

Digitized by the Internet Archive
in 2009 with funding from
University of Toronto

54

1

THE JOURNAL

OF

EXPERIMENTAL ZOÖLOGY

EDITED BY

WILLIAM E. CASTLE
Harvard University

EDWIN G. CONKLIN
Princeton University

CHARLES B. DAVENPORT
Carnegie Institution

HORACE JAYNE
The Wistar Institute

HERBERT S. JENNINGS
Johns Hopkins University

FRANK R. LILLIE
University of Chicago

JACQUES LOEB
University of California

THOMAS H. MORGAN
Columbia University

GEORGE H. PARKER
Harvard University

CHARLES O. WHITMAN
University of Chicago

EDMUND B. WILSON, *Columbia University*

and

ROSS G. HARRISON, *Yale University*
Managing Editor

100 683
23/2/10

VOLUME VI

PUBLISHED EIGHT TIMES A YEAR BY
THE WISTAR INSTITUTE OF ANATOMY AND BIOLOGY
36th STREET AND WOODLAND AVENUE
PHILADELPHIA, PA.

GL
1
J68
v.6
cop.2



CONTENTS

No. 1—January, 1909

- ADA SPRINGER
A Study of Growth in the Salamander, *Diemyctyles viridescens* 1
- EDMUND B. WILSON
Studies on Chromosomes. IV. The "Accessory" Chromosome in *Syromastes* and *Pyrochoris* with a Comparative Review of the Types of Sexual Differences of the Chromosome Groups. With Two Plates and Two Figures in the Text. 69
- N. M. STEVENS
Further Studies on the Chromosomes of the Coleoptera. With Four Plates. 101
- An Unpaired Heterochromosome in the Aphids. With Two Plates. 115
- DAVID DAY WHITNEY
The Effect of a Centrifugal Force upon the Development and Sex of Parthenogenetic Eggs of *Hydatina Senta*. With One Plate. 125
- Observations on the Maturation Stages of the Parthenogenetic and Sexual Eggs of *Hydatina Senta*. With Five Figures in the Text. 139

No. 2—February, 1909

- EDMUND B. WILSON
Studies on Chromosomes. V. The Chromosomes of *Metapodius*. A Contribution to the Hypothesis of the Genetic Continuity of Chromosomes. With One Plate and Thirteen Figures in the Text. 147
- MERKEL HENRY JACOBS
The Effects of Desiccation on the Rotifer *Philodina Roseola*. With One Figure. 207
- J. F. McCLENDON
Protozoan Studies. With Two Plates. 265
- CHARLES R. STOCKARD
The Development of Artificially Produced Cyclopean Fish—"The Magnesium Embryo." With One Plate and Sixty-three Text Figures. 285

No. 3—May, 1909

RAYMOND PEARL

- Studies on the Physiology of Reproduction in the Domestic Fowl. I.
Regulations in the Morphogenetic Activity of the Oviduct. 341

O. C. GLASER AND C. M. SPARROW

- The Physiology of Nematocysts. 361

LOUISE HOYT GREGORY

- Observations on the Life History of *Tillina Magna*. With Two Plates,
Three Figures and Six Diagrams in the Text. 383

CHARLES R. STOCKARD

- Studies of Tissue Growth. II. Functional Activity, Form of Regulation,
Level of the Cut, and Degree of Injury as Factors in Determining the Rate of
Regeneration. The Reaction of Regenerating Tissue in the Old Body. With One
Plate and Eight Figures in Text. 433

No. 4—July, 1909

C. M. CHILD

- Factors of Form Regulation in *Harenactis Attenuata*. I. Wound Reaction
and Restitution in General and the Regional Factors in Oral Restitution.
With Twenty-Four Figures. 471

R. W. HEGNER

- The Effects of Centrifugal Force upon the Eggs of Some Chrysomelid
Beetles. With Twenty-Four Figures. 507

WILLIAM REIFF

- Contributions to Experimental Entomology. I. *Junonia Coenia* Hübner 553
II. Two Cases of Anabiosis in *Actias Selene* Hübner. 565

J. FRANK DANIEL

- Adaptation and Immunity of the Lower Organisms to Ethyl Alcohol. . . . 570

A STUDY OF GROWTH IN THE SALAMANDER, *DIEMYCTYLUS VIRIDESCENS*

BY

ADA SPRINGER

PART I

I	Introduction.....	1
II	Normal rate of growth.....	4
III	The rate of starvation.....	5
IV	Effects of varying amounts of food.....	6
V	The effect of injury on the rate of growth	7
VI	Rate of decrease during starvation in normal animals and in those with the tail removed	12
VII	Rate of growth after starvation.....	12
VIII	Effect of temperature on the rate of growth and on the rate of starvation	13
IX	Relation of growth to moulting.....	15

PART II

I	To what factors are due irregularities in rate of growth.....	16
a	Males and females.....	16
b	Initial weight of animals	18
II	Influence of temperature on the rate of growth.....	21
III	Results of Part I interpreted in the light of the facts obtained in Part II	25
IV	Theoretical discussion.....	29
V	Summary.....	30

PART I

INTRODUCTION

For the purpose of studying the rate of growth and the external factors that influence its rate, the spotted salamander, *Diemyctylus viridescens*, has several advantages. It lives well in confinement, it takes food readily from the hand, and can be fed on pieces of beef; it withstands injury and can live for a long period without food.

The factors taken into consideration in this paper are four: (1) food, (2) starvation, (3) injury and (4) temperature; the results being based upon experiments carried on between October, 1906, and May, 1908.

The total number of individuals used in this and the subsequent investigation was about three hundred and seventy-five. All of the salamanders were adults, at least two and one-half or three years old, for, according to Gage¹ "the autumn of the third or the spring of the fourth year after hatching when two and one-half or three years old, the animal enters the water and assumes an aquatic life." All the animals used in the experiments, with the exception of six sets in Part I used to determine the effects of temperature, were taken from the same environment.

The animals were kept in sets consisting of six, ten and five individuals, respectively. For convenience the various sets are designated by capital letters, A, B, C; and when one set is a duplicate of another this fact is shown by designating those sets by capitals with the addition of the numerals, A¹, A², etc. The animals were kept in flat dishes containing from one and one-half to two inches of water, the room temperature varying from 20° C. to 25° C.

Pieces of raw beef of a definite size were used for food. Although an attempt was made to keep the pieces uniform, the size varied somewhat; that is, both the size of the pieces given to different animals at the same feeding and also the size of the pieces given to one animal at different feedings. A comparison of records, taken at random, of the amount of beef fed to the individuals at the same and at different feeding periods (the amount fed to the individual being determined by taking the average of the weight of beef given to the set), shows the following variations. The weight is expressed in milligrams.

Three feeding periods:

- (1) 44—58—47—52—55; average for the period, 51 mg.
- (2) 61—52—61—59—63—56—68—65—53—60; average, 59 mg.
- (3) 49—49—45—55; average, 49 mg.

During the first, second and possibly the third week after the beginning of the experiments the average amount of beef fed to the individuals was lower than the averages given above, because

¹ The life of the vermilion-spotted newt (*Diemyctylus viridescens*).

there was difficulty in feeding certain animals. After this time the average amount taken by each animal was 153 mg. in the three feeding periods during the week.

The weights of the salamanders were taken once a week, there intervening a period of from forty-eight to fifty hours, on the average, between the last feeding and the time of weighing; that is, from Saturday until Tuesday. The animals were dried with a cloth so as to get rid of as much of the moisture as possible, and weighed in a beaker of known weight. The weights were recorded in grams.

Possible errors in the comparative weights deserve consideration, for in all of the weights taken there were opportunities for positive and negative error: (1) Error as a result of undigested matter in the alimentary tract at the time of weighing. (2) Error from not drying the animals uniformly at the same and at different weighing periods. (3) Error from lack of uniform feeding, that is, varying amounts of food. (4) Some individuals failed to eat: this error, however, is lessened by the fact that where a certain number of individuals failed to eat, the same number in the control for that set were intentionally not fed. (5) Finally, corrections must be made for the death of one or more animals, which may shift the average of the set.

According to Minot,² increase of weight or growth depends upon two factors: (1) Upon the amount of body substance, the growing material present at a given time; (2) upon the rapidity with which that amount increases. The rate of growth may be expressed as a fraction of the weight added during a given period. Minot suggests taking the mathematical mean between the weights at the beginning, and at the end of a period, in order to furnish a basis from which to calculate the fraction, or the percentage increment. The rate of growth may in this way be expressed more accurately, for if during a period there is a definite increment, at the beginning of that period there is less material to increase than at the end. New material is being added daily, which in turn increases. By taking the mean, the actual amount of growing material at a definite period is more accurately ex-

²Senescence and Rejuvenescence.

pressed. The same principle holds in case of the rate of starvation. During a period there is a definite loss, but at the beginning of that period there is more material to lose weight than at the end, so the actual amount of decreasing material will lie as a mean between the first and last weights of the period.

The rate of increment and loss is best expressed for purposes of comparison in percentages, as absolute increments do not show relations between rates; for example, the absolute increment of a larger individual may be greater than that of a smaller one, yet the rate of growth in both may be the same, or even greater in the small one. This is shown in many of the tables, where the absolute increment and the percentage increment are both given. The percentage was calculated from the average weights of the sets.

II THE NORMAL RATE OF GROWTH

Increase in weight in *Diemyctylus viridescens* is due, as Mr. Morgulis³ has discovered, not to storage of fat in the various parts of the body, but to a uniform increase in the size of many of the organs, e. g., the skin, muscles, liver, ovaries, etc. This type of growth seems, therefore, comparable to growth from a young to an adult stage. Conversely in starvation there is a decrease in the size of the organs.

Percentage increment decreases as the maximum weight is approached; that is, the rate of growth becomes slower the nearer the animal approaches its upper limit of weight.

In Set A¹ (Table I), where the individuals had been fed 153 mg. (average) of the beef a week, there was a tendency for the percentage increment of weight to decrease as the animal approached the maximum or limit of weight. It might be supposed that a stage would be reached where this amount of food proved insufficient to produce an increase, and in consequence a state of equilibrium would be established between the body material and the amount of food, around which equilibrium there would be a fluctuation between loss and gain. If now an

³ Unpublished work of S. Morgulis.

increase in the amount of food be given, this maximum should be pushed higher.

Unfortunately the records in the tables do not show conclusively that this is actually the case, but there is a certain indication which may be interpreted as bearing on this question. The uniform loss in many of the sets after February 19 and March 5, lasting for about five or six weeks, cannot be attributed to the fact that the maximum had been reached, although it might have been that they were approaching the maximum. This seems the case because all of the sets had not been fed as much as 153 mg. of beef for eighteen weeks, as had been Set A¹ (Table I), so that they cannot be supposed to have reached their limit of size at the same time. The general loss was probably due to some general factor which affected many of the sets alike. It may have been due to the breeding season. After five weeks of loss, Set A¹ was fed three times, 153 mg. a week (459 mg.), and after a week's time regained almost the entire loss.

The weekly percentage increments do not always show a decrease as a limit is approached, because of the varied fluctuations from week to week. By taking definite periods, however, such as eighteen weeks in the case of Set A¹ (Table I), the percentage increment or rate during the first nine weeks, 23.3, will be found greater than during the second half, which was 21.5. The absolute increment, however, during the first half was less (545 mg.) than that during the last half of the period, which was 629 mg.

In Set C² (Table III), consisting also of six individuals, which had been fed 102 mg. of beef a week during a period of eighteen weeks, the rate during the first half was 14.5 per cent., and that during the second half was 9.1 per cent. In other sets the difference has also proved constant, as in Set D¹ (Table IV), and Set E³ (Table VI).

III THE RATE OF STARVATION

Set B¹ (Table II), consisting of six individuals, was starved for seventeen weeks, at the end of which time one individual died, indicating that the minimum limit of weight for the set was nearly reached.

The weights show that where an individual approaches the minimum weight there is a decrease in percentage of loss. In Set B¹ during the first half of the period, eight weeks, the rate of loss was 41 per cent, while during the last half, or nine weeks, the rate of loss was 35.2 per cent.

IV EFFECTS OF VARYING AMOUNTS OF FOOD

Percentage increment, or rate of growth, is directly proportionate to the amount of substance taken into the body. This is shown to be true by a comparison of the following sets. Sets C¹ and C² (Table III), consisting of six individuals respectively, were fed on the average 102 mg. of beef a week; Sets A¹ and A² (Table I), consisting of six individuals also, were fed 153 mg. of beef a week. After a period of nine weeks the percentage increments were as follows:

Set C ¹	18.4
Set C ²	14.5
Average of the two sets	16.4 per cent
Set A ¹	23.3
Set A ²	29.8
Average of the two sets	26.5 per cent

After the ninth week, December 18, the individuals of Set C¹ were fed 153 mg. of beef a week, while those in Set C² were, as before, fed 102 mg. a week. After another period of nine weeks the relations were as follows:

	<i>Increment per cent</i>
Set C ¹	34.9
Set C ²	9.1

This would seem to show that 102 mg. of beef per week was not the maximum amount of food which could be assimilated by the digestive tract.

After a period of eighteen weeks Set A¹ had gained 44.2 per cent of the original weight, while C² had gained but 23.5 per cent.

Comparing Set A¹ (Table I), in which the animals were fed 153 mg. of beef a week, and Set B¹ (Table II), in which the

animals were starved, it was found that after a period of eighteen weeks the former had gained 44.2 per cent of the initial weight, while the latter had lost 73.6 per cent of the initial weight.

V EFFECT OF INJURY ON THE RATE OF GROWTH

To determine the effects of injury, the tails of the salamanders were cut off, either once at the base, or six or even nine successive times, a very small piece each time.

On October 23 the tails of six salamanders were cut at the base, the animals being weighed before and after the operation, enough time being left between the weighings so that the cut surface had ceased to bleed. The animals were then weighed once a week for five weeks. Control normal animals were also weighed, and kept under the same conditions as the injured ones. The feeding was, as in the experiments above, about 153 mg. of beef a week. At the end of a period of five weeks the results were as follows: The injured set D¹ (Table IV) had gained (average) 19.5 per cent of the original weight after the tails were cut, while the percentage gained in the two normal control sets A¹ and A² (Table I) was 14.3 and 20.3, respectively, the average between the two control sets being 17.3 per cent. After the first week the individuals of the injured set had almost made up the weight lost by cutting their tails. Another set, started November 6, also showed this to be the case; the first week after the injury the percentage increase was 13.6, the entire weight of the tails being almost made up.

The experiment described above was repeated November 13, the number of animals used being somewhat larger. Six sets consisting of ten individuals each were used, the animals in three of the sets being injured by cutting off the tails at the base. Each set was controlled by a set of normal animals with tails intact. The injured and the normal control sets in every case were fed the same amount of beef, 153 mg. (average), and were kept under identical conditions. At the end of five weeks the results in percentage increments were as follows:

<i>The injured sets</i>		<i>Normal control sets</i>	
(1) Set E ¹ (Table V).....	14.7	Set G ¹ (Table V).....	11.4
(2) Set E ² (Table V).....	10.5	Set G ² (Table V).....	loss — 1.2
(3) Set E ³ (Table V).....	14.2	Set G ³ (Table V).....	6.5

The average for the injured sets is 13.1 per cent increment, and for the two normal control sets, in which there was a gain, 8.9 per cent increment.

After a period of fourteen weeks Set E³ had gained 47.7 per cent, while the normal set had gained 44.6 per cent.

Set E¹ (Table V), in which the new tails had been regenerating for five weeks, was divided, December 18, into two sets of five individuals each. In one set, E^{1a} (Table VII), the animals were again injured by cutting off the regenerating stump, together with a small piece of the old material at the base of the tail; in the other set, E^{1b} (Table VII), the regenerating stumps were left intact. This latter set, together with the normal intact Set G¹ (Table V), were used as controls. The results after a period of four weeks were as follows.

	<i>Increment per cent</i>
Set E ^{1a} , injured animals.....(average)	21.
Set E ^{1b} , animals with regenerating stumps.....	5.4
Set G ¹ , normal intact animals.....	11.4

The same experiment was duplicated by dividing Set E² (Table V) in the same way as Set E¹, the two being equivalent sets. The results were correspondingly the same (Table VIII):

	<i>Increment average per cent</i>
Set E ^{2a} , injured animals.....	21.3
Set E ^{2b} , animals with regenerating stumps.....	18.2
Set G ¹ , normal intact animals.....	11.4

The percentage increment, or the rate of growth in the injured set in both cases, was greater than in the normal control or in those with regenerating stumps.

Three other experiments, also started on December 18, resulted in similar comparative percentage increments. Two sets which

had been starved for five weeks were taken. In the one the tails were cut at the base, H³ (Table IX); in the other, Set H² (Table IX), the tails were left intact. After feeding both sets 153 mg. (average) of beef a week, for four weeks, the percentage increment in the injured set was 31.6, while that of the normal control only 20.3.

Set F¹ (Table XIV), in which the tails had been cut off at the base, and which had been starved for five weeks, was divided into two sets of five individuals each. In Set F^{1a} (Table X) the animals were again injured by cutting off the regenerating stumps, together with a small piece of the old material of the tail. In the other set F^{1b} (Table X), the regenerating tails were left intact, and this set together with Set H² (Table IX), the normal animals, served as controls. The results show the following percentage increments in the three cases, the animals being fed 153 mg. of beef (average) for four weeks:

	<i>Increment per cent</i>
Set F ^{1a} , injured animals.....	21.8
Set F ^{1b} , with regenerating stumps intact.....	23.4
Set H ² , normal intact animals.....	20.3

This experiment was carried further by dividing Set F³ (Table XIV) as F¹ had been. The animals in Set F^{3a} (Table XI) were injured by cutting the regenerating stumps as before. The results, after feeding these sets as before for four weeks, were similar to those above, viz:

	<i>Increment per cent</i>
Set F ^{3a} injured animals.....	28.5
Set F ^{3b} , with regenerating stumps intact.....	27.8
Set H ² , normal intact animals.....	20.3

After five weeks' starvation and subsequent feeding 153 mg. of beef a week for four weeks, the percentage increments in Sets F² and H² (Table XV) were as follows:

	<i>Increment per cent</i>
Set F ² , with regenerating stumps.....	27
Set H ² , normal intact animals.....	20.3

After a period of eleven weeks the results were as follows:

	<i>Increment per cent</i>
Set F ²	55.5
Set H ²	48.9

In every experiment, with the exception of Set F^{1b} (Table X), the *percentage increment was greater* in the injured animals. The degree of difference in some cases was very great, while in others it was but comparatively slight.

In the majority of cases, as may be seen by a comparison of the tables, the percentage increment of the injured animals was especially great during the first week after the injury; in some cases the loss of the tail being almost made up.

As a basis for comparison of the rate for the intact and for the injured animals, short periods of four or five weeks were taken. During this time the tails of the injured animals had begun to regenerate, and had added new material to the old. The average actual weight of the new material added during this period was from 42 to 50 mg.; and taking into consideration individual variation in this regard, in no case can the greater percentage increment in the injured animal be said to be due to the added weight of the new material; the difference in all cases being too great to be attributed to such a cause.

The results of the experiments cited above are in accordance with those by Professor Morgan. As expressed by him,⁴ "The greater percentage increment in the injured animals may be due to the influence of the regenerating tail on the growth of the rest of the body, or, if not due to accidental factors, it may be that the changes taking place at the cut surface incite the digestive tract to greater activity or the cells of the body to greater assimilation. In this way the injured animals would gain proportionately more body weight." This question is treated again in the light of additional experiments in Part II.

To determine the effects of successive cuts in three sets, I¹, I², I³, (Table XII), consisting of six individuals each, the tails were cut at the tips, the weight being taken before and after the operation.

⁴ Jour. Experimental Zoölogy for December, 1906, The Physiology of Regeneration.

During five successive weeks the remainder of the tail was cut five successive times. As a control set the records of a corresponding number of weeks for Sets A¹ and A² (Table I) were taken. These cannot, however, be considered strictly equivalent, for the experiments were not started on the same dates. The comparisons are therefore not very satisfactory. The animals were fed as before. Four weeks after the last cut was made, a time corresponding to that in the cases where the tails were cut at the base, the percentage increments were as follows (because of the great variation in the results of the different sets averages in the two groups of sets were taken):

In the three injured sets:

Set I ¹ (Table XII).....	42.7
Set I ² (Table XII).....	24.5
Set I ³ (Table XII).....	23.5
Average	30.2 per cent

In the normal control sets:

Set A ¹ (Table I).....	23.3
Set A ² (Table I).....	29.8
Average	26.5 per cent

On December 18 a similar experiment was started. Sets G³ and G², consisting of ten individuals each, after having been well fed for five weeks, were divided into two sets of five individuals, respectively, viz: Sets G^{3a} and G^{3b} (Table XIII), and G^{2a} and G^{2b} (Table XIII). In set G^{3b} the tails were cut nine successive times; five weeks after the last cut the percentage increment was 48.7. In Set G^{2b} the tails were cut six successive times; four weeks after the last cut the percentage increment was 52.3. In Set G^{2a} the weight was so far below the average that the results are of no value, and G³ became infected. For Set G^{3b} there was no set which could be taken as a comparative control; but comparing the thirteen weeks with a corresponding period of any normal intact set the percentage increment was considerably higher. In fact, the percentage in these two cases, except those obtained after a period of starvation, were the *highest percentages obtained in any of the experiments.*

There are, perhaps, not sufficient data upon which to determine definitely whether or not the percentage increment is greater when small pieces of the tail are cut off successively and when it is cut only once at the base; but there are indications from the weekly records and from the end results showing that the successive cuts produce a greater increment than does the single cut at the base. This would seem to indicate that the increased rate of growth is the direct response to the cut without regard to the regenerating mass; but there are other factors yet to be considered that show the results can not be so simply interpreted.

VI RATE OF DECREASE DURING STARVATION IN NORMAL ANIMALS AND IN THOSE WITH THE TAIL REMOVED

Six sets, consisting of ten individuals each, were taken November 13. In three sets the tails of the animals were cut off at the base, in the other three sets they were left intact. After four weeks' starvation a comparison shows the following percentage increments:

1 <i>The injured animals</i>		2 <i>The normal controls</i>	
Set F ¹ (Table XIV).....	6	Set H ¹ (Table XIV).....	6.5
Set F ² (Table XIV).....	4.6	Set H ² (Table XIV).....	0.5
Set F ³ (Table XIV).....	8.4	Set H ³ (Table XIV).....	0.2

The average for the three injured sets is 26.3 per cent, while for the normal it is 29.06 per cent.

VII RATE OF GROWTH AFTER STARVATION

Minot states that any irregularity of growth in his guinea pigs tends to be followed by an opposite compensating irregularity. "Each individual appears to be striving to reach a particular size. If growth ceases because of any factor which deprives the individual of the normal conditions, as sickness, when the normal conditions are again brought about there is a tendency, by acceleration of the rate of growth, to make up the loss."

Starvation, although not equivalent to sickness, may be compared with it, in that starvation is a factor which deprives the

individual of normal conditions. In animals that had been starved for five weeks, and after that time were fed 153 mg. (average) of beef, there was a marked acceleration of growth. Four sets were starved for five weeks, after which they were fed 153 mg. (average) of beef. Four sets were taken as controls which had been well fed for five weeks, after which time the same amount, 153 mg., was given to each animal. The condition of the animals at the beginning of the experiment was identical. After four weeks the differences in percentage increments were as follows:

<i>1 After five weeks' starvation</i>		<i>2 After five weeks' of feeding</i>	
Set H ² (Table IX).....	20.3	Set G ¹ (Table VI).....	11.4
Set F ^{1a} (Table X).....	21.8	Set E ^{1a} (Table VII).....	21.1
Set F ^{1b} (Table X).....	23.4	Set E ^{1b} (Table VII).....	5.3
Set F ^{3b} (Table XI).....	27.8	Set E ^{2b} (VIII).....	18.2

The percentage increment after the period of starvation in every case proved to be the greater. In many other sets this is also shown, as Sets A¹ (Table I); B² (Table II); D² (Table IV).

Throughout the experiments another fact comes to light that appears to be quite general, namely, that a very high percentage of gain during one week is followed the next by a low percentage, and in many cases even by a loss. This is most striking after feeding individuals that have been starved; the first percentage is very high, while those immediately following them are low.

VIII EFFECT OF TEMPERATURE

It is generally known that the rate of growth is accelerated by warmth and retarded by cold. This has been determined for the growing embryo and for regenerating parts. With the view to determine the effect of temperature above and below the normal (the normal in this case, being considered the room temperature), upon the rate of growth and the rate of starvation in adult salamanders, six sets, consisting of six individuals each, were kept under three conditions of temperature, as follows:

Two sets were kept at the normal temperature of the room, averaging 22° C. The highest temperature recorded during the

period of seven weeks between March 12 and April 16 was 24° C., the lowest 19° C. One set was fed three times a week, the other starved.

Two sets were kept at a temperature lower than that of the room, viz: 11° C. on the average. The highest temperature recorded was 15° C., the lowest 6° C. One set was fed three times a week, the other starved.

Two sets were kept at a temperature of 28° C. on the average. The highest temperature recorded was 31° , the lowest 25.5° C. As before, one set was fed and the other starved.

The quantity of beef given to each individual averaged somewhat lower than 153 mg. per week, the variation being from one-half to two-thirds of that amount. This was due to the fact that the individuals under conditions of low temperature proved difficult to feed, and in almost all cases it was found necessary to put the food into the mouth. This quantity was necessarily taken as a basis for the other sets.

A comparison of the records in Table XVI shows that the relative rate of growth cannot be determined, because the quantity of beef taken by the individuals in Set C, Table XVI (those under conditions of low temperature), was only enough to preserve the equilibrium. There were fluctuations between gain and loss, but the results after seven weeks' time show there was a gain of only 1.04 per cent of the original weight.

The same amount of food was inadequate in the case of A and B to preserve the equilibrium, and a steady loss was the result. The percentage of loss was greater in Set A, where the temperature was higher than in Set B; in the one case 31 per cent, and in the other 23.08 per cent.

On the other hand, the relative rate of loss can be determined in starving individuals. This is found to be highest at a high temperature (Table XVI), Set D, 58.5 per cent; it becomes lower at the normal temperature, Set E 41.4 per cent; and lowest when the temperature is below normal, Set F, 18.3 per cent.

Records were kept of individual salamanders which had been subjected to these conditions of temperature. Previous to the experiment the animals had been fed three times per week since

November 13. The records from these weighings show the same general results, namely, that the rate of starvation was lowest under conditions of low temperature, and that the quantity of beef necessary to preserve equilibrium in case of the individual at a low temperature was not sufficient for those at a higher temperature.

IX RELATION OF GROWTH TO MOULTING

There seems to be a more or less definite relation between the quantity of food and the frequency of shedding the skin. Although there is great individual variation in this regard, there is a certain uniformity which warrants the following conclusion, based upon the records of thirty-six individuals. The greater the quantity of beef fed to the individual the more frequent is the period of shedding. This was determined by a comparison of the records of the individuals in Set A¹ (Table I) and Set C² (Table III); the quantity of beef fed in the one case being greater than in the other. The average record of moulting in Set A¹ was seven, and in Set C² four, during the period from October to April. The individual records, showing the greatest frequency, give ten moultings. Four moultings were recorded in the case of starving individuals during the period.

PART II

With the view to determine some of the causes of variation in the results of the experiments carried on during the winter of 1906-07 (Part I), a new series was started in October, 1907.

Greater precautions were taken to diminish the possibilities of error. The animals were carefully dried and weighed in a covered dish, so as to prevent evaporation during weighing. Greater care was taken to preserve the average size of the pieces of beef. The average size of the pieces given to each individual at the beginning of the experiment was maintained throughout the later feedings, and was not, as in the first series (that of 1906-07), gradually increased during the first few weeks. In the first series of experiments the average size of the pieces of beef

after the first week or two, was about 50 mg., or 153 mg. per week; while in the present series the amount was twice as large. The average weight of each piece was 105 mg., or 315 mg. per week. The feeding in this series was regular from the beginning, which was not the case in the first series.

A record of each individual was kept, together with the number of pieces of beef consumed, so that at the end of a definite period the amount of food taken by each individual was known. Of course there was a chance for error in cases where the beef was later rejected by the animal. It will be well to state that if a certain individual in a set was not disposed to eat for several periods, the corresponding control individual was not fed at these times; thus keeping the conditions in each set as even as possible.

I TO WHAT FACTORS ARE DUE IRREGULARITIES IN RATE OF GROWTH

It has been found that animals kept under almost identical conditions of temperature, of food given and of depth of water, varied considerably in the rate of increment. As to the causes of these variations, several questions arose: (a) Does sex account for the variation; do females gain faster than males? (b) Does the initial weight of the animal affect the percentage increment? (c) Do the periods of moulting affect the rate?

(a) *Males and females.* Two sets, one consisting of ten males, the other of ten females, were placed under identical conditions of temperature and food, October 22. The average amount of beef taken by each individual per week was 315 mg. In respect to feeding, these two sets proved to be the most satisfactory of any during the experiments—for, with the possible exception of once or twice, the feeding was absolutely regular.

After a period of ten weeks the average percentage increment was as follows:

	<i>Per cent</i>
Set A (Table XVII), males	29.7
Set B (Table XVII), females	42.1

Thus the percentage increment of the females was considerably higher than that of the males.

In order to determine individual variation within a set, five males and five females from Sets A and B respectively were selected at random. The individual feeding record, together with that of the weights, was kept. The following table shows the initial weight of each individual with its percentage increment during the period of ten weeks. Average amount of beef per week was 315 mg.

MALES (TABLE XVIII)			FEMALES (TABLES XIX)		
	<i>In. wt.</i> grams	<i>Increment</i> per cent		<i>In. wt.</i> grams	<i>Increment</i> per cent
No. (3).....	1.577	38.9	No. (2).....	1.237	64.8
No. (5).....	1.885	28.8	No. (4).....	1.387	54.2
No. (4).....	2.509	26.8	No. (5).....	1.447	35.1
No. (1).....	2.627	28.01	No. (1).....	1.927	35.6
No. (2).....	2.787	20.1	No. (3).....	2.222	22.7

From the above table it may be seen that while the percentage increment of several of the individual males is greater than that of some of the females, in general the percentage in the females is greater. The highest percentage recorded for a female for the period of ten weeks is 64.8 per cent while that of a male was 38.9 per cent.

Records of individuals taken from the sets kept under high temperatures are not comparable with those given above, because of differences of temperature and feeding; but within the same set males and females may be compared. In Set D² (Table XXIII) at high temperature (30° C.), the individual records of two males and one female were taken. Each animal was fed 105 mg. of beef at each feeding period about thirty times during the ten weeks. The initial weights together with the percentage increments were as follows:

MALES (TABLE XXIII)			FEMALE (TABLE XXIII)		
	<i>In. wt.</i> grams	<i>Loss</i> per cent		<i>In. wt.</i> grams	<i>Increment</i> per cent
No. (1).....	1.037	12.5	No. (2).....	1.389	2.4
No. (3).....	1.677	25.			

Though the three individuals were fed the same amount of beef, both of the males lost in weight, while the female gained 2.4 per cent of the initial weight.

In Set E² (Table XXV) at high temperature (30° C.), individual records of two males and one female were kept. Each animal was fed about forty times during the period. The initial weights and percentages were as follows:

MALES (TABLE XXV)			FEMALE (TABLE XXV)		
	<i>In. wt.</i> grams	<i>Increment</i> per cent		<i>In. wt.</i> grams	<i>Increment</i> per cent
No. (2).....	1.539	22.8	No. (3).....	1.172	57.4
No. (1).....	2.805	10.5			

Here again the percentage in the female was considerably higher than in the males.

From the tables, however, it will be noticed that the initial weights of some of the females are less than are those of the males. The question arises as to whether the difference in percentage increments might not be due to this fact rather than to sex.

(b) *Initial weight.* By comparing the records of the five males in Table XVIII, it will be found that although there are exceptions, the animal whose initial weight is greatest shows the least percentage increment, as in the following:

	<i>In. wt.</i> grams	<i>Increment</i> per cent
No. (3).....	1.577	38.9
No. (2).....	2.787	20.1

These two weights represent the extremes and lying between them are gradations, showing that as the initial weight increases, the percentage increment decreases.

By a comparison of the five females in (Table XIX), the results are in general the same, as follows:

	<i>In. wt.</i> grams	<i>Increment</i> per cent
No. (2).....	1.237	64.8
No. (3).....	2.222	22.7

The greater the initial weight the less the percentage increment

Comparison of females and males of approximately the same initial weight, ought to show whether the percentage increment is greater in the females or in the males. The data on this point are not conclusive, as shown by a review of Tables XVIII and XIX.

MALES (TABLE XVIII)			FEMALE (TABLE XIX)		
	<i>In. wt.</i>	<i>Increment</i>		<i>In. wt.</i>	<i>Increment</i>
	<i>grams</i>	<i>per cent</i>		<i>grams</i>	<i>per cent</i>
No. (3).....	1.577	38.9	No. (2).....	1.237	64.8
No. (5).....	1.885	28.8	No. (4).....	1.387	54.2
No. (4).....	2.509	26.8	No. (5).....	1.447	35.1
No. (1).....	2.627	28.01	No. (1).....	1.927	35.6
No. (2).....	2.787	20.1	No. (3).....	2.222	22.7

MALES (TABLE XXIII)			FEMALES (TABLE XXIII)		
	<i>In. wt.</i>	<i>Loss</i>		<i>In. wt.</i>	<i>Increment</i>
	<i>grams</i>	<i>per cent</i>		<i>grams</i>	<i>per cent</i>
No. (1).....	1.037	12.5	No. (2).....	1.389	2.4
No. (3).....	1.677	25.			

MALES (TABLE XXV)			FEMALES (TABLE XXV)		
	<i>In. wt.</i>	<i>Increment</i>		<i>In. wt.</i>	<i>Increment</i>
	<i>grams</i>	<i>per cent</i>		<i>grams</i>	<i>per cent</i>
No. (2).....	1.539	22.8	No. (3).....	1.172	57.4
No. (1).....	2.805	10.5			

It is thus seen that the percentage increment for both sexes is very closely connected with the initial size. Whether there are also minor differences related to the sex of the individual can not be determined with certainty from the facts obtained.

In order to find out more exactly the relation between food, initial weight and percentage increment the weights of each piece of beef taken by each of five males and five females (Tables XVIII and XIX), respectively, for a period of four weeks out of the ten were recorded.

The following table shows the initial weights at the beginning of the period of four weeks, the amount of beef taken during the time and the percentage increments:

MALES (TABLE XVIII)			FEMALES (TABLE XIX)		
<i>In. wt.</i> grams	<i>Amt. of beef</i> grams	<i>Increment</i> per cent	<i>In. wt.</i> grams	<i>Amt. of beef</i> grams	<i>Increment</i> per cent
No. (3)..... 1.948	1.269	18.2	No. (5)..... 1.68	1.254	20.5
No. (5)..... 2.222	1.246	12.5	No. (2)..... 1.92	1.272	23.2
No. (4)..... 2.81	1.274	15.6	No. (4)..... 1.987	1.290	19.5
No. (1)..... 3.04	1.291	13.5	No. (1)..... 2.447	1.271	12.09
No. (2)..... 3.098	1.256	9.6	No. (3)..... 2.515	1.277	10.4

By comparing the five males it will be found that, while all have consumed approximately the same amount of beef, the percentage increments vary considerably. Taking the extremes, Nos. 3 and 2, it appears that while both have eaten about the same amount of beef, yet the percentage increment of the first, the initial weight being 1.948 gram, was twice that of the second, whose initial weight was 3.098 grams. Between these extremes there are inconsistencies, yet in general the same relation holds.

A similar comparison between the five females (Table XIX) shows the same relation. In Nos. 5 and 3, where the initial weights were 1.68 and 2.515 grams respectively, the amount of beef was approximately the same; yet the percentage increment in the first case was 20.5, and in the second 10.4. These results are in accordance with those for the period of ten weeks, and show that with increase of initial weight there is a decrease in percentage increment.

In connection with these general results it should be noted that in Tables XVII and XVIII there are weekly variations for which the factors considered cannot account.

Set C (Table XX) was composed of seven individuals considerably below the average in length and in weight. Because of their small size it may be assumed that they are younger individuals. They took pieces of beef the same size (105 mg.) as did the average ones, with the exception of two, which after two weeks ate practically nothing; this makes the percentage increment somewhat lower than it would have been had all eaten the normal amount. The average initial weight of the set was 0.91 gram, and after a period of six weeks the percentage increment was

48.08, the largest percentage obtained for animals taking three pieces of beef per week, despite the fact that two individuals did not eat after the first two weeks, which must have lowered the total increment. These results are also in harmony with the individual records showing that the less the initial weight the greater is the percentage increment.

(c) As to the other question which arose as a possible factor in accounting for the variations in the results, viz: the effect of moulting; the data were not sufficient upon which to base a suggestion.

II INFLUENCE OF TEMPERATURE

The series of experiments of 1906-07, the object of which was to test the effects of temperature above and below the normal on the rate of growth, was repeated. In the former series it was impossible to show the rate of growth at different temperatures because the amount of beef taken by the animals kept at a low temperature, 10° C., was insufficient to preserve equilibrium of those at 20° C. and 30° C.

In the present series the temperature conditions were practically the same as before, but the feeding was modified somewhat.

Six sets, consisting of ten individuals each, were kept at three different temperatures, as follows:

	<i>Average temperature deg. C.</i>
Set D (Table XXI).....	10
Set D ¹ (Table XXII).....	20
Set D ² (Table XXIII).....	30
Set E ¹ (Table XXIV).....	20
Set E ² (Table XXV).....	30
Set F (Table XXVI).....	30

The amount of beef taken by D was used as a basis for D¹ and D². For the first three weeks the feeding was very regular, all eating three pieces per week, averaging 105 mg. each; after this time, because of the effect of low temperature, the animals became difficult to feed.

After a period of ten weeks the results were as follows:

	<i>Increment per cent</i>
Set D.....	24.8
Set D ¹	12.5
Set D ² there was a loss of.....	14.4

The amount of food in case of the set at 10° C. was sufficient to give a percentage increase of 24.8; the same amount at 20° C. gave only 12.5 per cent; while at a temperature of 30° C. it did not prove sufficient to preserve equilibrium, a loss of 14.4 per cent was the result.

The individual records of three animals from each set were kept; the initial weights with the percentage increments being as follows:

SET D (TABLE XXI)			SET D ¹ (TABLE XXII)			SET D ² (TABLE XXIII)		
	<i>In. wt.</i>	<i>Increment</i>		<i>In. wt.</i>	<i>Increment</i>		<i>In. wt.</i>	<i>Loss</i>
	<i>grams</i>	<i>per cent</i>		<i>grams</i>	<i>per cent</i>		<i>grams</i>	<i>per cent</i>
No. (1)....	1.374	20.5	No. (1)....	(lost)		No. (1) ...	1.037	-12.5
No. (2)....	1.947	21.4	No. (2) ...	1.297	37.3	No. (2)....	1.389	(gain) 2.4
No. (3)....	2.232	8.4	No. (3)....	2.007	-16.5	No. (3)....	1.677	-25.

During the period of ten weeks Nos. 1 in D and D² were fed thirteen times (105 mg. average weight of piece), this amount being as much as No. 1 in Set D would take. No. 2 of D was fed 16 times; No. 2 of D¹ 18 times; No. 2 of D² 16 times; No. 3 of D, D¹, D², 13 times.

The result of the individual records were the same in general as those for the entire sets. The irregularities of the percentage increments in the two individuals of set D¹ (Table XXII) may be explained, or an explanation suggested. No. 3 was a large female, the initial weight being 2.007 grs. The steady loss was not due to a diseased state, but to the fact that the amount of food was not sufficient to preserve the initial weight. This was shown later when the experiment had closed; the animal was fed as much as it would take, and a steady gain followed. The high percentage increment in No. 2, Set D¹, may be due to the small initial weight.

Set E¹ (Table XXIV) at 20° C. was fed as much and as often as the individuals would take food, and Set E² (Table XXV)

at 30° C. was fed a corresponding amount. The initial average weight and the percentage increments were as follows:

	<i>In. wt.</i> <i>grams</i>	<i>Increment</i> <i>per cent</i>
Set E ¹	1.738	49.7
Set E ²	1.69	29.07

This shows that the rate of growth of the animals at the two temperatures for the amount of beef was more than enough in both cases to preserve equilibrium, and even to add to the body weight.

The individual records of three animals from each set were as follows:

SET E ¹ (TABLE XXIV)			SET E ² (TABLE XXV)		
	<i>In. wt.</i> <i>grams</i>	<i>Increment</i> <i>per cent</i>		<i>In. wt.</i> <i>grams</i>	<i>Increment</i> <i>per cent</i>
No. (3) male.....	1.507	47.1	No. (3) female.....	1.172	57.4
No. (2) male.....	1.527	53.05	No. (2) male.....	1.539	22.8
No. (1) male.....	2.307	31.1	No. (1) male.....	2.805	10.5

During the period of ten weeks Nos. 1 in Set E¹ and Set E² were fed 38 and 40 times respectively (105 mg. of beef each time); No. 2 in Set E¹ was fed 42 times; No. 2 in Set E² 30 times; No. 3 in Set E¹ 45 times; No. 3 Set E² 45 times.

With the exception of No. 3 in Set E², the results show the same relative percentages as did the averages taken from the entire sets, viz: the gain was greater at the room temperature. No. 3 of Set E² was a female of small initial weight; this fact as interpreted in the light of the data cited above will not be difficult to explain. Lastly, Set F (Table XXVI), at 30° C. was fed as much beef and as often as the individuals would take, regardless of amount given to other sets. It was found, however, that this set ate about the same amount as Set E¹ (Table XXIV), and Set E² (Table XXV); and this may be considered the maximum amount of food that can be taken. The initial weight and the percentage increment for the period of ten weeks was as follows:

Initial weight (grams)	1.661
Increment (per cent).....	25.06

The individual records of two individuals do not agree entirely with the average results of the sets, as shown below:

	<i>In. wt.</i>	<i>Increment</i>
	<i>grams</i>	<i>per cent</i>
No. (1).....	1.107	56.4
No. (2).....	1.632	43.3

No. 1 was fed 40 times (105 mg. average per feeding), and No. 2 was fed 39 times.

The general results of the experiments carried out to test the effect of varying temperatures seem to show:

1. More food is required at a high temperature to preserve equilibrium than at a low temperature.

2. The maximum amount of beef that the animals will take at a low temperature is, on the average, one-third as much as for those at the room temperature (20° or at 30° C.). At a low temperature digestion probably takes place more slowly, or it may be less food is taken because waste is slower and less material for repair is needed by the body.

3. When a definite amount of beef was given to animals at three temperatures, viz: 10° C., 20° C. and 30° C., this being the maximum amount that those at 10° C. would take, the rate of growth was greatest at 10° C., less rapid at 20° C., and at 30° C. the beef given was not sufficient to maintain equilibrium. When, however, the animals at 20° C. were fed their maximum amount (the same as the maximum for those at 30° C.), which was three times as much as that given to the animals at 10° C., the percentage increment was almost twice as great as that of the animals at 10° C., and was greater than that at 30° C. The percentage increment of animals at 30° C. was also greater on their maximum amount of beef than that of the animals at 10° C. on their maximum amount of beef.

By comparing the ratios between the amounts of beef taken and the percentage increments in the above cases, it will be found that the rate of growth in proportion to the amount of food taken is greatest at 10° C., less at 20° C., and still less at 30° C.

III RESULTS OF THE SERIES OF 1906-07 (PART I) INTERPRETED IN THE LIGHT OF FACTS OBTAINED IN THE PRESENT SERIES OF EXPERIMENTS

The facts obtained in the present series of experiments in many cases show or indicate the causes of many of the irregularities of the Series of 1906-07.

In Sets A¹ and A² (Table I), composed of three males and three females respectively, where the food and temperature conditions were the same, the percentage increment in A¹ was 23.3 and in A² was 29.8. The initial weight, however, of the first was 2.006 grams, while of the second it was 1.661 gram. The difference in initial weight would seem to account for the difference in the rate of growth.

In Sets C¹ and C² (Table III) there was a similar difference, not so great, but which may be interpreted in the same way.

	<i>Initial weight</i>	<i>Increment per cent</i>
Set C ¹	1.853	18.4
Set C ²	2.11	14.5

In Set D¹ (Table IV) where the animals were injured by cutting off the tail at the base, and in Sets A¹ and A² the normal control, the initial weights and the percentage increments were as follows:

<i>Injured animals</i>			<i>Normal animals</i>	
	<i>After operation</i>	<i>Increment</i>		<i>Increment</i>
	<i>In. wt. grams</i>	<i>per cent</i>		<i>per cent</i>
Set D ¹	2.253	1.986	19.5	Set A ¹ 2.066
				Set A ² 1.661
				<i>After nine weeks</i>
				Set A ¹ 2.066
				Set A ² 1.661
				<i>After nine weeks</i>
Set D ¹	2.253	1.986	30.4	

The percentage in the injured set was greater than in one control and less than in the other, but when the initial weight is considered the difference between the two control sets may be explained. Based on this comparison, the evidence in favor of a greater percentage in the injured set is more striking.

A similar comparison to the one cited above may be made in the following sets (Table V):

<i>Injured animals</i>			<i>Normal animals</i>		
	<i>In. wt.</i>	<i>After operation</i>	<i>Increment</i>		
	<i>grams</i>	<i>grams</i>	<i>per cent</i>	<i>In. wt.</i>	<i>Increment</i>
				<i>grams</i>	<i>per cent</i>
Set E ¹	2.264	1.887	14.7	Set G ¹	1.944 11.4
Set E ²	2.044	1.73	10.5	Set G ²	2.111 (loss) 1.2
Set E ³	1.878	1.614	14.2	Set G ³	1.965 (loss) 6.5

In the injured Sets E¹ and E³, the initial weight in one case was greater, while in the other it was less than the initial weight of the normal control sets, G¹ and G³; yet the percentage increment in both cases was greater in the injured sets.

In Sets E^{1a} (Table VII), in which the animals were injured by cutting the regenerating stumps, in E^{1b} (Table VII) in which the regenerating stumps were left intact, and in G¹ (Table VI), the normal control, the average initial weights and percentage increments were as follows:

	<i>In. wt.</i>	<i>After operation</i>	<i>Increment</i>		<i>In. wt.</i>	<i>Increment</i>
	<i>grams</i>	<i>grams</i>	<i>per cent</i>		<i>grams</i>	<i>per cent</i>
Set E ^{1a}	1.904	1.835	21	Set E ^{1b}	2.543	5.4
				Set G ¹	2.18	11.4

Taking into consideration the difference in initial weight, the large percentage of the injured set does not appear to be so anomalous. This was also the case in the following sets (Table VIII) where the experiment was the same.

	<i>In. wt.</i>	<i>After operation</i>	<i>Increment</i>		<i>In. wt.</i>	<i>Increment</i>
	<i>grams</i>	<i>grams</i>	<i>per cent</i>		<i>grams</i>	<i>per cent</i>
Set E ^{2a}	1.954	1.878	21.3	Set E ^{2b}	2.089	18.2
				Set G ¹	2.18	11.4

In Sets H³ (Table IX), where the animals were injured by cutting off the tails at the base, and H² (Table XI), where the tails were left intact, the average initial weight, and percentage increments were as follows:

	<i>In. wt.</i> grams	<i>After operation</i> grams	<i>Increment</i> per cent		<i>In. wt.</i> grams	<i>Increment</i> per cent
Set H ³	1.446	1.27	31.6	Set H ²	1.65	20.3

The difference in the initial weights was not great, therefore the percentage may be taken as showing more nearly a correct relation between the injured and the normal sets.

In Sets F^{1a} (Table X) in which animals were injured by cutting regenerating stumps, in F^{1b} (Table X) in which the regenerating stumps were left intact, and in H² (Table IX), the normal control set, the initial weights and the percentage increments were as follows:

	<i>In. wt.</i> grams	<i>After operation</i> grams	<i>Increment</i> per cent		<i>In. wt.</i> grams	<i>Increment</i> per cent
Set F ^{1a}	1.345	1.268	21.8	Set F ^{1b}	1.359	23.5
				Set H ²	1.65	20.3

This is the only case throughout the experiments, however, where the percentage increment was not greater in the injured set.

In Sets I¹, I², I³ (Table XII) the tails were cut six successive times, and the conditions of food and temperature were identical. The initial weights and the percentage increments of the injured sets together with those of the normal controls, A¹ and A², were as follows:

	<i>In. wt.</i> grams	<i>After operation</i> grams	<i>Increment</i> per cent		<i>In. wt.</i> grams	<i>Increment</i> per cent
Set I ¹	1.733	1.425	42.	Set A ¹	2.066	23.3
Set I ²	2.118	1.733	24.5	Set A ²	1.661	29.8
Set I ³	2.489	1.977	23.5			

Initial weights here also seem to account for the irregularities. That the percentage in Set I¹ is greater than either I² and I³, is probably due to the fact that the average initial weight is considerably less. This is true also in the control Sets A¹ and A².

From the comparisons cited above it is found that in some of the cases the initial weight of the injured sets (before the tails were cut) was greater than that of the intact control sets, while

in an equal number of cases the initial weight before the injury was less than in the intact sets. The percentage increment in the majority of cases, however, was greater in the injured sets. This would seem to indicate that the greater percentage increment in the injured sets was not due alone to a smaller initial weight before the tails were cut. It must be remembered, however, that after the tails had been cut off the weight in the injured sets in every case was less than that of the intact sets. It would seem to follow that the greater rate of growth in the injured sets was connected with the decrease in the volume, by removal of the tails. There is another relation to be considered, viz: whether the condition of the tissues themselves play a rôle or whether the result depends simply on relative volume, that is, whether there is any difference between two animals of the same weight, one having been a large animal when its weight was reduced by cutting off the tail, the other an intact smaller animal. The data are insufficient upon which to base a conclusion.

The following table shows four sets that were starved for a period of five weeks, after which time they were fed 153 mg. of beef per week; also four sets as controls which had been fed for five weeks, after which they were also fed 153 mg. of beef per week. The initial weights and the percentage increments were as follows:

	<i>After five weeks' starving</i>		<i>After five weeks of feeding</i>		
	<i>In. wt. grams</i>	<i>Increment per cent</i>	<i>In. wt. grams</i>	<i>Incremen per cent</i>	
Set H ² (Table IX).....	1.65	20.3	Set G ¹ (Table VI)....	2.18	11.4
Set F ^{1a} (Table X).....	1.345	21.8	Set E ^{1a} (Table VII)....	1.904	21.1
Set F ^{1b} (Table X).....	1.359	23.4	Set E ^{1b} (Table VII)....	2.543	5.3
Set F ^{2b} (Table XI).....	1.056	27.8	Set E ^{2b} (Table VIII)....	2.089	18.2

The four sets after starvation gained faster than did the sets after a period of feeding. Set B¹ (Table II) was starved for seventeen weeks, after which it was fed 153 mg. of beef a week for a period of nine weeks. When the percentage or rate of growth is compared with that of normal sets, A¹ and A² (Table I), for an equivalent period, the result is as follows:

	<i>In. wt.</i> <i>grams</i>	<i>Increment</i> <i>per cent</i>		<i>In. wt.</i> <i>grams</i>	<i>Increment</i> <i>per cent</i>
Set B ¹	0.89	54.2	Set A ¹	2.066	23.3
			Set A ²	1.661	29.8

After starvation the rate of growth was faster than in the normal animals. When Set B² (Table II) is compared with Sets A¹ and A² the result is the same. This was probably due to the fact that starvation had reduced the initial weight.

IV. THEORETICAL DISCUSSION

It has been shown that when two animals, one larger than the other, are given just enough food to preserve equilibrium in the large one, the smaller animal gains weight. Assuming that digestion and assimilation in both cases are the same, how may the facts be interpreted? It may be safely assumed that it takes a smaller amount of food to preserve equilibrium in case of the small animal, than in the large one, so that the material over and above that used in actual repair of the body waste goes to form new tissue, to increase the size. According to this view, as the small animal approaches the large one in size, which is the maximum weight for the amount of food taken as a basis, the rate of growth should become less. It takes gradually more and more material to replace waste, because of the new tissue that has been continually added; hence there is less to be used in the formation of new tissue. Even if more food were digested by the larger individual the result would be the same.

By feeding the large one more than enough to preserve equilibrium, and the small one the same amount, the large one will gain; but the rate will be slower than that of the small animal, for the same reason as given above; the small one uses less for repair and more goes to form new tissue.

When animals are injured by cutting off the tails, the increase in rate of growth that follows may be due either to a stimulus produced by the cut, or to an increase owing to the reduction in weight; that is, to a change in the relation between the body material and the amount of food taken. By cutting off the tails

at the base about 15 per cent (average) of the body weight is removed, so that it may be supposed the food material that otherwise would have been used to repair the waste in the tail goes to increase the body weight.

It has been shown that the smaller the animal the greater its rate of growth; it has also been found that after a period of starvation and consequent reduction in size, the rate of growth is faster than in the animals in a well-fed condition. It is probable that when the body material is reduced in animals by cutting off the tails, the increased rate of growth observed may be due to the reduction in size, that is, in proportion to the amount of food taken, rather than to the stimulus of the cut. Whether in addition to this the cut may also act as a stimulus, cannot be affirmed or denied from the experiments so far carried out. The reduction of the body weight by starvation and by cutting off the tails cannot, however, be considered equivalent factors. In the reduction of the initial weight by starvation the condition of the tissue is changed, while when the tails are cut off the remaining tissue still remains in the same condition as before the injury.

SUMMARY

1 Increase in weight in adult *Diemyctylus* is due to an increase in the size of many of the organs of the body, and not to a storage of fat. The converse is also true, that decrease in weight is due to a decrease in the size of the organs.

2 Percentage increment is directly proportional to the amount of food consumed by the individual; the more food consumed the faster is the rate. Rate of growth decreases as the maximum weight is approached. This maximum is determined within limits by the amount of food taken; for a certain amount there is a definite maximum or point where there is established a state of equilibrium between waste and repair. By increasing the amount of food the weight may be increased and a new condition of equilibrium be reached.

3 By cutting off the tails the rate of growth is increased. This increase in rate is probably due to a reduction in the size

of the animal, although from the data it is impossible to determine whether it might not be due to some extent also to the stimulus produced by the cut. Injury in this case reduces the weight of the body without affecting the amount of food digested, therefore it seems reasonable to suppose that less material is needed for repair (there being less material to be repaired), and more goes to increase the weight than is the case in normal control animals.

4 The initial weight is the main factor in determining the percentage increment or rate of growth; the greater the initial weight the less the percentage increment; that is, the larger the animal the more food is used for the actual maintenance of the body material, and the less goes to an increase in weight.

5 Sex may influence the rate of growth, but so far as the data go only indirectly through the initial weight. The average initial weights of the females were less than those of the males.

6 After starvation and subsequent reduction in the initial weight, the rate of growth is higher than in the normal animals. This increase in rate is probably due to the reduction of the initial weight.

7 During starvation the rate of decrease in weight diminishes as the temperature is lowered.

8 If the maximum quantity of food the animals will receive at the lower temperature be taken as a feeding basis, the rate of growth diminishes with the increase of temperature; that is, the rate is highest at the lower temperature and becomes lower as the temperature increases. The quantity of food the animal will take, however, increases with the temperature. It was found that the quantity of food taken by the animals at the intermediate and higher temperatures was three times that taken by those at the lower. Taking as a feeding basis the maximum quantity of food the animals will take at the intermediate temperature (which was also that for those at the higher) the rate of growth diminishes with the increase of temperature. The rates of growth at the intermediate and at the higher temperatures on their own feeding bases were both higher than that at the low temperature on its feeding basis, but the difference in the rates was not in proportion to the difference in quantity of food taken which was three to one.

Temperature, therefore, while influencing the amount of food the animals will take, also influences directly the rate of growth.

I wish to acknowledge my indebtedness and to express my thanks to Professor Morgan, under whose direction the work was done.

Zoological Laboratory
Columbia University

TABLE I

SET A¹

*Showing normal rate of growth. Fed 153 mg.
(average) of beef a week*

SET A²

*Showing normal growth as in A¹, also the
rate of starvation*

SET A ¹					SET A ²						
	No. of animals	Total weight	Average weight	Increase	Per cent inc.	No. of animals	Total weight	Average weight	Increase	Per cent inc.	
Oct.	16	6	12.396	2.066		6	9.968	1.661			
	23	6	11.876	1.979	-0.087	-4.3	6	9.856	1.643	-0.018	-1.
	30	6	12.54	2.09	0.111	5.4	6	10.326	1.721	0.078	4.6
Nov.	6	6	14.208	2.368	0.278	12.4	6	11.967	1.994	0.273	14.7
	13	6	14.	2.333	-0.035	-1.4	6	11.995	1.999	0.005	0.2
	20	6	14.32	2.386	0.053	-2.2	6	12.222	2.037	0.038	1.8
	27	6	14.298	2.383	-0.003	0.1	6	11.917	1.986	-0.051	-2.5
Dec.	4	6	14.735	2.456	0.073	3.	6	12.775	2.129	0.143	6.9
	11	6	15.167	2.528	0.072	2.8	6	13.21	2.202	0.073	3.3
	18	6	15.667	2.611	0.083	3.2	6	13.46	2.243	0.041	1.8
	24	6	16.655	2.776	0.165	6.1	6	13.572	2.262	0.019	0.8
<i>Began to starve</i>											
Jan.	2	6	16.275	2.712	-0.064	-2.3	6	12.625	2.104	-0.158	7.2
	8	6	16.347	2.724	0.012	0.4	6	11.719	1.953	-0.151	7.4
	15	6	16.86	2.81	0.086	3.1	6	11.165	1.861	-0.092	4.8
	22	6	17.492	2.91	0.100	3.	6	11.135	1.856	-0.005	0.2
Feb.	29	6				2.3	6				3.8
	5	6	18.294	3.049	0.139	2.3	6	10.322	1.72	-0.136	3.8
	12	6	19.087	3.181	0.132	4.2	6	10.	1.667	-0.053	3.1
Mar.	19	6	19.43	3.24	0.059	1.8	6	9.705	1.618	-0.049	2.9
	26	6	19.135	3.189	-0.061	-1.8	6	9.425	1.571	-0.047	2.9
	5	6	19.21	3.201	0.012	0.3	6	9.275	1.546	-0.025	1.6
Mar.	12	6	18.945	3.158	-0.043	-1.3	6	8.575	1.429	-0.117	7.8
	19	6	18.595	3.099	-0.059	-1.8	6	8.237	1.373	-0.056	3.9
	26	6	18.065	3.011	-0.088	-2.8	6	7.75	1.29	-0.083	6.2
	<i>Began to feed 450 mg. (average) of beef a week</i>										
Apr.	2	6	19.065	3.177	0.166	5.3	6	7.289	1.215	-0.075	5.9
	9	6	20.142	3.357	0.18	5.5	6	7.235	1.206	-0.009	0.7
	16	6	20.685	3.447	0.09	2.6	6	6.955	1.159	-0.047	3.6
			Mean (average)	Increase.	Per cent increase.			Mean (average)	Increase	Per cent increase	
From						From					
	Oct. 16 to Dec. 18	2.338	0.545	23.3		Oct. 16 to Dec. 18	1.952	0.582	29.8	
	Oct. 16 to Feb. 19	2.653	1.174	44.2		Oct. 16 to Nov. 20	1.849	0.376	20.3	
	Dec. 18 to Feb. 19	2.925	0.629	21.5		Dec. 24 to Apr. 16	1.710	1.103	64.5	
	Oct. 16 to Nov. 20	2.226	0.320	14.3						

TABLE II

SET B¹
Showing the result of starvation and of subsequent feeding

	No. of animals	Total weight	Average weight	Loss	Per cent loss
Oct. 16	6	11.561	1.927		
23	6	10.761	1.794	-0.133	7.1
30	6	10.278	1.713	-0.081	4.6
Nov. 6	6	9.76	1.627	-0.086	5.1
13	6	9.292	1.548	-0.079	4.9
20	6	8.784	1.464	-0.084	5.5
27	6	8.2	1.366	-0.098	6.9
Dec. 4	6	8.059	1.343	-0.023	1.6
11	6	7.629	1.271	-0.072	5.5
18	6	7.12	1.187	-0.084	6.8
24	6	6.842	1.14	-0.047	4.
Jan. 2	6	6.597	1.1	-0.04	3.5
8	6	6.094	1.016	-0.084	7.9
15	6	5.925	0.988	-0.028	2.7
22	6	5.905	0.984	-0.004	0.4
29	6	5.505	0.918	-0.066	3.45
Feb. 5	6	5.505	0.918	-0.066	3.45
12	5	4.45	0.89	-0.028	3.

Began to feed 153 mg. (average) of beef a week

			increase	% inc.	
19	4	5.007	1.251	0.361	33.7
26	3	5.94	1.313	0.062	4.8
Mar. 5	3	4.085	1.362	0.049	3.5
12	3	4.005	1.335	-0.027	-2.
19	3	4.103	1.368	0.033	2.4
26	3	4.105	1.368	0.00	0.0
Apr. 2	3	4.085	1.362	-0.006	-0.4
9	3	4.285	1.428	0.066	4.7
16	3	4.655	1.552	0.124	8.3

Mean (average) Loss and increase Per cent

From	Mean (average)	Loss and increase	Per cent
Oct. 16 to Feb. 12.	1.408	-1.037	-73.6
Oct. 16 to Dec. 18.	1.557	-0.740	-47.5
Feb. 12 to Apr. 16.	1.221	0.662	54.2
Oct. 16 to Dec. 11.	1.599	0.656	41.
Dec. 11 to Feb. 12.	1.08	0.381	35.2

SET B²
Showing the result of starvation and of subsequent feeding

	No. of animals	Total weight	Average weight	Loss	Per cent loss
6	6	11.756	1.959		
6	6	11.161	1.86	0.099	5.1
6	6	10.376	1.729	0.131	7.3
6	6	9.983	1.664	0.065	3.8
6	6	9.51	1.585	0.079	4.8
6	6	9.068	1.511	0.074	4.7
6	6	8.787	1.465	0.046	3.
6	6	8.31	1.385	0.08	5.6
6	6	7.722	1.287	0.098	7.3
6	6	7.465	1.244	0.043	3.3

Began to feed 153 mg. of beef a week

			increase	% inc.	
6	6	8.926	1.488	0.244	17.1
6	6	8.435	1.406	-0.082	-5.6
6	6	9.002	1.5	0.094	6.4
6	6	9.54	1.59	0.09	5.8
6	6	10.26	1.71	0.12	7.2
6	6	11.13	1.855	0.145	4.
6	6	11.34	1.89	0.035	1.8

Mean (average) Loss and increase Per cent

From	Mean (average)	Loss and increase	Per cent
Oct. 16 to Dec. 18	1.601	-0.715	-44.6
Dec. 18 to Apr. 16	1.694	0.901	53.1
Dec. 18 to Feb. 19	1.620	0.753	46.4

TABLE III

Showing normal rate of growth. Fed 102 mg. of beef (average) a week Showing normal growth as in C¹. Fed 102 mg. of beef a week

SET C ¹					SET C ²					
	No. of animals	Total weight	Average weight	Increase	Per cent inc.	No. of animals	Total weight	Average weight	Increase	Per cent inc.
Oct. 16	6	11.118	1.853			6	12.661	2.11		
23	6	11.131	1.855	0.002	0.1	6	12.805	2.134	0.024	1.1
30	6	11.277	1.879	0.024	1.2	6	12.991	2.165	0.031	1.4
Nov. 6	6	11.966	1.994	0.115	5.9	6	13.821	2.304	0.139	6.2
13	6	11.815	1.969	-0.025	-1.2	6	13.505	2.251	-0.053	-2.3
20	6	11.595	1.933	-0.036	-1.8	6	13.515	2.252	0.001	0.04
27	6	11.79	1.965	0.032	1.6	6	13.197	2.2	-0.052	-2.3
Dec. 4	6	12.305	2.051	0.086	4.2	6	13.85	2.308	0.108	4.7
11	6	11.61	1.935	-0.116	-5.8	6	13.777	2.296	-0.012	-0.5
18	6	13.37	2.23	0.295	14.1	6	14.64	2.44	0.144	6.

Began to feed 153 mg. of beef a week

Jan. 24	6	14.97	2.495	0.265	11.2	6	14.815	2.469	0.029	1.1
Jan. 2	6	14.777	2.463	-0.032	-1.2	6	14.845	2.474	0.005	0.2
8	6	14.977	2.496	0.033	1.3	6	14.897	2.483	0.009	0.3
15	6	15.44	2.573	0.077	3.03	6	14.775	2.463	-0.02	-0.8
22	6	17.324	2.887	0.314	11.5	6	15.395	2.551	0.088	3.5
29	6				2.2	6				3.
Feb. 5	6	18.105	3.018	0.131	2.2	6	16.285	2.714	0.163	3.
12	6	18.997	3.166	0.148	4.7	6	15.095	2.516	-0.198	-7.5
19	6	19.06	3.176	0.01	0.3	6	16.037	2.673	0.157	6.
26	6	18.555	3.093	-0.083	-2.6	6	16.035	2.673	0.00	0.
Mar. 5	6	18.92	3.153	0.06	1.9	6	15.965	2.661	-0.012	-0.4
12	6	18.365	3.061	-0.092	-2.9	6	15.077	2.513	-0.148	-5.7
19	6	18.73	3.12	0.059	1.9	6	15.072	2.512	-0.001	0.03
26	6	18.425	3.071	-0.049	-1.5	6	15.125	2.521	0.009	0.3

Began to feed 204 mg. of beef a week

Apr. 2	6	17.955	2.992	-0.079	-2.6	6	14.865	2.477	-0.044	-1.7
9	6	18.295	3.049	0.057	1.8	6	15.607	2.601	0.124	4.8
16	6	18.965	3.161	0.112	3.6	6	15.875	2.646	0.045	1.7

From	Mean (average)	Increase	Per cent increase	From	Mean (average)	Increase	Per cent increase
Oct. 16 to Dec. 18....	2.041	0.377	18.4	Oct. 16-Dec. 18	2.27	0.33	14.5
Dec. 18 to Feb. 19....	2.703	0.946	34.9	Dec. 18-Feb. 19	2.556	0.233	9.1
				Oct. 16-Feb. 19	2.391	0.563	23.5

TABLE IV

SET D¹
Rate of growth after cutting tails off at base. Fed 153
mg. of beef a week

SET D²
Tails cut at base as in D¹

SET D ¹						SET D ²					
Rate of growth after cutting tails off at base. Fed 153 mg. of beef a week						Tails cut at base as in D ¹					
	No. of animals	Total weight	Average weight	Increase	Per cent inc.	No. of animals	Total weight	Average weight	Increase	Per cent inc.	
Oct. 23		+ tails					+ tails				
		13.516	2.253				11.491	1.915			
6		- tails					- tails				
		11.916	1.986				9.998	1.666			
30	6	13.478	2.246	0.26	12.2	6	11.474	1.912	0.246	13.7	
Nov. 6	6	13.477	2.246	0.00	0.0	Began to starve					
	13	14.487	2.414	0.168	7.2						
	20	13.745	2.291	-0.123	-5.2						
	27	11.537	2.307	0.016	0.6						
Dec. 4	5	11.955	2.391	0.084	3.5	0					
	11	12.767	2.553	0.162	6.5						
	18	10.71	2.678	0.125	4.7	6	8.892	1.482			
						Fed 153 mg. of beef a week					
24	3	8.096	2.698	0.02	0.7	6	11.213	1.869	0.387	23.1	
Jan. 2	3	7.89	2.63	-0.068	-2.5	6	11.412	1.902	0.033	1.7	
	8	8.085	2.695	0.065	2.4	6	11.865	1.978	0.076	3.9	
	15	8.2	2.733	0.038	1.4	6	13.105	2.184	0.106	5.	
22	3	7.545	2.515	-0.218	8.3	6	14.25	2.375	0.191	8.3	
Feb. 5	3				7.4	6				2.5	
	5	8.765	2.922	0.407	7.4	6	15.	2.5	0.125	2.5	
	12	8.84	2.943	0.021	0.7	6	16.535	2.756	0.256	9.7	
19	3	8.92	2.973	0.03	1.01	6	16.5	2.75	-0.006	-0.2	
26	3	9.12	3.04	0.067	2.2	6	16.955	2.826	0.076	2.7	
Mar. 5	3	8.965	2.988	-0.032	-1.7	6	17.565	2.928	0.102	3.5	
	12	8.78	2.926	-0.062	-2.	6	16.689	2.782	-0.146	-5.1	
	19	8.657	2.886	-0.04	-1.3	6	16.737	2.789	0.007	0.2	
	26	3	8.52	2.84	-0.046	-1.6	6	17.17	2.862	0.073	2.5
Began to feed 408 mg. of beef a week						Began to feed 306 mg. (average) beef a week					
Apr. 2	3	8.2	2.73	-0.011	-3.9	6	17.225	2.871	0.009	0.3	
	9	9.295	3.098	0.368	12.6	6	18.44	3.073	0.202	6.7	
	16	9.105	3.035	-0.063	-2.	6	19.205	3.201	0.128	4.	
		Mean (average)	Increase	Per cent increase		Mean (average)	Increase	Per cent increase			
From Oct. 23 to Dec. 24		2.342	0.712	30.4	From						
Dec. 24 to Feb. 26		2.869	0.342	11.9	Dec. 18-Jan. 15	1.833	0.702	38.2			
Oct. 23 to Nov. 27		2.2	0.428	19.5							

TABLE V

SET E²

Rate of growth after cutting tails off at base. Fed 153 mg. of beef a week

No. of animals		Total weight	Average weight	Increase	Per cent inc.
Nov. 13		+ tails			
	10	20.44	2.044		
		- tails			
	10	17.3	1.73		
17	10	18.047	1.805	0.075	4.2
20	10	18.035	1.804	-0.001	-0.05
27	10	17.83	1.783	-0.021	-1.1
Dec. 4	10	18.347	1.835	0.052	2.8
11	10	19.067	1.907	0.072	3.8
18	10	19.217	1.922	0.015	0.7
			Mean (average)	Increase	Per cent increase
From	Nov. 13 to Dec. 18....		1.826	0.192	10.5

SET G²

Normal intact control. Fed as in E²

No. of animals		Total weight	Average weight	Increase	Per cent inc.
10		21.112	2.111		
10		21.207	2.121	0.01	0.4
10		20.81	2.081	-0.04	-1.9
10		20.067	2.007	-0.074	-3.6
10		20.095	2.01	0.003	0.1
10		20.445	2.045	0.035	1.7
10		20.794	2.079	0.034	1.6
			Mean (average)	Loss	Per cent loss
From	Nov. 13-Dec. 18		2.095	-0.032	-1.2

SET E¹

Same as Set E²

No. of animals		Total weight	Average weight	Increase	Per cent inc.
Nov. 13		+ tails			
	10	22.635	2.264		
		- tails			
	10	18.865	1.887		
17	10	18.995	1.899	0.012	0.6
20	10	19.256	1.926	0.027	1.4
27	10	20.295	2.03	0.104	5.2
Dec. 4	10	20.765	2.077	0.047	2.2
11	10	21.627	2.163	0.086	4.
18	10	21.882	2.188	0.025	1.1
			Mean (average)	Increase	Per cent increase
From	Nov. 13 to Dec. 18....		2.037	0.301	14.7

SET G¹

Same as G²

No. of animals		Total weight	Average weight	Increase	Per cent inc.
10		19.442	1.944		
10		18.936	1.894	-0.05	-2.6
10		19.655	1.966	0.072	3.7
10		19.535	1.954	-0.012	-0.6
10		20.189	2.019	0.065	3.2
10		21.09	2.109	0.09	4.3
10		21.795	2.18	0.071	3.3
			Mean (average)	Increase	Per cent increase
From	Nov. 13-Dec. 18		2.062	0.236	11.4

TABLE V—Continued

SET E ³ Same as Set E ²						SET G ² Same as G ²					
	No. of animals	Total weight	Average weight	Increase	Per cent inc.	No. of animals	Total weight	Average weight	Increase	Per cent inc.	
Nov. 13	10	+ tails	18.778	1.878		10	19.65	1.965			
		- tails	16.14	1.614							
			16.004	1.6	-0.014						-0.8
17	10	16.156	1.616	0.015	0.9	10	19.785	1.979	0.014	0.7	
20	10	16.342	1.634	0.018	1.1	10	20.19	2.019	0.030	2.	
27	10	17.349	1.735	0.101	5.9	10	19.895	1.99	-0.029	-1.4	
Dec.	4	10	17.469	1.747	0.012	0.6	10	20.26	2.026	0.036	1.7
	11	10	18.62	1.862	0.115	6.3	10	20.595	2.06	0.034	1.6
	18	10					10	20.988	2.099	0.039	1.8
				Mean (average)	Increase	Per cent increase			Mean (average)	Increase	Per cent increase
From						From					
	Nov. 13 to Dec. 18		1.738	0.248	14.2	Nov. 13—Dec. 18		2.032	0.134	6.5	

TABLE VI

SET E³

Rate after cutting tails off at base. Fed 153 mg. of beef a week

SET G¹

Normal control. Fed as in E³

SET E ³					SET G ¹					
Rate after cutting tails off at base. Fed 153 mg. of beef a week					Normal control. Fed as in E ³					
	No. of animals	Total weight	Average weight	Increase	Per cent inc.	No. of animals	Total weight	Average weight	Increase	Per cent inc.
Nov. 13	10	+ tails	18.778	1.878		10	19.442	1.944		
		- tails	16.14	1.614						
20	10	16.156	1.616	0.002	0.1	10	19.655	1.966	0.022	1.1
27	10	16.342	1.634	0.018	1.1	10	19.535	1.954	-0.012	-0.6
Dec. 4	10	17.349	1.735	0.101	5.9	10	20.189	2.019	0.065	3.2
11	10	17.469	1.747	0.012	0.6	10	21.09	2.109	0.09	4.3
18	10	18.62	1.862	0.115	6.3	10	21.795	2.18	0.071	3.3
24	10	19.7	1.97	0.108	5.6	10	23.535	2.354	0.174	7.6
Jan. 2	10	19.547	1.955	-0.015	-0.7	10	23.367	2.337	-0.017	-0.7
8	10	20.222	2.022	0.067	3.4	10	24.845	2.485	0.148	6.1
15	10	21.125	2.113	0.091	4.4	10	24.452	2.445	-0.04	-1.6
22	10	22.485	2.249	0.136	6.2	10	26.185	2.619	0.174	6.8
29	10				4.	10				4.4
Feb. 5	10	24.405	2.441	0.192	4.	10	28.615	2.862	0.243	4.4
12	10	25.268	2.527	0.086	3.4	10	29.105	2.911	0.049	1.6
19	10	26.255	2.626	0.099	3.8	10	30.597	3.06	0.149	4.9
26	10	26.192	2.619	-0.006	-0.3	8	24.165	3.021	-0.039	-1.4
Mar. 5	10	26.645	2.665	0.046	1.7	8	23.515	2.939	-0.082	-2.7
12	10	26.725	2.673	0.008	0.2	8	23.385	2.924	-0.015	-0.5
19	10	26.875	2.688	0.015	0.5					
26	10	26.49	2.649	-0.039	-1.4					
Apr. 2	10	26.115	2.612	-0.037	-1.4					
9	10	26.425	2.643	0.031	1.1					
16	10	26.475	2.648	0.005	0.1					
			Mean (average)	Increase	Per cent increase			Mean (average)	Increase	Per cent increase
From Nov. 13 to Feb. 19			2.12	1.012	47.7	From				
Dec. 18 to Jan. 15			1.987	0.251	12.6	Dec. 18-Jan. 15	2.312	0.265	11.4	
Jan. 15 to Mar. 19			2.4	0.575	23.9	Nov. 13-Feb. 19	2.502	1.116	44.6	
Nov. 13 to Jan. 15			1.863	0.499	26.7					

TABLE VII

SET E ^a Regenerating tails cut off at base. Fed 153 mg. of beef a week						SET E ^b Regenerating tails intact. Fed as in E ^a				
	No. of animals	Total weight	Average weight	Increase	Per cent inc.	No. of animals	Total weight	Average weight	Increase	Per cent inc.
Dec. 18	5	+ stumps				5	12.705	2.541		
		9.52	1.904							
		stumps								
		0.205	0.041							
		- stumps								
		9.177	1.835							
24	5	10.3	2.06	0.225	11.5	5	13.11	2.622	0.081	3.1
Jan. 2	5	10.311	2.062	0.002	0.09	5	12.927	2.585	-0.037	-1.4
8	5	10.837	2.167	0.105	4.9	5	13.14	2.628	0.043	1.6
15	5	11.337	2.267	0.10	4.5	5	13.414	2.683	0.055	2.
			Mean (average)	Increase	Per cent increase			Mean (average)	Increase	Per cent increase
From						From				
Dec. 18 to Jan. 15			2.051	0.432	21.	Dec. 18 to Jan. 15		2.613	0.142	5.4

TABLE VIII

SET E:^a

Regenerating tails cut off at base. Fed 153 mg. of beef a week

SET E:^b

Control. Regenerating tails intact. Fed as in E:^a

		No. of animals	Total weight	Average weight	Increase	Per cent inc.			No. of animals	Total weight	Average weight	Increase	Per cent inc.
Dec.	18	5	+ stumps	1.954					5	10.447	2.089		
			9.77 stumps										
			0.21										
			- stumps										
			9.39	1.878									
Jan.	24	5	10.436	2.087	0.209	10.5		5	11.165	2.233	0.144	6.6	
	2	5	10.535	2.107	0.02	0.9		5	11.167	2.233	0.000		
	8	5	11.417	2.283	0.176	8.		5	12.342	2.468	0.235	10.0	
	15	5	11.63	2.326	0.043	1.8		5	12.545	2.509	0.041	1.6	
				Mean (average)	Increase	Per cent increase					Mean (average)	Increase	Per cent increase
From								From					
	Dec. 18 to Jan. 15			2.102	0.448	21.3		Dec. 18 to Jan. 15			2.299	0.42	18.2

TABLE IX

SET H ³					SET H ²					
<i>Tails cut off at base after 5 weeks' starvation. Fed 153</i>					<i>Normal control after 5 weeks' starvation.</i>					
<i>mg. of beef a week</i>					<i>Fed as in H³</i>					
No. of animals	Total weight	Average weight	Increase	Per cent inc.	No. of animals	Total weight	Average weight	Increase	Per cent inc.	
	+tails									
	14.455	1.446								
Dec. 18	10	1.515	0.152		10	16.495	1.65			
	-tails									
	12.702	1.27								
24	10	15.242	1.524	0.254	18.1	10	19.222	1.922	0.272	15.2
Jan. 2	10	16.357	1.636	0.112	7.	10	18.857	1.886	-0.036	-1.8
8.	10	16.562	1.656	0.020	1.2	10	19.632	1.963	0.077	4.
15	10	17.477	1.748	0.092	5.4	10	20.229	2.023	0.06	3.
		Mean (average)	Increase	Per cent increase			Mean (average)	Increase	Per cent increase	
From					From					
Dec. 18 to Jan. 15		1.509	0.478	31.6	Dec. 18 to Jan. 15		1.836	0.373	20.3	

TABLE X

SET F ^{1a}					SET F ^{1b}					
Regenerating tails cut off at base after 5 weeks' starvation. Fed 153 mg. of beef a week					Regenerating tails intact after 5 weeks' starvation. Fed as in F ^{1a}					
No. of animals	Total weight	Average weight	Increase	Per cent inc.	No. of animals	Total weight	Average weight	Increase	Per cent inc.	
	+ stumps									
	6.715	1.345								
	stumps									
	0.185									
	- stumps									
	6.34	1.268								
Dec. 18	5				5	6.795	1.359			
24	5	7.855	1.571	0.303	21.3	5	8.4	1.68	0.321	21.1
Jan. 2	5	7.735	1.547	-0.024	-1.5	5	8.025	1.605	-0.075	-4.5
8	5	7.72	1.544	-0.003	-0.1	5	8.309	1.662	0.057	3.4
15	5	7.897	1.579	0.035	2.2	5	8.6	1.72	0.058	3.4
22	5	8.89	1.778	0.199	11.8	5	9.575	1.915	0.195	10.7
29					4.5	5				2.9
Feb. 5	5	9.745	1.949	0.171	4.5	5	10.15	2.03	0.115	2.9
12	5	10.175	2.035	0.086	4.3	5	10.825	2.165	0.133	6.3
19	5	10.35	2.07	0.035	1.7	5	11.192	2.238	0.073	3.3
26	5	10.755	2.151	0.081	3.8	5	11.225	2.245	0.007	0.3
Mar. 5	5	10.805	2.161	0.01	0.4	5	11.335	2.267	0.012	0.5
12	5	10.577	2.115	-0.046	-2.1	5	11.033	2.207	+0.06	-2.6
19	5	10.555	2.111	-0.004	-0.1	5	10.915	2.183	-0.024	-1.
26	5	11.11	2.222	0.111	5.1	5	11.31	2.262	0.079	3.5
<i>Began to feed 204 mg. of beef a week</i>					<i>Began to feed 408 mg. of beef a week</i>					
Apr. 2	5	11.11	2.222	0.000	0.0	5	11.395	2.279	0.019	0.8
9	5	11.657	2.331	0.111	4.8	5	12.605	2.521	0.242	10.
16	5	12.405	2.481	0.15	6.2	5	13.205	2.641	0.12	7.5
		Mean (average)	Increase	Per cent increase			Mean (average)	Increase	Per cent increase	
From						From				
Dec. 18 to Jan. 15	1.424	0.311	21.8		Dec. 18 to Jan. 15	1.539	0.361	23.4	
Dec. 18 to Mar. 26	1.744	0.954	54.6		Dec. 18 to Mar. 26	1.81	0.903	49.8	

TABLE XI

SET F ^a					SET F ^b						
Regenerating tails cut off in middle after 5 weeks' starvation. Fed 153 mg. of beef a week					Regenerating tails intact after 5 weeks' starvation. Fed as in F ^a						
	No. of animals	Total weight	Average weight	Increase	Per cent inc.	No. of animals	Total weight	Average weight	Increase	Per cent inc.	
		+ tails									
		6.36	1.272								
		- tails									
		6.286	1.257			5	5.28	1.056			
Dec. 18	5										
	24	5	7.592	1.518	0.261	18.8	5	6.567	1.313	0.257	21.7
Jan. 2	5		7.595	1.519	0.001	0.06	5	6.43	1.286	-0.027	2.
	8	5	7.869	1.574	0.055	3.5	5	6.72	1.344	0.058	4.4
	15	5	8.375	1.675	0.101	6.2	5	6.987	1.397	0.053	3.8
			Mean (average)	Increase	Per cent increase			Mean (average)	Increase	Per cent increase	
From							From				
Dec. 18 to Jan. 15.			1.466	0.418	28.5	From	Dec. 18 to Jan. 15	1.226	0.341	27.8	

SET I
Tails cut 6 successive times. Fed 153 mg. of beef a week

	No. of animals	SET I				SET II				SET III			
		Total weight	Average weight	Increase	Per cent inc.	Total weight	Average weight	Increase	Per cent inc.	Total weight	Average weight	Increase	Per cent inc.
Nov. 13	6	+ tails	1.733			+ tails	2 118			+ tails	2.489		
		- tails	10.4			- tails	12.705			- tails	14.935		
20	6	+ tails	1.683			+ tails	2.03			+ tails	2.388		
		- tails	10.039			- tails	11.654		-0.088	- tails	13.68		-0.108
27	6	+ tails	1.641			+ tails	1.891			+ tails	2.232		
		- tails	9.85		0.01	- tails	11.345		-0.088	- tails	13.395		-0.108
Dec. 4	6	+ tails	1.653			+ tails	1.889			+ tails	2.248		
		- tails	9.919		0.012	- tails	11.335		-0.002	- tails	13.487		0.016
11	6	+ tails	1.615			+ tails	1.836			+ tails	2.21		
		- tails	10.595		0.136	- tails	11.015		-0.01	- tails	13.261		0.71
18	6	+ tails	1.751			+ tails	1.965			+ tails	2.278		
		- tails	10.177		0.136	- tails	11.753		0.12	- tails	13.67		0.068
24	6	+ tails	1.696			+ tails	1.885			+ tails	2.181		
		- tails	10.925		0.125	- tails	11.307		0.104	- tails	13.091		0.138
Jan. 2	6	+ tails	1.742			+ tails	1.922			+ tails	2.319		
		- tails	10.454		0.177	- tails	11.532		0.104	- tails	13.917		0.138
8	6	+ tails	1.919			+ tails	2.011			+ tails	2.347		
		- tails	11.514		0.177	- tails	12.065		0.089	- tails	14.08		0.147
15	6	+ tails	1.865			+ tails	1.956			+ tails	2.246		
		- tails	11.187		0.18	- tails	11.735		0.213	- tails	13.475		0.211
15	6	+ tails	2.045			+ tails	2.169			+ tails	2.457		
		- tails	12.27		0.039	- tails	13.015		0.086	- tails	14.74		-0.042
15	6	+ tails	2.164			+ tails	2.083			+ tails	2.445		
		- tails	12.985		0.08	- tails	12.497		0.1	- tails	14.487		0.03
15	6	+ tails	2.199			+ tails	2.183			+ tails	2.445		
		- tails	13.192		0.035	- tails	13.115		0.036	- tails	15.107		0.073

TABLE XII—Continued

Set	Mean (average)	Increase	Per cent increase
I ¹ ... From Nov. 13 to Jan. 15.	1.812	0.774	42.7
I ² ... Nov. 13 to Jan. 15.	1.976	0.486	24.5
I ³ ... Nov. 13 to Jan. 15.	2.252	0.531	23.5

TABLE XIII

SET G^b

SET G^b

Tails cut 6 successive times. Fed 153 mg. of
beef a week

Tails cut 9 successive times. Fed as in G^b

		No. of animals	Total weight	Average weight	Increase	Per cent inc.			No. of animals	Total weight	Average weight	Increase	Per cent inc.
			+ tails							+ tails			
			9.437	1.887						9.75	1.95		
			tails							- tails			
Dec.	18	5	0.22	0.034			Dec.	18	5	9.545	1.909		
			- tails							+ tails			
			9.235	1.847						9.97	1.994		
			+ tails							- tails		0.085	4.3
Dec.	24	5	10.209	2.042	0.195	10.	24	5	9.867	1.974			
			tails							+ tails			
			0.197	0.029						9.76	1.952		
			- tails				Jan.	2	5	- tails		-0.022	-1.1
			10.064	2.013						9.57	1.914		
			+ tails							+ tails			
Jan.	2	5	10.03	2.006	-0.007	-0.3				10.047	2.009		
			tails							- tails		-0.095	4.8
			0.17	0.034						9.857	1.971		
			- tails							+ tails			
			9.914	1.983						10.429	2.086		
			+ tails							- tails		0.115	5.6
			10.295	2.059	0.076	3.7				10.07	2.014		
			tails							+ tails			
			0.252	0.054						10.805	2.161		
			- tails							- tails		0.147	7
			9.96	1.992						10.622	2.124		
			+ tails							+ tails			
			10.8	2.16	0.168	8.2				11.055	2.211		
			tails							- tails		0.087	4.
15	5		0.335	0.067						10.76	2.152		
			- tails							+ tails			
			10.366	2.073						11.5	2.3		
			+ tails							- tails		0.148	6.6
			10.961	2.192	0.152	7.	Feb.	5	5	11.15	2.23		
			11.125	2.225						+ tails			
			- tails							11.75	2.35		
			10.961	2.192						- tails		0.120	5.2
			9.055	2.264	0.072	3.2				11.425	2.285		
Feb.	5	3	7.465	2.488	0.224	9.4				11.425	2.285		
			7.615	2.538	0.05	1.9				9.637	2.409	0.124	5.2
			7.895	2.631	0.093	3.5				9.155	2.288	-0.121	-5.1
			8.01	2.670	0.039	1.4	Mar.	5	4	9.967	2.492	0.204	8.5

TABLE XIII—Continued

		No. of animals	Total weight	Average weight	Increase	Per cent inc.			No. of animals	Total weight	Average weight	Increase	Per cent inc.
Mar.	5	3	8.077	2.692	0.022	0.8	Mar.	12	4	9.825	2.456	0.036	1.4
	12	3	7.905	2.635	-0.047	-1.7		19	4	9.845	2.461	0.005	0.2
	19	3	7.975	2.658	0.023	0.8		26	4	9.79	2.447	-0.014	-0.5
	26	3	7.965	2.655	-0.003	0.1	Apr.	2	4	9.555	2.388	-0.059	-2.4
Apr.	2	3	7.965	2.655	0.000			9	4	9.795	2.448	0.06	2.4
								16	4	9.935	2.484	0.035	1.4
				Mean (average)	Increase	Per cent increase					Mean (average)	Increase	Per cent increase
From							From						
Dec. 18 to Feb. 19...				2.104	1.101	52.3	Dec. 18 to Mar. 19				1.997	0.974	48.7

TABLE XIV

SET F ¹						SET H ¹					
<i>Rate after cutting tails off at base. Starved.</i>						<i>Normal intact. Starved.</i>					
	No. of animals	Total weight	Average weight	Loss	Per cent loss	No. of animals	Total weight	Average weight	Loss	Per cent loss	
Nov. 13	10	+tails	20.679	2.068		10	20.287	2.029			
		-tails	17.552	1.755							
20	10	17.095	1.71	0.045	2.5	10	19.429	1.943	0.086	4.3	
27	10	16.077	1.608	0.102	6.1	10	17.605	1.761	0.182	9.8	
Dec. 4	10	15.45	1.545	0.063	3.9	10	16.615	1.662	0.099	5.7	
	11	10	14.327	1.433	0.112	7.5	10	15.935	1.594	0.068	4.1
	18	10	13.51	1.351	0.082	5.8	10	15.542	1.554	0.04	2.5
			Mean (average)	Loss	Per cent loss			Mean (average)	Loss	Per cent loss	
From	Nov. 13 to Dec. 18. . . .		1.553	0.404	26.	From	Nov. 13-Dec. 18		1.791	0.475	26.5

SET F ²						SET H ²					
<i>Same as Set F¹</i>						<i>Same as H¹</i>					
	No. of animals	Total weight	Average weight	Loss	Per cent loss	No. of animals	Total weight	Average weight	Loss	Per cent loss	
Nov. 13	10	+tails	19.886	1.989		10	22.445	2.245			
		-tails	16.872	1.687							
20	10	16.664	1.666	0.021	1.2	10	21.303	2.13	0.115	5.2	
27	10	15.47	1.547	0.019	1.1	10	19.76	1.976	0.154	7.5	
Dec. 4	10	15.092	1.509	0.038	2.4	10	19.075	1.908	0.068	3.5	
	11	10	14.177	1.418	0.091	6.2	10	17.575	1.758	0.15	8.1
	18	10	13.162	1.316	0.102	7.4	10	16.495	1.65	0.108	6.3
			Mean (average)	Loss	Per cent loss			Mean (average)	Loss	Per cent loss	
From	Nov. 13 to Dec. 18. . . .		1.501	0.371	24.6	From	Nov. 13-Dec. 18		1.947	0.595	30.5

TABLE XIV—Continued

SET F ³ Same as F ¹					SET H ³ Same as H ¹						
	No. of animals	Total weight	Average weight	Loss	Per cent loss		No. of animals	Total weight	Average weight	Loss	Per cent loss
Nov. 13	10	+ tails 17.52	1.752				10	19.607	1.961		
		- tails 15.495	1.55								
	20	14.815	1.482	0.068	4.4		10	18.771	1.877	0.084	4.3
	27	13.825	1.382	0.1	6.9		10	17.307	1.731	0.146	8.
Dec. 4	10	13.287	1.329	0.053	3.9		10	16.379	1.638	0.093	5.5
	11	12.397	1.24	0.089	6.9		10	15.332	1.533	0.105	6.6
	18	11.64	1.164	0.076	6.3		10	14.455	1.446	0.087	6.
			Mean (average)	Loss	Per cent loss				Mean (average)	Loss	Per cent loss
From						From					
	Nov. 13 to Dec. 18....		1.357	0.386	24.8		Nov. 13-Dec. 18	1.703	0.515	30.2	

TABLE XV

SET F²

Regenerating tails. Rate of growth after starvation.
Fed. 153 mg. of beef a week

	No. of animals	Total weight	Average weight	Increase	Per cent inc.
Dec. 18	10	13.162	1.316		
24	10	16.437	1.644	0.328	22.1
Jan. 2	10	16.04	1.604	-0.040	-2.4
8	10	16.507	1.651	0.047	2.8
15	10	17.269	1.727	0.076	4.4
22	10	18.37	1.837	0.11	6.1
29					6.5
Feb. 5	10	20.935	2.094	0.257	6.5
12	10	21.465	2.147	0.053	2.5
19	10	23.035	2.304	0.157	7.
26	10	23.095	2.31	0.006	0.2
Mar. 5	10	23.294	2.329	0.019	0.8
12	10	22.925	2.293	-0.036	-1.5
19	10	23.095	2.31	0.017	0.7
26	10	22.812	2.281	-0.029	-1.2
Apr. 2	10	22.115	2.212	-0.069	-3.
9					
16					
			Mean (average)	Increase	Per cent increase
From Dec. 18 to Mar. 5			1.822	1.013	55.5

SET H²

Normal intact control after starvation.
Fed as in F²

	No. of animals	Total weight	Average weight	Increase	Per cent inc.
Dec. 18	10	16.495	1.65		
24	10	19.222	1.922	0.272	15.2
Jan. 2	10	18.857	1.886	-0.036	-1.8
8	10	19.632	1.963	0.077	4.
15	10	20.229	2.023	0.06	3.
22	10	21.69	2.169	0.146	6.9
29	10				5.3
Feb. 5	10	24.13	2.413	0.244	5.3
12	10	24.89	2.489	0.076	3.2
19	10	25.885	2.589	0.1	3.9
26	10	25.4	2.54	-0.049	-1.9
Mar. 5	7	19.035	2.719	0.179	6.8
12	5	12.537	2.507	-0.211	-8.1
19	5	12.502	2.5	-0.007	-0.2
26	5	11.84	2.368	-0.132	-5.4
Apr. 2	5	11.595	2.319	-0.049	-2.
9	5	11.925	2.385	0.066	2.8
16	5	12.44	2.48	0.095	3.9
			Mean (average)	Increase	Per cent increase
From Dec. 18 to Mar. 5			2.184	1.069	48.9

TABLE XVI

SET A
Rate of growth at high temperature 28.2° (average). Fed

	Av. temperature degrees C.	No. of animals	Total weight	Average weight	Increase	Per cent
Feb. 21		6	11.8	1.967		
Mar. 5	27.5	6	10.057	1.676	-0.291	-15.9
12	27.6	6	9.15	1.525	-0.151	-9.4
19	29.	6	8.835	1.473	-0.053	-3.4
26	27.	5	7.425	1.485	0.012	0.8
Apr. 2	30.6	5	7.04	1.408	-0.077	-5.3
9	29.	5	7.095	1.419	0.011	0.7
16	26.2	5	7.15	1.43	0.011	0.7
			Mean (average)	Loss	Per cent loss	
From						
Feb. 21 to Apr. 16			1.698	-0.537	-31	

SET B
At room temperature 22° (average). Fed

		No. of animals	Total weight	Average weight	Increase	Per cent
Feb. 21		6	13.08	2.18		
Mar. 5	21.5	6	12.355	2.059	-0.121	-5.7
12	22.1	6	11.327	1.888	-0.171	-8.6
19	22.	6	10.745	1.791	-0.097	-5.2
26	22.	6	10.465	1.744	-0.047	-2.6
Apr. 2	23.3	5	8.285	1.657	-0.087	-5.1
9	22.	5	8.475	1.695	0.038	2.2
16	22.	5	8.647	1.729	0.034	1.9
			Mean (average)	Loss	Per cent loss	
From						
Feb. 21 to Apr. 16			1.954	-0.451	-23.08	

SET D
Same as A. Starved

	No. of animals	Total weight	Average weight	Loss	Per cent
	6	10.225	1.704		
	6	8.95	1.492	-0.212	13.2
	6	7.825	1.304	-0.188	13.4
	3	3.49	1.16	-0.144	11.6
	3	3.105	1.035	-0.125	11.3
	3	2.905	0.968	-0.067	6.6
	3	2.797	0.932	-0.036	3.7
			Mean (average)	Loss	Per cent loss
From Mar. 5 to Apr. 16 ..		1.318	-0.772	58.5	

SET E
Same as B. Starved

	No. of animals	Total weight	Average weight	Loss	Per cent
	6	10.33	1.721		
	5	8.2	1.64	0.081	-4.8
	5	7.215	1.443	-0.197	-12.7
	5	6.64	1.328	-0.115	-8.3
	5	6.04	1.208	-0.120	-9.4
	5	5.745	1.149	-0.059	-5.
	5	5.66	1.13	-0.019	-1.6
			Mean (average)	Loss	Per cent loss
From Mar. 5 to Apr. 16 ..		1.425	-0.591	41.4	

TABLE XVI—Continued

SET C

At low temperature 11.2° C (average). Fed

	Av. temperature degrees C.	No. of animals	Total weight	Average weight	Increase	Per cent
Feb. 21		6	10.712	1.785		
Mar. 5	13.1	6	11.72	1.953	0.168	8.9
12	8.5	6	11.285	1.881	-0.072	-3.7
19	11.5	6	11.585	1.931	0.05	2.6
26	12.	5	9.87	1.974	0.043	2.2
Apr. 2	12.	5	9.625	1.925	-0.049	-2.
9	10.	5	10.435	2.087	0.162	8.
16	11.6	5	9.907	1.981	-0.106	-5.2
			Mean (average)	Increase	Per cent increase	
From Feb. 21 to Apr. 16			1.883	0.196	1.04	

SET F

Same as C. Starved

	No. of animals	Total weight	Average weight	Loss	Per cent
6	10.325	1.721			
3	5.16	1.72	0.001	0.05	
2	3.222	1.611	-0.109	6.5	
2	3.005	1.502	-0.109	7.	
2	2.94	1.47	-0.032	2.1	
2	2.93	1.46	-0.001	0.06	
2	2.865	1.432	-0.028	1.9	
			Mean (average)	Loss	Per cent loss
From Mar. 5 Apr. 16			1.576	-0.289	-18.3

TABLE XVII

SET A

Males. Showing normal rate of growth. Fed 315 mg. of beef per week

	No. of animals	Total weight	Average weight	Increase	Per cent inc.
Oct. 22	10	21.235	2.124		
28	10	21.978	2.198	0.074	3.4
Nov. 4	10	22.874	2.287	0.089	3.9
11	10	22.934	2.293	0.006	0.2
18	10	23.721	2.372	0.079	3.3
25	10	24.749	2.475	0.103	4.2
Dec. 2	10	25.085	2.509	0.034	1.3
9	10	26.366	2.637	0.128	4.9
16	10	27.397	2.740	0.103	3.8
23	10	28.378	2.838	0.098	3.5
31	10	28.645	2.865	0.027	0.9
			Mean (average)	Increase	Per cent increase
From					
Oct. 22 to Dec. 31			2.494	0.741	29.7

SET B

Females. Normal rate of growth. Fed as in Set A

	No. of animals	Total weight	Average weight	Increase	Per cent inc.
Oct. 22	10	17.214	1.721		
28	10	19.052	1.905	0.184	10.1
Nov. 4	10	19.148	1.915	0.01	0.5
11	10	19.402	1.94	0.025	1.2
18	10	20.343	2.034	0.094	4.7
25	10	21.806	2.18	0.146	6.9
Dec. 2	10	22.708	2.271	0.091	4.
9	10	23.575	2.358	0.087	3.7
16	10	24.394	2.44	0.082	3.4
23	10	25.815	2.582	0.142	5.6
31	10	26.387	2.639	0.057	2.1
			Mean (average)	Increase	Per cent. increase
From					
Oct. 22 to Dec. 31			2.18	0.918	42.1

TABLE XVIII

Males. Individuals showing normal rate of growth.

No. 1

No. 2

	No. of animals	Mg. of beef	Weight	Increase	Per cent inc.
Oct. 22	1	315 (average)	2.627		
28	1		2.672	0.045	1.6
Nov. 4	1		2.687	0.015	0.5
11	1		2.720	0.033	1.2
18	1		2.910	0.19	6.7
25	1	3.255	0.345	11.1	
Dec. 2	1	3.04	-0.215	-6.8	
9	1	3.163	0.123	3.9	
16	1	3.446	0.283	8.5	
23	1	3.439	-0.007	-0.2	
31	1	3.483	0.044	1.2	

	No. of animals	Mg. of beef	Weight	Increase	Per cent inc.
	1	315 (average)	2.787		
	1		2.755	-0.032	-1.1
	1		2.855	0.1	3.5
	1		2.795	-0.06	-2.1
	1		2.92	0.125	4.3
	1	3.095	0.175	5.4	
	1	3.098	0.003	0.09	
	1	2.98	3.227	0.129	4.
	1	308	3.468	0.241	7.2
	1	329	3.365	-0.103	-3.
	1	326	3.412	0.047	1.3

	Mean (average)	Increase	Per cent increase
From Oct. 22 to Dec. 31	3.055	0.856	28.01
Dec. 2 to Dec. 31	3.261	0.443	13.5

	Mean (average)	Increase	Per cent increase
From Oct. 22 to Dec. 31	3.099	0.625	20.1
Dec. 2 to Dec. 31	3.255	0.314	9.6

No. 3

No. 4

	No. of animals	Mg. of beef	Weight	Increase	Per cent inc.
Oct. 22	1	315 (average)	1.577		
28	1		1.587	0.01	0.6
Nov. 4	1		1.659	0.072	4.4
11	1		1.744	0.085	4.9
18	1		1.799	0.055	3.1
25	1	1.997	0.198	10.4	
Dec. 2	1	1.948	-0.049	-2.4	
9	1	2.09	0.142	7.	
16	1	3.25	2.197	0.107	4.9
23	1	318	2.335	0.138	6.
31	1	329	2.339	0.004	0.1

	No. of animals	Mg. of beef	Weight	Increase	Per cent inc.
	1	315 (average)	2.509		
	1		2.472	-0.037	-1.4
	1		2.539	0.067	2.6
	1		2.537	-0.002	-0.07
	1		2.592	0.055	2.1
	1	315	2.73	0.138	5.1
	1	315	2.81	0.08	2.8
	1	303	3.044	0.234	7.9
	1	324	2.998	-0.046	-1.5
	1	325	3.126	0.128	4.1
	1	322	3.287	0.161	5.

	Mean (average)	Increase	Per cent increase
From Oct. 22 to Dec. 31	1.958	0.762	38.9
Dec. 2 to Dec. 31	2.143	0.391	18.2

	Mean (average)	Increase	Per cent increase
From Oct. 22 to Dec. 31	2.898	0.778	26.8
Dec. 2 to Dec. 31	3.048	0.477	15.6

TABLE XVIII—Continued

No. 5

	No. of animals	Mg. of beef	Weight	Increase	Per cent inc.
Oct. 22	1		1.885		
28	1	315	1.927	0.042	2.2
Nov 4	1	315	1.959	0.032	1.6
11	1	315	2.035	0.076	3.8
18	1	315	2.052	0.017	0.8
25	1	315	2.112	0.06	2.8
Dec. 2	1	315	2.222	0.11	5.
9	1	286	2.301	0.079	3.4
16	1	322	2.438	0.137	5.7
23	1	315	2.47	0.032	1.3
31	1	323	2.52	0.05	2.
		(average)	Mean (average)	Increase	Per cent increase
From Oct. 22 to Dec. 31			2.202	0.635	28.8
Dec. 2 to Dec. 31			2.371	0.298	12.5

TABLE XIX
Females Individuals showing normal rate of growth.
No. 1 No. 2

No. 1					No. 2						
	No of animals	Mfg. of beef	Weight	Increase	Per cent inc.		No. of animals	Mfg. of beef	Weight	Increase	Per cent inc.
Oct	22	I	1.927			I		1.237			
	28	I	315	2.142	0.215	10.5	I	315	1.517	0.280	20.3
Nov.	4	I	315	2.122	-0.020	-0.9	I	315	1.487	-0.03	-1.9
	11	I	315	2.117	-0.005	-0.2	I	315	1.497	0.01	0.6
	18	I	315	2.194	0.077	3.5	I	315	1.637	0.14	8.9
	25	I	315	2.452	0.258	11.1	I	315	1.844	0.207	11.8
Dec.	2	I	315	2.447	-0.005	-0.2	I	315	1.92	0.076	4.
	9	I	307	2.649	0.202	7.9	I	318	2.173	0.253	12.3
	16	I	311	2.573	-0.076	-2.9	I	300	2.09	-0.083	3.8
	23	I	328	2.691	0.118	4.4	I	330	2.288	0.198	9.
	31	I	325	2.762	0.071	2.6	I	324	2.424	0.136	5.7
			Mean (average)	Increase	Per cent increase				Mean (average)	Increase	Per cent increase
From						From					
Oct. 22 to Dec. 31			2.344	0.835	35.6	Oct. 22 to Dec. 31			1.83	1.187	64.8
Dec. 2 to Dec. 31			2.604	0.315	12.09	Dec. 2 to Dec. 31			2.172	0.504	23.2

No. 3					No. 4						
	No of animals	Mfg. of beef	Weight	Increase	Per cent inc.		No. of animals	Mfg. of beef	Weight	Increase	Per cent inc.
Oct	22	I	2.222			I		1.387			
	28	I	315	2.432	0.21	9.	I	315	1.462	0.075	5.2
Nov.	4	I	315	2.357	-0.075	-3.1	I	315	1.689	0.227	14.4
	11	I	315	2.284	-0.073	-3.1	I	315	1.807	0.118	6.7
	18	I	315	2.367	0.083	3.5	I	315	1.797	-0.01	-0.5
	25	I	315	2.382	0.015	0.6	I	315	1.952	0.155	8.2
Dec.	2	I	315	2.515	0.133	5.8	I	315	1.987	0.035	1.7
	9	I	317	2.698	0.183	7.	I	314	2.186	0.199	9.5
	16	I	311	2.637	-0.061	-2.2	I	321	2.217	0.031	1.4
	23	I	327	2.696	0.059	2.2	I	332	2.339	0.122	5.3
	31	I	322	2.793	0.097	3.5	I	323	2.418	0.079	3.3
			Mean (average)	Increase	Per cent increase				Mean (average)	Increase	Per cent increase
From						From					
Oct. 22 to Dec. 31			2.507	0.571	22.7	Oct. 22 to Dec. 31			1.902	1.031	54.2
Dec. 2 to Dec. 31			2.654	0.278	10.4	Dec. 2 to Dec. 31			2.202	0.431	19.5

Ada Springer

TABLE XIX—Continued

No. 5

	No. of animals	Mg. of beef	Weight	Increase	Per cent inc.
Oct. 22	1		1.447		
28	1	315	1.542	0.095	6.3
Nov. 4	1	315	1.552	0.01	0.6
11	1	315	1.507	-0.045	-2.9
18	1	315	1.567	0.06	3.9
25	1	315	1.724	0.157	9.5
Dec. 2	1	315	1.68	-0.044	-2.5
9	1	301	1.943	0.263	14.5
16	1	312	1.999	0.056	2.8
23	1	321	2.051	0.052	2.5
31	1	320	2.065	0.014	6.8
			Mean (average)	Increase	Per cent increase
From Oct. 22 to Dec. 31			1.756	0.618	35.1
Dec. 2 to Dec. 31			1.872	0.385	20.5

TABLE XX

SET C

Normal growth. Fed 315 mg. of beef per week

	No. of animals	Total weight	Average weight	Increase	Per cent inc.
Nov. 11	7	6.371	0.910		
18	7	7.021	1.003	0.093	9.7
25	7	7.929	1.133	0.13	12.1
Dec. 2	7	7.945	1.135	0.002	0.1
9	7	8.534	1.219	0.084	7.1
16	7	8.821	1.26	0.041	3.3
23	6	8.92	1.486	0.226	16.4
			Mean (average)	Increase	Per cent increase
From Nov. 11 to Dec. 23			1.198	0.576	48.08

A Study of Growth

TABLE XXI
SET D
Growth at low temperature (10° C. average). Fed as much as animals would eat

	No. of animals	Temperature degrees C.	Total weight	Average weight	Increase	Per cent inc.
Oct. 22	10		17.22	1.722		
28	10	10	20.731	2.073	0.351	18.5
Nov. 4	10	12	21.676	2.168	0.095	4.4
11	10	13	21.766	2.177	0.009	0.4
18	10	11	21.746	2.175	-0.002	-0.09
25	10	10	22.531	2.253	-0.078	3.1
Dec. 2	10	10	21.763	2.176	-0.077	-3.4
9	10	9	22.45	2.245	0.069	3.1
16	10	12	22.041	2.204	-0.041	-1.8
23	10	11	23.061	2.306	0.102	4.5
31	10	12	22.104	2.21	-0.096	-4.2
			Mean (average)	Increase	Per cent increase	
From Oct. 22 to Dec. 31			1.966	0.488	24.8	

No. 1 (Male)

No. 2 (Male)

	No. of animals	Mg. of beef (average)	Weight	Increase	Per cent inc.	No. of animals	Mg. of beef (average)	Weight	Increase	Per cent inc.	
Oct. 22	1		1.374			1		1.947			
28	1	315	1.734	0.36	23.1	1	315	2.202	0.255	12.2	
Nov. 4	1	315	1.874	0.14	7.7	1	315	2.192	-0.01	-0.4	
11	1	110	1.827	-0.047	-2.5	1	315	2.302	0.11	4.8	
18	1	105	1.747	-0.08	-4.4	1	110	2.457	0.155	6.5	
25	1	0	1.797	0.05	2.8	1	105	2.532	0.075	3.	
Dec. 2	1	105	1.67	-0.127	-7.3	1	105	2.406	-0.126	-5.1	
9	1	0	1.697	0.027	1.6	105	105	2.436	0.03	1.2	
16	1	0	1.605	-0.092	5.5	1	0	2.284	-0.152	-6.4	
23	1	110	1.8	0.195	11.4	1	105	2.422	0.138	5.8	
31	1	105	1.688	-0.112	6.4	1	105	2.415	-0.007	-0.2	
			Mean (average)	Increase	Per cent increase				Mean (average)	Increase	Per cent increase
From Oct. 22 to Dec. 31			1.531	0.314	20.5	From Oct. 22 to Dec. 31			2.181	0.468	21.4

TABLE XXI—Continued

No. 3 (Male)

	No. of animals	Mg. of beef (average)	Weight	Increase	Per cent inc.
Oct. 22	1		2.232		
28	1	315	2.607	0.375	15.
Nov. 4	1	315	2.89	0.183	6.6
11	1	315	2.637	-0.253	-9.1
18	1	105	2.607	-0.03	-1.1
25	1	0	2.567	-0.040	-1.5
Dec. 2	1	0	2.515	-0.042	-1.6
9	1	105	2.538	0.023	0.9
16	1	0	2.493	-0.045	-1.7
23	1	110	2.613	0.12	4.7
31	1	0	2.43	-0.183	-7.2
			Mean (average)	Increase	Per cent increase
From Oct. 22 to Dec. 31			2.331	0.198	8.4

TABLE XXII

SET D¹

Growth at room temperature (20° C. average). Fed same as Set D

	No. of animals	Temperature degrees C.	Total weight	Average weight	Increase	Per cent inc.
Oct. 22	10	20	16.924	1.692		
28	10	20	18.534	1.853	0.161	9.
Nov. 4	10	20	18.987	1.899	0.046	2.4
11	10	19	18.492	1.849	-0.05	-2.6
18	9	20	17.289	1.921	0.072	3.8
25	9	20	17.429	1.937	0.016	0.8
Dec. 2	9	21	17.09	1.899	-0.038	-1.9
9	9	20	16.696	1.855	-0.044	-2.3
16	9	20	17.207	1.912	0.057	3.
23	9	20	17.757	1.973	0.061	3.1
31	9	20	17.268	1.919	-0.054	-2.7
			Mean (average)	Increase	Per cent increase	
From Oct. 22 to Dec. 31			1.805	0.226	12.5	

No. 2 (Male)

No. 3 (Female)

	No. of animals	Mg. of beef (average)	Weight	Increase	Per cent inc.	No. of animals	Mg. of beef (average)	Weight	Increase	Per cent inc.
Oct. 22	1		1.297			1		2.007		
28	1	315	1.592	0.295	20.4	1	315	2.134	0.127	6.1
Nov. 4	1	315	1.679	0.087	5.3	1	315	2.162	0.028	1.3
11	1	315	1.697	0.018	1.	1	315	2.107	-0.055	-2.5
18	1	315	1.777	0.08	4.6	1	105	2.092	-0.015	-0.7
25	1	105	1.864	0.087	4.7	1	105	1.982	-0.110	-5.4
Dec. 2	1	105	1.82	-0.044	-2.3	1	0	1.916	-0.066	-3.3
9	1	105	1.947	0.127	6.7	1	0	1.822	-0.094	-5.
16	1	0	1.823	-0.124	-6.5	1	0	1.737	-0.085	-4.7
23	1	110	1.944	0.121	6.4	1	110	1.777	0.04	2.2
31	1	105	1.892	-0.052	-2.7	1	0	1.7	-0.077	-4.4
			Mean (average)	Increase	Per cent increase			Mean (average)	Loss	Per cent loss
From Oct. 22 to Dec. 31			1.594	0.595	37.3	From Oct. 22 to Dec. 31		1.853	0.307	16.5

TABLE XXIII

SET D²

Growth at high temperature (30° C. average). Fed same as Set D.

	No. of animals	Temperature degrees C.	Total weight	Average weight	Increase	Per cent inc.
Oct. 22	10		15.849	1.585		
28	10	35	15.714	1.571	-0.014	-0.8
Nov. 4	10	29	15.477	1.548	-0.023	-1.4
11	10	28	15.537	1.554	0.006	0.3
18	10	28	15.287	1.529	-0.025	-1.6
25	10	29	15.245	1.525	-0.004	-0.2
Dec. 2	9	26	12.982	1.442	-0.083	-5.5
9	9	28	13.427	1.492	0.05	3.4
16	9	29	13.078	1.453	-0.039	-2.6
23	9	31	12.78	1.420	-0.033	-2.2
31	9	32	12.338	1.371	-0.049	-3.5
			Mean (average)	Loss	Per cent loss	
From Oct. 22 to Dec. 31			1.478	0.214	14.4	

No. 1 (Male)

No. 2 (Female)

	No. of animals	Mg. of beef (average)	Weight	Increase	Per cent inc.	No. of animals	Mg. of beef (average)	Weight	Increase	Per cent inc.
Oct. 22	1		1.037			1		1.389		
28	1	315	1.047	0.01	0.9	1	315	1.484	0.095	6.6
Nov. 4	1	315	1.014	-0.033	-3.2	1	315	1.432	-0.052	-3.5
11	1	110	1.044	0.03	2.9	1	315	1.462	0.03	2.
18	1	105	1.012	-0.032	-3.1	1	105	1.547	0.085	5.6
25	1	0	0.967	-0.045	-4.5	1	105	1.637	0.09	5.6
Dec. 2	1	105	0.947	-0.02	-2.	1	105	1.548	-0.089	-5.5
9	1	0	0.962	0.015	1.5	1	105	1.589	0.041	2.6
16	1	0	0.88	-0.082	-8.9	1	0			
23	1	110	0.918	0.038	4.2	1	105	1.479	-0.110	-7.1
31	1	105	0.915	-0.003	-0.3	1	105	1.423	-0.056	-3.8
			Mean (average)	Loss	Per cent loss			Mean (average)	Increase	Per cent increase
From Oct. 22 to Dec. 31			0.976	0.122	12.5	From Oct. 22 to Dec. 13		1.406	0.034	2.4

TABLE XXIII—Continued
No. 3 (Male)

	No. of animals	Mg. of beef (average)	Weight	Increase	Per cent inc.
Oct. 22	1		1.677		
28	1	315	1.637	-0.04	-2.4
Nov. 4	1	315	1.517	-0.12	-7.6
11	1	315	1.537	0.02	1.3
18	1	110	1.524	-0.013	-0.8
25	1	0	1.442	-0.082	-5.5
Dec. 2	1	0	1.387	-0.055	-3.8
9	1	0	1.408	0.021	1.5
16	1	0	1.425	0.007	0.4
23	1	110	1.419	-0.006	-0.4
31	1	0	1.304	-0.115	8.4
			Mean (average)	Loss	Per cent loss
From Oct. 22 to Dec. 31			1.49	0.373	25.

TABLE XXIV

SET E¹*Growth at 20° C. (average). Fed as much as animals would eat*

	No. of animals	Temperature degrees C.	Total weight	Average weight	Increase	Per cent inc.
Oct. 22	10		17.377	1.738		
28	10	20	22.126	2.213	0.475	24.
Nov. 4	10	20	21.756	2.176	-0.037	-1.6
11	10	20	22.356	2.236	0.06	2.7
18	10	19	23.899	2.39	0.154	6.6
25	10	20	25.364	2.536	0.146	5.9
Dec. 2	10	20	25.89	2.589	0.053	2.
9	10	21	26.637	2.664	0.075	2.8
16	10	20	27.377	2.738	0.074	2.7
23	10	20	28.04	2.804	0.066	2.3
31	9	20	26.05	2.89	0.086	3.
			Mean (average)	Increase	Per cent increase	
From Oct. 23 to Dec. 31			2.314	1.152	49.7	

No. 1 (Male)

No. 2 (Male)

	No. of animals	Mg. of beef (average)	Weight	Increase	Per cent inc.	No. of animals	Mg. of beef (average)	Weight	Increase	Per cent inc.
Oct. 22	1		2.307			1		1.527		
28	1	630	2.407	0.1	4.2	1	630	1.854	0.327	19.3
Nov. 4	1	630	2.442	0.035	1.4	1	630	2.017	0.163	8.4
11	1	525	2.494	0.052	2.1	1	525	2.047	0.03	1.4
18	1	525	2.627	0.133	5.1	1	525	2.257	0.21	9.7
25	1	525	2.855	0.228	8.3	1	420	2.424	0.167	7.1
Dec. 2	1	420	2.911	0.056	1.9	1	420	2.476	0.052	2.1
9	1	525	3.003	0.092	3.1	1	420	2.53	0.054	2.1
16	1	315	3.033	0.03	0.9	1	110	2.649	0.119	4.5
23	1	315	3.108	0.075	2.4	1	315	2.58	-0.069	-2.6
31	1	315	3.157	0.049	1.5	1	315	2.628	0.048	1.8
			Mean (average)	Increase	Per cent increase			Mean (average)	Increase	Per cent increase
From Oct. 22 to Dec. 31			2.732	0.850	31.1	From Oct. 22-Dec. 31		2.077	1.101	53.05

TABLE XXIV—Continued
No. 3 (Male)

	No. of animals	Mg. of beef (average)	Weight	Increase	Per cent inc.
Oct. 22	1		1.507		
28	1	630	2.242	0.735	39.2
Nov. 4	1	630	2.307	0.065	2.8
11	1	525	2.192	-0.115	-5.1
18	1	525	2.297	0.105	4.6
25	1	525	2.687	0.39	15.6
Dec. 2	1	420	2.510	-0.177	-6.8
9	1	315	2.522	0.012	0.4
16	1	105	2.635	0.113	4.3
23	1	315	2.437	-0.198	-7.8
31	1		(died)		
			Mean (average)	Increase	Per cent increase
From Oct. 22—Dec. 31			1.972	0.930	47.1

TABLE XXV
SET E²
Growth at 30° C. (average). Fed as in E¹

	No. of animals	Temperature degrees C.	Total weight	Average weight	Increase	Per cent inc.
Oct. 22	10		16.899	1.69		
28	10	35	17.15	1.715	0.025	1.4
Nov. 4	10	29	17.661	1.766	0.051	2.
11	10	28	18.227	1.823	0.057	3.1
18	9	28	18.669	2.074	0.251	12.8
25	9	29	19.967	2.218	0.144	6.7
Dec. 2	9	26	20.002	2.222	0.004	0.1
9	8	28	18.864	2.358	0.136	5.9
16	8	29	19.406	2.426	0.068	2.8
23	8	31	19.49	2.436	0.01	0.4
31	8	32	18.120	2.265	-0.171	7.2
			Mean (average)	Increase	Per cent increase	
From Oct. 22 to Dec. 21			1.977	0.575	29.07	

No. 1 (Male)

No. 2 (Male)

	No. of animals	Mg. of beef (average)	Weight	Increase	Per cent inc.	No. of animals	Mg. of beef (average)	Weight	Increase	Per cent inc.
Oct. 22	1		2.805			1		1.539		
28	1	420	2.627	-0.178	-6.5	1	420	1.582	0.043	2.7
Nov. 4	1	840	2.577	-0.05	-1.9	1	840	1.582	0.000	
11	1	525	2.687	0.110	4.1	1	525	1.677	0.095	5.8
18	1	630	2.93	0.243	8.6	1	630	1.862	0.185	10.4
25	1	525	3.085	0.155	5.1	1	315	1.887	0.025	1.3
Dec. 2	1	420	3.003	-0.082	-2.6	1	420	2.05	0.163	8.2
9	1	525	3.245	0.242	7.7	1	420	2.07	0.02	0.9
16	1	315	3.327	0.082	2.4	1	315	1.977	-0.093	4.5
23	1	315	3.288	-0.039	-1.1	1	315	1.97	-0.007	0.3
31	1	315	3.116	-0.172	5.3	1	315	1.937	-0.033	1.6
		Mean (average)	Increase	Per cent increase			Mean (average)	Increase	Per cent increase	
From Oct. 22 to Dec. 31		2.96	0.311	10.5		From Oct. 27-Dec. 31	1.738	0.398	22.8	

TABLE XXV—Continued
No. 3 (Female)

	No. of animals	Mg. of beef (average)	Weight	Increase	Per cent inc.
Oct. 22	1		1.172		
28	1	420	1.322	0.150	12.
Nov. 4	1	840	1.412	0.090	6.5
11	1	525	1.507	0.095	6.5
18	1	630	1.724	0.217	13.4
25	1	315	1.987	0.263	14.1
Dec. 2	1	420	2.062	0.075	3.7
9	1	315	2.210	0.148	6.9
16	1	110	2.153	-0.057	-2.6
23	1	110	2.140	-0.013	-0.6
31	1	315	2.116	-0.024	-1.1
			Mean (average)	Increase	Per cent increase
From Oct. 22 to Dec. 31			1.644	0.944	57.4

TABLE XXVI

SET F

Growth at 30° C (average). Fed as much as animals would eat.

	No. of animals	Temperature degrees C.	Total weight	Average weight	Increase	Per cent inc.
Oct. 22	10		16.606	1.661		
28	10	35	17.449	1.745	0.084	4.9
Nov. 4	10	29	18.324	1.832	0.087	4.8
11	9	28	17.679	1.964	0.132	6.9
18	8	28	16.564	2.071	0.107	5.3
25	8	29	17.092	2.137	0.066	3.1
Dec. 2	8	26	17.919	2.239	0.102	4.6
9	8	28	18.751	2.344	0.105	4.5
16	7	29	16.265	2.323	-0.021	-0.9
23	7	31	15.766	2.252	-0.071	-3.1
31	7	32	14.962	2.137	-0.115	-5.2
			Mean (average)	Increase	Per cent increase	
From Oct. 22 to Dec. 31			1.899	0.476	25.06	

No. 1

No. 2

	No. of animals	Mg. of beef (average)	Weight	Increase	Per cent inc.		No. of animals	Mg. of beef (average)	Weight	Increase	Per cent inc.
Oct. 22	1		1.107				1		1.632		
28	1	420	1.417	0.310	24.5		1	420	1.627	-0.005	-0.3
Nov. 4	1	525	1.389	-0.028	-1.9		1	525	1.747	0.120	7.1
11	1	525	1.512	0.123	8.4		1	420	2.612	0.865	39.6
18	1	315	1.677	0.165	10.3		1	420	2.735	0.123	4.6
25	1	525	1.787	0.110	6.3		1	525	2.855	0.120	4.2
Dec. 2	1	420	1.912	0.125	6.7		1	420	2.872	0.017	0.5
9	1	525	2.002	0.090	4.5		1	420	2.992	0.120	4.
16	1	315	2.069	0.067	3.2		1	315	2.945	-0.047	-1.5
23	1	315	2.033	-0.036	-1.7		1	315	2.854	-0.091	-3.1
31	1	315	1.978	-0.055	-2.7		1	315	2.674	-0.180	-6.5
			Mean (average)	Increase	Per cent increase				Mean (average)	Increase	Per cent increase
From Oct. 22 to Dec. 31			1.542	0.871	56.4		From Oct. 22 to Dec. 31		2.153	1.042	48.3

STUDIES ON CHROMOSOMES

IV THE "ACCESSORY" CHROMOSOME IN SYROMASTES AND PYRROCHORIS WITH A COMPARATIVE REVIEW OF THE TYPES OF SEXUAL DIFFERENCES OF THE CHROMOSOME GROUPS¹

BY

EDMUND B. WILSON

WITH TWO PLATES AND TWO FIGURES IN THE TEXT

Since the unpaired idiochromosome ("accessory chromosome") was first discovered by Henking ('91) in *Pyrrochoris apterus* L. this species has been reëxamined by only one observer, Dr. J. Gross ('07), with results that are in substantial agreement with those that he had reached in an earlier investigation ('04) on the coreid species *Syromastes marginatus* L. In both cases his conclusions here in conflict with the view advanced by McClung ('02), and first

¹ *Terminology.* With the advance of our knowledge of the chromosomes that form the distinctive differential between the chromosome groups of the two sexes, and between the male producing and the female producing spermatozoa, it becomes increasingly difficult to find a common name that will apply equally to their various modifications. Terms such as the "accessory," "odd" or "heterotropic" chromosome, or "monosome," that are based on the condition of these chromosomes in the male only, are misleading or inappropriate; and some of them are in certain cases inapplicable, even in the male—e. g., in *Syromastes*, where the "accessory" chromosome is not univalent but bivalent. Such terms as "heterochromosome" or "allosome" (Montgomery) seem to me unsatisfactory, since they designate the *m*-chromosomes as well as the differential chromosomes, though these are obviously of quite different nature. Since it has now become evident that a univalent "accessory" chromosome in the male is exactly equivalent to what I have called the "large idiochromosome" in other forms, I think these chromosomes should be designated by the same name, and one that will apply equally to both sexes. While there are some objections to the word "idiochromosome" as a general term for this purpose I am not able to suggest a better one; and since it has already been thus employed by some writers, I shall use it hereafter in a broader sense than that in which I first proposed it, to designate the differential chromosomes in general, whether they are paired or unpaired in the male, and whether one or more pairs are present. A univalent or odd idiochromosome in the male will be called the unpaired idiochromosome (or simply the idiochromosome), while the word "heterotropic" may perhaps conveniently be used as descriptive of its passage without division to one pole in one of the maturation divisions. In *Syromastes*, as will appear, the "accessory" or heterotropic chromosome represents a pair of idiochromosomes; while in *Galgulus* there are several pairs of these chromosomes.

shown to be correct in principle by the work of Stevens and myself, that half the spermatozoa are male producing and half female producing. This view rests on the following facts. When the male somatic chromosome groups contain an odd number, including an odd or unpaired idiochromosome (as in *Anasa*, *Alydus*, or *Protenor*) the female groups have one more chromosome, being duplicates of the male groups with the addition of another chromosome like the unpaired one of the male. When the male groups contain an even number, including a large and a small idiochromosome (as in *Lygæus*, *Cænus* or *Tenebrio*) the female groups contain the same number, but include two large idiochromosomes in place of a large and a small one. In the first type half the spermatozoa receive the odd idiochromosome while half do not, the former accordingly containing one chromosome more than the latter. In the second type all the spermatozoa receive the same number of chromosomes, but half receive the large idiochromosome and half the small. It follows from these relations that eggs fertilized by spermatozoa containing the odd chromosome, or its homologue the large idiochromosome, must produce females, those fertilized by the other spermatozoa males. These cytological results, first reached by Stevens ('05) in *Tenebrio* (which has a pair of unequal idiochromosomes in the male) and myself ('05b, '05c, '06) in *Anasa*, *Protenor*, *Alydus* and *Harmostes* (which have an unpaired idiochromosome in the male) and in *Lygæus*, *Cænus*, *Podisus* and *Euschistus* (which agree essentially with *Tenebrio*), have since been confirmed in a considerable number of species and extended to several other orders of insects.² They have recently received indirectly a striking experimental confirmation in the important work of Correns ('07), which proves that in the dioecious flowering plant, *Bryonia dioica*, the pollen grains are likewise male determining and female determining in equal numbers.

Gross's conclusion in the case of *Syromastes* and *Pyrrochoris* is opposed to all these results in that only one of the two forms of spermatozoa is supposed to be functional (those containing the

² See the tabular review in the sequel.

“accessory” chromosome) the others being regarded as in a certain sense comparable to polar bodies (as was also supposed by Wallace ('05).³ This result was based mainly on the numerical relations, and especially on the belief that in both these forms the number of chromosomes is an even one and the same in both sexes—twenty-two in *Syromastes*, twenty-four in *Pyrrochoris*. Since the complete reduced number (eleven and twelve in the two respective cases) is present only in those spermatozoa that contain the “accessory” chromosome, Gross argues that this class alone can be concerned in fertilization, as follows:

Syromastes . . . Egg 11 + spermatozoön 11 = 22 (♂ or ♀)
Pyrrochoris . . . Egg 12 + spermatozoön 12 = 24 (♂ or ♀)

whereas in *Anasa* or *Protenor* the relations are:

Anasa Egg 11 + spermatozoön 10 = 21 (♂)
 Egg 11 + spermatozoön 11 = 22 (♀)
Protenor Egg 7 + spermatozoön 6 = 13 (♂)
 Egg 7 + spermatozoön 7 = 14 (♀)

In the hope of clearing up this perplexing contradiction I endeavored to procure material for a reëxamination of the two forms in question, and through the great kindness of Professor Boveri, to whom my best thanks are due, was fortunate enough to obtain an abundant supply of both, though unluckily it includes no female material.⁴ As far as the relations can be worked out on the male alone they give, I believe, the solution of the puzzle and bring the two species in question into line with the general principle that has been established for other forms. This is evidently true of *Pyrrochoris*. *Syromastes*, however, constitutes a new

³ At first thought this seems to be in harmony with the remarkable discovery of Meves ('03, '07) that in the male honey bee actual polar bodies are formed which produce abortive spermatids. But obviously the two cases are not parallel, for in the bee the fertilized eggs produce only females; and this finds a natural explanation, in accordance with the general conclusions of McClung, Stevens and myself, in the assumption that it is the male producing class that degenerate as polar bodies.

⁴ The material, fixed in Flemming's fluid and in Bouin's micro-acetic-formol mixture, is of excellent quality and gave preparations of perfect clearness. The Flemming material is on the whole the best. For single stains Zwaardemaker's safranin and iron hæmatoxylin were employed (the latter especially for photographs). Various double stains were also used. One of the best, which I can strongly recommend to other workers in this field, is the combination of safranin and lichtgrün, which gives preparations of admirable clearness and is also easy to use and certain in its results.

type that is not yet known to be exactly paralleled in other forms; though, as will appear, the genus *Galgulus* presents a somewhat analogous case. It does not seem to have occurred to Dr. Gross (as it did not to me until I had carefully studied both forms) that *Syromastes* and *Pyrochoris* might be of different type, but such is evidently the case. I shall endeavor to show that *Pyrochoris* is of quite orthodox type, having an odd somatic number in the male and a typical unpaired idiochromosome. Since I am compelled to differ with Dr. Gross in regard to this species, I am glad to admit that the doubts I formerly expressed as to his account of the spermatogonial number in *Syromastes*, were unfounded. In regard to the female number, on the other hand, I believe he was misled by a wrong theoretic expectation (as he evidently was in case of the male *Pyrochoris*), though it is possible that his determination of the *apparent* number was also correct, as indicated beyond.

SYROMASTES MARGINATUS L.

Gross's account of this form was as follows: The somatic groups in both sexes are stated to show twenty-two chromosomes. The "accessory" chromosome arises by the synapsis of two spermatogonial chromosomes, and is therefore a bivalent. It divides equationally in the first spermatocyte division but fails to divide in the second, passing bodily to one pole in advance of the other chromosomes without even entering the equatorial plate. All of the spermatid-nuclei thus receive ten chromosomes and half of them in addition the "accessory." These are the essential conclusions; but they are complicated by the following singular view of the relations between the "accessory" and the microchromosomes or "*m*-chromosomes." The chromosome nucleolus of the growth period is supposed not to give rise (as it does in *Pyrochoris* and other forms) to the heterotropic or "accessory" chromosome of the spermatocyte divisions, but to the *m*-chromosome bivalent—the same view as the earlier one of Paulmier ('99) which has since been shown to be erroneous (Wilson '05c). But, on the other hand it is believed to arise, not from the

m-chromosomes of the spermatogonia, but from two larger chromosomes, while the spermatogonial *m*-chromosomes are supposed to be converted into the "accessory" (!). I will not enter upon the very ingenious, if somewhat fantastic, conclusions that are based on these results, for, as I shall attempt to show, the results themselves cannot be sustained in some important particulars. But apart from this I am glad to be able to give the most positive confirmation of Gross's interesting discovery in regard to the numerical relations in the male. *Syromastes* is indeed a case in which the spermatogonial number is an even one (twenty-two), while there is a heterotropic chromosome in the second division. Half the spermatozoa seem to receive ten chromosomes and half eleven, as in so many other species of Coreidæ. But as Gross also correctly described, the heterotropic chromosome is here a bivalent which represents two chromosomes united together. The true numbers characteristic of the two classes of spermatozoa are therefore ten and twelve, respectively. For the sake of clearness I will here point out that this becomes at once intelligible under the assumption that the female number is not twenty-two, as Gross believed, but twenty-four; and such I believe will be found to be the fact.

That Gross was mistaken—doubtless misled by the earlier conclusion of Paulmier ('99), in which he was at first followed by Montgomery ('01)—in supposing that the chromosome nucleolus of the growth period divides to form the *m*-chromosomes, is I think thoroughly demonstrated by my preparations. In the case of *Anasa* and *Alydus* I showed ('05c) that the *m*-chromosomes are not formed in the way Paulmier believed, but arise from two small separate rod-like chromosomes that are in a diffused condition during the growth period and only condense to form compact bodies at the same time that the condensation of the larger chromosomes takes place. I have since found this to be true of many other species. It is confirmed in the case of *Anasa* by the smear preparations of Foot and Strobell ('07), and I have also since fully established the same conclusion by this method, by means of which every chromosome in the nucleus may be demonstrated.⁵

⁵ This is opposed to the conclusion of Montgomery ('06).

Although I have no smear preparations of *Syromastes* it is perfectly clear from the sections that the facts are the same here as in *Anasa Alydus*, and other forms. In the early prophases of the first division (at a period corresponding to Gross's Figs. 31 to 37) when the plasmosome has disappeared or is greatly reduced in size, the nuclei contain both the chromosome-nucleolus and the *m*-chromosomes. This is shown in great numbers of cells with unmistakable clearness and after various methods of staining, particularly after safranin alone or combined with lichtgrün. In the early part of this period the chromosome nucleolus is at once recognizable by its intense color and sharp contour and is not for a moment to be confused with a plasmosome. The ordinary bivalents are still in the form of ragged pale bodies, having the form of longitudinally split rods or double crosses. The *m*-chromosomes have the same texture and staining reaction, but are much smaller and never show the cross form. While it is difficult to show the facts to demonstration in photographs of sections they may be fairly well seen in the following. Photo 18 shows the chromosome nucleolus (not quite in focus,) one of the large bivalents (two others barely appear) and both *m*-chromosomes. Photo 19 is a similar view (the *m*-chromosomes more condensed), while Photo 20 shows the *m*-chromosomes and three of the ordinary bivalents. The succeeding changes must be rapidly passed through, since the successive steps are often seen in the same cyst, passing from one side to the other. In these stages the large bivalents rapidly condense and regain their staining capacity, finally assuming a bipartite or quadripartite form. The *m*-chromosomes undergo a similar condensation, being finally reduced to ovoidal or spheroidal bodies. The chromosome nucleolus, on the other hand, becomes somewhat looser in texture and assumes an asymmetrical quadripartite shape, in which form it enters the equatorial plate to form the eccentric "accessory" chromosome. The period at which the *m*-chromosomes condense varies considerably, and the same is true of their relative position; sometimes they are in contact, sometimes more or less widely separated, even lying on opposite sides of the nucleus. Photo 21 shows two nuclei, one above the other, in each of which appear both *m*-chromosomes,

the chromosome nucleolus and a number of the other bivalents. Photo 22 shows the same condition. Photo 23, from the same cyst, is slightly later, showing the two spheroidal *m*-chromosomes wide apart, the chromosome nucleolus, and several of the other chromosomes. (The chromosome nucleolus, perfectly recognizable in the preparation, is in the photograph hardly distinguishable from the other bivalents seen endwise.) Up to this point, which shortly precedes the dissolution of the nuclear membrane, the chromosome nucleolus is still immediately recognizable by its deeper color (especially after safranin). There follows a brief period in which this distinction disappears, but the chromosome nucleolus is still recognizable by its asymmetrical form. That it gives rise to the eccentric "accessory" is, I think, beyond doubt. The evidence is demonstrative that it does not divide to form the *m*-chromosomes, and that the latter arise from separate rods as described. Gross appears to have seen these rods at a much earlier period (cf. his Fig. 10) and correctly identifies them with the spermatogonial *m*-chromosomes; but he believed them to give rise to the "accessory."

The relation of the chromosome nucleolus to the spermatogonial chromosomes cannot be determined in *Syromastes* with the same degree of certainty as in *Pyrrhochoris* (as described beyond), but the size relations leave hardly a doubt that Gross was right in asserting its origin from two of the larger of these chromosomes. The study of these relations is of importance because I believe they justify the conclusion that the chromosome nucleolus, and hence the "accessory," is nothing other than a pair of slightly unequal idiochromosomes, which can readily be recognized in the spermatogonial groups.

Study of the spermatogonial groups in detail shows that twenty of the chromosomes may be equally paired, while the remaining two are slightly but distinctly unequal in size. These can always be recognized as the smallest of the chromosomes except the *m*-chromosome. Photos 1 and 2 show two groups in which this clearly appears. These photographs are reproduced in Text Figs. 1*a*, 1*b*, with two others, *c* and *d*, the chromosomes in question being designated as I and *i*.

It is evidently this pair that give rise to the bivalent "accessory" (eccentric) chromosome of the first division and hence to the chromosome nucleolus of the growth period. Gross correctly describes this bivalent as a quadripartite body or tetrad, but overlooked the fact that it is composed of two slightly unequal halves, and these correspond in relative size to the unequal pair in the spermatogonia. This appears unmistakably in a great number of polar views of the first division metaphase (though it is not always apparent) and is clearly shown in Photos 3, 4 and 5. It is evident that the bivalent is so placed in the equatorial

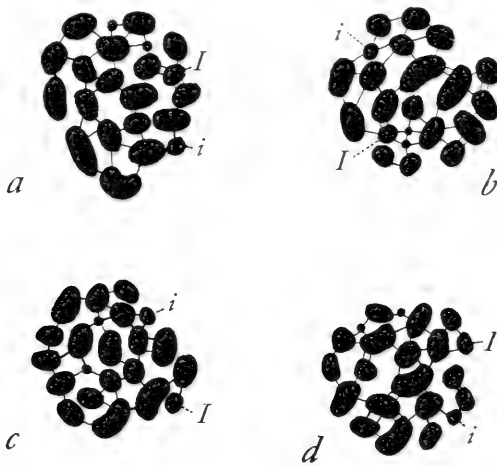

FIG. 1. Four spermatogonial chromosome-groups of *Syromastes marginatus*; *a* and *b* are reproductions of Photos 1 and 2.*

* The drawings are not made from the microscope with the camera lucida but directly upon enlarged photographs of the objects. Since I believe this method to be superior in accuracy for the representation of such small objects I will briefly describe it in the hope that others may find it useful. The original negatives are taken directly from the sections at an enlargement of 1500 diameters (2 mm. oil immersion, compensation ocular 6). From these negatives enlarged bromide prints are made (with a photographic camera) three times the size of the original negatives (i. e., 4500 diameters) upon double weight paper, which gives a good surface for pen drawings. The drawing is then made directly on the print with waterproof ink, and when thoroughly dry the remains of the photograph are bleached out in a mixture of sodium hyposulphite and potassium ferricyanide. The enlarged prints of course show the chromosomes with more or less blurred outlines (though they are clearer than might be supposed); but by working with an ordinary print and the object before one for comparison the drawings may nevertheless be made with great accuracy. They may be tested and if necessary corrected, by the use of a reducing glass.

plate as to undergo an equational division, like the idiochromosomes of other Hemiptera heteroptera. In uniting to form a bivalent before the first division these chromosomes differ from those of most other Hemiptera, but in all other respects up to the end of the first division they correspond exactly with them. But even this difference is bridged by a condition occasionally seen in other forms, for instance in *Lygæus* and *Metapodius*.⁶ In the last named form the typical and usual condition is that the idiochromosomes are in the first division quite separate, lying eccentrically outside the principal ring of chromosomes like the unpaired idiochromosomes of other coreids (Photos 6 and 7), and in this position they separately divide. Exceptionally, however, they lie in close contact (Photos 8 and 9), forming an asymmetrical bivalent precisely like that of *Syromastes*. In both cases this bivalent divides equationally, giving two asymmetrical daughter-dyads, thus $\frac{Ii}{ii}$.

The exactness of the correspondence up to this point seems to leave no doubt of the homology of this pair of chromosomes in the two forms. In the second division, however, the two species show a remarkable contrast. In *Metapodius*, as in *Lygæus* or *Euschistus*, the two idiochromosomes are always united to form an unsymmetrical bivalent which enters the equatorial plate and is separated into its two components, half the spermatids receiving the large one and half the small. In *Syromastes*, on the other hand, the idiochromosomes remain united and do not enter the equatorial plate at all, but pass directly to one pole where they are included in the daughter-nucleus, as Gross has described (Photos 11 to 17). Owing to this behavior of the idiochromosome bivalent, polar views of the second division always show but ten chromosomes instead of eleven (Photo 10). In this case therefore half the spermatid nuclei receive two more chromosomes than the others, the two classes having respectively ten and twelve chromosomes. As the idiochromosome bivalent passes to the pole its two components are usually closely united, and often cannot be

⁶ The latter remarkable genus, which presents the phenomenon of the "supernumerary chromosomes" (Wilson '07c), will form the subject of a forthcoming fifth "Study."

distinguished; but in some cases they may still be seen, as in Photo 12. As the nuclear vacuole forms the ordinary chromosomes rapidly diminish in staining capacity, while the idiochromosome bivalent retains its compact form and dark color, like a nucleolus, and thus comes conspicuously into view, particularly after safranin. Its double nature is at this time often more clearly apparent than in the preceding stages. It disappears from view some time after the reconstruction, at a much earlier period than in *Pyrrochoris*.

Only exceptionally in my preparations do the chromosomes of the second division show a quadripartite form as Gross figures them. Their usual form is dumb-bell shaped or dyad-like; though as the two halves separate they are often connected by double fibers, as is the case with many other species of Hemiptera.

PYRROCHORIS APTERUS L.

As already stated, *Pyrrochoris* is of different type from *Syro-mastes* and agrees precisely with other forms having an unpaired idiochromosome, such as *Anasa* or *Protenor*. Aside from the interest that this species possess as the one in which Henking first discovered the idiochromosome, it is in other respects a peculiarly interesting form for the study of the general spermatogenesis, particularly in respect to the presynaptic and synaptic periods. I shall here, however, confine myself mainly to the numerical relations and the history of the idiochromosome. Henking himself somewhat doubtfully concluded that the spermatogonial number was twenty-four: "Ich habe in drei Fällen die Zahl 24 erhalten, in einem Falle die Zahl 23. Da die Bilder überall die gleichen sind, so habe ich das Zahlgeschäft nicht an einer grösseren Zahl vorgenommen und glaube *die theoretisch zu erwartende Zahl 24 als das Normal ansehen dürfen*" (op. cit., p. 688, italics mine). It is clear enough from this that Henking, too, was misled by a false theoretic expectation; and a study of his figures (op. cit., Figs. 6, a, b, c, 7) will show that they are very far from decisive. In the case of the female, Henking speaks much more positively ('92) and there is hardly a doubt that his count of twenty-four chromosomes was correct, since he found this number "unverkenn-

bar" in the dividing oögonia, and in the connective tissue cells of the ovary, and also figured (Fig. 39) a double group (exactly such as I described in *Anasa*, Wilson '06, Fig. 2, *k*), showing forty-eight chromosomes.

Gross accepts Henking's account without question, treating the numerical relations in rather summary fashion as follows: "Die Aequatorialplatte der sich teilenden Spermatogonien enthält 24 Chromosomen. Dieselbe Zahl hat Henking ausser in den Spermatogonien auch in den Oogonien gefunden. Ebenso konnte ich in den Follikelzellen der Eiröhren, also in somatischen Zellen, konstatieren. 24 ist also die Normalzahl der Species" ('07, p. 277). In support of this are given two polar views of spermatogonial metaphases (the female groups are not figured) each showing eight small and sixteen large chromosomes (Figs. 9 and 10). His account continues as follows: The idiochromosome appears ready in the syanaptic period (synzesis) as a double nucleolus-like body, assumed to be a bivalent body that arises by the synapsis of two of the spermatogonial chromosomes, though none of the earlier stages were followed out. At a later period it appears as a single spheroidal body owing to the close apposition of its two halves. This chromosome divides in the first spermatocyte division, but in the second lags behind the others and passes undivided to one pole, as Henking described. All of the spermatid-nuclei thus receive eleven chromosomes, while half of them receive in addition the idiochromosome. Since both sexes were supposed to contain twenty-four chromosomes, Gross drew the same conclusion as the one previously reached in the case of *Syromastes*, namely, that only the twelve-chromosome spermatozoa are functional.

In regard to the spermatocyte divisions my own results are perfectly in accord with Henking's and Gross's. As to the spermatogonial number, I must say that after having immediately confirmed Gross's account of *Syromastes* (which I examined first) I was fully prepared to find a similar relation in *Pyrrhochoris*. It was therefore with astonishment that I found everywhere twenty-three instead of twenty-four spermatogonial chromosomes. This number appears with diagrammatic clearness in a great number of spermatogonia from different individuals (testes from 35 different

individuals have been sectioned) and is shown both in camera drawings and in photographs. Eight of the latter are shown (Photos 24 to 31), and these same groups are also represented in the drawings, Text Figs. 2, *a, b, c, d, e, j, k, l*, together with four others (*f, g, h, i*), also from photographs. Inspection of these photographs and drawings will show that the unpaired idiochromosome is at once recognizable by its large size, which renders

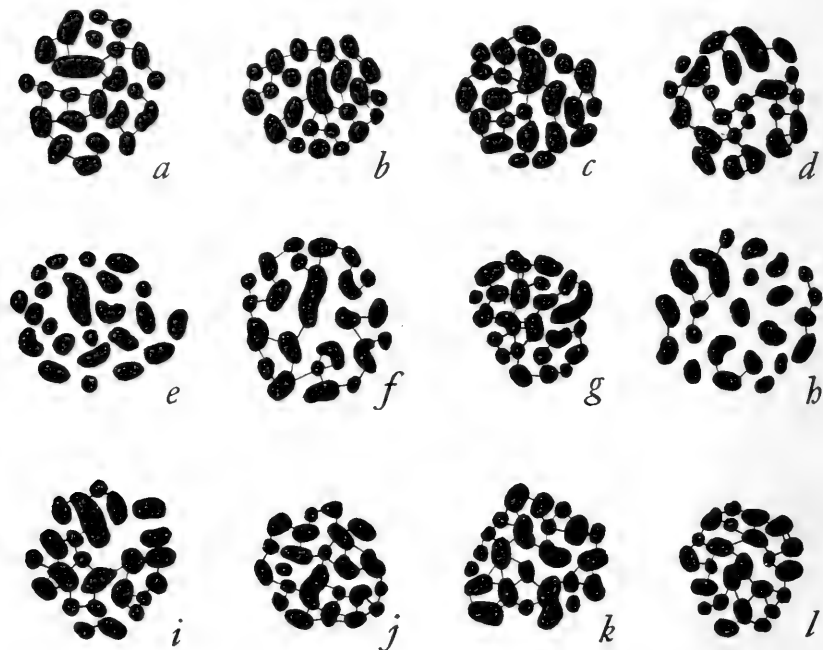

FIG. 1. Spermatogonial groups of *Pyrrhocoris apterus* (drawn on photographic enlargements, as explained under Fig. 1); *a, b, c, d, e, j, k* and *l* are reproductions of Photos 24, 25, 26, 27, 28, 29, 30 and 31, respectively.

it almost as conspicuous as in *Protenor* (heretofore described by Montgomery and myself). I find the size relations not quite the same as Gross describes them. There are, as he states, eight chromosomes that are considerably smaller than the others; but two of the others are but slightly larger. The remaining twelve paired chromosomes are much larger, though the contrast is in my material not so great as Gross figures it. The idiochromo-

some is nearly twice as large as any of the others, and is obviously unpaired. I have examined a large number of spermatogonial groups with great care with a view to the possibility that this chromosome might in reality be double, but am thoroughly convinced that such is not the case. This is unmistakably evident when this chromosome has the form of a straight or only slightly curved rod (Photos 24 to 28, Text Fig. 2, *a* to *i*), and these constitute the great majority of observed cases. I have, however, found a few cases where it has a very marked sigmoid curvature; two or three of these give at first sight the appearance of two chromosomes in contact (Photos 29, 30, 31; Text Fig. 2, *j*, *k*, *l*). Even here close study shows that it is a single body; but such forms might readily mislead an observer having a preconceived idea of the number to be expected.

That this is a single chromosome that is identical with the idiochromosome of the growth period and the maturation divisions is placed beyond doubt by a study of the presynaptic stages, which were not examined by either Henking or Gross. This period is of such interest in *Pyrrochoris* as to merit a special study. With only a single exception I know of no other form in which the history of the idiochromosome and the succession of the stages can be so completely and readily followed at this time. Throughout this whole period, beginning with the telophases of the last spermatogonial division, the idiochromosome can be traced step by step as a single body, and it is evidently identical with the large unpaired spermatogonial chromosome.

In the stages that immediately follow the last spermatogonial telophase (Photos 32 and 33) the chromosomes still retain their boundaries, though they show a looser texture, vaguer outlines and diminished staining capacity (by which characters the post-phases are readily distinguishable from the prophases). The large chromosome (idiochromosome) is clearly distinguishable at this time, both by its size and by its deeper color. In the stages that immediately follow a remarkable contrast appears between this chromosome and the others. The latter rapidly lose their visible boundaries and their staining capacity, breaking up into a fine net-like structure in which traces of a spireme-like arrangement may

sometimes be seen. The idiochromosome, on the other hand, retains its identity and deep color and now appears as a conspicuous elongated body ("caterpillar stage"). Though its outlines are still somewhat ragged and its color less intense than in the succeeding stages, it already appears in sharp contrast to the pale reticulum (Photos 34 and 35). It sometimes extends straight across the whole diameter of the nucleus; but beside such forms, in the same cysts, are often curved and shorter forms. At this time it is usually surrounded by a distinct clear space or vacuole, as I hope the photographs may show; and there are also in the nucleus from one to three much smaller nucleolus-like bodies which (on account of the staining reactions) I believe to be plasmosomes, but these soon disappear. Splendid pictures of these and the following stages are given by the safranin-lichtgrün combination, which shows the idiochromosome at every stage bright red, while in properly differentiated preparations the reticulum is pure green.⁷ The idiochromosome now takes up a peripheral position and the clear space surrounding it disappears. It acquires a more definite contour, stains still more intensely, and rapidly shortens until it is converted into a condensed ovoidal or spheroidal chromosome nucleolus that may be traced without a break through every stage up to the prophases of the first spermatocyte division. As it shortens it may undergo a variety of form changes. In what I regard as the typical process it shows no indication of duality at any period up to the full contraction phase (synizesis) being progressively reduced to a short rod and finally to an ovoidal or spheroidal body (Photos 36 to 42). In the meantime the nuclear reticulum contracts more and more, usually towards one side of the nucleus, becomes coarser in texture, and increases in staining capacity, until at the climax of the process

⁷ The effect of this stain depends in some measure, of course, on the relative degree of extraction of the two dyes. My method is to stain in safranin for two to four hours and then to place the slide at once in strong alcoholic solution of lichtgrün for ten to twenty seconds. This is at once followed by rapid washing in 95 per cent and absolute alcohols. The alcohol is then replaced by clove oil and the latter by xylol. In all cases the chromosomes of dividing cells and the chromosome nucleolus of all stages appear brilliant red, the achromatic fibers and general cytoplasm pure green. The relative intensity of red and green depend on the length of immersion in the green solution. The description here given applies to sections rather strongly stained in the green.

it forms a close knot, or rounded mass, staining almost black in hæmatoxylin, at one side of which is the idiochromosome (now a condensed chromosome nucleolus). These structures lie in a large clear nuclear vacuole, as shown in Photos 39 to 42. The stage thus attained is the characteristic contraction phase or synyzesis, which in this species is extremely marked.⁸

In the safranin-lichtgrün preparation at this period the chromosome nucleolus is, as always, intensely red. The synaptic knot varies with the relative intensities of the red and green, being in some preparations distinctly red, in others pure green, in still others of mixed appearance. In the succeeding stage the chromatin emerges from the synaptic knot in the form of separate spireme threads which lose their staining capacity for hæmatoxylin and in the double stain are again pure green (Photos 43 and 44). In the middle and late growth period they are still more or less green but contain red granules. In the prophases of the first division they at last lose their affinity for the green and finally appear pure red; but this does not occur until just before the dissolution of the nuclear membrane. Since the idiochromosome always retains its intense red color it may thus be followed from stage to stage with great certainty.

The study of the whole cycle of changes from the last spermatogonial division onward gives certain very definite results in regard to synapsis in general, and especially in regard to the idio-

⁸ Many recent writers have expressed the opinion that the synyzesis stage is an artifact produced as a shrinkage product, though Miss Sargant ('96) stated very explicitly that she had seen it in the living cells, and this has recently been confirmed by Overton ('05). I can fully substantiate this in the case of *Anasa tristis*. The perfectly fresh testis, gently teased apart in a Ringer's fluid in which the spermatozoa continue their active movements, very clearly shows nearly all the features of the spermatogenesis, including the number, shape and size relations of the chromosomes, their characteristic grouping and behavior in the spermatocyte divisions, the double rods, crosses and other prophase figures, the spindle fibers and asters, and even, I believe, the centrosomes. In this fresh material the synyzesis stage appears in essentially the same form as in the sections, the nuclear knot lying in a large clear vacuole. These nuclei only appear in the same region of the testis as in sections, and they show a conspicuous contrast to those of earlier and later stages that lie near by them. In the post synaptic stages the chromosomes, in the form of spireme threads can be seen again spreading through the nuclear cavity. These observations leave no doubt in my mind that the synyzesis is a normal phase of the spermatogenesis in these animals, though it is not improbable that the contraction may be somewhat exaggerated by the reagents. It is evident, however, from such studies as those of the Schreiners ('06) and others that the synyzesis does not occur in some forms.

chromosome. Concerning the first point I will here only indicate one principal conclusion. It is quite clear that in *Pyrrochoris* (and I think the same holds true in other Hemiptera) synapsis, or the conjugation of chromosomes two by two, does not occur in the closing anaphases of the last spermatogonial division as was described by Montgomery ('00) in *Peripatus* and *Euschistus* ("Pentatoma"), by Sutton ('02) in *Brachystola*, by Stevens ('03) in *Sagitta*, and by Dublin ('05) in *Pedicellina*. Although the number of chromosomes in the postphases immediately following this division (Photos 32 and 33) cannot be exactly made out, it is perfectly evident that it is not the reduced number but approximates to the somatic number (twenty-three). The chromosomes, therefore, have not paired two by two in the spermatogonial anaphases. It is equally certain that this stage does not pass directly into the synizesis but is separated from it by a long "resting period" (Photos 34 to 38)—as is demonstrated by the topographical relations as well as by the progressive stages of the idiochromosome—in which the ordinary chromosomes lose their sharp boundaries and their affinity for nuclear stains. In this respect *Pyrrochoris* shows a close similarity to *Tomopteris*, as described by the Schreiners ('06), whose original preparations, by the kindness of Dr. Schreiner, I have had opportunity to examine. This comparison has convinced me that synapsis occurs at the same period in both—whether by parasynapsis (side to side union) or telosynapsis (end to end union⁹) or in some other way I am not prepared to say. There can be no manner of doubt that the first division of the bivalents is a transverse one, as described by Paulmier and Montgomery; but it has been rendered evident enough by recent studies on reduction that this in itself gives no trustworthy evidence regarding the mode of synapsis. The direct investigation of the process in the Hemiptera presents great difficulties.

The foregoing general conclusion regarding the time of synapsis is of importance for the more specific one in regard to the idiochromosome. During the entire earlier presynaptic period the

⁹ I have for some years made use of these terms in my lectures on cytology.

elongated idiochromosome is manifestly a single body. As it shortens and condenses to form the chromosome nucleolus, it shows a considerable variety of forms; and the rate of condensation also varies, cells that are already entering the synzesis stage being sometimes seen in which the idiochromosome is still distinctly a rod (Photos 35 and 36). In most cases it is at this time a single ovoidal or spheroidal body; but not infrequently it appears more or less distinctly double (Photos 37 to 39). This condition is however not produced by a previous synapsis of two chromosomes, as Gross believed, but arises, I think, from a tendency of the chromatin to accumulate towards the ends of the rod; and when this is very marked it may assume an appearance of duality, even in the earlier stages (Photo 37, below), though this is relatively rare. In the later stages a double appearance is not infrequent, dumb-bell forms being thus produced, which sometimes give in the synzesis stage apparently double bodies. The earlier stages conclusively show that this is a secondary appearance. In the later (postsynaptic) stages (Photos 34 and 35), and throughout the growth period, it always appears as a single spheroidal body. In view of these facts I think the conclusion inevitable that the chromosome nucleolus is a univalent chromosome that arises by the condensation of the unpaired large chromosome of the spermatogonia.

I have little to add to Henking's and Gross's accounts of the maturation divisions. As will be seen from Photos 45, 46, 50, 51, the size relations are correlated with those of the spermatogonial chromosomes. In polar views of the first division appear with great constancy four smallest chromosomes, one slightly larger one, and seven still larger ones, or twelve in all. The idiochromosome is one of the largest, but cannot be distinguished from the others (as is also the case in *Protenor*). This is obviously due to the fact that the idiochromosome is still a univalent or single chromosome, while each of the others represents two of the spermatogonial chromosomes united. Since all have nearly the same dumb-bell shape as seen in side view, the idiochromosome appears from the pole approximately but half as large, relative to the others, as in the spermatogonia. The same size-relations appear in the second division, but all the chromosomes are much smaller, as the photographs clearly show.

I have not succeeded with *Pyrrochoris* (as I have with several other genera) in obtaining photographs of both anaphase daughter groups showing all the chromosomes; but it is perfectly evident that all divide equally in the first division, and all but the idiochromosome in the second. This chromosome lags behind the others and then passes undivided to one pole where it is included in the daughter nucleus (Photos 47 to 49) as Henking described. This pole thus receives twelve chromosomes, the other but eleven. As in a number of other species the idiochromosome retains its compact form and deep-staining capacity long after the reconstruction of the nuclei and the breaking up of the other chromosomes. It may thus be distinguished (especially well in safranin preparations) up to a rather late period stage of the spermatids, even after the tails have grown out. It finally disappears from view, and the mature spermatozoa show no visible indication of their dimorphism.

GENERAL

If my conclusions are correct, *Pyrrochoris* agrees exactly with other forms in which an unpaired idiochromosome is present. *Syromastes* however presents a new type in which the "accessory" chromosome is not univalent but bivalent, and in which accordingly half the spermatozoa receive two more chromosomes than the other half. If we may apply the same rule to *Syromastes* as that which holds for other Hemiptera we may expect the spermatozoa that receive the "accessory" to be female-producing, the others male-producing. The fertilization formulas for the two species considered in this paper should therefore be as follows:

PYRROCHORIS

Egg 12 + spermatozoön 11 = zygote 23 (♂)

Egg 12 + spermatozoön 12 = zygote 24 (♀)

SYROMASTES

Egg 12 (including *I* and *i*)* + spermatozoön 10 = zygote 22 (including *I* and *i*) (♂)

Egg 12 (including *I* and *i*) + spermatozoön 12 (including *I* and *i*) = zygote 24 (including *I*, *I*, *i*, *i*) (♀)

* The formation of a reduced female group of this composition may readily be explained if it be supposed that in synapsis the two small idiochromosomes couple with each other to form the bivalent *ii*, the two large ones to form the bivalent *II*.

The correctness of my deduction may readily be tested by a reëxamination of the female groups. Gross, it is true, states that he has found but twenty-two chromosomes in the female (follicle cells); but I think no one is likely to consider as in any way conclusive the single figure that he gives in support of this (op. cit., Fig. 111). Not less than five of the twenty-two chromosomes figured are deeply constricted; and any one of these might in reality be two chromosomes in contact. I hope that Dr. Gross himself may be willing to reëxamine this point, in view of the possibility here suggested. It is however also possible that the two members of each of the idiochromosome pairs in the female may be united to form a bivalent, in which case the female would apparently show but twenty-two chromosomes; but even if this be so the two members must separate again when transferred to the male.

In regard to *Pyrochoris*, there is little doubt that the determination of the female number by Henking and Gross as twenty-four was correct; and since the idiochromosome in the male is the largest of the chromosomes we may expect the female groups to show two such chromosomes.¹⁰

I should state the expectation less confidently in the case of *Syro-mastes* if it stood entirely alone; but another case has now been made known in which the male and female groups differ by more than one chromosome. This occurs in the genus *Galgulus*, which has been worked out in my laboratory by Mr. F. Payne (whose results are now in press)¹¹ on material collected by myself. The following facts are very clearly shown in this form. The spermatogonial number is thirty-five, the female number thirty-eight. In the second division five of the chromosomes are always asso-

¹⁰ Henking's figures ('92) give considerable evidence that such is really the case. His Fig. 83 of the first polar metaphase shows one of the twelve bivalents fully twice the size of the others; and the same is true of Fig. 68, which shows a side view of the second polar spindle, though not all the chromosomes are shown. With this accords his Fig. 39 of a double group from a connective tissue cell of the female showing forty-eight chromosomes, of which four, of nearly equal size, are nearly twice the size of the others. This agrees precisely with the relation shown in a double group of *Anasa* figured by me in a former paper ('06, Fig. 2, *k*) which shows twice the normal number of both the largest and the smallest chromosomes.

¹¹ Since published in *Biol. Bull.*, xiv, 5.

ciated to form a definite pentad element of which four pass to one pole, one to the other, while the remaining fifteen chromosomes divide equally. Half the spermatozoa thus receive sixteen chromosomes and half nineteen. From these facts it is clear that the sixteen-chromosome class must be male producing, the nineteen-chromosome class female producing, according to the formula:

GALGULUS

$$\begin{aligned} \text{Egg } \frac{n}{2} + \text{spermatozoön } \frac{n}{2} - 3 &= \text{zygote } n - 3 (\sigma) \\ \text{Egg } \frac{n}{2} + \text{spermatozoön } \frac{n}{2} &= \text{zygote } n (\varphi) \end{aligned}$$

This case, together with that of *Syromastes* (if my inference regarding this form be correct) shows that we must considerably enlarge our previous conceptions as to the relations between sex production and the chromosomes; for we can no longer hold that only a single pair are involved. In *Syromastes* there are two such pairs, in *Galgulus* several pairs.

A COMPARATIVE REVIEW OF THE TYPES OF SEXUAL DIFFERENCES
OF THE CHROMOSOMES

It is evident that a greater variety of types exists in regard to the sex differences than was indicated in the brief general review given in the third of my "Studies" (Wilson '06.) In that paper I distinguished three types, examples of which are given by *Protenor*, *Lygæus* and *Nezara*; but the number must now be increased to at least five, and possibly to seven, of which I will now give a brief synopsis. With the exception of *Syromastes* and *Diabrotica* this synopsis includes only species of which both sexes have been accurately determined. Forms like the aphids, in which idiochromosomes have not yet been positively identified, have been omitted. Seventeen of the species are here reported for the first time (one or both sexes) from my own results hitherto unpublished. I am indebted to Dr. Stevens for permission to include her results on the *Diptera* and on *Diabrotica*, which are now in press ('08a, '08b).

I

Both sexes with the same number of chromosomes; a pair of equal idiochromosomes present in both. No visible difference between the two classes of spermatozoa or between the male and female somatic groups.

FERTILIZATION FORMULA

$$\text{Egg } \frac{n}{2} + \text{spermatozoon } \frac{n}{2} = \text{zygote } n (\sigma \text{ or } \varphi)$$

Described Case

Specie	Order	Family	Somatic No.		Authority
			♂	♀	
Nezara hilaris Say	Hemiptera heteroptera	Pentatomidæ	14	14	Wilson ('06)

To this type belongs also *Oncopeltus fasciatus* Dall, one of the *Lygæidæ*. It is further probable that here belong many forms in which no visible sexual differences are to be seen, and in which idiochromosomes have not been identified. If a particular pair of chromosomes, corresponding to idiochromosomes, are of general occurrence, though not visibly distinguishable from the others, it is probable that this type represents the most frequent condition in animals generally.

II

Both sexes, and both classes of spermatozoa, with the same number of chromosomes. The male with a pair of unequal idiochromosomes, half the spermatozoa receiving the large one and half the small. In the female a pair of equal idiochromosomes like the large one of the male.

FERTILIZATION FORMULA

$$\begin{aligned} \text{Egg } \frac{n}{2} (\text{including } I) + \text{spermatozoön } \frac{n}{2} (\text{including } i) &= \text{zygote } n (\text{including } Ii) \sigma \\ \text{Egg } \frac{n}{2} (\text{including } I) + \text{spermatozoön } \frac{n}{2} (\text{including } I) &= \text{zygote } n (\text{including } II) \varphi \end{aligned}$$

Described Cases

Species	Order	Family	♂ Somatic No.	♀ Somatic No.	Authority
<i>Oeбалus pugnax</i> Fab.	Hemiptera heteroptera	Pentatomidæ	10	10	Wilson
<i>Euschistus</i>					
<i>fissilis</i> Uhl.	Hemiptera heteroptera	Pentatomidæ	14	14	Wilson '05b, '05c, '06
<i>ictericus</i> L.	Hemiptera heteroptera	Pentatomidæ	14	14	Wilson '06
<i>servus</i> Say	Hemiptera heteroptera	Pentatomidæ	14	14	Wilson
<i>tristigmus</i> Say	Hemiptera heteroptera	Pentatomidæ	14	14	{ ♂ Montgomery '01 ♀ Wilson '06
<i>variolarius</i> P. B.	Hemiptera heteroptera	Pentatomidæ	14	14	Wilson '06
<i>Cœnus delius</i> Say	Hemiptera heteroptera	Pentatomidæ	14	14	Wilson '05b, '05c, '06
<i>Stiretrus anchorago</i> Fab	Hemiptera heteroptera	Pentatomidæ	14	14	Wilson
<i>Podisus</i>					
<i>maculiventris</i> Say } (<i>spinus</i>) }	Hemiptera heteroptera	Pentatomidæ	16	16	{ ♂ Montgomery '01 ♀ Wilson '05b, '05c, '06
<i>Banasa</i>					
<i>dimidiata</i> Say	Hemiptera heteroptera	Pentatomidæ	16	16	Wilson '07b
<i>calva</i> Say	Hemiptera heteroptera	Pentatomidæ	26*	26	Wilson '07b
<i>Lygæus</i>					
<i>turcius</i> Fab.	Hemiptera heteroptera	Pentatomidæ	14	14	Wilson '05b, '05c, '06
<i>bicrucis</i> Say	Hemiptera heteroptera	Pentatomidæ	14	14	Wilson
<i>Tenebrio molitor</i>	Coleoptera	Tenebrionidæ	20	20	Stevens '05
<i>Chelymorpha argus</i>	Coleoptera	Chrysomelidæ	22	22	Stevens '06
<i>Trirhabda virgata</i>	Coleoptera	Chrysomelidæ	28	28	Stevens '06
<i>canadense</i>	Coleoptera	Chrysomelidæ	30	30	Stevens '06
<i>Drosophila ampelophila</i>	Diptera		8	8	Stevens '08a
<i>Musca domestica</i>	Diptera		12	12	Stevens '08a
<i>Calliphora vomitoria</i>	Diptera		12	12	Stevens '08a
<i>Sarcophaga sarracinæ</i>	Diptera		12	12	Stevens '08a
<i>Scatophaga pallida</i>	Diptera		12	12	Stevens '08a
<i>Tetanocera sparsa</i>	Diptera		12	12	Stevens '08a
<i>Eristalis tenax</i>	Diptera		12	12	Stevens '08a

* See Type IIa.

III

The female chromosome groups with one more chromosome than the male. Male with an unpaired idiochromosome and an odd spermatogonial number, half the spermatozoa receiving the idiochromosome and half being without it. Female with an equal pair of idiochromosomes like the unpaired one of the male.

FERTILIZATION FORMULA

$$\text{Egg } \frac{n}{2} \text{ (including } I) + \text{spermatozoön } \frac{n}{2} - 1 = \text{zygote } n - 1 \text{ (including } I) \text{ ♂}$$

$$\text{Egg } \frac{n}{2} \text{ (including } I) + \text{spermatozoön } \frac{n}{2} \text{ (including } I) = \text{zygote } n \text{ (including } II) \text{ ♀}$$

Described Cases

Species	Order	Family	♂ Somatic No.	♀ Somatic No.	Authority
Largus cinctus H. S.	Hemiptera heteroptera	Pyrrochoridæ	11	12	Wilson
succinctus L.	Hemiptera heteroptera	Pyrrochoridæ	13	14	Wilson
Pyrrochoris apterus L.	Hemiptera heteroptera	Pyrrochoridæ	23	24	{ ♀ Henking '91 ♂ Wilson
Alydus pilosulus H. S.	Hemiptera heteroptera	Coreidæ	13	14	Wilson '05b, '05c, '06
Harmostes reflexulus Std.	Hemiptera heteroptera	Coreidæ	13	14	{ ♂ Montgomery '01 ♀ Wilson '06
Protenor belfragei Hag.					Coreidæ
Leptocoris trivittatus Say	Hemiptera heteroptera	Coreidæ	13	14	
Archimerus calcarator Fab.	Hemiptera heteroptera	Coreidæ	15	16	Wilson
Pachylis gigas Burm.	Hemiptera heteroptera	Coreidæ	15	16	Wilson
Anasa tristis DeG.	Hemiptera heteroptera	Coreidæ	21*	22	Wilson '05b, '05c, '06, '07a
armigera Say	Hemiptera heteroptera	Coreidæ	21	22	{ ♂ Montgomery '06 ♀ Wilson
sp.	Hemiptera heteroptera	Coreidæ	21	22	Montgomery '06
Euthoctha galeator Fab.	Hemiptera heteroptera	Coreidæ	21	22	Wilson
Leptoglossus phyllopus L.	Hemiptera heteroptera	Coreidæ	21	22	Wilson
Margus inconspicuus H. S.	Hemiptera heteroptera	Coreidæ	23	24	Wilson
Chariesterus antennator Fab.	Hemiptera heteroptera	Coreidæ	25	26	Wilson
Corynocoris distinctus Dall.	Hemiptera heteroptera	Coreidæ	25	26	Wilson
Aprophora quadrangularis	Hemiptera homoptera	Jassidæ	23	24	Stevens '06
Pæciloptera septentrionalis	Hemiptera homoptera	Fulgoridæ	27	28	Boring '07
pruinosa	Hemiptera homoptera	Fulgoridæ	27	28	Boring '07
Elater, sp.	Colcoptera	Elateridæ	19	20	Stevens '06
Blatta germanica	Orthoptera	Blattidæ	23	24	{ ♂ Stevens '06 ♀ Wassilieff '07
Anax junius	Odonata	Aeschiidæ	27	28	LeFevre and McGill '08

*This number, disputed by Foot and Strobell ('07a, b), has since been confirmed by my own reëxamination ('07a, '08) and by that of Lefevre and McGill ('08) and others.

5

IV

Female groups (by inference only) with two more chromosomes than the male. In the male a pair of unequal idiochromosomes, half the spermatozoa receiving both these chromosomes, and hence two more than the other half. In the female (by inference only) two such pairs.

FERTILIZATION FORMULA

Egg $\frac{n}{2}$ (including *I, i*) + spermatozoön $\frac{n}{2} - 2 =$ zygote $n - 2$ (including *I, i*) ♂

Egg $\frac{n}{2}$ (including *I, i*) + spermatozoön $\frac{n}{2}$ including *I, i*) = zygote n (including *I, I, i, i*) ♀ (by inference only)

Described Case

Specie	Order	Family	Somatic No.		Authority
			♂	♀	
<i>Syromastes marginatus</i> L	Hemiptera heteroptera	Coreidæ	22	24	{ ♂ Gross '04 ♀ Wilson (inferred)

V

Female groups with three more chromosomes than the male. Half the spermatozoa receiving three more chromosomes than the other half.

Egg $\frac{n}{2} +$ spermatozoön $\frac{n}{2} - 3 =$ zygote $n - 3$ (♂)

Egg $\frac{n}{2} +$ spermatozoön $\frac{n}{2} =$ zygote n (♀)

Described Case

Specie	Order	Family	Somatic No.		Authority
			♂	♀	
<i>Galgulus oculus</i> Fab.	Hemiptera heteroptera	Galgulidæ	35	38	Payne '08

At least two of the foregoing types may be complicated by the presence of certain additional chromosomes, present in some individuals but not in others of the same species, to which I have applied the name of "supernumerary chromosomes."¹² The number of these varies from one to six in different individuals but is constant in the same individual. In some forms (*Metapodius*, *Banasa*) these supernumer-

¹² Wilson '07b, '07c. A detailed description is now in preparation.

aries accompany a typical pair of unequal idiochromosomes (as in Type II). In other forms (*Diabrotica*), the supernumeraries accompany an unpaired idiochromosome (as in Type III). In these cases definite numerical formulas cannot be given, since the distribution of the supernumeraries is variable and both sexes show a variable number of chromosomes in consequence (directly known only in *Metapodius*.) For the present these cases may most conveniently be treated as sub-types as follows:

IIa

Forms that agree with Type II except that certain individuals may possess, in addition to a pair of idiochromosomes, one or several supernumerary chromosomes. The cases described, with the numbers of chromosomes observed, are as follows:

Species	Order	Family	♂	♀	Authority
			Somatic No.	Somatic No.	
<i>Banasa calva</i>	Hemiptera heteroptera	Pentatomidæ	26 [26+1]	26	Wilson '07b
<i>Metapodius terminalis</i>	Hemiptera heteroptera	Coreidæ	21* 22 22+1 22+2 22+3 22+4	22 22+1 22+2 22+3	Wilson '07b, '08
<i>femoratus</i>	Hemiptera heteroptera	Coreidæ	22 22+2 22+3 22+4	22+1 22+2 22+4 22+6	Wilson '07b, '08
<i>granulosus</i>	Hemiptera heteroptera	Coreidæ	22 22+1 22+2 22+3 22+4 22+5	22+3 22+4	Wilson '07b, '08

* This number occurs only in Montgomery's ('06) material of this species, identification of which though probably correct, is not absolutely certain. This case will be considered in a later publication.

IIIa

Forms that agree with Type III except that certain individuals may possess, in addition to an unpaired idiochromosome, one or several supernumerary chromosomes. Described cases as follows:

Specie	Order	Family	♂	♀	Authority
			Somatic No.	Somatic No.	
Diabrotica 12-punctata soror	Coleoptera	Chrysomelidæ	19		Stevens '07, '08
			19+1		
			19+2		
			19+3		
			19+4		

Despite the apparent diversity of the types that have been enumerated all conform to the common principle that the spermatozoa are of two classes, equal in number, that are respectively male producing and female producing. In the case of Type I this is no more than an inference, since the two classes cannot be distinguished by the eye; but its great probability will be admitted in the fact that the forms with equal idiochromosomes are connected by forms (such as *Mineus*) in which only a slight inequality exists, with those in which the inequality is very marked (Wilson '05a). The facts now show that the difference between the two classes of spermatozoa is not always confined to a single pair of chromosomes, but may affect two pairs (*Syromastes*) or even a larger number (*Galgulus*). It is noteworthy that in every case where a quantitative difference of chromatin exists between the sexes it is always in favor of the female, whether it appear in a larger number of chromosomes or in the greater size of one of them. But I must again emphasize the fact that this quantitative difference cannot be considered as the primary factor that differentiates the two classes, for in the first class such a difference does not exist,¹³ while in *Metapodius*, even in the same species, it is some-

¹³ I based this type on the facts observed in *Nezara*, where the idiochromosomes are equal in size in both sexes. This is not in accordance with the later observations of Montgomery ('06) who believes that in the Hemiptera generally the two components (paternal and maternal) of every chromosome pair are at least slightly unequal—though he finds the idiochromosomes of *Oncopeltus* equal as I have also since observed. A reëxamination of *Nezara* confirms my original account of this form, though in some individuals the idiochromosomes often appear very slightly unequal. A careful examination of the other chromosomes, particularly the small *m*-chromosomes (which are most favorable for the purpose) in *Alydus*, *Anasa*, *Archimerus*, *Pachylis*, and other genera, leads me to a very skeptical view of Montgomery's general conclusion on this point. It is true that the two members of each pair vary slightly in relative size, and are not always exactly equal; but, in my material at least, it is clear that

times the female, sometimes the male, that has the larger number and quantity. I therefore adhere to the view that if the primary and essential difference between the two classes of spermatozoa inhere in the chromosomes (there is of course room for difference of opinion on this point) it must be, or originally have been, qualitative in nature.

Since the appearance of my third "Study," in which some general discussion of the sex chromosomes was offered, there has appeared an important paper by Correns ('07) on the higher plants, the results of which, as he points out, harmonize remarkably with those based on the cytological evidence. The most important of his results is the experimental proof obtained by hybridizing experiments on *Bryonia*, that in the diœcious species the pollen grains are male producing and female producing in equal numbers, quite in accordance with the view put forward by McClung ('02) in regard to the spermatozoa of insects and proved to be correct in principle by the work of Stevens and myself. That the same result should appear from investigations carried out on such different material and by such different methods certainly gives good ground for the belief that as far as the male is concerned the phenomenon is at least a very general one. Professor Correns points out in some detail the extraordinarily close parallel between his experimental results and the cytological ones of Stevens and myself; but the interpretation that he offers differs materially from both those that I suggested in an analysis of my observations (Wilson '06). According to my first interpretation (Castle's) both sexes are assumed to be sex hybrids or heterozygotes. The conclusion of Correns is that, in respect to the active sexual tendencies of the gametes that produce them, only the male is a sex hybrid or heterozygote (σ (φ)), while the female is a homozygote (φ φ).¹⁴ This interpretation explains the numerical equality

this is merely a casual fluctuation, the general rule being equality. This variation appears in different cells of the same cyst (as may be seen with especial clearness in the *m*-chromosomes in side views of the second division where errors due to foreshortening may be eliminated). It would be indeed strange if these relations were subject to no variation whatever.

¹⁴ It is necessary to an understanding of Correns's view to bear in mind that the gametes are not considered to be "pure" in the original Mendelian sense, but to bear both sexual possibilities, one of which is "active," the other "latent."

of the sexes in accordance with the Mendelian principle without the necessity for assuming selective fertilization. It is so simple, and seems to be so clearly demonstrated in the case of Bryonia, that its application to the interpretation of sex production in general is very tempting. Correns himself believes it "very probable" that his conclusion will apply to all the dioecious flowering plants, and possible that it may also hold true of animals (op. cit., pp. 65, 66). It is evident that in their superficial aspects the cytological results seem to bear this out. Wherever the sexes show visible differences in the somatic chromosome groups the female groups consist of two series in duplicate, while the male groups show two series that are not duplicates, only one of them being identical with one of the female series. As far as the chromosomes are concerned, and from a purely morphological point of view, the female is therefore in fact a homozygote, the male a heterozygote, in these animals. But when more closely scrutinized from this standpoint the interpretation seems by no means so clear. As I showed in my third "Study" the odd chromosome of the male must be derived from the egg; and if this chromosome bears the sexual tendency, it must under Correns's hypothesis carry the female tendency—which is a *reductio ad absurdum*, since it is not accompanied by a male-bearing mate or partner in the male. I think this brings clearly into view the following alternative. Either the females of these insects must be physiologically heterozygotes (as I assumed), or the so-called "sex chromosomes" (idiochromosomes) do not bear the sexual tendencies but only accompany them in a definite way. Which of these possibilities is the true one may be left to further research to decide. I will only point out that Professor Correns carefully considers the difficulties that his interpretation encounters in some other directions, and admits that it must be modified in certain cases—for example in the honey bee and in *Dinophilus*, in which latter case he too is compelled to admit the possibility of selective fertilization. The parthenogenetic females of such forms as the aphids and phylloxerans, which produce both males and females without fertilization, are still considered by Correns as homozygotes, the production of males being assumed to be determined, if I under-

stand his conception, by the activation of the "latent" (not to be confused with the "recessive") male possibility in the male producing eggs. This is doubtless an admissible assumption, though it seems to me to put a considerable strain upon the general hypothesis. The more natural view would seem to be the one directly suggested by the facts, i.e., that the parthenogenetic stem-mother aphid is a heterozygote, the male tendency being in the condition of a Mendelian recessive. But I will not enter upon a discussion of this question, which is now in a condition where a little observation and experiment will outweigh a large amount of hypothesis. I think, however, that the first of the interpretations that I suggested (following Castle) should not be rejected without further data, and especially not until the question of selective fertilization has been put to the test of direct experiment.

Zoölogical Laboratory
Columbia University
February 13, 1908

WORKS REFERRED TO

- BORING, ALICE M. '07—A Study of the Spermatogenesis of twenty-two Species of the Membracidae, Jassidae, Cercopidae and Fulgoridae. *Journ. Exp. Zool.*, iv, 4.
- CORRENS, C. '07—Die Bestimmung und Vererbung des Geschlechtes. Berlin, 1907. Also (in abbreviated form) in *Arch. f. Rassen- u. Ges.-Biologie*, iv, 6.
- DUBLIN, L. I. '05—The History of the Germ-cells in *Pedicellina Americana*. *Ann. N. Y. Acad. Sci.*, xvi, 1.
- FOOT, K., and STROBELL, E. C. '07a—The "Accessory Chromosome" of *Anasa tristis*. *Biol. Bull.*, xii.
- '07b—A Study of Chromosomes in the Spermatogenesis of *Anasa tristis*. *Am. Journ. Anat.*, vii, 2.
- GROSS, J. '04—Die Spermatogenese von *Syromastes marginatus*. *Zool. Jahrb., Anat. u. Ontog.*, xx.
- '07—Die Spermatogenese von *Pyrrochoris apterus*. *Ibid.*, xxiii.
- HENKING, H. '91—Ueber Spermatogenese und deren Beziehung zur Eientwicklung bei *Pyrrochoris apterus*. *Zeitschr. f. Wiss. Zool.*, li.
- '92—Untersuchungen über die ersten Entwicklungsvorgänge in den Eiern der Insekten, Ill. *Ibid.*, liv, 1.

- LEFEVRE, G., and MCGILL, C. '08—The Chromosomes of *Anasa tristis* and *Anax junius*. *Am. Journ. Anat.*, viii, 4.
- MEVES, F. '03—Ueber "Richtungskörperbildung" im Hoden von Hymenopteren. *Anat. Anz.*, xxiv.
- '07—Die Spermatocytenteilungen bei der Honigbiene, etc. *Arch. mik. Anat.*, lxx, 3.
- MONTGOMERY, T. H. '00—The Spermatogenesis of *Peripatus*, etc. *Zool. Jahrb., Anat. u. Ontog.*, xiv.
- '01—A Study of the Chromosomes of the Germ-cells of Metazoa. *Trans. Am. Phil. Soc.*, xx.
- '04—Some Observations and Considerations upon the Maturation Phenomena of the Germ-cells. *Biol. Bull.*, vi, 3.
- '06—Chromosomes in the Spermatogenesis of the Hemiptera Heteroptera. *Trans. Am. Phil. Soc.*, xx.
- McCLUNG, C. E. '02—The Accessory Chromosome—Sex Determinant? *Biol. Bull.* iii.
- OVERTON, J. B. '05—Ueber Reduktionsteilung in den Pollenmutterzellen einiger Dikotylen. *Jahrb. wiss. Bot.*, xlii, 1.
- PAULMIER, F. C. '99—The Spermatogenesis of *Anasa tristis*. *Journ. Morph., Supplement*.
- PAYNE, F. '08—On the Sexual Differences of the Chromosome groups in *Galgulus oculatus*. *Biol. Bull.*, xiv, 5.
- SARGANT, ETHEL '96—The Formation of the Sexual Nuclei in *Lilium martagon*. I, Oögenesis. *Ann. Bot.*, x.
- SCHREINER, K. E. and A. '06—Neue Studien über die Chromatinreifung der Geschlechtszellen (*Tomopteris*). *Arch. Biol.*, xx.
- STEVENS, N. M. '03—On the Ovogenesis and Spermatogenesis of *Sagitta bipunctata*. *Zool. Jahrb., Anat. u. Ontog.*, xviii.
- '05—Studies in Spermatogenesis with Especial Reference to the "Accessory Chromosome." Carnegie Institution, Washington, Pub. no. 36.
- '06—Studies in Spermatogenesis. II. A Comparative Study of the Heterochromosomes in certain Species of Coleoptera, Hemiptera and Lepidoptera, with Especial Reference to Sex Determination. *Ibid.*, Pub. 36, II.
- '08a—A Study of the Germ-cells of Certain Diptera, etc., *Journ. Exp. Zoöl.*, v, 3.
- '08b—The Chromosomes in *Diabrotica*, etc. *Ibid.*, v, 4.
- SUTTON, W. S. '02—On the Morphology of the Chromosome group in *Brachystola magna*. *Biol. Bull.*, iv, 1.

- WALLACE, L. B. '05—The Spermatogenesis of the Spider. *Biol. Bull.*, viii.
- WASSILIEFF, A. '07—Die Spermatogenese von *Blatta germanica*. *Arch. mik. Anat.*, lxx.
- WILSON, E. B. '05a—Studies on Chromosomes. I. The Behavior of the Idiochromosomes in Hemiptera. *Journ. Exp. Zool.*, ii.
- '05b—The Chromosomes in Relation to the Determination of Sex in Insects. *Science*, xx, p. 500.
- '05c—Studies on Chromosomes. II. The paired Microchromosomes, Idiochromosomes and Heterotropic Chromosomes in the Hemiptera. *Ibid.*, ii.
- '06—Studies on Chromosomes. III. The Sexual Differences of the Chromosome Groups in Hemiptera, with some Considerations on the Determination and Inheritance of Sex. *Ibid.*, iii.
- '07a—The Case of *Anasa tristis*. *Science*, xxv, p. 191.
- '07b—Note on the Chromosome groups of *Metapodius* and *Banasa*. *Biol. Bull.*
- '07c—The Supernumerary Chromosomes of *Metapodius*. Read before the May Meeting of the N. Y. Acad. of Sci. *Science*, xxvi, 677.
- '08—The Accessory Chromosome of *Anasa tristis*. Read before the Am. Soc. of Zoölogists, December, '07. *Science*, xxvii, 690.

EXPLANATION OF PLATES

All of the figures are reproduced directly from photographs by the author, without retouching. The originals were taken with a Spencer $\frac{1}{2}$ oil-immersion, Zeiss ocular 6, which gives an enlargement of 1500 diameters. The admirable method of focusing devised by Foot and Strobell was employed. They are reproduced at the same magnification.

PLATE I

(Photos 1 to 5, 10 to 23, *Syromastes marginatus*; 6 to 10, *Metapodius terminalis*; 24 and 25, *Pyrrorchis apterus*).

1 and 2. Spermatogonial groups of *Syromastes*; copied in Text-fig. 1, *a, b*.

3 to 5. Polar views, first maturation metaphase; *m*-chromosome at the center, idiochromosome-bivalent ("accessory" chromosome) outside the ring at the left.

6 and 7. Corresponding views of *Metapodius*, typical condition with the two separate idiochromosomes outside the ring at the left.

8 and 9. The same; exceptional condition, with the idiochromosomes (at the left) in contact.

10. Polar metaphase, second division, *Syromastes*.

11 to 17. Side views of the same division. The duality of the idiochromosome appears in 12, 16 and 17.

18 to 23. Early prophases of first maturation division, *Syromastes*. Each of these shows the separate *m*-chromosomes, and in all but No. 20 the chromosome nucleolus (idiochromosome bivalent) also appears.

24 and 25. Spermatogonial metaphases of *Pyrrorchis* (copied in Text-figs. 2, *a, b*).

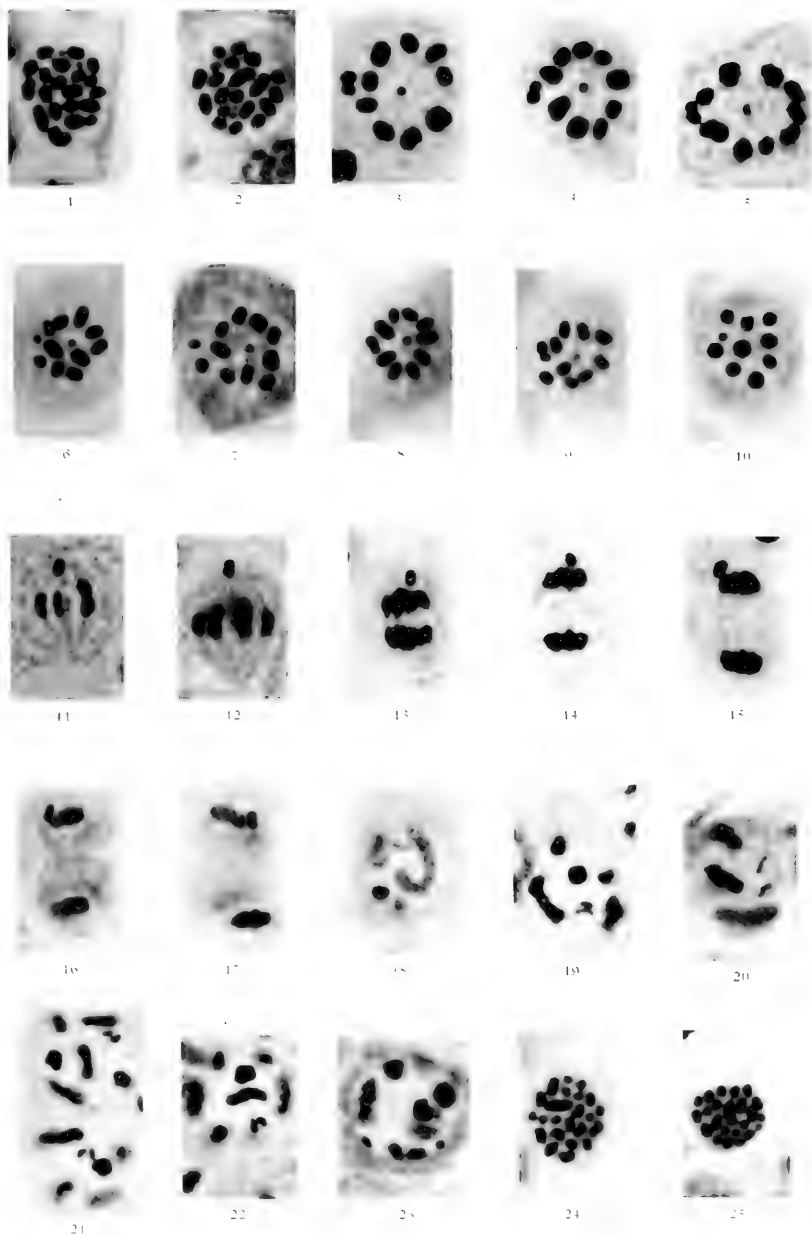



PLATE II

Pyrochoris apterus

26 to 31. Spermatogonial groups, each showing twenty-three chromosomes, including the large unpaired idiochromosome; 30, 31 illustrate the rare case in which the latter appears double, owing to marked sigmoid curvature. These photos are copied in Text-figs. 2, c, d, e, j, k and l, respectively.

32 and 33. Post-phases shortly following last spermatogonial division; the chromosomes still distinct, idiochromosome recognizable by its large size and deeper color.

34 and 35. Presynaptic stages following the last, showing "caterpillar" stage of idiochromosome and small nucleoli. In the last two the shortening has begun.

36 to 38. Further condensation of the idiochromosome; initial stages of synizesis; apparent duality of the idiochromosome in two of the cells.

39 to 42. Synizesis, showing various forms of the chromosome nucleolus.

43 and 44. Early post-synaptic stages.

45 and 46. Polar metaphases, first spermatocyte division.

47 to 49. Side views of second division.

50 and 51. Polar metaphases, second division.

Edmond B. Wilson.

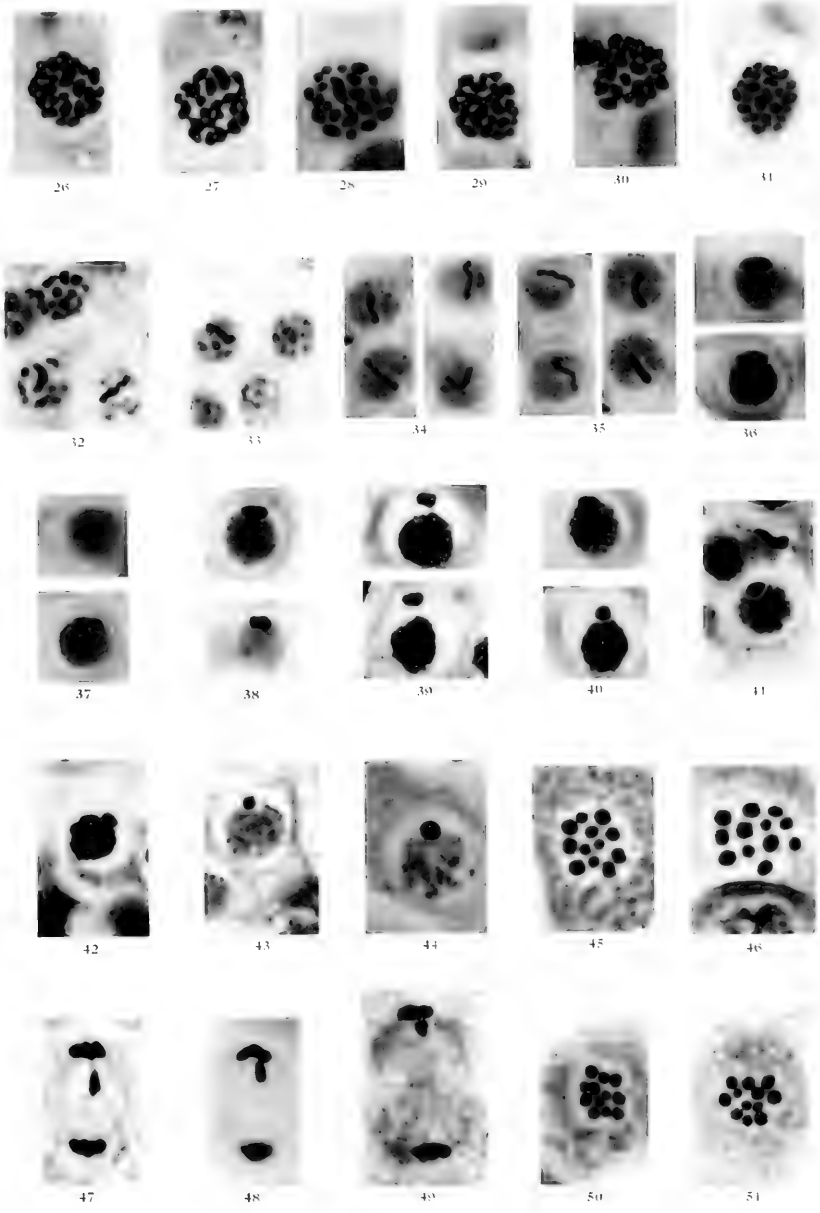



FURTHER STUDIES ON THE CHROMOSOMES OF THE COLEOPTERA

BY

N. M. STEVENS

WITH FOUR PLATES

In three previous papers ('05, '06, '08) the chromosomes of several species of Coleoptera have been described and figured, and the rôle of the heterochromosomes in sex determination discussed. The following pages are a further contribution to our knowledge of the character and behavior of the heterochromosomes, and of the methods of synapsis in this order of insects.

The methods used in handling the material have been the same as in previous work: fixation with Gilson's mercurio-nitric, Flemming's chromo-aceto-osmic, and Hermann's platino-aceto-osmic fluids, and staining with iron hæmatoxylin or thionin. The aceto-carmin method has been used in testing fresh material, and as a check on the section method.

PHOTINUS PENNSYLVANICUS (FAM. LAMPYRIDÆ)

PHOTINUS CONSANGUINEUS (FAM. LAMPYRIDÆ)

In my 1906 paper on the spermatogenesis of Coleoptera and other insects, the spermatogonial plate of one of the fireflies, *Ellychnia corrusca*, was shown on Pl. XIII, Fig. 236. The material was obtained from adults in September at Woods Hole. Only spermatogonia and growth stages of the spermatocytes were present in the testes. The spermatogonial plate contains nineteen chromosomes (Fig. 1), two V's, two long rods and fifteen shorter rods. Constancy in form made this material seem very favorable for study of the individuality of the chromosomes, but I have not been able to get the maturation stages. Two other fireflies

however have been studied, *Photinus pennsylvanicus* and *Photinus consanguineus*.

In *Photinus consanguineus*, all of the spermatocyte stages were found in the testis of the adult in summer at Cold Spring Harbor, and dividing spermatogonia were obtained from the larva in October. In the adults of *Photinus pennsylvanicus* only ripe spermatozoa were present; in the larvæ collected in October and November, only spermatogonia and growth stages of the spermatocytes. A large number of larvæ were collected and kept during the winter in battery jars with a piece of turf in the bottom. Some of the jars were placed in the greenhouse, others in a cool basement room. The material from both sets of jars was tested from time to time with aceto-carmine, but not until May when the larvæ were beginning to pupate, were any maturation mitoses found. From May 8 to May 13 both larvæ and pupæ furnished good material. As in *Tenebrio molitor*, the pupæ contained favorable divisions in somatic cells.

Fig. 2 is the equatorial plate of an oögonium of *Photinus pennsylvanicus*, from an ovary sectioned in October. There are twenty chromosomes, two longer and two shorter than the others. The two smallest correspond to the small odd chromosome (x) of the male, seen in Fig. 3, the spermatogonial plate of nineteen chromosomes. Fig. 4 is an equatorial plate from a male somatic cell, found in mitosis in the digestive tract of a male pupa. In *Ellychnia corrusca* the synizesis and synapsis stages are similar to those previously described for several of the Coleoptera (Stevens '06, Pl. IX, Figs. 37 to 42, 61 to 62, and Pl. XII, 153 to 154; Nowlin '06, Pl. I, Figs. 2 to 5, and Pl. II, Figs. 52 to 54)—a dense group of short loops at one end of the nucleus in synizesis, followed by a stage in which the loops straighten and unite in pairs. In *Photinus pennsylvanicus* these stages are quite different. After the last spermatogonial division, the chromosomes evidently remain condensed for some time, for we find many cysts on the border line between spermatogonia and spermatocytes in which the nuclei have the appearance of Fig. 5. A slightly later stage shows the chromosomes more crowded together and at one side of the nuclear space. The next stage, which might

be called the synizesis stage, shows the odd chromosome (x) still condensed, and the others forming a rather fine and closely wound spireme (Fig. 7). The fine spireme of Fig. 7 gradually thickens and spreads out (Fig. 8), and later loses much of its staining quality (Figs. 9 and 10). In these later growth stages the spireme winds in such a way as to appear in tangential section (Fig. 10) to radiate from the heterochromosome (x). There seems to be no question in this case but that synapsis must occur in the stage shown in Figs. 5 and 6, since the spireme, once formed (Fig. 7), remains unbroken until the prophase of the first maturation division.

When the chromosomes come into the first spermatocyte spindle, nine of them are often typical tetrads, and one a dyad (Fig. 11). A comparison of x which is univalent with the bivalents convinces one that this is a reducing division for the bivalents and quantitative for the odd chromosome. In early metaphase the chromosomes viewed from one pole of the spindle are circular or oval in outline (Fig. 12), but in metakinesis and anaphase (Fig. 13) nine are dumb-bell shaped and one, the heterochromosome, is circular. Figs. 14 and 15 show the typical metakinesis and early anaphase, while Fig. 16 is a late anaphase.

The second spermatocytes all contain ten chromosomes, of which one, the daughter heterochromosome (x) usually stands out to one side of the equatorial plate (Fig. 17), and nearer one pole of the spindle in metaphase and anaphase (Figs. 18 and 19).

In most of the Coleoptera where an odd chromosome has been found, it passes undivided to one pole of the first spindle, and divides in the second division, as in the Orthoptera and many Hemiptera homoptera; but in *Photinus* we have a case like that of *Anasa* and several other Hemiptera heteroptera where the unpaired chromosome undergoes its quantitative division in the first spermatocyte while its bivalent companions are being separated into their univalent elements.

In *Photinus consanguineus* the number of chromosomes is the same as in *Photinus pennsylvanicus*, twenty in the female and nineteen in the male. The chromosomes of the daughter plates are easily counted after the cell has divided (Fig. 20),

proving that the heterochromosome is not divided in this mitosis and that the spermatozoa are dimorphic, half of them containing ten, the other half nine chromosomes.

The chromosomes of an egg follicle cell are shown in Fig. 21, and those of a spermatogonium in Fig. 22. The synzesis and synapsis stages are quite different from those of *Photinus pennsylvanicus*, and similar to those of *Ellychnia*. The synzesis stage has the short crowded loops (Fig. 23). The synapsis stage is less distinct than in some of the cases previously described. One occasionally finds a nucleus with the longer synaptic loops (Fig. 24), but more often synapsis and union of chromosomes occur at the same time, giving a mixture of loops, and spireme with sharp angles of which Fig. 25 is perhaps a fair specimen. The heterochromosome may be seen in this stage but is more conspicuous in the later pale spireme stage (Fig. 26).

Fig. 27 is the first spermatocyte equatorial plate, Fig. 28 and Fig. 29 the metaphase and anaphase, showing the unpaired chromosome dividing late. In fact, it frequently divides so late that the two daughter-heterochromosomes are still quite close together and connected by linin fibers in the metaphase of the pairs of second spermatocytes, as shown in Figs. 30 and 31. A pair of daughter plates are given in Fig. 32, showing that as in *P. pennsylvanicus*, the heterochromosome does not divide in the second spermatocyte. Usually it lags behind the daughter plate to which it belongs, so that the two anaphases (Figs. 29 and 33) are characterized by a pair of daughter heterochromosomes, and by a single heterochromosome, respectively.

These two species of *Lampyridæ* are the only cases which have been found, where the unpaired heterochromosome divides in the first spermatocyte instead of the second. In one, *Photinus consanguineus*, it divides very late, in a stage which is a late anaphase or telophase for the other chromosomes, while in the other species, *P. pennsylvanicus*, it divides at the same time with the other chromosomes, or only slightly later. It will be interesting to study the spermatogenesis of other *Lampyridæ* for comparison on this point. An abundance of adult material of several other species has been secured and examined, but only spermatozoa

were found. It will therefore be necessary to obtain the larvæ or pupæ before the maturation stages can be studied.

LIMONEUS GRISEUS (FAM. ELATERIDÆ)

In previous work an odd chromosome was found in two species of Elateridæ ('06). In both, the male number of chromosomes was nineteen, and in one the female number (twenty) was determined ('06, Pl. XIII, Fig. 229). In both species the unpaired chromosome was the smallest one.

In *Limoneus griseus* there are seventeen chromosomes in the spermatogonia (Fig. 34), and the heterochromosome (x) is the largest. The synapsis and synzesis stages are similar to those of *Photinus pennsylvanicus*. The most conspicuous stage in the transition from spermatogonia to spermatocytes is one in which the condensed chromosomes appear as approximately spherical bodies which nearly fill the small nucleus (Fig. 35). In Fig. 36 the chromosomes are united and somewhat elongated. Elongation continues until all traces of the individual chromosomes, with the exception of the odd chromosome (x), are lost in the fine, closely wound spireme with which the heterochromosome remains connected by linin threads (Fig. 37). As the nucleus enlarges, and the spireme becomes thicker and less stainable, the heterochromosome shows a central vacuole (Fig. 38), and a little later it appears like a spireme wound about in plasmosome material and still connected with the much paler general spireme (Fig. 39). At this point it resembles in its behavior the "accessory" of *Orchesticus* and *Xiphidium* (McClung '02, Pl. VII, Figs. 4, 5, 12). In the later pale spireme stage (Fig. 40) the heterochromosome is again condensed.

In the first spermatocyte spindle the odd chromosome appears in the equatorial plate in metaphase (Figs. 41 and 42), does not divide, but lags behind the daughter plates (Fig. 43). The chromosomes of a pair of daughter plates are shown in Fig. 44. In the telophase (Fig. 45) the heterochromosome holds the hæmatoxylin after the other chromatin has been almost entirely destained. In the second spermatocytes (Fig. 46) the unpaired

chromosome (x) frequently divides somewhat later than the others. Polar plates of the two classes of second spermatocyte mitoses are shown in Figs. 47 and 48. So far as investigated the Elateridæ have an unpaired heterochromosome which differs from that of the Lampyridæ in dividing in the second spermatocytes.

NECROPHORUS SAYI (FAM. SILPHIDÆ)

Necrophorus sayi has an unpaired heterochromosome, while *Silpha americana* ('06, Pl. XI, Figs. 141-150) has an unequal pair of heterochromosomes. *Necrophorus* also differs from *Silpha* in having a much smaller number of chromosomes, thirteen in the spermatogonia (Fig. 49), while *Silpha* has forty. The synizesis stage is of the finely wound spireme type with the odd chromosome usually visible. There is no preliminary stage that can be pointed out as a synapsis stage, but as the chromosomes remain united in a spireme up to the prophase of the first maturation division, when they appear in the reduced number, it seems certain that synapsis must occur at the close of the last spermatogonial division before the synizesis stage. The bivalents of the prophase of the first spermatocyte mitosis (Fig. 50) have the appearance of two spermatogonial chromosomes united end to end, and in the spindle they are merely somewhat shortened (Fig. 52).

The first spermatocyte has seven chromosomes with the univalent one oftenest at the center of the group (Fig. 51). Fig. 52 shows the seven chromosomes of one spindle drawn at three different levels of the same section. Here the odd chromosome is at the periphery of the plate. The centrosomes in this form are very large. Polar plates of one spindle are shown in Fig. 53, and in Fig. 54 equatorial plates of the second divisions which proceed as in other similar cases giving the usual dimorphic spermatids, containing in *Necrophorus* six and seven chromosomes.

CHRYSOMELA SIMILIS (FAM. CHRYSOMELIDÆ)

Most of the Chrysomelidæ have an unequal pair of heterochromosomes, but *Chrysomela similis*, like the *Diabroticas*, has an odd chromosome. At the close of the synizesis stage this

form often shows synapsis with unusual clearness (Fig. 55). Fig. 56 shows a late growth stage with the spireme still staining more deeply than in most cases, and Fig. 57 the equatorial plate of the first spermatocyte with twelve chromosomes. Metakinesis of several of the bivalents and division of the centrosome are shown in Fig. 58, and an early anaphase in Fig. 59. The second spermatocytes contain eleven and twelve chromosomes (Fig. 60), as do also the spermatids and spermatozoa. The sperm heads (Fig. 61) have a large middle piece which stains in iron hæmatoxylin, but not in thionin.

LISTOTROPHUS CINGULATUS (FAM. STAPHYLINIDÆ)

STAPHYLINUS VIOLACEUS (FAM. STAPHYLINIDÆ)

Three rove-beetles have been examined with a rather small amount of material in each case. All have an unequal pair of heterochromosomes. *Listotrophus cingulatus* has twenty-six chromosomes in the spermatogonia (Fig. 62), one being very small. The heterochromosome pair is distinguishable in the synizesis stage, which is of the spireme type, and in the later growth stages both members of the pair are clearly separated and associated with a large plasmosome. The chromosomes of the first spermatocyte are shown in Figs. 63 and 64, and those of the second division in Figs. 65 and 66.

In the blue rove-beetle, *Staphylinus violaceus*, the heterochromosome pair associated with a plasmosome is shown in Fig. 67. The first spermatocyte contains twenty-two chromosomes (Fig. 68), and the unequal pair shows clearly in a section of a spindle (Fig. 69). The two second spermatocyte equatorial plates appear in Figs. 70 and 71. Another brown rove-beetle, not identified, has twenty-eight chromosomes in the spermatogonia and fourteen in the spermatocytes.

TETRAOPES TETRAOPHTHALMUS (FAM. CERAMBYCIDÆ)

CYLENE ROBINIA (FAM. CERAMBYCIDÆ)

Tetraopes, the common red milkweed beetle, has twenty chromosomes. Two spermatogonial plates (Figs. 72 and 73) show the different appearance of the chromosomes in different cysts.

The two smallest are the heterochromosomes. The synizesis and synapsis stages are of the loop type, though not especially clear. Fig. 74 is the equatorial plate of the first maturation division; and Figs. 75 to 77, metaphase and anaphase, show the unequal pair of heterochromosomes dividing either earlier or later than the other chromosomes.

Only one specimen of *Cylene* gave any maturation divisions. The remainder of the testes examined contained only spermatids and spermatozoa. The number of chromosomes is the same as in *Tetraopes*, twenty. The larger heterochromosome shows the peculiarity of holding the stain longer than the other chromosomes. Figs. 78 and 79 are metaphases of the first division from an iron hæmatoxylin preparation much destained.

EPICAUTA CINEREA (FAM. MELOIDÆ)

EPICAUTA PENNSYLVANICA (FAM. MELOIDÆ)

Two varieties of *Epicauta cinerea*, one with all gray elytra and the other with a lighter gray border around the elytra, were studied, and the chromosomes in both, as well as in *Epicauta pennsylvanica*, found to be of the same number and character—nineteen large and one small chromosome in the spermatogonia. The synizesis and synapsis stages are of the loop type and the maturation divisions result in spermatids one half of which contain the small heterochromosome, and one half the large one. Figs. 80 to 83 show the chromosomes of the spermatogonia, first and second spermatocytes. The larger heterochromosome holds the stain as in *Cylene*.

PENTHE OBLIQUATA (FAM. MELANDRYIDÆ)

Only one pair of *Penthe obliquata* has been captured. The ovaries and one testis were fixed in Gilson's mercurio-nitric fluid, and the other testis in Flemming. The Flemming material alone gave any satisfactory results. The presence of an unequal pair of heterochromosomes is shown in Figs. 84 to 86—a spermatogonial plate, a section of a first spermatocyte spindle, and two second spermatocyte equatorial plates.

CICINDELA VULGARIS (FAM. CICINDELIDÆ)

In *Cicindela primeriana* ('06, Pl. XIII, Figs. 198 to 206) the number of chromosomes was twenty, and the heterochromosome pair a large trilobed bivalent. In *Cicindela vulgaris* the number is twenty-two, three larger than the others (Fig. 87). In the first spermatocyte spindle the conspicuous elements are the trilobed heterochromosome group and a four-lobed or cross-shaped macrochromosome (Fig. 88). The divisions are like those of *Cicindela primeriana*.

OTHER CHRYSOMELIDÆ

Among the Chrysomelidæ, several other cases of an unequal pair of heterochromosomes will be briefly referred to. *Lema trilineata* (Figs. 89 to 92) has thirty-two chromosomes, one very small. The synzinesis stage is of the loop type followed by synapsis. *Doryphora clivicolis* is quite similar to *Doryphora 10-lineata* ('06, Pl. XII, Figs. 151 to 186), and the character of the heterochromosome group is much more easily determined. The reduced number of chromosomes is seventeen, instead of eighteen as in *10-lineata*. The chromosomes of the first and second maturation divisions are shown in Figs. 93 to 96.

Chrysochus auratus has the loop type of synzinesis and synapsis and a typical pair of quite unequal heterochromosomes (Figs. 97 and 98). The reduced number is thirteen. *Haltica chalybea*, the steel-blue flea-beetle, has twenty-two chromosomes in the spermatogonium (Fig. 100). Only occasionally a specimen of this species has been found in the net, and these have been studied with the aid of aceto-carmin. No drawings have been made of synzinesis, synapsis or growth stages. Fig. 101 is a prophase showing the heterochromosomes (h_1 and h_2) and another condensed pair of chromatin elements which may be *m*-chromosomes. In the later prophase when the chromosomes are coming into the spindle, the heterochromosomes are often widely separated (Fig. 102), and the same is true of the metaphase (Figs. 103 to 105), so that twelve chromosomes show in the equatorial plate of the first spermatocyte (Fig. 106), but in the late anaphase (Fig. 107), the

two heterochromosomes are always found between the two polar masses of chromatin separating like any other unequal pair. In the telophase and youngest spermatids they are usually still separate from the general mass of chromatin (Fig. 108). An abundance of material for further study of this form is much to be desired.

The chromosomes of *Coptocyclus clavata* are very similar to those of *Coptocyclus guttata* (Nowlin '06). There are eighteen in the spermatogonium, the two smallest being the unequal pair of heterochromosomes. The testes of *Lina laponica* were examined with the hope that there might be some perceptible difference in chromosomes corresponding to the dimorphism described by Miss McCracken ('06) but none was found. The first spermatocytes contain seventeen rather small bivalents, one of which is quite unequal, and the second equatorial plates show clearly the usual dimorphism.

MISCELLANEOUS

A number of the Coccinellidæ have been found to have nineteen large and one small chromosome in the spermatogonia and ten in the spermatocytes as in *Adalia bipunctata* ('06, Pl. XIII, Figs. 193 to 197). An unequal pair has also been found in one of the Rhynchophora, *Phytonomus punctata*, and in *Obera tripunctata*, one of the Lamiinæ.

DISCUSSION

The character of the heterochromosomes has now been determined for more than fifty species of Coleoptera, belonging to sixteen families. In twelve species an unpaired heterochromosome has been found, in all of the others an unequal pair, and in *Diabrotica soror* and *Diabrotica 12-punctata* ('08) from one to four small supernumerary heterochromosomes may be present in addition to a large unpaired one.

In connection with the work on the odd chromosome in the Coleoptera, new material of *Stenopelmatus* ('05) has been studied, and the spermatogonial number determined as forty-seven instead of forty-six. It was also possible to count one cyst of second

spermatocytes; the numbers are twenty-three and twenty-four, and the odd chromosome can be identified among the twenty-four. *Stenopelmatus* material, at best, is unfavorable for accurate counting on account of the large number of chromosomes and the fact that they rarely form flat plates.

There seems at present to be no doubt that whenever an unpaired heterochromosome is present in the first spermatocyte, the spermatogonial number is odd in the Coleoptera, Orthoptera and Hemiptera (cases with supernumeraries are an exception to the rule which however, applies if the supernumeraries are counted out). It is equally certain that the unequal pair of the spermatocyte is also found in the spermatogonia. In *Tenebrio molitor* and *Photinus pennsylvanicus* the chromosomes of the somatic cells of the male have been shown to be of the same number and character as those of the spermatogonia.

Not quite so certain is it that an equal pair of heterochromosomes in the female always corresponds to the unpaired one or the unequal pair. This paper adds two more, *Photinus pennsylvanicus* and *Photinus consanguineus*, to the four species of Coleoptera previously recorded ('05 and '06) as having such an equal pair of female heterochromosomes. No exceptions have been found, but it proves to be difficult to get suitable material for determining the number of chromosomes in somatic cells. The pupæ would probably give good somatic mitoses in nearly every case, but they are rarely to be had unless one can breed the insects. In the flies there was no difficulty in finding dividing oögonia and egg-follicle cells, and in every case an equal pair of large heterochromosomes corresponded to the large and the small one of the male ('08). In the Hemiptera an equal pair of heterochromosomes has been determined in the female of a comparatively large number of species (Wilson '05, '06, '07, Stevens '06, Boring '07). The consensus of evidence would therefore indicate that this is the rule for these orders of insects, and that the determination of sex is closely connected with fertilization, since it is evident that only those eggs that are fertilized by spermatozoa containing the odd chromosome or the larger of an unequal pair of heterochromosomes can develop into females, and the males

must be the result of fertilization by spermatozoa which contain either no heterochromosome or the smaller of an unequal pair.

The only other alternative for these insects seems to be that sex is already determined in the egg before fertilization either as a matter of dominance or as a result of maturation, and that fertilization is selective; i.e., the eggs that are already predetermined to produce females can be fertilized by those spermatozoa only which contain the odd chromosome or the larger of two unequal heterochromosomes, while the eggs which are already male can be fertilized only by the other class of spermatozoa. If a general application of the results obtained in insects were to be made, the second supposition would certainly cover more cases, but any such general application is premature until adequate evidence is at hand to prove that the sex character is represented in the chromosomes.

Further study of the phenomena of synapsis and synizesis in the Coleoptera indicates the existence of at least two distinct types. In the first, which I have called the loop type, synizesis seems to be a prolonged telophase of the last spermatogonial mitosis, the spermatogonial number of chromosomes appearing as short loops crowded together at one end of the nucleus. After a time the loops straighten and the free ends unite in pairs and the pairs unite to form a spireme. In some cases the synapsis stage is very distinct, in others, synapsis and union to form a spireme occur nearly or quite simultaneously.

The second, or spireme type of synizesis is preceded by synapsis which may form a distinct stage as in *Photinus pennsylvanicus* and *Limoneus grisens*, or it may occur in the anaphase or telophase of the last spermatogonial mitosis, and a closely wound spireme follow immediately. In this type, the heterochromosomes are usually distinguishable in the synizesis stage outside of the massed spireme, while in Type I they are not seen until after the spireme is formed.

Bryn Mawr College

March 4, 1908

LITERATURE CITED

- BORING, A. M. '07—A Study of the Spermatogenesis of Twenty-two Species of Membracidae, Jassidae, Cercopidae and Fulgoridae. *Jour. Exp. Zool.*, vol. iv.
- McCLUNG, C. E. '02—The Spermatocyte Divisions of the Locustidae. *Kans. Univ. Quart.*, vol. xi.
- McCRACKEN, I. '06—Inheritance of Dichromatism in *Lina* and Gasteroidea. *Journ. Exp. Zool.*, vol. iii.
- NOWLIN, W. N. '06—A Study of the Spermatogenesis of *Coptocyclus aurichalcea* and *Coptocyclus guttata*, with Especial Reference to the Problem of Sex Determination. *Journ. Exp. Zool.*, vol. iii.
- STEVENS, N. M. '05—Studies in Spermatogenesis with Especial Reference to the "Accessory Chromosome." Carnegie Institution, Washington, Pub. 36.
- '06—Studies in Spermatogenesis. II. A Comparative Study of the Heterochromosomes in Certain Species of Coleoptera, Hemiptera and Lepidoptera, with Especial Reference to Sex Determination. Carnegie Institution, Washington, Pub. 36, no. 2.
- '08—A Study of the Germ Cells of Certain Diptera, with Reference to the Heterochromosomes and the Phenomena of Synapsis. *Jour. Exp. Zool.*, vol. v.
- '08—The Chromosomes in *Diabrotica vittata*, *Diabrotica soror* and *Diabrotica 12-punctata*: A Contribution to the Literature on Heterochromosomes and Sex Determination. *Journ. Exp. Zool.*, vol. v.
- WILSON, E. B. '05—Studies on Chromosomes. II. The Paired Microchromosomes, Idiochromosomes and Heterotropic Chromosomes in the Hemiptera. *Journ. Exp. Zool.*, vol. ii.
- '06—Studies on Chromosomes. III. Sexual Differences of the Chromosomes Groups in Hemiptera, with some Considerations on the Determination of Sex. *Jour. Exp. Zool.*, vol. iii.
- '07—Note on the Chromosome Groups of *Metapodius* and *Banasa*. *Biol. Bull.*, vol. xii.
- '07—The Supernumerary Chromosomes of Hemiptera. *Science*, n. s., vol. xxvi.

DESCRIPTION OF PLATES

The figures were drawn with camera lucida, and the magnification multiplied with the aid of a drawing camera, by $1\frac{1}{2}$ or by 2, as follows:

Figs. 1, 4, 5 to 10, 22 to 51, 53 to 100, 106—Zeiss 2 mm., 12 oc. $\times 2$.

Figs. 2 and 3, 13 to 16, 18 to 20—Zeiss 2 mm., 12 oc. $\times 1\frac{1}{2}$.

Figs. 11 and 12, 17, 101 to 104, 105 to 107—Zeiss 2 mm., 6 oc. $\times 2$.

Fig. 108—Zeiss 2 mm., 6 oc. $\times 1\frac{1}{2}$.

Figs. 21, 52—Zeiss 1.5 mm. 12 oc. $\times 2$.

The plates were reduced one-half.

Lettering on Plates

x = an unpaired heterochromosome.

h_1 = the larger of an unequal pair of heterochromosomes.

h_2 = the smaller of an unequal pair of heterochromosomes.

PLATE I

Ellychnia corrusca (Fam. Lampyridæ)

Fig. 1 Spermatogonium, metaphase, nineteen chromosomes.

Photinus pennsylvanicus (Fam. Lampyridæ)

Fig. 2 Oögonium, metaphase, twenty chromosomes.

Fig. 3 Spermatogonium, metaphase, nineteen chromosomes.

Fig. 4 Somatic cell ♂, metaphase, nineteen chromosomes.

Figs. 5 and 6 Synapsis stages.

Fig. 7 Synizesis stage, spireme type.

Figs. 8 and 10 Growth stages.

Figs. 11 and 12 First spermatocytes, metaphase.

Fig. 13 First spermatocyte, metakinesis, polar view.

Fig. 14 First spermatocyte, metakinesis, side view.

Figs. 15 and 16 First spermatocytes, anaphase.

Fig. 18 Second spermatocyte, metaphase.

Fig. 19 Second spermatocyte, anaphase.

Fig. 20 A pair of spermatids with nine and ten chromosomes.

Photinus consanguineus (Fam. Lampyridæ)

Fig. 21 Ovarian follicle cell, metaphase, twenty chromosomes.

Fig. 22 Spermatogonium, metaphase, nineteen chromosomes.

Fig. 23 Synizesis stage, loop type.

Figs. 24 and 25 Synapsis stages.

Fig. 26 Growth stage.

N. M. STEVENS

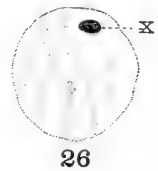
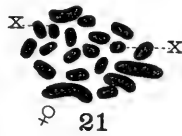
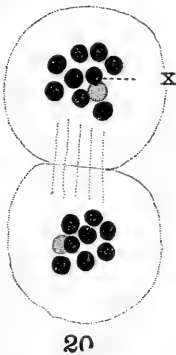
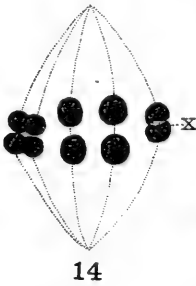
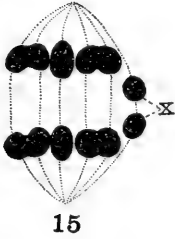
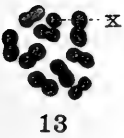
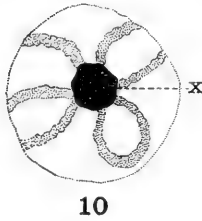
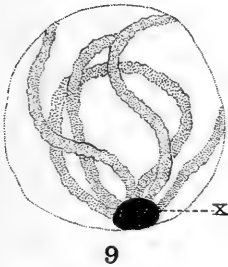
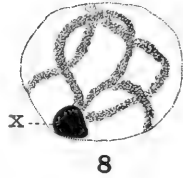
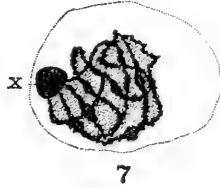
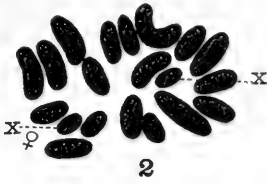

PLATE II

Photinus consanguineus (continued)

- Figs. 27 and 28 First spermatocytes, metaphase.
- Fig. 29 First spermatocyte, anaphase.
- Figs. 30 and 31 Second spermatocytes, metaphase.
- Fig. 32 Second spermatocyte, daughter plates.
- Fig. 33 Second spermatocyte, anaphase

Limoneus griseus (Fam. Elateridæ)

- Fig. 34 Spermatogonium, metaphase, seventeen chromosomes.
- Figs. 35 and 36 Synapsis stages.
- Fig. 37 Synizesis stage, spireme type.
- Figs. 38 to 40 Growth stages.
- Figs. 41 and 42 First spermatocytes, metaphase.
- Fig. 43 First spermatocyte, telophase.
- Fig. 44 First spermatocyte, daughter plates.
- Fig. 45 Second spermatocyte, brief rest stage.
- Fig. 46 Second spermatocyte, anaphase.
- Figs. 47 and 48 Second spermatocytes, daughter plates containing eight and nine chromosomes.

Necrophorus sayi (Fam. Silyphidæ)

- Fig. 49 Spermatogonium, metaphase, thirteen chromosomes.
- Fig. 50 First spermatocyte, prophase.
- Figs. 51 and 52 First spermatocytes, metaphase.
- Fig. 53 First spermatocyte, daughter plates.
- Fig. 54 Second spermatocytes, equatorial plates.

N. M. STEVENS

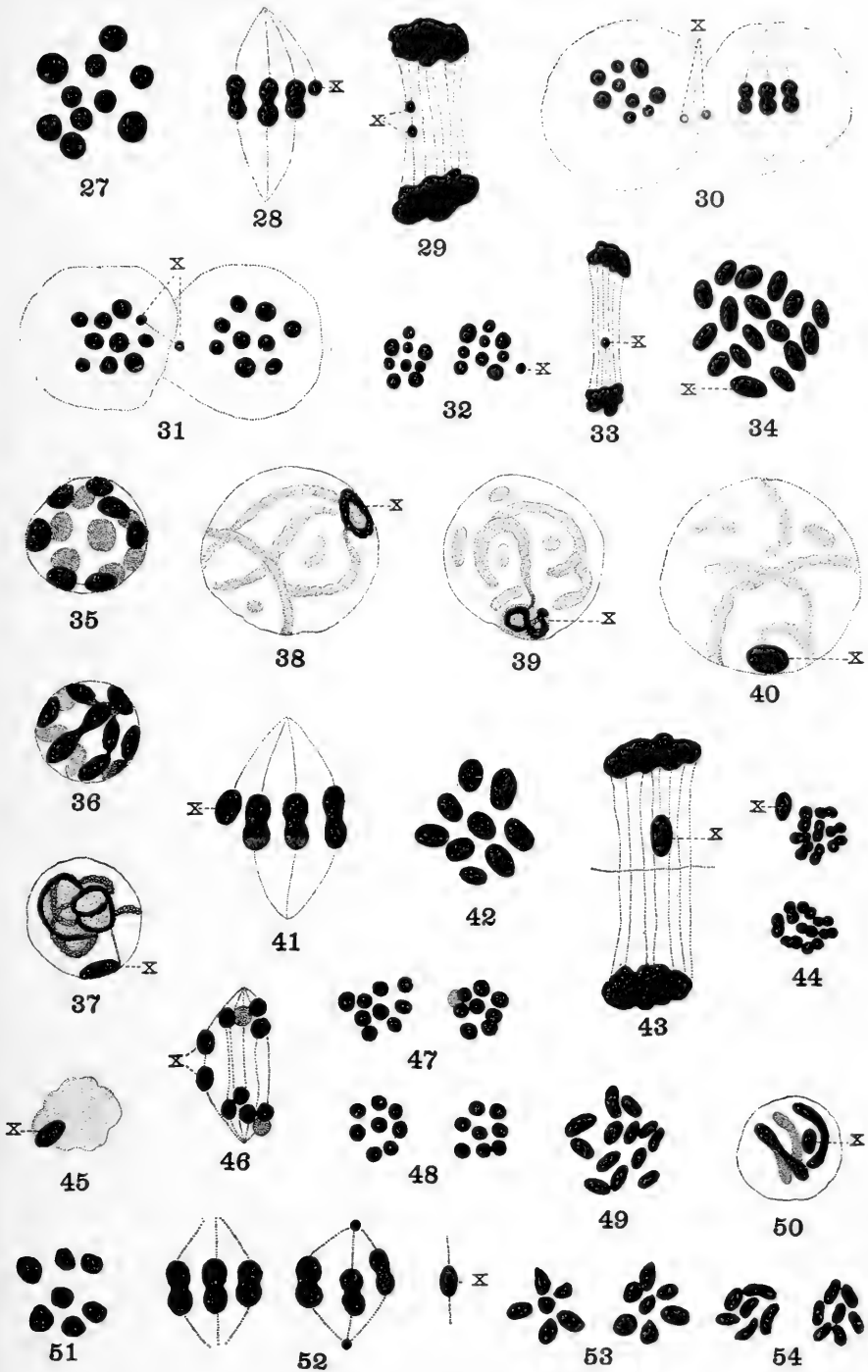

PLATE III

Chrysomela similis (Fam. Chrysomelidae)

- Fig. 55 Synapsis stage.
Fig. 56 Growth stage.
Fig. 57 First spermatocyte, equatorial plate.
Fig. 58 First spermatocyte, metakinesis.
Fig. 59 First spermatocyte, early anaphase.
Fig. 60 Second spermatocyte, equatorial plates containing eleven and twelve chromosomes.
Fig. 61 Developing sperm heads.

Listotrophus cingulatus (Fam. Staphylinidae)

- Fig. 62 Spermatogonium, metaphase, twenty-six chromosomes.
Figs. 63 and 64 First spermatocyte, metaphase.
Figs. 65 and 66 Second spermatocytes, metaphase.

Staphylinus violaceus (Fam. Staphylinidae)

- Fig. 67 Growth stage.
Figs. 68 and 69 First spermatocyte, metaphase.
Figs. 70 and 71 Second spermatocyte, metaphase.

Tetraopes tetraophthalmus (Fam. Cerambycidae)

- Fig. 72 and 73 Spermatogonia, twenty chromosomes.
Figs. 74 and 76 First spermatocytes, metaphase and metakinesis.
Fig. 77 First spermatocyte, anaphase.

Cylene robinia (Fam. Cerambycidae)

- Figs. 78 and 79 First spermatocytes, metaphase.

Epicauta cinerea (Fam. Meloidae)

- Fig. 80 Spermatogonium, twenty chromosomes
Figs. 81 and 82 First spermatocyte, metaphase.
Fig. 83 Second spermatocyte, equatorial plates of two types.

Penthe obliquata (Fam. Melandryidae)

- Fig. 84 Spermatogonium, sixteen chromosomes.
Fig. 85 First spermatocyte, metaphase.
Fig. 86 Second spermatocytes, metaphase.

N. M. STEVENS

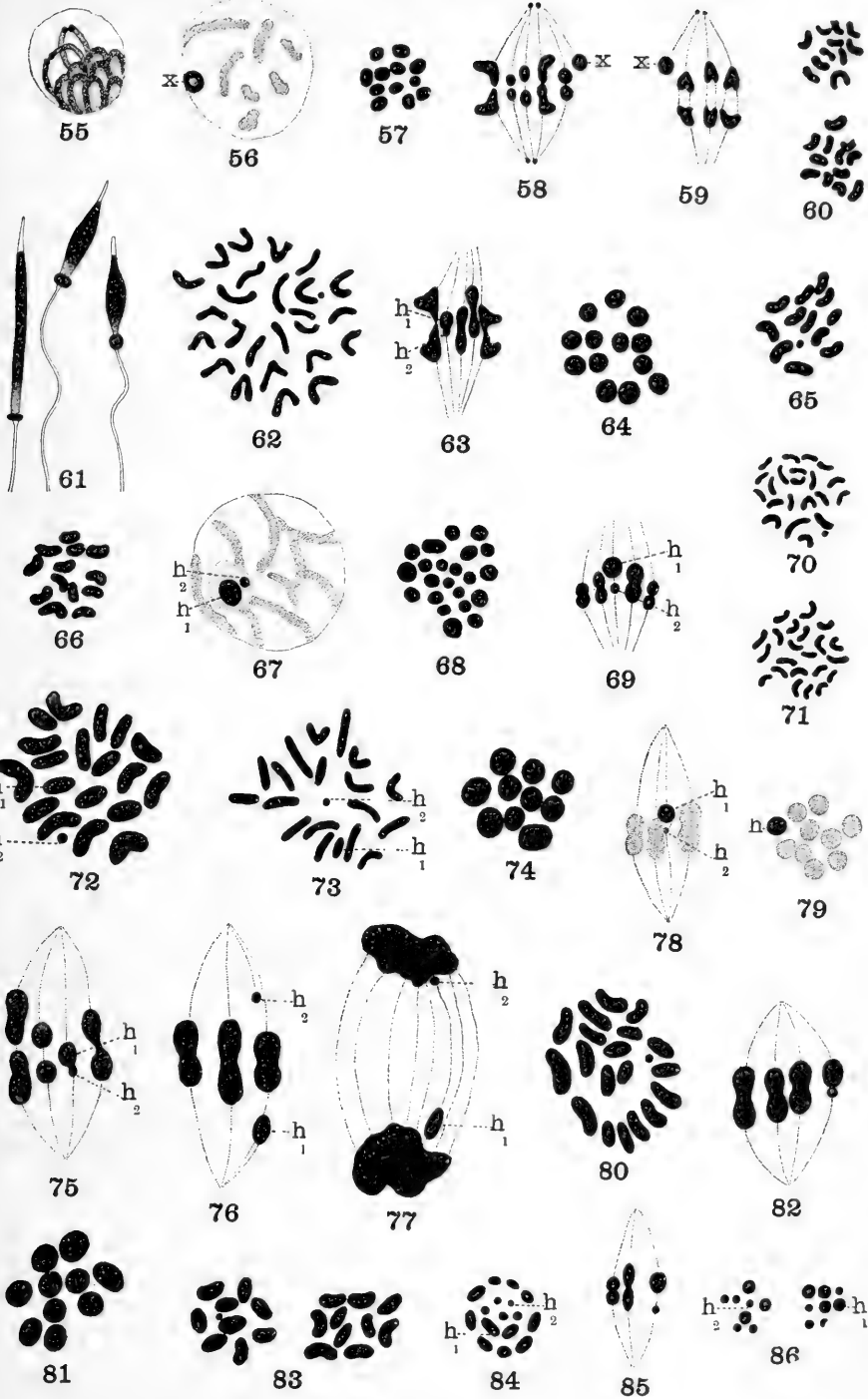

PLATE IV

Cicindela vulgaris (Fam. Cicindelidæ)

- Fig. 87 Spermatogonium, metaphase, twenty-two chromosomes.
Fig. 88 First spermatocyte, metaphase.

Lema trilineata (Fam. Chrysomelidæ)

- Fig. 89 Spermatogonium, thirty-two chromosomes.
Fig. 90 Growth stage.
Fig. 91 First spermatocyte, metaphase.
Fig. 92 Second spermatocytes, equatorial plates.

Doryphora clivicolis (Fam. Chrysomelidæ)

- Fig. 93 First spermatocyte, metaphase, seventeen bivalents, h_1 and h_2 the unequal pair of hetero-chromosomes.
Fig. 94 First spermatocyte, late prophase.
Figs. 95 and 96 Second spermatocytes, equatorial plates.

Chrysochus auratus (Fam. Chrysomelidæ)

- Fig. 97 First spermatocyte, metaphase.
Fig. 98 First spermatocyte, anaphase.
Fig. 99 First spermatocyte, equatorial plate.

Haltica chalybea (Fam. Chrysomelidæ)

- Fig. 100 Spermatogonium, metaphase, twenty-two chromosomes.
Fig. 101 First spermatocyte, prophase.
Fig. 102 First spermatocyte, later prophase.
Figs. 103 to 106 First spermatocytes, metaphase.
Fig. 107 First spermatocyte, anaphase.
Fig. 108 A pair of spermatids, early stage.

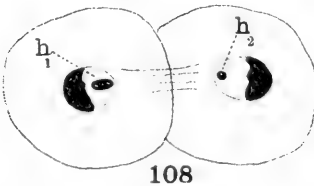
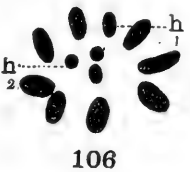
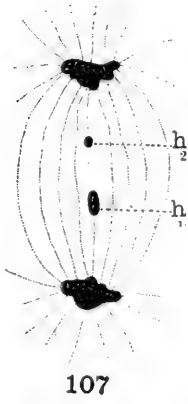
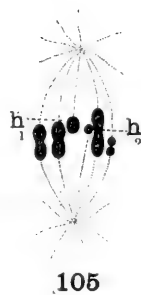
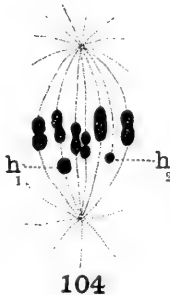
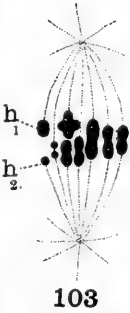
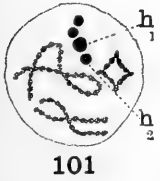
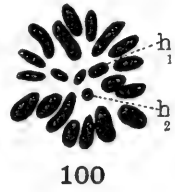
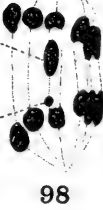
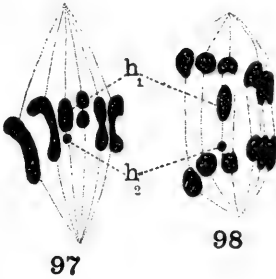
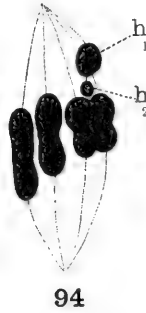
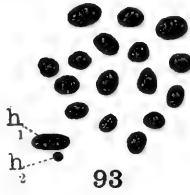
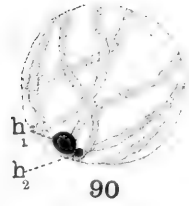
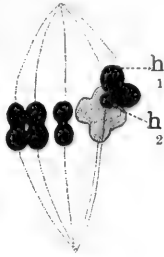
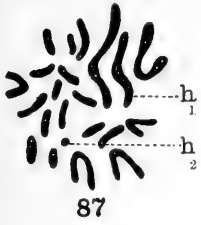

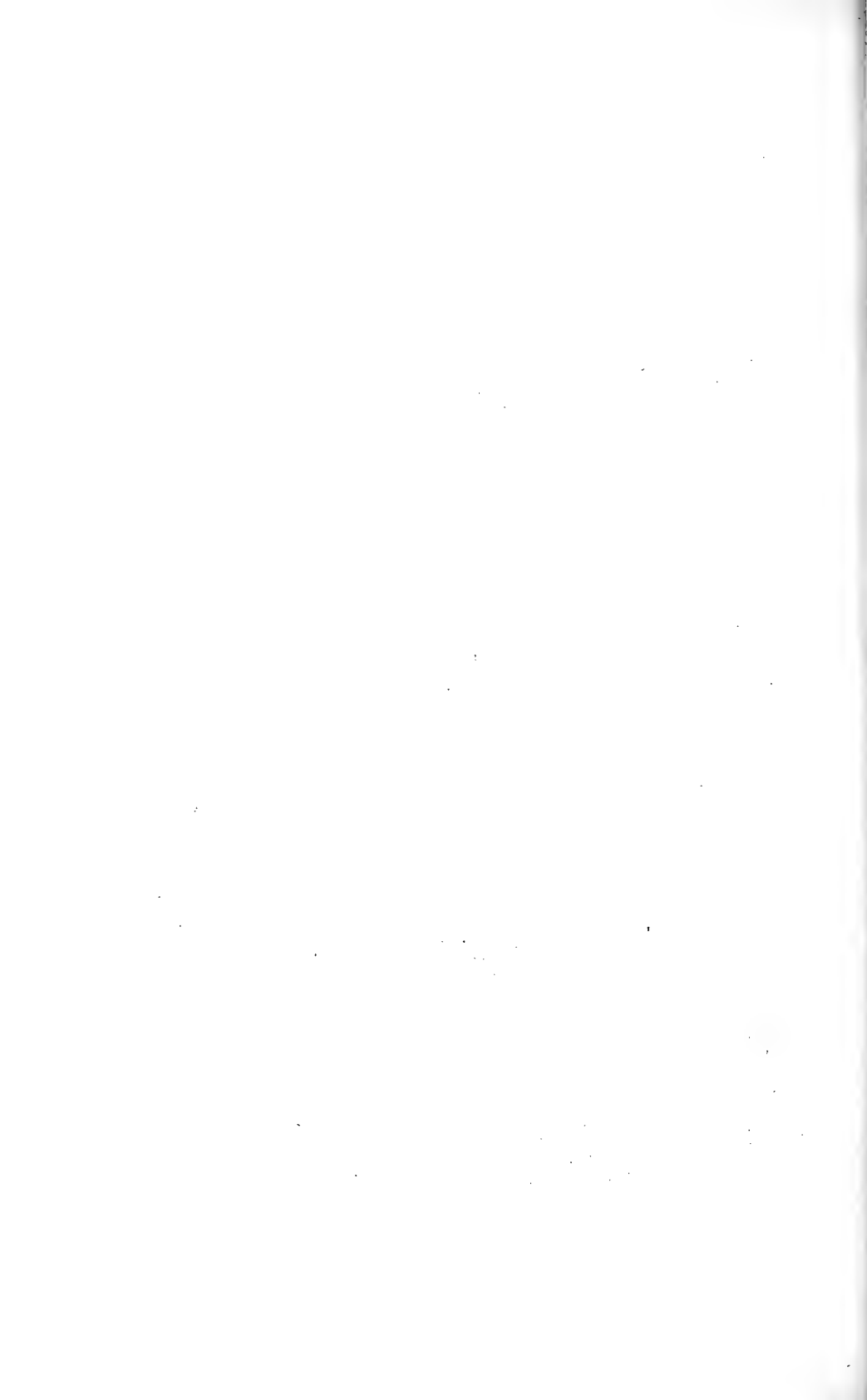

AN UNPAIRED HETEROCHROMOSOME IN THE APHIDS

BY

N. M. STEVENS

WITH TWO PLATES

In two previous papers on the germ cells of aphids ('05 and '06) the spermatocytes have been described as having no heterochromosome of any kind. In all of the aphids which have been studied, there is, however, one peculiar lagging chromosome in the first spermatocyte mitosis ('05, Pl. IV, Figs. 37 and 38; '06, Pl. I, Fig. 12; Pl. II, Figs. 33, 34, 42, 49; Pl. III, Figs. 60 and 78; Pl. IV, Figs. 100, 101, 111, 112). This chromosome appeared to be a bivalent which separated very late, giving second spermatocytes with equal series of chromosomes ('05, Pl. IV, Fig. 39; '06, Pl. I, Fig. 25).

The results recently obtained by Morgan ('08) in the study of the germ cells of *Phylloxera* (sp. ?), which has a similar lagging chromosome, have led to a reinvestigation of the matter in the aphids. In *Phylloxera* (sp. ?) Morgan finds six chromosomes in somatic cells of female embryos and five in male embryos. The first spermatocytes contain three chromosomes. The lagging chromosome, though it appears about to divide as in the aphids, does not do so, but remains in the larger of the two second spermatocytes, the cytoplasm dividing very unequally. The smaller cells, containing two chromosomes, degenerate, while the three chromosomes of the larger cells all divide, giving only one kind of spermatozoa; i. e., such as can fertilize female-producing eggs. The *Phylloxera*s, therefore, fall into the same category with the other Hemiptera homoptera described by Boring ('07), and with the Hemiptera heteroptera, Coleoptera and Orthoptera, which have an unpaired heterochromosome, the only important

difference being that one-half of the second spermatocytes degenerate, leaving only one kind of spermatozoa—those destined to unite with female-producing eggs.

These facts, which are described as quite clear for Phylloxera, are exceedingly obscure for the aphids, and not until I had gone over all of my material three times, was I able to convince myself that the lagging chromosome does not divide in the first spermatocyte, but in the telophase goes into the larger of two second spermatocytes, the smaller cell sooner or later degenerating. The earlier stages shown in previous figures indicate equal division of chromosomes and cytoplasm; and in the final division of the cell there is every possible variation of inequality. There is also great variation in different species in the smaller second spermatocytes. In some cases the chromosomes massed in the anaphase of the first spermatocyte, never separate again, and one finds these rounded clumps of chromatin with little cytoplasm among the dividing second spermatocytes, while in the youngest cysts of spermatids they have completely disappeared. In other cases the chromosomes separate and show no signs of degeneration in the second spermatocyte cysts, and they may even divide, mitosis going as far as a late anaphase, but not ending in cell division. In the latter case degeneration occurs in the younger cysts of spermatids.

A few of the most convincing cases will now be described with figures, the different aphids being designated by their host plant as in previous papers.

In the green rose aphid the anaphases (Figs. 1, 2 and 3) would not even suggest the possibility that the lagging chromosome is not equally divided between the two second spermatocytes, yet in the prophase of the second division (Fig. 4) there is a double chromosome which can be no other than the lagging one of the first division with the two parts folded together. Fig. 5 is a smaller second spermatocyte containing six chromosomes and lacking the double one. Figs. 6 and 7 are first and second spermatocyte equatorial plates, and Fig. 8 is a side view of a first spermatocyte spindle, showing the heterochromosome (*x*) not yet divided, while the other chromosomes are in early anaphase.

In the star cucumber aphid there is great variety in the ana-

phases. Early stages (Fig. 9) do not indicate any inequality. Later stages (Fig. 10) show some inequality in the size of the two cells, but the lagging chromosome still seems destined to divide. Here again, however, one finds in the prophase of the second division a double chromosome (Figs. 11 and 12) which can be accounted for only by supposing that the lagging chromosome finally pulls back into the larger cell and folds together. In this species the chromosomes can be counted in a few second spermatocyte prophases and metaphases of the smaller cells, as degeneration occurs mainly in the spermatid cysts. Figs. 12 and 13 show prophases of the two kinds of second spermatocytes, Fig. 13 being a smaller cell lacking the double chromosome. Figs. 14 and 15 are the corresponding metaphases.

Among my preparations of aphids collected from *Solidago altissima*, is one, rather lightly stained with iron hæmatoxylin, which shows one chromosome black while the others are gray, in the first spermatocyte prophases and metaphases. In the prophase stage (Fig. 16) which was mentioned in my '05 paper as a possible synizesis stage (Pl. IV, Fig. 34), the dark staining chromosome is the isolated one, and in the metaphase (Figs. 17, 18 and 19) it is single while the other five are double. There are no anaphases in this preparation. The typical anaphases found on other slides are shown in Figs. 20, 21 and 22, Fig. 22 indicating a shifting over to one of the pair of second spermatocytes of the whole of the lagging chromosome and of considerable additional cytoplasm. The prophases of the second division in this species (Fig. 18) do not show the heterochromosome (*x*) double, and the anaphases look as though it was simply pulled out at right angles to its original long axis (Figs. 20 and 21) and later (Fig. 22), the pulling being relaxed at one end, was returning to its original form. Figs. 24 and 25 are second spermatocytes in metaphase, showing five and six chromosomes, Fig. 25 being one of the very few cases where it was possible to count the chromosomes in the smaller cells.

In the reddish brown aphid from the beach goldenrod, there are anaphases of the first division in which the lagging chromosome is distinctly divided as in Fig. 26, others where it is wholly

within one prospective second spermatocyte, (Fig. 27) and all intermediate stages. In the first spermatocytes there are four large chromosomes of about equal size and two small ones (Fig. 28). In the prophase of the larger second spermatocytes one of the four large chromosomes is larger than the others (Fig. 29). This is as far as the evidence goes for this species.

On restaining a pale slide of the Harpswell willow aphid, one cyst of second spermatocytes in metaphase was found. Here the two sizes of cells could be distinguished and chromosomes counted (Figs. 30 and 31). Fig. 32 shows daughter plates of a second spermatocyte in anaphase. Figs. 33 and 34 are prophases of spermatogonial mitoses from a male embryo. Only five chromosomes could be counted. It was impossible to determine the number in metaphases in the same embryo. This material, if it could be secured in abundance, should give perfectly clear and decisive results on all points connected with the heterochromosome, but I found it only on one small willow at South Harpswell Me., and have discovered nothing like it anywhere else.

In the black aphid on the common milkweed there are four chromosomes in the first spermatocytes, the third largest staining darker in pale iron hæmatoxylin preparations (Fig. 35). Fig. 36 is an early anaphase showing two double chromosomes and the single elongating heterochromosome (*x*). Fig. 37 is a prophase from the same preparation. Figs. 38, 39 and 40 are different stages in the division of the first spermatocyte. The number in the small second spermatocytes was not clear, but in a similar aphid from the garden nasturtium these cells have three chromosomes while the larger ones have four (Fig. 41).

The woolly aphid from the beech shows well how deceptive the anaphase of the first spermatocyte can be. Fig. 42 is the stage most often seen, while Fig. 43 shows the final result of division. Figs. 44 and 45 are from the Saranac willow aphid, in which both cell and heterochromosome simulate equal division, but in the final stages of mitosis the whole heterochromosome goes over to one cell and the other cell becomes only slightly smaller.

In my '06 paper, Pl. IV, a few figures (110-113) were given for

a maple aphid having sixteen chromosomes. Fig. 47 shows a very common appearance of the telophase in this aphid, the chromosomes being massed at one pole and well separated at the other. The massed chromatin is destined to degenerate. An earlier stage (Fig. 46) shows the chromatin massed at both poles, the heterochromosomes (*x*) dividing, and the cell apparently about to divide equally or nearly so. Fig. 49 shows more inequality in the two cells, but the heterochromosome divided and one-half in each prospective cell. Fig. 48 is quite a different case. Both parts of the heterochromosome (*x*) are in the nucleus of the larger cell and the chromatin of the smaller cell is densely massed. In Fig. 49 we have another variation: the two parts of the heterochromosome have run together and are in the larger cell, but the chromosomes of the smaller cell are not massed together. A careful comparison of first and second spermatocytes in metaphase brings out the fact that while in the first spermatocyte there is one chromosome considerably larger than the others, in the second spermatocyte equatorial plate there are two larger than the others and nearly equal. One of these is the division product of the large chromosome of the first spermatocyte and the other is the undivided heterochromosome (*x*) which is second in size in the first spermatocyte (Figs. 50 and 51).

In the *Oenothera* aphid, whose male germ cells were described in my first paper on aphids ('05), the failure of the lagging chromosome to divide in the first spermatocyte is more difficult to demonstrate than in any of the other species. On a slide where there are dozens of telophases like Fig. 54, only one case could be found where the two parts of the heterochromosome were in one nucleus, leaving only four chromosomes in the other (Fig. 55). The lagging chromosome is the second in size and in several prophases of the second mitosis it appears double as shown in Fig. 56, though not so conspicuously so as in the green rose and star cucumber aphids (Figs. 4, 11 and 12). Smaller cells containing only four chromosomes and lacking this double chromosome can also be found (Fig. 57). In another preparation, which has unfortunately been lost, anaphases of the smaller second spermatocytes were seen, and such may also be distinguished among the degenerating spermatids.

With the exception of those cited for the Harpswell willow aphid (Figs. 33 and 34), I am unable to find any spermatogonia or male somatic cells in my aphid material, where the number of chromosomes can be satisfactorily counted. It is perfectly certain that the earlier parthenogenetic eggs and embryonic cells contain an even number of chromosomes—a complete double series of maternal and paternal chromosomes. The question is: Where does the mate of the unpaired heterochromosome (x) of the spermatocytes disappear? With no direct evidence at hand, my present opinion is that the two heterochromosomes must pair before the maturation of the male-producing eggs and separate in that mitosis while the other chromosomes divide longitudinally. I have never been able to find a polar spindle in male eggs; that is, in such cases as that of the *Oenothera* aphid where the males and females are produced by different mothers. There is one peculiar case, however, mentioned in my '06 paper, which may be a case in point. In one parthenogenetic individual of the orange milkweed aphid, two eggs in different embryos had only seven chromosomes (Fig. 52) in the equatorial plate of the maturation spindle, while all others had eight (Fig. 53). The two plates were very much alike, each having a large chromosome in the center, evidently corresponding to the two largest in other plates united. Unfortunately I never found any males of this species, although I continued to collect the aphids at short intervals until the plants were killed by frost; but it is possible that, as in the brown rose aphid, only a few scattering males and sexual females appear, while the parthenogenetic female generations go on until destroyed by freezing or starvation. I have found nothing else of this kind in looking over preparations of parthenogenetic individuals collected with the sexual generation, but good equatorial plates of polar spindles, cut and stained so that the chromosomes can be satisfactorily counted, are always rare in aphid material. If my surmise as to the maturation of the male-producing aphid eggs should prove to be correct, it would seem probable that these eggs develop into males because a dominant female sex-chromosome has been removed and for that reason only, since the same parthenogenetic mother aphid may contain embryos of three kinds,

parthenogenetic female, sexual female and male, of approximately the same age and therefore developing under the same conditions of temperature and nutrition. Thus Castle's ('03) theory in regard to the appearance of males among parthenogenetic insects would be realized by a slightly different method of maturation. This would bring us one step nearer the conclusion that sex and sexual characters are really represented, in the germ cells of insects at least, by the heterochromosomes.

As to the fact that the lagging chromosome of the aphids is a heterochromosome intimately connected with the phenomenon of sex determination, the present reinvestigation of the male germ cells, I think, leaves no doubt. The question as to how and when the number of chromosomes of the parthenogenetic female generations is reduced to that of the male individuals will be further investigated as soon as suitable material can be obtained.

The discovery of Morgan that only female-producing spermatozoa develop in Phylloxera, and the above corroborating facts for the aphids at once suggest the idea that in the bee and the ant an unpaired male heterochromosome may be left in the male-producing eggs after maturation, and that, as in the phylloxerans and aphids only female-producing (containing a male sex-chromosome) spermatozoa develop. The complete reduction in number of chromosomes occurring during the maturation of the egg instead of in the spermatocytes might prevent the detection of such a heterochromosome in these forms, but study of other hymenopterous insects such as *Nematus*, where in some species only females come from the parthenogenetic eggs, in other species only males, and in still others both males and females, may throw light on the problem.

In all of the other cases familiar to me, where an unpaired heterochromosome is present in the spermatocytes, if it is destined to divide in the first maturation mitosis, it is attached to mantle fibers from only one pole of the spindle. This is true for many Hemiptera homoptera (Stevens '06; Boring '07); for the Orthoptera (McClung and others) and for several of the Coleoptera (Stevens '06 and '08). On the other hand, when the odd chromosome is attached to mantle fibers from both poles of the

first spindle, it divides in the first division, as in *Anasa* and other Hemiptera heteroptera (Wilson '05, '06) and in *Photinus* (Stevens '08). In the latter case the division products of the odd chromosome make connection with only one pole of the second spindle.

In the aphids the unpaired heterochromosome is connected with fibers from both poles of the first spindle and, in most cases, until a very late anaphase or telophase, appears to be about to divide equally. Both cell and heterochromosome begin to do one thing, and finally do something quite different. One can hardly fail to be impressed with the idea that we have here a case where the karyokinetic apparatus is imperfectly adjusted to the demands made upon it by the cell as a whole or by the chromosomes, but that the end is finally attained in spite of this imperfect working of the spindle. This peculiarity in the first maturation division, it would seem, must have come in with a change from purely sexual reproduction to parthenogenetic, involving the suppression of the male-producing spermatozoa.

The apparent equal division of the lagging chromosome in anaphases of the first spermatocyte division together with the facts that there is no condensed heterochromosome in growth stages of the spermatocytes and that all of the chromosomes of the second spermatocytes certainly divide longitudinally ('05, Pl. IV, Fig. 41; '06, Pl. II, Fig. 50; Pl. IV, Figs. 108 and 109) led to the conclusion that there was no heterochromosome in the aphids. The late shifting over of the whole lagging chromosome and a variable amount of cytoplasm into one of each pair of second spermatocytes, together with the significance of the smaller degenerating cells were overlooked until the preparations were reexamined in the light of Morgan's results on *Phylloxera*. This experience with the germ cells of the aphids indicates the probability that a sex-determining differentiation of chromosomes in the male germ cells may exist in other cases where it has not yet been detected because of a large number of small chromosomes, or of some unexpected peculiarity in the behavior of the heterochromosomes.

I desire to express here my indebtedness to Prof. T. H. Morgan for urging a reinvestigation of my aphid material, and also

for allowing this paper to appear in advance of his more elaborate paper on the germ cells of the phylloxerans.

Bryn Mawr College
May 20, 1908

LITERATURE CITED.

- BORING, A. M. '07—A Study of the Spermatogenesis of Twenty-two Species of Membracidæ, Jassidæ, Cercopidæ and Fulgoridæ. *Jour. Exp. Zoöl.*, vol. iv.
- CASTLE, W. E. '03—The Heredity of Sex. *Mus. Comp. Zoöl.*, Harvard, No. 137.
- MORGAN, T. H. '08—The Production of two kinds of Spermatozoa in Phylloxerans—Functional "Female Producing" and Rudimentary Spermatozoa. *Proc. Soc. for Exp. Biol. and Med.*, vol. v, no. 3.
- STEVENS, N. M. '05—A Study of the Germ Cells of *Aphis rosae* and *Aphis ænotheræ*. *Jour. Exp. Zoöl.*, vol. ii.
- '06—Studies on the Germ Cells of Aphids. *Carnegie Inst.*, Wash., Pub. 51.
- '06—Studies in Spermatogenesis. II. A Comparative Study of the Heterochromosomes in Certain Species of Coleoptera, Hemiptera and Lepidoptera, with Especial Reference to Sex Determination. *Carnegie Inst.*, Wash., Pub. 36, no. 2.
- '08—The Chromosomes in *Diabrotica vittata*, *Diabrotica soror* and *Diabrotica 12-punctata*. *Journ. Exp. Zoöl.*, vol. v, no. 4.
- '08—Further Studies on the Chromosomes of the Coleoptera. *Jour. Exp. Zoöl.*, vol. vi, no. 1.
- WILSON, E. B. '05—Studies on Chromosomes. II. The paired Microchromosomes, Idiochromosomes, and Heterotropic Chromosomes in the Hemiptera. *Jour. Exp. Zoöl.*, vol. ii.
- '06—Studies on Chromosomes. III. Sexual Differences of the Chromosome Groups in Hemiptera, with some Considerations on Determination and Inheritance of Sex. *Jour. Exp. Zoöl.*, vol. iii.

DESCRIPTION OF PLATES

The figures were all drawn with a Zeiss 1.5 mm. oil immersion objective and a Zeiss compensating ocular 12. The magnification was doubled with a drawing camera, and the plates reduced one-half, giving a magnification of 2000 diameters.

Lettering on Plates

p = a plasmosome

x = the unpaired heterochromosome

PLATE I

Green rose aphid

- Figs. 1 to 3 First spermatocyte, anaphase.
- Fig. 4 Second spermatocyte, large, prophase, seven chromosomes.
- Fig. 5 Second spermatocyte, small, prophase, six chromosomes.
- Fig. 6 First spermatocyte, metaphase.
- Fig. 7 Second spermatocyte, metaphase.
- Fig. 8 First spermatocyte, metakinesis.

Star cucumber aphid

- Fig. 9 First spermatocyte, early anaphase.
- Fig. 10 First spermatocyte, telophase.
- Figs. 11 and 12 Second spermatocyte, large, prophase, five chromosomes.
- Fig. 13 Second spermatocyte, small, prophase, four chromosomes.
- Fig. 14 Second spermatocyte, large, metaphase, five chromosomes.
- Fig. 15 Second spermatocyte, small, metaphase, four chromosomes.

*Aphid from *Solidago altissima**

- Fig. 16 First spermatocyte, prophase, possibly a synizesis stage.
- Fig. 17 First spermatocyte, metaphase.
- Figs. 18 and 19 First spermatocyte, lateral view of chromosomes in metaphase.
- Fig. 20 First spermatocyte, anaphase.
- Figs. 21 and 22 First spermatocyte, telophase.
- Fig. 23 Second spermatocyte, large, prophase, six chromosomes.
- Fig. 24 Second spermatocyte, large, metaphase, six chromosomes.
- Fig. 25 Second spermatocyte, small, metaphase, five chromosomes.

Aphid from beach goldenrod

- Fig. 26 First spermatocyte, anaphase.
- Fig. 27 First spermatocyte, telophase.
- Fig. 28 First spermatocyte, metaphase.
- Fig. 29 Second spermatocyte, large, prophase, six chromosomes.

N. M. STEVENS

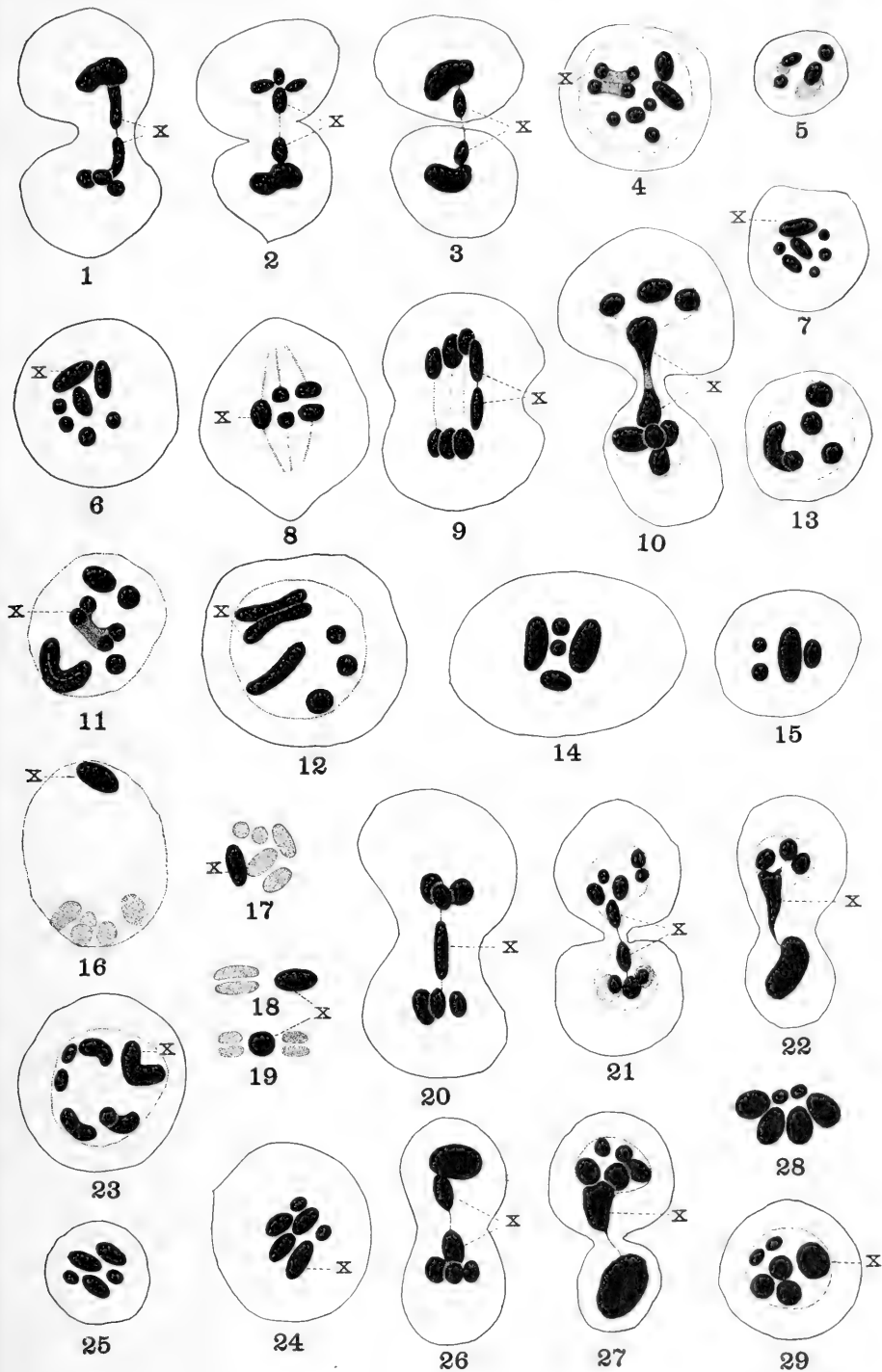

N. M. S. del.

PLATE II

Harpwell willow aphid

- Fig. 30 Second spermatocyte, large, metaphase, three chromosomes.
Fig. 31 Second spermatocytes, small, metaphase, two chromosomes.
Fig. 32 Second spermatocyte, daughter plates.
Fig. 33 Spermatogonium nucleus, prophase.
Fig. 34 Similar prophase, drawn at two foci in same section, five chromosomes.

Black milkweed aphid

- Fig. 35 First spermatocyte, metaphase.
Fig. 36 First spermatocyte, metakinesis.
Fig. 37 First spermatocyte, prophase.
Fig. 38 First spermatocyte, anaphase.
Figs. 39 and 40 First spermatocyte, telophase.
Fig. 41 Second spermatocytes, small, of a similar nasturtium aphid, three chromosomes.

Woolly beech aphid

- Fig. 42 First spermatocyte, anaphase.
Fig. 43 First spermatocyte, telophase.

Saranac willow aphid

- Figs. 44 and 45 First spermatocyte, telophase, two stages.

Maple aphid

- Fig. 46 First spermatocyte, anaphase.
Figs. 47 to 49 First spermatocyte, telophase, three common types or stages.
Fig. 50 First spermatocyte, metaphase.
Fig. 51 Second spermatocyte, metaphase.

Orange milkweed aphid

- Fig. 52 Equatorial plate of maturation spindle of parthenogenetic egg, exceptional case with seven chromosomes.
Fig. 53 Usual case with eight chromosomes.

Aphis anothéræ

- Fig. 54 First spermatocyte, an early telophase.
Fig. 55 First spermatocyte, later telophase, with the divided heterochromosome (x) in one nucleus.
Fig. 56 Second spermatocyte, large, prophase, five chromosomes.
Fig. 57 Second spermatocyte, small, four chromosomes.

N. M. STEVENS

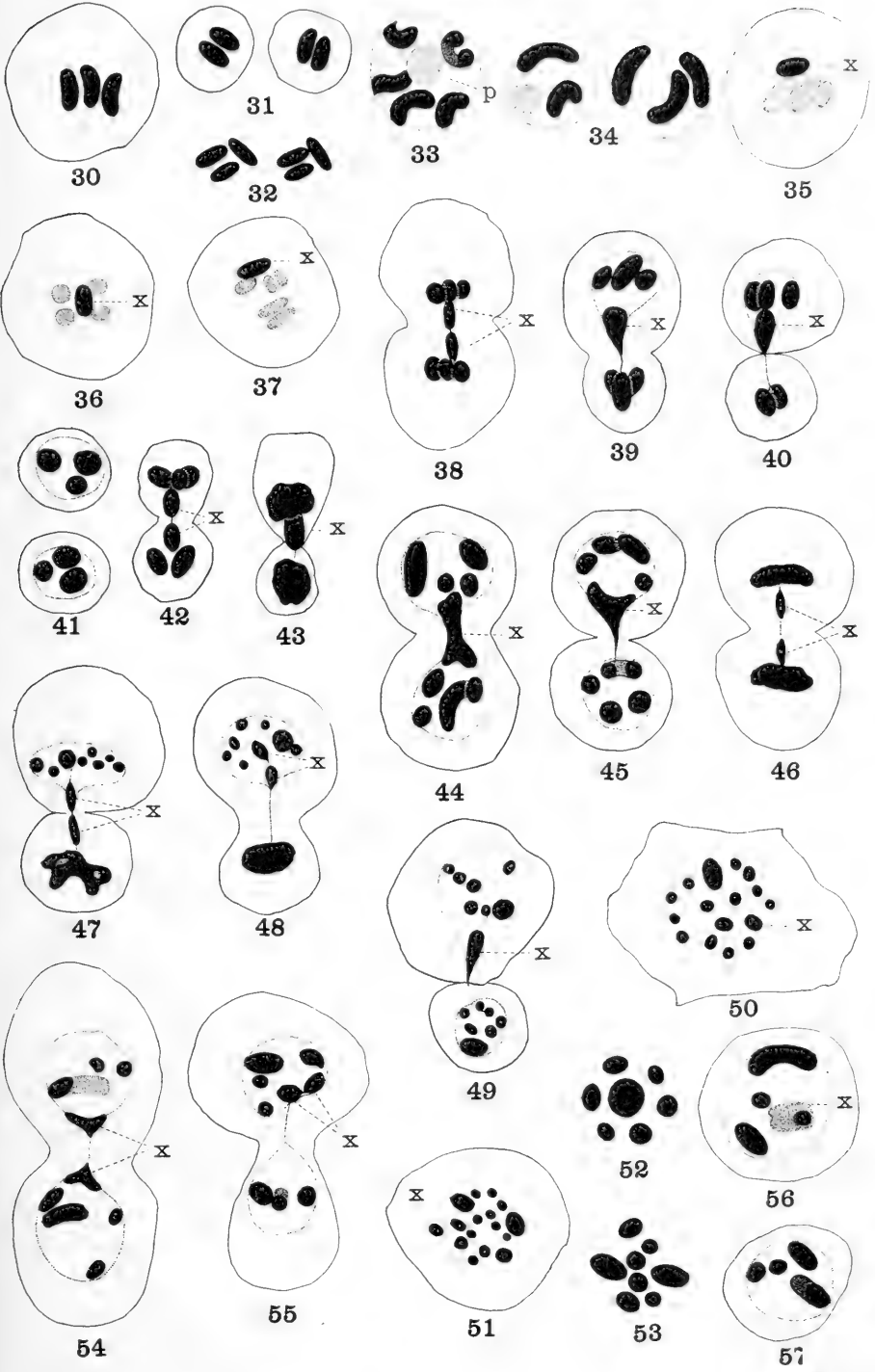

N. M. S. del



THE EFFECT OF A CENTRIFUGAL FORCE UPON THE DEVELOPMENT AND SEX OF PARTHENO- GENETIC EGGS OF HYDATINA SENTA

BY

DAVID DAY WHITNEY

WITH ONE PLATE

I	Introduction.....	125
II	Relation of the first cleavage plane to the stratification of the material of eggs centrifuged when the germinal vesicle is intact.....	126
III	Relation of the first cleavage plane to the stratification of the material of eggs centrifuged when the maturation spindle is present.....	127
IV	Condition of the young animals which developed from centrifuged eggs.....	128
V	The proportion of male and female producing females in the first, second and third generations after centrifuging.....	130
VI	General discussion.....	133
VII	Summary.....	134
VIII	Literature.....	135

I. INTRODUCTION

The eggs of *Hydatina senta* are very favorable for experiments with the centrifugal machine. The adult females which contain eggs in stages up to and including the first maturation spindle may be centrifuged at the rate of twenty thousand revolutions in two to three minutes without any apparent injury. The animal is so transparent that the eggs can be seen immediately after centrifuging and their condition recorded. The materials in the egg are separated into three distinct zones, a pink zone, a middle clear zone and a gray zone. This stratified material only becomes partly redistributed in the egg before cleavage and sometimes scarcely any redistribution takes place. After the egg is laid the polar body is formed and the first cleavage appears in thirty-five to forty-five minutes. The eggs develop within forty-eight to seventy-two hours and produce in most cases normal embryos.

The following experiments and observations were made at the suggestion and under the supervision of Prof. T. H. Morgan.

II RELATION OF THE FIRST CLEAVAGE PLANE TO THE STRATIFICATION OF THE MATERIAL OF EGGS CENTRIFUGED WHEN THE GERMINAL VESICLE IS INTACT

If several hundred animals are centrifuged at the same time and are examined immediately many can be seen to contain eggs, the contents of which are sharply differentiated into three zones. As the animals are thrown down during the centrifuging process in any position the stratification of the eggs may lie in any relation to the median longitudinal axis of the female. The pink zone may be toward the head or foot of the animal, toward the side next the stomach or on the opposite side, or in any other intermediate position. The gray zone is always on the opposite side of the egg from the pink zone and the middle zone between the two. The germinal vesicle is found at the junction of the clear middle and pink zones and can be easily recognized owing to its large size (Fig. 1).

From the various lots of females, centrifuged twenty thousand revolutions, eight were selected containing the pink zone toward the head of the animal and the gray zone toward the foot. The germinal vesicle was plainly visible near the line between the clear middle and pink zones.

Each of these eggs was carefully watched while it remained in the oviduct of the female as well as after it was laid. In every egg the first cleavage appeared at that end of the egg which contained the pink pigment. The first division was unequal as it is in the normal egg. In some cases all the pink zone was cut off in the smaller cell while in other cases only a part of it was included in this cell. The gray zone was always included in the larger cell.

Six other females which had the pink zone of the egg toward the foot of the animal and the gray zone toward the head were isolated and the further history of each egg was carefully followed.

The first cleavage in all these eggs appeared in the end which contained the pink material.

It is hardly possible that in these fourteen eggs the pink material and the germinal vesicle were driven in each case to the animal pole. If this assumption is correct these two lots of eggs indicate that the position of the first cleavage is determined by the induced position of the germinal vesicle at either end of the egg. When, however, the germinal vesicle is carried to the side of the egg with the pink material, that is, when it comes to lie midway between the two ends of the egg, it moves later toward one of the ends of the egg since the first cleavage in such cases is at one end.

III RELATION OF THE FIRST CLEAVAGE PLANE TO THE STRATIFICATION OF THE MATERIAL OF EGGS CENTRIFUGED WHEN THE MATURATION SPINDLE IS PRESENT

Some of the centrifuged females were found containing eggs stratified into the three characteristic zones but showing the maturation spindle apparently at the side of the egg, where it normally forms, in the clear middle zone (Fig. 2).

In cases where the pink zone was in the end of the egg toward the head of the animal the first cleavage sometimes appeared in that end of the egg and cut off the pink zone in the small cell. At other times it appeared at the opposite end of the egg and included the gray zone in the small cell. In other cases where the gray zone was in the end of the egg toward the head of the animal the first cleavage sometimes appeared in that end but at other times it appeared in the opposite end of the egg. When the eggs were centrifuged so that the stratification was from side to side, instead of from end to end the first cleavage usually cut off a part of each of the three zones in each cell.

Apparently the first cleavage appeared at that end of the egg nearest to the maturation spindle irrespective of the stratified zones of the egg.

IV CONDITION OF THE YOUNG ANIMALS WHICH DEVELOPED FROM CENTRIFUGED EGGS

If the materials of the egg which are differentiated into zones by the centrifugal force are important formative substances their displacement and their different location in the first cleavage stage ought to cause abnormalities in the embryos and in the mature animals which develop from such eggs.

The following experiments which are only a few of those carried out will serve to indicate to what extent the embryos from centrifuged eggs were affected by the displacement of the materials.

Experiment I. January 11, 1908, at 8:30 p.m., many females were centrifuged about twenty thousand revolutions and then placed in a watch glass containing tap-water and allowed to lay their eggs. At 10 p.m., thirty-seven eggs were isolated.

January 13, at 9:30 a.m., there were in the dish thirty-two apparently normal young females, three winter eggs and two dead parthenogenetic eggs.

Experiment V (Control). January 21, at 10 p.m., two hundred and eighty eggs that had been laid by females which had not been centrifuged were isolated in a watch glass containing tap-water.

January 22, at 8 p.m., two hundred and forty normal young animals were removed from the dish.

January 23, at 11 a.m., six normal young removed and of the thirty-four unhatched eggs which remained thirty-one were winter eggs and three were dead parthenogenetic eggs.

Experiment XI. March 14, 7:45 p.m., several hundred females were taken from the culture jar and placed in a watch glass containing tap-water. No eggs had been laid by 8 p.m. These animals furnished material for the following experiments.

Lot A. At 8:35 p.m., twenty-five eggs which had been laid since 8 p.m., were isolated and centrifuged twenty thousand revolutions.

March 15, at 12:40 p.m., sixteen young normal females were taken out of the dish and nine unhatched eggs remained. At 9 p.m. the nine eggs were still unhatched. March 16, at 10 a.m., two of

the eggs had hatched. Of the seven remaining eggs one was a winter egg, three were dead parthenogenetic eggs and the other three contained living embryos which were apparently unable to break through the egg envelope.

Lot B. March 14, at 8:40 p.m., twenty eggs were isolated and allowed to remain undisturbed. At 9:10 p.m., these eggs were centrifuged in the same way and treated as Lot A. March 15, at 1:30 p. m., seventeen young normal females were in the dish and three unhatched eggs which contained living embryos. At 9 p.m., two of these eggs had produced normal females but the other was still unhatched.

Lot C. March 14, at 8:45 p.m., thirty eggs were isolated and allowed to remain undisturbed. At 9:45 p.m., these eggs, in some of which the first cleavage and in others the second and third cleavage had appeared, were centrifuged and treated as Lot A.

March 15, at 1:40 p.m., fourteen normal young females were removed from the dish and sixteen unhatched eggs remained. At 9 p.m., seven other normal young females were removed.

March 16, at 10 a.m., two other normal young females were removed. Seven eggs remained. One was a winter egg, two were dead parthenogenetic eggs and four contained living embryos.

Lot D (Control). March 14, at 10:30 p.m., thirty-three eggs were isolated.

March 15, at 12:30 p.m., thirteen normal young females and two normal young males were removed from the dish. At 9 p.m., seventeen other normal young females and one normal young male were removed.

In Experiment I the eggs were centrifuged when they contained the germinal vesicle or else the maturation spindle. In Experiment XI, Lot A, they were centrifuged in the stage when the polar body is forming or just after it was formed. In Lot B the eggs were centrifuged just before the first cleavage and in Lot C during and after the first cleavage.

In some of these experiments the young animals which developed from the centrifuged eggs seem to die sooner if not fed than do the animals developing from normal eggs. Also there

are more cases of the embryos unable to get out of the egg after they are fully formed. They can be seen writhing and twisting inside the egg and sometimes lived there as long as seven days.

These cases of abnormalities were due perhaps to the food material in the egg being displaced and therefore unable to nourish certain muscles which are well supplied with food material in the normal embryo. Consequently the young animal was weaker in certain parts of its body.

In a few cases the eggs began to develop but apparently soon ceased and never produced embryos which showed any ciliary movement. In normal embryos the ciliary movement around the head can be seen several hours before hatching. Whether the early death of such eggs is due to abnormal cleavage, misplaced egg substance, or misplaced chromosomes in division is not clear.

It is nevertheless apparent from these experiments that a very high percentage of normal young animals develop from eggs that have been centrifuged in the various stages of their early development.

V THE PROPORTION OF MALE AND FEMALE PRODUCING FEMALES IN THE FIRST, SECOND AND THIRD GENERATIONS AFTER CENTRIFUGING

If the dislocation of the egg substances has any influence on sex it should become evident by following the history of individual eggs in which the zones of stratification are differently arranged in their relation to the first cleavage plane.

The following data give the result of experiments carried out to examine the question.

Experiment XXXI. March 5, at 2:15 p.m., a female containing a large egg was centrifuged twenty thousand revolutions. At 3:10 p.m., the egg had been laid and was in the first cleavage stage. The pink zone was entirely included in the smaller cell (Fig. 3).

On March 6, at 11 a.m., a normal young female was swimming about in the dish. Food was then added. She produced eggs

and on March 8, at 10 a.m., four young daughter-females were present in the dish. This female produced twenty-nine eggs which developed into females. Two of these daughter-females matured and produced males and twenty-seven matured and produced females.

Experiment XXXIII. The conditions, size of egg, and the arrangement of egg material in the first cleavage were approximately the same as in Experiment XXXI. A normal young female developed from the egg, matured and produced males.

Experiment XXXVII. March 5, at 2:15 p.m., a female containing a large egg was centrifuged. At 4:30 p.m., the egg that had been laid was in the first cleavage stage. The small cell included portions of the pink and clear zones, Fig. 4.

On March 6, at 11 a.m., a normal young female was swimming about in the dish. Food was added. This female grew to maturity and produced twenty-five eggs, all of which developed into females. One of these daughter-females matured and produced males and twenty-four matured and produced females.

Experiment XLIV. The conditions, size of egg, and the arrangement of the egg material in the first cleavage were approximately the same as in Experiment XXXVII. A normal young female developed from the egg, matured and produced twenty-five eggs, all of which developed into female-laying females. In later generations males appeared.

Experiment XXXII. March 5, at 2:15 p.m., a female containing a large egg was centrifuged. At 3:30 p.m., an egg had been laid and was in the first cleavage stage. The small cell included portions of the three zones (Fig. 5).

On March 6, at 9 a.m., a normal young female was present in the dish. Food was added. This female matured and produced only three eggs. One of these eggs developed into a male-laying female and the other two developed into female-laying females. This small production of eggs was due to the scanty amount of food given to the female.

Experiment L. March 10, 1 p.m., a female containing a large egg was centrifuged. At 3 p.m., the egg had been laid and was in the first cleavage stage. The small cell contained about two-

thirds of the gray zone and a portion of the clear zone (Fig. 6). On March 11, at 11 a.m., a normal young female was swimming about in the dish. Food was added. This female matured and produced fifteen eggs which developed into females. One of these daughter-females produced males and the other fourteen produced females.

Experiment LV. The conditions, size of egg and the arrangement of the egg material in the first cleavage were approximately the same as in Experiment L. A normal young female developed from the egg, matured and produced fourteen eggs all of which developed into female-laying females. In later generations males appeared.

Several small male eggs were centrifuged in the same manner as the large eggs. In some of these the first cleavage plane appeared so as to cut off all the pink zone in the small cell and in others it cut off some of each of the three zones. In both cases apparently normal males were produced.

None of the females in the above experiments produced the normal number of eggs, which is forty to fifty, because of poor food conditions.

In former experiments it has been shown that the percentage of male-laying females in a family of daughter-females may vary from 0 to 50 per cent and also that the percentage of male-laying females in one generation is no indication what it may be in the next generation.

Experiments XXXI to LV. In these experiments the appearance of male-laying females from the various forms of centrifuged eggs does not seem to be markedly different from normal cases. In the experiments where the daughter-females of a family were all female-laying females males always appeared in the later generations, thus showing that no pure female-laying female strains were produced. Moreover, large (female) eggs never produced male animals nor did small (male) eggs ever produce female animals.

GENERAL DISCUSSION

Lyon has found in the eggs of the sea-urchin, *Arbacia*, that the first cleavage plane is always at right angles to the plane of stratification of the egg material.

Lillie has shown that the stratification, caused by centrifuged force, of the material in the egg of *Chætopterus* plays no part in determining the position of the polar lobe. When the germinal vesicle is still intact the egg has a well defined polarity, that is, one end is the animal and the other end the vegetative pole. If the germinal vesicle is driven to the vegetative pole the polar spindle which develops from it always migrates to the animal pole and there forms the polar bodies.

In later work on sea-urchin's eggs Morgan and Lyon show that, "while the cleavage conforms strictly to the induced stratification, the gastrulation does not conform to the symmetrical arrangement of the materials. The exceptional cases show that there is no necessary relation between stratification of the materials as such and the embryonic axes."

However, in the eggs of *Cumingia* Morgan has shown that the stratification of the egg material does not influence the position of the first cleavage plane. He says, "This difference is due to the shifting of the nucleus in the egg of the sea-urchin, while the spindle in *Cumingia* retains its original orientation."

It must be borne in mind that the above results were obtained from eggs centrifuged at different stages in their maturation. The eggs of *Chætopterus* were centrifuged when in the germinal vesicle and maturation spindle stages, while the eggs of *arbacia* were centrifuged when in the female pronucleus stage. The eggs of *Cumingia* were also centrifuged when in the maturation spindle stage and those of *Hydatina* in the germinal vesicle stage as well as in the maturation spindle stage.

When the eggs of these different animals are centrifuged in the maturation spindle stage the spindle is not usually moved from its original position and consequently the first cleavage take place precisely as it does in normal eggs.

When the eggs of *Chætopterus* and *Hydatina* are centrifuged

in the germinal vesicle stage the later histories of the germinal vesicles differ. In the egg of *Chætopterus* the maturation spindle which develops from the germinal vesicle, according to Lillie, migrates to the animal pole if it does not happen to be located at that pole, while in *Hydatina* the maturation spindle never migrates from the end of the egg into which the germinal vesicle is driven by the centrifugal force. In the egg of *Arbacia* the female pronucleus may be so oriented by centrifugal force that the direction of the first cleavage plane is due rather to its location and follows in consequence the stratification of the materials in the egg.

None of the previous workers have reared the embryos from centrifuged eggs to maturity because the forms upon which they worked were not suitable for such experiments but *Hydatina* is an exceptionally favorable form for such work.

Eggs were centrifuged in various stages of maturation so that the zones of egg materials were differently arranged in their relation to the first cleavage plane, thus making it possible that in some cases the pink material of the egg would be included in the cells that make up the anterior end of the embryo while the gray material would be included in the cells of the foot region or vice-versa. In other cases the material would be more or less equally distributed in the anterior and posterior regions of the embryo.

In no case was the sex of the eggs changed and such eggs produced a very high percentage of normal young males and females. Furthermore the young females grew to adult animals and produced normal offspring of which the sex ratio was apparently normal.

It would, therefore, seem that the effect of centrifugal force upon the eggs of *Hydatina senta* is not sufficient to cause any noticeable change of structure or of sex in the animals that develop from them.

VI SUMMARY

1 When the unsegmented eggs of *Hydatina senta* are centrifuged twenty thousand revolutions the materials in the eggs are stratified into a pink zone, a clear middle zone and a gray zone.

2 If eggs are centrifuged a short time before maturation when the nucleus is intact the nucleus is carried to the top of the clear zone against the bottom of the pink zone.

3 Very little redistribution of the egg materials takes place before the first cleavage. In consequence the segmented egg retains the distribution of materials impressed on it by the centrifugal force.

4 The first cleavage plane always appears at that end of the egg at which the pink zone and germinal vesicle are located. It forms across one end as in the normal egg separating a smaller and a larger cell.

5 The egg centrifuged after the polar spindle has formed shows that the spindle does not move from its original position. Its location determines the position of the first cleavage plane in so far as this appears at the end of the egg nearest to where the spindle lies.

6 Normal animals, both males and females, develop from centrifuged eggs and these have been reared to sexual maturity.

7 The sex of animals developing from large (female) or small (male) eggs is not affected by the centrifugal force nor is the sex ratio in the descendants of females developing from centrifuged eggs altered.

Zoölogical Laboratory

Columbia University

April 25, 1908

LITERATURE

- HERTWIG, O. '97—Ueber einige am befruchteten Froschei durch Centrifugalkraft hervorgerufene Mechanomorphosen. Sitzungsber. preuss. Akad. Wiss. Berlin, math-phys. Klasse.
- '99—Beiträge zur experimentellen Morphologie und Entwicklungsgeschichte. 4. Ueber einige durch Centrifugalkraft in der Entwicklung des Froscheies hervorgerufene Veränderungen. Arch. f. mikr. Anat., liii.
- '04—Wietere Versuche über den Einfluss der Centrifugalkraft auf die Entwicklung tierischer Eier. Arch. f. mikr. Anat., lxiii.
- LILLIE, F. '06—Observations and Experiments Concerning the Elementary Phenomena of Embryonic Development in Chætopterus. Journ. Exp. Zoöl., vol. iii.

- LYON, E. P. '06—Some Results of Centrifugalizing the Eggs of *Arbacia*. *Amer. Journ. Physiol.*, xv.
- MORGAN, T. H. '06—The Influence of a Strong Centrifugal Force on the Frog's Egg. *Arch. f. Entw. Mech.*, xxii.
- '07—The Effect of Centrifuging the Eggs of the Mollusc, *Cumingia*. *Science*, n. s., vol. xxvii, no. 680, pp. 66-67.
- MORGAN AND LYON '07—The Relation of the Substances of the Egg, separated by a Strong Centrifugal Force, to the Location of the Embryo. *Arch. f. Entw.-Mech.*, xxiv.
- WETZEL, G. '04—Centrifugalversuch an unbefruchteten Eiern von *Rana fusca*. *Archiv. f. mikr. Anat.*, lxiii.

DESCRIPTION OF PLATE

Fig. 1 Section of a centrifuged egg, showing the three zones and the germinal vesicle located near the boundary of the pink and the clear zones. Gilson mercurio-nitric fixing fluid and Heidenhain's iron hæmatoxylin stain.

Fig. 2 Section of a centrifuged egg showing the three zones and the maturation spindle in the clear zones. Yolk granules are lodged against the achromatic figure. Bouin's fixing fluid and Heidenhain's iron hæmatoxylin stain.

Figs. 3 to 6 Free hand semi-diagrammatic drawings of living eggs in the first cleavage stage which were centrifuged when in the oviducts of the females. The fine stippling shows the position of the pink zone, the coarser stippling shows the position of the gray zone, and the clear space indicates the clear zone.

Fig. 3 Experiment XXXI—The pink zone included in the small cell and the gray and clear zones are in the larger cell.

Fig. 4 Experiment XXXVII—About one-half of the pink zone and a portion of the clear zone included in the small cell and the other part of the pink zone, all the gray zone, and a part of the clear zone are included in the larger cell.

Fig. 5 Experiment XXXII—Portions of each of the three zones in each of the two cells.

Fig. 6 Experiment L—About two-thirds of the gray zone included in the small cell while the other third of the gray zone together with all of the pink zone and nearly all of the clear zone are included in the larger cell.

EFFECT OF A CENTRIFUGAL FORCE UPON DEVELOPMENT AND SEX

DAVID DAY WHITNEY

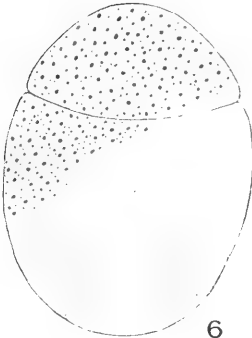
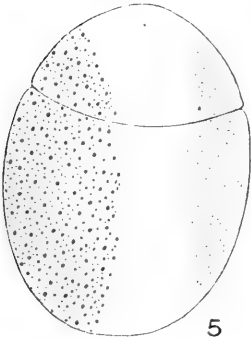
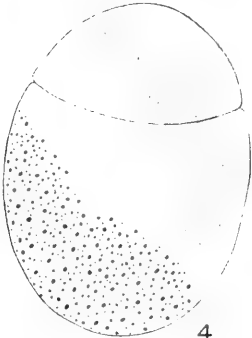
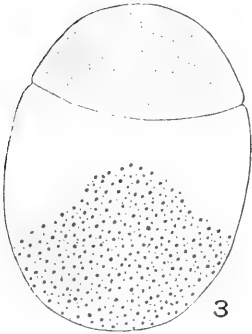
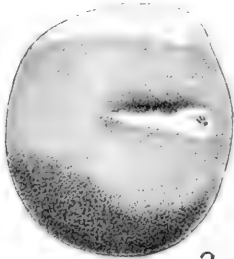
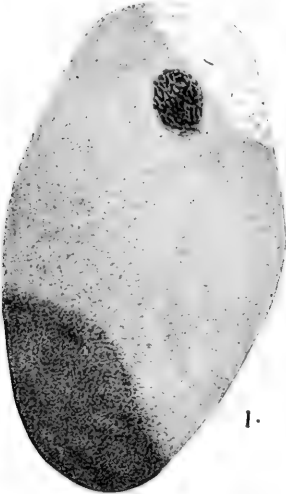



OBSERVATIONS ON THE MATURATION STAGES OF THE PARTHENOGENETIC AND SEXUAL EGGS OF HYDATINA SENTA

BY

DAVID DAY WHITNEY

I	Introduction.....	137
II	Material and methods.....	138
III	Female egg.....	140
IV	Male egg.....	141
V	Winter egg.....	142
VI	General discussion.....	143
VII	Summary.....	144
VIII	Literature.....	145

I INTRODUCTION

Despite the experiments that have been carried out by several workers to discover how sex is determined in parthenogenetic eggs the attempts to show that such external factors as temperature or food influence the result do not appear to have been successful. Attention has turned more recently to the possibility that there are internal factors in the eggs that are all-important in producing males or females.

As early as 1845 Dzierzon brought forward very strong evidence to show that the eggs of the honey-bee, *Apis mellifica*, always develop into males if unfertilized, but if fertilized they develop into females (queens or workers). In other words, internal rather than external agents bring about the result. This theory has been often attacked and strongly defended, and now seems to be generally accepted.

In the aphids Balbiani and Stevens find that the same female may produce both male parthenogenetic and fertilized or winter eggs. Lauterborn finds the same phenomenon in the Rotifer, *Asplanchna*, and Issakowitsch in a Daphnid. Whether the eggs that are fertilized are originally male eggs or develop from a dif-

ferent part of the ovary is not certain, but the evidence seems to indicate that they are male eggs.

In the two kinds of parthenogenetic eggs of some of the aphids Stevens finds that there is no reduction in the number of the chromosomes during the formation of the polar body. Lenssen, in a study of the parthenogenetic eggs of the Rotifer, *Hydatina senta*, finds that there is a reduction in the number of the chromosomes during the formation of the polar body in the male egg but no reduction in the female egg.

Weismann found that both kinds of parthenogenetic eggs of *Polyphemus* (Daphnid), certain Ostracods and Rotifers produced only one polar body while the fertilized eggs produced two polar bodies. Blochmann and Stevens found the same relation to hold for certain aphids.

In *Lisparis dispar*, a parthenogenetic Lepidopteran, Platner found that two polar nuclei were formed. In the bee *apis*, Blochmann, Paulcke, Petrunckewitsch and others find that the parthenogenetic eggs which develop into male animals give off two polar bodies. In the Rotifer, *Asplanchna*, Mrazek, Erlanger and Lauterborn found that the female parthenogenetic egg gave off one polar body and that the male parthenogenetic as well as the fertilized egg gave off two polar bodies. In the parthenogenetic eggs of *Hydatina senta* Lenssen thought that the male egg gave off one polar body and the female egg gave off none!

At the suggestion and under the supervision of Prof. T. H. Morgan the following work upon the eggs of *Hydatina senta* was done with the view of obtaining more light upon the maturation stages and their relation to the determination of sex.

I am also indebted to Prof. E. B. Wilson for many valuable suggestions and criticisms.

II MATERIAL AND METHODS

The Rotifers were collected and reared in cultures as described in a former paper.

The first maturation spindle is formed before the egg is laid and in order to study the early maturation stages animals con-

taining eggs were killed and fixed in masses of thousands and sectioned in toto. Many eggs were found in the desired stages, but as the eggs are filled with yolk granules of various sizes it was exceedingly difficult to find many sections in which the yolk granules were not mingled with the chromosomes.

Hot sublimate acetic, Bouin's fluid, strong Flemming, Gilson, Carnoy, and alcohol acetic, were used as killing and fixing fluids. Some good preparations were obtained by each method, but alcohol acetic gave the best results in obtaining equatorial plates; for it coagulated the cytoplasm of the egg in such a way as to embed the yolk granules in its meshes, thus leaving the spindle and its chromosomes free from yolk granules. Thousands of animals were sectioned and about three hundred good slides were made. Sections were cut 5μ in thickness in 51° to 52° C. paraffine.

Many parthenogenetic females were also isolated separately and the sex of their offspring determined, for those eggs first laid, before the females were killed and sectioned. The general nature of the maturation stages of such eggs was determined before a more detailed study was made of the eggs in the mixed slides.

After the eggs are laid the envelope around them is so thin and at the same time so exceedingly impervious to fixing fluids that the eggs usually collapse in the process of fixation. Sometimes a few do not collapse in alcohol acetic but, however careful one may be, by the time the eggs are embedded they have shrunk. In such eggs the yolk granules are so crowded in among the chromosomes and stain so darkly that no satisfactory results can be obtained.

In order to free the spindle from these granules the eggs were first centrifuged. In sections of such eggs the maturation spindle remained in the clear middle zone of the egg and was often entirely free from yolk granules. As only a few sections of these eggs were made no good stages were found in which the chromosomes could be counted but the method gives promise of results that can not be obtained in other ways.

Heidenhain's iron hæmatoxylin was used chiefly and gave the best results although many other stains were tried.

In order to see the polar bodies the eggs, some time after they

were laid, were put into Schneider's aceto-carminé for about thirty seconds and then into a water-glycerine solution (1 drop in 5 cc. of water). The blastomeres become separated and the polar bodies can be readily seen.

III FEMALE EGG

The female egg is easily distinguished from the male egg by its larger size and is never mistaken for the winter egg which may be of equal size, but has a much thicker envelope around it, besides containing the conspicuous sperm nucleus.

In the female parthenogenetic egg the number of chromosomes was never definitely determined but many spindles in metaphase were seen in side view, containing numerous chromosomes (20 to

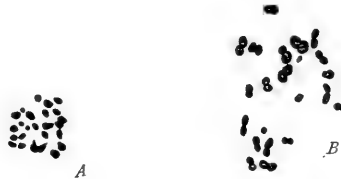

Fig. 1 Female parthenogenetic egg. *A*, equatorial plate of the polar spindle, showing twenty-three to twenty-five chromosomes; *B*, prophase of polar spindle, showing twenty-two chromosomes.

30). In one polar view of a metaphase twenty-five chromosomes were seen, Fig. 1, *A*. In a prophase twenty-two dumb-bell shaped chromosomes were seen in one section (Fig. 1, *B*) and in the adjoining section there were four other dumb-bell shaped chromosomes together with one that was not constricted. No anaphase or telophase stages were found although hundreds of eggs were examined. Lenssen found the chromosomes somewhat scattered about on the equator of the maturation spindle and concluded they were in an early anaphase but since he considered the unreduced number to be ten or twelve chromosomes the twenty or more chromosomes that he saw were probably in an early meta-

NOTE—The drawings of the chromosomes were made as carefully as possible with a camera under a 1.5 mm. Zeiss apochromatic and compensation ocular 6. They were then enlarged with a drawing camera about three times, corrected by comparison with the objects, and reduced by one-third in reproduction.

phase instead of in an early anaphase. He never saw a telophase stage and decided without any evidence that the chromosomes never separated beyond the early anaphase stage and that later all the chromosomes form the segmentation nucleus.

This is probably not the case because one polar body can always be seen near the periphery of the egg after the first cleavage, in total mounts prepared by the method already described. Sometimes a constriction can be seen across the middle of the polar body giving it the appearance of being divided into two parts. In the two-cell stage of the egg after the two blastomeres separate the polar body is always found in the space between the two cells (Fig. 2, *A-B*). In the four-cell stage it is seen at the point of juncture of the four cells (Fig. 2, *C*).

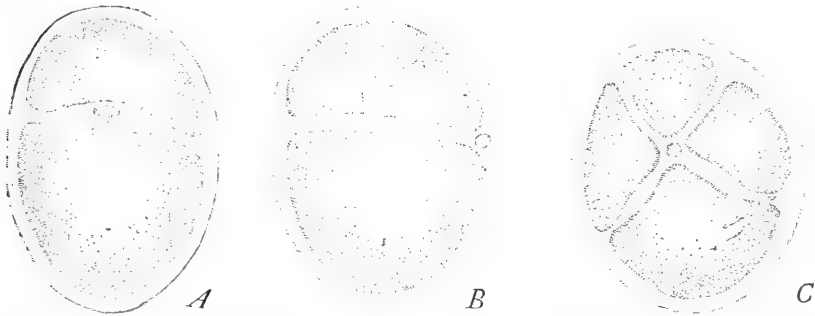

Fig. 2 Female parthenogenetic egg. *A, B*, eggs in the two-cell stage, showing one polar body; *C*, egg in the four-cell stage, showing one polar body at the intersection of the two cleavage planes.

IV MALE EGG

The male egg is much smaller than the other two kinds of eggs and has a thin envelope around it similar to that of the female parthenogenetic egg. The maturation spindle was seen several times when the chromosomes were in metaphase, anaphase and telophase stages. In two cases of telophase ten and fourteen chromosomes respectively were counted on one end of the spindle (Fig. 3, *C-D*). Polar views of the metaphase stage showed clearly eleven to thirteen chromosomes (Fig. 3, *A-B*). They were always less in number and larger in size than the chromosomes in the metaphase stage of the female parthenogenetic eggs.

Three polar bodies are to be found near the periphery of the egg close to the line of meeting of the blastomeres. One was usually larger than the other two and often at a little distance away from them (Fig. 4, *A-B*), although in one instance the three polar bodies were close together and seemed to be of the same size (Fig. 4, *C*).



Fig. 3 Male parthenogenetic egg. *A, B*, equatorial plates of the polar spindle, showing twelve to thirteen chromosomes; *C, D*, polar spindle in telophase, showing ten to fourteen chromosomes.

Lauterborn states that in the male parthenogenetic egg of *Asplanchna* the first of the two polar bodies which was extended usually divided.

Lenssen concluded that only one polar body was formed because he saw the maturation spindle in the telophase stage. He did not follow the history of the chromosomes in the later stages and consequently never saw any polar bodies.

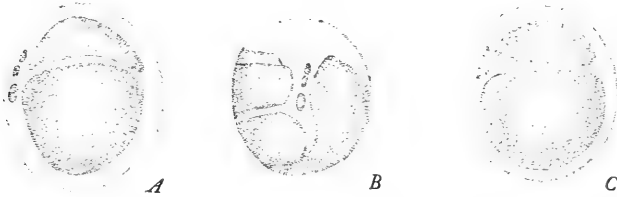

Fig. 4 Male parthenogenetic egg. *A, B*, eggs in the four-cell stage, showing three polar bodies, two of which are smaller than the other; *C*, egg in the two-cell stage, showing three polar bodies of nearly the same size.

V WINTER EGG

The fertilized or winter egg has a very thick envelope. An oval shaped small body which is probably the sperm nucleus is always found near the egg nucleus.

The chromosomes were seen in sections on the maturation spindle (side view) in all stages but in only two anaphase stages (Fig. 5,

C-D), could they be counted because of being too closely crowded together. The polar view of the metaphase in the alcohol acetic fixation gave the best results. Fourteen chromosomes were seen in several sections of different eggs (Fig. 5, *A-B*). The chromosomes were of about the same size as those in the metaphase of the male parthenogenetic egg and were much larger in size and less in number than those in the metaphase of the female parthenogenetic egg.



Fig. 5 Winter or fertilized egg. *A, B*, equatorial plates of the polar spindle, showing fourteen chromosomes; *C, D*, anaphases of the polar spindle, showing twelve to fourteen chromosomes on each end of the spindle.

On account of the thick and opaque egg envelope, the polar bodies were never seen.

VI GENERAL DISCUSSION

Although Lensen was mistaken in regard to the number of the chromosomes nevertheless he was firmly convinced that the number in the maturation stages of the male parthenogenetic and the fertilized egg were the same and that the number in the female parthenogenetic egg was greater. By comparing my Figs. 1, 3 and 5, it will be seen that this conclusion is confirmed. The greatest number of chromosomes seen in an equatorial plate of the male egg was possibly thirteen and the number seen in an equatorial plate of a winter egg was fourteen. The chromosomes of both eggs in the same stages were of the same size.

In the female parthenogenetic egg the greatest number of chromosomes seen was twenty-five (Fig. 1). The chromosomes were

very much smaller than in the other two kinds of eggs and usually were so crowded together that it was impossible to count them except in a very few cases.

These observations show that there is probably a reduction in the number of chromosomes in the male parthenogenetic and winter egg but no reduction in the female parthenogenetic egg. The former case would be similar to what occurs in the honey-bee. In the aphids Stevens found that there is no reduction in the number of chromosomes in either of the male or female parthenogenetic eggs but only in the fertilized egg.

It appears that in different animals parthenogenetic eggs vary in the number of polar bodies that they give off. The male egg of *Asplanchna*, *Hydatina* and *Apis* gives off two polar bodies while the male egg of aphids gives off only one.

If it is true that the male egg when fertilized becomes the winter egg which develops into a female it seems evident that the reduction in the number of chromosomes and the formation of the second polar body is not in itself the factor that determines the ultimate sex of the egg.

The sperm would seem to introduce a factor that determines the sex of the embryo. This idea is strongly suggested by the evidence that Meves has brought forward in the case of the honey-bee in which he finds that only one kind of functional sperm is produced. Morgan also finds a similar phenomenon for certain *Phylloxerans*. If the same process occurs in the sperm of *Hydatina* the cause of the change in sex of the male egg may be at least surmised.

VII SUMMARY

1 In the female parthenogenetic egg of *Hydatina senta* there is no reduction in the number of chromosomes during maturation. One polar body is extruded.

2 In the male parthenogenetic egg there is a reduction in the number of chromosomes during maturation. Two polar bodies are formed, one of which subsequently divides.

3 In the winter egg, that becomes fertilized, there is a reduction in the number of chromosomes during maturation, and since

a similar process of reduction takes place in the parthenogenetic egg that becomes a male it would seem to follow that the sex of the embryo from this egg is changed by the spermatozoön.

Zoölogical Laboratory
Columbia University
April 25, 1908

LITERATURE CITED.

- BALBIANI, E. G. '69-'72—Mémoire sur la génération des aphides. *Am. Sc. Nat.* Ser. 5, Zool., T. 11, 1869; T. 14, 1870; T. 15, 1872.
- BLOCHMANN, F. '88—Ueber die Richtungskörper bei unbefruchtet sich entwickelnden Insekteneiern. *Verh. naturh. med. Ver. Heidelberg, N. F.*, vol. iv, no. 2.
- '89—Ueber die Zahl der Richtungskörper bei befruchteten und unbefruchteten Bieneneiern. *Verh. naturh. med. Ver. Heidelberg, N. F.*, vol. iv, pp. 239-41; *fr. R. Mic. Loc.*, 1889.
- BRAUER, A. '94—Zur Kenntniss der Reifung des parthenogenetisch sich entwickelnden Eies von *Artemia salina*. *Arch. mikr. Anat.*, vol. xi.
- CASTLE, W. E. '03—The Heredity of Sex. *Bull. of the Mus. of Comp. Zool. Harvard College.* vol. xl, no. 4.
- DZIERZON, J. '45-'76—[For a complete list of the writings of Dzierzon, see *Bibliotheca Zoologica*, ii, p. 2270.]
- ERLANGER U. LAUTERBORN '97—Ueber die ersten Entwicklungsvorgänge im parthenogenetischen und befruchteten Rädertierei. *Zool. Anz.*, vol. xx.
- ISSAKOWITSCH, A. '05—Geschlechtsbestimmende Ursachen bei den Daphniden. *Biol. Centralb.*, xxv.
- LAUTERBORN, R. '98—Ueber die cyclische Fortpflanzung limnetischer Rotatorien. *Biol. Centralbl.*, xviii.
- LENSEN '98—Contribution à l'étude du développement et de la maturation des œufs chez *Hydatina senta*. *La Cellule*, xiv.
- MAUPAS, M. '91—Sur le déterminisme de la sexualité chez l'*Hydatina senta*, *Ehr. C. R. Ac. Sc. Paris*, cxiii.
- MEVES, F. '07—Die Spermatozytenteilungen bei der Honigbiene. *Arch. mikr. Anat.*, lxx.
- MORGAN, T. H. '08—The Production of Two Kinds of Spermatozoa in Phylloxerans. Functional "Female Producing" and Rudimentary Spermatozoa. *Proceedings of the Society for Experimental Biology and Medicine*, vol. v, no. 3.

- MRAZEK, AL. '97—Zur Embryonalentwicklung der Gattung *Asplanchna*. *Jahresb. böhna Ges.*, 2, pp. 1-11.
- NUSSBAUM, M. '97—Die Entstehung des Geschlechts bei *Hydatina senta*. *Arch. mikr. Anat.*, xlix.
- PAULCKE, W. '99—Zur Frage der Parthenogenetischen der Drohnen. *Anat. Anz.*, vol. xvi.
- PETRUNKEWITSCH, A. '01—Die Richtungkörper und ihr Schicksal im befruchteten und unbefruchteten Bienenei. *Zool. Jahrb.*, vol. xiv.
- PHILLIPS, E. F. '03—A Review of Parthenogenesis. *Amer. Phil. Soc.*, vol. xlii.
- PLÄTNER, G. '88—Die erste Entwicklung befruchteter und parthenogenetischer Eier von *Lisparis dispar*. *Biol. Centrabl.*, vol. viii, no. 17.
- '89—Ueber die Bedeutung der Richtungkörperchen. *Biol. Centrabl.* vol. viii.
- STEVENS, N. M. '04—A study of the Germ Cells of *Aphis rosæ* and *Aphis cænotheræ*. *Journ. Exp. Zool.*, vol. ii.
- WEISMANN AND ISCHIKAWA '88—Weitere Untersuchungen zum Zahlengesetz der Richtungkörper. *Zool. Jahrb.*, vol. iii.
- WEISMANN, A. '80—Parthenogenesis bei den Ostracoden. *Zool. Anz.*, iii.
- WHITNEY, D. D. '07—Determination of Sex in *Hydatina senta*. *Journ. Exper. Zool.*, vol. v.
- WILSON, E. B., '05—Studies on Chromosomes. *Jour. Exp. Zool.*, vols. ii and iii.

STUDIES ON CHROMOSOMES

V THE CHROMOSOMES OF METAPODIUS. A CONTRIBUTION TO THE HYPOTHESIS OF THE GENETIC CONTINUITY OF CHROMOSOMES¹

BY

EDMUND B. WILSON

WITH ONE PLATE AND THIRTEEN FIGURES IN THE TEXT

The genus *Metapodius* (Acanthocephala), one of the coreid Hemiptera, shows a very exceptional and at first sight puzzling relation of the chromosome-groups which has seemed to me worthy of attentive study by reason of its significance for the hypothesis of the "individuality" or genetic continuity of the chromosomes. The most conspicuous departure from the relations to which we have become accustomed lies in the fact that different individuals of the same species often possess different numbers of chromosomes, though the number in each individual is constant. An even more surprising fact is that in all of my own material every male individual possesses at least 22 spermatogonial chromosomes, including a pair of unequal idiochromosomes like those of the Pentatomidæ, while in Montgomery's material of *M. terminalis* every male has but 21 spermatogonial chromosomes, one of which is a typical odd or "accessory" chromosome (unpaired idiochromosome).²

The present paper presents the results of an investigation of these relations that has now extended over nearly four years, in the course of which serial sections of more than sixty individuals

¹ Part of the cost of collecting and preparing the material for this research was defrayed from a grant of \$500 from the Carnegie Institution of Washington, made in 1906. I am indebted to Rev. A. H. Manee, of Southern Pines, N. C., for valuable coöperation in the collection of material, and to Dr. Uhler, Mr. Heidemann, Mr. Van Duzee, and Mr. Barber for aid in its identification.

² By Professor Montgomery's courtesy I have been enabled to study thoroughly his original preparations and to satisfy myself of the correctness of his account (Montgomery '06). I also owe to him a number of unsectioned testes of the same type.

have been carefully studied. These individuals belong to three well marked species—*M. terminalis* Dall. and *M. femoratus* Fab. from the Eastern and Southern States, *M. granulosus* Dall. from the Western—all of which show a similar numerical variation.³ My first material, including sections of two testes of *M. terminalis* (Nos. 1, 2) from the Paulmier collection, long remained a complete puzzle and led me to the suspicion that the material was pathological. This possibility was eliminated by the study of additional material of the same type; but the contradiction with Montgomery's results on the same species suggested that his specimens were not correctly identified (Wilson '07a). Continued study at length convinced me that this supposition too was probably unfounded. If the identification was correct, as I now believe it was, *M. terminalis* is a species that varies not only in respect to the individual chromosome number but also in respect to the sex-chromosomes, certain individuals having an unpaired "accessory" chromosome, while others have an unequal pair of idiochromosomes. The latter condition alone has thus far been found in *M. femoratus* and *M. granulosus*. The essential facts, and the general history of the spermatogenesis, are otherwise closely similar in the three species.

The range of variation in the number of chromosomes is in *M. terminalis* from 21 to 26, in *M. femoratus* from 22 to 27 or 28, and in *M. granulosus* from 22 to 27, the particular number (or its equivalent in the reduced groups) being a characteristic feature of the individual in which it occurs. I do not mean to assert that there is absolutely no fluctuation in the individual. In this genus, as in others, apparent deviations from the typical number frequently are seen, and real fluctuations now and then appear; but the latter are so rare that they may practically be disregarded. That the number may be regarded as an individual constant (subject to such deviations as are hereafter explained (p. 185) is abundantly demonstrated, not only by the agreement of large numbers of cells from the same individual but perhaps even more

³A complete list of the individuals examined, arranged by localities, is given in the Appendix at p.-202. Each individual is there designated by a number by which it is referred to in the text and description of figures.

convincingly by the definite correlation of the spermatocyte-groups with those of the spermatogonia of the same individual. This is shown in the following table, which summarizes the facts thus far observed.⁴

SUMMARY

Somatic number (spermatogonia or ovarian cells)	First spermatocyte division	terminalis		femoratus		granulosus	
		♂	♀	♂	♀	♂	♀
		21.....	11	9	0	0	0
22.....	12	3	4	3	0	1	0
23.....	13	5	2	0	2	2	0
24.....	14	3	3	2	1	4	0
25.....	15	2	2	0	0	1	1
26.....	16	1	0	2	1	4	2
(27).....	17	0	0	0	0	1	0
28 (27?).....		0	0	0	1	0	0

Distribution in the whole group

Total somatic number	Number of males	Number of females	Totals
21.....	9	0	9
22.....	7	4	11
23.....	7	4	11
24.....	9	4	13
25.....	3	3	6
26.....	7	3	10
(27).....	1	0	1
28 (27?).....	0	1	1
Total.....	43	19	62

⁴ The somatic numbers of the males are in each case determined from the dividing spermatogonia. Those of the female are from dividing cells in various parts of the ovary—mainly from the region just above or below the end-chamber—some of them undoubtedly follicle-cells, others probably young nutritive cells or oögonia. The chromosome-groups from different regions differ considerably in size, but otherwise show the same general characters. With a very few exceptions the number of chromosomes has been determined by the count of several groups from the same gonad, in many cases by the count of a very large number. In many individuals hundreds of perfectly clear equatorial plates may be seen and the evidence is entirely demonstrative. In seven of the males (owing to lack of mitoses, or to defective fixation) the somatic number has been inferred from that shown in the spermatocyte divisions, or *vice versa*; but with a single exception both numbers have been directly observed in other individuals of the same type. I am therefore confident that the numbers are substantially correct as given. In case of the female, only the somatic numbers can be given, since the maturation-divisions are not available for study.

The material of *terminalis* is from New Jersey, Pennsylvania, Ohio, North Carolina, South Carolina and Georgia; that of *femoratus* from the three states last named; that of *granulosus* from Arizona. The variation of number is independent of locality, and individuals of the same species showing different numbers were often taken side by side on the same food plants. It is equally independent of sex, as the table at once shows. I am unable to find any constant correlation between the number of chromosomes and any other visible structural characters of the adult animals.

Such an astonishing range of variation in the chromosome number in the same species seems at first sight to present a condition of chaotic confusion. But, as I shall endeavor to show, the first impression thus created disappears upon more critical examination. Detailed study of the facts proves that the variation is not indiscriminate but affects only a particular class of small chromosomes that are distinguishable from the ordinary ones both by size and by certain very definite peculiarities of behavior. These chromosomes are absent in all of Montgomery's material; in my own they are sometimes present, sometimes absent, the total number varying accordingly. The chromosomes in question are the ones which in earlier papers I have called the "supernumeraries."⁵ In behavior they show an unmistakable similarity to the idiochromosomes; and for reasons given beyond I believe them to be nothing other than additional small idiochromosomes, the presence of which has resulted from irregularities of distribution of the idiochromosomes in preceding generations. The relations seen in Montgomery's material form the converse case, the small idiochromosome having disappeared or dropped out. I shall try to show that both cases are probably due to the same initial cause.

⁵Wilson '07a, '07b. I first discovered this phenomenon in the pentatomid species *Banasa calva* ('05b) describing the single supernumerary as a "heterotropic chromosome." Later ('07a) a single supernumerary was found in certain individuals of *Metapodius terminalis*, and other numerical variations in this species and in *femoratus* and *granulosus* were briefly recorded; but at that time I did not yet fully understand the facts. *Banasa calva* is the only form outside the genus *Metapodius*, in a total of more than seventy species of Hemiptera I have examined, in which supernumerary chromosomes have been found. Miss Stevens ('08b) has recently found in the coleopteran genus *Diabrotica* a condition that is in some respects analogous to that seen in *Metapodius*.

A GENERAL DESCRIPTION

Since the phenomena as a whole are somewhat complicated, I have thought it desirable to bring the most essential facts together for ready comparison in a preliminary general account illustrated by a limited number of selected figures (Figs. 1, 2). The fundamental type of the genus is, I believe, represented by individuals that possess 22 chromosomes in the somatic groups of both sexes, and in which no supernumeraries are present (Fig. 1, *d-f*). Two of the chromosomes are a pair of very small *m*-chromosomes, like those of other coreids; two are a pair of idiochromosomes consisting in the male of a large and a small member, in the female of two large ones; while the remaining 18 are ordinary chromosomes or "autosomes." These chromosomes have in the spermatogenesis the same general history as in other Hemiptera heteroptera. In the first division the idiochromosomes are separate univalents, their position being typically (but not invariably) outside a ring formed by the nine larger bivalents within which lies the small *m*-chromosome bivalent (Fig. 1, *d*, Photo 2). This division accordingly shows 12 separate chromosomes (one more than the reduced or haploid number.) In the second division, as described beyond, they are always united to form a dyad or bivalent, composed of two unequal halves, and the number of separate chromosomes is 11. The spermatogonial groups possess 22 chromosomes (Fig. 1, *e*) of which the small idiochromosome may often be recognized as the smallest of the chromosomes next to the *m*-chromosomes; but it does not differ sufficiently in size from the other chromosomes to be always certainly distinguishable.⁶ In the growth period the idiochromosomes, as usual, have the form of condensed deeply-staining chromosome-nucleoli, while the other chromosomes are in a vague, faintly staining condition. They are usually in contact but not fused (Fig. 1, *f*, Photo 25), thus form-

⁶ In considering the relative size-relations it is important to bear in mind that the apparent size, as seen in polar view, varies considerably with the degree of polar elongation. Still more important is the fact (which I have emphasized in a preceding paper) that in the first division univalent chromosomes always appear relatively much smaller than they do in the spermatogonia. This is the case with the idiochromosomes and the supernumeraries, which are always readily recognizable in the spermatocyte-divisions, but are often difficult to distinguish in the spermatogonia.

EXPLANATION OF FIGURES

FIG. 1

About one-fourth of the figures were drawn upon enlarged photographs by the method described in a preceding paper (Wilson '09). The others are from camera lucida drawings. In all cases the form, size, and grouping of the chromosomes are represented as accurately as possible. The form, size, and general appearance of the spindles are shown, but no attempt has been made to represent the exact details of the fibrillæ. Figs. 1 and 2 are enlarged about 3300 diameters, the others a little less than 3000 diameters.

Lettering, in all the Figures

I, large idiochromosome or odd chromosome; *i*, small idiochromosome; *m*, *m*-chromosome; *p*, plasmosome; *s*, supernumerary chromosome. In cases where *s* and *i* are both present and of equal size it is impossible to distinguish between them. In such cases I have as a rule designated as *i* the one lying nearest to *I*; but this is quite arbitrary. It should be noted also that *I* cannot always be distinguished from the smaller of the ordinary bivalents.

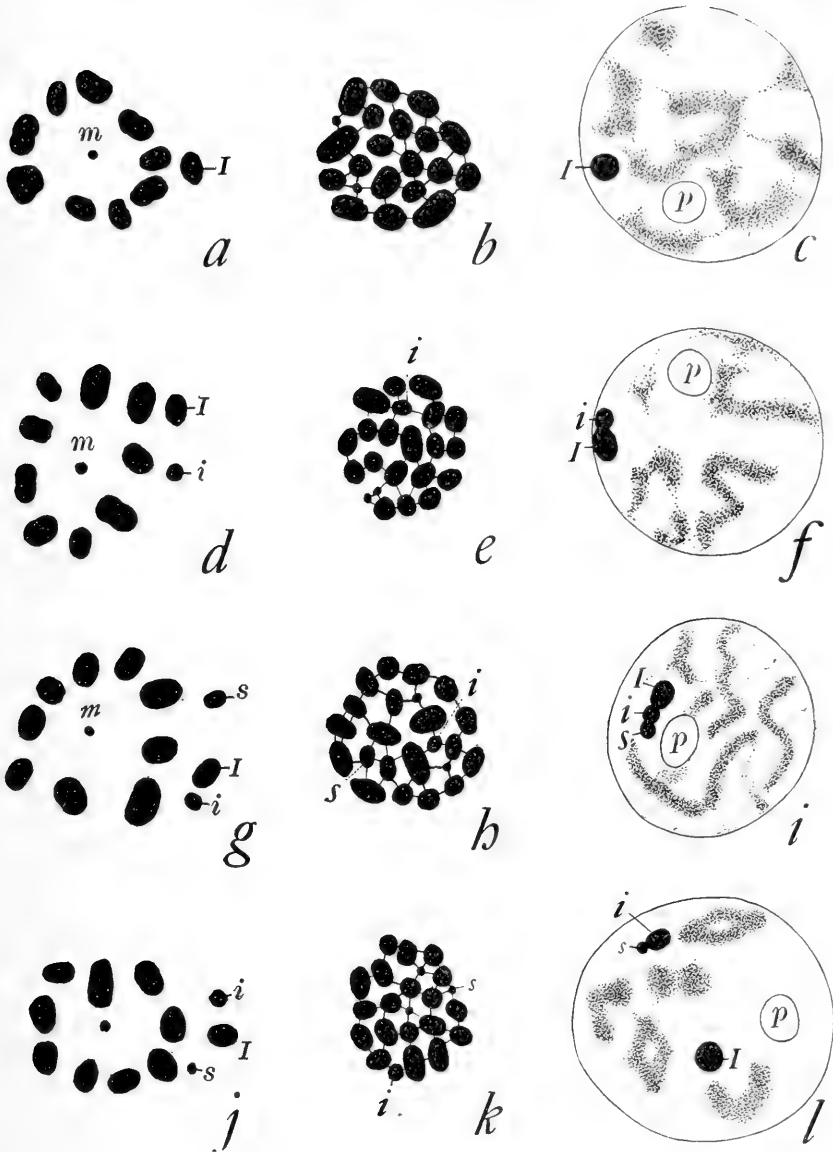

FIG. 1

M. terminalis

a-c (No. 3), 21-chromosome form; *a*, first spermatocyte metaphase; *b*, spermatogonial metaphase; *c*, nucleus from the growth period.

d-f (No. 19), 22-chromosome form, stages corresponding to above.

g-i (No. 20, Photo 4), 23-chromosome form, one large supernumerary.

j-l (No. 43), 23-chromosome form, one small supernumerary.

ing a very characteristic bipartite body; but in a good many cases they are separate (Fig. 6, *c, d*, Photo 26). A large and very distinct plasmosome is also present.

Such a group of 22 chromosomes may be regarded as the type of which all the other forms may be regarded as variants, and probably as derivatives. In forms having more than 22 chromosomes the increase in number is due to the presence of from one to six supernumeraries. These vary in number and size in different individuals, but both are constant in a given individual. Their maximal size is equal to that of the small idiochromosome (in which case they are indistinguishable from the latter); such forms will be called "large supernumeraries." Their minimal size, ("small supernumeraries") is about the same as that of the *m*-chromosomes; but from the latter they are always distinguishable, in the male, by a quite different behavior in the maturation process. When a single supernumerary is present it may be either large or small, its size being (with slight variation) constant in the individual. When more than one is present all may be of the same size (the most usual condition) or they may be of different sizes, the relation being again an individual constant. Whatever their number or size their behavior is essentially the same as that of the idiochromosomes. In the growth-period they have a condensed form and are typically united with the idiochromosomes to form a compound chromosome-nucleolus, the components of which are often distinctly recognizable and vary in number with the number of the supernumeraries. In the first division they divide as separate univalents, and this division accordingly shows as many chromosomes above 12 as there are supernumeraries—i.e., if the spermatogonial number be $22 + n$, the number in the first division is typically $12 + n$. Their typical position in this division is, like that of the idiochromosomes, outside the ring of larger bivalents, though there are many exceptions. In the second division they are, as a rule, again associated with the idiochromosomes to form a compound element, though not infrequently one or more of them may be free from the others.

A definite correlation thus appears in each individual between the number and relative sizes of the chromosomes seen in the

maturation-divisions and in those of the spermatogonia; and it also appears in the number and size of the components of the chromosome-nucleoli when these can be distinctly recognized. Figs. 1 and 2 illustrate this correlation and epitomize the most essential facts. These figures have been selected from a much larger number to show the clearest and most typical conditions. Some of them are enlarged from the photographs reproduced in Plate I. Many others, with an account of secondary variations, are given beyond. Each horizontal row of figures represents three stages of the same type which, with two exceptions, are all from the same individual. The left hand figure in each row shows the typical arrangement of the chromosomes in the metaphase of the first spermatocyte-division, the middle figure a spermatogonial group, and the right hand one a nucleus from the growth period, to show the chromosome-nucleolus together with some of the diffused ordinary chromosomes.

Fig. 1, *a-c* (terminalis, No. 3), represent these three stages in an individual of the 21-chromosome type (Montgomery's material) showing 11 chromosomes in the first division, 21 in the spermatogonia, and a single chromosome-nucleolus in the growth period. (Additional figures of this individual in Fig. 3.) Fig. 1, *d-f* (terminalis, No. 19), show the 22-chromosome type, with a small idiochromosome present in addition to the large one. The small idiochromosome (*i*) is distinguishable in Fig. 1, *e*. (Additional figures in Figs. 4-6.)

Fig. 1, *g-i* (terminalis, No. 20), show the 23-chromosome type, with one large supernumerary. In the spermatogonial group (*h*) this chromosome and the small idiochromosome are probably represented by the two designated as *i* and *s*. The nucleus from the growth-period (*i*), shows the plasmosome (*p*) and a tripartite chromosome-nucleolus formed by the idiochromosomes and the supernumerary attached in a row (*cf.* Photo 27; additional figures in Figs. 7-8). Fig. 1, *j-l* (terminalis, No. 43), show a 23-chromosome group with one small supernumerary. This clearly appears in the spermatogonial group (*s*); and the small idiochromosome (*i*) is also distinguishable. In the nucleus from the growth-period (*l*), the supernumerary and small idiochromosome

are united (*i, s*) the large idiochromosome (*I*) being separate. (Additional figures in Figs. 7, 8.)

Fig. 2, *a-c* (terminalis, No. 21), show the corresponding stages in an individual of the 24-chromosome type, with two large supernumeraries. Their identification in the spermatogonial group is somewhat doubtful. (Additional figures in Fig. 10.)

Fig. 2, *d, e* (terminalis No. 34), show a 25-chromosome type with three large supernumeraries. The growth-period (*f*) is from an individual of *granulosus* (No. 54) that is possibly of the 26-chromosome type. (Additional figures in Fig. 12.)

Fig. 2, *g, h* (femoratus No. 42), and *i* (*granulosus*, No. 60) show the 26-chromosome type with four large supernumeraries. (See Photo. 28, additional figures in Figs. 9, 10.)

Fig. 2, *j-l* (femoratus, No. 40), are from a very interesting individual of the 26-chromosome type, with two large and two small supernumeraries (additional figures in Figs. 9, 10). The spermatogonia of this individual (*k*) uniformly show 26 chromosomes, including four very small ones (two *m*-chromosomes, two small supernumeraries), but the large supernumeraries and the small idiochromosomes are doubtful. No case was found in which all of the six components of the chromosome-nucleolus could be seen; *l* shows five of them, including the two small ones.

B ADDITIONAL DESCRIPTIVE DETAILS

I will now give a somewhat more detailed and critical account of the facts. Taken as a whole, the series (including nearly 300 slides of serial sections) presents a profusion of evidence on many cytological questions that could not be adequately described save in a large monograph; but I will here limit the account mainly to the numerical and topographical relations of the chromosomes. The clearness of the preparations is such that nearly all the principal phenomena might have been illustrated by photographs (of which upwards of 200 have been prepared). Thirty of these are reproduced in Plate I, less for the purpose of giving the evidence in detail than of illustrating its character to those not directly familiar with this material.

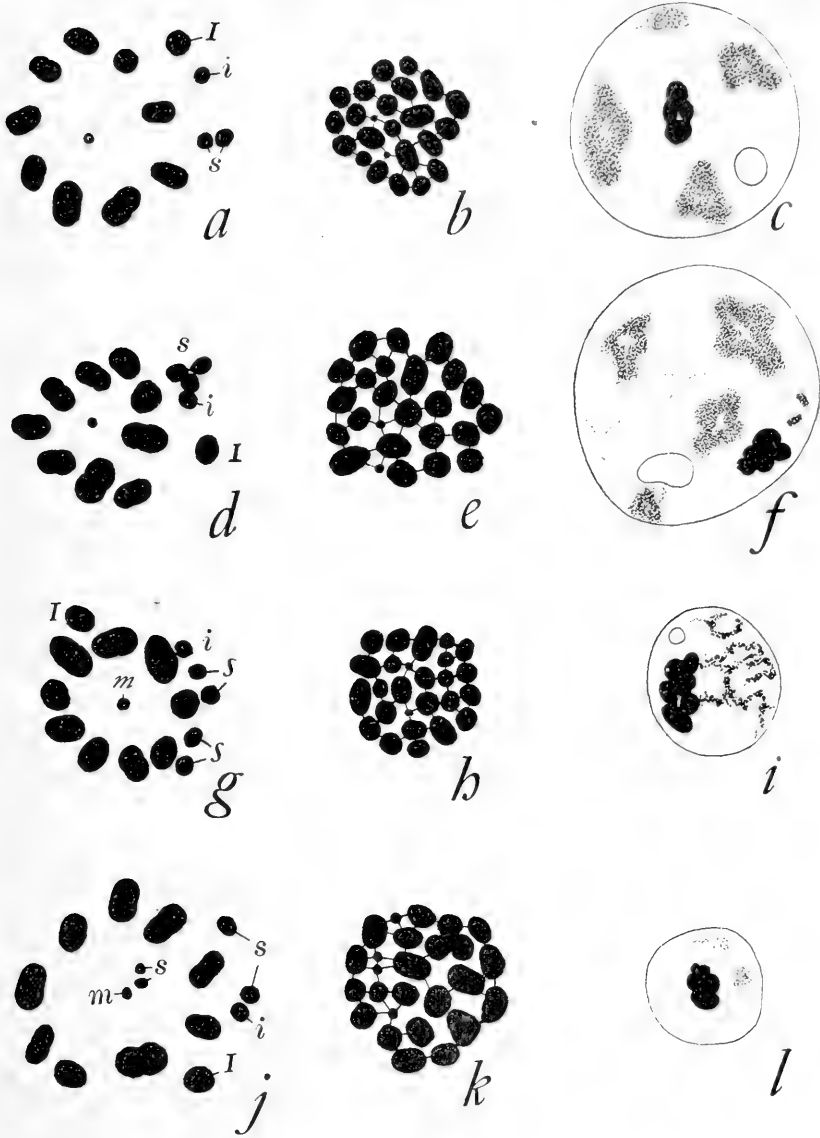

FIG. 2

a-e, *M. terminalis*; *f, i*, *granulosus*; *g-h, j-l*, *femoratus*.

a-c (No. 21), 24-chromosome form, two large supernumeraries.

d-e (No. 34), 25-chromosome form, three large supernumeraries.

f (No. 54), growth-period, 25- or 26-chromosome form.

g-h (No. 42 Photo 8), 26-chromosome form, four large supernumeraries.

i (No. 60), 26-chromosome form, growth-period.

j-l (No. 40), 26-chromosome form, two large and two small supernumeraries.

1 *Individuals having twenty-one spermatogonial Chromosomes, including an unpaired Idiochromosome. Small Idiochromosome and Supernumeraries absent*

To this group belong only the specimens, all males, collected by Montgomery at West Chester, Pa., of which I have examined nine individuals, all of which have essentially the same characters.⁷ Montgomery ('01) originally described these forms as having 22 spermatogonial chromosomes but subsequently ('06) corrected this to 21, describing the phenomena as agreeing in all essential respects with those seen in *Anasa* and other coreids. A study of the original preparations has enabled me to confirm this later account in every essential point. After the synzesis or contraction phase of synapsis (as in all individuals of the genus) the ordinary chromosomes appear in the form of rather delicate spireme-like threads, longitudinally split. In later stages of the growth-period they shorten, become irregular, lose their staining capacity, and assume the vague, pale condition characteristic of so many other forms. In the early prophases of the first division they become more definite, stain more deeply, and appear as coarse longitudinally split rods that often show an indication of a transverse division at the middle point, or in the form of the double crosses as described by Paulmier in *Anasa* ('99). In the later prophases they condense still further to form nine compact bivalents which finally arrange themselves in a more or less regular ring. The equatorial plate of the first division always shows in polar view 11 chromosomes (Fig. 3, *a, b*, Photo 1). In the most typical case the univalent idiochromosome lies outside this ring, but it sometimes lies in or inside it. The small *m*-chromosome bivalent is always near the center of the ring. In side view the larger bivalents are either dumb-bell shaped or more or less distinctly quadripartite, in the

⁷ These were taken from magnolia trees. In the summer of 1907 I collected in the same locality two males and three females, all from blackberry bushes. To my disappointment, these differ from Montgomery's specimens, one male having 22 spermatogonial chromosomes, the other 23; while the ovarian cells have in one female 23 and in the other two 24 chromosomes. It is possible that a different species fell into Montgomery's hands, perhaps an introduced form; but both the structure of the testis and the character of the chromosome-groups agree so exactly with my own material that I now believe that Montgomery's identification was probably correct.

latter case appearing dumb-bell shaped as seen in polar view. The eccentric idiochromosome is of nearly the same size as the smallest of the large bivalents and is often indistinguishable from the latter except by its position. All these chromosomes divide equally in this division, the *m*-chromosomes usually leading the way in the march towards the poles, while the idiochromosomes often lag slightly behind the others.

The second division likewise shows 11 chromosomes in polar view (3, *c*, *d*); but the regular grouping characteristic of the first division is now usually lost, the ring formation being often no longer apparent, while either the *m*-chromosome or the idiochromosome may now occupy any position.⁸ In this mitosis all the chromosomes divide except the idiochromosome which lags behind the others and finally passes undivided to one pole (Fig. 3, *e-h*, Photos 14, 15) as Montgomery described. The nucleus formed at this pole thus receives 11 chromosomes, the sister nucleus but 10, precisely as in *Anasa*, *Narnia*, *Chelinidea* or *Leptoglossus*. This is proved beyond all doubt by polar views of the anaphases, showing the sister groups lying one above the other in the same section (Fig. 3, *h*). In the particular example figured the idiochromosome lies eccentrically, but this is quite inconstant.

The spermatogonia (Fig. 3, *i*, *j*) always show 21 chromosomes, a largest and a smallest pair being always distinguishable. The unpaired idiochromosome cannot be distinguished from the others. The *m*-chromosomes are usually equal, but sometimes appear slightly unequal.

In the growth-period the *m*-chromosomes and the idiochromosome have the same history as in other coreids. The former are

⁸ The regrouping of the chromosomes in the second division, first described by Paulmier ('99) in *Anasa tristis*, is characteristic of the Coreidæ generally, an eccentric position of the idiochromosome being a nearly constant feature of the first division but not of the second. Failure to recognize this fact in the case of *Anasa tristis* seems to have been one of the main sources of error in the entirely mistaken conclusions of Foot and Strobell ('07a, '07b) regarding this species. (Cf. Lefevre and McGill, '08.) Demonstrative evidence on this point is given by polar views of rather late anaphases in which every chromosome of each daughter plate may be seen in the same section. Such views, of which I have studied many, both in *Anasa* and in other genera, show that one of the chromosomes may indeed occupy an eccentric position, and may there divide; but in such cases the odd chromosome is always found elsewhere in the group, lying either in or near one of the daughter-groups and not in the other. When the odd chromosome is eccentric it is found in one of the daughter groups but not in the other.

typically separate, and at first diffuse (as in *Anasa* or *Alydus*). Later they condense to form two spheroidal bodies that conjugate in the late prophase to form the central small bivalent and are almost immediately separated again by the division. The idio-

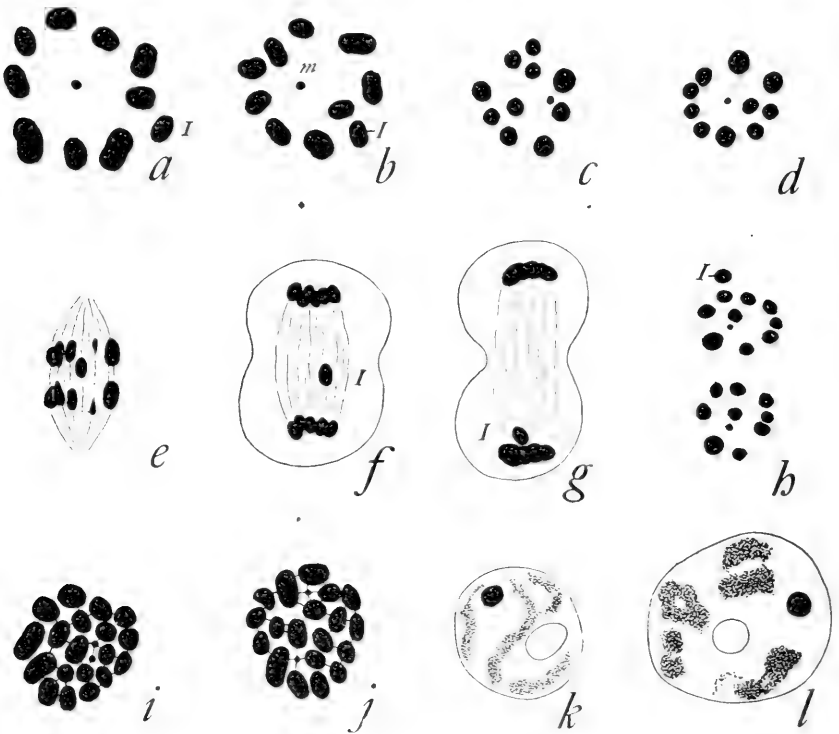

FIG. 3

M. terminalis (Montgomery's material (Nos. 3-11), 21-chromosome form)

a, b, first division, polar view (Photo 1); *c-d*, second division; *e, f*, side views of second division (Photos 14, 15); *h*, sister-groups from the same spindle, in one section, anaphase second division, one showing 10 chromosomes the other 11.

i-j, spermatogonial groups, 21 chromosomes; *k-l*, early and late growth-period.

chromosome has throughout the early and middle growth-period the form of a *single* spheroidal or ovoidal intensely staining chromosome-nucleolus, which shows in brilliant contrast to the other chromosomes (Fig. 3, *k, l*, Photo 24). This body is sometimes slightly constricted in the earlier period. Later it is always con-

stricted, assuming the bipartite form in which it enters the equatorial plate to form the eccentric chromosome. Throughout the growth-period a large plasmosome is also present, usually separate from the chromosome-nucleolus. In properly stained sections these two bodies differ so markedly in staining reactions that they cannot for a moment be confused. In hæmatoxylin preparations the chromosome-nucleus is intensely black, the plasmosome pale yellowish, bluish or gray. In Montgomery's safranin-gentian preparations (though now somewhat faded) the former is bright red, the latter bluish or nearly colorless.

There are no females in Montgomery's material; but in view of the relations known in many other related forms it may safely be concluded that the 11-chromosome spermatozoa are female-producing, and that the female somatic number in this race is 22.

2 *Individuals with twenty-two Chromosomes in the somatic Groups of both Sexes including a pair of unequal Idiochromosomes in the Male, and a Pair of equal large ones in the Female*

This condition has been found in seven males and four females, all three species being represented. The three species closely agree in all the phenomena.

To the males of this type precisely the same description applies as to the foregoing case except that a small idiochromosome is present in addition to the "odd" or "accessory" chromosome. The latter is now indistinguishable from a "large idiochromosome," and the identity of these two forms of chromosomes, on which I have laid stress in former papers, is thus fully demonstrated. This appears most clearly in the maturation divisions. In the first division the chromosomes show the same grouping as in the 21-chromosome forms, but a small idiochromosome accompanies the "accessory," frequently lying beside it outside the principal ring, though sometimes being in or inside the latter (Fig. 4, *a-j*, Photos 2, 3). This chromosome is always recognizable as the smallest of all the chromosomes except the *m*-chromosomes, and it is in general about half the size of the large idiochromosome or slightly less. All the chromosomes now divide equally (Fig. 4, *l*,

Photo 11), 12 chromosomes passing to each pole. The second division immediately follows without the intervention of a "resting stage," and the chromosomes undergo the same regrouping as that described for the 21-chromosome forms. As this takes place, the two idiochromosomes conjugate to form an unequal bivalent (precisely as in *Lygaeus* or *Euschistus*); so that when the equatorial plate reforms but 11 (instead of 12) chromosomes appear in polar view (Fig. 5, *a-c*, Photo 12). The idiochromosome-bivalent now usually lies near the center of the group (contrasting with the first division), and the *m*-chromosome is usually not far from it. Such views are almost indistinguishable from those of the 21-chromosome individuals, since the small idiochromosome is covered by the large one and only appears in side view. In the course of the division the idiochromosome bivalent separates into its two components, which pass to opposite poles, while all the other chromosomes divide equally. The idiochromosomes at first separate more rapidly than the other daughter-chromosomes (Fig. 5, *f, h*), as in other genera, but as the division proceeds the reverse condition prevails, so that the two idiochromosomes are seen lagging on the spindle between the diverging daughter groups (Fig. 5 *i-l*). In the later stages one passes to each pole. There is much variation in this process. Often the two move at the same rate so that in the late anaphases one may be seen entering each pole (Fig. *k, l*, Photo 17). Not uncommonly, however, one or the other lags behind upon the spindle (usually the large one, though Fig. 5, *j*, shows the reverse case) giving a condition that exactly resembles that seen in the 21-chromosome forms (Fig. 5, *m, n*), but earlier anaphases in the same cysts at once show the difference. It is no less conclusively shown by polar views of the late anaphases, in which each daughter-group is seen to consist of 11 chromosomes, ten of which are duplicated in the two while the eleventh is in one case the large, in the other the small idiochromosome (Fig. 5, *q, r, s, t*).

The difference between the two types is shown with almost equal clearness by the chromosome-nucleoli of the growth-period. In the 21-chromosome type, as already stated, this body is single. A similar appearance is sometimes given in the 22-chromosome indi-

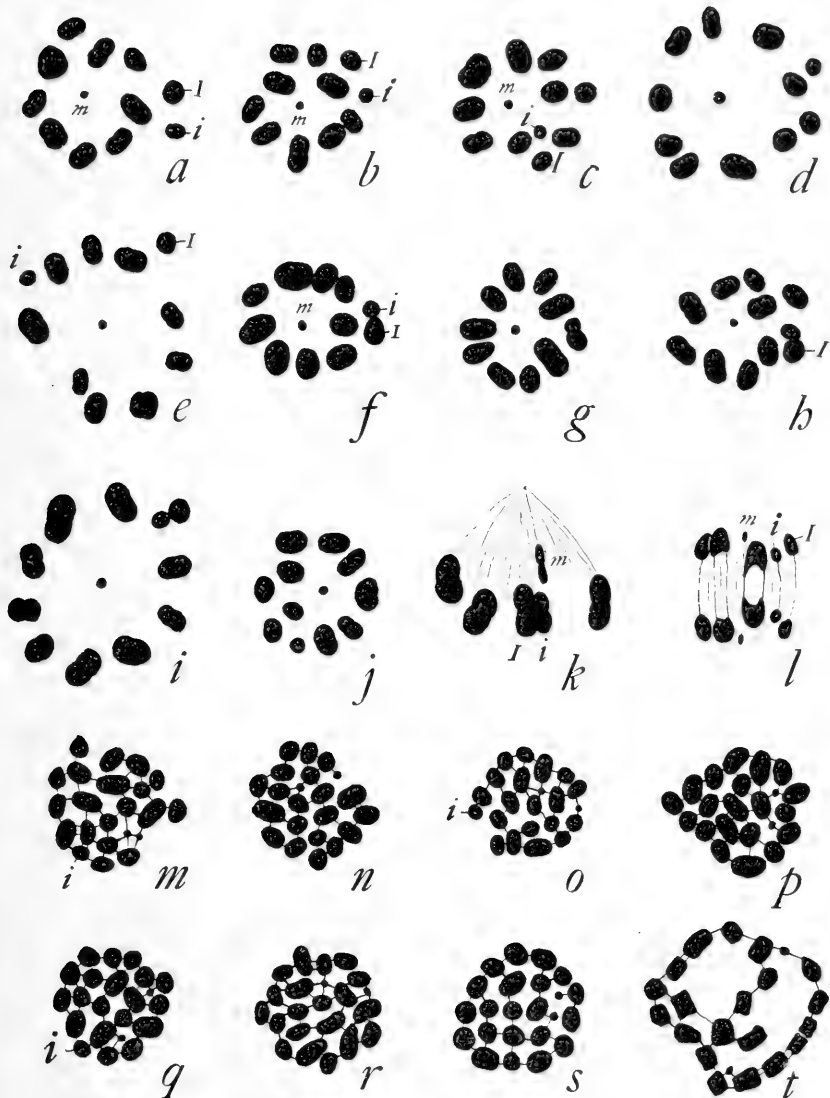

FIG. 4

22-chromosome forms

a-l, first division; *a, b*, term. No. 19, typical (Photo 2); *c*, term. No. 12 (Photo 3); *d, e*, fem. No. 29 *f*, term. No. 12; *g, h*, term. No. 19, idiochromosomes united; *i*, fem. No. 29, same condition; *j*, gran. No. 47; *k*, fem. No. 29, first division, side view, idiochromosomes united; *l*, fem. No. 46 (Photo 11), first division, anaphase, division of both idiochromosomes.

m-q, spermatogonial groups; *m*, term. No. 19; *n, o*, fem. No. 46; *p, q*, fem. No. 29.

r-t, ovarian groups; *r*, term. No. 24; *s*, term. No. 44; *t*, term. No. 23, exceptional form and grouping.

viduals, owing to close union of the two idiochromosomes. But in very many cells of this period the chromosome-nucleolus consists of two very distinct unequal moieties, in contact (Fig. 6, *a*, *b*, Photo 25), or not infrequently widely separated (Fig. 6, *c*, *d*. Photo 26). When in contact they form a double body closely similar to the idiochromosome-bivalent of the second division. There can be no question of confusing either of these bodies with the plasmosome, since the latter, showing its characteristic staining reactions, is also present.

In the late prophases of the first division the idiochromosomes, if previously united, almost invariably part company to divide as separate univalents, as in other Hemiptera; but they usually remain near together outside the principal ring. Only very exceptionally do they divide together.

The spermatogonial groups (Fig. 4, *m-q*) uniformly show 22 chromosomes, and in some cases the small idiochromosome may be recognized by its small size (*m*, *q*). This is, however, not nearly so marked as in the first division, since it now appears relatively twice as large, owing to the univalent character of the other chromosomes, and often it cannot certainly be distinguished from the smaller of these (*n*, *p*).

These facts make it clear that if the small idiochromosome be supposed to disappear, the entire series of phenomena would become identical with those shown in the 21-chromosome individuals, the large idiochromosome now appearing as the odd or "accessory" chromosome.

The unreduced female groups of this type (ovarian cells) are closely similar to those of the male (Fig. 4, *r-t*) but a small idiochromosome can never be distinguished. The absence of this chromosome cannot be so convincingly shown in *Metapodius* as in such forms as *Lygaeus* or *Euschistus*, owing to its greater relative size. Nevertheless, after the detailed study of many female groups I am convinced that this chromosome is not present, and that all the chromosomes may be equally paired. Apart from analogy, therefore, I think the conclusion reasonably safe that in *Metapodius*, as in other forms, the unequal idiochromosome-pair of the male is represented in the female by a large equal pair,

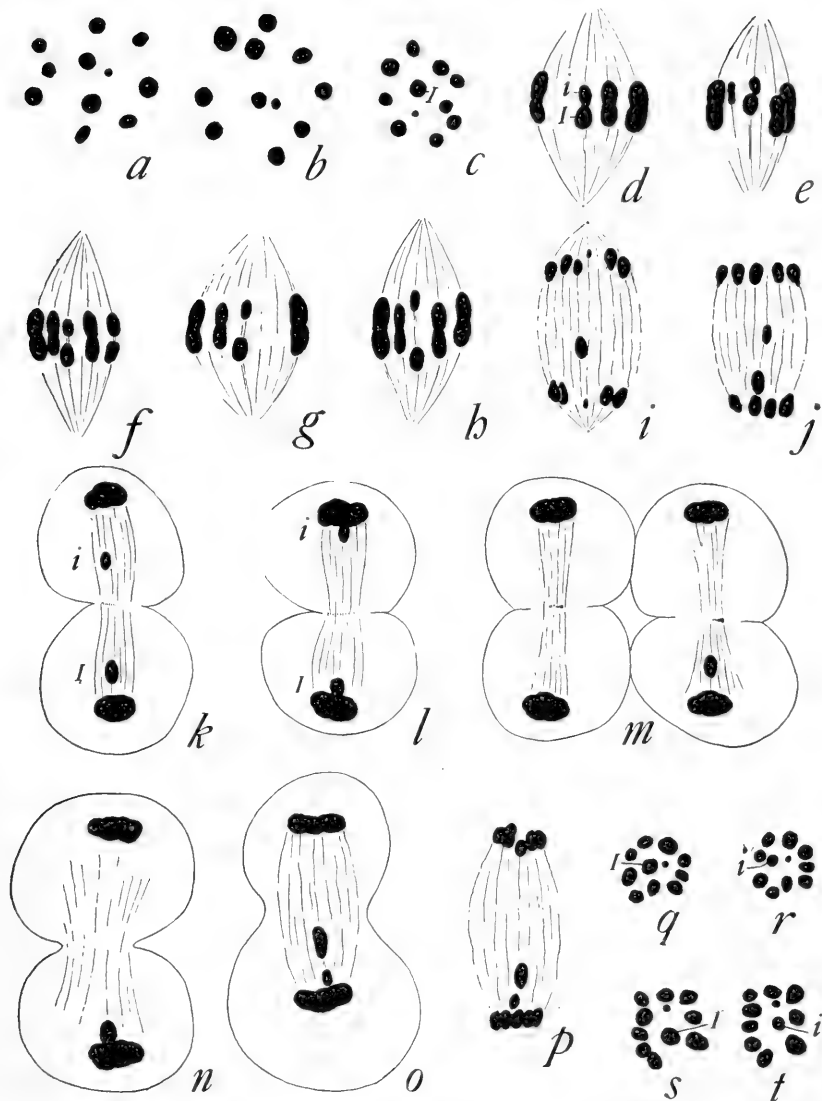

FIG. 5

22-chromosome forms

a-c, second division, polar view; *a*, fem. No. 19; *b*, fem. No. 28; *c*, gran., 47 (Photo 12).

d-p, second division, side view; *d-h*, fem. No. 29, metaphases, separation of idiochromosomes; *i, j*, term. No. 19, anaphases, lagging of one idiochromosome; *k-m*, gran., No. 47, late anaphases (Photo 17); *n*, term., No. 19, late anaphase, lagging large idiochromosome; *o*, fem., No. 46, exceptional condition, both idiochromosomes passing to one pole (Photo 18); *p*, term. No. 19, similar form; *q, r*, term., No. 19, sister anaphase groups, from the same spindle; *s, t*, fem., No. 29, the same.

and that, accordingly, the usual rule holds in regard to fertilization.

Exceptional conditions. There are two conditions, rarely seen, that are of interest for comparisons with other species. Now and then the idiochromosomes fail to separate for the first division, but remain in more or less close union to form an asymmetrical bivalent, which in side view is seen to form a tetrad (Figs. 4, *f-i*, *k*, Photo 3). This bivalent undergoes an equational division, in this respect agreeing with the conditions uniformly seen in Syro-

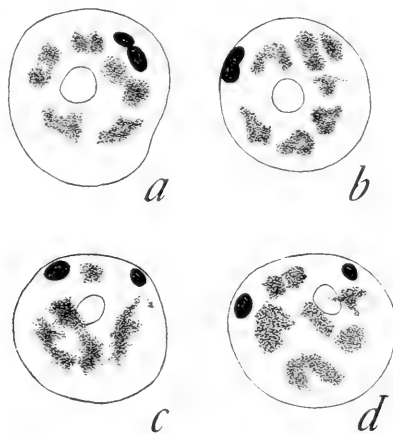

FIG. 6

M. femoratus (No. 29) 22-chromosome form

Four nuclei from growth-period showing diffused ordinary chromosomes, condensed chromosome-nucleoli and plasmosome; in *a* and *b* the two idiochromosomes are united to form double chromosome-nucleoli (Photo 25); in *c* and *d* they are separate (Photo 26).

mastes (Gross '04, Wilson '09), and differing from that occurring in the Coleoptera or Diptera (Stevens '06, '08a). A rarer but more interesting deviation from the type is the failure of the idiochromosomes to separate in the second division, both passing together to the same pole (Fig. 5, *o*, *p*, Photo 18). Since the other chromosomes divide equally it may be inferred that in this case one pole receives 12 chromosomes and the other but 10. This has been seen in only three cells and is doubtless an abnormality. It may however, possess a high significance as forming a possible point

of departure for the origin of the whole series of relations observed in the genus.

3 *Individuals possessing twenty-three Chromosomes; one Supernumerary*

This condition exists in all three species and has been found in seven males and four females. In four of these males the supernumerary is large (of approximately the same size as the small idiochromosome, as in Fig. 1, *g-i*); in three it is no larger than the *m*-chromosomes (as in Fig. 1, *j-l*), and is indistinguishable from the latter save in behavior. In each case, as already described, the spermatogonia show 23 chromosomes and the first division 13; and in those showing a small supernumerary in the first division the spermatogonia always show three very small chromosomes.

The grouping in the first division, though conforming to the same general type, shows many variations of detail, as may be seen from Fig. 7, *a-l*, Photos 4-6. It is a curious fact that the form of grouping is to some extent characteristic of the individual. For example, the typical arrangement, with both idiochromosomes and supernumerary outside the ring, is very common in Nos. 43 (Fig. 1, *j-l*) and 20 (7, *a-c*), very rare in Nos. 1, 2 (Fig. 7, *i*) and 49 (Fig. 7, *f-h*). In No. 49, very many of the first division metaphases show both supernumerary and small idiochromosome lying inside the ring (Fig. 7, *g-h*). I am unable to suggest an explanation of this.

In this division all the chromosomes divide equally (Fig. 7, *m-p*), so that each secondary spermatocyte receives 13 chromosomes. The usual regrouping now takes place, and the idiochromosomes couple as usual to form an asymmetrical bivalent. The supernumerary sometimes remains free (i. e., not attached to any other), in which case 12 chromosomes appear in polar view (Fig. 8, *b, d*). Much more frequently the supernumerary attaches itself to the idiochromosome bivalent to form a triad element, polar views now showing but 11 chromosomes (8, *a, c*), one of which is compound. The three components of such triads usually lie in a straight line, the supernumerary being attached sometimes to the small idio-

FIG. 7

23-chromosome forms, one supernumerary

a-h, first division, polar views, one large supernumerary; *a-c*, term., No. 20, typical grouping; *d-e*, gran., No. 48; *f, g, h*, gran., No. 49 (Photo 5).

i-l, first division, polar views, one small supernumerary; *i*, term. No. 1 (Photo 6); *j-l*, term. No. 43 typical grouping in *k*.

m-p, first division, side-views; *m* and *n* (term. No. 43) show division of *I, i, m*, and small *s*; *o*, term., No. 20, division of *I, i*, and large *s*; *p*, term., No. 43, division of *m, i*, and small *s*.

q-s, spermatogonial groups from individuals with one large supernumerary; *q, r*, term., No. 20; *s*, gran., No. 49.

t-y, spermatogonial groups from individuals with one small supernumerary; *t, u*, term., No. 43; *v-y*, term., No. 2 (Photo 29).

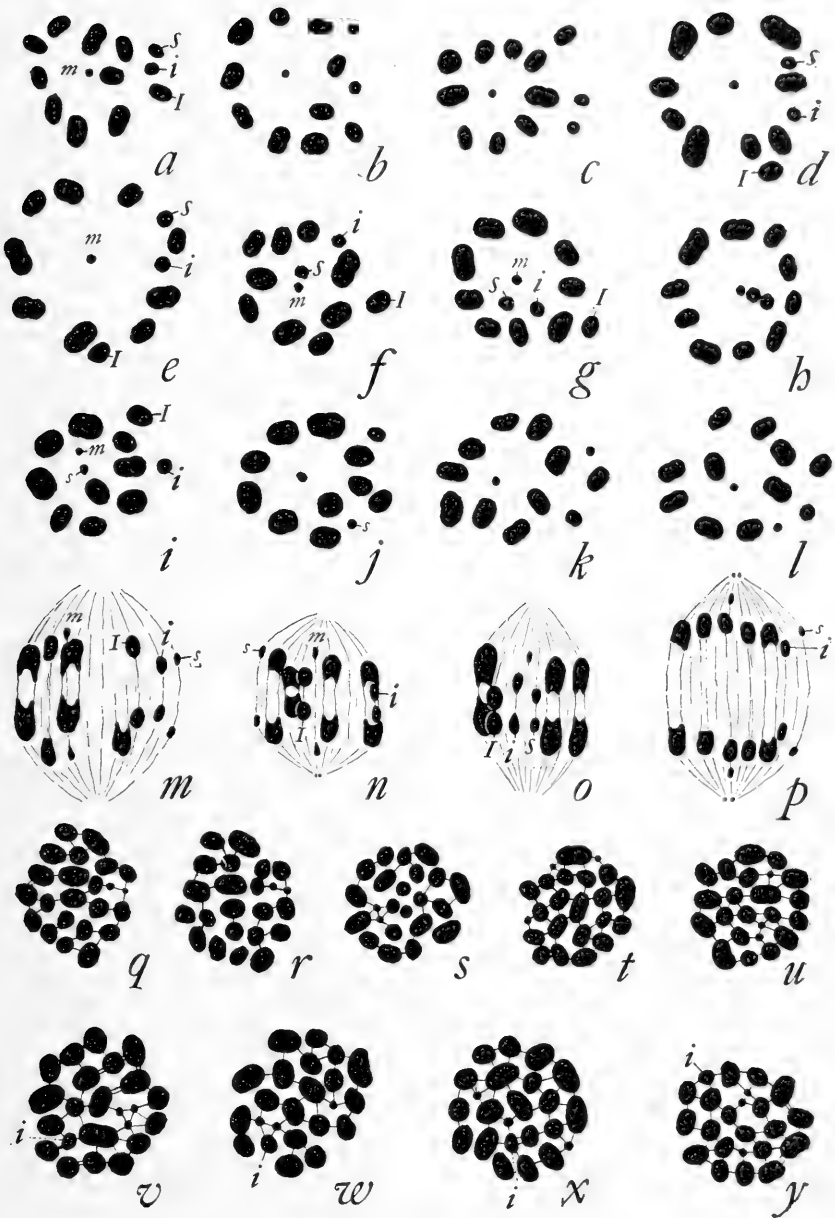

FIG. 7

chromosome, sometimes to the large, or not infrequently lying between the two (Fig. 8, *g, h, o-q*).

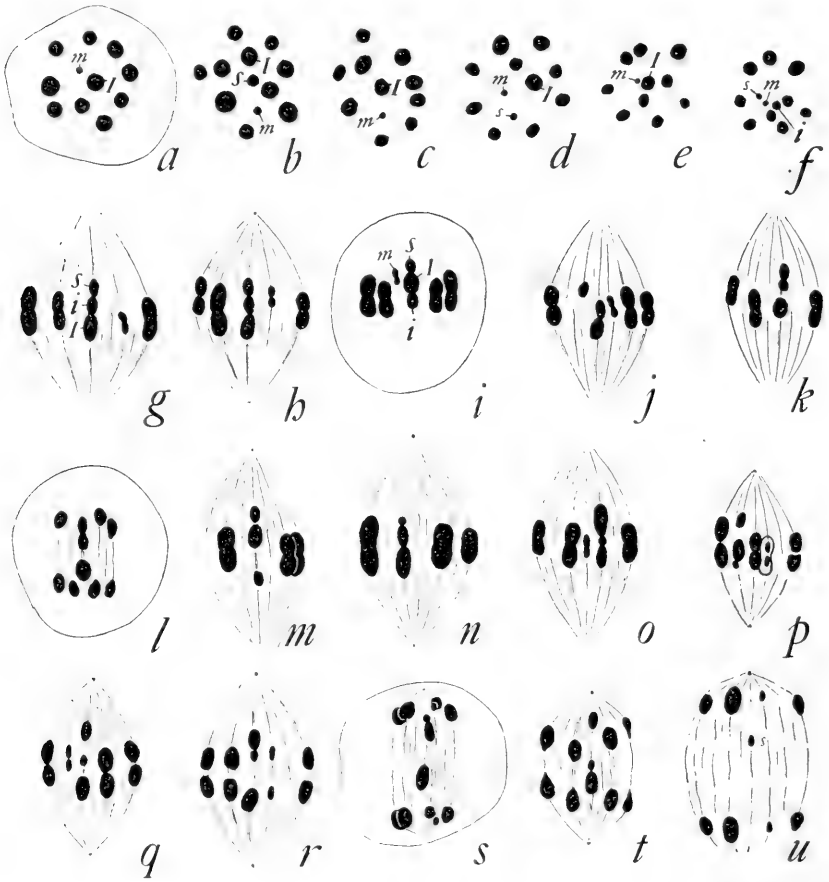

FIG. 8

23-chromosome forms, one supernumerary

a-f, polar views, second division; *a*, gran., No. 49, large supernumerary attached; *b* (same cyst) supernumerary free; *c-d*, similar views of terminalis, No. 43, with small supernumerary; *e-f* (No. 43), sister groups from same spindle, polar views.

g-m, side-views, second division, from gran., No. 49, with large supernumerary, free in *j*, attached in the others.

n-u, similar views from individual (term., No. 43) with small supernumerary; in *u* the supernumerary is free.

In the ensuing division, if the supernumerary lies free it passes without division as a heterotropic chromosome to one pole (8, *u*). When connected with the idiochromosome bivalent it passes to one pole attached to one or the other of the idiochromosomes (Fig. 8, *k-m*, *p-t*). In either case one pole receives 11 chromosomes and one 12 (Fig. 8, *e*, *f*); but since the supernumerary may accompany either idiochromosome four classes of spermatid nuclei are formed, namely:

$$\begin{array}{ll} (1) 10 + I = 11 & (2) 10 + i + s = 12 \\ (3) 10 + t = 11 & (4) 10 + I + s = 12 \end{array}$$

As described in an earlier paper ('07a), there is a tendency for the supernumerary to be associated more often with the small idiochromosome than with the large, and classes 1 and 2 are accordingly more numerous than 3 and 4. I was formerly inclined to attribute importance to this as pointing to the more frequent occurrence of the supernumerary in the male than in the female. The larger series of data now available leads me to doubt whether it has much significance; for if (leaving the 21-chromosome forms out of account) the whole series of forms be taken together, one or more supernumeraries are found in 27 out of 34 males, and in 15 out of 19 females—about 80 per cent in each case. It appears therefore that in the long run the supernumeraries are distributed between the two sexes with approximate equality.

Figs. 7, *q-s* show spermatogonial groups from individuals with one large supernumerary, but in none of them can this chromosome or the small idiochromosome be certainly distinguished. Fig. 7, *t-y* are from individuals with one small supernumerary, each showing three very small chromosomes. In *t* and *u* the small idiochromosome is doubtful. Fig. 7, *v-y*, on the other hand, are from an individual (terminalis, No. 2), showing great numbers of very fine spermatogonial groups, in almost all of which the small idiochromosome is at once recognizable. The same is true of a second individual from the same locality. These two individuals, from the Paulmier collection, were the first material I examined and found so puzzling until the examination of another similar individual, No. 43, cleared up the nature of the second division.

4 *Individuals with twenty-six Chromosomes; four Supernumeraries*

It will be convenient to consider this type before the 24- and 25-chromosome forms, since the material is more favorable for an account of the remarkable phenomena occurring in the second division. Of these individuals there are seven males and three females, all three species being represented. Unfortunately very few perfectly clear spermatogonial groups are shown; but the spermatocyte-divisions and cells of the growth-period are particularly well shown and in large numbers of cells. In all but one of these individuals the four supernumeraries are large and of nearly equal size. In one (femoratus No. 40) two are large and two small. The latter case, already shown in Fig. 2, *j-l*, is further illustrated by Fig. 9, *h, i, j, n, o*. Two of these (*h* and *i*) show but three supernumeraries in the first division, a common appearance in this individual (see p. 186). Fig. 9, *a-l*, show varying arrangements of the 16 chromosomes that appear in the first division, the most typical ones being *k* and *l*. In 9, *a-c, k, l*, both idiochromosomes and the four supernumeraries lie outside the ring. In 9, *g*, all but the large idiochromosome are inside the ring.

In some of these slides the compound chromosome-nucleoli are shown with great distinctness in many cells of the growth-period. This body usually has the form of a flat plate that lies next the nuclear wall (Fig. 10, *q, r*) so that a clear view of all the components can only be had in tangential sections. Thus viewed (Fig. 10, *s-u*, Photo 28) it may often be seen to consist of six components one of which (the large idiochromosome) is about twice the size of the others and is usually at one side or end of the group. The other five evidently represent the small idiochromosome and the four supernumeraries. In side view (Fig. 10, *q, r*) not more than three or four of the components, can as a rule be recognized. In a considerable number of cases these six chromosomes are not aggregated to form a single body but form two or more simpler bodies.

The second division in these forms presents an extraordinary

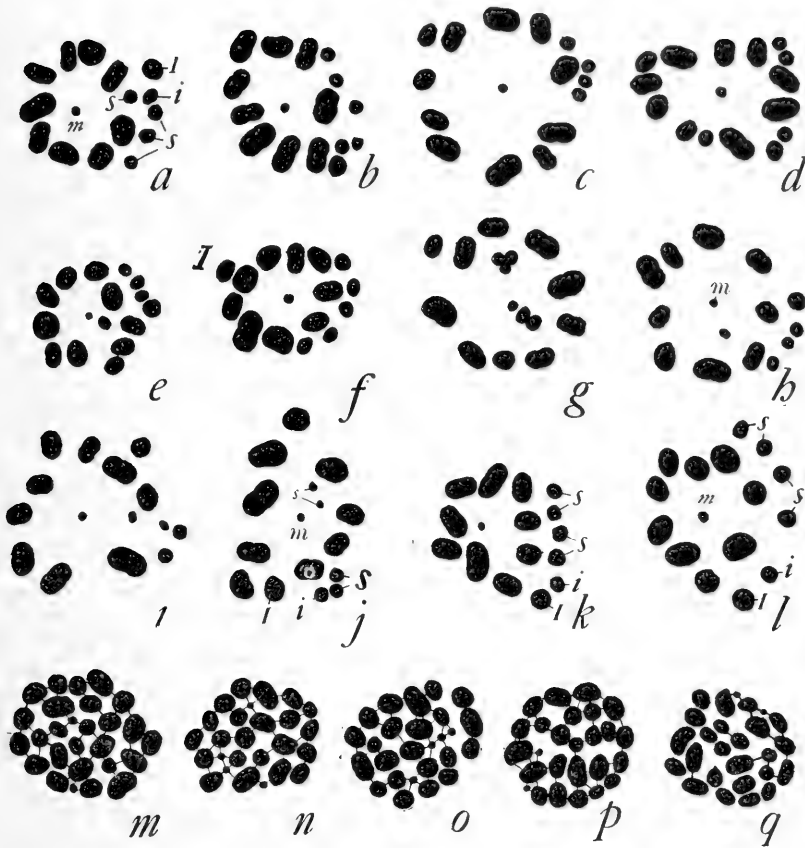

FIG. 9

26-chromosome forms, four supernumeraries

a-g, first polar, supernumeraries large and equal; *a-d*, fem., No. 42; *e*, gran., No. 55; *f*, gran., No. 59; *g*, gran., No. 60.

h-j first polar, from (fem., No. 40, with two large supernumeraries and two small; all of these are shown in *j*, (cf. Fig. 2, *j*), while in *h* and *i* one is missing (see p. 186).

k, first polar, term., No. 36; *l* from same individual (Photo 9).

m-o, spermatogonia groups; *m*, fem., No. 42, abnormal group with 27 chromosomes; *n*, *o*, fem., No. 40, showing two small supernumeraries.

p-q, ovarian groups, gran. No. 61.

appearance which I at first thought must be due to an artificial clumping together of the chromosomes through defective fixation; but the study of very many of these figures convinced me that such is not the case. As in the preceding types, ten of the chromosomes, including the *m*-chromosomes, have the form of symmetrical dumb-bell shaped bodies which are equally halved in the ensuing division. The remaining chromosomes are usually aggregated to form a compound element (Fig. 10, *h-l*, Photos 22, 23) in which may be very clearly distinguished the same components as those that appear in the chromosome-nucleoli of the growth-period; and the size-relations make it evident that one of them is the large idiochromosome, one the small, while four are the supernumeraries. In other words, these six chromosomes, which divide as separate univalents in the first division, have now again conjugated to form a hexad group. This compound element almost always lies near the center of the group. Polar views of this division accordingly show typically 11 chromosomes, of which the central one is compound (Figs. 10, *a-g*, Photo 13). Not infrequently, however, one or more of the supernumeraries may be separate from the others (Fig. 10, *f, g*), the apparent number in polar view varying accordingly.

In side views the grouping of the components of the hexad element is seen to vary considerably though the large idiochromosome is more frequently at one end of the group. In the ensuing division the other ten chromosomes divide equally, while the hexad element breaks apart into two groups that pass to opposite poles (Fig. 10, *l-p*). The distribution of the various elements is difficult to determine exactly, since they always lag behind the others in the anaphases and are scattered along the spindle in such a way as often to give confusing pictures. The study of many such anaphases leads me to conclude, however, that at least one of the smaller components always passes to the opposite pole from the larger one, while the other four undergo a variable distribution. In Fig. 10, *l*, the group is just separating into three toward each pole; in 10 *m*, it is quite clear that three of the small ones are passing to one pole, while the large one and two small ones are passing to the other, and Fig. 10, *n*, is probably a similar case. In these

cases it seems clear that each pole receives 13 chromosomes, as follows:

$$a \quad 10 + I + 2s = 13$$

$$b \quad 10 + i + 2s = 13$$

Fig. 10, *o*, on the other hand, shows a perfectly clear case in which the hexad element has separated into a 2-group and 4-group: Fig. 10, *p*, shows what is probably a later stage of the same type. In both these cases one pole appears to receive 12 and one 14 as follows:

$$a \quad 10 + I + 3s + 14$$

$$b \quad 10 + i + s = 12$$

one pole receiving but one supernumerary, and the other three. The cases in which all of the components may be clearly recognized in the anaphases are comparatively rare, and in the greater number of them the distribution of the supernumeraries appears to be symmetrical. Of their unsymmetrical distribution in some cases there can be no doubt (and the same is true of the 14-chromosome form, as described beyond). The few undoubted cases of this all show one to one pole and three to the other (as in Fig. 10, *o-p*), and I have never found a case in which all four pass to the same pole.

It seems, therefore, probable that in the 26-chromosome type there are at least six classes of spermatozoa, as follows:

$$(1) \quad 10 + I + 2s = 13$$

$$(2) \quad 10 + i + 2s = 13$$

$$(3) \quad 10 + I + s = 12$$

$$(4) \quad 10 + i + 3s = 14$$

$$(5) \quad 10 + I + 3s = 14$$

$$(6) \quad 10 + i + s = 12$$

It is possible that the following four additional classes may be produced:

$$(7) \quad 10 + I + 4s = 15$$

$$(8) \quad 10 + i = 11$$

$$(9) \quad 10 + I = 11$$

$$(10) \quad 10 + i + 4s = 15$$

Perfectly clear spermatogonial figures of this type were rarely found, though many of them show approximately 26. The normal group of fem., No. 42, is shown in Fig. 2, *h*. Two groups from fem. No. 40 (with two small and two large supernumeraries) are shown in Fig. 9, *n, o*, each having 26 chromosomes including four small ones (cf. Fig. 2, *k*). Two ovarian groups from gran., No. 61,

FIG. 10

26-chromosome forms

a-g, second division, polar, *d* from fem. No. 40, the others from fem. No. 42; *a*, (Photo 13) *b*, *c*, show a single central hexad; in *e* and *g* the components are more loosely united; in *d* and *f* one supernumerary is free.

h-p, side-views, second division, from fem. No. 42 (Photos 22, 23) explanation in text.

q-u, growth-period, gran. No. 60; *q* and *r* show the compound chromosome-nucleolus in oblique and side-view, *s*, *t*, *u*, *en face*.

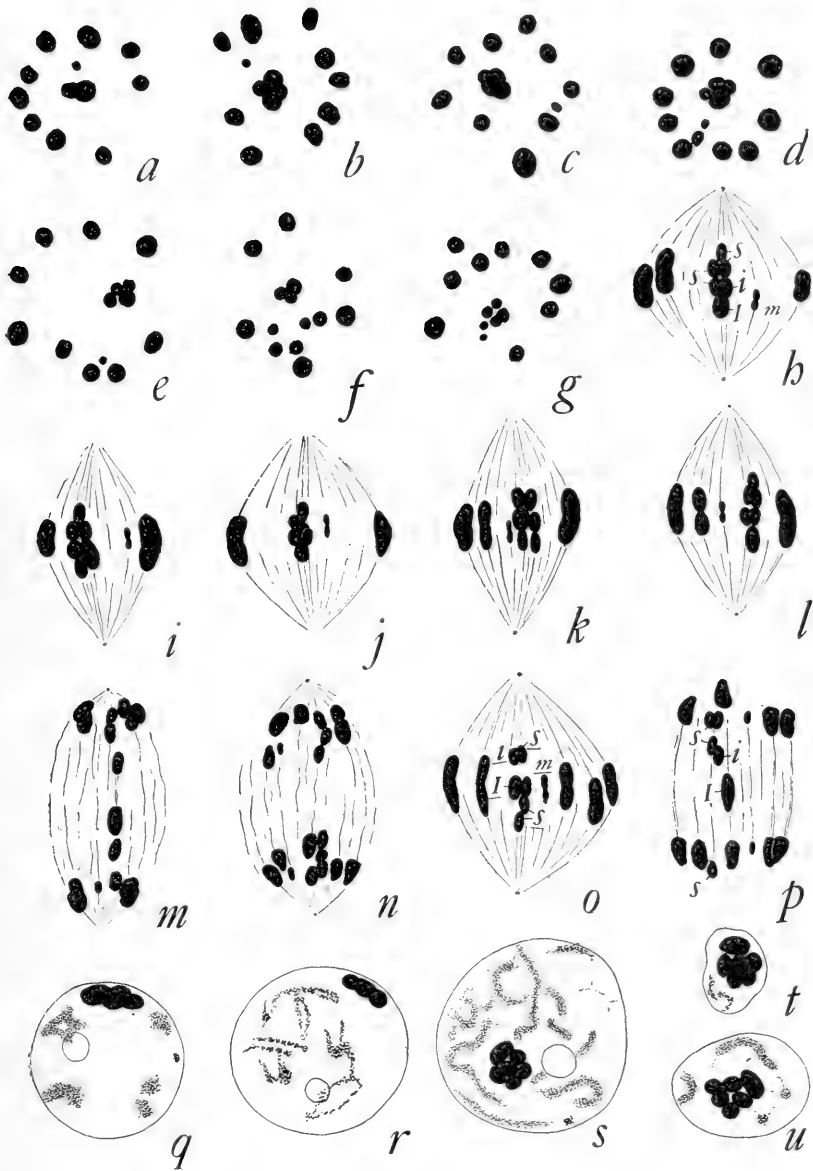

FIG. 10

FIG. 11

24-chromosome forms, two supernumeraries.

- a-e*, term., No. 21, first polar, showing various groupings; *g*, the same, gran., No. 52 (Photo 7).
h, term., No. 21, second polar, tetrad element near center.
i-o, somatic groups from individuals with two large supernumeraries; *i-l*, spermatogonial groups from term. No. 21; *m, n*, ovarian groups from fem. No. 31; *o*, ovarian group, fem., No. 45.
p-r, spermatogonial groups from fem., No. 22, with one large supernumerary and one small; Photo 30).
s-w, second division, side-view; *s*, term., No. 21; *t-w*, gran., No. 52 (Photo 21).

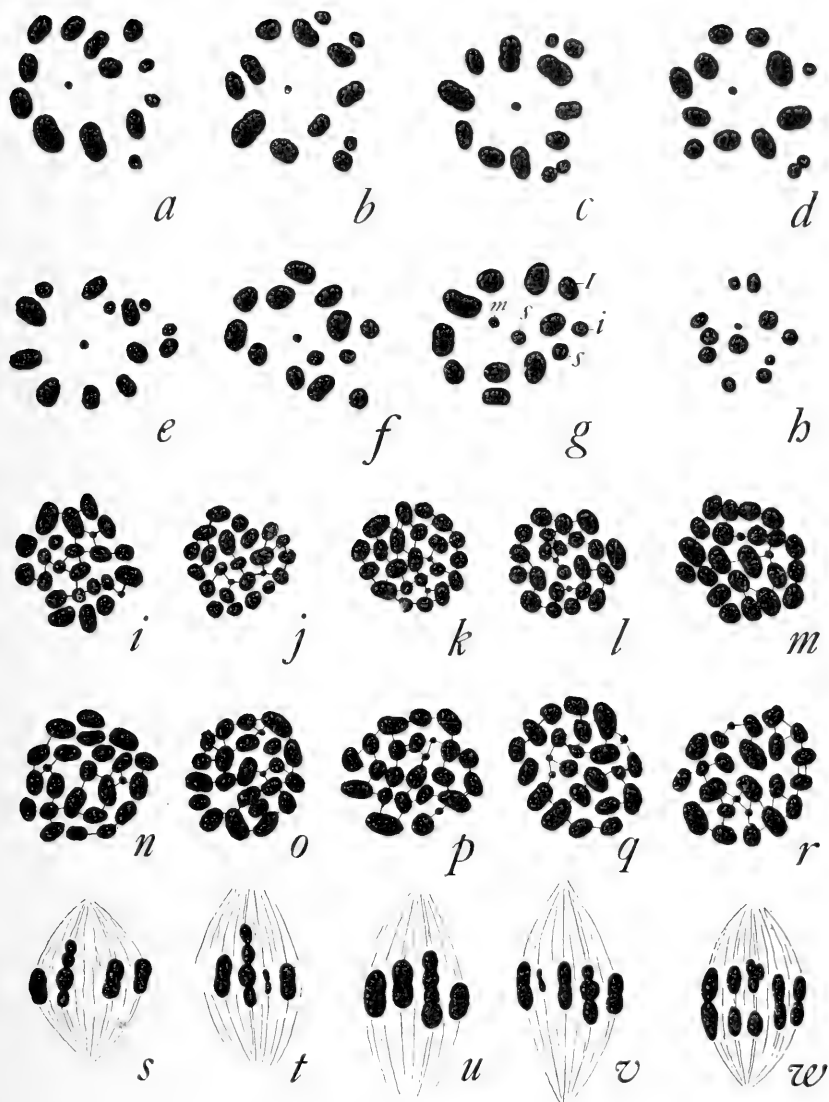

FIG. 11

are shown in Fig. 9, *p, q*. Fig. 9, *m*, shows a spermatogonial group from fem., No. 42, that is abnormal in showing with perfect clearness 27 instead of 26 chromosomes (cf. Fig. 2, *h*).

5 *Individuals with twenty-four Chromosomes; two Supernumeraries*

The material for these individuals and those of the 25-chromosome class, is less satisfactory than in the preceding case, but the relations are undoubtedly quite analogous to those just described. The 24-chromosome class is represented by 9 males and 4 females, and occurs in all three species. In one of the males one of the supernumeraries is large (of the same size as a small idiochromosome) and one small; in all the others both are large. Additional figures of the first division, showing variations in the grouping, are given in Fig. 11, *a-g*; of spermatogonial groups in Figs. 11, *i-r*. Of particular interest is the male, term., No. 22, shown in Photo 30 and in Fig. 11, *p-r*. This individual was, unfortunately, immature showing only spermatogonia and cells in the growth-period; but many perfectly clear spermatogonial groups are shown. These groups uniformly show 24 chromosomes, of which three are very small, while in many cases two others are slightly but distinctly smaller than the others. The latter are evidently the small idiochromosome and the larger supernumerary, while the three small ones represent the *m*-chromosomes and the small supernumerary.

In the second division the two idiochromosomes and the supernumeraries are frequently united to form a tetrad element, various forms of which are shown in Fig. 11, *s-w*. The distribution of these four components is not so well shown in this material as in that of the 26-chromosome class, described above. It is, however, clear that this distribution is inconstant. In cases like those shown in Fig. 11, *s, t*, it is probable that the tetrad divides in the middle, so that each idiochromosome is accompanied by a supernumerary, and each pole receives 12 chromosomes. The cases shown in Fig. 11, *v, w*, prove however that this is not always the case; for in *w* the large idiochromosome is seen passing to one pole while both supernumeraries, attached to the small idiochromosome,

are passing to the other. In this case one pole receives 11 chromosomes, the other 13. It is evident that in this form there is the possibility of forming six classes of spermatozoa, as follows:

$$(1) 10 + I = 11$$

$$(2) 10 + i + 2s = 13$$

$$(3) 10 + I + s = 12$$

$$(4) 10 + i + s = 12$$

$$(5) 10 + I + 2s = 13$$

$$(6) 10 + i = 11$$

In none of these individuals is the material very favorable for the study of the chromosome-nucleoli. They are always evidently compound, but only in a few cases can the components be clearly recognized (as in Fig. 2, *c*).

6 *Individuals with twenty-five Chromosomes; three Supernumeraries*

No individuals of this type were found in *M. femoratus*. The other two species are represented by three males and three females but here again the material does not admit of exhaustive study. In one of the females, two of the supernumeraries are large and one small, the ovarian cells showing 25 chromosomes, of which three are very small (Fig. 12, *i-k*), a condition seen in every group of which a clear view can be had. The two larger supernumeraries cannot, however, be certainly identified in any of these. In all the other individuals the supernumeraries are of the larger form. Fig. 12, *a, b*, show the first division in one of these cases (term., No. 34); *c-g* are spermatogonial groups from the same individual; *h*, an ovarian group of the same type. Fig. 12, *m-p*, are from a doubtful case in which nearly all the first division figures show three supernumeraries (*n, o*), but a single case (*m*) shows distinctly four.

7 *Individuals with twenty-seven Chromosomes; five Supernumeraries.*

This class is represented by a single very interesting male of *granulosus* (No. 57), in which only the first division can be satisfactorily examined. Many polar views of this division show 17 chromosomes (Fig. 13, *a-i*, Photo 10), of which two are always

smaller than the others. One of these, always central in position, is evidently the *m*-chromosome bivalent. Of the remaining six, one is in most cases decidedly smaller than the others—a relation

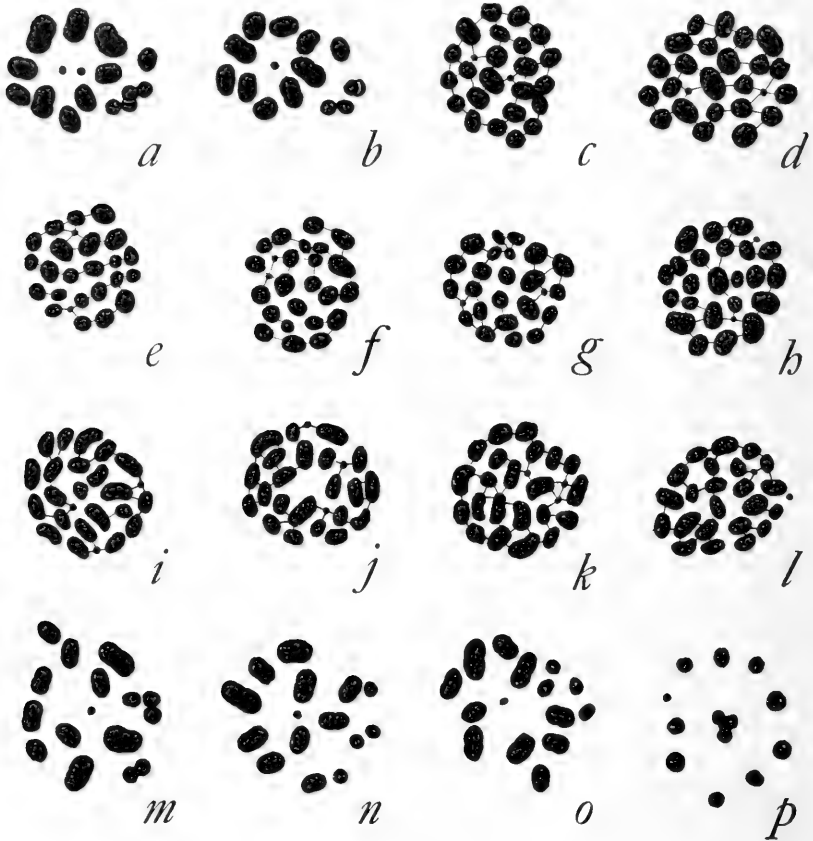

FIG. 12

25-chromosome forms, three supernumeraries

a, b, first polar, term., No. 34; *c-g*, spermatogonial groups from same individual; *h*, term., No. 38, ovarian group; *i-k*, ovarian groups from term., No. 27, with two large supernumeraries and one small; *l*, gran., No. 58, ovarian groups, three large supernumeraries.

m, n, o, first division, *p*, second division from gran., No. 54, with three or four supernumeraries.

of which the constancy is attested by the nine figures given of this division. It is evident that in this individual there are four large supernumeraries and one small; and although nospermatogonia

are clearly shown it may be inferred that the somatic number is 27. The chromosome-nucleoli in this individual are evidently compound, but in no case can all the components be clearly recognized. The second division shows, as a rule, 11 elements in polar view, the central one being compound (Fig. 13, *j-k*), but the distribution of the compound element could not be determined.

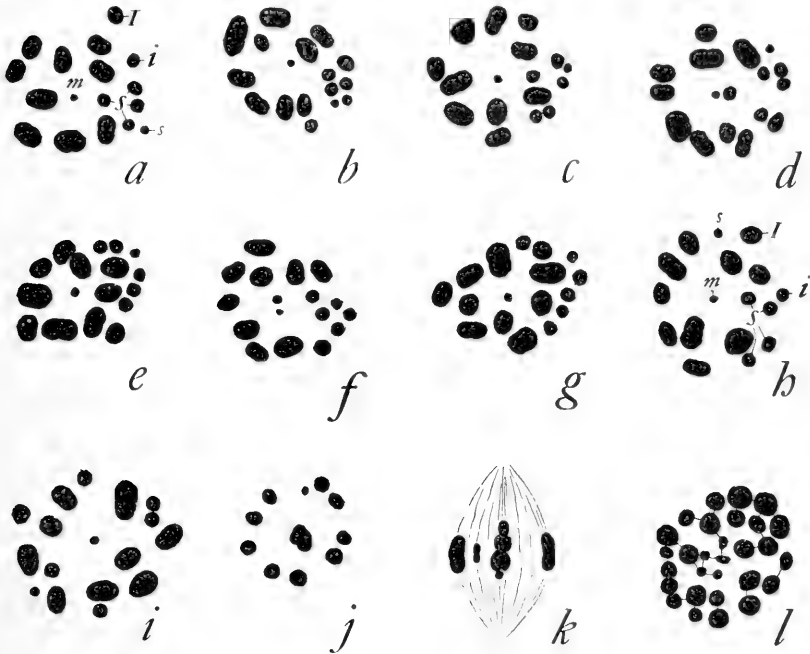

FIG. 13

27 and (?) 28-chromosome forms

a-i, first division, from gran., No. 57, having four large supernumeraries and one small *j* (polar) and *k* (side-view), second division, same individual (Photo 10).

l, ovarian group from fem., No. 33, having three large and two or three small supernumeraries; in this group appear 28 chromosomes.

8 Individuals with twenty-eight (?) Chromosomes; six Supernumeraries.

The last case to be considered is that of a single female of femoratus (No. 33), in which the number is either 27 or 28. A single perfectly clear ovarian group, shown in Fig. 13, *l*, shows beyond

doubt 28 chromosomes, including five smallest ones and three or four next smallest. A few other less clear groups were seen in which appear but 27 chromosomes, the missing one being one of the smallest. In these cases one of the small ones may be hidden among the larger ones; but it is also possible that the 28-group is an abnormality. In this individual there are probably three larger supernumeraries and either two or three small ones.

C SUMMARY AND CRITIQUE

1 In the genus *Metapodius* the number of chromosomes is constant in the individual but varies in different individuals from 21 to 27 or 28. The number 21 appears only in the males of *M. terminalis* (Montgomery's material).

2 The number is independent of sex and locality, and is not correlated with constant differences of size or visible structure in the adults.

3 The variation affects only a particular class of chromosomes.

4 The 22-chromosome forms represent the type from which all the others may readily be derived. These forms possess a pair of unequal idiochromosomes which show the same behavior as in *Lygæus* or *Euschistus*, all the spermatozoa receiving 11 chromosomes, and half containing the large idiochromosome, half the small.

5 In the 21-chromosome forms the small idiochromosome has disappeared, leaving the large one as an "odd" or "accessory" chromosome. Half the spermatozoa accordingly receive 11 chromosomes and half 10.

6 Numbers above 22 are due to the presence of from one to five or six additional small chromosomes which show in every respect the same behavior as the idiochromosomes, and are probably to be regarded as additional small idiochromosomes. In the growth period they have a condensed form and are typically associated with the idiochromosomes to form a compound chromosome-nucleolus. In the first division they divide as separate univalents. In the second, they are typically (though not invariably) again associated with the idiochromosomes to form a compound element. The components of this element undergo a variable distribution

to the spermatid nuclei. All the spermatid nuclei receive the haploid type-group of 11 chromosomes, half including the small idiochromosomes and half the large; but in addition each may receive one or more supernumeraries. The total number of chromosomes in the sperm nuclei is therefore variable in the same individual.

7 Both the number of the supernumeraries and their size, individually considered, are constant in the individual.

The first question that the foregoing report of results will raise is whether the number and size relations of the chromosomes in each individual are really as constant as I have described them. I have for the most part selected for illustration and description the more typical conditions; but, granting the accuracy of the figures, does such a selection really give a fair presentation of the actual conditions? It is almost needless to say that very many cases might have been shown that would seem to give conflicting results. By far the greater number of these discrepancies are, I believe, only apparent. Numerical discrepancies of this kind are very often evidently due to mere accidents of sectioning or to the superposition or close contact of two or more chromosomes. Again, apparent discrepancies in the size relations of the chromosomes, as seen in polar views, very often arise through different degrees of elongation (particularly in the maturation divisions). But apart from such apparent variations, real deviations undoubtedly occur in almost all of the relations described. Now and then, for example, a spermatogonial or ovarian group is found that clearly shows one chromosome too many (as in Fig. 9, *m*),⁹ and the same is true of the first spermatocyte-division, but such cases are very rare. The former case is probably a result of an abnormality in the formation of the chromosomes from the resting nucleus, the latter not improbably to a failure of synapsis. Again, both spermatogonial and spermatocyte-cysts are occasionally found in which the number of chromosomes is doubled or quite irregular. These are

⁹ A perfectly clear case of this has been found in the pyrrochord species *Largus cinctus* (a particularly fine form for study). In this form the normal male number is 11, the female 12; but in one female three cells were found each of which shows with all possible clearness 13 chromosomes, very many other cells showing the normal number.

probably due to an antecedent nuclear division without cell division, or to multipolar mitoses such as now and then occur in both spermatogonia and spermatocytes.

As regards the chromosome-nucleoli of the growth-period, the contrast between those of the 21 and 22-chromosome forms, or between either of these forms and those with higher numbers is usually at once apparent; but in very many cases where more than one supernumerary is present the number of components can only here and there be clearly seen. Contrary to what might be expected from their compact form, the compound chromosome nucleoli seem to be rather difficult of proper fixation, their components often clumping together or breaking up more or less when they coagulate. I infer this from the fact that different slides differ materially in the clearness with which these bodies are shown.

Two discrepancies, apparent or real, should be especially mentioned. One is the difficulty of recognizing the larger supernumeraries in the somatic groups. As already explained, these chromosomes, like the idiochromosomes, appear relatively much larger in the somatic groups than in the first maturation division (owing to their univalence in the latter case); but we should expect to recognize them more clearly, at least in the female groups, than is actually the case. This is perhaps due to their undergoing a greater degree of condensation than the others during the growth-period; but I am not sure that this explanation will suffice. A second discrepancy, which may involve an important conclusion, is that in perfectly clear views of the first division, the number of supernumeraries is often less than would be expected from the spermatogonial groups. This is notably the case with *femoratus*, No. 40 (Fig. 9, *h-j*), which has clearly 26 spermatogonial chromosomes, but very rarely shows 16 in the first division, the usual number being 15. A similar discrepancy has been noted in other individuals, and in several of the types. Since the typical number in all these cases appears in some or many of the first spermatocytes, I long supposed the occasional deficiency to result from an accident of sectioning. I now incline to believe, however, that in some cases one (or possibly more) of the supernumeraries may really disappear (by degeneration?) during the growth-period,

and that this may be one way in which their progressive accumulation in number in successive generations is held in check.

For the foregoing reasons it cannot be said that any of the relations described appear with absolute uniformity or fixity. The condition typical of each individual must be discovered by the study and comparison of large numbers of cells. I will only say that prolonged and repeated study has thoroughly convinced me that the relations, as described, may be regarded as being on the whole individual constants. This judgment is based primarily on the exhaustive study of a few of the best series of preparations of individuals of the 21, 22, 23, and 26-chromosome types, in which the facts are quite unmistakable and have given the point of view from which the less favorable material of other cases may fairly be examined.

D DISCUSSION OF RESULTS

The principal significance of these phenomena seems to me to lie in their bearing on the general hypothesis of the "individuality" or genetic continuity of the chromosomes; but they are also of interest for a number of more special problems which I will first briefly consider.

The Relation of the Chromosomes to Sex-production in Metapodius

The conditions seen in this genus seem to be irreconcilable with any view that ascribes the sexual differentiation to a general quantitative difference of chromatin, whether expressed in the number or the relative size of the chromosomes. In all known cases of constant sexual differences in the chromosomes it is invariably the female that possesses the larger number of chromosomes or the greater quantity of chromatin,¹⁰ and this has naturally suggested the view that this difference *per se* may be the sex-determining factor. As I have pointed out before ('09), such a view is inapplicable to cases like *Nezara* or *Oncopeltus*, where the idiochromosomes are of equal size and no quantitative sexual differences are visible; yet the phenomena in these genera are otherwise so closely similar

¹⁰ See review in Wilson '09.

to those seen in other insects that I cannot doubt their essential similarity also in respect to sex-production.

In *Metapodius* the facts are still more evidently opposed to the quantitative interpretation. The number of chromosomes has here no relation to sex-production; and, as will be seen from the table at p. 149, in the forms with supernumeraries the relative frequency of high numbers and of low is nearly equal in the two sexes. If my general interpretation of the chromosomes in this genus be correct, a like conclusion applies to the total relative mass of chromatin in the two sexes; for all individuals alike possess the type-group of 22 chromosomes (Montgomery's form excepted) while the supernumeraries represent the excess above this amount. I have endeavored to determine whether this appears in direct measurements, independently of my general interpretation; but have found this impracticable for several reasons. Very considerable differences in the apparent size of the chromosomes are produced by different degrees of extraction; but this will not account for the considerable differences seen in the same slide when the extraction is uniform. It is evident that the actual size of the chromosomes varies with the size of the cells; for example, both in *Metapodius* and in many other genera, the chromosomes in the larger spermatogonia near the tip of the testis are larger (in many cases much larger) than those of the smaller spermatogonia of other regions. How great the differences are may be appreciated by a comparison of the figures. For example, in the spermatogonial groups of No. 2 (23 chromosomes, Fig. 7, *v-x*), the chromatin mass is obviously much greater than in those of No. 21 (24 chromosomes, Fig. 11, *i-l*). In the 25-chromosome female groups shown in Fig. 12, *i-k* (No. 27), the chromatin mass is evidently much less than in the 21-chromosome male group shown in Fig. 1, *b*, or in the 23-chromosome male groups of Fig. 7, *v-x*. Conversely, the 22-chromosome female group of No. 44 (Fig. 4, *s*) shows a much greater chromatin mass than in the corresponding male group of No. 46 (Fig. 4, *o*), or the male 24-chromosome group shown in Fig. 11, *j*.

Evidently, therefore, the relative mass of chromatin can only be determined by means of accurate measurements of both the

chromosomes and the mass of protoplasm, but I have found the errors of measurement of the cell size to be too great to give any trustworthy result regarding the relative chromatin mass.

Despite the difficulties in the way of an accurate direct determination, I believe the facts on the whole warrant the conclusion that the relative chromatin mass shows no constant correlation with sex. The most probable conclusion is that the male-producing spermatozoa in *Metapodius* are distinguished by the same characters as in other forms having unequal idiochromosomes, the former class being those that receive the large idiochromosome, the latter those that receive the small one, irrespective of the supernumeraries that may be present in either class. For reasons that I have elsewhere stated, I believe that if the idiochromosomes be the sex-determinants their difference is probably a qualitative one, and since the small idiochromosome may be lacking it would seem that the large one must in every case play the active rôle—perhaps as the bearer of a specific substance (enzyme?) that calls forth a definite reaction on the part of the developing individual. If this be so, we can comprehend the fact that the presence of additional small idiochromosomes (supernumeraries) in either sex does not affect the development of the sexual characters in that sex.

b The possible Origin of the unpaired Idiochromosome ("odd" or "accessory" Chromosome) and of the Supernumeraries

The explanation of the unpaired idiochromosome offered in the second and third of my "Studies on Chromosomes" ('05, '06) was suggested by the fact that various degrees of inequality exist in the paired idiochromosomes, there being an almost continuous series of forms connecting those in which the idiochromosomes are equal (*Nezara*, *Oncopeltus*) with those in which they are so very unequal that the small one appears almost vestigial (*Lygæus*, *Tenebrio*). It is evident that by the further reduction and final disappearance of the small member of this pair the large one would be left without a mate, and its history in the maturation process would become identical with that of an "odd" or "accessory"

chromosome. I still believe that this explanation may be applicable to many cases; but a different one seems more probable in the case of *Metapodius* and perhaps may be more widely applicable. This was suggested by the observation (p. 166) that in a very few cases, in 22-chromosome individuals both idiochromosomes were seen passing to the same pole in the second division. The rareness of this occurrence shows that it is doubtless to be regarded in one sense as abnormal. But even a single such event in an original 22-chromosome male, *if the resulting spermatozoa were functional*, might give the starting point for the whole series of relations observed in the genus, including the establishment of an unpaired idiochromosome. The result of such a division should be a pair of spermatozoa containing respectively 10 and 12 chromosomes. The former might give rise at once to a race having an unpaired idiochromosome and the somatic number 21 in the male (as in Montgomery's material). The latter might similarly produce an individual having in the first generation a single supernumerary chromosome and in succeeding generations an additional number. This appears from the following considerations:

1 If a 10-chromosome spermatozoön, arising in the manner indicated, should fertilize an egg of the 22-chromosome class (having 11 chromosomes after reduction) the result should be a male containing 21 chromosomes, the odd one being the large idiochromosome derived from the egg. Such an individual would be in no respect distinguishable from those of Montgomery's material, and would similarly form male-producing spermatozoa containing 10 chromosomes and female-producing ones containing 11 (including the unpaired idiochromosome). A single such male, paired with an ordinary 22-chromosome female, would suffice to establish a stable race identical with the form found by Montgomery at West Chester, Pa., the males having 21 chromosomes, the females having 22, precisely as in *Anasa* or *Leptoglossus*. This seems to me the most probable explanation of the conditions found in Montgomery's material; and possibly it may explain the origin of the unpaired idiochromosome in other cases as well.

2 The result of fertilizing the same type of egg by a spermatozoön from the 12-chromosome pole would be an individual having

23 chromosomes (egg 11 + spermatozoön 12) including two large idiochromosomes—hence presumably a female—and one small. The eggs produced by such a female should after maturation be of two classes, having respectively 11 and 12 chromosomes. The 12-chromosome class would contain both a large and a small idiochromosome, and if fertilized by ordinary 11-chromosome spermatozoa would produce individuals with 23 chromosomes, male or female according to the class of spermatozoön concerned. Such females would, as before, contain two large idiochromosomes and one small. The males would contain one large and two small, and would accordingly produce spermatozoa having either 11 or 12 chromosomes.

Now, such an additional small idiochromosome in the male would be indistinguishable from a single "supernumerary chromosome" as it appears in the 23-chromosome individuals in my material. The resemblance is shown not only in size but also in behavior; for, as I have shown, the supernumerary, like the idiochromosome, forms a chromosome-nucleolus during the growth period, it divides as a univalent in the first division, and in the second is usually associated with the idiochromosome bivalent. A single such supernumerary chromosome, once introduced into the race would lead to the presence of additional ones in succeeding generations. Thus, 12-chromosome eggs fertilized by 12-chromosome spermatozoa would give individuals (male or female) with 24 chromosomes, including two supernumeraries; and from these might arise, through irregularities of distribution such as I have described, gametes with 11, 12, or 13 chromosomes, giving in the next generation 22, 23, 24, 25 or 26 chromosomes according to the particular combination established in fertilization.¹¹ If this

¹¹ Since the presence of an unpaired idiochromosome in some individuals and of supernumeraries in others is assumed to be traceable to the same initial cause, we should naturally expect to find the two conditions coexisting side by side, and in approximately equal numbers; but in point of fact the former is very rare and was only found in one locality, while the latter is very common. This may constitute a valid objection to my interpretation. It should be borne in mind, however, that abnormal divisions of the kind assumed to form the starting point are very rare, and that an extremely minute proportion of the total number of spermatozoa produced ever actually enter the eggs. The chances against fertilization by either class of the original modified spermatozoa are therefore very great. Since only sixty individuals have been examined it need not surprise us that one of the two conditions in question

interpretation be correct, the origin of an unpaired chromosome in certain individuals of this genus has been owing to the same cause that has produced the supernumeraries. Since both conditions coexist in the same species, along with that which may be regarded as the original type (22 chromosomes) it may be concluded that *Metapodius* is now in a period of transition from the second to the third of the types distinguished in my last study. It seems quite possible that other species of coreids that now have constantly an unpaired idiochromosome may have passed through a similar condition, though in all of them thus far examined both the small idiochromosome and the supernumeraries have disappeared. In *Metapodius*, accordingly, the supernumeraries may be regarded as on the road to disappearance. That such is the case is rendered probable by the fact that their number does not pass a certain limit, and is rarely more than four. The very small chromosomes of this kind, so often observed, are perhaps degenerating, or even vestigial in character. But aside from this, attention has already been called to the probability that one or more of the supernumeraries may be lost during the growth-period (p.186); and while this is not certain, it may well be that both methods are operative in their disappearance.

The foregoing interpretation of the supernumeraries enables us to understand why variations in their number are not accompanied by corresponding morphological differences in the somatic characters; for they are but duplicates of a chromosome already present and hence introduce no new qualitative factor. It can hardly be doubted that some kind of quantitative difference must exist between individuals that show different numbers, but none

has been more frequently met with. Another objection might be based on the different relations that occur in *Syromastes*. In this form (see Wilson '09) the passage of both idiochromosomes to one pole without separation is a normal and constant feature of the second division, yet no supernumeraries appear in any of the individuals, and it is probable that the female groups contain two pairs of idiochromosomes like the single pair that appears in the male. We have no data for a conjecture as to how such a condition can have arisen; but evidently the small idiochromosome does not in this case become an erratic supernumerary but retains a definite adjustment to the other chromosomes. Still, I do not consider this an obstacle to my interpretation of *Metapodius*, for it is now evident that the history of the idiochromosomes in general has differed widely in different species and families, even among the Hemiptera. We have thus far only made a beginning in their comparative study. [See Addendum, p. 200.]

has thus far been discerned. Such a difference does not appear in the size of the animals, for there are large individuals with no supernumeraries and small individuals that possess them. An interesting field for experiment seems here to be offered.

c The "Individuality" or Genetic Continuity of the Chromosomes

It is in respect to this much debated hypothesis that the facts observed in *Metapodius* seem to me most significant and important. It is evident that the whole series of relations are readily intelligible if the fundamental assumption of this hypothesis be accepted. Without such explanation they seem to me to present an insoluble puzzle. The disposition to reject this hypothesis that appears in a considerable number of recent papers on the subject will doubtless lead to more critical and exhaustive observation of the facts; but when it goes so far as to deny every principle of genetic continuity in respect to the chromosomes, it is, I believe, a backward step. This reaction perhaps reaches a climax in the elaborate and apparently destructive criticism of Fick ('07) who considers the hypothesis to be thoroughly discredited, and believes his analysis to justify the conclusion: "*Dass weder theoretisch noch sachliche Beweise für die Erhaltungslehre vorliegen, sondern dass im Gegenteil unwiderlegliche Beweise gegen sie vorhanden sind, so dass es im Interesse der Wissenschaft dringend zu wünschen ist, dass die Hypothese von allen Autoren verlassen wird*" ('07, p. 112, italics in original). I incline to think that this sweeping judgment would have carried greater weight had Professor Fick, in certain parts of his able and valuable discussion, taken somewhat greater pains in his presentation of facts and shown a more judicial temper in their analysis.¹² To some of the objections and difficulties

¹² I will give two specific examples of this. The experimental results of Moenkhaus ('04), on hybrid fishes, which evidently form a strong support to the continuity hypothesis, are unintentionally but completely misrepresented in the statement at p. 75: "So berichtet Moenkhaus bei Fundulus-Monichia-kreuzung (*sic*), dass sich die beiderlei (zuerst sehr verschiedenartigen) Chromosomen in der Regel schon nach der zweiten Teilung nicht mehr unterscheiden lassen." But Moenkhaus's explicit statement, based on the examination of "many thousand cells," is that even in the late cleavage "Nuclei showing the two kinds of chromosomes mingled together upon the spindle are everywhere to be found" (op. cit., p. 48). Fick evidently had in mind the fact that the paternal and maternal chromosomes do not as a rule retain their original grouping after the first two or three cleavages. His actual statement, however,

brought forward in this critique reply has already been made by Boveri ('07), Strasburger ('08), Schreiner ('08) Bonnevie ('08) and others. Some of the difficulties are real, but an attentive study of the matter will show that a large part of Fick's critique is directed against the strict hypothesis of individuality and offers no adequate interpretation of the essential phenomenon that requires explanation. It may be admitted that many of the facts seem at present difficult to reconcile with the view that the identity of the chromosomes as actual individuals is maintained in the "resting" nucleus; and I have myself indicated (*The Cell*, 1900, p. 300) that the name "individuality" was perhaps not the best that could have been chosen. Certainly we have as yet comparatively little evidence that the chromosomes retain their boundaries in the "resting" nucleus. It is evident that the chromosomes are greatly diffused in the nuclear network, and it may be that the substances of different chromosomes are more or less intermingled at this time. Fick's "manœuvre-hypothesis," which treats the chromosomes of the dividing cell as temporary "tactic formations," may therefore be in some respects a more correct formulation of the facts than that given by the hypothesis of "individuality" in the strict sense of the term. But the last word on this question has by no means yet been spoken. A new light is thrown on it by the recent important work of Bonnevie ('08) which brings forward strong evidence to show that in rapidly dividing cells (cleavage stages of *Ascaris*, root-tips of *Allium*), although the identity of the orig-

(both here and in the later passage at p. 98) will wholly mislead a reader not familiar with Moenkhaus' work, in regard to one of the most significant and important discoveries in this whole field of inquiry.

Hardly less misleading is Professor Fick's report of my own observations on the sex-chromosomes of insects, which are stated as follows: "Wilson's Untersuchungen beweisen eben *sicher* nur soviel, dass bei einigen Insektengattungen constante Beziehungen zwischen dem Geschlecht und dem Vorhandensein eines besonderen Chromosomenpaares bestehen, bei anderen Gattungen *nicht*" (p. 90). I am confident that those who are familiar with the researches referred to will not accept this as a fair statement of the results. The fact is that in one form or other the sex-chromosomes are present in all of the forms that I have examined (now upwards of seventy species) and that with various modifications all conform to the same fundamental type. It is true that in two genera (*Nezara* and *Oncopeltus*) the sex-chromosomes are equal in size, and hence afford no *visible* differential between the somatic groups of the two sexes; but I especially emphasized the fact (cf. '06, pp. 17, 34) that these chromosomes are in every other respect identical with those of other forms in which the size-difference clearly appears, and are connected with the latter by a series of intermediate gradations that leaves no doubt of the essential uniformity of the phenomena.

inal chromosomes is lost in the "resting" nucleus after each mitosis, each new chromosome nevertheless arises by a kind of endogenous formation within and from the substance of its predecessor. In this way an individual genetic continuity of the chromosomes can be directly followed through the "resting period" of the nucleus. "Eine *genetische Kontinuität* der Chromosomen nacheinander folgender Mitosen konnte in der von mir untersuchten Objekten teils sicher (*Allium*, *Amphiuma*) teils mit überwiegender Wahrscheinlichkeit (*Ascaris*) verfolgt werden. Es ging aber auch hervor, dass eine *Identität* der Chromosomen verschiedener Mitosen *nicht existiert*, sondern dass *jedes Chromosom in einem früher existierenden endogen entstanden ist*, um wieder am Ende seines Lebens für die endogene Entstehung eines neuen Chromosoms die Grundlage zu bilden" (op. cit, p. 54). Whether this particular conclusion will also apply to more slowly dividing cells remains to be seen. But apart from this direct evidence it seems to me that a denial of every form of genetic continuity between the chromosomes of successive cell-generations—which, despite certain qualifications, seems to be the position of Fick and a number of other recent writers—is only possible to those who are ready to ignore some of the most obvious and important of the known facts, especially those that recent research has brought to light among the insects. The most significant of these are:

1 In *Metapodius* the specific number varies, while in the individual both the number and the size-relations of the chromosomes are constant.

2 In all species where the somatic chromosome-groups show sexual differences in regard to the number and size-relations of the chromosomes, exactly corresponding differences exist between the male-producing and the female-producing spermatozoa.

Both these series of facts demonstrate that the "tactic formation" of a fixed number of chromosomes of particular size is not a specific property of a single chromatin-substance as such, of the species. It has been assumed by some writers that departures from the normal specific number, such as appear in merogonic, parthenogenetic, double-fertilized or giant (double) eggs, are the result merely of departures from the normal quantity of chroma-

tin."¹³ If attentively considered the facts summarized above will, I think, clearly show the inadequacy of such an explanation. Why should a given quantity and quality of chromatin always reappear in the same morphological form as that in which it entered the nucleus? Why, for example, in *Metapodius* should the minute fraction of chromatin represented by a single small supernumerary always reappear in the form of such a chromosome, showing specific peculiarities of behavior, rather than as a corresponding enlargement of one of the other chromosomes? Why should a larger excess always appear as a group of two, three, or more supernumeraries that differ definitely in behavior from the others and show constant size relations among themselves? Specifically, in individual No. 40, why should two small supernumeraries and two large ones always appear, rather than three large ones? In species where a constant quantitative chromatin-difference exists between the sexes, why should the excess in the female always appear in the same form as that which appears in the female-producing spermatozoa—in one case as a large idiochromosome instead of a small (*Lygæus*), in another as an additional chromosome of a particular size (very large in *Protenor*, small in *Alydus*, of intermediate size in *Anasa*), in a third case as three additional chromosomes (*Galgulus*)?

To these and many similar questions which the facts compel us to consider, I am unable to find any answer on the merely quantitative hypothesis. Each of them receives a simple and intelligible reply under the view that it is the number, size, and quality of the chromosomes that enter the nucleus that determine the number, size, and mode of behavior of those that issue from

¹³ Fick's treatment of these cases is worth citing. "Es muss von vornherein als wahrscheinlich bezeichnet werden, dass unter den abnormen Umständen, da einmal die Zahl der 'Chromatin-Manövereinheiten' (im Sinne meiner Manöverhypothese gesprochen) in der Zelle erhöht ist, diese Zahl sich erhält" (p. 96). Why should the number be maintained? Because, we are told, "Die Erhaltung der erhöhten Zahl und ihre regelmässige Wiederkehr bei den folgenden Teilungen muss bei dem nun einmal über die Norm erhöhten Chromosomenbestand der Zelle als der *einfachere, leichter verständliche Vorgang* erscheinen, als es ein besonderer, ein "Regulation" auf die Norm hervorbringender Akt wäre." To most readers this will seem like an argument for, rather than against, the hypothesis of genetic continuity. But since it is obviously not thus intended I can discover no other meaning in the passage than that with a given "bestimmte Chromatinmanöverart" characteristic of the species (p. 115) the number of chromosomes formed is proportional to the quantity of chromatin-substance.

it. But such an answer implies the existence of a definite individual genetic relation between the chromosomes of successive cell-generations; and it is this relation, I take it, that forms the essence of the hypothesis of genetic continuity, whether or not we include in the hypothesis the assumption that the chromosomes persist as "individuals" in the resting nucleus where their boundaries seem to disappear. We might, for instance, assume that the chromosomes are magazines of different substances (e. g., enzymes or the like) that differ more or less in different chromosomes, that are more or less diffused through the nucleus in its vegetative phase, but are again segregated out in the original manner when the chromosomes reform.¹⁴ We have, admittedly, but an imperfect notion of how such a re-segregation may be effected, though the conclusions of Bonnevie already referred to, constitute an important addition to the earlier ones of Boveri (see '07, p. 232) in this direction. However this may be, in my view the most practicable, indeed the almost necessary, working attitude is to treat the chromosomes *as if they were* actually persistent individuals. The facts in *Metapodium*, which at first sight seem to present so chaotic an aspect, fall at once into order and become intelligible if regarded as due to the presence in the species of a certain number of erratic chromosomes, one or more of which may be introduced into the zygote at the time of fertilization and which in some sense retain their identity throughout the development. The particular combination established at the time of fertilization is the result of the chance union of two particular gamete combinations. Since the distribution of the supernumeraries to the spermatid nuclei is variable, different gamete combinations occur in the spermatozoa of the same individual; and the same is probably true of the eggs. Moreover, adults of the same species live side by side on the same food-plants and presumably may breed together. Different combinations may thus be produced in the offspring of a single pair, whether the parents possess the same or different numbers. *Metapodium* thus fulfills the prediction of Boveri, written nearly twenty years ago. "Wenn bei einer Spezies einmal sehr viele und verschieden-

¹⁴ A view similar to this is suggested by Fick himself in his earlier discussion ('05, p. 204), but it does not reappear in his later one.

artige Irregularitäten vorkämen, diese sich wohl auf lange hinaus erhalten müssten, so dass unter Umständen Fälle mit ausserordentlich grosser Variabilität der Chromosomenzahl zur Beobachtung kommen könnten, ohne dass selbst diese das Grundgesetz umstossen vermöchten, welches lautet: Es gehen aus jedem Kerngerüst so viele Chromosomen hervor als in die Bildung derselben eingegangen sind" ('90, p. 61). To the earlier expression of this "Grundgesetz" Boveri has recently added the statement that the chromosomes that emerge from the nucleus are not merely of the same number but also show the same size-relations as those that entered it. "Was durch den kurzen Ausdruck "Individualität der Chromosomen" bezeichnet werden soll, ist die Annahme dass für jedes Chromosoma, das in einen Kern eingegangen ist, irgend eine Art von *Einheit* im ruhenden Kern erhält, welche der Grund ist, dass aus diesem ruhenden Kern wieder genau ebenso viele Chromosomen hervorgehen und dass dieses Chromosomen überdies da, wo vorher verschiedene Grössen unterschieden waren, wieder in den gleichen Grössenverhältnissen auftreten" ('07, p.229).

The facts seen in *Metapodius* and other insects are thoroughly in accord with the foregoing statement, and justify the additional one that the chromosomes conform to the same principle in respect to their characteristic modes of behavior. In the Hemiptera heteroptera generally the idiochromosomes and supernumeraries, the *m*-chromosomes, and the "ordinary chromosomes" or "autosomes" show each certain constant peculiarities in respect to the time of synapsis and behavior during the growth-period, and assume a characteristic (though not entirely constant) mode of grouping in the first spermatocyte. Perhaps the most obvious of these facts is the very early condensation of the idiochromosomes and supernumeraries in the growth-period as contrasted with the other chromosomes; and in the case of *Pyrrochoris* I have shown ('09) that the idiochromosome never assumes a diffuse condition after the last spermatogonial division. But even more significant are the definite differences shown in the couplings of the various forms of chromosomes that take place in the course of the spermatogenesis. Nothing in these phenomena is more striking than the accuracy with which these couplings take place.

As Montgomery and Sutton have shown, the ordinary paired chromosomes of the spermatogonia give rise to bivalents of corresponding size at the time of general synapsis. The actual coupling of the ordinary chromosomes at this time is still a matter of dispute;¹⁵ but no doubt can exist in regard to the couplings that occur at a later period in case of the *m*-chromosomes, the idiochromosomes, and the supernumeraries. These characteristic couplings are not determined merely by the size of the chromosomes. The union of the unequal idiochromosomes after the second division takes place with the same regularity as that of the equal *m*-chromosomes in the prophases of the first. A small supernumerary that is indistinguishable from the *m*-chromosomes in the spermatogonia never couples with the latter in either division, but with the much larger idiochromosomes. The couplings are equally independent of the original positions of these chromosomes, either in the spermatogonia or in the growth-period, as is seen with especial clearness in case of the *m*-chromosomes. These phenomena naturally suggest the conclusion that the couplings result from definite affinities among the chromosomes. The possibility no doubt exists that the couplings are produced by extrinsic causes (such as the achromatic structures) but the evidence seems on the whole opposed to such a conclusion. I consider it more probable that they are due to intrinsic qualities of the chromosomes and that the differences of behavior shown by different forms may probably be regarded as due to corresponding physico-chemical differences. This conclusion is in harmony with Boveri's experimental results, though based on wholly different data. While it does not seem worth while to attempt its wider development here, I may express the opinion that all the chromosomes may consist in the main of the same material basis, differing only in respect to certain constituents; and further that the degree of qualitative difference may vary widely in different species.

Zoölogical Laboratory
Columbia University
August 10, 1908

¹⁵ See for example, Meves ('07, pp. 453-468) who, like O. Hertwig, Fick and others, rejects the theory of "individuality."

ADDENDUM

The probability in regard to the female groups of *Syromastes*, expressed in the footnote at p. 192 was first stated in my preceding paper ('09, p. 73) after a study of the male only. Since the present paper was sent to press I have had opportunity to examine females of this form. The facts are exactly in accordance with my prediction, the female groups containing 24 chromosomes, while the male number is 22. It now seems clear, however, that the two idiochromosomes of *Syromastes* do not correspond respectively to the large and the small idiochromosome of *Metapodius* or *Lygæus* but are equivalent, *taken together*, to the large idiochromosome or to the odd chromosome of *Anasa*, etc.

October 25, 1908.

WORKS REFERRED TO

- BONNEVIE, K. '08—Chromosomenstudien. I. Arch. f. Zellforschung, i, 23.
- BOVERI, Th. '90—Zellenstudien. III. Ueber das Verhalten der chromatischen Kernsubstanz bei der Bildung der Richtungskörper und bei der Befruchtung. Jena, 1890.
- '07—Zellenstudien. VI. Die Entwicklung dispermer Seeigel-Eier, etc. Jena, 1907.
- FICK, R. '05—Betrachtungen über die Chromosomen, ihre Individualität, Reduction, und Vererbung. Arch. Anat. u. Phys., Anat. Abth., Suppl. 1905.
- '07—Vererbungsfragen, Reduktions- und Chromosomenhypothesen, Bastard-Regeln. Merkel und Bonnet's Ergebnisse, xvi, 1906.
- FOOT, K. AND STROBELL, E. C. '07a—The "Accessory Chromosome" of *Anasa tristis*. Biol. Bull., xii.
- '07b—A Study of Chromosomes in the Spermatogenesis of *Anasa tristis*. Am. Journ. Anat., vii, 2.
- GROSS, J. '04—Die Spermatogenese von *Syromastes marginatus*. Zöol. Jahrb., Anat. Ontog., xii.
- LEFEVRE, G. AND MCGILL, C. '08—The Chromosomes of *Anasa tristis* and *Anax junius*. Am. Journ. Anat., vii, 4.
- MOENKHAUS, W. S. '04—The Development of the Hybrids between *Fundulus heteroclitus* and *Menidia notata*, etc. Am. Journ. Anat., iii.

- MEVES, Fr.—Die Spermatocytenteilungen bei der Honigbiene, etc. Arch. Mikr. Anat., lxx.
- MONTGOMERY, T. H. '01—A Study of the Germ-cells of Metazoa. Trans. Am. Phil. Soc., xx.
- '06—Chromosomes in the Spermatogenesis of the Hemiptera Heteroptera. Ibid., xxi, 3.
- PAULMIER, F. C. '99—The Spermatogenesis of *Anasa tristis*. Journ. Morph., xv, Suppl.
- SCHREINER, K. E. AND A. '08—Gibt es eine parallele Konjugation der Chromosomen? Videnskebs-Selskabets Skriffer. i. Math-Naturw. Klasse, 1908, no. 4.
- STEVENS, N. M. '06—Studies in Spermatogenesis. II. A Comparative Study of the Heterochromosomes in Certain Species of Coleoptera, Hemiptera and Lepidoptera, etc. Carnegie Institution. Pub. 36, ii.
- '08a—A Study of the Germ-cells of Certain Diptera, etc. Journ. Exp. Zoöl., v. iii.
- '08b—The Chromosomes in *Diabrotica vittata*, etc. Ibid., v, iv.
- STRASBURGER, E. '08—Chromosomenzahlen, Plasmastrukturen, Vererbungsträger und Reduktionsteilung. Jahr. wiss. Bot., xlv, iv.
- WILSON, E. B. '05a—Studies on Chromosomes, I. Journ. Exp. Zoöl., ii.
- '05b—Studies, etc. II. Ibid., ii, iv.
- '06—Studies, etc., III. Ibid., iii, 1.
- '09—Studies, etc., IV Ibid., vi, 1.
- '07a—Note on the Chromosome-groups of *Metapodius* and *Banasa*. Biol. Bull., xii, 5.
- '07b—The Supernumerary Chromosomes of Hemiptera. Report of May Meeting. N. Y. Acad. Sci. Science, n. s., xxvi, 677.
- '07c—The Case of *Anasa tristis*. Science, n. s., xxv, 631.

APPENDIX

List of individuals examined, arranged according to locality

No.	Species	Sex	Locality	Supernumeraries	Somatic No.	No. in first div.
1	terminalis	♂	Madison, N. J. (Paulmier)	1 small	23	13
2	terminalis	♂	Madison, N. J. (Paulmier)	1 small	23	13
3-11	terminalis	♂	West Chester, Pa. (Montgomery)	absent	21	11
12	terminalis	♂	West Chester, Pa. (Wilson)	absent	22	12
13	terminalis	♂	West Chester, Pa. (Wilson)	1 large	23	13
14	terminalis	♀	West Chester, Pa. (Wilson)	1 large	23	
15	terminalis	♀	West Chester, Pa. (Wilson)	2 large	24	
16	terminalis	♀	West Chester, Pa. (Wilson)	2 large	24	
17	terminalis	♂	Mansfield, Ohio	absent	22	12
18	terminalis	♀	Mansfield, Ohio	absent	22	
19	terminalis	♂	Raleigh, N. C.	absent	22	12
20	terminalis	♂	Raleigh, N. C.	1 large	23	13
21	terminalis	♂	Raleigh, N. C.	2 large	24	14
22	terminalis	♂	Raleigh, N. C.	1 large, 1 small	24	14
23	terminalis	♀	Raleigh, N. C.	absent	22	
24	terminalis	♀	Raleigh, N. C.	absent	22	
25	terminalis	♀	Raleigh, N. C.	1 large	23	
26	terminalis	♀	Raleigh, N. C.	2 large	24	
27	terminalis	♀	Raleigh, N. C.	2 large, 1 small	25	
28	femoratus	♂	Raleigh, N. C.	absent	22	12
29	femoratus	♂	Raleigh, N. C.	absent	22	12
30	femoratus	♀	Raleigh, N. C.	1 large	23	
31	femoratus	♀	Raleigh, N. C.	2 large	24	
32	femoratus	♀	Raleigh, N. C.	4 large	26	
33	femoratus	♀	Raleigh, N. C.	3 large 2-3 small	27-8	
34	terminalis	♂	Southern Pines, N. C.	3 large	25	15
35	terminalis	♂	Southern Pines, N. C.	3 large	25	15
36	terminalis	♂	Southern Pines, N. C.	4 large	26	16
37	terminalis	♂	Southern Pines, N. C.	2 large	24	14
38	terminalis	♂	Southern Pines, N. C.	3 large	25	
39	femoratus	♂	Southern Pines, N. C.	2 large	24	14
40	femoratus	♂	Southern Pines, N. C.	2 large, 2 small	26	16
41	femoratus	♀	Southern Pines, N. C.	1 large	23	
42	femoratus	♂	Columbia, S. C.	4 large	26	16
43	terminalis	♂	Charleston, S. C.	1 small	23	13
44	terminalis	♀	Charleston, S. C.	absent	22	

List of individuals examined, arranged according to locality—Continued

No.	Species	Sex	Locality	Supernumeraries	Somatic No.	No. in first div.
45	femoratus	♀	Charleston, S. C.	2 large	24	
46	femoratus	♂	Savannah, Ga.	absent	22	12
47	granulosus	♂	Tucson, Arizona	absent	22	12
48	granulosus	♂	Tucson, Arizona	1 large	23	13
49	granulosus	♂	Tucson, Arizona	1 large	23	13
50	granulosus	♂	Tucson, Arizona	2 large	24	14
51	granulosus	♂	Tucson, Arizona	2 large	24	14
52	granulosus	♂	Tucson, Arizona	2 large	24	14
53	granulosus	♂	Tucson, Arizona	2 large	(24)	14
54	granulosus	♂	Tucson, Arizona	3-4 large	25-26	15-16
55	granulosus	♂	Tucson, Arizona	4 large	26	16
56	granulosus	♂	Tucson, Arizona	4 large	26	16
57	granulosus	♂	Tucson, Arizona	4 large, 1 small	(27)	17
58	granulosus	♀	Tucson, Arizona	3 large	25	
59	granulosus	♂	Grand Canyon, Arizona	4 large	26	16
60	granulosus	♂	Grand Canyon, Arizona	4 large	(26)	16
61	granulosus	♀	Grand Canyon, Arizona	4 large	26	
62	granulosus	♀	Grand Canyon, Arizona	± 4 large	± 26	

EXPLANATION OF PLATE I.

The figures are reproduced directly from the original photographs, without retouching, at an enlargement of 1500 diameters. It should be borne in mind that in the photographs considerable apparent size-variations are produced by differences of focus, and that unless the chromosomes lie exactly in one plane the photograph often gives a less accurate impression than a drawing. Drawings of most of these photographs with designations, will be found among the text figures, as indicated.

1 *M. terminalis* (No. 3, Montgomery's material), 21-chromosome form, first spermatocyte-division polar view; unpaired idiochromosome (odd or accessory) outside the ring, to the right (Fig. 3, b).

2 *M. terminalis* (No. 19), 22-chromosome form, first division, polar view; the two separate idiochromosomes at the right. (The small idiochromosome, being slightly out of focus, appears too small. Its size is correctly shown in the drawing, Fig. 4, b).

3 *M. terminalis* (No. 12), 22-chromosome form similar view; idiochromosomes in contact (Fig. 4, f).

4 *M. terminalis* (No. 20), 23-chromosome form, one large supernumerary, view similar to the preceding; idiochromosomes and supernumerary to the right (Fig. 1, g).

5 *M. granulosis* (No. 49), 23-chromosome form, one large supernumerary, which lies inside the ring with the small idiochromosome and *m*-chromosome (Fig. 7, g).

6 *M. terminalis* (No. 1), 23-chromosome form, one small supernumerary lying inside the ring with the *m*-chromosome and one of the large bivalents (Fig. 7, i).

7 *M. granulosis* (No. 52), 24-chromosome form, two large supernumeraries (Fig. 11, g).

8 *M. femoratus* (No. 42), 26-chromosome form, four large supernumeraries (Fig. 2, g).

9 *M. terminalis* (No. 36), 26-chromosome form, similar to preceding (Fig. 9, e).

10 *M. femoratus* (No. 57), 27-chromosome form, four large supernumeraries and one small (Fig. 13, h).

11 *M. femoratus* (No. 46), 22-chromosome form, first division in side view, both idiochromosomes dividing (Fig. 4, i).

12 *M. granulosis* (No. 47) 22-chromosome form, second division, polar view (Fig. 5, e).

13 *M. femoratus* (No. 42), 26-chromosome form; second division, polar view, showing hexad element near center (Fig. 10, a).

14 *M. terminalis* (No. 3, Montgomery's material) 21-chromosome form, second division side view, showing lagging idiochromosome ("accessory chromosome") (Fig. 3, f).

15 From the same cyst as the last, later stage of second division; idiochromosome entering one pole (Fig. 3, g).

16 *M. femoratus* (No. 29), 22-chromosome form, second division metaphase in side view, showing idiochromosome bivalent (like Fig. 5, d).

17 *M. granulosis* (No. 47), 22-chromosome form, late anaphase of second division, one idiochromosome entering each pole (Fig. 5, l).

18 *M. femoratus* (No. 46), abnormal late anaphase of second division, showing both idiochromosomes passing to the same pole (Fig. 5, o).

19 *M. femoratus* (No. 29), 22-chromosome form, second division showing initial separation of the idiochromosomes (like Fig. 5, f).

20 *M. granulosis* (No. 49), 23-chromosome form, one large supernumerary, second division metaphase, showing triad element formed by the union of the supernumerary with the idiochromosome-bivalent (like Fig. 8, i).

21 *M. granulosis* (No. 52), 24-chromosome form, two large supernumeraries, second division, showing tetrad element consisting of the idiochromosomes and supernumeraries united in a linear series (Fig. 11, u).

- 22 *M. femoratus* (No. 42), 26-chromosome form, four large supernumeraries; second division showing hexad element formed by the idiochromosomes and supernumeraries (Fig. 10, *h*).
- 23 From the same cyst, similar view (Fig. 10, *k*).
- 24 *M. terminalis* (No. 3, Montgomery's material), 21-chromosome form, nucleus from the growth-period, showing single spheroidal chromosome nucleolus (like Fig. 3, *l*).
- 25 *M. femoratus* (No. 29), 22-chromosome form, growth-period, showing double chromosome-nucleolus (idiochromosome-bivalent) and plasmosome (Fig. 6, *b*).
- 26 From the same slide, showing different ordinary chromosomes, separate chromosome-nucleoli and plasmosome (Fig. 6, *c*).
- 27 *M. terminalis* (No. 20), 23-chromosome form, growth-period, showing tripartite chromosome-nucleolus formed by the idiochromosomes and supernumerary (like Fig. 1, *i*).
- 28 *M. granulosis* (No. 60), 26-chromosome form, growth-period, showing hexad chromosome-nucleoli from three different cells (like Fig. 10, *s-u*).
- 29 *M. terminalis* (No. 2), 23-chromosome form, one small supernumerary; spermatogonial group, showing three small chromosomes (the supernumerary and two *m*-chromosomes); the small idiochromosome distinguishable above towards the left (Fig. 7, *y*).
- 30 *M. terminalis* (No. 22), 24-chromosome form, one small supernumerary and one large (Fig. 11, *p*)



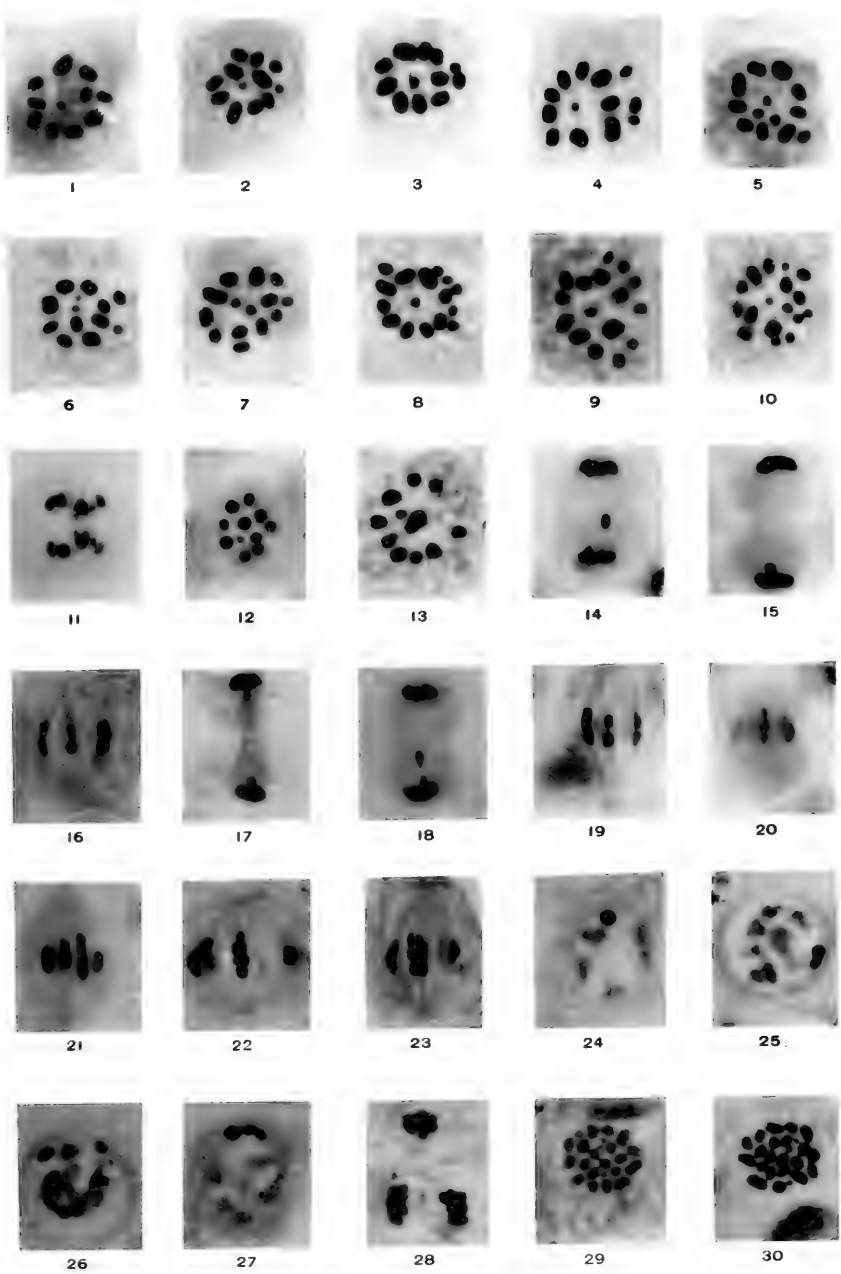

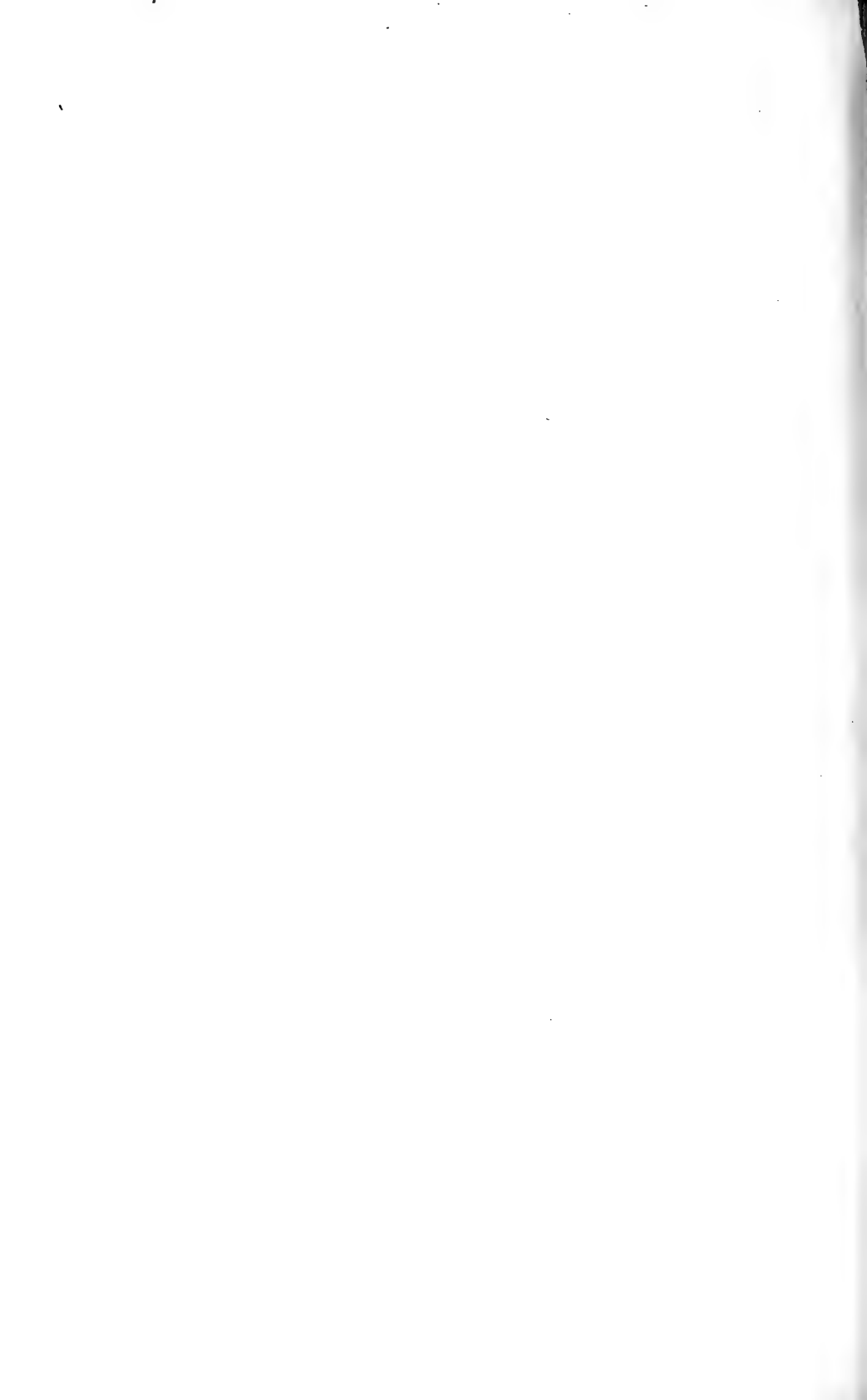

THE EFFECTS OF DESICCATION ON THE ROTIFER PHILODINA ROSEOLA

BY

MERKEL HENRY JACOBS

WITH ONE FIGURE

I	Introduction.....	207
II	Historical.....	210
III	Structure and natural history of <i>Philodina</i>	217
IV	Behavior of <i>Philodina</i>	220
	1 Behavior under normal conditions.....	220
	2 Behavior at the onset of desiccation.....	222
V	Visible changes attending a process of desiccation.....	223
VI	Degree of desiccation attained by <i>Philodina</i>	227
	1 The views of Davis and others.....	228
	2 Evidence for the view that a true desiccation occurs.....	231
VII	Effect of desiccation on the life processes of <i>Philodina</i>	236
	1• Injurious effects of desiccation.....	236
	2 Influence of the previous condition of the animal.....	237
	3 Influence of the conditions attending the desiccation.....	238
	<i>a</i> Effect of rapidity of drying.....	238
	<i>b</i> Effect of temperature at which drying occurs.....	242
	<i>c</i> Effect of duration of desiccation.....	244
	<i>d</i> Effect of alternations of moisture and dryness.....	244
	<i>e</i> Effect of intensity of desiccation.....	246
	<i>f</i> Effect of temperature on mortality.....	248
	4 Conditions of the life processes in a dried animal.....	249
	5 Effect of desiccation on egg production.....	252
VIII	Summary.....	260
IX	Bibliography.....	262

I INTRODUCTION

It has long been known that various animals, among them certain of the rotifers, tardigrades, and the smaller nematode worms, can survive conditions fatal to most other organisms. Although normally living in water, or at least under conditions of moisture, these animals may be dried for long periods of time without serious injury. They are found in countless numbers in

the dust from the gutters of roofs and other places where water is accustomed to stand at intervals, and even after prolonged drying the addition of a little water is all that is necessary to start them into activity. While in the dried condition they show no visible signs of life. All movements cease and the body frequently shrinks to a shapeless mass so that it is difficult to distinguish them from the particles of sand among which they are found. When water is again applied the body gradually regains its original form, movements appear, and after a longer or shorter time, depending on the conditions of the desiccation, the animals resume their normal activities apparently none the worse for the experience. Not only may they be dried naturally in the air but they may be subjected artificially to even more extreme conditions. Various observers have kept them in desiccators and vacua for long periods of time and have subjected them to temperatures at which life ordinarily is impossible, without destroying their power of again resuming their normal activities upon the application of water.

The length of time the animals may remain in this state of suspended animation is often considerable; there are well authenticated cases of rotifers, whose usual period of life is probably not more than a few weeks or months at most, which have been revived after a period of desiccation extending over three or four years; one observer even claims to have revived them after fifteen years' desiccation. In the case of the *Anguillulidæ* even longer periods have been recorded; Baker in 1771 succeeded in reviving individuals of *Tylenchus scandens* which had remained in a dried condition in grains of wheat for 27 years.

As to the principal facts just given there seems to be little doubt. They have been confirmed by numerous observers and anyone may repeat for himself with little trouble the experiments on which they are based. In the interpretation of these facts, however, there has been, and still is, much diversity of opinion. What is the actual effect of drying on the rotifer or tardigrade? Is the water contained in its tissues really removed or does the animal have some means of protecting itself against the loss of water, the desiccation being only apparent? If the former be the case, what

is the condition of the dried animal? Are its life processes merely retarded or have they come to a complete standstill? In the revival of a dried animal by the application of water, are we dealing, as many have supposed, with a case of passage from death to life or merely with an acceleration of vital processes which have been continuing all the while but in a greatly reduced state?

These and similar questions have been under discussion for many years and as yet no unanimity of opinion has been reached by zoölogists in regard to them. Every point has been affirmed and denied many times by equally capable men. Much of the discussion on the subject has been pure speculation based on neither observation nor experiment and hence is of little value; however, even the most careful observers have differed radically with each other on many points of importance, the observations of one worker being contradicted by the apparently equally accurate observations of another worker. The result is that the question even at the present day is in a state of the greatest confusion and uncertainty and is still far from being finally settled.

It was with the intention of clearing up some of these points of dispute that the present piece of research was undertaken in the fall of 1906 at the suggestion of Prof. E. G. Conklin. It gives me great pleasure to express at this point my sense of deep indebtedness to him not only for suggesting the subject but for the interest he has taken in the work and for the many helpful suggestions and criticisms he has offered. The experiments were performed in the Zoölogical Laboratory of the University of Pennsylvania during the years 1906-1907 and 1907-1908. During the course of the work a number of points of interest somewhat off of the main line of the investigation came up; some of these points are touched upon in the present paper, others are still under investigation and are reserved for subsequent publication.

The animal worked upon was *Philodina roseola*, one of the Bdelloid rotifers, and in all cases except where otherwise expressly stated it will be understood that the observations apply to this form. *Philodina* was chosen partly on account of the ease with which it could be obtained, making experiments on large numbers of individuals possible, and partly because it shows the phenom-

enon of revival after desiccation in a particularly favorable way. A limited number of observations were made on *Adineta* (*Callidina*) *vaga*, a nearly related form, but these show practically no points of difference from those made on *Philodina*.

II HISTORICAL

In the year 1701, Anton von Leeuwenhoek in searching for new objects to examine under his microscope chanced to take some of the dry dust from the gutter of a roof and on moistening it was greatly astonished to see after a time living animals swimming about actively in the water. Struck with the observation he again allowed the animals to dry and on moistening them the next day with water previously boiled by way of precaution against introducing any life from outside sources, he obtained the same result. Further experiments convinced him that these animals, which were rotifers, probably belonging to the species *Rotifer vulgaris*, might be deprived of water for at least several months without losing the power of recovering their normal activities when water was again supplied. This was the first observation to be made on the phenomenon of desiccation with subsequent revival in animals; strangely enough it attracted little attention at the time. Leeuwenhoek believed that the animals themselves were not truly dried but that they were protected by an impenetrable cuticle from loss of water * * * "*cuticulas ex tam solida conflatas esse materia ut ne minimam quidem permittant exhalationem. Quod si sese aliter haberet, asserere non vereor haec animalcula * * * onni aqua destituta necessario omnia esse emoritura.*"

The next mention of the subject was made in 1743 by an Englishman, Turbervill Needham, who observed minute worms to issue from grains of wheat when water was applied to them. To use his expression they "took life" on the application of moisture. In the same year another Englishman, Henry Baker, again called the attention of naturalists to the rotifers discovered by Leeuwenhoek, but he contented himself with merely repeating that writer's description of them and it was not until ten years later

that he discussed the subject on his own account. Needham's discovery excited considerable attention but was for the most part received with incredulity. That living organisms could be dried and after remaining apparently lifeless for a time be caused to "take life" by the application of water seemed so incredible to the scientists of the day that they preferred either to deny the animal nature of the worms altogether, calling them "filaments animés," "fibres mouvantes" or "etuis pleins de globules mobiles" which were started into movement by the imbibition of water or to assert that they arose by spontaneous generation. It was not until the time of Fontana (1771) and Roffredi (1775) that the animal nature of these anguillulids was established beyond all doubt.

In the meantime other men were making similar observations. Among the earliest of these may be mentioned Trembley (1747), Baker (1753), Schaeffer (1755), Ginnani (1759), Ledermüller (1759), Fontana (1768), Göze (1772), Corti (1774), Müller (1775) and Roffredi (1775). The list of the animals capable of enduring desiccation was also increased during this period. Ledermüller in 1759 had observed the revival of "paste eels," Fontana in 1768 of Gordius, and Spallanzani in 1776 of tardigrades and the anguillulids found in the dust of roofs. Later observers added several new forms and increased the list of rotifers and tardigrades which show this peculiarity.

The history of our exact knowledge of the phenomenon of suspended animation dates from the publication in 1776 of Spallanzani's "Opuscoli di Fisica Animale e Vegetabile." The section of this work relating to the desiccation of animals is a model of scientific research. Spallanzani, unlike most of his contemporaries, tested his theories by actual experiments and these experiments were often carried out with great care and considerable ingenuity. If other workers had used the same amount of care the subject would be in a far less confused state than it is at the present day. Spallanzani first repeated the experiments of Leeuwenhoek and made the observation, which has been confirmed by a number of subsequent workers on the subject, that rotifers can recover their activity after a period of drying only when a certain amount of sand or moss is present; when dried on a clean glass slide they are

invariably killed. He considered this result to be due to the injurious effect of the air on the dried animals, the sand protecting them from its action. He made many other interesting observations, for example, on the effect of high temperatures on animals in different degrees of desiccation, on the number of times they may be dried without being killed and the effect on them of various chemical substances. Unlike Leeuwenhoek he believed that the rotifers could endure the withdrawal of the last traces of water from their bodies. He was able to revive them after subjecting them while in the dried state to the desiccating action of high temperatures and the vacuum. There was no doubt in his mind that the process of desiccation caused an actual stoppage of the life processes and that the animals in the dried condition were to be considered as dead. He entitled his paper, "Observations and experiments on certain marvelous animals which the observer can at his will make pass from death to life."

Spallanzani's work naturally excited great interest and gave rise to much discussion. The statement that animals could be brought back to life after being dead for a time could not be allowed to pass unchallenged by the physiologists of the day and many heated controversies arose between those who supported Spallanzani and those who opposed him. Among those who engaged in the discussion may be mentioned such distinguished naturalists as Haller, Cuvier, Oken, Humboldt, Lamarck, Treviranus, and Johannes Müller. The controversies for the most part, however, were carried on on purely theoretical grounds and had little experimental evidence to back them. From the time of Spallanzani to the time of Doyère, a period of sixty years, although the question continued to be one of the most discussed in the whole realm of physiology, practically no new facts were added to our knowledge of the subject.

On the whole, the opponents of Spallanzani seemed to gain the upper hand. This was largely due to the apparently convincing arguments advanced by two men, Ehrenberg in Germany and Bory St. Vincent in France. Both of these workers not only denied that dead rotifers could be brought back to life but asserted that recovery after true desiccation was impossible. The unde-

niable fact that rotifers, tardigrades, and anguillulids may be obtained from apparently dry sand they explained in different ways. Ehrenberg, on the one hand, contended that actual drying does not occur, the sand protecting them from loss of water "as a woolen mantle protects the Arab from the intense heat of the desert." He believed that in this state of apparent desiccation all of the vital processes continued, even reproduction. Bory St. Vincent, on the other hand, believed that the animals in question could not survive a period of drying even when sand was present and that their apparent revival was due to the hatching of eggs concealed in the sand. "Nous avons quelquefois * * * retrouvé des Rotifères * * * mais ils n'y ressuscitaient pas; ils s'y développaient comme les Daphnies et autres petits entomostracés, dont les ovules sont demurés dans le sol."

The next worker to take up the subject in a scientific manner was the French naturalist Doyère. So great was the authority of Ehrenberg and Bory St. Vincent and so plausible their reasoning that he had been led to doubt the accuracy of Spallanzani's observations or at least to regard the matter as worthy of further investigation. He accordingly undertook a series of experiments, published in 1842, with the result that Spallanzani's conclusions were in the main confirmed. He found, however, that the animals are not always killed in the absence of sand, a certain proportion of those dried on a clean slide recovering, although requiring a much longer time. Furthermore, he showed that it is not the exposure to the air that injures the rotifers and tardigrades in this case as Spallanzani had supposed, since animals dried in the air and then placed in a vacuum showed a lower mortality than those dried directly in the vacuum. He concluded that the rapidity of drying is an important factor in the effect of the desiccation. He furthermore showed that rotifers may be revived after an apparently almost perfect desiccation. He found that they could endure a sojourn of 17 days in a desiccator followed by 28 days in an air pump with a pressure of 5-6 centimeters of mercury and that after thorough drying in the sunlight a temperature of 140° C. or more could be resisted for a brief period. He concluded, therefore, that the last traces of water might be extracted without destroying the power

of revival, and that, since life processes are impossible in the absence of water, in the dried animal we are dealing with a case of life *in potentia* as opposed to life *in actu*. These contentions were supported by observations made several years later by the physicist Gavarret, who subjected rotifers to the action of a vacuum of only 4 mm. pressure for 51 days, sulphuric acid being present to absorb all traces of free moisture, and yet was able to revive them by the application of water.

About the same time Pouchet, followed by Pennetier and Tinel, obtained results which were diametrically opposed to those of Doyère. Numerous carefully conducted experiments led these naturalists to believe that a true desiccation is invariably fatal in the case of rotifers, tardigrades, and anguillulids just as in other animals. They found in all of their experiments that these animals when dried on a glass slide either with or without a small quantity of sand are killed in the course of a few days even at ordinary temperatures and that individuals dried under more natural conditions cannot resist an hour's exposure to a temperature of 100° C. Pouchet even found that rotifers and tardigrades obtained in a dried condition from natural sources were all killed in three months when exposed to the air in a sunny place. All of these results were presumably due to the loss of water by the animals when exposed to unfavorable conditions.

Since the views of Pouchet, Pennetier, and Tinel on the one hand and Doyère and Gavarret on the other, differed so widely and since both seemed to be based on equally careful experiments, it was decided, instead of wasting time in fruitless discussion, to submit the matter to arbitration. Accordingly a commission was appointed in 1859 by the Société de Biologie consisting of MM. Balbiani, Berthelot, Brown-Séguard, Dareste, Guillemin, Ch. Robin, and Broca, chairman, to hear the evidence presented by both sides, to perform any experiments of their own they might consider necessary, and to present the result of their deliberations in the form of a report to the society. This commission discharged its duty with the greatest thoroughness. It held forty-two regular sessions without counting the times when a few of its members met for discussion. The examination of the evidence

presented by both sides in the form of experiments occupied several months and the final report of the commission presented in March, 1860, covers a hundred and forty printed pages. This report on the whole sustains the contentions of Doyère, not because of any inaccuracies in Pouchet's results, but because they are largely negative in nature while Doyère's are positive. It concludes with the words, "des animaux * * * aménés au degré de dessiccation le plus complet qu'on puisse réaliser dans l'état actuel de la science, peuvent conserver encore la propriété de se ranimer au contact de l'eau." Although the language employed in the report is rather guarded, it evidently was the opinion of the commission that life under these conditions could exist only *in potentia*.

The results obtained by this commission as well as those of Doyère and Spallanzani are contradicted by the observations of some of the more recent workers on the subject. In 1873 H. Davis, a member of the Royal Microscopical Society and a student of rotifers published a paper which has since been largely quoted and in which he stated his conclusions that in *Philodina*, at least, the desiccation when followed by revival is only an apparent one, the animal being able to protect itself by means of a gelatinous secretion against the loss of its body fluids. He demonstrated how such a secretion could be effective by showing that grapes covered with a thin coating of gelatine remained in a juicy condition for a long time even in the vacuum of an air pump while grapes not thus treated soon lost their water and assumed a shriveled appearance. The fact that rotifers dried with a small quantity of sand are capable of recovery even after a prolonged exposure to extreme conditions while those dried on a clean slide for a much shorter time are not, had always been more or less puzzling to naturalists since it was first observed by Spallanzani. It received a ready explanation on Davis' theory, it being assumed that in the former case where drying was slow the animal had time to protect itself by pouring out a secretion, while in the latter case drying was so rapid that the animal, not being able to form its usual protection, was killed. This explanation was so simple and so in accord with the facts known for other animals that it was immediately accepted by many and at the present day is still frequently quoted.

Certain of the most recent investigators have gone even farther than Davis. O. Zacharias ('86), for example, on the basis of several observations made on a species of *Philodina* has tried to discredit the whole subject of the revivification of desiccated animals. According to him, rotifers can resist drying no better than other aquatic animals; when withdrawn from water they are invariably killed. Like Bory St. Vincent he considers the many cases of supposed revival to be due to the hatching of eggs which by virtue of their thick shells are able to resist drying the same as the eggs of insects or other animals. The fact that revival is commonly supposed to occur in the presence of sand he regards as strong confirmatory evidence since it is to be supposed that concealed in the sand there might easily be many eggs which would escape the notice of the observer. He concludes his paper with the words * * * "es einzig und allein die *Eier* sind durch welche die continuierliche Generation ensfolge aufrecht erhalten wird."

F. Faggioli ('91) as the result of a number of observations and experiments on several species of rotifers comes to the same conclusion. Like Zacharias he regards the stories of the revival of animals submitted to conditions of desiccation as myths based on imperfect observations. Perhaps his position may best be summed up in the following quotation from Fredericq ('89) which he cites in his paper. "Les Rotifères et les Tardigrades adults meurent sans retour quand on les desseche. Mais les oeufs qu'ils ont generalement dans le corps ne sont pas dans le même cas. Ces oeufs conservent leur vitalité malgré l'absence d'eau. Places ensuite dans un milieu convenable et humide ils se développent avec rapidité et donnent naissance à une nouvelle génération de jeunes animaux que l'on avait à tort considérés comme résultant de la réviviscence du corps de leurs parents."

It is seen from this short historical review that the entire subject is in a very unsatisfactory state. On scarcely any point is there any general agreement. All observers, perhaps, will admit that it is possible to obtain living animals from sand that is apparently dry but further than this there is no consensus of opinion. One body of observers represented by Bory St. Vincent, Zacharias and

Faggioli claim that the animals come from eggs concealed in the sand in the dead bodies of the parents, the latter having of necessity been killed by the exposure to the conditions of dryness. Another body, represented by Leeuwenhoek, Ehrenberg, Pouchet, Davis, and Hudson, although admitting that adult rotifers may survive even prolonged conditions of desiccation, consider that they are able to do so only in virtue of some effective means of preventing the escape of water from their tissues, the condition of the animal in the dried state therefore not differing in any essential respect from its normal state. Still others, among them Spallanzani, Schultze, Doyère, Gavarret and Preyer consider that the desiccation is a true one and may continue theoretically up to a point of absolute dryness without injury to the animal. They either state specifically that the animal in this condition is lifeless or tacitly assume such to be the case. Other observers, while admitting that desiccation may proceed very far, consider that the life processes never come to a complete standstill although they may be very greatly retarded.

It is the purpose of the present paper to consider the evidence for these various views and to attempt to reduce the subject to a state of greater certainty than that in which it now rests. The two points which will chiefly be considered are first, whether or not the animal suffers a true desiccation and, second, what is the state of the vital processes of the animal in the absence of water. Before proceeding to the observations and experiments on which the conclusions of the paper are based, a brief account will be given of the structure, natural history, and behavior of *Philodina* to render more intelligible that which is to follow.

III STRUCTURE AND NATURAL HISTORY OF PHILODINA

Philodina roseola is one of the commonest of the rotifers, belonging to the order Bdelloida of which the common rotifer, *Rotifer vulgaris*, is also a member. It is widely distributed throughout the world, being frequently found in small basins in the rocks in which water periodically collects; a favorite habitat is in the stone urns in cemeteries. It is usually associated with the uni-

cellular alga, *Spæhrella lacustris* (*Hæmatococcus pluvialis*), on which it feeds and from which it appears to derive the red color which gives it its specific name. In size, it is microscopic, being barely visible as a minute speck to the naked eye. Adult individuals when fully extended measure from 0.35 to 0.5 mm. in length and when contracted from 0.1 to 0.15 mm. The newly hatched young are about five-eighths as long as the adults which they resemble closely except in being colorless and in having a more transparent alimentary tract.

The members of the group *Bdelloida* are peculiar among the rotifers in their method of locomotion. In addition to their swimming movements which resemble those of other rotifers, they are able to creep over the surface of solid objects like a leech, hence the name applied to them. These creeping movements are rendered possible by the telescopic structure of the body, which may readily be extended or contracted, and by the presence at its anterior end of a so-called proboscis by means of which adhesion to solid objects is possible. The proboscis of *Philodina* is fairly stout and when the trochal disc has been withdrawn within the body, as it always is when the animal is creeping, it appears to form the anterior end of the body. When the trochal disc, which consists of two ciliated lobes which the earlier observers mistook for wheels, is extended, the proboscis is drawn back so as to lie behind and dorsal to it. In creeping, the animal first fastens its foot by means of a sticky substance secreted by the cement glands contained in it; the proboscis is then attached and the foot drawn forward, the body shortening and arching itself, like that of a leech or a "measuring worm." The foot is then again attached and the body extended. These movements may occur with considerable rapidity although the progress of the animal is not so fast as when swimming. As a rule a high temperature and fresh water favor swimming movements and low temperatures and foul water creeping movements.

Externally *Philodina* is covered with a fairly thick cuticle which in the regions of the head and foot is divided into a number of segments by alternate stiff and flexible portions. By an inrolling of the flexible regions the stiffer parts are allowed to fit within one

another and a sort of telescoping of the body is thus permitted. When fully contracted the head and tail are drawn entirely within the large segment which covers the middle of the body and both ends of the latter are puckered together as if drawn in with a string. The animal in this condition is shaped like a lemon and is well fitted to resist the injurious effects of desiccation. The part of the cuticle that is outermost, that is, that which surrounds the middle of the body, is thicker than the parts that cover the head and tail. It is also somewhat different in chemical nature as is shown by the fact that when living animals are placed in a weak solution of methylene blue it is only part of the body that takes the stain. This is true either of contracted animals or those that are creeping or swimming. In the latter case a blue band appears about the middle of the body, the head and foot remaining colorless. The fact that that part of the cuticle which alone is exposed at the time of drying should be of a different nature from the remainder is probably significant. Perhaps it may be more impermeable to water and thus check the rapidity of evaporation. Whether or not it is a complete protection will be considered in another place. Within the cuticle and the hypodermis which secretes it are found the muscles; these are especially well developed in *Philodina* on account of its habit of contracting and extending the body. They are both longitudinal and circular, the former serving to draw the head and foot together at the time of contraction and the latter by exerting a pressure on the fluids of the body to cause their extension. In a rotifer dried slowly enough to retain its natural form, the position of these muscles may be observed in the form of slight thickenings beneath the cuticle.

The various internal organs are much the same as those of other rotifers. The mastax is well developed and the walls of the stomach are thick and glandular. They usually appear more or less yellowish, greenish, or sometimes a deep brick red, depending on the amount of pigment present in the cells of *Sphærella* on which the animals are feeding. The nephridia are fairly conspicuous and under the higher powers of the microscope it is easy to observe the peculiar flickering movement of the flame cells. A contractile vesicle is present into which the nephridia discharge their products.

The method of reproduction of *Philodina* is of interest. There are two ovaries, one on each side of the alimentary canal, and each is combined with a large vitellarium. The eggs undergo a partial development within the body of the mother and at the time of laying are relatively large and are protected by fairly thick shells. The point of special interest in connection with the reproduction of *Philodina* is that there are no male individuals; this is also true of the other members of the group *Bdelloida*. Although these animals are among the commonest of our rotifers and have been under observation for over two hundred years, males have never been observed, and it seems reasonably certain that they do not exist. Parthenogenesis appears to be the only method of reproduction.

The eggs hatch two or three days after being laid and the young from the first behave exactly like the adults which they closely resemble in most respects. They seem to be somewhat less resistant to desiccation, but there is much individual variation and the difference is not very great in any event. They feed freely and grow rapidly; egg laying may begin seven or eight days after hatching at which time they have not yet reached their full size.

As to the length of life of *Philodina* under favorable conditions, unfortunately nothing definite can be said except that it is considerably longer than has been supposed in the case of other rotifers. *Hydatina* is said to live about two weeks; in the course of these experiments rotifers isolated at the time of hatching have been kept alive for more than six weeks, and under more favorable conditions they would probably have lived still longer.

IV THE BEHAVIOR OF PHILODINA

I Behavior under Ordinary Conditions

The behavior of *Philodina* is more complicated than that of most rotifers owing to the two different modes of locomotion. Ordinarily the animals are found in one of the following four states, (1) swimming, (2) creeping, (3) attached by the foot and feeding or (4) contracted. The causes which determine the succession

of these states in a given individual have not yet been worked out in detail although the problem presents a number of points of interest. A swimming individual behaves in much the same manner as the forms described by Jennings ('04); orientation in response to any stimulus takes place by random movements resembling those of an infusorian. In a creeping individual, on the other hand, orientation is much more direct; the process resembling that which occurs in a planarian. Any strong stimulus causes the animal to stop and make a few testing movements with its proboscis; orientation either towards or away from the stimulus then occurs directly without the intervention of random movements. If the stimulus be very strong, the animal contracts at once, this reaction being caused by a variety of stimuli such as heat, injurious chemicals, hypertonic solutions, mechanical shocks and the onset of desiccation. It is interesting to note that in this one animal we have at one time the method of reaction of an infusorian and at another that of a typical metazoan. As has already been mentioned, the temperature and the purity of the water seem to be two of the factors which determine whether creeping or swimming shall prevail, although probably they are not the only ones concerned. Feeding movements may occur under almost any conditions; they are especially marked after a period of desiccation.

The reaction of *Philodina* to light is of some interest. Normally it is almost indifferent. When a number of individuals are present in a dish they tend to become scattered to all parts of it regardless of the direction of the source of light. If now they be disturbed, either by jarring the dish, drawing the water through a pipette a few times, or adding a few drops of fresh water, they immediately move towards the side of the dish away from the light, either creeping or swimming according to circumstances. This reaction is very striking and never fails to occur. In the course of these experiments it was put to a practical use whenever it was desired to obtain rotifers free from sand. A small amount of the sand from the large culture was placed in a small dish and the water agitated with a pipette, being given a spiral motion so as to carry the sand to the center of the dish. In a few moments most of the rotifers had invariably collected in the clean water on the

side of the dish away from the light where they could be removed by means of a fine pointed pipette. If left undisturbed for thirty or forty minutes they again spread out into all parts of the dish.

2 *Behavior at the Onset of Desiccation*

At the onset of desiccation, no matter under what circumstances it occurs, the animals all show a general restlessness. If they have been quietly feeding, for example, they withdraw the corona and begin to make active creeping movements. These movements are more or less at random and thus differ from the responses made when creeping, to more definitely localized stimuli. The negative phototaxis, which is shown so markedly under certain conditions, is always abandoned when the water begins to disappear. A group of rotifers which has collected on the side of the dish away from the light is quickly broken up, each individual starting to creep in the direction in which it happens to be turned at the time and continuing in this direction until it comes either to the edge of the drop or to a place where the surface film lies so close to the slide that it cannot creep under it. It then stops, contracts, makes one or two testing movements with the proboscis, and starts off again in a new direction until brought to a stop in a similar way. Contact with solid objects such as grains of sand does not cause the creeping movements to cease as Davis and others have assumed. So far as can be observed the behavior of rotifers dried on a clean slide and those dried with a quantity of sand is essentially the same. In both cases they continue to creep as long as it is possible to do so and when such movements become impossible they contract into a more or less spherical mass and dry wherever they happen to be. As has been mentioned the movements are purely at random. Frequently a number of rotifers may be seen in the field of the microscope at once, all creeping in different directions. When two rotifers meet they pay no attention to each other but continue on their way just as before. There is no instinct that leads them to gather together in groups for mutual protection as Hudson and others have asserted. Where such groups are found the cause is merely that they have all re-

mained in the evaporating drop as long as possible thus being brought together as the latter decreased in size. When drying occurs under a cover glass or with sand, the contracting surface film of the drop may frequently be seen to sweep a number of rotifers together and by further contraction press them into a compact mass; the part the rotifers themselves play in the process, however, is purely a passive one.

On the whole, the method of response to the first stages of desiccation shown by *Philodina* is an advantageous one. It is true that the random movements sometimes lead single individuals into places where they are caught by sudden evaporation of the water and dried without any protection at all. On the other hand, the majority of the rotifers, by continuing to move as long as possible, tend to find their way to the places where the water lingers longest and where drying, when it does occur, is most gradual. If they stopped at the first grain of sand they encountered they would frequently be dried under far less advantageous circumstances.

V VISIBLE CHANGES ATTENDING THE PROCESS OF DESICCATION

When the water has so far evaporated that creeping is no longer possible, the rotifer contracts in the manner already described, drawing in both the head and the foot and then puckering the two ends of the body as though they were drawn together by a purse string. This part of the contraction is accomplished by muscular action and occurs before the water surrounding the animal has evaporated. Before the final contraction occurs the head may be rapidly extended two or three times as if to test the external conditions. When the process of drying is very slow contraction may continue still further, the animal becoming noticeably smaller even before all of the water has disappeared. Under these conditions irregular wrinkles do not appear although the puckering at the two ends is discernible. When dried more rapidly, even when in contact with a large quantity of sand the animal assumes a more or less irregular form, both longitudinal and transverse wrinkles appearing in the cuticle and the internal organs shrinking away

from the latter. Although the animal is not necessarily injured by this irregular shrinking it is more likely to be than in the case where it contracts regularly.

Loss of water from the body is very rapid after the last trace of the surrounding film has disappeared. Wrinkles appear almost immediately in the case of individuals dried on a clean slide. In one minute the body may have become fairly irregular in outline and in two minutes assumed the characteristic appearance of desiccation. Although further loss of water and shrinkage occur the change in size and appearance after two or three minutes is not very noticeable since the cuticle has assumed its final wrinkled form and further contraction is confined to the internal organs. In rotifers dried more slowly the contraction is more evident since the cuticle and hypodermis are pressed together against the internal organs and follow them in their shrinkage. That muscular action is responsible for at least a part of the contraction is shown by the fact that dead rotifers when allowed to dry assume very irregular forms, the closing of the ends of the body above described not occurring.

The amount of shrinkage that occurs under favorable conditions is very considerable. It may easily be followed by keeping single individuals under the microscope during the drying process and making camera drawings of them from time to time. In those that are dried slowly and thus contract regularly it is easy to compare approximately the volumes at the different times. Such an examination shows that in the case of slow desiccation with sand, which is one of the most favorable methods, the animal may shrink to one-third or one-fourth of its original volume.

When water is added to rotifers that have been dried for a time a very rapid swelling occurs. In one minute the animal has doubled in volume and in five or often less has reached its normal size. From this time until movements appear the visible changes are slight and consist in changes of form apparently due to the slow relaxation of the muscles that have drawn in the ends of the body. When those at the anterior end relax the animal becomes pear shaped; the foot may be extended either before or after this occurs. In rotifers which have been dried rapidly and which are therefore

much wrinkled, the first change that occurs is a filling out of the wrinkles, the amount of swelling apparently being slight since the greater part of the shrinkage has occurred in the internal organs, the cuticle having stuck fast to the slide or to a grain of sand. That a considerable swelling occurs, however, is easily observed when a group of rotifers has dried together, the individuals being pushed apart as the water is absorbed. The usual time required for all of the wrinkles to disappear is about five minutes, although it may frequently be considerably less.

The point at which the water enters may be determined by staining rotifers *intra vitam* with neutral red before drying them and then adding water which has been made weakly alkaline by the addition of a small amount of sodium bicarbonate. As the latter touches the organs which have been stained red it changes them to a bright yellow color and thus furnishes a very exact means of observing the method of penetration. Such an experiment shows that the water enters largely at the two ends of the animal and to a much less extent through the cuticle surrounding the body. Its entrance is practically instantaneous.

The time required for movements to appear varies greatly with the circumstances attending the process of desiccation. The times required under a number of different conditions are given in another section of this paper. Under the most favorable conditions they may appear in five minutes, as was the case with a number of individuals which had been dried slowly on filter paper; usually seven to ten minutes are required and sometimes an hour or more. The first movements to appear are muscular contractions within the body, although sometimes the flame cells of the nephridia begin to beat before muscular movements can be observed. In any case the beginning of the activity of the nephridia is one of the first signs of the return of the normal life processes. Care must be taken not to confuse with true muscular movements the jerky movements exhibited immediately after water has been applied which are due only to changes in tension set up by the imbibition of the water and are not indicative of life. In all cases where the time required for movements to appear is mentioned it is understood that it is the distinctively vital movements that are meant. Soon after the first movements have appeared the foot

is extended, often with great suddenness. This is apparently accomplished by the contraction of the circular muscles of the body which thus set up a pressure which causes it to be protruded. Even in individuals which have been killed by drying the foot becomes more or less extended but this is probably due to the absorption of water by osmosis.

After the first extension of the foot, movements separated by periods of rest may recur at intervals for some time before the animal fully recovers and creeps away. Complete recovery sometimes occurs in as short a time as ten minutes, but under certain conditions it may require several hours or even a day. Most workers have introduced a source of error into their observations by failing to keep their rotifers for a long enough time. In the present series of experiments, the animals were always kept at least twenty-four hours before being pronounced dead.

After the rotifers have recovered they may show the effects of the desiccation in various ways. Sometimes the body is more or less crooked and distorted, at other times the cilia appear injured and do not beat normally. In other cases the animals remain contracted and make no movements although they are not dead as is shown by the fact that they undergo no disintegration. That some of the life processes such as oxidations still continue may be shown by placing upon them a drop of a solution of neutral red which has been rendered weakly alkaline by a very small quantity of sodium bicarbonate. Living rotifers which are excreting carbon dioxide change the color of the solution and are rapidly stained pink or red; dead ones do not show this reaction. A complete transition is therefore shown from individuals which are killed through those in which movements never appear but some of the life processes continue for a short time and those which have been more or less injured to those which completely recover and show no visible signs of injury.

The facts just mentioned may be considered as an answer to the views of those who doubt the whole phenomenon of recovery after desiccation, among whom Zacharias ('86), Fredericq ('89) and Faggioli ('91) may be named as some of the more recent workers. The evidence advanced by these men is purely negative in char-

acter. In certain cases they failed to observe the recovery of dried rotifers and they, therefore, conclude that such recovery is impossible. On the other hand, many observers have contributed an abundance of positive evidence, of which that just given is typical. It is possible for anyone, by using the proper precautions, to dry rotifers and see for himself the gradual return of movements up to the time of complete recovery. It is certain, therefore, that the return of all of the normal vital activities in animals which by drying have been rendered motionless and apparently lifeless is not one of the myths of zoölogy as many have supposed. This does not imply that the rotifers which have been subjected to the conditions of dryness have actually undergone a true desiccation. From the evidences so far presented it is possible that they have not. This point will be discussed more in detail in the next section.

It is necessary to observe that all rotifers are not equally resistant to a process of drying. The only well authenticated cases of recovery after desiccation are found in the family Philodinidæ (Philodina, Rotifer and Adineta) in species which normally live in places where they are exposed to drying at frequent intervals. Perhaps other rotifers possess this power, but that such is the case has not been proven. A number of experiments made to determine this point with *Megalotrocha* and several of the Loricata gave purely negative results, no cases of recovery being observed. The observations of Lance ('94) are of interest in this connection. He found in the tardigrades that only those species could resist desiccation which live in places where they are exposed to it under natural conditions.

VI DEGREE OF DESICCATION ATTAINED BY PHILODINA

One of the most disputed points in connection with the entire subject of suspended animation in rotifers and other aquatic animals is the degree of desiccation they may attain without injury. Some workers hold that there is no limit to the amount of drying that may occur, while others just as strongly contend anything resembling a true desiccation is necessarily fatal. They believe that in

all cases in which recovery occurs the loss of the body fluids has in some way been prevented. Among those who have held this latter view, perhaps the most important name is that of H. Davis ('73) who was the first to give a plausible explanation of the means by which desiccation could be prevented. Since his views have found a wide acceptance and are frequently quoted at the present day, they will be considered at some length and an attempt made to determine their truth or falsity.

I The Views of Davis and Others

Davis as well as many others before him, had noticed that rotifers dried on a clean glass slide are killed by the process while if a little sand or moss is present recovery almost always occurs. He supposed that in the latter case the rotifers had time to protect themselves by secreting a gelatinous waterproof cyst which effectually prevented evaporation while in the former case, having no protection, they were dried and consequently killed. According to his view a true desiccation of the animal is always followed by death and in all cases of recovery desiccation has been prevented. He showed that grapes may be effectually protected against drying by means of a thin coating of gelatine and assumed that in the case of rotifers exposed to desiccation we are dealing with a phenomenon somewhat similar.

Others had claimed that the sand has a direct protective effect. Ehrenberg, for example, had compared it to the woolen mantle of an inhabitant of the desert and others had considered that it always holds in its interstices sufficient water to prevent complete desiccation. But Davis and Hudson rightly objected that sand at 100° C., at which temperature dried rotifers may survive for a short time, would be but poor protection against loss of water in the case of such a soft bodied animal, and Davis' explanation that the rotifers are covered by an actual waterproof capsule has the merit of being the first one to take this fact into consideration.

Nevertheless, there are many reasons why this view cannot be accepted. In the first place the evidence for the existence of such a gelatinous secretion is extremely slight. Davis did not see it

clearly himself and merely states in support of this view that several of his correspondents after reviving dried rotifers observed a quantity of sticky material adhering to them. This is not surprising since the cement glands at the tip of the foot are continually secreting a sticky substance by means of which the animal fastens itself to solid objects and which under certain conditions may be poured out in considerable quantities. The mere presence of a small amount of this substance seems like rather slender evidence on which to base such far-reaching conclusions.

Hudson ('89) is more definite in his statements. In describing the appearance of a group of rotifers dried on a piece of paper he says, "Each *Philodine* is the center of a patch of glutinous secretion which meets the similar patches surrounding its neighbors in a succession of straight lines; so that the whole group has quite a tessellated appearance. Here and there where fibers pass over or through a group long tongues of the secretion stretch from the animals to the fibers." The appearance observed by Hudson is a very common one in groups of dried rotifers; the interpretation he makes of it, however, is entirely wrong. What he thought to be the "glutinous secretion" is nothing but the cuticle of the animal from which the internal organs have shrunk more or less in the process of drying and which so closely resembles a secretion of some sort as to be easily mistaken for it on superficial observation. In the present experiments many careful observations were made on rotifers during the processes of drying and subsequent revival with the result that absolutely no evidence could be obtained that any such substance is secreted at the time of drying or dissolved when water is added. By adding a little methylene blue to the water before the rotifers dry, it is easy to follow the process in detail. This stain colors no part of the living animal but that portion of the cuticle which is outermost when it is contracted. If the animals are not allowed to remain in it too long there are no injurious effects and normal recovery occurs. Rotifers thus stained and then placed in clean water before being dried show very clearly all of the changes that occur during the process. If any secretion were poured out in the manner described by Davis and Hudson it should be visible outside of the stained cuticle.

Such, however, is not the case. The cuticle itself at the time of drying becomes the "glutinous patch" and on the addition of water resumes its original appearance.

If we assume that the peculiar staining reaction of this portion of the cuticle is itself due to a protective secretion of some sort we still see that the explanation of Davis cannot hold. The staining reaction is the same in all animals, creeping, swimming, and contracted, and appears very quickly. Even in rotifers killed instantly by a drop of boiling water the blue color appears just the same as in living ones. The secretion then, if such it be, is present in all individuals at all times and is not produced only on special occasions as Davis asserts and as it should be if his views were correct.

Another objection to Davis' theory lies in the behavior of the rotifers at the time of drying. Davis held that the failure of rotifers dried on a clean slide to protect themselves was because of their behavior under such unusual conditions. To quote from his paper, "The rotifers in crawling excitedly over the slide as they generally do trying to find more water or protection in their usual refuge—sand and dirt—part with much of their adhesive covering and the evaporation of the small quantity of water is so rapid that they have no time to settle down quietly as usual while more covering is secreted; they roam about almost to the last minute when they are overtaken by drought and shrink hastily into a ball to dry and perish." Davis evidently had observed the behavior of rotifers dried on a slide without sand; he just as evidently had not observed their behavior when dried with sand. If he had, he would have observed no differences of any importance. Whether a rotifer is dried on a plain slide, under a cover glass, or with sand its behavior is essentially the same. It keeps on creeping until the water has so far evaporated that it can creep no farther and then it contracts and dries more or less rapidly according to circumstances. When the water begins to disappear it does not stop when it comes to a quantity of sand and quietly encyst itself as he supposed. In almost every case it keeps on creeping the same as before and often dries up at some distance from the sand. That most of the rotifers are eventually found in

contact with the sand is due entirely to the fact that as the water disappears their movements become more and more restricted until they finally come to an end in its vicinity where the water lingers longest. It is true that the presence of sand is beneficial in the drying process but, as experiments to be mentioned later show, this is due entirely to the greater slowness of the drying under these circumstances and not to any preparations the animal makes to resist desiccation. That the presence of sand is responsible for no essential difference in behavior is shown by the fact that rotifers dried with a small quantity of sand show practically as great a mortality as those dried with none at all. If the mere presence of the sand enabled the rotifers to encyst themselves normally, we should not expect this to be so. If, on the other hand, the effect is merely one of the rapidity of evaporation, the fact finds a ready explanation.

It is seen, therefore, that the two points of originality in Davis' view, namely, the presence of protective secretion and a difference in the behavior of the rotifers when dried under different conditions are both based upon too slight evidence and are not confirmed by more careful observations. So far as his arguments go, there is no reason to believe that rotifers exposed to conditions of dryness can escape a true desiccation. On the other hand, in addition to this negative evidence there is much positive evidence in favor of the view that an actual drying does occur.

2 *Evidence for the View that True Desiccation Occurs*

In the first place, it must be noted that during the process of desiccation there are very marked changes in the size and form of the rotifers. Shrinkage always occurs and there may be considerable distortion of the body if the drying is rapid enough. According to Davis' view we should expect such shrinkage only in rotifers dried on a clean slide which are killed by the process. The fact is, however, that it occurs in all cases. When rotifers are very slowly dried, with or without sand, they retain their original form very perfectly and fairly accurate estimates may be made of their loss in volume during the drying process. From careful

measurements made on several different individuals before and after the addition of water it was determined that rotifers which had contracted to one-third or one-fourth of their original volume and remained in this condition for several weeks or a month were perfectly capable of being revived. A number of careful measurements showed that under all conditions of drying—on a clean slide, with sand, on filter paper, etc.—a very considerable shrinkage occurs, the exact amount being dependent on the conditions of the desiccation. How can such results, which may be obtained by anyone with very little trouble, be reconciled with Davis' theory that loss of water is prevented by an impermeable secretion? If the water is retained within the body how can such loss of volume occur?

It might be suggested, although such a supposition sounds rather improbable, that loss of water occurs up to a certain point but that by the time this point is reached formation of some sort of a protective covering has gone far enough to prevent its further escape. That a protective covering impermeable to water is not present is shown by the following experiment. Several rotifers were dried for a month under the most favorable conditions possible; at the end of that time they were examined and seen to be considerably shrunken. A small piece of wet filter paper was then placed in the dish in which they were contained in such a way as not to touch them, and the dish was covered with a piece of glass. Camera drawings were made of the rotifers at intervals of one minute to determine the effect of the moist atmosphere. A distinct swelling was observed in one minute and in five minutes the volume had increased perhaps 50 per cent. The dish was then uncovered and shrinkage immediately occurred. When water was added the rotifers recovered normally. This experiment, therefore, shows conclusively that in rotifers dried in such a way that recovery is possible after a desiccation lasting for a month the covering of the body is freely permeable to moisture. It is certain, therefore, that no such protection as that demanded by Davis' view is present.

It might perhaps be objected that in the above experiment the swelling observed took place mainly in the superficial part of the

body—perhaps even in a special secretion surrounding it. The following experiment shows clearly that this was not the case. A number of rotifers were stained *intra vitam* with neutral red and then carefully dried. Several were tested to be sure that revival occurred normally on the addition of water. Others were then subjected in the dish in which they were dried, to *moist ammonia* fumes, being kept under observation all the while. Almost immediately the internal organs, which had stained deeply in the neutral red, began to change color and in less than a minute had become yellow, showing thereby the penetration of the ammonia. This experiment, like the preceding, shows that the cuticle of normally dried rotifers is not impermeable to gases and to water vapor and that it therefore cannot protect the animals from desiccation. It is quite possible and even probable that the cuticle, especially the thicker part about the middle of the animal which covers it when it is contracted, is useful in retarding evaporation. Experiments to be mentioned below show that too rapid evaporation is injurious. But although it may retard evaporation it cannot prevent it and it seems certain, therefore, that so far as any external covering is concerned there is no bar to complete desiccation of the animal.

That rotifers which have been exposed to conditions favoring desiccation contain very little water is shown by simple physical methods. Spallanzani and Doyère both noticed that such rotifers are so brittle that they break into pieces when pressed with the point of a needle. The same result was obtained in the course of these experiments and it was also observed that no water could be obtained by exerting pressure on the cover glass covering the rotifers, provided that the latter were examined immediately after removal from the desiccator. When kept in a damp atmosphere for a short time they absorbed sufficient water to be detected by this method of treatment, and this probably accounts for the results obtained by Davis, who claims to have been able to squeeze water from rotifers which had been dried for three weeks in a vacuum, since he admits that the water was obtained only after *repeated* pressure had been applied. The fact that repeated pressure was necessary at all shows that the amount of water present could have been but slight, and it leaves room for the objection that there was

time for moisture to be absorbed from the atmosphere. That only a small amount of water is sufficient to give the appearance he describes may be proved by pressing under a cover glass small shreds of filter paper or pieces of apparently dry plant tissues. There is also a possibility that what Davis imagined to be water was only a thin film of air which under certain conditions arising in microscopic work closely resembles water.

The fact that desiccation is often very complete may be shown by chemical means as in the following experiment. A number of rotifers, stained *intra vitam* with neutral red, were allowed to dry under the most favorable conditions possible and were then placed in a desiccator over night. One lot was moistened and found to be normal in every respect. A second lot was exposed to ammonia fumes rendered as dry as possible by means of calcium chloride and a third lot exposed to the same fumes after having been allowed to remain in a moist atmosphere for five minutes. The third lot changed color from red to yellow almost instantly; the second lot retained their red color. That the effect in the latter case was not due to the inability of the ammonia to penetrate the cuticle was shown by the fact that a number of the rotifers which had been purposely crushed also retained their color. The failure of the characteristic reaction between ammonia and neutral red in the case of rotifers dried in a desiccator must be considered to indicate that they retain very little water.

There is also much indirect evidence that the desiccation is a real one. Some of this evidence will be mentioned later but it may not be out of place to refer at this point to the resistance shown by dried rotifers to high temperatures. Gavarret and others have found that rotifers in water are killed by a temperature of 51° C., giving all the evidences of heat coagulation. When partially dried and in a moist atmosphere they are killed at 81° C. and after thorough drying they may resist temperatures of 100° – 110° C. Doyère even found a rotifer which after being dried in the sun for several weeks was not killed by a very short exposure to 153° C. How can such results be explained on Davis' theory that the body fluids are retained within a watertight cyst? Does the protoplasm at the time of the formation of this cyst undergo some mysterious

change which causes it to resist the coagulating effect of high temperatures while still retaining its water? Such a supposition is on its very face highly improbable. On the other hand if we believe that there is an actual loss of water these facts fall in line with the observations of Lewith and others that in egg albumin with loss of water the coagulation temperature rises from 56° to 145° C. There is every reason to believe, therefore, that in *Philodina* we have to do with a true desiccation of the body. This is shown by the chemical and physical tests mentioned above, by the great amount of shrinkage that occurs at the time of drying, by the fact that the cuticle is freely permeable to gases and to water vapor, and by the additional fact that coagulation is not caused by relatively high temperatures. Furthermore, it has been shown that the only plausible explanation that has ever been given of a method by which loss of water could be prevented is based on insufficient observation and is not borne out by the facts. We must not assume, however, as many have done, that the desiccation is ever an absolute one. Even with the most perfect desiccating devices known it is impossible to remove the last traces of water at ordinary temperatures. The chemist recognizes the fact that in organic analysis it is necessary to heat the substance which is being analyzed almost to the charring point to remove all of the water it contains. With rotifers this is impossible since long before this point is reached certain irreversible changes have occurred which cause the death of the animal. It is certain that no rotifer has ever lived after an *absolute* desiccation. It is useless, therefore, to speculate whether or not life would be possible after complete removal of water, since such a condition cannot be attained by the means in our possession without destroying the very structures on which life depends. But the fact that an animal with no means of protecting itself against loss of water save the hygroscopicity of its tissues may remain capable of resuming its normal vital activities after a sojourn of weeks or even months in a vacuum or a desiccator is in itself a striking one and one which must necessarily enlarge our conceptions of the properties of living matter. ‘

VII EFFECT OF DESICCATION ON THE LIFE PROCESSES OF
PHILODINA

It has been seen that recovery is possible in the case of rotifers which have attained a considerable degree of desiccation. It remains to consider in more detail the effect of this desiccation on the life processes of the animal. Are the latter brought to a complete standstill or are they merely retarded? Is the dried rotifer dead or alive—or neither? Does the process of desiccation have any injurious effects and if so what is the nature of these effects? Questions such as these have occupied the attention of physiologists for many years and in the following section an attempt will be made to at least partially answer them. The last one—having to do with the injurious effects of desiccation—will be considered first since it appears to throw some light on the others.

I Injurious Effects of Desiccation

It has been the testimony of practically all observers that desiccation is always more or less injurious. This is shown by the fact that when large numbers of individuals are used some deaths always occur, even under the most favorable conditions of drying, and by the further fact that desiccation may not be repeated indefinitely. Spallanzani was the first to observe the latter point. He found that in certain rotifers experimented on by him all were killed after the sixteenth drying. In the course of this work Spallanzani's experiment was repeated with a small number of rotifers, the latter being dried once a day with a small quantity of sand. The following table shows the number of dead and alive on each successive day:

TABLE I

<i>Date</i>	<i>Alive</i>	<i>Dead</i>
December 31.....	11	0
January 1.....	8	3
January 2.....	5	6
January 3.....	2	9
January 4.....	2	9
January 5.....	2	9

<i>Date</i>	<i>Alive</i>	<i>Dead</i>
January 6	1	10
January 8	1	10
January 8	1	10
January 9	1	10
January 10	1	10
January 11	0	11

2 *Influence of the Previous Condition of the Animals*

The preceding experiment is typical of a considerable number performed and shows unmistakably that desiccation is a more or less harmful condition which some rotifers are better able to resist than others. That the resisting power of different individuals may be influenced by the conditions to which they were exposed previous to desiccation is shown by the following experiment. A number of rotifers were placed in a glass dish with a little clean water and were starved for three days. A number of others were taken from the original culture and both lots dried under exactly the same conditions and kept for the same length of time (four days). Water was then applied and the percentage which recovered noted. The following table gives the result of the experiment:

TABLE II
Effect of Starving

	Number of individuals	First movements (average for three rotifers)	Percentage of recoveries
Well fed individuals.....	15	19 minutes	80
Starved individuals.....	20	no movements	0

This experiment shows the great caution that must be used in comparing results obtained with rotifers taken from different cultures or the same culture at different times. In all of the following experiments the rotifers compared were as similar as it was possible to obtain them and furthermore fairly large numbers were dealt with so as to eliminate as far as possible this source of error.

*3 Influence of the Conditions Attending Desiccation**a Effect of Rapidity of Drying*

Since the time of Spallanzani it has been the almost unanimous testimony of all observers that rotifers dried on a clean glass slide, even for short periods of time, are killed, while when a little sand or moss is present this is not the case. These factors have been variously explained. Spallanzani thought that the sand was necessary to protect the animals from the injurious action of the air. Ehrenberg and others that it held in its interstices sufficient water to prevent actual desiccation and Davis that in its presence the rotifers were able to protect themselves by means of a waterproof cyst. All of these views have been shown to be untenable. That it is not contact with the air that kills the animals is shown by Doyère's experiment in which rotifers and tardigrades dried in the air showed a lower mortality than those dried in a vacuum. That the sand in itself cannot serve as a protection against evaporation is shown by the fact that it may be heated to a temperature of 100° C. or more without killing the rotifers contained in it. That Davis' explanation is not the correct one is shown by the fact, discussed at some length above, that even in rotifers dried with sand a true desiccation occurs. We are, therefore, forced to the conclusion that the favorable effect of the sand is due rather to a retardation of desiccation than to its entire prevention.

To test this view three lots of rotifers were taken from the same culture and the first dried without any sand, the second with a small quantity, and the third with a large quantity. All were then kept at room temperature under exactly the same conditions for four days, at the end of which time water was added and the rotifers kept under observation. In the following table the first column gives the number of individuals experimented upon, the second the average time required for movements to appear in a given number and the last column the percentage that eventually recovered. The number chosen for the second column was usually 10 per cent of the entire number of individuals and except where otherwise mentioned the determinations were made on this

basis. The choice of 10 per cent, of course, was entirely arbitrary but this number was found to be convenient and to give fairly reliable results. In making the last determination it was necessary to keep the animals for at least a day to be sure that no cases of revival should be missed. For this reason, in this and all similar experiments, the rotifers were dried in shallow glass dishes which could be covered and thus the loss of the water added at the end of the experiment prevented. A great fault to be found with much of the previous work on the subject is that ordinary glass slides were used with which on account of evaporation the rotifers could not be kept under observation for more than a few hours. Doubtless this is the reason why so many observers have been unable to find evidences of revival after drying without sand.

The results of the experiments, made with these precautions, are given in the following table. It will be seen that the time required for the first movements to appear is inversely proportional to the percentage of recoveries; in other words, the slower the movements are in appearing the greater is the mortality. This relation was shown in a large number of experiments to be quite general and knowing one quantity it is possible to predict in a rough and approximate way the other.

TABLE III
Effect of the presence of sand

	Number of individuals	First movements	Percentage of recoveries
Dried with large quantity of sand	49	12 minutes	82
Dried with small quantity of sand	65	45 minutes	17
Dried without sand.....	58	No movements in 40 minutes	5

These experiments are in full accord with the view that the protective effect of the sand is due to the greater slowness of the drying process when it is present. If the mere presence of sand in itself were sufficient to cause the rotifers to settle down and secrete a capsule about themselves we should expect that a small quantity would be almost as effective as a large quantity. This, however,

is not the case as the above figures show. The difference between the effects of drying with a small quantity of sand and with none at all is usually not so great as would appear from the table, since in the first experiment the mortality is unusually high. As a rule, almost the same result is obtained in the two cases.

The effect of the rapidity of drying is brought out in a striking manner in the following experiment. Two lots of rotifers from the same culture were dried at the same time at room temperature, the one in a calcium chloride desiccator and the other in a partly covered dish containing a piece of moist filter paper. In the first dish the drying required twenty-five minutes; in the second about twelve hours. The drops of water in the two cases were as nearly the same size as possible and neither contained any sand. After the drying had taken place both were kept for three days in the desiccator, attaining presumably the same degree of dryness.

TABLE IV
Effect of rapidity of drying

	Number of individuals	First movements minutes	Percentage of recoveries
Dried slowly under cover	60	7	75
Dried uncovered in desiccator . . .	51	39	12

It is seen from these figures that by allowing the drying to proceed slowly enough a large percentage of the rotifers may recover even when dried for several days in a perfectly clean glass dish. This result is opposed to most of the observations that have been made and is not in accord with Davis' theory. It must also be noticed that even where the drying was extremely rapid a certain number recovered when by using a covered dish rather than an ordinary slide they could be kept a sufficiently long time after the application of water.

Any method of retarding evaporation seems to have the same effect. Rotifers dried on small pieces of filter paper in which evaporation is necessarily slow may be preserved in good condition for very long periods. Even after a month movements appear

on the addition of water in five to seven minutes and creeping individuals are sometimes observed in ten or fifteen.

These experiments, therefore, seem to show that the rapidity with which the first part of the drying occurs is of great importance in determining the ultimate effect of the desiccation on the animal. They also serve to explain the discrepancies that appear in the accounts of various observers. Spallanzani, Pouchet, Davis, Hudson, Leidy, Zacharias, Faggioli and others state very positively that a few hours drying on a clean slide is invariably fatal. Doyère, on the other hand, is just as positive that such treatment is not necessarily harmful. When we examine the accounts given by these experimenters of their method of procedure we find that Doyère dried his animals very slowly while the others did not take this precaution, hence the disagreement in their results.

When we compare rotifers dried slowly with those dried rapidly we can see why the latter method of procedure should be injurious. A rotifer dried slowly, although shrunken to a fraction of its former size, preserves perfectly its original form and shows no irregular wrinkles on the surface of the body. The body wall fits tightly about the internal organs and the muscles adhere to it closely. One dried rapidly, on the other hand, is very irregular in appearance. The internal organs are more or less shrunken away from the cuticle which itself is often very much distorted, and sometimes has the appearance of an irregular gelatinous secretion. Frequently when water is added it may be seen that some of the muscles have been torn by the stresses set up by the rapidity of the drying and it is to be supposed that under these conditions the delicate internal organs would also suffer greatly. The injurious effect of the rapid drying therefore seems to be a mechanical one. Even those individuals which are not permanently injured by the first drying, since they are very susceptible to changes in moisture, if kept exposed to ordinary atmospheric conditions would be far more likely to be harmed than those which at the start contracted into a compact and symmetrical mass. This may explain the fact that rotifers dried without sand cannot be kept for such long periods of time as those dried under more favorable conditions.

b Effect of Temperature at which Drying Occurs

From the results obtained in the preceding experiment it might be thought that rotifers dried at a high temperature would show a greater mortality than those dried at a low one on account of the more rapid evaporation of the water. Strangely enough, this is not the case. In two parallel experiments in which all of the conditions are the same except the temperature at which the drying occurs, the rotifers dried at the higher temperatures always show the higher percentage as well as the greater rapidity of recovery. This relation was found many times. The following are two typical experiments. In the first one a moderate amount of sand was present; in the second the rotifers were dried in clean dishes, without any foreign matter. In both cases after the drying was complete, the dishes were allowed to remain covered at room temperature for four days before the application of water.

TABLE V
Effect of temperature at which drying occurs. Sand present

	Number of individuals	First movements minutes	Percentage of recoveries
Dried at 20°	49	12	82
Dried at 40°	55	4	94

TABLE VI
Effect of temperature at which drying occurs. No sand

	Number of individuals	First movements	Percentage of recoveries
Dried at room temperature fairly rapidly	58	no movements in 40 minutes	5
Dried at 40° in desiccator	52	20 minutes	65
Dried at 40° in covered dish	57	7 minutes	93

These experiments do not form an exception to the rule stated above that rapid drying is more injurious than slow drying. *Other things being equal* rapid drying is the more injurious. This is seen in Table V. The rotifers dried in the desiccator at 40° showed a

greater mortality than those dried slowly in a partially covered dish at the same temperature although in spite of the rapidity with which they were dried they were much less injured than those dried at 20°. We may conclude, therefore, that while rapidity of desiccation is a very important factor in determining the mortality, it is not the only one and it may even be obscured by certain others such as the one mentioned.

Attention must be called to the extremely high percentage of recoveries and the rapid appearance of movements in the case of the rotifers dried slowly at the high temperature. Although no sand or other solid matter was present and although the drying lasted for four days, fifty-four out of the fifty-seven rotifers recovered normally. This is as high a percentage as is usually obtained under natural conditions. When we recollect that almost all workers on the subject have failed to get any cases of recovery after even a few hours' drying in the absence of sand and that Doyère who is almost alone in having observed such recovery admits that in his experiments the mortality was always great and recovery very slow, we see the great importance of the external conditions under which desiccation occurs.

It is difficult to say just why the high temperature should have a beneficial effect. It cannot be that by promoting chemical changes it causes the formation of a protective secretion since rotifers dried at the high temperature appear even more shrunken than those dried at a low one and furthermore because they swell with equal readiness in a moist atmosphere showing the perfect permeability of their cuticle to water vapor. Perhaps the high temperature by favoring greater muscular activity may cause a greater contraction at the time of drying and thus prevent the injurious stresses set up in the tissues of a partially extended animal when the water leaves it rapidly. However this may be, it is interesting to note that under natural conditions the water in the urns in which *Philodina* lives must frequently reach a fairly high temperature at the time of its evaporation from exposure to the sun's rays and perhaps the greater resistance shown by this rotifer when dried at a high temperature is due to an adaptation to the conditions under which it lives in nature.

c Effect of Duration of Desiccation

The effects so far considered have been those due to the conditions under which drying occurred. It has been seen that the rapidity of the drying has a very important relation to the ultimate effect of the process and that the temperature at which it occurs is also of importance. There are other effects, however, which do not depend on the conditions under which the desiccation occurs, for example, it has long been known that the duration of the desiccation must be taken into account. Other things being equal, the longer the rotifers are kept the smaller are their chances of recovery. This fact has been noticed by numerous observers; Davis was unable to revive rotifers that had been kept dry under natural conditions for a year. The following table, based on experiments made on rotifers dried fairly rapidly in the absence of sand illustrates the relation that exists between the duration of the desiccation and the mortality. The rotifers all came from the same culture and were dried under exactly the same conditions at the same time.

TABLE VII
Effect of duration of Desiccation

Time of drying	Number of individuals	First movements minutes	Percentage of recoveries
5 minutes.....	40	11	98
1 hour.....	27	14	89
24 hours.....	32	22	84
2 days.....	25	35	60
4 days.....	33	68	54

d Effect of Alternations of Moisture and Dryness

Since the conditions of drying in the preceding experiments were the same in each case the difference in mortality observed must be due to some progressive change or changes that continue throughout the entire period of desiccation, the only variable factor being that of time. The question arises as to the cause of the

larger number of deaths in the longer period of drying. Is there a gradual loss of water which eventually injures the animals? Does slow metabolism gradually destroy the organs of the body in the absence of food? Do injurious waste products accumulate which cannot be eliminated? Or do changes of temperature and moisture result in mechanical injury to the tissues?

That changes in moisture and changes in temperature insofar as they cause changes in the relative humidity of the atmosphere have an injurious effect may easily be shown. In the following experiments two dishes containing rotifers from the same culture were dried under exactly the same conditions, no sand being present in either. Both were placed in an oven at a temperature of 40°. The first one was kept covered, its condition, therefore, remaining uniform, and the second one alternately turned upside down over a small dish of water and right side up over the same dish, being thus exposed to alternating moist and dry conditions. This process was repeated five times during a period of an hour and a half. In no case were the rotifers touched by the water. As in the other experiments the time required for the appearance of movements and the percentage that recovered were noted.

TABLE VIII
Effect of alternations of moisture and dryness

	Number of individuals	First movements	Percentage of recoveries
Dry 1½ hours.....	44	9 minutes	48
Alternately moist and dry 5 times.....	55	no movements	0

This experiment is interesting in several ways. In the first place, if death depended on loss of water as assumed by Davis and others we should expect the mortality to be less in the second case in which the rotifers had scarcely an opportunity to become thoroughly dried than in the first in which evaporation was unchecked. Instead, we find the reverse to be the case. In the second place the experiment shows in a physical way watsiologh

certain experiments mentioned above show in a physical way, namely, that the cuticle of dried rotifers is freely permeable to water vapor, their death being caused by changes in the amount of moisture.

Since rotifers are so easily killed by rapid changes in moisture content it must be supposed that in nature this is at least one of the factors responsible for the higher mortality during long periods of desiccation. The causes of the injury as in the case of rapid drying is probably mechanical, resulting in destruction of the delicate internal organs and the cells composing them. Rotifers living under natural conditions where much sand and organic matter is present would not be subjected to such rapid changes as those kept in small dishes and hence the mortality would naturally be expected to be lower. The protective effect of sand, therefore, is due not only to prevention of too rapid drying at the start but to prevention of too rapid changes in the moisture content of the animals after desiccation has occurred.

e Effect of the Intensity of the Desiccation

The mechanical injuries to the tissues caused by the swelling and shrinking under different atmospheric conditions are not the only causes of death during a prolonged desiccation. Under perfectly uniform conditions either in the dry air of a desiccator or in air thoroughly saturated with water vapor the same relation exists between mortality and duration of the desiccation. Other things being equal, a long desiccation is more injurious than a short one. Since the external conditions remain the same the injury must be due to some progressive change occurring within the body of the animal. Conceivably this change might be (1) a gradual loss of water (2) an accumulation of injurious waste products or (3) metabolic processes by which either the reserve supplies of food or the body tissues themselves are slowly used up.

There are many reasons to believe that the first of these possibilities is of little importance. The loss of water after the first part of the drying has occurred would be extremely slight and under ordinary conditions would come to an end as soon as an

equilibrium had been reached with more or less moist surrounding atmosphere. In a desiccator, to be sure, evaporation could continue almost indefinitely, but it has been seen from the experiments of Doyère, Gavarret, etc., that even after the most intense desiccation possible by physical means at ordinary temperatures many rotifers may recover, while they would surely have been killed if kept long enough under conditions in which the same degree of desiccation could never have been attained. Furthermore, in an atmosphere saturated with water vapor the drying is very slight and yet the same relation between mortality and duration of desiccation is noticed as in a case where thorough drying may occur. All attempts made in the course of this work to show by experiment that the intensity of desiccation in itself, and apart from other factors, has an effect on the mortality gave negative results. It could not be proved that an intense degree of desiccation is more injurious than a moderate one except insofar as a greater mechanical injury results when the water is extracted rapidly from the tissues. Presumably, the harmful effect of very perfect desiccation would be but slight if the water could be extracted slowly enough to avoid mechanical injury to the vital organs. Indeed, it seems certain that under some conditions a complete or nearly complete desiccation is far less harmful than an imperfect one. Rotifers kept in a moist atmosphere actually show a greater mortality than those kept in a dry one. The following experiment makes this point clear. Four dishes containing rotifers from the same culture were dried under exactly the same conditions (40° C. and no sand). All were kept for four days, one covered at room temperature, one covered at 40°, one in an atmosphere saturated with vapor at room temperature (average 20°) and one similarly saturated at 40°.

TABLE IX
Effect of moisture. Temperature constant (20°)

	Number of individuals	First movements minutes	Percentage of recoveries.
Moist atmosphere.....	48	9	38
Dry atmosphere.....	54	8	85

TABLE X
Effect of moisture. Temperature constant (40°)

	Number of individuals	First movements	Percentage of recoveries
Moist atmosphere.....	47	no movements	0
Dry atmosphere	45	14 minutes	71

It is seen from the tables that those kept in the moist atmosphere showed a far higher mortality than the others. The percentage that recovered was only 38 per cent as against 85 per cent at room temperature and 0 per cent against 71 per cent at 40°. We are forced to conclude therefore that death is not due to loss of water but to some process that is promoted by the presence of water. This being the case, what becomes of the view of Davis and others that rotifers protected from desiccation live while those exposed to it die? If a rotifer be protected by a waterproof and airtight cyst and be moist inside anyway, why should the presence of a little moisture in the air surrounding it be so injurious? This and other similar experiments show how untenable such a theory is

f Effect of Temperature on Mortality

It has been seen that rotifers dried at a high temperature show a lower mortality than those dried at a low one. If, however, the high temperature be allowed to continue for any length of time it has a harmful effect. This relation suggests that certain metabolic changes may be a source of injury to the animals since chemical reactions in general, including those which go on in the bodies of living organisms, take place far more rapidly at high than at low temperatures. The fact that the moisture causes an increase in the mortality, the greatest number of deaths occurring at the high temperature in the moist atmosphere, confirms this view. For convenience in comparison the two preceding tables are rearranged so as to make the amount of moisture the constant factor, the temperature being the variable one.

TABLE XI
Effect of temperature. Moisture constant
 MOIST

	Number of individuals	First movements	Percentage of recoveries
Kept at 20°	48	9 minutes	38
Kept at 40°	47	no movements	0

TABLE XII
Effect of temperature. Moisture constant
 DRY

	Number of individuals	First movements minutes	Percentage of recoveries
Kept at 20°	54	8	85
Kept at 40°	45	14	71

4 *Condition of the Life Processes in a Dried Animal*

It has been seen that the causes of injury to *Philodina* during a process of drying are various in nature. We can distinguish between the mechanical injuries resulting from too rapid desiccation or from sudden changes in the moisture content of the tissues and the injury which is due to slow changes within the body of the animal which continue under the most uniform external conditions. The fact that these changes are greater at high temperatures and under conditions of moisture than at low temperatures and in the absence of water makes it probable that they are chemical in nature and represent a certain amount of metabolism in the body of the animal. The question naturally arises whether death in the cases cited was due to an actual destruction of the tissues or to some more indirect cause. The former alternative is that adopted by Ritzema Bos in the case of *Tylenchus*. Many considerations make this view improbable in the case of *Philodina*. In the first place, both old and young individuals may be kept in an apparently healthy condition for at least a week in water free from any organic matter that might serve as food. In this case, where active movements continue all the while and where

the body is thoroughly saturated with water, destructive metabolism would necessarily be far more rapid than in the cases mentioned. If death does not occur in the former case it would be far less likely in the latter. The death of rotifers kept for four days in a moist atmosphere, therefore, cannot be explained as being due to destructive metabolism alone. It might be objected that the process of drying in some way lowers the vitality of the animals so that they are more readily injured by changes of this sort. That this is not the case is shown by the following experiment. Thirty-nine rotifers were dried in the same way as those used in the last mentioned experiments. The dish containing them was then inverted over another dish of water in such a way that the moisture could condense on it in small droplets. In this way each rotifer became surrounded by a minute drop of water which, however, in most cases was too small to permit creeping, although allowing a certain amount of movement. They were allowed to remain in this condition for four days, during which time, of course, no food could have been obtained even though feeding movements had been possible. When water was added, all began to creep at once and seemed perfectly normal in every respect. The experiment was repeated with twenty-eight rotifers and again 100 per cent of the animals recovered, creeping movements beginning almost immediately. It will be observed that in these two cases the animals had been dried and by the addition of a very small amount of water placed in conditions favorable to metabolism. Although no food was present all of the animals recovered. Of those dried in the same way and kept for the same time at the same temperature with only so much water as they could absorb from the air, only 38 per cent recovered—and this was a somewhat higher percentage than was obtained in other similar experiments.

We have to deal, therefore, with an interesting condition. Rotifers dried and kept dry recover normally; those dried and placed in a small quantity of free water do likewise; those dried and kept in an intermediate state are mostly killed. What is the cause of this condition? If we examine a rotifer that has been placed in a moist atmosphere after being dried we find that although in appear-

ance it is plump and moist there are absolutely no traces of movement either in the muscles or the contractile vesicle. The animal is to all appearances dead, although the experiments mentioned show that certain metabolic changes in all probability are occurring. In the case of animals surrounded by even a very small quantity of free water movements may frequently be observed and the activity of the nephridia may often be clearly seen. In the dried animal, while there are no movements of any sort, metabolic changes must necessarily be very slow. It is possible, therefore, that in the case of the rotifers surrounded by the moist air that death may be caused by the fact that only a part of the functions of the body continue while the others are suspended, metabolism, for example, going on but the excretory organs being unable to remove the waste substances set free. Perhaps, under these conditions, owing to the impossibility of free interchange of liquids between the different parts of the body, some of the organs are especially affected by the metabolic changes that occur. Whatever the nature of the processes with which we are dealing may be, it seems certain that a state in which rapid chemical changes may continue while some at least of the other vital processes have been suspended is one of great danger to the animal. This danger may be overcome either by reducing the chemical changes that occur by further drying or by causing the resumption of the other vital processes by the addition of a little free water.

It is interesting to note that the suspension of many of the normal activities of the animal occurs very suddenly. If a rotifer drying on a clean slide be watched under the microscope and a drop of water added at the instant when the last film of water surrounding it is about to disappear, movements are seen to be resumed within a few seconds; if the water be added a second after the film has disappeared no movements occur for several minutes. The actual amount of desiccation in the two cases is almost the same; the effect produced is very different. As the last traces of the surrounding water leave the animal there is a sudden suspension of certain of the life processes. The suddenness of this suspension as well as the fact that it occurs before actual drying of the tissues of the animal has begun makes it probable that we are dealing

with a phenomenon under the control of the nervous system. We have to distinguish, therefore, between metabolic processes, which continue as long as any water is present, and other life processes which come to a sudden stop at the very onset of desiccation.

This brings up the question, so often discussed in past years, as to whether a rotifer which has been dried as thoroughly as possible may be said to be living or what Preyer terms anabiotic, that is, lifeless but capable of life as opposed to lifeless and incapable of life. The truth probably lies between the two extremes. We have no reason to believe that there is a complete cessation of all metabolic changes, as Preyer and others have asserted, since so long as any traces of water are present such changes are possible even though they may be greatly reduced in extent, and it is well known that it is impossible to remove all of the free water from organic substances at ordinary temperatures. On the other hand, there appears to be a complete suspension of many of the normal vital processes. Those which depend on movements, either muscular or ciliary, are clearly impossible, and in all probability many others whose nature is more obscure cannot continue in the almost complete absence of water. In a dried rotifer, therefore, we have a cessation of the functions of many of the organs as such, while a certain amount of metabolic change in the tissues of the body as a whole still continues. Whether an animal in such a state is to be called living or lifeless depends entirely on our definition of "life."

5 *Effect of Desiccation on Egg Production*

During the course of the experiments carried on on *Philodina* it became apparent that a definite relation exists between the periods of drying and those of egg production. It was noticed that at certain times eggs and egg containing individuals were very numerous and that at other times they were almost lacking. Instead of a continual production of eggs as might be expected in a culture containing individuals of all ages and all degrees of maturity it was found that the eggs were produced at almost the same time by all the members of the community regardless of their size and age. On examining the records kept of the condition of the

various cultures, it was found that in every case the period of maximum egg production had been preceded by a period of desiccation and furthermore, that each desiccation of any length of time had been followed by an increase in the reproductive activity. This relation seemed to present so many points of interest that more exact observations were made extending over a period of several months. In addition, certain experiments were arranged in which other factors which might have an influence on the result were kept under control. The following is an account of the observations made on culture II during January, February and March, 1908.

The culture was started in December, 1907. After being dried several weeks, water was applied on January 2. Beginning with January 8 differential counts were made every few days to determine the percentages respectively of eggs, newly hatched young, and adults showing developing eggs. These counts were made from random samples of fifty or more individuals taken from different parts of the dish. Although the results thus obtained could from their nature be only approximate, the fact that several counts made on the same day usually agreed very closely and that smaller cultures in which the entire number of individuals could be observed showed exactly the same changes makes it certain that the figures given represent fairly accurately the condition of the culture as a whole. In Fig. I the percentages of the different classes of individuals have been plotted as ordinates over the dates of observation and curves drawn to represent the changes that occurred in the condition of the culture from day to day. The breaks in the curves represent the periods of desiccation.

Reference to the table will show that aside from a few irregularities due to the entrance of the element of chance the curves for the three periods show a general similarity. The curve representing the number of egg containing individuals shows a maximum about four days after the application of water, that representing the number of eggs shows a maximum in each case after an interval of six or eight days and that representing the number of young after ten or twelve days. These figures agree closely with those obtained where a small number of rotifers were kept under

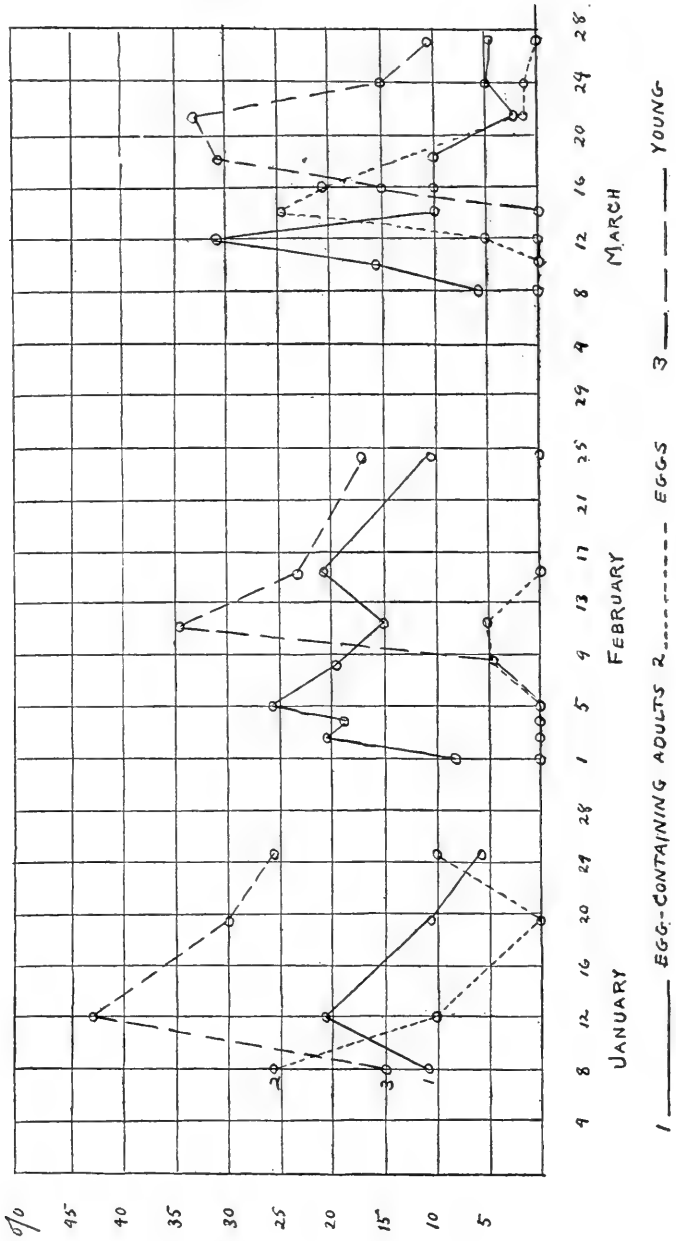

FIG. I

observation. The three maxima follow each other in regular order, as should be expected, the maximum for the development of the eggs within the body coming first, then that for the deposited eggs, and finally that for the newly hatched young. The two most noticeable irregularities in the curves occur in the January series. The first is in curve 1 where the maximum comes after the maximum of curve 2 instead of before it. This is probably due to the fact that no records were kept between January 2 and January 8. If they had been, a maximum in all probability would have been found during this period. The second irregularity, that in the curve representing the number of eggs, on January 25, was due to finding a cluster of five eggs, the eggs usually being laid in groups. A careful search failed to disclose any more eggs and hence this apparently high percentage did not represent a general condition in the culture, being merely one of the errors of chance that cannot be eliminated from a method of this sort. However, taken as a whole, the curves show in a striking manner the relation between desiccation and egg laying.

It might perhaps be objected that inasmuch as the periods of desiccation came at approximately equal intervals, their apparent influence on egg production might be due merely to a chance coincidence with a regular periodicity in the production of eggs which is independent of external conditions. That this objection has no force is shown by the fact that in other cultures dried at very irregular intervals exactly the same results were obtained and furthermore that in cultures allowed to continue for a long time without drying no such periodicity was observed. In one such case the culture had not been permitted to dry for several months. During the latter part of this period the percentage of eggs had fallen almost to zero, it being a rare occurrence to find even a single egg. The culture was then allowed to dry for two weeks. Ten days afterward the percentage of eggs had increased to over fifty where it remained for a few days and then again diminished until a week or two later it was at zero.

A number of experiments were made on small numbers of individuals. By keeping them in a fairly small drop of water in a covered dish an accurate count could be made of the number of

eggs produced. In one such case thirty rotifers which had laid no eggs for some time previously in less than a week produced fifty-five eggs. Similar results were obtained in other experiments. The length of time necessary for the appearance of eggs was about the same as that required in the large cultures.

A factor which must be considered as a possible cause of the phenomenon just described is the food supply. Associated with *Philodina* there are always found large numbers of the unicellular plant, *Sphærella lacustris*. The rotifers feed to some extent on the partly grown cells but much more largely on the small microzooids which are produced in large numbers after each period of desiccation. It might be thought, therefore, that the effect observed was due not to the direct influence of the desiccation but to its indirect influence in causing an increased food supply. To decide this point, experiments were tried in which the rotifers after being dried were placed in water free from microzooids. In all such cases, although there was no increase in the food supply, egg production was brought about just as before. The following experiment is a typical one selected from a number showing similar results.

Six rotifers were taken from a small culture in which no eggs had been laid for several weeks, and dried on a clean piece of filter paper for twelve days. On March 7 they were placed in a dish with water and as soon as they had revived the filter paper was removed. No food of any sort was present. In one of the rotifers the ovary was slightly enlarged, in the others it showed no signs of developing eggs. On March 8 the alimentary tract of all had acquired a glandular appearance but contained no food. Traces of egg formation were observed. On March 9 three contained fairly well developed eggs. On March 10 all six contained eggs and two individuals contained two eggs—a rather unusual occurrence. On the 11th one of the rotifers had died but the other five all contained eggs. On the 12th seven eggs had been laid, on the 14th eleven and on the 16th twenty-one, of which four had hatched. By the 17th ten of the twenty-one eggs laid had hatched and by the 21st all had hatched, no new ones being laid after March 16. On the 21st only one of the five rotifers showed any signs of

an egg in the ovary and this one did not develop. No further egg laying occurred.

This and similar experiments show that the production of eggs is not due to the better food supply after a period of desiccation; since egg production takes place in the absence of food. Furthermore, in the cases where a few individuals were kept under direct observation the formation of eggs was sometimes observed to begin before the microzooids had been produced. That the food supply is not without effect, however, is shown by observations such as the following. Seven rather small rotifers showing no trace of eggs were dried on filter paper for three weeks and then placed in a dish of clean water without any food whatever. The development of eggs started just as before and in three days all except one contained partially grown eggs. At this point, however, development ceased, the eggs becoming no larger. Six days later microzooids were added from another culture. The rotifers fed rather freely on them and in three days all contained large eggs. An egg laying period then ensued which did not differ from those already described. This experiment shows that although an abundant food supply is not the factor that starts egg production, a sufficient supply of food must be present in order that the latter shall continue. This is especially the case in smaller rotifers in which the reserve supply stored in the tissues of the body is not great.

Another factor that must be considered is the amount of oxygen present in the water. It is conceivable that the failure of old cultures to produce eggs is due to an exhaustion of the oxygen supply of the water and that the greater activity after a period of drying is due to a renewal of this supply. To this objection it may be answered that cultures in which *Sphærella* is present in abundance and in which, therefore, considerable oxygen must be set free in the presence of the light, behave exactly in the same way as cultures in which *Sphærella* is altogether absent. Furthermore, the addition of fresh water when the culture is almost dry or even after a very short period of desiccation produces no noticeable effect. This last mentioned fact speaks against the view that a diminished production of eggs in old cultures occurs as the result of the accumulation in too large quantities of injurious waste

products. No matter how large the volume of water added no increase in egg production occurs without a fairly long desiccation. In cases where rotifers were transferred to other dishes and placed in fresh water there seemed to be no noticeable increase in reproductive activity.

Although desiccation is able to cause the formation of eggs at times when they would not otherwise appear it is not always necessary for their production. In an experiment made to determine the length of life of *Philodina*, several individuals, raised from the egg without any desiccation, when about a week old began to lay eggs and continued to do so for several weeks. Furthermore, it must be noted that under more natural conditions than can be obtained in the laboratory, eggs seem to be produced more freely than in the cases mentioned. Their production does not seem to be so clearly related to a period of desiccation. This may be partly due to the greater variety in the conditions met with out of doors in a large stone urn and partly to the more abundant food supply which would permit the effects of a single drying to last for a longer time. However this may be, and whether or not desiccation is the only factor concerned in the production of eggs the experiments described leave little room for doubt that it is a factor and under certain conditions a most important one. Under these conditions the process of desiccation serves as a stimulus to cause the production of eggs at times when otherwise they would not be produced. The drying in some way starts into activity the previously resting germ cells and inaugurates a process of growth and division which may continue for a considerable time after the initial stimulus has ceased to act. This fact is of some interest when considered in connection with certain other well known phenomena relating to the development of both plants and animals.

It is well known that most cells cannot continue to grow and divide indefinitely, without receiving certain stimuli from without. The behavior of some of the Protozoa furnishes a striking example of this point. Several workers have shown that in *Paramœcium* after a number of generations division becomes slower and finally ceases unless an appropriate stimulus be supplied. In

nature, this takes the form of a conjugation with another individual, but as Maupas, Calkins, and others have shown, other stimuli may serve the same purpose. After division has ceased it may again be started by a change in food or by various chemicals. Perhaps the list of stimuli that produce this effect is larger than we now suspect. Many examples might be given of the effect of external stimuli in causing growth to proceed beyond its usual limits. The production of plant galls by the stings of insects is one of the best known cases. Possibly the formation of certain pathological growths in animals is due to similar causes. Another example is furnished by the regenerative processes that occur in both plants and animals after injuries, in which resting cells are stimulated into activity.

In the case of the germ cells, which are potentially immortal the effect of outside stimuli is also clearly seen. In the life of nearly every egg cell, after a period of active growth and division comes a stage in which further development is impossible without some outside stimulus. Usually this stimulus is supplied by the entrance of the sperm. The process of fertilization has for its purpose two objects, the one being the introduction of new hereditary qualities and the other the stimulation of the resting protoplasm of the egg to develop. That these two processes are distinct is shown by the fact that under certain conditions development may be made to occur in the absence of the sperm. Cases of artificial parthenogenesis have been reported in many groups of animals in which fertilization is the rule in nature. The echinoderms, molluscs, annelids, and insects all furnish examples, and even in some of the vertebrates the early segmentation stages have been obtained by means of appropriate stimuli. Artificial parthenogenesis may be brought about in a variety of ways. Heat, chemicals, and hypertonic salt solutions have all been used with success. Furthermore, as Loeb has shown, a combination of two of these methods may be more effective than one alone. Experiment will doubtless show new methods and new combinations of old methods to secure the same result.

Is it not possible that in the case of *Philodina* the process of drying may furnish a stimulus comparable to those just mentioned,

the desiccation serving to start the development of the resting germ cells? Analogous cases are known in plants. Many seeds are known to be incapable of germination until they have been dried for a certain length of time. Drying is said to start into activity the resting buds of trees. In *Sphærella lacustris*, which is always found associated with *Philodina*, microzoöids are always produced in large numbers after a period of desiccation. Furthermore, in Loeb's experiments on artificial parthenogenesis, the extraction of water from the eggs by hypertonic solutions furnished a very effectual means of starting developmental processes. Loeb has shown that the important factor in this case is the actual loss of water rather than its reabsorption when the eggs are again placed in normal sea-water. There seems to be no doubt, therefore, that under certain conditions loss of water may be an active agent in starting processes of growth and development in resting cells.

It is interesting to note, although the fact may have no significance, that the group of rotifers to which *Philodina* belongs, which are the only ones of the rotifers normally subjected to frequent periods of desiccation, at the same time are the only ones in which sexual reproduction has been entirely lost. The thought suggests itself that in the presence of such great changes in the external conditions the stimulus furnished by the union of the sex cells of different individuals is not so necessary as in most other animals. On the other hand, it must be noted that in the aphids parthenogenesis is said to continue as long as the external conditions remain uniform, males being produced only when there is a change in these conditions. Be this as it may, the fact remains that desiccation in certain rotifers is able to bring on a period of reproduction. Whether or not this is the only factor involved it undoubtedly is an important one and one which may be found to have a wider significance than we now suspect.

VIII SUMMARY

1 Rotifers of all ages may recover all of their normal activities after an extended period of desiccation.

2 The tissues of the body become truly desiccated, as is shown by the amount of shrinkage that occurs, by physical and chemical tests for water, and by other more indirect methods. The desiccation, however, must not be considered an absolute one, it being impossible to remove the last traces of water at ordinary temperatures.

3 The cuticle of *Philodina* under all conditions of desiccation is freely permeable to water vapor and gases. No evidence of a waterproof cyst can be found.

4 The presence of sand, etc., is not necessary that recovery shall occur as many have claimed. By proper conditions of drying almost all of the individuals recover after a desiccation of at least four days in the absence of all solid matter whatever.

5 The process of drying is always more or less injurious under any conditions, as is shown by the fact that some deaths almost always occur and that it may not be repeated indefinitely.

6 The chances of recovery of a given individual depend on its previous condition as well as on the circumstances under which drying occurs.

7 The rapidity of the drying process has a very important effect on the mortality, rapid drying being more injurious than slow drying. It is apparently immaterial by what means the process of drying is slowed.

8 The injurious effect of rapid drying seems to be due to mechanical injuries to the vital organs and the cells composing them caused by the rapid extraction of water.

9 The final intensity of the desiccation makes little difference in the mortality provided it be attained gradually enough.

10 Other things being equal, a fairly high temperature at the time of drying is favorable, a low one unfavorable.

11 Alternations of moisture and dryness are very injurious.

12 Rotifers kept at a high temperature show a greater mortality than those kept at a low one.

13 Rotifers kept in a moist atmosphere show a greater mortality than those kept in a dry one.

14 Metabolic changes in the tissues probably continue in dried rotifers though very much retarded. The functions of the various organs as such are suspended.

15 The suspension of these functions occurs very suddenly, possibly owing to nervous control.

16 Desiccation usually brings on a period of reproductive activity.

BIBLIOGRAPHY

- BLAINVILLE, M. H. de '26—Sur Quelques Petits Animaux qui, après avoir perdu le mouvement par la dessiccation, le reprennent comme auparavant quand on vient à les mettre dans l'eau. *Ann. des Sci. Nat.*, ix, 104-110, 1826.
- BROCA, P. '60—Rapport sur la Question soumise à la Société de Biologie par Pouchet. MM. Penetier, Tinel, et Doyère au Sujet de la Reviviscence des Animaux Deséchés. Lu à la Société de Biologie le 17 et le 24 Mars 1860 par M. Paul Broca au Nom d'une Commission composée de MM. Balbiani, Berthelot, Brown-Séguard, Dareste, Guillemin, Ch. Robin et Broca, Rapporteur. *Mem. de la Soc. Biol.* (3), ii, 1-139.
- DAVIS, H. '73—A New Callidina: with the Result of Experiments on the Desiccation of Rotifers. *Mon. Micr. Journ.*, ix, 201-209.
- DOYÈRE, M. P. L. N. '42—Memoire sur les Tardigrades. *Ann. des Soc. Nat.* (2), xviii, 1-32.
- EHRENBERG, C. G. '38—Die Infusionsthierchen. Leipzig, p. 492, 1838.
- FAGGIOLI, F. '91—De la prétendue reviviscence des Rotifères. *Archiv. Ital. de Biol.*, 360-374, 1891.
- FREDERICQ, L. '89—La lutte pour l'existence chez les animaux marins Paris, 1889.
- FROMENTEL, E. de '77—Recherches sur la revivication des rotifères, les anguillules et les tardigrades. *C. R. Assoc. Franc. l'avanc. des sci.* vi, 641-657.
- GAVARRET, J. '59—Quelques Expériences sur les Rotifères, les Tardigrades, et les Anguillules des Mousses des Toits. *Ann. des Sci. Nat. (Zool.)*, (4), xi, 315-330.
- HAZEN, T. E. '99—The Life History of *Sphærella lacustris*. *Mem. of the Torr. Bot. Club*, vi, 3, 1899.
- HUDSON, C. T. '73—Remarks on Mr. Henry Davis' Paper "On the Desiccation of Rotifers." *Mon. Micr. Journ.*, ix, 274. The Desiccation of Rotifers. *Journ. Roy. Micr. Soc.* (2), vi, 79.
- HUDSON, C. T. AND GOSSE, O. H. '89—The Rotifera or Wheel Animalcules. London, 1889.

- JENNINGS, H. S. '04—Contributions to the Study of the Behavior of Lower organisms. Carnegie Inst. Publications, 1904.
- KOCHS, W. '90—Kann die Kontinuität der Lebensvorgänge zeitweilig völlig unterbrochen werden? Biol. Centralb., x, 673-686, 1890.
- ECKSTEIN, K. ('83)—Die Rotatorien der Umgegend von Giessen. Zeitschr. f. Wiss. Zool., xxxix, 343-344. 1883.
- LEEUWENHOEK, A. von, 1719—Continuatio Arcanorum Naturæ. Epist. 144 ad Henr. Bleysvicium Lugd. Batav., 1719.
- LEIDY, J. '74—Remarks on the Revivification of Rotifer vulgaris. Proc. Acad. of Nat. Sci., Phila., p. 88, 1874.
- NEEDHAM, T., 1743—A Letter Concerning Chalky Tubulous Concretions, with some Microscopical Observations on the Farina of the Red Lily, and on Worms Discovered in Smutty Corn. Phil. Transact., xlii, 634-641, 1743.
- POUCHET, F. A. '59—Expériences sur la resistance vitale des animalcules pseudo-resuscitants. Comp. Rend., xlix, 886.
- '59—(2) Nouvelles Expériences sur les animaux pseudo-resuscitants. Comp. Rend., xlix, 492. (3) Recherches et expériences sur les animaux resuscitants. Paris: J. B. Balliere et fils, 92 pp., 1859.
- PREYER, W. '91—Ueber die Anabiose. Biol. Centralb., xi, 1-5. 1891.
- RITZEMA BOS, J. '88—Untersuchungen über Tylenchus devastatrix. Kühn. Biol. Centralb., vii, 650-659. 1888.
- SLACK, H. J. '73—The Desiccation of Rotifers. Mon. Micr. Journ., ix, 241, 1873.
- SPALLANZANI, L., 1787—Oeuvres: Opuscules de physique, animale et végétale, etc. trans. Jean Senebier. Tome, ii, 203-285.
- ZACHARIAS, O. '86—Können die Rotatorien und Tardigraden nach vollständiger Austrocknung wieder aufleben oder nicht? Biol. Centralb., vi, 230, 1886.



PROTOZOAN STUDIES

BY

J. F. McCLENDON

WITH TWO PLATES

While studying the Protozoa under Dr. H. S. Jennings in 1904-1905 I was impressed by the number of the theories relating to the physiology of these minute organisms and began to devise experiments with a view to testing some of the theories. Without attempting to draw very general conclusions from these experiments it is hoped that they will at least suggest further problems and make clearer the fact that Protozoa are very complex organisms. Not until quantitative studies of several forms are made will the physiology of the Protozoa be understood as clearly as that of the higher vertebrates. We cannot until then be sure of the significance of reactions such as are described in this paper and for this reason they are not fully discussed.

I. REACTIONS OF AMŒBA PROTEUS TO MINUTELY LOCALIZED STIMULI¹

The reactions of Amœba to various stimuli have been described by various writers, but with the aid of the apparatus shown in Figs. 1 and 2 a more precise localization was possible.² As has been the case with other studies on Protozoa, so here, a detailed study reveals complexities comparable with those found in higher organisms.

Mechanical Stimulation

Amœbæ were stimulated with an extremely fine glass needle. The time was counted with a metronome and distances measured

¹ These experiments were made at Randolph-Macon College, Ashland, Va., in 1907.

² To any one wishing to have apparatus like this made I would be glad to furnish descriptions or other data.

with an ocular micrometer in one eye piece of a Zeiss binocular microscope. The results of a large number of experiments show that the *Amœba* does not respond to mechanical stimuli of very small area unless they be repeated at short intervals of time (one to two seconds), and that this interval is in inverse ratio to the area stimulated. Even when a glass needle was thrust through the *Amœba* so that the end protruding from the other side was seen, no response was obtained, but the *Amœba* moved along as usual, the needle cutting a path through the protoplasm until the *Amœba* had passed beyond it. When an *Amœba* was cut in two gradually by an extremely fine glass needle pressed upon it horizontally, the cutting produced no reaction that could be detected either in the piece with, or the piece without a nucleus. Some time elapsed before the non-nucleated piece behaved differently from the nucleated.

Chemical Stimuli

It was found impossible to confine fluids poured out of capillary tubes to very small areas, so I resorted to the following indirect method: A fine copper wire was ground to a needle point and further sharpened by erodin in acid. This copper needle was stuck into the ectosarc of the *Amœba*. The mechanical effects should be no greater than those of the glass needle (i.e., unnoticeable) but the metallic copper, and colloidal particles flying off from it should chemically affect the adjacent protoplasm. Marked local changes occurred, and if the needle remained in the protoplasm long enough the adjacent area was killed. It appeared to me from a number of observations that this stimulus produced responses very quickly in remote parts of the *Amœba*. This was very difficult to test for the following reasons: (1) The *Amœba* may be considered as constantly receiving stimuli from one or more directions. It is probable that some of these stimuli come from within and are very variable. An additional stimulus must be very strong to produce a reaction that can be distinguished from others. (2) The *Amœba* may be considered as a closed bag of ectosarc containing endosarc in the "sol" stage, and a contraction of the ectosarc at one place might produce hydrostatically

an extension at a distant point. Dellinger ('06) supposed that there are strands of denser protoplasm running through the endosarc, and gives as evidence the observation that an elongated ingested diatom will move freely along with granules in the endosarc when it lies lengthwise to the direction of flow, but will stop when turned sidewise, as though the meshes between the strands were greater than the breadth but less than the length of the diatom. The same effect might be produced, however, by the resistance of the ectosarc when indented by the diatom. The diatom with its silicious shell would probably be heavier than the endosarc and press against the "ventral" wall of ectosarc. If it were lighter than the endosarc it would press against the "dorsal" body wall of the *Amœba*. In either case the resistance against being swept along by the current of endosarc would be less when it lay lengthwise than when it lay crosswise to the direction of flow.

To demonstrate this I measured the force required to pull an ordinary glass slide over the surface of a soft gelatine plate under water. It required 2548 dynes when placed crosswise but only 2078 dynes when placed lengthwise. The same would hold for the diatom if it were heavier than or lighter than the endosarc. The current of endosarc would act on a larger surface when the diatom were placed crosswise but whether this would be sufficient to overcome the increased resistance it is impossible to determine without knowing the viscosity of endosarc and ectosarc. But without morphological evidence to the contrary we may safely assume the endosarc to be without a fixed structure.

To eliminate the hydrostatic effect I took advantage of the reaction of the *Amœba* which removes a strongly stimulated area from the source of the stimulus. Ordinarily this is done by local contraction of the ectosarc in the region stimulated. However, if this area is in the middle of a flat side, such a contraction is of no avail and I have observed none. Furthermore, if the opposite point of the *Amœba* is in contact with the substratum, its contraction would not aid in the removal of the stimulated point. By studying *Amœbæ* both from the side after the method of Dellinger and from above, I learned to distinguish from above those

portions that were attached to the substratum. I found from a large number of observations that an *Amœba* stimulated in the center of a large flat area over an attachment to the substratum, by introducing into the ectosarc a copper needle, showed a temporary stoppage of the extension of pseudopodia in the most remote parts. The interval of time was in half the cases less than that calculated for the movement of hydrogen ions in aqueous solution (.03 mm. per second). The reaction time in *Amœba* is considerable (though apparently very variable) and allowing for it, it is probable that in all cases the stimulus traveled at a speed greater than .03 mm. per second. Lest there be an electrostatic action at a distance I "grounded" the copper needle and repeated the experiment many times but with the same results. In order to facilitate observation I selected large *Amœbæ* moving along without dorsal or lateral pseudopodia. These gave the same results.

The Food Taking of the Amœba

From the above results, and observations on food taking I propose the following hypothesis to account for the latter process: Chemical and physical influences of the medium cause a hardening and shrinkage (by loss of water) of the ectosarc (Rhumblers "Geletinisirungsdruck"). Chemical processes within prevent this hardening from extending to the endosarc, and dissolve portions of the ectosarc that are displaced inward. The medium affects different portions of the surface to different degrees, causing regional differences in degree of hardening and shrinking, thus producing amœboid movements. A food body being protoplasmic and therefore similar to the substance of the *Amœba* might, in lying near an *Amœba*, protect it from these outside influences. The protected region would become more fluid, and shrinkage of other regions of the surface would press it out toward the food until it touched it. The food would be pushed along and sometimes rolled over and would rub on the surface of the pseudopod producing mechanical stimuli of sufficient frequency to cause a local shrinkage of the ectosarc. This stimulus would spread through the protoplasm but being very weak and rapidly growing weaker

would cause the contraction of only a small area. Beyond the contracted area the protoplasm would continue moving toward the food and surround it from the sides. Probably many other factors enter into and complicate the process and sometimes make it resemble the food taking of higher animals.

2. THE EFFECTS OF CENTRIFUGAL FORCE ON PARAMÆCIUM³

Methods

For short periods of time the hæmatocrit attachment of a hand centrifuge was used. For longer periods I made an electric centrifuge. I made several centrifuges that could be run by a one-fortieth horse power or a one-twentieth horse power hot air motor. The University of Missouri furnished me with a Bausch and Lomb electric centrifuge with a special revolving arm of 158 mm. radius, carrying two one-half drachm vials. I enclosed this in a close fitting chamber which increased the speed by preventing radial air currents. With shunt winding 4000 revolutions per minute were obtained. The speed was regulated with a circular rheostat having 32 stops. In most cases I used gum arabic (or other gums) dialysed through filter paper until it was neutral to litmus, to buoy up the Paramæcia in the centrifuge, and I repeated these experiments without gum up to as high a speed as the Paramæcia could survive. For a convenient index of the centrifugal force the formula n^2r was used—where n is the number of revolutions per minute and r the radius in millimeters. In earlier experiments the revolutions could not be counted with a speed-counter and had to be calculated from the gear, and the results were probably too high owing to slipping of bands. The word *outward* is used to denote direction from the axis of the centrifuge and *inward* toward the axis. The recorded experiments are on Paramæcium caudatum but Paramæcium aurelia gave similar results.

For permanent preparations I found the best method to be fixation for one minute in 1 per cent chromic acid and staining from three to five minutes in Biondi's methyl green, orange G and acid

³ These experiments were carried on during the session of 1906-1907 at Randolph-Macon College, Ashland, Va., and continued during the winter of 1907-1908 at the University of Missouri.

fuchsin mixture with a little less fuchsin and of about one-fourth saturated strength. To facilitate changing rapidly from one fluid to another the hæmatocrit was used to precipitate the Paramœcia. The chromatin was stained green, plasmosomes orange, cell granules red or orange, trichocysts red and cilia and discharged trichocysts sometimes green. Every part of a whole mount could be studied with the 2 mm. Zeiss apochromatic objective so but few sections were cut.

Experiments

After centrifuging 15 minutes with $n^2r = 13,950 \times 10^6$ the heavier substances of the food vacuoles and phosphate crystals if present lie in the extreme outer end of the Paramœcium and some may even be forced through the ectoplasm. Next to these come the micronucleus and then the macronucleus. Fig. 3 shows a specimen subjected to this force five minutes. The chromatin has been precipitated so violently as to stretch the nuclear wall, but otherwise the macronucleus has not been displaced. It appears as though the macronucleus were attached in some way, but the appearance might be due to the nuclear sap being less dense than the endoplasm or to the viscosity of the endoplasm preventing the rapid precipitation of the whole macronucleus. The anterior end of the Paramœcium was in this case turned outward. Dr. Lyon ('05) showed that this is usually the initial orientation, but the geotropic reaction may be strong enough to turn the anterior end in the opposite direction, as is shown in Fig. 5. Fig. 4 is drawn from a specimen subjected for half an hour to less force ($n^2r = 6200 \times 10^6$). The micronucleus is almost in the extreme outer end of the animal. The precipitation of the chromatin has greatly stretched the wall of the macronucleus and the wall has burst at its inner end. In a lot that were centrifuged longer one Paramœcium was found to be without macronucleus or micronucleus or even scattered chromatin material. I have this specimen stained and mounted and have examined it repeatedly without finding a trace of chromatin. Whether the wall of the macronucleus burst as in the preceding case and the nuclei disintegrated, or whether the nuclei were forced through the wall of the

Paramœcium and lost, or whether the Paramœcium is the result of a division in the centrifuge in which one daughter was prevented from receiving nuclear material by the centrifugal force, it is impossible to say. I have found what appeared to be division stages in specimens just taken from the centrifuge. However, if the centrifugal force had been great the process of division in these specimens was usually not continued, but the elongate and sometimes partially constricted animal would swim about for days without undergoing much change before death. Fig. 5 is of a specimen centrifuged 24 hours, $n^2r = 742 \times 10^6$. The posterior end was turned outward, and both nuclei have crowded into that end. All the Paramœcia subjected to this experiment were very small at its close, probably due to loss of water under the increased pressure.

Judging from many individuals, the time that the macronucleus remained displaced after removal from the centrifuge was about the same as the time it had probably remained displaced in the centrifuge. Many exceptions to this rule, and the fact that some individuals changed their orientation while in the centrifuge, makes an exact statement impossible.

E. P. Lyon ('05) showed that Paramœcia centrifuged for some time are not negatively geotropic. If the geotropic reaction be due to the pressure in one direction of substances in the Paramœcium of specific gravity different from the surrounding protoplasm, (statolith theory) an abnormal displacement of such substances might upset the mechanism of geotropism. I found in confirmation of Lyon's results that Paramœcia recently taken from the centrifuge are not negatively geotropic but apparently swim as often in one direction as in another and gradually reach the bottom by their own weight. Great care must be used in this experiment to rid the Paramœcia of gum if they have been put in it, as Ostwald ('06) has shown that altered viscosity of the medium may change the sign of the reaction. Jensen ('93) has shown that Paramœcia are positively geotropic on hot days, and the friction of the air may raise the temperature of fluids in the centrifuge. The effects of a rise of temperature and increase in viscosity due to a little gum in the medium would tend to neutralize

one another. It has been shown above that the pressure in the centrifuge reduces the size and probably increases the density of the Paramœcia. This might cause them to go to the bottom even though they preserved a negatively geotropic orientation. I found the time elapsing before the return of the negatively geotropic reaction to roughly correspond to the time required for the return of the nuclei to their normal position. This might indicate that the nuclei in normal position acted as statoliths. The fact that the Paramœcia are constantly revolving on their long axes does not prevent the application of the statolith theory, because Paramœcia moving horizontally do not react to gravity (Jennings '04); it is only when they start to swim downward that they react.

I kept Paramœcia in the centrifuge for various periods of time up to one week to test whether distance from the nucleus would effect the structure of the ectoplasm, and obtained only negative results. Probably the circulation of the endoplasm is sufficient to equalize the distribution of substances diffusing out of the nucleus. In case gum solution was used control experiments of Paramœcia in gum but not centrifuged were made. The gum was eaten and gave the Paramœcia a slightly swollen, vacuolated appearance. Some of the experiments are tabulated below:

n ^o r	TIME	RESULT
164 × 10	7 hrs.	Many nuclei displaced, they had returned in a few hours.
384 × 10	15 min.	Many nuclei displaced, they had returned in 15 minutes.
585 × 10	1 day	Many nuclei displaced, they had returned in 1 day.
585 × 10	1½ days	Many nuclei displaced, they had returned in 30 hours.
585 × 10	3½ days	Many nuclei displaced, they had returned in 2½ days.
585 × 10	4 days	Similar results, the displacement was in some cases transmitted to products of fission.
585 × 10	5 days	Similar results.
585 × 10	6 days	Similar results.
764 × 10	6 days	Similar results, many misshapen.*
1318 × 10	1 day	Similar results, many misshapen.*
1316 × 10	1 day	Similar results, some dumb-bell shaped.

In those marked with * no gum was used.

A marked effect on the rate of division was noticed in individuals taken from the centrifuge. It has been shown by Calkins

In the above experiment there were in 20 days, 30 divisions in the three series from the centrifuge and only 10 in the control. During the five days in which the control lived, there were 16 divisions in the centrifuged series.

Many experiments with *Paramœcia* centrifuged from one hour to six days, both with and without gum, gave similar results, only the effect was not so marked in the longer periods. All the above lots were from the same culture.

It was stated above that many *Paramœcia* are misshapen in the centrifuge. The end into which the nuclei are precipitated is bulged out by them, and in a few cases the other end is also bulged out (by the accumulation of substances of low specific gravity?) giving the animal the form of a dumb-bell. I fed *Paramœcia* on egg yolk, and globules of a dark brown fatty substance were formed in the endoplasm in such numbers as to make it appear black. These black *Paramœcia* were subjected to as great a centrifugal force as they could stand, in some cases for two or three days. The fatty substance being of low specific gravity, accumulated in the end opposite the one into which the nuclei were precipitated. The result was a pear shaped body, the large end being black and the small end of the normal *Paramœcium* color. So great was the difference in the specific gravity of the two ends that the animal could only with difficulty assume a horizontal position or turn the small end uppermost. No marked increase in rate of growth or reproduction that could be ascribed to the stimulating effect of the lecithin in the yolk was observed.

It was noted above that some of the *Paramœcia* when taken from the centrifuge appeared to be undergoing division. More often the body was abnormally elongated, with or without a constriction in the middle. In these cases the end not containing the nuclei shriveled after a day or so, and the animal died within a week. It may be that the centrifugal force keeping the nucleus in one end prevents its division though the animal is large enough to form two, and the portion around the nucleus attempts to form itself into an individual, thus causing the constriction in the middle. If such a division is actually completed I have never observed it.

When *Paramœcia* are centrifuged without gum in the medium,

the bacteria upon which they feed are all precipitated to the outer end of the receptacle. Although the centrifugal force may be such that the Paramœcia can swim against it, the lack of bacteria elsewhere may cause them to remain in the outer end of the receptacle in the area made acid by the bacteria. Here some of them are pressed out of shape and may be reduced to thin lamellæ. I have seen such forms after being taken from the centrifuge swim about for days in this flattened condition, and sometimes finally regain their normal proportion. More often the Paramœcium turns a number of times while being pressed in the outer end of the receptacle and is reduced to an irregular mass. Such masses may grow to large size and develop several buccal grooves. They may also divide and some of the products of division be irregular, while others form normal Paramœcia. A curious case is shown in Fig. 6, though as this specimen was fed on egg its abnormality is probably as much due to the bulging out of one end by the fatty substance as to the pressure of the wall of the receptacle. Its condition when removed from the centrifuge is shown at *a*. The large end is three-lobed and it appears as though it were about to divide itself longitudinally into three individuals. The next day there are four lobes on the large end and two on the small end (*b*). On the third day two of the constrictions have disappeared and the animal is almost divided longitudinally into two. In this condition it died.

One of the irregular individuals taken from the centrifuge and isolated in small watch crystals, divided into two daughters that appeared normal in every respect save that each bore a long horn on the oral side. Dr. H. S. Jennings found a Paramœcium similar to one of these, in an old culture, and found that for a number of generations (i.e., as long as the series lived) the horn was passed to one of the products of each division and the other was normal. I thought it would be interesting to compare the transmission of these horns produced mechanically, with his observations. The diagram in Fig. 7 presents the results: The irregular individual taken from the centrifuge is represented by *a*; it divided to form the first two daughters, each with a horn. Some daughters are represented by small sketches, the others by the letters *n* meaning

normal and *h*, bearing a horn. One of the first two daughters has the horn nearer the anterior end the other nearer the posterior end. After each division the horn is in a different position, and we can predict the position of the horn in each generation by drawing an imaginary line bisecting the animal in the preceding generation transversely. Many of the "normal" daughters were kept many generations without showing any abnormality in their offspring. Although one series died out in the sixth and the other in the eighth generation there is no reason to believe that the horns would have been lost had the series lived. Sometimes the horn grew and at other times decreased in size but in the later generations it was as large as in the earlier. It is easy to see why such deformities are seldom found in nature, for in case one is produced, even if the deformed individual has an equal chance with normal ones of living and reproducing, after seven generations less than one per cent of its offspring will show the abnormality. The main difference between the results of the reproductive process here and in the Metazoa is the transmission of acquired characters to a small per cent of the progeny in case such characters do not cause the death of their possessors. To speak of a germ plasm in *Paramœcium* without morphological evidence might seem unwarranted.

3. ON ABNORMALITIES PRODUCED BY ENCYSTMENT AND OTHER CAUSES IN *PARAMœCIUM AURELIA*.⁴

The encystment of *Parameœcium putridum* was described by Lindner ('99) that of *P. busaria* by Prowazek ('99) and that of *P. caudatum* by Simpson ('01). I have repeatedly observed *Paramœcium aurelia* forming a thin membranous cyst in which it might be confined for a week but in which it was killed by drying. For this reason it might be wrong to compare these cysts with those observed by others in *Paramœcium*. "These cysts are most often seen in the interior or on the surface of bacterial zoöglea and I thought at first that the *Paramœcia* were simply entangled in the zoöglea, but as other *Paramœcia* were seen at the same

⁴ These observations were made at the University of Missouri.

time making their way with ease through the same zoöglea at least part of the wall of the cyst must be secreted by the Paramœcium. During the formation of the cyst the animal continually rotates inside of it and the ciliary coat is never lost. The cyst gradually contracts until it is shorter than the occupant, which may have the anterior end folded over the middle of the body or the ectoplasm thrown into folds. After the animal has been in the cyst for some time the folding of the ectoplasm may assume the character of an invagination of the anterior (rarely posterior) end. The invaginated ectoplasm seems to be in large measure absorbed, for after several days the occupant of such a cyst looks like merely the posterior end of a Paramœcium. If the cyst is opened or if one waits until the occupant comes out of its own accord, the latter will swim about and ingest its food as though an anterior end were superfluous. I found numbers of Paramœcia without anterior ends, and a few without posterior ends, in the old culture in which the encystment was found. One of these is represented in Fig. 8, *a*. It was isolated in a watch crystal and remained in the form of the figure two days. On the third day it had changed to the form shown in Fig. 8, *b*. This might be interpreted as a division in which the reduced vitality of the animal prevented the complete separation of the daughters, followed by a partial division of one of the daughters. The specimen was lost so that its later history could not be followed.

Some abnormalities seem to be the result of the plasticity of the adoral side at the time of conjugation. A pair of conjugants were isolated, and when they separated the adoral regions were drawn out into prominences (Fig. 9). Such prominences are gradually absorbed although they may remain for several days. These prominences do not seem to be of the same nature as the horns shown in Fig. 7 since so far as the investigations go the horns do not and these smaller prominences do disappear. If Paramœcia are shaken up with broken glass all those that are not killed or cut in two regain their normal form in a short time (and even fragments if they live regenerate after a longer period) although they may be so torn and mashed out of shape as to bear little resemblance to the type. Probably the form of a Paramœcium

cannot be permanently changed without the formation in it of one or more new chemical substances. In other words we might hypothetically consider the horn alluded to as of the nature of a graft differing chemically from the *Paramœcium* to which it was attached.

4. ON VARIATIONS IN *PARAMŒCIUM CAUDATUM* AND *P. AURELIA*⁵

In making the foregoing studies I was interested in inquiring into the identity of the species used. In the experiments at Ashland, Va., only one form was used. It had but one micronucleus and agreed in other respects with descriptions of *Paramœcium caudatum*. At the University of Missouri two forms were found, one similar to that studied in Virginia and another having two micronuclei, and in this respect agreeing with descriptions of *Paramœcium aurelia*. Calkins ('06) found a case of *P. caudatum* acquiring two micronuclei and some of its offspring losing one micronucleus and becoming normal *P. caudatum* again. He further states that the number of micronuclei is the only invariable character for separating *caudatum* from *aurelia* and therefore they are probably the same species. Whether *caudatum* and *aurelia* form two *species* or not cannot be decided from the data at hand but I have evidence to show that these two *forms* are quite distinct. In none of the numerous cultures which I have kept for months and in one case a year, have I found individuals with different numbers of micronuclei in the same culture. No characters of outward form were found that would serve to separate *caudatum* and *aurelia*. The size character is best studied in graphs of the lengths of a large number of individuals of each culture (Fig. 10). In each curve in Fig. 10 the lengths of the individuals measured in fractions of a millimeter are plotted as abscissas and the number of individuals in a class represented by arbitrary units on the ordinates and marked at the top by a cross. The curve itself is merely to aid the eye in comparing measurements from one culture with those from another, as are also the

⁵ These observations were made at the University of Missouri.

continuations of the .1, .2, and .3 mm. ordinates. The height of one curve is not to be compared with that of another as it depends on the number of individuals measured and the number of classes, but the spread and limits of the curves are to be compared. The specimens were measured after killing in one per cent chromic acid, a mechanical stage was used to prevent any unconscious selection and the measurements for some curves were made with an ocular micrometer, and for other curves with a camera lucida. Fig. 10, *a* represents the lengths of 218 individuals from a culture of *P. caudatum* from Hinkson Creek, Columbia, Mo., kept in the laboratory one month. Individuals .2 mm. in length form the class of greatest frequency. The next curve (*b*) is of 234 individuals from a pond near by. The class of greatest frequency is .19 mm. The third curve (*c*) is of 219 individuals from Ashland, Va. They had enough food for health but not enough for reproduction. The class of greatest frequency is .182 mm. After feeding this culture 24 hours on hay infusion, 184 individuals were measured (*d*), and the class of greatest frequency calculated at .191 mm., showing that the majority had increased in length. It will be noticed that the curve extends farther to the left. This is due to the fact that many individuals had recently divided and were shorter than before feeding. These and all other cultures of *P. caudatum* gave a nearly symmetrical curve. Such was not the case with *P. aurelia* (shown in the last two curves). The curve *e* is plotted from the lengths of 297 individuals from an old culture found at the University of Missouri. The class of greatest frequency is .133 mm. Hence most of them are shorter than the majority of *P. caudatum*, but it will be seen that the second mode of the curve is composed of individuals longer than the majority of *P. caudatum*. At first I thought some individuals of *caudatum* had gotten into the culture, but an examination of the micronuclei of a large number of individuals both large and small proved that not to be the case. The next curve (*d*) is of 127 individuals from a culture from a drain ditch at Columbia, Mo. It shows two modes similar in position to those in the preceding, but the highest is of the largest individuals (.26 mm. in length). From these two cultures of *P. aurelia* I isolated individuals of different lengths

and started separate cultures from them, which were kept for months. In every case the progeny of one individual showed a curve of as little spread as those given of *P. caudatum*. Thus it was possible to obtain a culture of minute individuals or one of giants or one of medium size. Subjecting a culture to higher temperature or increased salinity decreased the size of the individuals while lower temperatures increased the size of the individuals. *P. aurelia* of this region must then be dimorphic or else it happened that in starting both the above cultures (*e* and *f*) only large and small and no medium sized individuals were procured. Large samples of water containing decaying leaves, etc., from various places developed no cultures of *Paramœcia*, so that more data for *aurelia* was not obtained. We may say then that *aurelia* differs from *caudatum* in the presence of two micronuclei and that some *aurelia* are smaller than the smallest *caudatum*.

It has frequently been noted that conjugating individuals are smaller than non-conjugants. I think that the fact that the mouths of conjugants are closed is sufficient to cause the smaller size. By comparing curve *c* (of individuals fed less) with curve *d* (of individuals fed more) you may note that those fed less are smaller. However, no matter how little food is given *Paramœcia* they can still take in water through the mouth and be swelled up with vacuoles, which is not the case with conjugants. Note that the variation of the well fed individuals is greater than that of the poorly fed. Dr. Pearl ('07) found the same to be true of non-conjugants as contrasted with conjugants.

In conclusion, a note on the effect of a certain food may be of interest. It is well known that hay infusion has to be often renewed to keep a culture of *Paramœcia* in good condition. If the culture is left in the same infusion the individuals become smaller, sluggish and finally die. However, if a considerable amount of cane sugar be added to the culture, the *Paramœcia* are very little affected at first but after several weeks become more active and live for months. Whether this be due to alcohol that appears or to bacteria produced in the culture was not determined.

APPENDIX

Dr. Jennings's paper entitled "Heredity, Variation and Evolution in Protozoa. I" (this journal, vol. v) appeared after this paper had been sent to press. I would emphasize a probable difference between the process of heredity in Protozoa and in Metazoa other than the difference in complexity. In Protozoa the "germ-plasm," whether it be all or part of the individual, is probably equally as accessible to the environment as the "soma." I use the words "germ plasm" and "soma" for brevity.

BIBLIOGRAPHY

Of Part 1

- BERNSTEIN '00—Chemotropische Bewegung &c. Arch. f. d. ges. Physiol. 80 Bd.
 DELLINGER, O. P. '06—Locomotion of Amœba and Allied Forms. Jour. Exper. Zool., vol. iii.
 JENNINGS, H. S. '04—Contributions to the Study of Lower Organisms. 6. The Movements and Reactions of Amœba. Publication No. 16. Carnegie Inst.
 MCCLENDON, J. F. '07—Experiments on the Eggs of Chætopterus, etc. Bio. Bull., vol. xii.
 MATHEWS, A. P. '07—An Apparent Pharmacological Action-at-a-distance by Metals and Metaloids. Amer. Jour. Physiol., vol. xviii.
 MAXWELL, S. S. '07—Is the Conduction of the Nerve Impulse a Chemical or a Physical Process? Jour. of Bio-chemistry, vol. iii.
 MONTGOMERY, E. '81—Zur Lehre von Muskelcontraction. Arch. f. d. ges. Physiol., 25 Bd.
 RHUMBLER, L. '98—Physikalische Analyse von Lebenserscheinungen der Zelle. I. Arch. f. Entwicklungsmech. d. Organismen, vol. vii.
 '05—Zur Theorie der Oberflächenkräfte der Amöben. Zeit. wiss. Zool., 83 Bd.
 SUTHERLAND, W. '06—A Molecular Theory of the Electric Properties of Nerve. Amer. Jour. Physiol., vol. xvii.

Of Part 2

- CALKINS, G. N. AND LIEB, C. '02—Studies on the Life History of Protozoa, II. Arch. f. Protistenk., 1 Bd.

- CALKINS, G. N. '04—Studies on the Life History of Protozoa. IV. Jour. Exper. Zool., vol. i.
- CZAPEK '02—Stoffwechselprozesse in der geotropisch gereizten Wurzelspitze, etc. Ber. deutsch. bot. Gesell., 20 Bd.
- DARWIN, F. '03—On Artificial Production of Rhythm in Plants. Ann. of Bot., 1903.
- HATAI '03—Lecithin a Stimulant to Growth. Amer. Jour. Physiol., vol. x.
- JENSEN, P. '03—Ueber den Geotropismus niederer Organismen. Arch. f. d. ges. Physiol., 53 Bd.
- JENNINGS, '04—The Behavior of Paramœcium. Jour. Comp. Neur. and Psy., vol. xiv.
- KHAWKINE, M. W. '88—Le Principe de l'Hérédité et les Lois de la Mécanique en Application à la Morphologie de Cellules Solitaires. Arch. Zoo. Expér. et Gén. (2) Tome 6.
- LYON, E. P. '05—On the Theory of Geotropism in Paramœcium. Am. Jour. Physiol., vol. xiv.
- '07—Results of Centrifugalizing Eggs, I and II. Arch. f. Entwicklungsmech. d. Org. 23 Bd.
- MAUPAS, E., '88—Recherches Expérimentales sur la Multiplication des Infusiers Ciliés. Arch. Zoo. Exp. et Gen. (2) Tome 6.
- MITROPHANOW, P., '03—Nouvelles Recherches sur l'Appareil Nucleaire des Paramécies. Arch. Zoo. Exp. et Gen. (4), Tome i.
- MORGAN, T. H., '06—Influence of a Strong Centrifugal Force on the Frog's Egg. Arch. f. Entwicklungsmech. d. Org., 22 Bd.
- MOTTIER, D. M. '00—The Effect of Centrifugal Force on the Cell. Ann. Bot., vol. xiii.
- OSTWALD, WOLFGANG, '03—Zur Theorie der Richtungsbewegungen schwimmender niederer Organismen I. Archiv. f. d. ges. Physiologie, 95 Bd.
- '06—II. Archiv. f. d. ges. Physiologie, III Bd.
- WILDIERS, E. '00—Inutilité de la Lécithine comme Excitant de la Croissance, etc. La Cellule, T. xvii.

Of Part 3

- LINDNER, G. '99—Die Protozoenkeime in Regenwasser. Biol. Cent'bl., xix Bd.
- PROWAZEK, S. '99—Kleine Protozoenbeobachtungen. Zool. Anz., xxii.
- SIMPSON, J. Y. '01—Studies in Protozoa. I. Pro. Scott. Micro. Soc. iii.

Of Part 4

GERASSIMOW '04—Physiology of the Cell.

HERTWIG, R. '03—Wechselverhältniss von Kern und Protoplasma. München.
(Lehmann).

PEARL, R. '07—Biometrical Study of Conjugation in Paramœcium. Biometrika., vol. v.

PLATE I

Fig. 1 "Mechanical hand" for moving a fine pointed instrument in stimulating *Amœbæ*. When in use it is clamped to the stage of a Zeiss binocular microscope (Greenough model) so that the whole apparatus except the point of the instrument lies to one side of the field of the microscope. When necessary two can be clamped to the same microscope. A crude form of this apparatus, figured and described in an earlier paper (McClendon, '07), had the disadvantage of surrounding the field of the microscope on three sides and sometimes colliding with the watchglass or slide on which the objects were placed. By turning the milled head on the left an instrument held in the clamp is moved crosswise, by turning the milled head in the center the instrument is moved back and forth, and by turning the one on the right it is moved vertically, all three are held in the hand and turned by different fingers.

Fig. 2 A simpler form of the same apparatus. The milled head moving the instrument vertically is high above the other two.

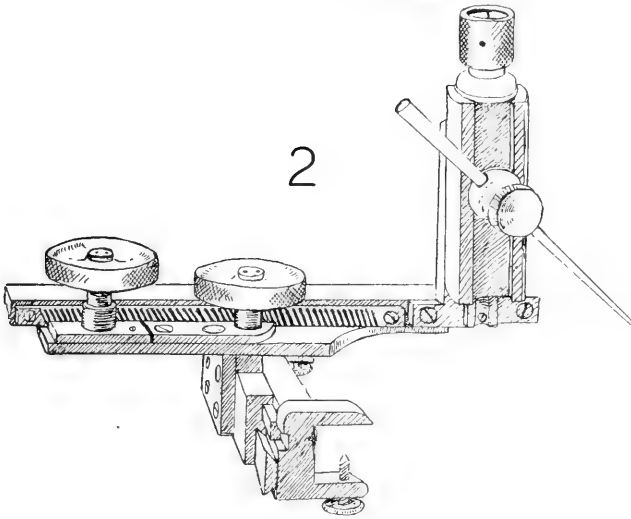
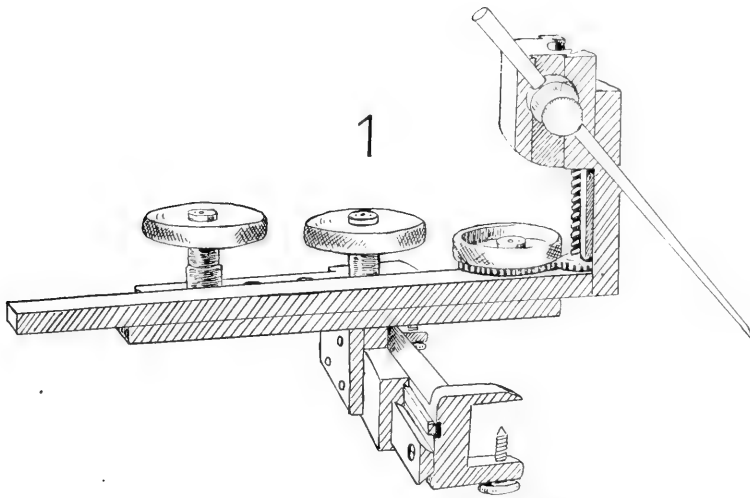

PLATE II

Fig. 3 *Paramecium caudatum*, (optical section) centrifuged 5 minutes; $n^2r = 13,950 \times 10^6$.

Fig. 4 *Ibid.*, centrifuged $\frac{1}{2}$ hour; $n^2r = 6,200 \times 10^6$.

Fig. 5 *Ibid.*, same scale, centrifuged 24 hours; $n^2r = 742 \times 10^6$.

Fig. 6 *a*, *P. caudatum* fed on hens' egg yolk and centrifuged two days, $n^2r = 764 \times 10^6$. *b*, the same one day later. *c*, the same one day later.

Fig. 7 Genealogical table of descendants of *a*, a *P. caudatum* mutilated in the centrifuge (6 days, $n^2r = 764 \times 10^6$). *h* = horned and *n* = normal individual.

Fig. 8 *a* = *P. caudatum* from old culture. *b* = the same two days later.

Fig. 9 A pair of ex-conjugants showing deformities produced by conjugation.

Fig. 10 Series of curves showing variation in length in *P. caudatum* and *P. aurelia*. *a*, *P. caudatum* (218 individuals) from Hinkson Creek, Columbia, Mo. *b*, *P. caudatum* (234 individuals) from a pond at Columbia, Mo. *c*, *P. caudatum* (219 individuals) from Ashland, Va., on maintenance. *d*, *P. caudatum* (184 individuals) from Ashland, Va., well fed 24 hours. *e*, *P. aurelia* (297 individuals) from old culture at the University of Missouri. *f*, *P. aurelia* (127 individuals) from a drain ditch at Columbia, Mo.

J. F. McCLENDON

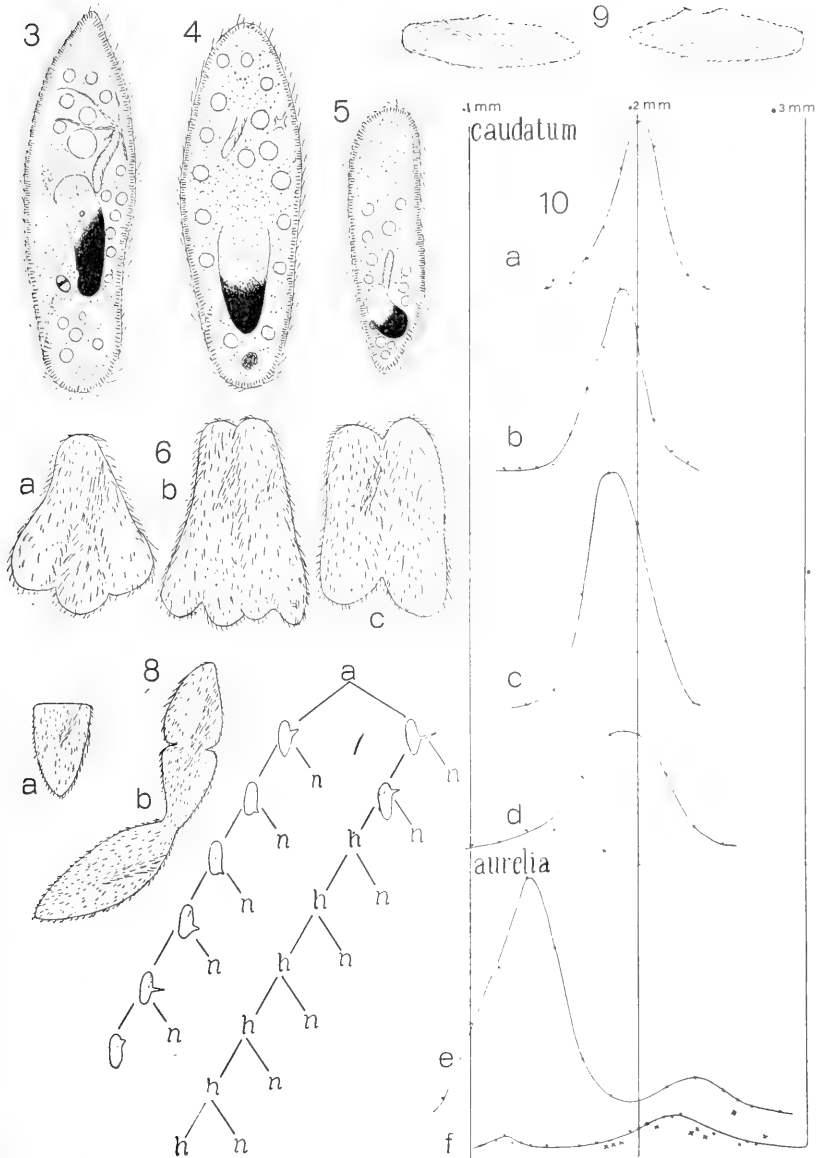



THE DEVELOPMENT OF ARTIFICIALLY PRODUCED CYCLOPEAN FISH—"THE MAGNESIUM EMBRYO"

BY

CHARLES R. STOCKARD

WITH ONE PLATE AND SIXTY-THREE TEXT FIGURES

Introduction	285
Material and method.....	287
Cyclocephali and Monstra Monophthalmica Asymmetrica.....	292
<i>a</i> Living cyclopean monsters from the first indication of the defect to the time of hatching.....	294
<i>b</i> Free swimming cyclopean fish.....	298
<i>c</i> Living Monstra Monophthalmica Asymmetrica	304
Morphology of Cyclocephalia.....	305
<i>a</i> Earliest indication, exact position and condition of the eye.....	305
<i>b</i> Incomplete cyclopia; double eyes.....	310
<i>c</i> Perfect single cyclopean eye and normal brain.....	311
<i>d</i> Extreme cyclopia; from the abnormally small anterior cyclopean eye to entire absence of eyes.....	315
Incomplete diprosopus, with three eyes and one additional lens.....	322
Morphology of Monstra Monophthalmica Asymmetrica	325
Independent origin and self-differentiation of the crystalline lens.....	328
Discussion and conclusions.....	330
Summary.....	334
Literature cited	336

INTRODUCTION

Development is the resultant of the interaction between the inherent tendencies contained within the egg substance itself and the external conditions which surround and act upon this substance. The usual interaction of these factors gives rise to normal animal forms. When, however, either factor is changed an unusual form results; in the one case there arises a germinal variant, and in the other an anomaly occurs as a response to the strange external environment. The product of development, the formed animal, is then to a certain extent a creature of its environment. On the other hand the importance of the internal factors must be recognized although modern experimental work often-

times points in a direction which would indicate that these factors may be largely modified in their influences by the external conditions.

Most monstrosities or abnormalities in development are due to the action of external factors, either mechanical, as pressure, or chemical. Mammals, birds and reptiles, with their complex embryonic membranes, offer many opportunities for the production of secondary abnormalities arising from unfavorable mechanical or physical conditions. Fœtal amputations and scars, membrane fusions distorting facial development, and many other such deformities are in most cases probably due to secondary influences on development. Besides these there are deformities of a different nature, such as the excessive monsters, *monstra in excessu*, in which certain organs have over developed or produced super-numerary parts; and contrasted with them are defective monsters which fail to complete themselves and are therefore less than a normal individual. It is with this latter class, *monstra in defectu*, that the present study is concerned. These defective individuals may be grouped into two sub-classes: first those in which certain organs fail to complete themselves, as in cleft palate, hare-lip, arrests in the development of the heart and other parts of the circulatory system. Second, individuals in which certain paired organs occur singly or without mates. True Cyclocephali or cyclops monsters find their place in this last group.

Cyclops monsters have long been known to occur in man and other mammals and are described in many of the earliest medical works. In these beings the one eye is in the middle line of the face and often shows external evidence of a double composition. The nose which normally arises above the eyes and grows down between them as the face develops is here mechanically prevented from descending by the presence of the median eye in its path. The fœtus, therefore, has a proboscis-like nose above the eye. The brain and other parts of the body are sometimes deformed though they may be normal.

Among the lower vertebrates true cyclops monsters have been recorded by Spemann ('04) as resulting from mechanical injuries to the eggs of the amphibian, *Triton tæniatus*. These mon-

sters were double-headed with one or both heads showing the cyclopean defect and were not of the usual single cyclopean type found in man and other mammals.

Two years ago (1907) I carried out experiments in which I was able to produce typical single cyclopean fish. This was the first record of the occurrence of cyclopia among fishes. It is also the first case of consistently producing vertebrate monsters such as are known in nature by changing the chemical environment in which the eggs develop. These embryos are in main details similar to the mammalian cyclops, having a single median eye and anteriorly placed double nasal pits.

The monsters were produced by allowing the eggs to develop in sea-water in which there was an excess of $MgCl_2$. Cyclopia occurred in a large percentage (at times 50 per cent) of the embryos. The discovery was made so late in the spawning season that it was impossible to investigate the details of the cyclopean defect or rear the embryos to hatching in order to observe their ability to swim or to see. The method of production, however, offered such an exceptional opportunity to obtain abundant material for studying all stages of development and degrees of cyclopia that this more extended survey was undertaken.

The following account includes a comparative study of cyclopean embryos from the earliest appearance of the optic vesicle to the perfectly formed free-swimming fish with a functional cyclopean eye.

The experiments were conducted in the Marine Biological Laboratory at Woods Holl, Mass., during the past summer, while occupying one of the rooms of the Wistar Institute.

MATERIAL AND METHOD.

As in my previous experiments, the eggs used were those of the teleost fish, *Fundulus heteroclitus*.

The method of producing the defect was much the same as that previously employed although expanded and modified in many ways. During the early part of the season it was difficult to find

solutions of the proper strengths and the eggs were either killed or unaffected. After a few experiments, however, a strength of MgCl_2 in sea-water was found that gave a large percentage of cyclopia, in many cases again causing 50 per cent of the eggs to form such individuals. This was a $\frac{1.9}{6.0}$ M solution prepared as follows: 19 cc. of a molecular solution of MgCl_2 in distilled water was added to 41 cc. of sea-water. This is not then an actual $\frac{1.9}{6.0}$ M MgCl_2 solution but it is $\frac{1.9}{6.0}$ parts molecular MgCl_2 . Making the solution in this way adds to the sea-water, water lacking all of its constituents except the Mg and thus increases in a greater proportion the excess of Mg present.

Cyclopia occurred in a series of similarly prepared solutions ranging as follows: $\frac{1.6}{6.0}$ M, $\frac{1.7}{6.0}$ M, $\frac{1.8}{6.0}$ M, $\frac{1.9}{6.0}$ M, $\frac{2.0}{6.0}$ M, $\frac{2.1}{6.0}$ M and $\frac{2.2}{6.0}$ M MgCl_2 . A point of importance is that the proportion of cyclops embryos produced gradually rises in this series up to the $\frac{1.9}{6.0}$ M solution and then falls off again. To illustrate concretely, in Experiment VII the $\frac{1.6}{6.0}$ M solution caused 12 per cent of the eggs to form cyclopean embryos, the $\frac{1.7}{6.0}$ M gave 30 per cent, the $\frac{1.8}{6.0}$ M 22 per cent, while $\frac{1.9}{6.0}$ M gave 50 per cent with the cyclopean defect. Continuing the series, the $\frac{2.0}{6.0}$ M falls off to 30 per cent and the $\frac{2.1}{6.0}$ M gives 23 per cent, while in the $\frac{2.2}{6.0}$ M no cyclopia occurred and the eggs were all killed. It must be born in mind that these percentages are for the eggs that formed embryos and not for the total number of eggs first put into the solution. The peculiar fact is, that in a series of MgCl_2 solutions we reach a place where a maximum number of cyclopean embryos occur and in strengths both weaker and stronger than this the number of cyclopean individuals is less. If the defect is due to osmotic pressure, we should not expect a greater pressure to bring about a more normal development. If the action is chemical, we do not usually reach a chemically effective dose and find that a greater dose is less effective. It might be argued that below the point of maximum occurrence of the cyclopean defect, the solutions are insufficient to effect any but the weaker embryos, so that a small number of cyclops appear; above this point the solutions are so strong that all except the hardiest embryos die in early stages and those surviving are so resistant that only a few give the cyclopean defect.

At the maximum point the normal or ordinary individuals, which predominate, would be affected, and here the greatest number of cyclopean embryos occur.

As I previously mentioned, the $MgCl_2$ is found to be rather toxic to these eggs during the earlier stages of development. Many die at this time, but in the medium strength solutions 70 to 80 per cent live and form embryos and in the weaker solutions often more than 90 per cent live. After the early embryo is formed, however, the high death rate falls and a dead embryo is of rare occurrence in any of the solutions. Many embryos were kept in the solutions thirty days and some hatched in strengths as strong as $\frac{1.8}{6.0}$ M. If, on the other hand, the eggs are removed from the solutions when sixty or seventy hours old, when the cyclopean condition is readily distinguishable, and placed in sea-water they grow much better and many hatch normally. Some of the cyclopean fish came out on the twelfth day after fertilization, though usually they were much slower in emerging. The control embryos hatch in from eleven to twenty days, depending chiefly upon the temperature.

Solutions of $MgCl_2$ in Distilled Water

Distilled water solutions of $MgCl_2$ of several strengths; $\frac{1.0}{6.0}$ M, $\frac{1.1}{6.0}$ M, $\frac{1.2}{6.0}$ M, $\frac{1.3}{6.0}$ M, $\frac{1.4}{6.0}$ M and $\frac{1.5}{6.0}$ M were not effective. The eggs either died during early stages or developed into embryos with two normal eyes. I had found (1906) that salts of lithium induce the same typical defects in *Fundulus* eggs in both sea-water and distilled water solutions. Such solutions have opposite conditions of pressure, being in one case hypertonic and in the other hypotonic and thus remove all question of osmotic effects as a cause. It was hoped that Mg might also act in the two solutions which would have made it certain that the direct action of the magnesium ion is responsible for the cyclopean condition of these embryos. The problem of cyclopean formation seems, however, to be more complex. It involves the action of magnesium in the presence of certain or all of the sea-water salts.

Solutions of $MgSO_4$ and $Mg(NO_3)_2$ in Sea-water

Sea-water solutions of $MgSO_4$ prepared in a similar manner to the $MgCl_2$ solutions above were employed. The following strengths $\frac{1}{8}$ M, $\frac{1.0}{6.0}$ M, $\frac{1.2}{6.0}$ M, $\frac{1.5}{6.0}$ M, $\frac{1.8}{6.0}$ M, $\frac{1.9}{6.0}$ M, $\frac{2.0}{6.0}$ M, $\frac{2.2}{6.0}$ M, $\frac{2.3}{6.0}$ M, $\frac{2.4}{6.0}$ M, $\frac{2.5}{6.0}$ M, and $\frac{2.7}{6.0}$ M were ineffective, the eggs in these solutions developing normally with very few deaths at any stage.

$Mg(NO_3)_2$ solutions in sea-water caused typical cyclopia indistinguishable in all respects from that produced in $MgCl_2$. The following strengths were used: $\frac{1.3}{6.0}$ M, $\frac{1.4}{6.0}$ M, $\frac{1.5}{6.0}$ M, $\frac{1.6}{6.0}$ M, $\frac{1.7}{6.0}$ M, $\frac{1.8}{6.0}$ M, $\frac{1.9}{6.0}$ M, and $\frac{2.0}{6.0}$ M. These $Mg(NO_3)_2$ solutions also killed many embryos during the early stages of development. Cyclopia occurred in from 4 per cent to 40 per cent of the eggs in $\frac{2.0}{6.0}$ M, $\frac{1.9}{6.0}$ M, $\frac{1.8}{6.0}$ M, $\frac{1.6}{6.0}$ M, and $\frac{1.3}{6.0}$ M. These strengths are comparable to those most effective for $MgCl_2$, both as to the amount of magnesium present and as to osmotic pressure.

Mixtures of $MgCl_2 + NaCl$; $MgSO_4 + NaCl$; and $Mg(NO_3)_2 + NaCl$

Mixtures of $MgCl_2$ and $NaCl$ were added to sea-water as follows: 12 cc. of a molecular solution of $MgCl_2$ was added to 12 cc. of $NaCl$, and 36 cc. of sea-water was then taken to make the entire quantity up to 60 cc. This solution will be spoken of as $\frac{1}{3}$ M + $\frac{1}{3}$ M, the first term referring to the $MgCl_2$ present and the second to the $NaCl$. On this basis the following mixtures were used: $\frac{1}{5}$ M + $\frac{1}{5}$ M, $\frac{1}{4}$ M + $\frac{1}{5}$ M, $\frac{2}{10}$ M + $\frac{1}{5}$ M, $\frac{7}{30}$ M + $\frac{1}{5}$ M, in which the $MgCl_2$ was varied and the $NaCl$ kept constant, and $\frac{1}{4}$ M + $\frac{1}{6}$ M, $\frac{1}{4}$ M + $\frac{1}{4}$ M, $\frac{6}{20}$ M + $\frac{1}{4}$ M, $\frac{1}{4}$ M + $\frac{1}{3}$ M, in which the amount of $NaCl$ was varied also.

Such mixtures caused the development of cyclopia, the best results were obtained in $\frac{1}{4}$ M + $\frac{1}{5}$ M, where as times as many as 25 per cent occurred. The $\frac{1}{15}$ M + $\frac{1}{5}$ M gave in one case 30 per cent of cyclopia. The $\frac{7}{30}$ M + $\frac{1}{5}$ M gave 11 per cent. It will be seen that the amount of $MgCl_2$ present in these mixtures is less than that necessary to cause similar results when used alone. This is a peculiar fact and one for which I know of no explanation. Similar results (Stockard '07b) were found with mixtures

of salts in distilled water where the final pressure was less than that of sea-water, the normal medium of the eggs. It is also true that if such substances as the sugars be added to a salt solution, a smaller dose of the salt becomes effective in the presence of the sugar. Morgan ('06) first called attention to this peculiar fact in studying the effects of solutions upon developing frogs' eggs. This would seem to indicate that the effects were due to osmotic pressure conditions and by slightly raising the pressure with another element the effective agent was assisted in its action, but my lithium experiments (1906 and 1907b) are against such a view.

A number of mixtures of $MgSO_4$ and $NaCl$ were tried, all giving negative results. Mixtures of $Mg(NO_3)_2$ and $NaCl$ as follows were used: $\frac{1}{4} M + \frac{1}{6} M$, $\frac{1}{15} M + \frac{1}{5} M$ and $\frac{7}{30} M + \frac{1}{5} M$. The first two caused eggs to develop cyclopia. These are mixtures closely similar to the effective $MgCl_2$ and $NaCl$ solutions.

We conclude that cyclopean monsters are produced in *Fundulus* eggs by the action of sea-water solutions of $MgCl_2$, $Mg(NO_3)_2$ and mixtures of $MgCl_2$ and $NaCl$ and $Mg(NO_3)_2$ and $NaCl$. No other solutions of the many I have tried during three summers gave similar effects. Other salt solutions and sugar solutions exerting practically the same osmotic pressure also fail to cause cyclopia.

Another argument opposed to the view that osmotic pressure is the cause is the fact that *Fundulus* embryos are so resistant to changes in pressure. Since two Mg salts give similar results when used in sea-water solutions, it seems probable that the action of Mg , either directly or indirectly, is responsible for the result. Eggs have been subjected to this action before the first cleavage, during the two-cell stage and just before going into four cells, with similar results. No attempt was made to determine at how late a stage the cyclopean condition could still be caused, though it could doubtless be induced after the eggs had passed much beyond the four cell stage. The fact is that cyclopia may be caused in an egg which has started its development normally and which would have given a two-eyed embryo. The idea of a germinal origin of the defect in this case seems excluded. Cyclopia in this instance is the result of unusual external conditions.

CYCLOCEPHALI AND "MONSTRA MONOPHTHALMICA ASYMMETRICA"

The magnesium solutions induce the formation of two distinct types of eye monstrosities. The first type is the typical cyclopean monsters, which exhibits a series of individuals showing various degrees of cyclopia. Beginning with a normal individual having eyes in their usual position, we find others in which the eyes are slightly inclined forward and somewhat closer together than usual; or the eyes are still more approximated and occupy an unusually anterior position. (See the diagram, Fig. 1). Next in the series are individuals with their eyes approximated but still distinctly separate, having two optic nerves and two eyeballs with their choroid coats in intimate approximation. We next find the true cyclopean eye which still shows a double nature having two optic nerves; the retina has a paired arrangement and either one or two lenses may occur, depending upon the degree of distinctness of the two components. This eye generally occupies a ventro-median position and looks forward, inclining slightly downward. The eye in others is completely single, showing no indication of a compound structure; it has one optic nerve, a single retinal arrangement, one lens and one pupil. This is the perfection of cyclopia and many embryos possessing such an eye are apparently normal in other respects, except the mouth and nose. They have a typically bilateral brain and are perfectly capable of free-swimming movements. Passing beyond this stage of cyclopia, we find embryos which have gone to the extreme and show only a defective antero-median eye. In some individuals the eye is represented merely by a choroid vesicle. The step beyond this is the entire absence of the eye. Diagram Fig. 1 gives a schematic illustration of the various degrees in the cyclopean series thus outlined. The histological conditions shown by such a series will be considered beyond. It is important to understand that this series is made up of different individuals showing various degrees of cyclopia and that a cyclopean monster does not pass through these steps in its development. The cyclopean defect is foreshadowed in its final condition when the optic vesicle first separates itself from the brain.

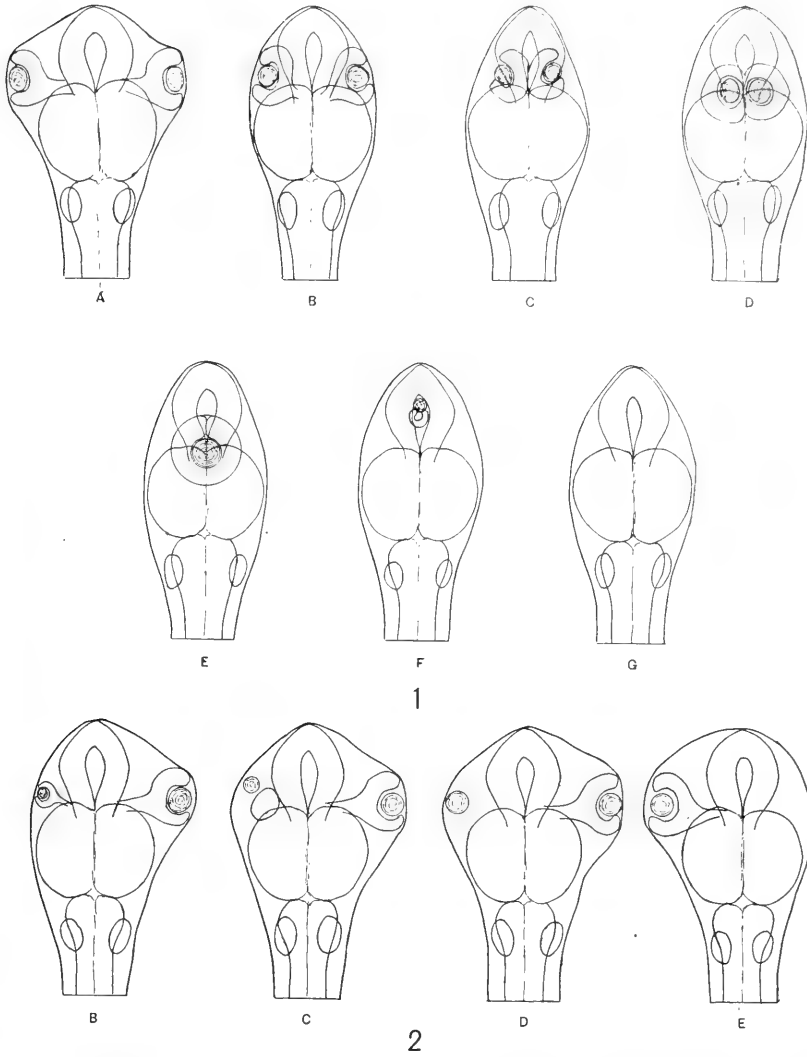

Fig. 1 Diagrams of the various conditions of the cyclopean defect as shown by the "Magnesium embryos," from the normal *A* to complete absence of the eye *G*.

Fig. 2 Diagram of the monstrem monophthalmicum asymmetricum series, from one defective eye *B* to complete absence of one eye *E*.

The second type of optic defect caused by magnesium is a new monstrosity and may be termed *Monstrum monophthalmicum asymmetricum*, the monster with one asymmetrical eye. It has only one perfect eye which represents one of the normal pair and occupies the usual lateral position. This eye is in all cases perfect while its mate may be indicated by either a small eye, by a mere cellular mass representing an optic cup, or all indications of the second optic cup may be wanting. (See Fig. 2.) This peculiar one-eyed condition exists in many of the embryos in the magnesium solutions. Had such a defect resulted from a mechanical operation, it would probably have been interpreted to mean that one eye anlage was injured and the other not. With the solutions, however, we get a clear case of the gradual dropping out of one eye by comparing different individuals, and here as in cyclopia the defect is present from the earliest appearance of the eye, and is not due to a gradual degeneration, or arrest during development. A study of sections of these embryos makes the conditions clearer.

a The Living Cyclopean Embryos from the First Indication of the Defect to the Time of Hatching

The optic vesicles appear in most eggs when about thirty hours old; at this time the blastopore is just closing and the embryo is well mapped out on the embryonic shield. Many attempts were made to select cyclopean individuals at this stage but it could not be done with a great degree of certainty, since some embryos are always slow in giving off the optic vesicles and these at times appear to have only one, but when examined some hours later are found to be normal. A number of eggs were selected, however, at thirty hours old which proved to be cyclopean on later examination.

At about forty hours the defect is plainly detectable so that one may arrange the eggs very accurately into two groups, the cyclopean individuals and the normal. After such a separation, none of the normal embryos ever exhibited the cyclopean defect in later stages, although kept in Mg solutions. A number of such tests as this in connection with the study of sections convinced me that

the cyclopean condition existed as such from the first appearance of the optic vesicles, and no subsequent fusion of the two optic vesicles or cups took place after that time.

A forty-two hour embryo is shown in Fig. 3. It is seen to be well formed and the optic vesicles are clearly outlined on either side of the head. Fig. 4 illustrates a cyclopean individual of the same age. The single optic vesicle occupying a ventro-median position is shown through the transparent embryo. This young individual with its newly formed optic vesicle shows a typical cyclopean condition, and no indication is seen of two separate elements that would later fuse. Other embryos at this age have abnormally twisted cephalic regions and show no indication of eyes, although the cyclopean eye might easily be concealed by the bent brain (Fig. 5). Such embryos at later periods are found to be cyclopean and to have narrow tubular brains showing more or less abnormal bendings.

When the embryos are about three days old, the brain has expanded and presents a distinctly bilateral appearance; the optic cups are well developed and the lenses are partially formed (Fig. 6). A cyclops monster at this time has a well formed body and the brain is often normal, though in Fig. 7 it is inclined toward the narrow tubular condition and is anteriorly twisted. The ventromedian eye is clearly seen through the brain and the outline of its lens is distinct. A somewhat younger, sixty-five hour, embryo is shown in Fig. 8 with a superficially perfect brain and two optic cups intimately approximated. The telencephalon is seen to protrude beyond the eyes, as is the case in the normal individual (Fig. 6).

Three four-day embryos are shown by Figs. 9, 10 and 11. The brain and spinal cord at this time are clearly mapped out by a coarse pigmentation, the two hemisphere-like portions (*corpora bigemina*) of the mid-brain are distinctly formed and the eyes are large with the lens clearly outlined within the cup. A cyclopean monster with a perfectly formed large ventro-median eye is illustrated by Fig. 10. Comparing its brain and other parts with the normal (Fig. 9), one fails to find any important deviations. The abnormal condition of the narrow tubular brained cyclops,

Camera lucida sketches of living embryos from MgCl₂ solutions

- Fig. 3 A normal embryo of forty-two hours, the two optic vesicles present.
- Fig. 4 A typical cyclopean individual of forty-two hours. The single median eye (*O. V.*) is represented in circular outline.
- Fig. 5 An embryo of same age, twisted brain, no optic vesicle shown.
- Fig. 6 Normal seventy-two hour embryo.
- Fig. 7 Cyclops of same age. The eye, *op.c.*, in ventro-median position.
- Fig. 8 Sixty-five hour embryo, two ventrally approximated optic cups.
- Fig. 9 Normal four day embryo—bilateral brain outlined.
- Fig. 10 Four day cyclops, large ventro-median eye and typically bilateral brain, *op.c.*, the eye.
- Fig. 11 Four day cyclops with narrow tubular central nervous system.
- Figs. 12 and 13 Five day cyclops, narrow tubular brain with waist-like constrictions dividing them into fore, mid and hind-brain regions. Ventro-median eye.
- Fig. 14 Five day cyclops with ventro-median eye and dorsally humped brain.

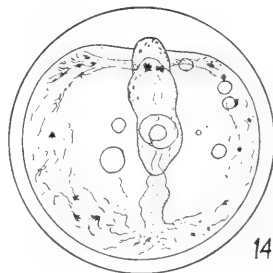
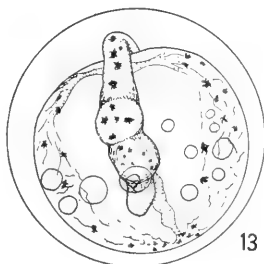
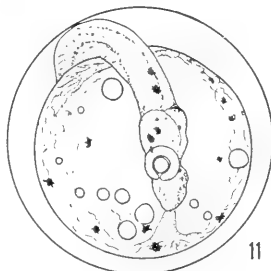
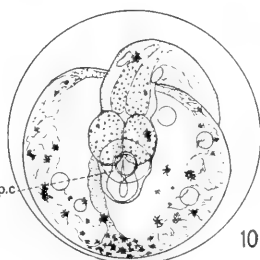
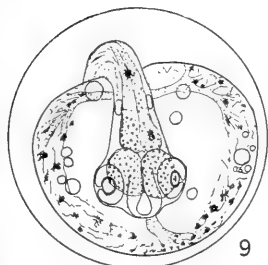
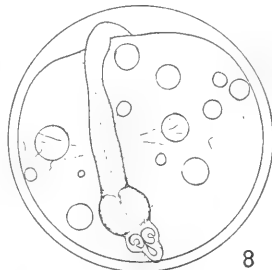
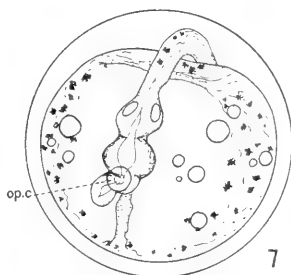
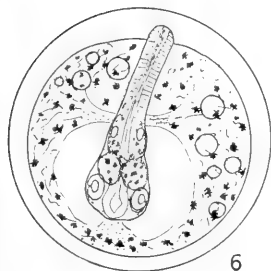
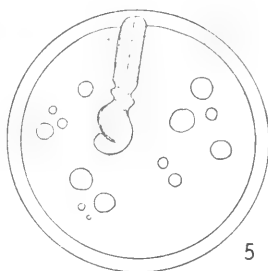
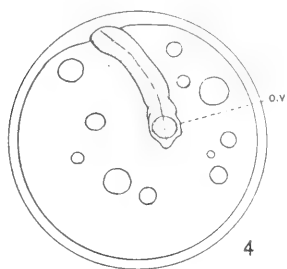
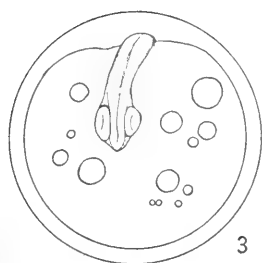

Fig. 11, is evident. Fig. 12 shows a common type of cycloopia with the three primary brain regions separated by waist-like constrictions. Two other variations of the narrow tubular condition are found in Figs. 13 and 14. The embryos are five days old and no changes of importance occur from this time until the hatching period is reached, except the usual progressive development of the eye structures.

The normal embryos generally begin hatching when about twelve days old, one cyclopean monster hatched at this time but most such individuals were much later than the normal in coming out. A twelve day cyclopean fish is seen in dorsal view in Fig. 15 and ventrally in Fig. 16. The large cyclopean eye projects forward and occupies the position usually taken by the mouth at this time. A slight indentation along its mid dorsal line suggests its double nature, although the ventral view (Fig. 16) shows this same eye to possess only one pupil and lens. The brain of this specimen is practically normal. An embryo with the two eyes intimately approximated is shown in front view in Fig. 17. The eyes are joined and each looks forward in a direction slightly towards the side to which it belongs. A common variety of cyclopean fish is one in which the eye is unusually small and occupies an extremely anterior position; Fig. 18 shows such an embryo. This variety is usually unable to hatch, although a few were assisted in breaking through the membrane. They swam rather abnormally, owing to a twisted condition of the body. A dorsal and ventral view of a cyclopean fish is shown in Plate I, Figs. A and B. This indicates the striking appearance presented by these embryos.

b Free-Swimming Cyclopean Fish

Many embryos, showing the cyclopean defect in various degrees, hatched normally and were capable of swimming in a manner indistinguishable from ordinary two-eyed fish. These monsters gave many indications of ability to see. They went to the more brilliantly lighted side of the dish with the normal ones. They darted away in a normal fashion when any object was placed in front of the eye, while similar objects put at equal distances from

their tails caused no excitement. In two instances they lived for ten days, which is about as long as the two-eyed embryos can survive without food. At this time the entire content of the yolk-sac has been absorbed. The embryos in nature doubtless begin feeding previous to this stage. The cyclopean individuals appear to be as active as the normal and their ability to live would seem to depend only upon the possibility of their obtaining food.

A normal fish eight days after hatching is illustrated by Fig. 23. The mouth projects forward beyond the dorsal tip of the head and the two eyes are lateral in position. A cyclopean embryo eight days after hatching is shown in Fig. 24. Here the two eyes are united and occupy the position which the mouth has in Fig. 23. In Fig. 25 a perfectly cyclopean eye is shown in dorsal view: the same individual is seen in lateral and ventral views in Figs. 26 and 27. This fish swam in a normal manner. In the lateral position the mouth is shown projecting ventrally as a proboscis-like structure. This condition is due to the fact that the single antero-median eye occupies the position normally assumed by the mouth and thus obstructs the usual forward growth of its structures. The mouth, therefore, remains ventro-posterior to the eye and grows downward, presenting the proboscis-like appearance.

Such a condition recalls in a striking way the nose of the mammalian cyclops. In mammals the cyclopean defect is accompanied by a proboscis-like nose situated in the forehead above the median eye. The nose in normal development grows downward to its facial position, but in cyclopia the median eye obstructs its path and forces the formation of the proboscis-like organ in the forehead. The same explanation holds for the fish's mouth where the eye prevents its forward growth, producing the proboscis-like organ.

It is interesting to find that the mouth in cyclopean fish stands in a position so as to fall in the gill series as number one, all the gills and the mouth have the same general direction. I have found that in *Bdellostoma* the mouth arises in a manner similar to the gills and actually at first arches dorsally and only secondarily arches ventrally. It may have originally been a member of the gill series, as Dohrn (1875) has long thought. It would be

Camera sketches of the living embryos in magnesium solutions

- Fig. 15 Dorsal view of twelve day cyclopean monster, the antero-median eye with furrow indicating its double nature.
- Fig. 16 Ventral view of the same individual, the eye possesses a single pupil and lens.
- Fig. 17 A twelve day embryo, ventral view showing two eyes intimately approximated.
- Fig. 18 Fourteen day embryo. Small extremely anterior cyclopean eye with protruding lens, extreme cyclopia.
- Fig. 19 A five day Monstrum monophthalmicum asymmetricum; the left eye has no mate.
- Fig. 20 A similar twelve day monster lacking its left eye.
- Fig. 21 An incomplete diprosopus monster seventy-two hours old. Two brains, two normal lateral eyes and one perfect middle eye, the other middle eye indicated by the circular lens *L*.
- Fig. 22 The same monster when eighteen days old, three perfect eyes. The embryo hatched three hours after this drawing was made and swam abnormally.

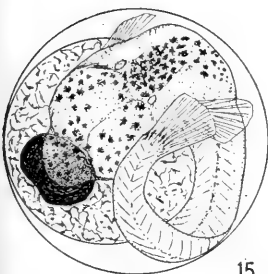

15

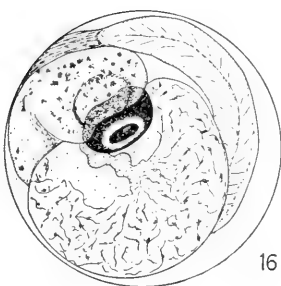

16

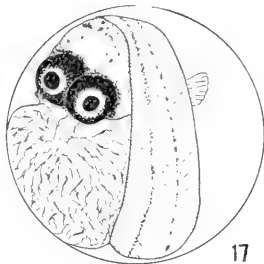

17

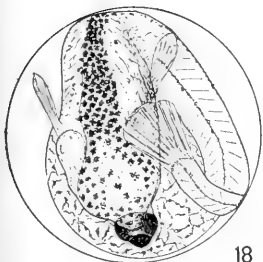

18

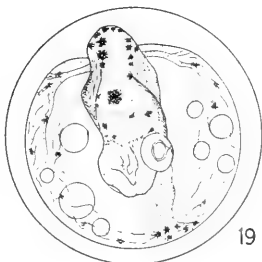

19

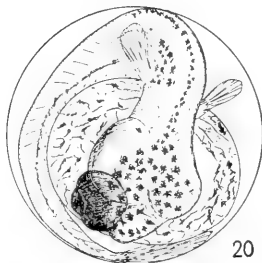

20

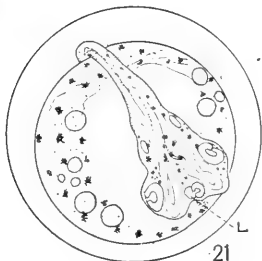

21

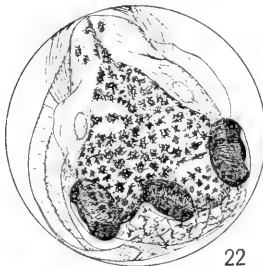

22

Camera sketches of free-swimming fish

- Fig. 23 Normal individual. *M*, its anteriorly placed mouth.
- Fig. 24 Incomplete cyclops, two eyes joined and occupy the position usually taken by the mouth.
- Fig. 25 Dorsal aspect of a perfect cyclops. Antero-median single eye.
- Fig. 26 Lateral view of same. The mouth *M* is forced by the eye to remain in a ventral position and hangs down as a proboscis-like structure.
- Fig. 27 Ventral view of same fish, note perfectly single eye, one lens and one pupil, *ys.*, yolk-sac.

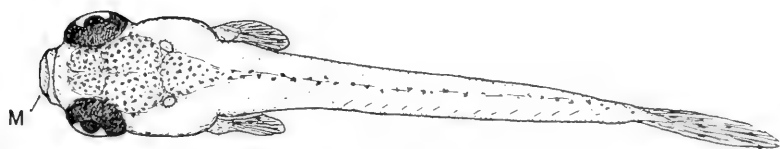

23

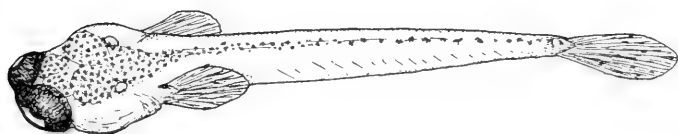

24

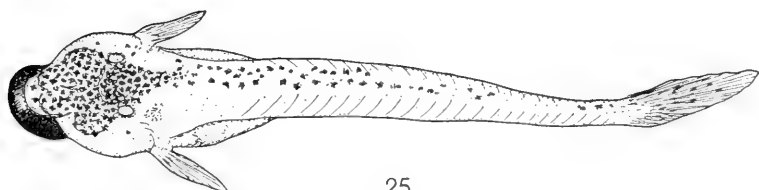

25

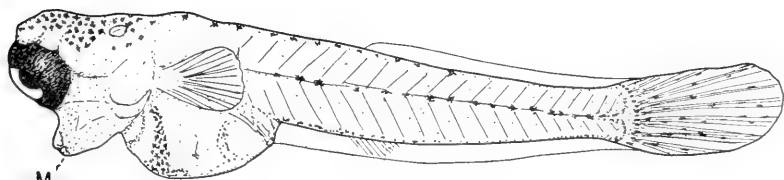

26

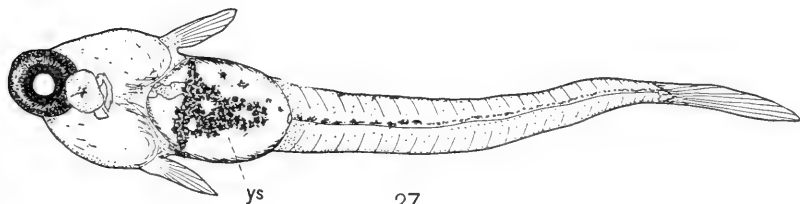

27

interesting to know whether the "cyclopean mouth" is functional. The mouth does not possess a wide opening as it would normally although a small aperture is sometimes distinguishable near the end of the proboscis. No attempt was made to feed the embryos.

c Living Monstra Monophthalmica Asymmetrica

These asymmetrical one-eyed monsters may also be identified in early stages of their development. They have a single eye situated on one side of the head. Such an eye appears in some cases as though it were cyclopean and one might easily imagine the cyclopean eye becoming displaced from its usual median position to one side or the other of the head. Studying such eyes in section, however, clearly shows their single unmated origin and condition. An embryo of this kind is shown when five days old in Fig. 19. The brain is slightly abnormal and the pigmentation scarce for such a stage of development. The eye occupies the usual place of the paired eye of that side. A twelve day embryo shortly before hatching is illustrated by Fig. 20. The shape of the body and of the head is comparatively normal. The unpaired eye is slightly forward of its usual position.

Many of these embryos hatched. A few of them swam in circles, often whirling around with great rapidity, much as Japanese waltzing mice do. Others swam in irregular spirals and only progressed in a straight direction with difficulty. This peculiar one-sided manner of swimming is not due to asymmetrical vision, but results from a defective muscular arrangement, the animal's body being slightly bent or twisted so that it is unable to straighten perfectly. Some embryos with this eye on one side had normally straight bodies and these were capable of swimming in a direct course with apparently as much ease as a two-eyed fish or the symmetrical cyclopean embryos.

These monsters also lived, free-swimming, for some time. In a few cases their mouths were perfect, but in others the mouth parts were distorted or twisted by an asymmetrical condition of the ventral head region.

MORPHOLOGY OF CYCLOCEPHALIA

It was mentioned above that the optic outpushings became visible on the sides of the brain at about thirty hours after fertilization. At this time the brain of *Fundulus* is a solid mass of cells without a central ventricle. The optic bodies are not hollow at first, but are solid outpushings which later develop central cavities. The cavity generally forms in the optic outpushings while the brain is yet solid. Dareste ('91) has advanced hypothetically the idea that if the anterior vesicles of the brain did not develop, a contact would be maintained between the "parties retiniennes" up to a certain time and consequently they would unite to give a median cyclopean eye. If this were in reality the cause of cyclopia we might expect all Teleosts like *Fundulus* to be normally cyclopean since in them the eyes arise while the brain is without a ventricle. Spemann ('04) finds in cyclopean Triton embryos that although the tube is hollow, the eye anlagen are defective from the beginning. The matter of a closed brain would then seem to be unimportant in a consideration of the causes of cyclopia.

a Earliest Indication, Exact Position and Condition of the Eye

When forty-one hours old, the brain as shown in trans-section by Fig. 28, is still a solid mass. The two normal optic outpushings have developed small cavities but no indication of invagination of the vesicles or ectodermic lens structures are seen.

A section through the optic region of an apparently one-eyed monster when forty-one hours old, is shown by Fig. 29. The sections of this series show only one ventro-lateral eye vesicle. The vesicle is large and distinctly optic in nature, while on the opposite side is shown a thick cellular wall from which the brain is becoming separated. Such an individual resembles more a *Monstrum monophthalmicum asymmetricum* than it does the cyclopean type.

Fig. 30 shows a transverse section through the eye of a forty-nine hour embryo which exhibits a perfectly clear case of cyclopia. Here the brain is beginning to form a cavity and the optic vesicle with a well defined central cavity is just invaginating to form the

optic cup. This eye occupies an almost ventro-median position and is united to the brain by a solid cellular stalk. Its contact with ectoderm from which the lens will arise is not established as the head-fold does not yet extend back to this point. An eye in such a ventral position will oftentimes come in contact with the ectoderm at a later stage than would a normal lateral eye. Ordinary two-eyed individuals at this age (forty-nine hours) were, like this cyclops, just beginning to form the optic cups and the lateral ectoderm over the incipient cups showed a slight thickening, the earliest indication of a lens. As a rule the cyclopean eye is somewhat slower than the normal in its rate of development and may generally be compared with the eyes of slightly younger two-eyed individuals.

Several embryos at this age lack eyes entirely and belong to the blind variety presently to be described.

Two-eyed embryos when fifty-four hours old possess well-formed optic cups and lenses still connected with the ectoderm, although projecting into the cavity of the cup. The nasal pits are clearly marked ectodermal invaginations in an anterior and slightly median position relative to the eyes. The brain possesses a well developed central cavity. A cyclopean eye of a distinctly double composition from a fifty-four hour embryo is shown in cross-section by Fig. 31. The optic cup is bilateral and two lens anlagen are indicated by the thickened ventral ectoderm. The section of the brain dorsal to this eye is small and hollow. It is a portion of the diencephalon which is between a larger telencephalon and a much larger mid-brain. This eye would finally have produced a large median cyclopean organ of the double type with two retinal areas and two lenses. Its connection with the brain is through two closely approximated stalks and two optic nerves would probably have formed later. Comparing such an eye with that of Fig. 32, of like age we find that here the optic cup is single and one lens is forming. Both sections show the eye in practically similar positions. The embryo from which Fig. 32 was taken possesses a well formed telencephalon and two lateral nasal-pit thickenings of the anterior ectoderm.

A horizontal section of a fifty-four hour double-eyed cyclops

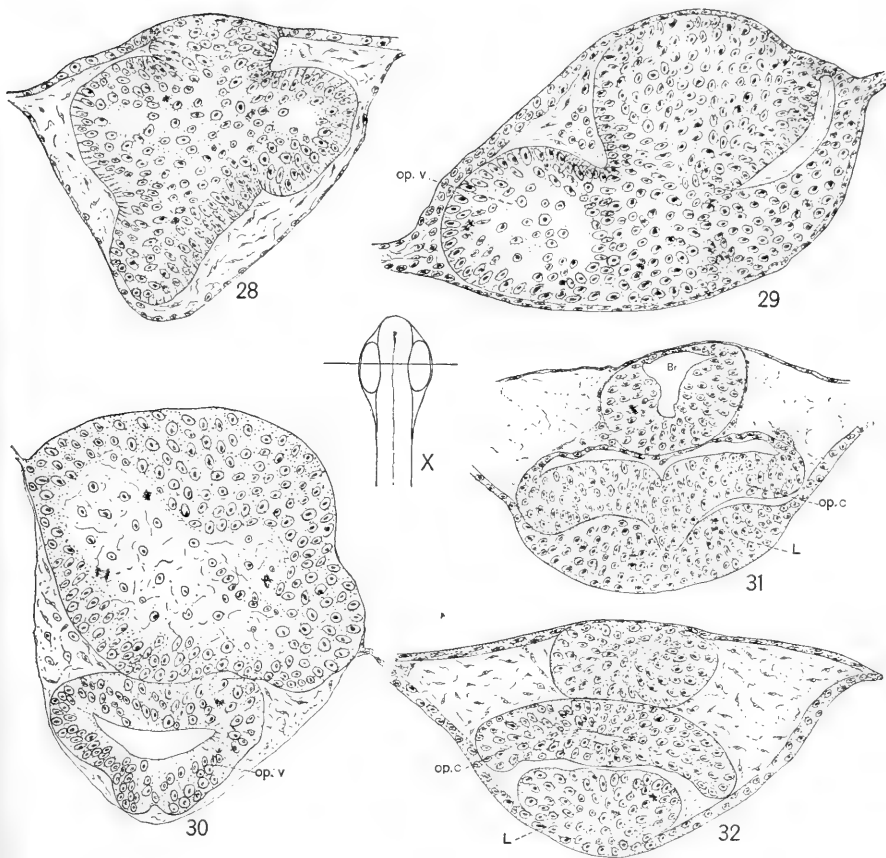

Fig. 28 A trans-section through the optic outpushings of a normal forty-one hour embryo. The brain is solid and cavities are just forming in the optic outpushings.

Fig. 29 Trans-section through the single optic vesicle (*op.v.*) of a forty-one hour embryo from $\frac{1.9}{100}$ M $MgCl_2$. The optic process is situated laterally and no indication of a like process exists on the other side.

Fig. 30 A slightly oblique section through the cyclopean optic vesicle of a forty-nine hour embryo from $\frac{1.1}{100}$ M $MgCl_2$, *op.v.* optic vesicle.

Fig. 31. Cross section through double cyclopean eye of fifty-four hour embryo from $\frac{1.7}{100}$ M $MgCl_2$, *op.c.* optic cup; *L*, lens thickening of ectoderm; *Br*, normal bilateral brain.

Fig. 32 Section of single cyclopean eye in similar embryo. *L*, lens; *op.c.* optic cup, small solid diencephalon above; *X*, guide figure indicating the plane of the sections.

is given in Fig. 33. Such a section is most instructive. The condition of the eye is much the same as that shown by the transverse section, Fig. 31. The cup is double and two ventral lenses are present. The section passes below (ventral) the diencephalon so that no part of it shows; the telencephalon is indicated in front of the eyes and a thickening of the forward ectoderm shows the nasal plate, posteriorly or behind the eyes the mid-brain is cut in horizontal section.

A sagittal section of a typical cyclopean embryo is shown by Fig. 34. Here we see the eye and the brain in the third dimension. The telencephalon in front, the diencephalon above the eye, and behind this the large mid-brain with a spacious median cavity. In front of the eye is also shown a median ectodermal thickening, the double nasal pit. The eye is single and exactly ventro-median in its position and connects in a more lateral section with the brain at about the point where the telencephalon and diencephalon join. The lens and retina are differentiating into their typical structures. One may obtain a clear mental reconstruction of the cyclops monster at this age by comparing Figs. 31, 32, 33 and 34, the transverse, horizontal and sagittal mid-planes of the cyclopean eye.

The early stages just described illustrate the cyclopean defect in its various degrees, and the eye throughout its development retains the original condition of singleness or doubleness. No evidence whatever can be found of subsequent fusions during development. Two clearly approximated eyes arise in that condition and remain so without fusing to give a double cyclopean eye, and a double eye never attains to the single condition by a more intimate union of its parts. The statement made in my (1907a) former paper, p. 257, that "the fusion of the two components may take place at different periods within a certain limit" is incorrect, as I (1908) have pointed out in a short note on the subject. This statement was one of interpretation and was based on a comparison of late embryos which showed different degrees of cyclopia. It seemed from such an incomplete study that the eyes were more or less double or compound, depending upon the stage in development at which they had become approxi-

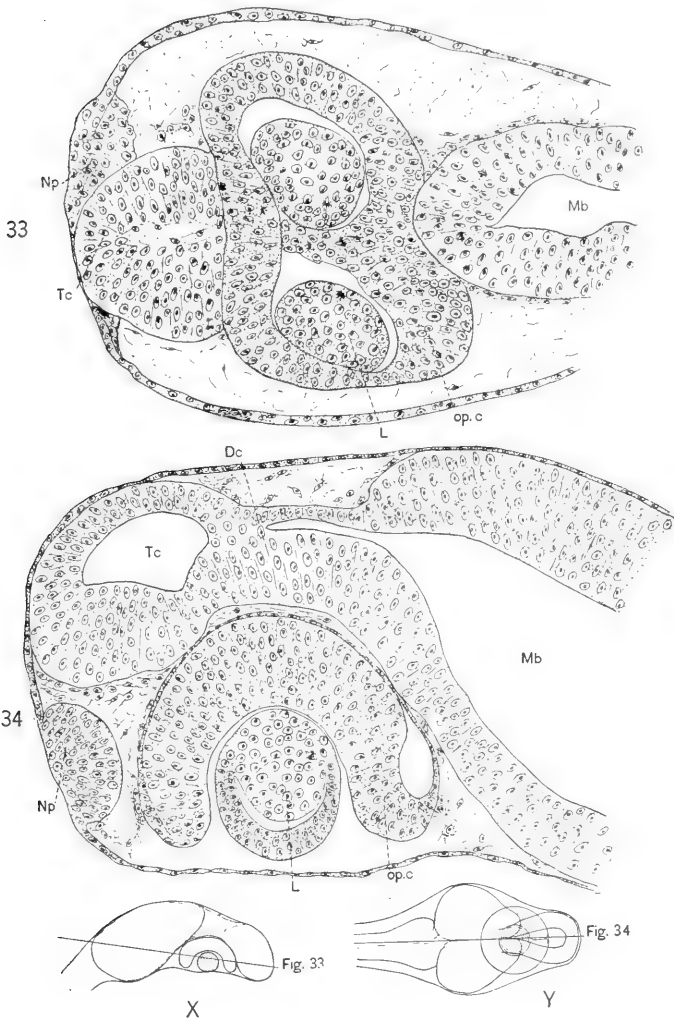

Fig. 33 Almost horizontal section through a double cyclopean eye of a fifty-four hour embryo in $\frac{17}{60}$ M $MgCl_2$. See guide figure *X* for plane of section. *Np.*, nasal plate; *L*, lens; *op.c.*, optic cup; *Tc.*, telencephalon; *Mb.*, mid-brain.

Fig. 34 Sagittal section (guide figure *Y*) through typical single cyclopean eye showing its ventral position below the diencephalon *Dc.* The nasal pit, *Np.* is median; *L*, lens; *op.c.* optic cup; *Tc.*, telencephalon; *Mb.*, mid-brain.

mated. The point is one which can only be proven by a number of direct observations on all ages of cyclopean embryos and careful study of sections; such a study has convinced me that no fusion of the eyes takes place after they are once clearly given out from the brain.

It seems advisable for later stages to consider groups of embryos showing various degrees of the cyclopean defect.

b Incomplete Cyclopia; Double Eyes

Under the term incomplete cyclopia may be considered individuals with eyes abnormally close together although separate. Among *Fundulus* embryos such individuals exist and a series of stages connect these embryos with those in which the two eyes are intimately connected or joined together. An individual of this kind when sectioned will show the eyes as in Fig. 35. This section is from a four day embryo, the two eyes are united in the median line of the head and both are perfect eyes with a lens, single retina and one optic nerve. The choroid coat as indicated by the heavy line is just beginning to form. Fig. 36 shows a section of two eyes which are more intimately united. This case is the common "hour-glass" eye of cyclopia. The two eyes are independent, except for their waist-like connection and each has its lens, single pupil, retina and distinct opticus. The optic nerve of the right component is seen entering the optic cross at the base of the brain. The brain in this embryo is remarkably perfect, as it is in many cyclopean monsters, and I see no reason whatever for attributing the defect to a "single brain" or any other gross malformation of the cephalic region. Many embryos with deformed brains possessed two normal eyes and the converse is true, many normal brains were accompanied by cyclopean eyes.

Leaving the "hour-glass" eye, we find the double-eye shown in Fig. 37, having a common optic chamber each half of which is supplied by one component. Two lenses and two pupils are present and generally two optic nerves, although they may run so nearly parallel that the two are difficult to distinguish. A single nasal pit is present in the embryo from which Fig. 37 is a section. All of the cyclopean monsters possess two distinct auditory vesicles.

Fig. 38 is a section through a unique double eye; no other such case was found. The two retinal components are connected along their median dorsal line within the brain and extend down facing one another. They are like the two sides of a leguminous pod; between the two a single lens is placed suggesting the seed in the pod. Enclosing the ventral part of the retinal components is a choroid coat shown in heavy black. This choroidal coat does not fully encompass the retinal areas, a part of which extends dorsally far up into the brain. The anterior end of the eye is V-shaped in section. The optic cup anlagen in this case must have been closely united from their first origin in the brain, since portions of the retinal region are still contained within the brain itself, yet during development they did not fuse into a single eye. A single nasal pit is present and the mouth is ventral and proboscis-like.

An almost single eye is indicated in section, Fig. 39. The choroid coat surrounds the retina, the latter showing slight traces of its compound nature. Two lightly staining regions of nerve tissue are seen and the entire eye is unusually wide laterally. The single lens is normal. The brain here is also normal and the eye occupies a ventro-median position. A further union of the eyes gives the

c Perfect Single Cyclopean Eye and Normal Brain

The cyclopean eyes are in many cases perfectly single, resembling in all respects, except their position, one eye of a normal pair. They are placed immediately ventral and their antero-posterior mid-plane is in the median line of the embryo. The brain in such a cyclops is often normal in all general respects. Figs. 40 and 41 represent horizontal sections through the brain regions of such a cyclopean fish when seventy-seven hours old. Fig. 40, the more dorsal section, passes through the mid-brain and shows the two lateral, hemisphere-like bodies (corpora bigemina) with well formed cavities. Behind these the section cuts the floor of the hind-brain for some distance and finally crosses it where the head bends. Passing ventrally through a number of sections, we find the one shown in Fig. 41. Here only a small ventral

Transverse sections of different degrees of double cyclopean eyes

Fig. 35 Section of eyes in four day embryo, the two eyes united. Choroid coat beginning.

Fig. 36 Section of "hour-glass" eyes, the optic nerve of the right component entering the normally bilateral brain. From a sixteen day embryo, the retinae and lenses differentiated. *r.o.n.*, right optic nerve; *Ch.*, choroid coat.

Fig. 37 Section of eye in hatched embryo. Double-eye with two pupils and two lenses. Retina undifferentiated.

Fig. 38 Hatched cyclops, section through the peculiar eye with two components facing and lens between them (see text).

Fig. 39 Section through almost single cyclopean eye, only indication of its compound nature paired retinal arrangement. Brain normal.

Guide figure *X* indicates the plane of all sections and the eye position in the several specimens.

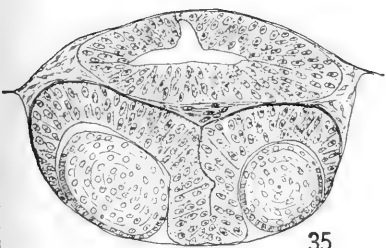

35

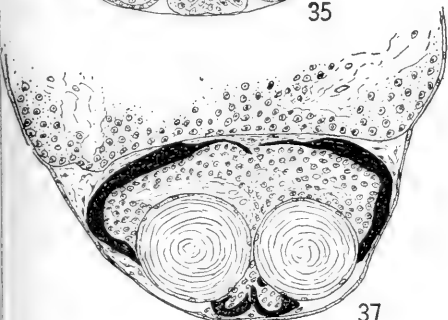

37

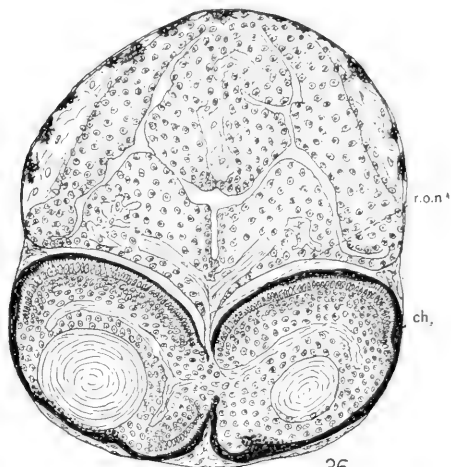

36

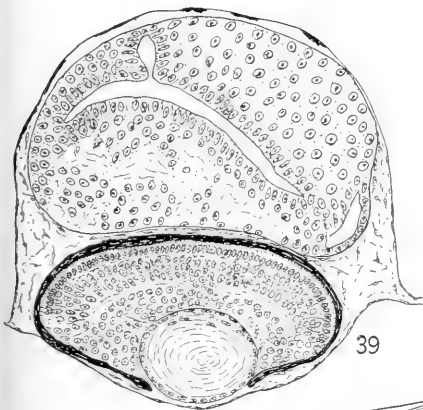

39

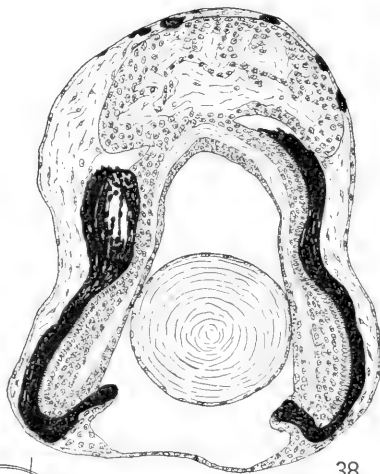

38

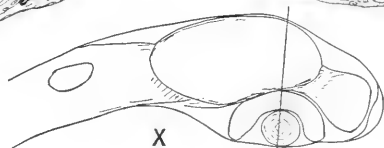

X

part of one of the corpora bigemina is cut and the completely single eye with its lens is found lying ventrally and in a median position. The double olfactory pit is seen in front of the eye and somewhat to one side of the head. The posterior part of the section runs below the hind-brain and finally cuts it as the head bends just in the middle region of the well formed auditory vesicles. The section thus presents the three sense organs, the single cyclopean eye, the nasal pits united into a double pit; the paired ear vesicles alone are in their usual positions.

A transverse section through the eye of a four day embryo is illustrated in Fig. 42. The retina is unusually wide laterally but no other indication of doubleness is shown. The choroid coat is beginning to form and the eye is connected with the floor of the brain by a single cellular stalk. The retina at this age is only slightly differentiated and there is no arrangement into layers. This embryo has two distinct nasal plates. Several of the cyclopean fish show the nasal plates separate, although they are usually represented by an anterior double plate near the middle line.

A nine day embryo of which Fig. 43 represents a section through the eye has a finely developed brain, well expanded laterally and perfect in general shape and structure. The eye is completely single and the retina is partially formed into layers; the lens is almost transparent and the vitreous humor is being formed about it. The eye has all structures closely similar to those in a paired eye of this age and would doubtless have functioned had the embryo hatched. This specimen has a single nasal pit.

Another cyclops of perfect structure when studied in sections at thirteen days old showed the mouth posterior to the eye, hanging as a ventral proboscis-like mass. Two nasal plates were present and the eye was single. This eye, Fig. 44, was unusually far forward and although the retina was well differentiated into layers the humor had not perfectly formed behind the lens. The small section of the brain is shown in Fig. 44 to be bilateral and not unusual in appearance. Passing forward through the series of sections to a place where the anterior end of the cyclopean eyeball stops, a minute lens is found lying in a ventro-median position,

Fig. 45. This lens, although only nine micromillimeters in diameter, has differentiated and shows perfect lens fibers arranged in the usual concentric fashion. It has no connection whatever with the eye, nor with any part of the central nervous system. The small lens doubtless originated and differentiated its tissue in an independent manner. The independent origin and self-differentiation of lenses will be clearly shown in a following section of this paper. Fig. 45 also illustrates the two lateral nasal plates in section.

The cyclopean eye is thus seen to be at times single in nature, showing no trace of a double composition. This may be considered the climax or perfection of cyclopia, if such an expression is permissible. Eyes not completely united, or double-eyes, are the incomplete or imperfect cyclopean condition, while the single condition reduced or distorted may be termed extreme cyclopia.

d Extreme Cyclopia: From the Abnormally Small Anterior Cyclopean Eye to Entire Absence of Eyes

Many cases are found representing the condition of extreme cyclopia. They may be considered in order, beginning with the least modified. In discussing the living embryo mention was made of those with a small cyclopean eye placed far forward (Fig. 18). Sections of such eyes show them to be of a more or less imperfect nature and sometimes deeply buried in the tissues of the head. Fig. 46 shows a section through the small eye of a hatched embryo eighteen days after fertilization. This eye is placed in the extreme anterior tip of the head and the section shows on the right side pigment spots which lie on the front end of the forehead. The eye is unusually small and the living embryo was abnormal, being unable to swim directly forward. The nasal pits are united in the anterior eye region and a proboscis-like mouth is situated ventrally.

Two still more abnormal cyclopean eyes are shown in transverse section by Figs. 47 and 48, both from thirteen day embryos. In Fig. 47 the eye is close to the single olfactory pit, the retina is differentiated into layers, but the lens is larger than the optic cup so that it cannot fit completely into it. The brain of this individ-

Sections of perfectly single cyclopean eyes

Fig. 40 Horizontal section through mid-brain showing its corpora bigemina, *Cb*, and floor of hind brain, *Hb*, in **seventy-seven** hour cyclops.

Fig. 41 A more ventral section of same series, *E*, the Cyclopean eye; *ol.p.*, olfactory pits united. *Hb*, hind-brain and *Av.*, auditory vesicle; *Cb*, floor of one mid-brain lobe. Guide figure *X* gives plane of each section.

Fig. 42 Trans-section of a four day single cyclopean eye in exact ventro-median position. *ch*, choroid coat; *p*, pigment spot.

Fig. 43 Similar section of nine day eye. Humor cavity behind the lens. Note perfectly bilateral brain. *p*, pigment spot.

Fig. 44 Section of single median eye below perfectly bilateral brain, **thirteen** days old.

Fig. 45 A more anterior section in same series as Fig. 44. The forward tip of the eye *ch* is seen. A small lens *L* lies free near the ventral ectoderm; *ol.p.*, olfactory pit; *p*, pigment spots on anterior end of brain.

Guide figure *X* indicates plane of all sections.

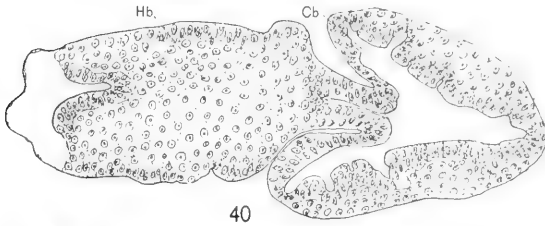

40

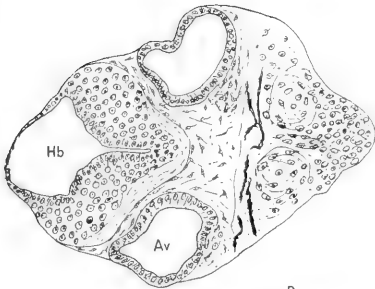

41

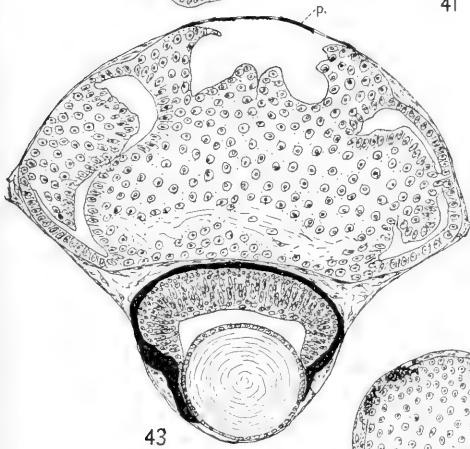
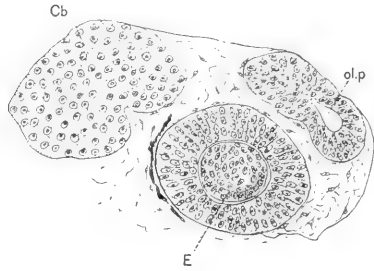

43

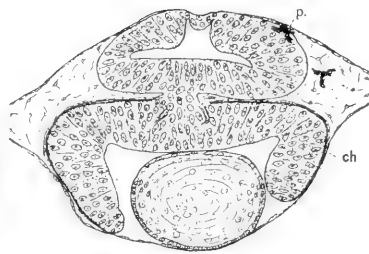

42

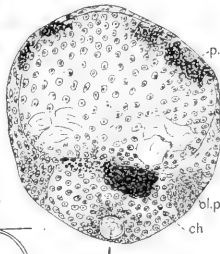

45

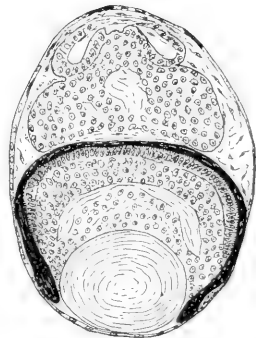

44

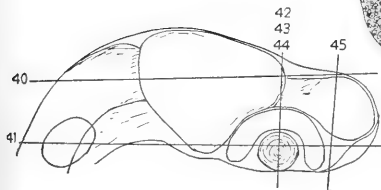

X

ual is abnormal and the eye is out of the median line. The embryo of Fig. 48 was abnormal with the brain distorted so that the cyclopean eye was slightly to one side and far out beyond the head. The retina differentiates into layers but the lens lies out of the central position, and would be unable to function efficiently.

A peculiar condition is found in the embryo from which sections shown in Figs. 49, 50 and 51 were taken. This very small eye was again in an extremely anterior position, though almost in the median line. The lens is as large as the optic cup and protrudes far out beyond its edge. Fig. 49, the most anterior section of the three, passes through the great circle of the spherical lens and shows it entirely outside the optic cup. On passing back in the series to where the lens is less in size, we reach the anterior edge of the optic cup and choroid coat, Fig. 50. Continuing back in the series of sections, the lens disappears and the optic cup alone is shown in Fig. 51. The lens in this eye is clearly too large for the accompanying cup as was also the case with the two eyes just described. The size of these lenses is, therefore, independent of the size of the optic cup. Lewis' ('04) idea that the cup regulates the size of the lens does not apply to these embryos, nor does the rule for the amphibian that the origin of the lens is dependent upon the influence of the cup.

A step beyond this condition of a small anterior eye with its ill-fitting lens may be illustrated by an embryo in which the eye is a minute choroidal sphere buried in mesenchyme below the brain and in the median line. In life this specimen seemed entirely eyeless, but sections showed this small eye-like structure (Fig. 52) in the position typically taken by a cyclopean eye. Such cases as this emphasize the necessity of sections in order to correctly interpret the conditions of cyclopia and conclusions based only on superficial studies are necessarily unreliable. The nasal pits were in the normal lateral position. Passing back in the sections to the region usually occupied by the two eyes, it will be seen that on one side a typical lens occurs (Fig. 53). The lens is well differentiated and completely isolated from all connections with either nervous or eye tissue. A band of muscle is seen in the figure to touch the inner edge of the lens.

The occurrence of this lens recalls at once Herbst's ('01) argument regarding the independent origin of the lens. He held that "if the lens really developed independently of the optic cup, then in the case of median cyclopia the two lateral lenses should arise in their usual positions; but they do not, and furthermore, the cyclopean cup gets a lens from ectoderm out of the usual lens-forming region." The *Fundulus* embryos show lenses arising at times in their usual places and often in other places, independently of the optic cup. We may suppose that in these embryos certain areas of the ectoderm are at times out of their normal positions, and thus explain the promiscuous distribution of independent lenses.

Finally, embryos exist in which no indication of the optic cup can be found, these may be said to have passed beyond the extreme cyclopean condition. They are not ordinary individuals that are merely blind, since the mouth is usually distorted and sometimes the snout-like structure which accompanies cyclopia is present. This suggests the possibility that the "proboscis-mouth" is not entirely due to its normal position having been usurped by the cyclopean eye. Some of these embryos have free lenses and others no optic parts at all. Figs. 54 and 55 are two transverse sections from the same embryo, the anterior one shows a lens lying against the olfactory pit but free from all connection with the central nervous system. Fig. 55 shows a second lens lying close against the brain tissue. This embryo has no indication whatever of optic cups, and seemed eyeless in life. Other individuals when carefully examined in section had neither an optic cup nor any lens-like structures.

We have thus reviewed a series of forms beginning with the usual two-eyed embryos and passing through all degrees of double eyes to single cyclopean eyes, to extremely small cyclopean eyes, to individuals finally with only lenses present and no optic cups and others with neither lens nor cup.

The extreme cyclopean condition

Fig. 46 Cross-section of hatched embryo, small cyclopean eye located in anterior tip of head. The nose is anterior to this section. *p*, pigment on "forehead" of embryo.

Fig. 47 Section of thirteen day embryo. Small cyclops eye with large lens, differentiated retina and abnormal brain partly surrounding the eye; *ol.p.*, nasal pit.

Fig. 48 Section of thirteen day cyclops with eye far forward and out of median line beneath an abnormal mass of the brain.

Figs. 49, 50 and 51 Sections of a small anterior cyclopean eye with large lens projecting out of optic cup. The first section Fig. 49, is most anterior, the great-circle of the spherical lens, Fig. 50, tip of lens in the edge of optic cup, and Fig. 51, center of optic cup behind the lens.

Figs. 52 and 53 Sections of **thirty** day embryo which seemed eyeless in life. **Brain abnormal.** Fig. 52, the cyclopean eye is represented by a choroid vesicle, *E*. The more posterior section, Fig. 53, shows a perfect lens *L*, in the usual lateral position, but no optic cup exists. A band of muscle *m* is between the lens and brain.

Figs. 54 and 55 Sections of two lenses *L*, one forward by the olfactory pit, *ol.p.*, the other more posterior and surrounded by brain tissue. No optic cup present in this nine day embryo.

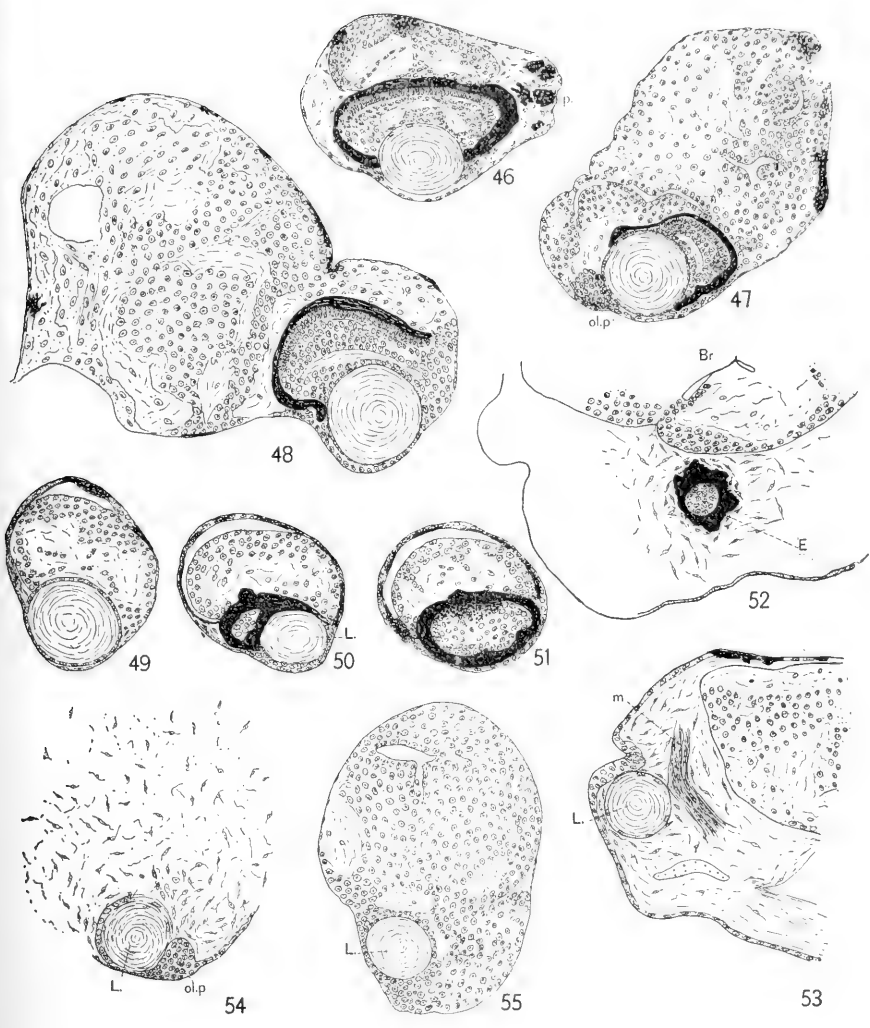

INCOMPLETE DIPROSOPUS WITH THREE EYES AND ONE
ADDITIONAL LENS

A most valuable object for study was an incomplete diprosopus monster which appeared in my solutions. This individual had two heads separated as far as the lateral eye region. It appeared as indicated by Fig. 21 when seventy-two hours old. The two brains are separate, almost back to the auditory vesicles. Two normal eyes are shown in outer lateral positions while between the heads one eye, perfect in shape, is mated with the outer eye of the left head and a circular body occupies the usual position of left eye on the right head. The embryo seemed normal in other respects and was in a vigorous condition.

The monster when eighteen days old had developed to the usual size and was still hardy. At this time it presented a striking appearance as indicated imperfectly by Fig. 22. Three large eyes normal in form and capable of movement looked out from the double head. All visible evidence of the circular body shown near the middle eye when seventy-two hours old had disappeared. The middle eye was clearly paired with the left eye of the left head component and the right eye of the right head seemed mateless. A single pair of auditory vesicles were present. The young fish respired and twisted vigorously within the membrane. Three hours after this drawing was made, the embryo hatched and swam about in a circular fashion, the body not straightening perfectly. The free living animal was kept for five days and then preserved for sectioning.

The sections show the presence of two brains, one spinal cord and one normal mouth leading into a pharynx with its series of gills, while a second short throat is present in the right head. There are two notochords back to the middle of the yolk-sac and one from there on. The rear end of the medulla becomes single and only one pair of ear vesicles are present. There are two olfactory pits anterior and median to the lateral eyes.

Three perfectly normal eyes exist. They possess clearly differentiated retinæ, irides, humor chambers and lenses. Two of these eyes are connected in the usual way with the brain of the

left head and one with the brain of the right. Fig. 56 is a section showing the middle eye somewhat back of its center so as to bring the edges of the other eyes into the figure. The middle eye is more anterior in position than the two lateral ones, owing to the slight obliquity of the left head. A distinct lens is shown in the cup in Fig. 56. On going backwards in the series we reach a section passing through the middle of the two lateral eyes and the posterior end of the middle eye (Fig. 57). The section shows dorsally the huge double brain and ventrally a central throat and most interesting of all a fourth lens. This lens lies against the outside choroid coat of the middle eye and is in just the position (recognizing a displacement due to development of the middle eye) to be the lens of the left eye of the right head, if such an eye were present. We thus have in this double head three typical eyes and the fourth represented by a free lens. It was impossible to detect the clear lens in the living embryo which emphasizes again the necessity of sections for a definite interpretation of the conditions existing in these monsters. Conclusions drawn from observations on the living eggs without the comparison of sections may be incomplete. The sections further make clear the nature of the circular outline shown against the middle eye of the seventy-two hour embryo (Figs. 21 and 57). Comparing the figures of sections and those of the whole embryos, it will be remembered that the sides of the sections are transposed, since the drawings of the total embryos are made from a simple microscope and the sections from a compound microscope which inverts the image.

This incomplete diprosopus monster increases the series of eye monstrosities so that it passes through the cyclopean group to beyond the normal. The diagram (Fig. 58) illustrates in a simple way the various conditions we have considered and emphasizes the continuous nature of the series. Beginning at one end with eyeless individuals, we pass gradually through a series with small buried cyclopean eyes (which may be indicated in the diagram by a palpebral opening, such as similar mammalian cyclops would show), to the perfectly single cyclopean eye, to the double eye with one lens and pupil, to the hour-glass eye with two lenses and two pupils, to two independent but closely approximated eyes, next to

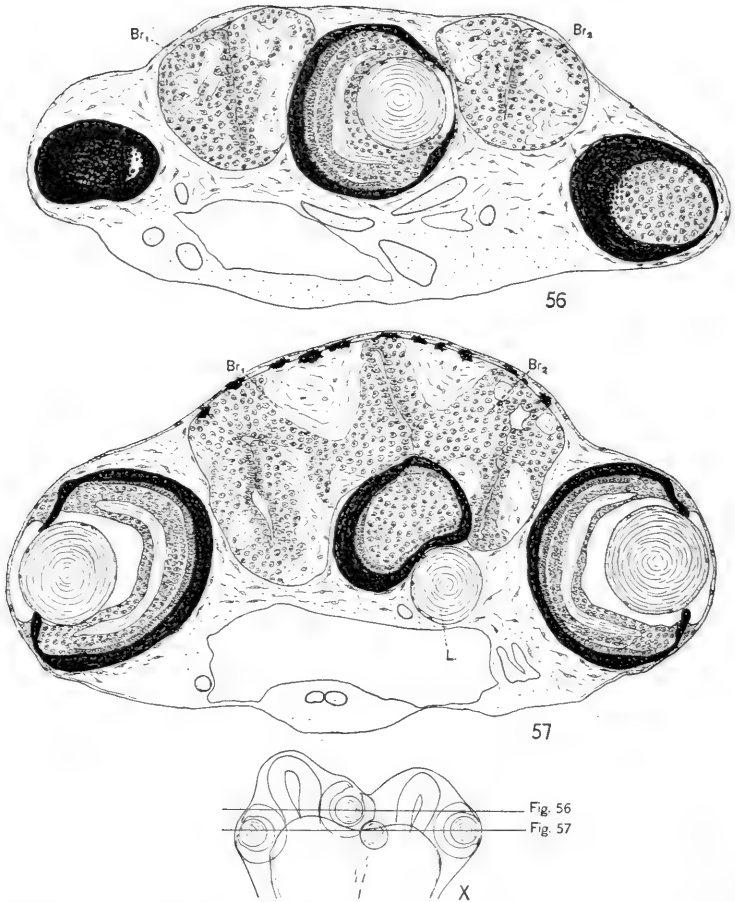

Fig. 56 Section through anterior median eye and edges of lateral eyes of hatched incomplete diprosopus; Br_1 Br_2 , the two brains

Fig. 57 More posterior section through middle of lateral eyes, posterior part of middle eye, and an additional fourth lens L .

Guide figure X makes both sections clear.

the normal condition and finally beyond to the incomplete diprosopus with three eyes and a fourth lens. The idea of arranging monsters in such a series including the normal is due to Prof. H. H. Wilder.

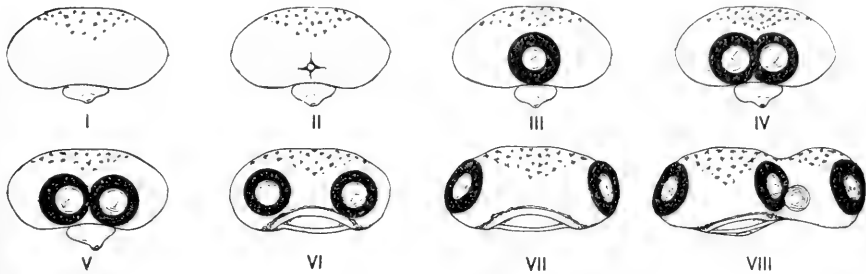

Fig. 58 Diagram of the various conditions shown by the "magnesium embryos" from entire absence of the cyclopean eye *I*, to deeply buried eye *II*, perfect single cyclopean eye *III*, double-eye, *IV*, two approximated eyes *V*, eyes unusually close together *VI*, normal *VII*, three eyes and fourth lens *VIII*.

The normal is a mean from which different degrees of abnormalities are but greater or less deviations. It is possible to arrange almost any type of abnormality in such a series. Supernumerary arms or legs on one side might exist in various individuals in different numbers down to the single normal one; other specimens could be found showing degenerate or small arms and finally armless or legless individuals are known.

MORPHOLOGY OF MONSTRA MONOPHTHALMICA ASYMMETRICA

A brief description of the asymmetrical monophthalmica monsters in life has been given above, but their true nature and structural conditions are impossible to detect without sections. It is found that here again a continuous series exists, beginning with the ordinary two-eyed individual through all gradations to the complete disappearance of one eye.

The section through the middle of the eyes in a normal embryo of thirteen days old is illustrated in Fig. 59. The eyes, of course, are equal in size and alike differentiated structurally. In the salt solutions, however, many embryos occur with one eye perceptibly

smaller than its mate. A section through the eyes of an embryo of this kind when seventy-six hours old is shown in Fig. 60. The left eye is decidedly smaller than the right and possesses a correspondingly small lens. From the comparative study of a number of individuals it may be safely stated that this difference in size between the two eyes will not be overcome later, nor on the other hand will the small eye degenerate or disappear. The embryo will hatch with its eyes in dissimilar conditions comparable to the state of things shown by this seventy-six hour stage. The brain is normal and two nasal plates are present.

An embryo closely similar to the one just described was sectioned after hatching. Its large eye appears as in Fig. 61. More anterior sections show a small eye looking forward with a somewhat protruding lens in its cup. Behind this small eye is another lens lying free in the ectoderm (shown in Fig. 61). This lens is perfectly differentiated and appears to have arisen independently.

A further reduction of the eye is shown by Fig. 62. In this thirteen day embryo the left eye is perfect and the right is represented by a small cellular mass lying close against the brain. The lens of the right side is entirely wanting. In life the head was slightly one-sided, obviously on account of the asymmetrical eye development; no indication of the cellular mass could be detected and the embryo seemed truly one-eyed.

A section of another seventy-six hour individual which in life also seemed to be one-eyed is illustrated by Fig. 63. The brain is normal and almost bilaterally symmetrical, an ordinary left eye exists but there is not the trace of an indication of the right optic cup. An ectodermal thickening represents the right lens in process of formation in the position that it would typically occupy. This lens anlage must have arisen independently of a stimulus from an optic cup and is well removed from the brain, so that no direct stimulus from that source can be responsible for its appearance.

Other one-eyed individuals showed complete absence of all parts of the second eye, the lens as well as the optic cup failing to arise. The occurrence in the Mg solutions of these one-eyed embryos as well as the cyclopean embryos suggests that the chem-

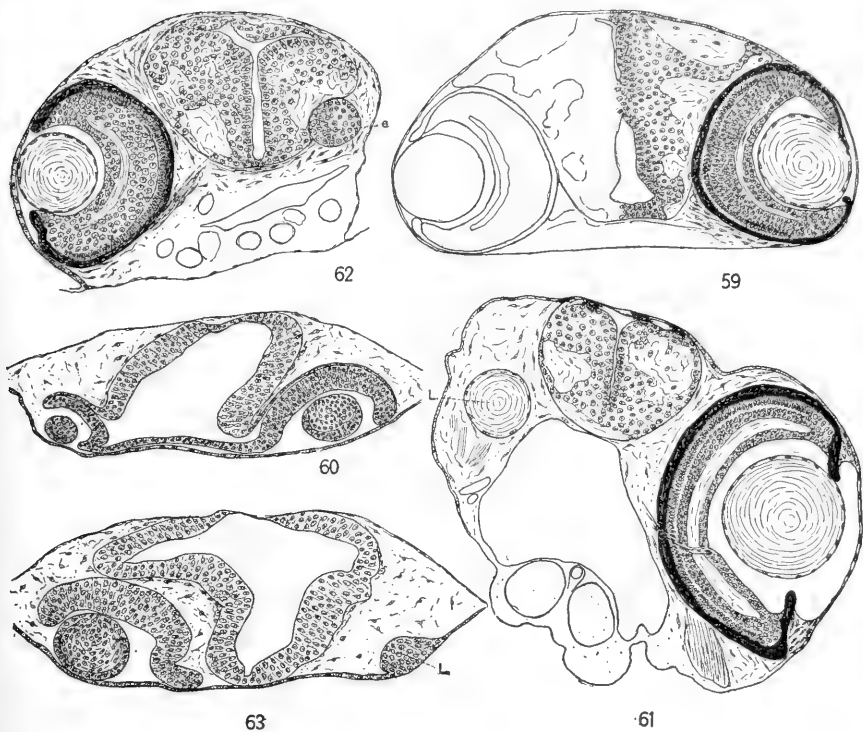

Monstra monophthalmica asymmetrica

Fig. 59 Section through eyes of normal thirteen day embryo.

Fig. 60 Section of seventy-six hour embryo with one normal and one small eye and perfect brain.

Fig. 61 Section of the normal eye of a hatched embryo; a small eye with a lens is situated more anteriorly on the other side and behind this is a third lens, *L*, shown in the figure on the left side.

Fig. 62 Section of normal eye in thirteen day embryo, the other eye is represented by the cellular mass, *e*, close against the brain.

Fig. 63 Section of normal eye in seventy-six hour embryo, the brain is bilateral and perfect, but no indication exists of the right optic cup although the ectoderm of that side has formed a lens thickening *L*.

ical influence exerts a peculiar inhibition of that process of out-pushing or separation by which the optic vesicles arise. Such an idea will be more fully considered in the general discussion given below.

The unequal eyes may possibly result from an unequal allotment of eye material to one side or the other. A major portion might go to the right side and a minor part to the left, or the entire eye anlagen might by chance occur on one side. This in a sense would be lateral cyclopia. Such reasoning is of course purely hypothetical.

INDEPENDENT ORIGIN AND SELF-DIFFERENTIATION OF THE CRYSTALLINE LENS

Spemann ('01), Lewis ('04), and others have concluded from experiments on amphibian embryos that there is no localization of lens-forming material in any given area of the ectoderm. They further held that the formation of a lens is dependent upon a stimulation of the ectoderm through contact with the optic-vesicle or cup. Spemann ('05) in discussing the question of the self-differentiating power of the lens concluded from a consideration of Schaper's ('04) experiments on the frog that the lens is not capable of self-differentiation, but that a continued influence or contact of the optic-cup is necessary to cause the lens-plate or lens-bud to develop into a typical lens. LeCron ('07) has recently shown that the lens in *Amblystoma* is not self-differentiating. I ('07d) found in embryos of the blind Myxinoid, *Bdellostoma stouti*, that a lens-thickening formed in early stages while the optic-vesicles were near the ectoderm. During development the optic cup becomes distantly removed from the ectoderm and the lens-plate disappears as if it were unable to continue development independently of the optic cup contact.

On the other hand Mencl ('03) has claimed that the lens in *Salmo salar* is at times formed independently of the optic cup influence and Spemann ('07) has recently modified his attitude. Spemann finds that in a certain species of frog, *Rana esculenta*, the lens may arise independently of the optic cup. This lens also

continues to develop and differentiates typical fibers. Most conclusive evidence favoring the independent origin and self-differentiation of the lens is furnished by the *Fundulus* embryos now under consideration.

Attention has been called repeatedly to the occurrence of lenses having no connection with other optical parts. It may be well at this time to summarize these cases which clearly show that in *Fundulus* the lens may arise independently and continue its development and differentiation.

Fig. 63 illustrates the budding off of the lens from ectoderm on the side of the head which lacks entirely an optic cup. Fig. 61 shows a lens fully differentiated though lying freely in the mesenchyme of the head. It will be recalled that this is a supernumerary lens; the large and small eyes of the embryo both possess lenses. An optic cup can not be responsible for this third lens. Fig. 57 of the incomplete diprosopus shows the fourth lens of the double head entirely outside the optic cup of the third eye which possesses a lens. Figs. 54 and 55 show two lenses in an embryo that possessed no trace of an optic cup. Fig. 53 indicates a lens in its usual position but no optic cup is present. In Fig. 45 a tiny lens is found in front of a cyclopean eye which possesses its own lens. Many other similar illustrations could be given.

No one could hold that this indiscriminate collection of lenses, all of which are entirely isolated from any connection with optic cups or other eye parts, as well as in nearly all cases from the brain itself has arisen through direct stimuli derived from the optic cups. It is also evident that the lens after its formation continues to self-differentiate.

It seems to me that in *Fundulus* the case is clearly proven that lens formation does not depend upon a direct stimulus from the optic cup. Such a dependence as advanced by Lewis ('04) for the frog is not, therefore, of universal application, nor is the view tenable that the differentiation of the lens depends upon a continued stimulus from the optic cup.

DISCUSSION AND CONCLUSIONS

The foregoing facts furnish important information as to the cause and manner of development of cyclopia, and the facts bear directly on previous ideas concerning this subject.

By treating the fish eggs with magnesium solutions, it is conclusively shown that the experimenter has the power without mechanically injuring the egg or embryo to cause what would have been a two-eyed individual to become a cyclopean monster. This undoubtedly is a case of the occurrence of cyclopia through the action of external influences on the developing egg. I conclude, then, that cyclopia does not necessarily result from germinal variations, but I make no claim that it may never arise in such a way. On the contrary, there is no reason why cyclopia should not occur through germinal variations as readily as does any other new feature. The fact that mammalian cyclopean monsters do not survive, or even if it be proven that the free-swimming cyclopean fish are incapable of living or reproducing, does not argue against the possibility that cyclopia may in cases be due to germinal variation. Such a statement is emphasized by a case I ('07c) recently recorded. In a flock of sheep in North Carolina two entirely legless lambs appeared in the spring of 1907. Again in 1908 two other similar lambs have occurred, one being the offspring of a mother which had previously borne a legless individual. These lambs were unable to feed without assistance and in nature would doubtless have died shortly after birth, but their peculiar occurrence in this flock is very probably due to germinal variations, either within the mother or father, or both. Students of inheritance consider sports to be due to germinal variations and the ability of such sports to survive depends merely on their adaptations to the surroundings and not in the least on their manner of origin. No reason can be given why a cyclopean individual might not occur as a sport due to sudden germinal variations. From the experiments contained in the present paper, however, it may be emphatically affirmed that cyclopia is *not always* due to germinal origin.

Spemann ('04) through an ingenious method of experiment, produced double-headed Triton embryos which exhibited various

degrees of cyclopia. The eggs of this salamander when constricted about the periphery of the first plane of cleavage with a fiber-like ligature gave monsters with two equal heads. When the ligature was oblique with reference to this plane one of the heads was cyclopean to a greater or less degree. Spemann thought the defective head due to the loss of the anlagen of certain parts, consequently these parts never began development and organs situated lateral to them developed in contact from the start. In other words parts between the eye anlagen fail to form and thus the anlagen come in contact and so develop from the beginning. This explanation is of course entirely speculative, but it is supported in a manner by experiments which according to Mall ('08) Lewis has performed on the fish embryo. Mall states that Lewis found by pricking the extreme anterior end of the embryonic shield in *Fundulus* eggs that many of the eggs develop into cyclops embryos. It was found in some that the prick had destroyed the "nose" only. "This experiment shows conclusively that it is the absence of tissues between the eye anlagen that allows them to come together and unite."

The above explanation no doubt holds for some cases of cyclopia produced by cutting or pricking; there it is evident that tissue is destroyed and the destruction of median tissue may cause the regions containing the eye anlagen to unite. It is difficult to apply this explanation to all cases. In the "Magnesium embryos," why should tissue between the eyes fail to form and not other tissues; why are the nasal pits united in some cyclops and separate in others? A close microscopic examination of the brain floors in cyclopean and two-eyed embryos shows no absence of recognizable parts in the former. The monstra monophthalmica asymmetrica are also to be explained; here one eye in some cases fails to come off from the brain. Is this due to the absence of its early anlage? The very small cyclopean eye sometimes buried deeply in the head, and the eye shown in Fig. 38 which is partly inclosed within the brain, as well as the entire absence of an eye, suggest another explanation that may apply to all cases in the magnesium solutions.

The small eyes close together, cyclopia in various degrees, the

imperfect formation or absence of one eye and entire absence of eyes are all conditions common to the magnesium solutions and very rare or never occurring in other solutions, nor in the hundreds of eggs observed developing in sea-water. The conditions are, therefore, probably due to a common cause, and I suggest hypothetically that this cause is an inhibitory or anæsthetic effect of the magnesium on the process of outpushing and separation of the optic vesicles. Magnesium exerts a decidedly anæsthetic effect upon both vertebrate and invertebrate animals and is an inhibitor of muscular activity. It might possibly inhibit the giving off of the optic vesicles or prevent their separation in the brain, so that both might come off together as in cyclopia, and it might have caused the eye in Fig. 38 to be arrested when only halfway separated from the brain; the absence of one eye and complete absence of eyes would be perfect inhibition. It is necessary to find a definite point in the strength of the solutions in order to obtain the proper amount of inhibition for many weaker eggs are killed during early stages.

The strongest argument against such an hypothesis is the fact that Mg in distilled water solutions fails to cause cyclopia, whereas its anæsthetic or inhibiting powers should be most active in such a solution.

Dareste's ('91) idea that cyclopia is caused by a closed brain or the failure of the anterior vesicle to develop is unsupported, since in Triton with the hollow-brain tube present Spemann finds that the defect occurs. In *Fundulus* the optic outpushings are normally given off while the brain is yet solid, so that according to Dareste all of these fish would be cyclopean in nature.

Schwalbe ('06) in his *Morphologie der Missbildungen des Menschen und der Tiere*, considers cyclopia to result from unusual pressure exerted during early stages of development which does not cause the lateral parts to grow together but prevents them from developing at all. This position is somewhat in accord with the hypothesis suggested above. If pressure prevents the growing apart laterally of the Anlagen which normally require energy to accomplish their separation, then by anæsthetizing a part, one accomplishes practically the same thing as by applying pressure.

The part in anæsthesia lacks energy to grow out laterally, thus the two eye anlagen remain together in the floor of the brain and come off as one median vesicle either double or single, depending upon the extent of separation possible under the given degree of pressure or anæsthesia.

Mall ('08), in his recent memoir on the causes underlying the origin of human monsters, gives an excellent survey and discussion of the evidence furnished by experimental teratology. In the body of the paper is presented a strong case in favor of external influence during development as the chief cause of many monstrosities. Here we may consider only the discussion of cyclopia. The idea of fusion of the two eye vesicles during their development is advocated, but the present evidence is against this position and is in accord with Spemann's ('04) view of an early defective anlage. Mall also inclines toward the idea of the single brain as being primarily responsible for cyclopia, but it is shown by embryos considered here that cyclopia often accompanies perfectly bilateral and bilobed brains, neither does a retarded growth of the frontal process necessarily follow in cases of cyclopia.

Experiments uphold the statement "that every egg has in it the power to develop cyclops monsters." The germinal theories of cyclopia are shown by the experiments to be unnecessary as explanations of its cause. The possibility of its occurrence through germinal variations, though to my mind extremely slight, is not entirely excluded by experiments. The experiments conclusively show the origin of cyclopia through external influences.

Much could be said pro and con regarding the significant nature of the cyclopean fish embryos as a specific response to a definite chemical environment. The suggestion is evident, though highly hypothetical, that cyclopia in man and mammals might be due to a similar chemical cause, an excess of Mg salts in either the mother's blood or the amniotic fluid surrounding the developing embryo.

The Magnesium embryo is as typical of these Mg solutions as is the now classic lithium larva of the sea urchin produced by Herbst ('92, '93) in his Li solutions, or Morgan's ('04) lithium frog embryos produced in a similar way. They all tend to show that dif-

ferent chemical conditions may each induce by their actions a specific type of larva from a given variety of egg.

SUMMARY

1 The eggs of the fish, *Fundulus heteroclitus*, give rise to a large percentage of cyclopean embryos when subjected during their development to solutions of magnesium salts in sea-water. Similar results follow if the eggs are placed in the solutions either before cleavage or when in the two or early four-cell stages, later stages were not tried. This is the first instance of repeatedly causing, by the use of chemical substances, vertebrate monstrosities such as are known in nature.

2 The peculiar embryos with the median cyclopean eye are able to hatch. Many of them swim about in a perfectly normal manner, darting back and forth to avoid objects placed in their field of vision as readily as do two-eyed individuals.

3 The cyclopean fish is exactly comparable to the monstrous cyclops of man and other mammals. Both have a median eye either double or single in its structure. The nose in the mammalian cyclops is a single proboscis-like mass above the eye. The nasal pits in the "Magnesium embryos" are sometimes united and sometimes separate, but the mouth hangs ventrally as a proboscis-like organ strikingly suggesting in form the nose in mammalian cyclopia. The mouth of *Fundulus* normally occupies an extremely anterior position but in the cyclopean fish the eye has usurped this place, thus preventing the usual forward growth of the mouth elements and forcing them to remain ventrally as the proboscis-like mass. (See Figs. 25, 26, 27.) In cyclopean mammals a similar mechanical explanation accounts for the condition of the nose. The median eye obstructs the path of down-growth which passes normally between the eyes, and forces the nose to form above the eye as a proboscis on the forehead.

4 A study of more than 275 living cyclops monsters and of many of these in section shows all degrees in the defect. Eyes unusually close together, intimately approximated eyes, the double

eye in a median position, the single cyclopean eye, an extremely small anterior eye, a deeply buried ill-formed cyclopean eye, and finally an entire absence of the eye. The embryos exhibit these various degrees of the cyclopean defect from the earliest appearance of the optic outpushings, and in no case was cyclopia due to a union or fusion of the two eye components after they had originated distinctly.

5 A second type of monster designated as *Monstrum monophthalmicum asymmetricum*, the monster with one asymmetrical eye, was also common in the magnesium solutions. These individuals have one perfect eye of the normal pair but the other is either small, poorly represented or entirely absent. This condition is also present from the first appearance of eye structures and is not due to degeneration or arrest of development.

6 Both types of monsters often form lenses independently of the optic cup stimulus. These self-originating lenses are also capable of perfect self-differentiation, forming lens fibers and appearing as transparent crystalline bodies. Such facts oppose the idea that the lens during its origin and development is in a dependent relationship with the optic cup, and show this view not to be of universal application.

7 The experiments conclusively prove that eggs may be induced to develop into cyclopean monsters by external influences. These influences do not mechanically injure or destroy certain eye regions as does cutting or pricking. It follows, therefore, that cyclopean monsters appearing in nature are not necessarily due to germinal variations, but are far more likely the result of some unusual external influence during development.

8 The occurrence of the various eye monstrosities shown by embryos which develop in magnesium solutions are all probably due to a common cause and I suggest the following hypothetically: Magnesium which possesses a decidedly anæsthetic effect on most animals and is inhibitory in its influences on muscular activity may retard through degrees of anæsthesia the optic outpushings in *Fundulus* embryos and thus account for the total absence of eyes, small eyes, eyes which failed to develop energy necessary for their normal separation and the other unusual conditions which

have been considered in detail in the present article. This view, of course, is hypothetical and objections to it are recognized.

Cornell University Medical College
New York City, October 1, 1908

LITERATURE CITED

- DARESTE, C. '91—Recherches sur la production artificielle des monstruosités ou essais de tératogénie expérimentale. pp. 366-383, Paris.
- DOHRN, A. '75—Der Ursprung der Wirbelthiere und das Princip des Funktionswechsels. Leipzig, pp. 1-87.
- HERBST, C. '92—Experimentelle Untersuchungen über den Einfluss der veränderten chemischen Zusammensetzung des umgebenden Mediums auf die Entwicklung der Thiere. I. Theil. Zeitsch. f. wissensch. Zool. iv, pp. 446-518.
- '93—Experimentelle Untersuchungen. II. Theil. Mittheil. aus der Zool. Station zu Neapel, xi, pp. 136-220.
- '01—Formative Reize in der thierischen Ontogenese. Ein Beitrag zum Verständniss der thierischen Embryonalentwicklung. Leipzig.
- LECRON, W. L. '07—Experiments on the Origin and Differentiation of the Lens in *Amblystoma*. Am. Journ. Anat., vi, pp. 245-258.
- LEWIS, W. H. '04—Experimental Studies on the Development of the Eye in *Amphibia*. I. On the Origin of the Lens. *Rana palustris*. Am. Journ. Anat., iii, pp. 505-536.
- MALL, F. P. '08—A Study of the Causes Underlying the Origin of Human Monsters. Journ. Morph., xix, pp. 1-361.
- MENCL, E. '03—Ein Fall von beiderseitiger Augenlinsenausbildung während der Abwesenheit von Augenblasen. Arch. f. Entw'mech., xvi, pp. 328-339.
- MORGAN, T. H. '03—The Relation Between Normal and Abnormal Development of the Embryo of the Frog, as Determined by the Effects of Lithium Chlorid in Solution. Arch. f. Entw'mech., xvi, pp. 691-712.
- '06—Experiments with Frog's Eggs. Biol. Bull., xi, pp. 71-92.
- SCHAPER, A. '04—Ueber einige Fälle atypischer Linsenentwicklung unter abnormen Bedingungen. Anat. Anz., xxiv, pp. 305-326.
- SCHWALBE, E. '06—Die morphologie der Missbildungen des Menschen und der Tiere. I. Theil. Allgemeine Missbildungslehre. Jena, pp. 1-230.

- SPEMANN, H. '01—Ueber Correlationen in der Entwicklung des Auges. Verhandl. der Anat. Gesellsch., 1901.
- '04—Ueber experimentell erzeugte Doppelbildungen mit cyclopischem Defekt. Zool. Jahrb. Suppl. vii, pp. 429-470.
- '05—Ueber Linsenbildung nach experimenteller Entfernung der primären Linsenbildungszellen. Ausführlich: Zool. Ang., xxviii.
- '07—Neue Tatsachen zum Linsenproblem. Zool. Anz., xxxi, pp. 379-386.
- STOCKARD, C. R. '06—The Development of *Fundulus heteroclitus* in Solutions of Lithium Chlorid, with Appendix on its Development in Fresh Water. Journ. Exp. Zoöl., iii, pp. 99-120.
- '07a—The Artificial Production of a Single Median Cyclopean eye in the Fish Embryo by Means of Sea-water Solutions of Magnesium Chlorid. Arch. f. Entw'mech, xxiii, pp. 249-258.
- '07b—The Influence of External Factors, Chemical and Physical, on the Development of *Fundulus heteroclitus*. Journ. Exp. Zoöl., iv, pp. 165-201.
- '07c—A Peculiar Legless Sheep. Biol. Bull., xiii, pp. 288-290.
- '07d—The Embryonic History of the Lens in *Bdellostema Stouti* in Relation to Recent Experiments. Am. Journ. Anat., vi, pp. 511-515.
- '08—The Question of Cyclopia. Science, n.s., xxviii, pp. 455-456.
- WILDER, H. H. '08—The Morphology of *Cosmobia*. Am. Journ. Anat., viii, pp. 355-440.

EXPLANATION OF PLATE I.

Fig. A Dorsal view of a cyclopean embryo in almost natural colors. The large antero-ventral eye shows a slight furrow indicating its double nature.

Fig. B The same embryo when the egg is rolled back towards the top of the page. A somewhat ventral view showing the single pupil and lens, the double condition of the eye is only indicated from above.

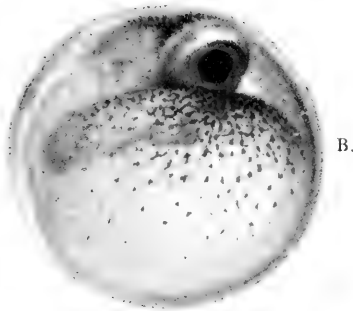

RICHEOLI, *del*



In Figure 32, Plate II, of Miss Stevens's paper on "Further Studies on the Chromosomes of the Coleoptera" (vol. vi, no. 1), one chromosome has been omitted; the figure should appear thus:





STUDIES ON THE PHYSIOLOGY OF REPRODUCTION IN THE DOMESTIC FOWL

I. REGULATION IN THE MORPHOGENETIC ACTIVITY OF THE OVIDUCT¹

BY

RAYMOND PEARL

INTRODUCTION

This paper forms the first in a series in course of preparation in this laboratory, all dealing with various phases of one broad, general problem. It is desirable that at the beginning of such a series a statement should be made outlining the problem under investigation and, in a general way, the standpoint from which it is to be attacked. It is the purpose of this introduction to give such a statement.

When the work of this laboratory was organized one general line of investigation which suggested itself as of first-class importance, both from the theoretical and practical standpoint, was the study of egg production in the domestic fowl. A high average yield of large eggs uniform in size and color is a matter of enormous importance to the poultry industry. How can it be obtained? Can high egg producing capacity be bred into a strain? Can feeding produce it? These are the questions which practical poultrymen in the experiment stations, agricultural colleges, and elsewhere are trying to answer. The zeal for inquiry in these directions is greatly stimulated by the obvious fact that at some time or other during the history of poultry under domestication there has been a very great increase in egg production over what obtains in the wild representatives of the genus *Gallus*. If the thing can be done once, why not again?

¹ Papers from the Biological Laboratory of the Maine Experiment Station, No. 7.

It takes but brief consideration of these economic points to convince one that behind them lies a very broad and complex biological problem, on which light must be obtained before there can be any hope of solving the practical questions. This is the problem of the physiology of reproduction in the hen. Egg production is a definite, if complex, physiological process. In the production and laying of an egg a long series of events are involved; a number of different organs of the body play a part. Before we can hope to control egg production with any precision or certainty it is necessary to learn in detail what is the normal course of events in the production of an egg; how and in what ways each of these events may be modified or influenced by external circumstances; and to what extent each of them is an inherited matter. The physiology of the organs concerned in egg production must be worked out in detail.

In order that a comprehensive idea may be gained of the scope of this problem, let us examine the following skeleton outline of the factors and processes immediately concerned in egg production and the points which must be investigated in attempting to get light on these processes.

I *Physiology of egg production within the individual.*

- A Processes occurring in or relating to the ovary.
 - 1 The development of the egg and its yolk up to the time of ovulation. Resorption of yolk.
 - 2 Ovulation proper. The rupture of the follicle.
 - 3 Fecundity.
- B Processes occurring in the oviduct.
 - 1 Movement of egg to the outside.
 - 2 Formation of albumen.
 - 3 Formation of the several egg membranes.
 - 4 Formation and determination of the shape and color of the shell of the egg.
- C Intra-individual variation and correlations in regard to the points enumerated under A and B. Homotyposis.
- D Behavior in its relation to egg production and reproduction in general.
 - 1 Mating instincts and habits.
 - 2 Brooding instincts and habits.

II *Physiology of egg production within the race.*²

A Variation in egg production.

- 1 Intra-racial
 - 2 Inter-racial
 - 3 Mutation.
 - 4 Seasonal distribution of egg production.
- } in regard to each of the points enumerated under I above.

B Inheritance of egg-producing ability. Considered with reference to each of the points enumerated under I above.

- 1 In pure-bred lines.
- 2 Under hybridization.

C Evolution of egg-producing ability.

- 1 Influence of selection.
- 2 Egg production in the wild progenitors of domestic poultry.
- 3 Fixation of egg producing ability as a racial character.

III *The influence of environmental factors (in the broadest sense) on the processes enumerated above.*

- 1 Nutrition.
- 2 Housing.
- 3 Meteorological factors.
- 4 Drugs.
- 5 Other environmental agents.

IV *The relation of internal factors to, and their influence upon the processes enumerated under I and II.*

V *Pathological and teratological cases relating to egg production.*

This outline, while not as extensive or complete as it might be made, gives a fairly comprehensive view of the general scope of the problem which forms the subject of the present investigation. Each topic in the list suggests, of course, a whole series of problems, but even to enumerate all these would take far more space than is available here. All that is desired at present is that the broad outlines of the general problem on which we are working shall be clear to the reader. On account of the extent of the subject it is necessary to publish the results of the work upon it in a series of separate papers. The skeleton outline given above will serve as a means of coördinating the separate papers, and making clear the

² The general standpoint which regards variation, heredity and other factors of evolution as physiological problems has been well set forth by Jensen ('07) and Jennings ('08).

relation of each to the general problem. Statements and discussions of the subsidiary problems connected with each of the topics in the outline will be given in connection with the detailed treatment of those topics.

In attacking this problem we are bound to no exclusive method of investigation. The observational, experimental and statistical methods will be used as they appear to be demanded by the exigencies of the case. The writer's standpoint is that the problem is one in general physiology, involving questions having to do both with individual and with racial physiology. On a certain number of the points covered in the outline work has been completed and will be published as soon as possible. On other phases of the problem the work is well advanced though not ready for publication.

The present paper deals with a definite and circumscribed topic falling under IB₄ and IC of the outline. It is well known by poultrymen that the first eggs laid by a pullet often differ from the normal eggs and from eggs laid later by the same bird in regard to both size and shape. This implies a process of regulation in the continued activity of the oviduct in shaping successively laid eggs. The present paper deals with the detailed analysis of a clear-cut and unusually pronounced case of such regulatory activity of the oviduct.

THE MORPHOGENETIC ACTIVITY OF THE OVIDUCT

A bird's egg is an object of very characteristic shape. While the form of the egg varies in different species, and also within the single species, all such variation is comprised between relatively narrow limits. The conformation to type in the case of eggs from birds of a single species is in most cases quite close. It is usually still closer in a series of eggs laid by the same bird, as in the case of any of the domesticated fowls. The production of a series of definitely and characteristically formed bodies all conforming closely to a type by an organism implies that the organs concerned in this production have a morphogenetic function along with others.

It is a well established fact that the shape of the egg of any

bird is determined in the oviduct. The yolk as it leaves the ovary is spherical in form, except as it may be deformed through the action of gravity. As it passes down the oviduct it is surrounded by albumen, and finally at the lower end by the so-called "shell" membrane, or *membrana testacea*. It is probable that the egg is not given anything approaching its characteristic form until after the formation of this membrane. As to exactly where and how the egg is given its form by the oviduct there is some difference of opinion and definite evidence is lacking. Szielasko ('05), who has paid particular attention to this problem, after reviewing the older literature of the subject expresses the opinion that the egg is given its definite form in the uterus. He says on this point (p. 289): "Das Gepräge, welches die Eiform der verschiedenen Species aufweist, kann in der Tat, wie Grässner vermutet, nur von dem Uterus verliehen sein; denn solange das Ei im Oviduct verweilt, ist seine Form variabel, da es jeder Umhüllung entbehrt. Die erste Hülle, *membrana testacea* genannt, wird dem Ei erst im untersten Abschnitt des Oviductes unmittelbar vor der Mündung desselben in den Uterus—im sogenannten Isthmus—umgelegt. Auch durch diese Membran wird dem Ei noch keine bestimmte Gestalt gegeben. Diese resultiert erst aus der Umlagerung der harten Kalkschale, welche im Uterus geschieht. Hier ist also das formgebende Organ, hier muss demnach die Untersuchung angreifen."

This was also the early view of the matter. Wahlgren writing in 1871 states as a matter of common opinion that: "Hier (i.e., in the uterus) erhält das Ei seine Schale und seine Form."

The most recent worker in the subject, Thompson ('08), while making the statement (p. 112), "The egg, just prior to the formation of the shell, is, as we have seen, a fluid body, tending to a spherical shape and enclosed with a membrane," which would certainly seem to imply that he supposed the definite shape to be given to the egg in the uterus, proceeds to develop a theory of the method by which the egg gets its form which seems, as he states it, to involve the activity of nearly the whole oviduct in the process.

Direct observation shows that after the *membrana testacea* is formed, and before the egg passes into the uterus, it certainly is

not "a fluid body tending to a spherical shape." On the contrary it has a definite ellipsoidal shape. Is this however in detail the same as the final shape the egg will have after the shell is formed?

The bulk of the evidence at present available would appear to point to the conclusion that while the *general* shape of the egg may be determined before it reaches the uterus the *particular* form of each individual egg is produced in the uterus. Granting this to be the case the further question arises as to the mechanism of this morphogenetic activity of the uterus. There are clearly two possibilities: (a) the uterus may take an active part, shaping the plastic egg, by means of contraction of its muscular wall, or (b) the uterus may play a passive part, acting simply as a mold with more or less elastic walls into which the fluid egg is, as it were, poured. At first thought it might be supposed that the fact that the muscular layer is markedly thicker³ in the uterine wall than in any higher portion of the oviduct could be taken as evidence that muscular activity plays the chief part in the shaping of the egg. This idea loses any force it might otherwise have, however, when it is remembered that the process of expelling the egg demands an extensive muscular development of the uterus wall. Szielasko ('05) has attempted to decide between these alternatives experimentally by injecting fluid under pressure into the uterus from the oviduct end of the organ after previous ligation of the cloacal end. He found that the injected uterus had the form of the egg, and concluded from this that the action of the uterus in shaping the egg is mainly passive and depends simply on the elasticity of its walls. He admits, however, that muscular activity may play some part and in particular (p. 290) points out that muscle action must bring about the closure of the two openings of the uterus while the egg is in that organ. Thompson's theory as to the determination of the form of the egg, without any special discussion of the point, assumes that the muscular activity of the oviduct produces the observed results on the eggs.

From data which have accumulated in this laboratory as well

³Cf. Cushny ('02)

as from a critical examination of the earlier literature of the subject the writer has reached the provisional conclusion that the uterus actively shapes the egg by muscular contractions during and preceding the deposition of the shell, and that it is in this way that the finer and individual form characteristics of eggs are determined. Such a view does not deny that the uterus may and does at the same time act as an elastic walled mold. It is hoped that it will be possible later to get more complete direct physiological evidence on this matter than now exists.

It will of course be recognized that while it is obviously proper to speak of the morphogenetic activity of the oviduct in connection with egg production, the kind of morphogenetic activity here involved is different from that usually implied by the use of this term. The form of the egg is not immediately determined by processes of cell division and differentiation. Instead we are dealing with the formed products of a purely physiological, as distinct from developmental, process. Recognizing this fact it is no less important to investigate cases of such "physiological morphogenesis" (if such an expression is permissible), particularly if, as will be shown in the present paper, it closely parallels or indeed appears to be identical with "developmental morphogenesis" in certain important respects.

REGULATION IN MORPHOGENESIS

By the expression "regulation in morphogenesis" is commonly understood the production by an organism of adaptive or normally formed structures or parts under conditions or from beginnings which are in some degree abnormal or unusual. Regulation is a process of adjustment. In the words of Driesch ('01, p. 92): "Regulation ist ein am lebenden Organismus geschehender Vorgang oder die Aenderung eines solchen Vorgangs, durch welchen oder durch welche eine irgendwie gesetzte Störung seines vorher bestandenen "normalen" Zustandes ganz oder theilweise, direkt oder indirekt, kompensirt und so der "normale" Zustand oder wenigstens eine Annäherung an ihn wieder herbeigeführt wird."

The whole process of normal development of an organism is

obviously in many particulars very like a regulatory process as thus defined by Driesch. This is perhaps more clearly shown than anywhere else in the production of a series of generally "like" parts by an organism. The present writer (Pearl, '07) has made a special study of this process in the case of the plant *Ceratophyllum*. In that paper it is shown that in the development of leaf whorls and of branches, and in fact in the general morphogenetic activity of the plant there is a progressive development of parts towards a definite type. At the beginning of the production of a series of like parts such as leaf whorls, the form of the whorl produced is quite variable and quite different from the type finally established. Viewing the whole series of leaf whorls produced it may be said that the earlier whorls on any plant axis are "abnormal" in the sense that they are quite different from the type which is finally attained. As more leaf whorls are formed they come to conform closer and closer to the type of whorl which is finally produced with great precision and constancy. Now this series of events is in some particulars like a regulatory process. Beginning with the production of something which is "abnormal"⁴ (in the sense that it is different from the finally established type) the organism finally produces the "normal" (i.e., a definite fixed type of structure). In doing this the plant appears in a sense to "profit by experience" in its morphogenetic activity. The form of a whorl produced at any given point on a plant axis is a function in a mathematical sense of the previous developmental history of the plant.

It has been possible in the case of *Ceratophyllum* to work out with a remarkable degree of precision the way in which this approach towards a definite type in the normal ontogenetic development takes place. It was found, whether the character dealt with was leaf production or branch production, that the change as one passed from earlier produced parts towards those finally produced was in accordance with a logarithmic curve. This fact was characterized in the paper cited as the "first law of growth

⁴ It is to be noted, however, that the "abnormality" here is *not* the result of a previous "Störung" as in the case of a true regulation as defined by Driesch (*loc. cit.*)

in *Ceratophyllum*." It was expressed in this way (p. 125): "If we let y stand for number of leaves in the whorl and x denote the position in the series of successively formed whorls, then we find that y is a simple logarithmic function of x as follows:

$$y = A + C \log (x - a)$$

where A , C , and a are constants."

In connection with this work on *Ceratophyllum* it was pointed out that a logarithmic change in growth and development was probably very general for different organisms and different characters. Subsequent studies have served to strengthen this conviction. It is the purpose of this paper to present the results of an investigation of a case of "physiological morphogenesis" which shows in the successive production of a series of "like" structures (eggs) a progressive change from a very abnormal product to a normal one (i.e., a regulatory change *sensu strictu*), this change following a logarithmic law.

DESCRIPTION OF CASE

On January 30, 1908, a barred plymouth rock pullet in the poultry house at the Maine Experiment Station laid her first egg. This egg, because of its strikingly abnormal shape, attracted the attention of the poultryman who brought it to the notice of the writer. The specimen was so remarkable, especially when the fact that it was the first egg ever laid by this bird was taken into consideration, that arrangements were made to have every egg which she laid saved and dated as they were laid. The character of this first egg is indicated in Fig. 1 of Plate I. It will be seen that the egg was strikingly long and narrow and furthermore misshapen in respect to being concave along the sides which are usually convex. This gave the egg an elongated ovate pyriform shape as a whole. When this egg was examined the question at once arose as to whether the succeeding eggs laid by this hen No. 183 would be on the whole like this first egg, or whether they would approach the normal form of eggs in general. If the latter should be found to be the case, how would this change occur? Would

it be a gradual change according to some definite curve, logarithmic or other, or would it be a sudden and entirely irregular change from the abnormal to the normal? To answer these questions the attempt was made to save every egg laid by this bird over a considerable period of time. With the exception of one egg (the 15th laid) every egg laid before July 1, 1908, was preserved. During the period this hen laid 87 eggs.

The appearance of the first 12, and the 18th, 30th, 42d, and 54th of these eggs is shown in Plate I. After the first dozen eggs the change of the egg form was so gradual that it does not seem advisable to take the space to reproduce a photograph of each individual egg. Instead it has been deemed sufficient to take for illustration every 12th egg beginning with the 18th.

The length, maximum breadth and length-breadth-index (100 times the breadth divided by length) of each egg, together with date of laying, are shown in Table I.

From the data of Table I, and the photographs in Plate I the following points are to be noted:

- 1 The first egg laid by hen No. 183 had a greater length, a smaller breadth, and consequently a lower index, than any other egg which she ever laid. Since the abnormality of this hen's egg in general existed chiefly in these dimensions it may be said that the first egg laid deviated more widely from the normal than did any other egg laid by the hen.

- 2 In the eggs successively produced by this hen there is in general a decrease in length and an increase in breadth, leading to an increase in the value of the index. In other words, the eggs laid by this hen become progressively more nearly normal in form with continued production.

FOOTNOTE TO TABLE I

*The measurements of the eggs were made for the most part with a micrometer caliper reading to hundredths of a millimeter, and the dimensions were recorded to the second decimal place. In some instances it was necessary to make the measurements with a caliper reading only to tenths of a millimeter. In all cases in making the divisions for the index the lengths and breadths were used to the total recorded number of decimal places. In preparing Table I length and breadth have been recorded to the nearest tenth. It is possible under these circumstances that the second decimal place in the index may not exactly agree with what is obtained by dividing the tabled breadth $\times 100$ by the tabled length.

TABLE 1
Data Regarding the Eggs of Hen No. 183*

Ordinal number of egg	Date laid 1908	Length mm.	Maximum breadth mm.	Index	Ordinal number of egg	Date laid 1908	Length mm.	Maximum breadth mm.	Index
1.....	I 30	69.3	33.8	48.77	45.....	IV 23	59.2	36.8	62.16
2.....	II 4	66.7	35.1	52.63	46.....	IV 25	58.7	37.0	63.03
3.....	II 6	63.7	35.6	55.89	47.....	IV 26	54.5	37.3	68.44
4.....	II 11	64.5	36.0	55.81	48.....	IV 28	56.6	37.3	65.90
5.....	II 13	61.6	35.9	58.28	49.....	IV 29	56.4	37.5	66.49
6.....	II 15	65.7	35.5	54.03	50.....	IV 30	56.2	37.4	66.55
7.....	II 17	61.1	36.6	59.90	51.....	V 2	58.8	37.3	63.45
8.....	II 19	59.1	36.4	61.59	52.....	V 3	56.3	37.3	66.25
9.....	II 21	63.8	35.2	55.17	53.....	V 5	59.3	37.4	63.07
10.....	II 27	63.9	35.9	56.18	54.....	V 6	53.5	36.8	68.79
11.....	II 28	59.1	35.5	60.07	55.....	V 8	59.8	36.9	61.71
12.....	III 1	60.3	36.6	60.70	56.....	V 9	54.8	37.8	68.98
13.....	III 2	58.6	37.3	63.65	57.....	V 11	62.1	38.1	61.35
14.....	III 3	60.6	37.6	62.05	58.....	V 12	55.7	37.4	67.06
15.....	III 4		egg lost		59.....	V 14	57.9	36.6	63.19
16.....	III 5	62.2	36.2	58.20	60.....	V 16	55.7	37.4	67.02
17.....	III 7	61.8	37.6	60.84	61.....	V 17	55.2	37.6	68.17
18.....	III 8	58.7	37.7	64.22	62.....	V 19	62.9	36.7	58.38
19.....	III 10	60.5	37.5	61.98	63.....	V 20	57.9	38.2	66.06
20.....	III 11	55.8	37.4	67.08	64.....	V 24	59.5	36.7	61.61
21.....	III 13	58.5	37.0	63.21	65.....	V 27	58.9	37.9	64.36
22.....	III 15	59.6	36.8	61.65	66.....	V 28	63.5	37.1	58.39
23.....	III 17	57.1	36.5	63.93	67.....	V 29	55.4	37.6	67.79
24.....	III 19	58.2	36.6	62.91	68.....	V 30	56.1	37.1	66.14
25.....	III 21	56.3	37.0	65.76	69.....	VI 1	61.9	36.4	58.87
26.....	III 22	59.4	36.5	61.43	70.....	VI 2	57.0	38.3	67.16
27.....	III 24	60.5	37.3	61.61	71.....	VI 3	59.4	37.4	62.92
28.....	III 25	58.1	37.7	65.00	72.....	VI 5	57.6	36.4	63.17
29.....	III 27	60.2	37.3	61.91	73.....	VI 6	55.5	37.5	67.48
30.....	III 28	58.7	37.2	63.42	74.....	VI 7	56.6	37.6	66.48
31.....	III 30	58.3	37.4	64.18	75.....	VI 9	58.0	37.3	64.37
32.....	III 31	55.6	37.2	66.91	76.....	VI 10	56.1	38.1	67.81
33.....	IV 3	55.8	36.7	65.77	77.....	VI 12	58.5	37.2	63.62
34.....	IV 5	59.2	37.9	64.02	78.....	VI 14	58.8	36.9	62.66
35.....	IV 6	56.4	37.2	65.96	79.....	VI 15	56.0	37.8	67.44
36.....	IV 8	63.4	35.9	56.62	80.....	VI 17	59.8	36.9	61.70
37.....	IV 10	58.8	36.8	62.59	81.....	VI 19	63.6	36.7	57.69
38.....	IV 12	58.8	37.3	63.76	82.....	VI 20	58.1	37.4	64.27
39.....	IV 13	56.4	36.9	65.42	83.....	VI 22	61.7	37.6	60.88
40.....	IV 15	57.7	36.5	63.26	84.....	VI 23	58.7	38.3	65.24
41.....	IV 16	56.4	37.3	66.13	85.....	VI 25	59.8	37.7	63.02
42.....	IV 18	59.2	37.1	62.67	86.....	VI 27	59.1	37.2	62.91
43.....	IV 19	56.3	37.5	66.61	87.....	VI 28	54.6	37.8	69.24
44.....	IV 21	60.5	36.7	60.66					

3 The progressive change in the dimensions of these eggs is in each case gradual, but not absolutely steady. Instead there are fluctuations up and down in each of the characters studied. These fluctuations appear from mere inspection of Table I to be distributed in a random manner. It will be shown in the next section of the paper that this is in fact the case.

4 No egg after the first shows the pyriform shape due to a concavity of the lateral contour of the egg. The eggs laid after the first are simply elongate ovate in form.

5 After the first 12 eggs had been laid the form of the egg was (barring random fluctuations) very close to the normal. The further progressive change towards the normal was exceedingly gradual.

With regard to the absolute size of these eggs it may be said that they were all noticeably smaller than the average for the breed. The weight of the first egg laid was 37.9 grams. This was the lightest egg ever laid by hen No. 183 so far as is known. The weights of the first 12 eggs laid are shown in Table II.

TABLE II
Weight of the Eggs of Hen No. 183

Ordinal number of egg	Weight in grams	Ordinal number of egg	Weight in grams
1	37.9	7	47.2
2	45.8	8	44.4
3	46.8	9	44.8
4	47.4	10	46.3
5	45.3	11	42.7
6	46.9	12	47.1

From this table it will be seen that the second and succeeding eggs were distinctly heavier than the first egg laid. After the second egg was laid there was no definite change in the weight of the eggs. All the changes that occurred in weight after that time were the chance up and down fluctuations about an average point. There was no definite tendency for the eggs to become heavier or lighter as more were laid. Consequently after some 50 had

been laid the weights of the eggs were no longer taken. There seems to be no particular reason for reproducing here more than the weights of the first dozen eggs shown in Table II. In general it will be seen that all of these eggs were below the average for the breed in size.

WHAT IS THE CHARACTER OF THE PROGRESSIVE CHANGE TOWARDS THE NORMAL IN THE SHAPE OF THESE EGGS ?

In order to answer this question recourse must be had to analytical treatment of the data set forth in Table I. Such analysis may best be begun by exhibiting graphically the changes in the different dimensions of the successively laid eggs. The length and breadth may be considered first. In plotting these dimensions only the first 25 eggs are taken. The reasons for stopping these diagrams at this point are the following: (1) To get the whole 87 eggs into a single text figure involves such a reduced scale as practically to destroy the effectiveness of the diagram for analytical discussion. (2) The dimensions of the eggs after the 25th fluctuate up and down about what is practically a straight line. This being the case it is not necessary in each of the diagrams to carry the line out to the end of the data of Table I.

The lengths of the first 25 eggs are shown graphically in Fig. 1. In this diagram the abscissæ denote the *ordinal position* of the eggs in the whole series laid. The ordinates denote the length of the eggs in millimeters.

From the diagram it appears that:

- 1 The length of the eggs decreases very rapidly in the first 5 laid.
- 2 The rate of decrease in length becomes progressively slower with successive eggs.
- 3 It results in consequence that the line of plotted lengths (disregarding chance fluctuations) is decidedly curved at its beginning, but approximates more and more to a straight line as it proceeds.

The breadths of the first 25 eggs to be laid by hen No. 183 are

shown graphically in Fig. 2. The plan of this diagram is the same as that of Fig. 1.

From this diagram it is apparent that the increase in the breadth of the eggs which occurs with successive laying follows, on the whole, a straight line. The actual observations zigzag up and down, but the underlying steady tendency appears to be for the breadth of the eggs to increase at a slow, but uniform rate, or, in other words, in a straight line. This is in marked contrast to what has been seen for the length.

Turning now to the index ($100 \times \text{breadth} \div \text{length}$) which may be taken as measuring shape we have the discussion of a series of values which have been seen to follow a straight line divided by a dimension which follows a decided curve. It would be expected that the quotient (index) so obtained would exhibit a decided curve when plotted. That this is in fact the case is shown in Plate II, where the zigzag line represents the observed indices of the successively laid eggs. Examining this diagram it is seen that to a more pronounced degree the statements made regarding the change in the length of the eggs apply to the index, if "increase" is in each case substituted for "decrease." The index increases in value very rapidly at first and the *rate* of increase becomes progressively slower with successive eggs. In the case of the index the whole 87 eggs are included in the plotted curve.

Now since the length-breadth index is a better measure of the shape of the egg as a whole than either the length or breadth alone it is desirable to deal with this character in the further analytical study of this case. It was decided to graduate the index curve. Now the shape of the curve, rising sharply at the beginning, curving smoothly and quickly and then running off nearly horizontal, only curving very gradually, suggests at once to the eye that it is a logarithmic curve. Furthermore, previous experience with similar data suggested a logarithmic as the proper curve. Accordingly a curve of the type

$$y = a + bx + c \log x$$

was fitted to the observations, as a first trial. In obtaining the constants of this equation a table of values of $S(\log x)$ $S(\log x)_z$

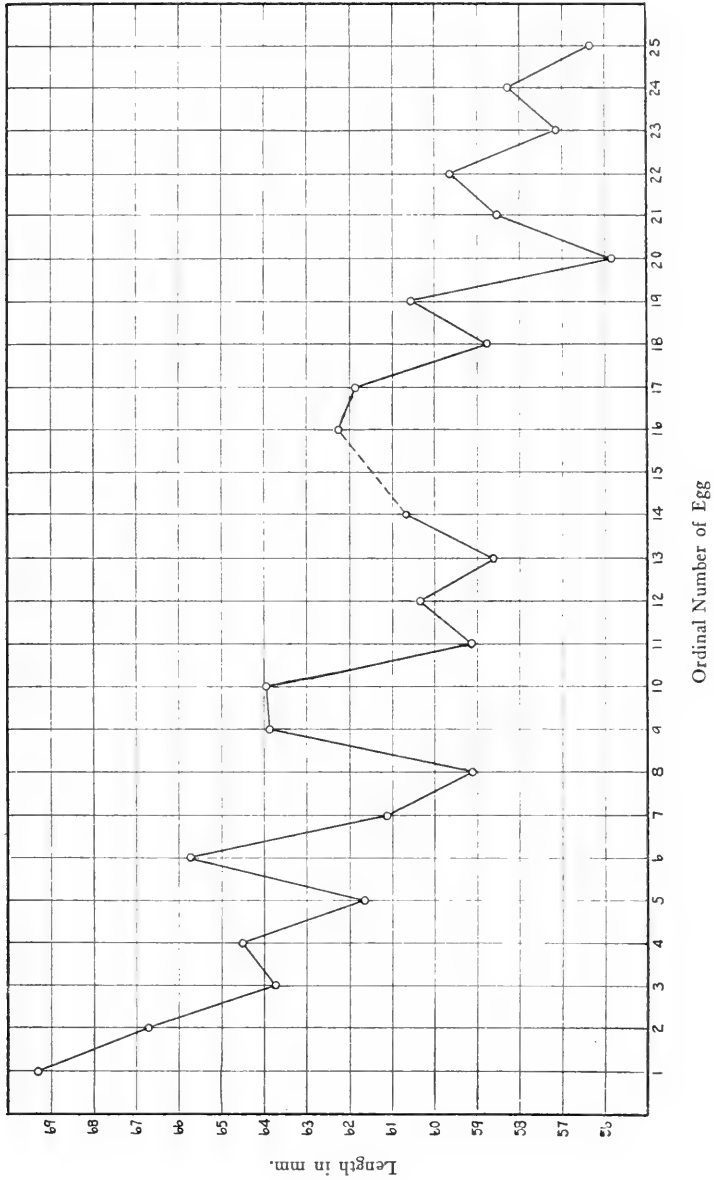

Fig. 1. Length of first 25 eggs laid by hen No. 183

and $S(x \log x)$ calculated in this laboratory⁵ was used with great saving of labor. The resulting curve was

$$y = 49.0241 - .0910 x + 11.7669 \log x$$

where y denotes the length-breadth index and x the ordinal number of the egg in the whole series laid.

Calculating the ordinates of this curve we have the set of values shown graphically by the smooth curve in Plate II.

It is clear that this curve is a wonderfully good graduation of the observations. It is so good, in fact, that it is apparent *that this logarithmic curve is the analytical expression of the manner in which the change in the shape of the eggs of No. 183 occurred.* It is possible now summarily to state the facts regarding the shape of the eggs of hen No. 183 as follows: *The first egg laid by this hen was abnormally long and narrow; the eggs subsequently laid approached more and more to the normal in shape. This change in shape was in accordance with a logarithmic curve of the type*

$$y = a + bx + c \log x$$

wherein y denotes the length-breadth index of the egg, x its ordinal number in the series laid, and a , b and c are constants.

It will be noted that the smooth curve shows a tendency for the index as observed to decrease after reaching a maximum along in the region of the 50th to 60th eggs. The turning downward of the theoretical curve comes about from the fact that the term $.0910 x$ in the equation is negative. This decrease is not to be interpreted as due to any tendency for the eggs to change from the normal towards the abnormal after a number have been laid. On the contrary there is every reason to believe that it is merely a chance result due to ending the observations at the particular point where they were ended. The observation line fluctuates up and down as the result of chance factors. It happened by chance that towards the end of the series the "down" fluctuations predominated to an extent sufficient to change the sign of the line term (x term) in the equation and turn the fitted curve slightly downward. There is

⁵ This table, which is very useful in fitting logarithmic curves to any sort of data by the method of least squares, will shortly be published.

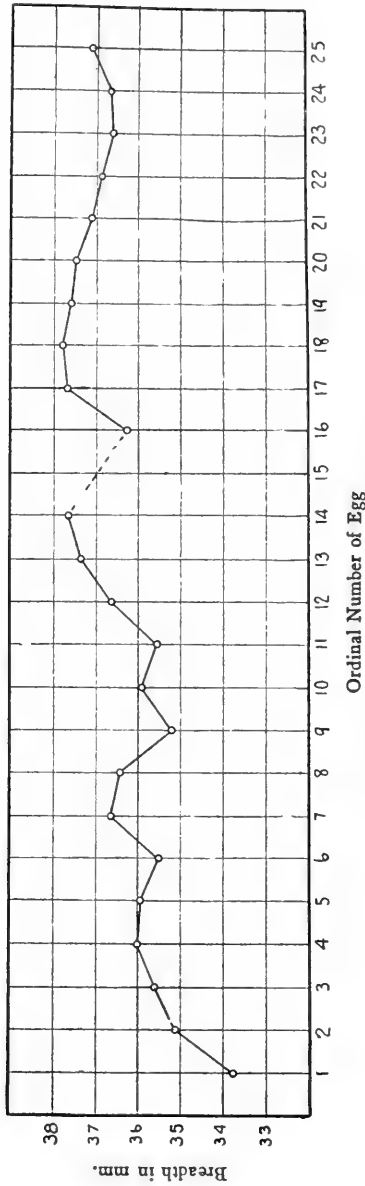

Fig. 2 Breadth of first 25 eggs laid by hen No. 183

no doubt that had the observations been extended to 100 eggs these "down" fluctuations would have been offset by an "up" set, and the theoretical curve would have shown no downward tendency at its upper end. This is indeed directly indicated in the value of the 87th observation. This egg had the highest index of any ever laid by hen No. 183. If the observations had been stopped at 60 eggs the theoretical curve again would not have shown the slight downward tendency at the upper end. That it does show this is simply an accident resulting from ending the observations at a particular point.

DISCUSSION OF RESULTS

The facts which have been set forth above are of interest in connection with two questions, viz: (1) the physiology of the determination of the shape of the egg and (2) the more general question of regulation in morphogenesis.

With regard to the first of these questions there are two features of the present case which lend strong support to the view that the shape of the egg is determined by the *active contractions* of the muscular wall of the uterus. (Cf. p. 6 supra, and Szielasko ('05) p. 289.) These features are: (a) that the eggs laid by this hen were not all alike or even approximately alike. There were great differences in the shape of different eggs. (b) That the shape of the eggs changed in an orderly and progressive fashion (regulation) as they were successively laid. It is hardly conceivable that these two things both could have occurred with the uterus playing simply a passive part and only influencing the shape of the egg through the elasticity of its walls. It might possibly be maintained that the uterus wall became more and more stretched peripherally as more eggs were laid, and that this would account for the thickening and rounding up of the egg in a purely passive way. But if this position is taken one is at a loss to explain the sudden occurrence of a relatively long narrow egg in the middle of a whole series of approximately normal ones. An example of such occurrence is given by egg No. 36, and another by egg No. 62.

The only reasonable conclusion on this point appears to be that

the muscular activity of the walls of the uterus determines the shape of the egg. The results further show that this morphogenetic activity of the oviduct may be of a definitely regulatory character.

Turning to the consideration of the regulation shown in this case the chief point of interest lies in the precise manner in which the regulatory change follows a logarithmic curve. Though the biological processes involved are quite different in the two cases the type of change is exactly the same in the successive production of leaf whorls and branches in the normal ontogenetic development and growth of *Ceratophyllum* (cf. p. 8 supra) and in the successive production of eggs by this hen No. 183 which has been seen to be a regulatory process in the strict sense. The approach from a condition of wide deviation from a final type to that type is in both cases along a logarithmic curve. This means that normal ontogenetic development and growth on the one hand, and regulatory development on the other hand have at least one character or principle in common. This principle may be set forth as follows. Whenever a developmental or growth process follows a logarithmic curve it means that the amount of change which occurs in any given time interval, say between time A and time B, is strictly proportional, either directly or inversely to the total amount of change which has occurred before time A, or, in other words, to the condition in which the organism finds itself at time A. Furthermore, the rate of change is proportional to the time during which the process has continued. Thus to take a concrete illustration, the amount of growth occurring in a time period A to B in an organism exhibiting a logarithmic growth curve is proportional to the size which the organism has already attained at time A. In growth this relation is inverse: the larger the organism (i.e., the more it has grown) at any given time, the smaller will be the growth change in the next subsequent unit time interval. *The longer the process continues and the nearer it comes to its final goal, the slower is the rate of progression towards that goal.* It is of much interest to find both normal ontogenetic and regulatory changes alike in this respect.

In the case of *Ceratophyllum* (Pearl '07) it was found that in

addition to the logarithmic approach of successively formed structures to a type ("first law of growth") there was also a reduction of variability with successive whorl formation ("second law of growth"). Of such a reduction of variability with continued formative activity we find no evidence in the case described in this paper. If such a law obtained in this case it would be expected that the zigzag line in plate II would exhibit progressively smaller and smaller fluctuations up and down about the smooth curve the farther out on that curve one went. The diagram shows that this is not the case. The fluctuations are just as frequent and extensive at the end of the curve as at the beginning. The only difference is that they are about a different mid-point in the upper part of the curve from what they are at the start.

SUMMARY

1 The plan of a comprehensive investigation of the problem of the physiology of reproduction in the domestic fowl is set forth in outline, and a statement is made of the general standpoint from which the problem is being attacked (pp. 339—342.)

2 A description is given of a case in which the first egg laid by a certain pullet was very abnormal in shape. There was a progressive change in the successive eggs laid by this pullet. This change was of a regulatory character, the eggs finally coming to be normal in shape.

3 It is shown that this progressive regulatory change follows a logarithmic curve, and the significance of this fact is discussed.

4 The data obtained in this case are held to warrant the conclusion that the shape of the egg is determined by the muscular activity of the walls of the uterus. 4

LITERATURE CITED

- CUSHNY, A. R.—On the Glands of the Oviduct in the Fowl. *American Journal of Physiology*, vol. vi, pp. xviii and xix.
- DRIESCH, H. '01—Die organischen Regulationen. Vorbereitungen zu einer Theorie des Lebens. Leipzig. (Engelmann), 1901, pp. xv and 228.
- JENNINGS, H. S. '08—Heredity, Variation and Evolution in Protozoa. I. The Fate of New Structural Characters in *Paramecium*, in Connection with the Problem of the Inheritance of Acquired Characters in Unicellular Organisms. *Jour. Exper. Zool.*, vol. v, pp. 577-632, 1908.
- JENSEN, P. '07—Organische Zweckmässigkeit, Entwicklung und Vererbung vom Standpunkt der Physiologie. Jena, 1907. 251 pp.
- PEARL, R. '07 (with the assistance of O. M. Pepper and F. J. Hagle)—Variation and Differentiation in *Ceratophyllum*. Carnegie Institution of Washington. Publ. no. 58, 1907.
- SZIELASKO, A. '02—Die Bildungsgesetze der Vogeleier bezüglich ihrer Gestalt. Gera-Untermhaus, 1902.
- SZIELASKO, A. '05—Die Gestalt der Vogeleier. *Journ. f. Ornithol.* Jahrg. 53, pp. 273-297, 1905.
- THOMPSON, D'ARCY W. '08—On the Shape of Eggs and the Causes which Determine Them. *Nature*, vol. lxxviii, no. 2014, pp. 111-113, 1908.
- WAHLGREN, FR. '71-'72—Ein Ei im Ei. *Journ. f. Ornithol.*, Jahrg. 1871-72, pp. 260-265.

EXPLANATION OF PLATES

PLATE I

Shows photographs of the first 12, the 18th, 30th, 42d and 54th eggs laid by hen No. 183. The order of arrangement of the eggs on the plate is shown in the following scheme.

		<i>Top</i>				
	1	2	3	4		
<i>Left</i>	5	6	7	8	<i>Right</i>	
	9	10	11	12		
	18	30	42	54		
		<i>Bottom</i>				

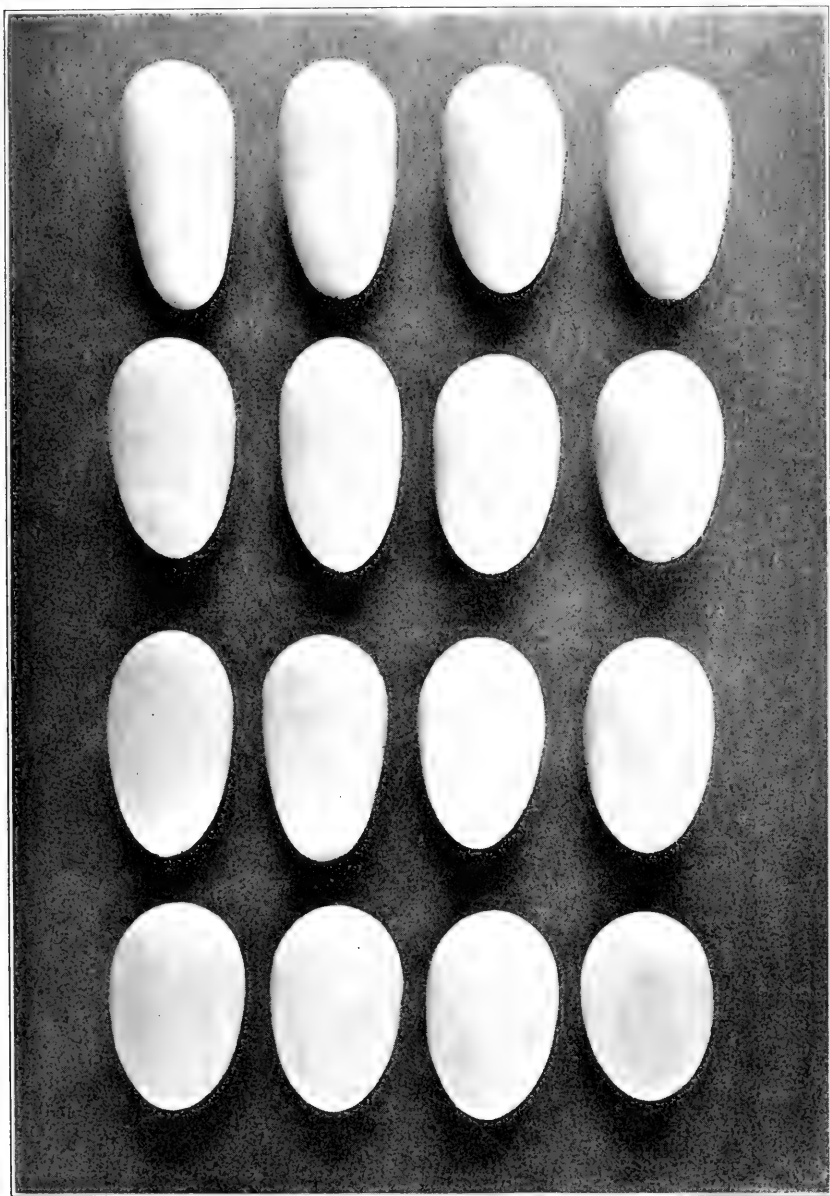
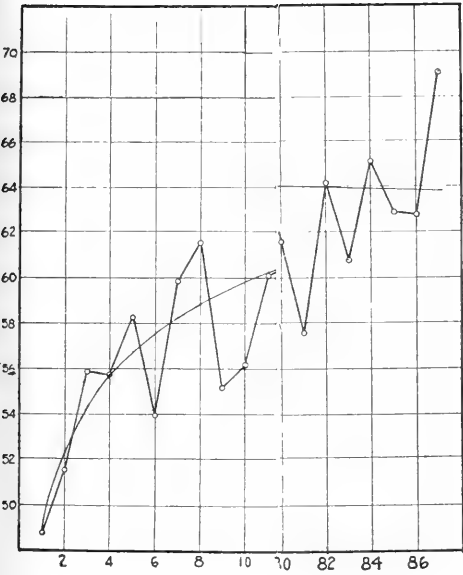

PLATE II

Diagram showing the observed change in the length-breadth index (100 breadth + length) of the first 87 eggs laid by hen No. 183. The zigzag line gives the observations and the smooth curve the graph of a curve of type

$$y = A + Bx + C \log x$$

fitted to the observations by the method of least squares.



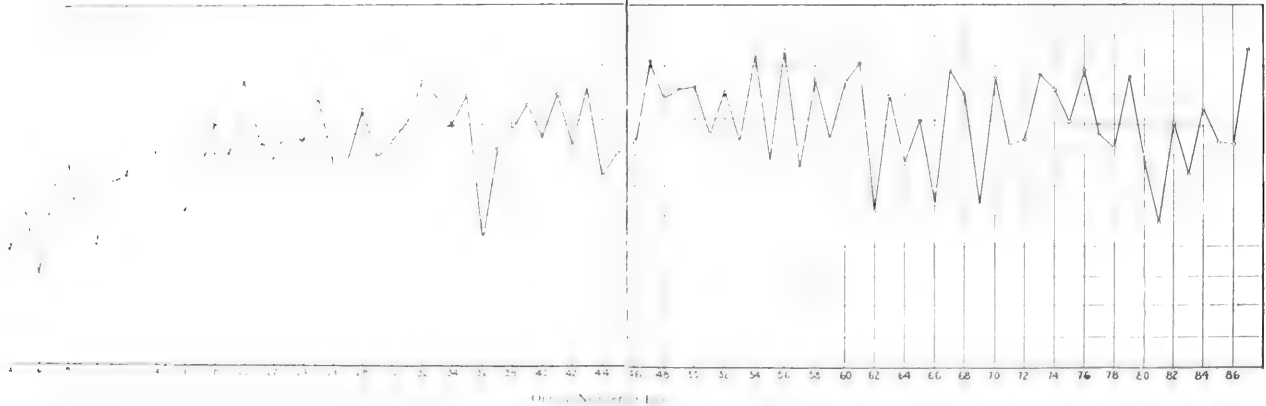

THE PHYSIOLOGY OF NEMATOCYSTS¹

BY

O. C. GLASER AND C. M. SPARROW

I	Introduction.....	361
II	Material and methods.....	362
III	Experiments with Montagua.....	364
IV	Experiments with the tentacles and acontia of Metridium.....	366
V	Experiments with isolated nematocysts.....	368
	Mechanical pressure.....	369
	Uniform external pressure.....	369
	Solutions.....	369
	Hypertonic Solutions.....	372
	Negative external pressure.....	372
	Heat.....	373
	Alternating current.....	373
VI	Rate of explosion.....	374
VII	Variations in the explosive pressure.....	374
VIII	Application of the osmotic theory to Eolids and Coelenterates.....	375
IX	The physiological effects of nematocysts on other organisms.....	378
X	Summary.....	380
XI	Literature.....	382

INTRODUCTION

Grosvenor ('03) has given a brief review of the different theories which have been invented to explain the discharge of nematocysts, and has himself proposed a view which in the present state of our knowledge seems the only one worth careful consideration. Grosvenor's theory is that the discharge of nematocysts in Coelenterates, and in those animals which derive their nematocysts from them, is brought about by osmotic pressure. His evidence is as follows: Cerata of Eolis immersed in Calberla's fluid, extrude large numbers of undischarged nematocysts. If the fluid is diluted with sea-water, the threads of the capsules are everted. Similar results were obtained when cerata were plunged into "fairly

¹ Contribution from the Zoölogical Laboratory of the University of Michigan, No. 122.

strong" solutions of sugar or salt. Here too the nematocysts were not discharged, but when the preparations were subsequently washed out with distilled water, the nematocysts exploded. Grosvenor also experimented with the tentacles of actinians. When these were plucked off, and quickly thrust into a 50 per cent solution of sugar, and teased into small fragments, though many discharged nematocysts were found, pieces in which none had discharged were common enough. Such fragments were isolated and kept for from 24 to 72 hours. The nematocysts remained undischarged until the sugar solution was washed out with water, when approximately 20 per cent of the capsules discharged themselves.

"These facts," says Grosvenor, "seem to show that the discharge of nematocysts is due to osmosis. The capsule apparently contains a solution of such strength that it takes up water from such a weak solution as sea water, but not from the protoplasm of the nematocytes, or the fluids in the alimentary canal of *Æolids*, or from any of the other solutions mentioned above."

Our interest in the history of the nematocysts of *Æolids*, ('02;06) led us in the summer of 1908, to undertake a careful investigation of this subject. The work was begun by the Senior author in the Zoölogical Laboratory of the University of Michigan, and was brought to a practical completion in the Marine Biological Laboratory at Woods Hole. To the Director, Prof. F. R. Lillie, we are indebted for the use of a room in the laboratory.

MATERIAL AND METHODS

The material used for the experiments and for the development of methods consisted of *Hydra*, *Metridium*, *Physalia*, and *Montagua*. Experiments were made with the nematocyst bearing tissues of these animals, and also with the isolated stinging capsules. The methods used for isolating them were peptic and auto-digestion at 35° C., and maceration in sea-water to which crystals of chloretone had been added. In the case of the peptic digestions, all the tissues except the nematocysts, were dissolved in a solution composed of 4 cc. HCl; 1000 cc. H₂O Dist.; and

10 gr. flaked pepsin. The digestive processes took place quite rapidly, in some instances being complete within 24 hours. The solutions were then centrifugated, and there was obtained a thick sediment, composed, in the case of *Physalia* especially, of countless isolated, undischarged nematocysts. Many discharged ones also were found, but these formed a minority. The same methods were employed in the case of the auto-digestion.

Experiments to be described later, showed that although these methods are adequate, the nematocysts are changed in certain ways by these processes, and we therefore resorted to the maceration method referred to. For this purpose the acontial filaments of *Metridium* were found extremely good as they are composed of immense numbers of nematocysts held together by a minimum of other tissues. In sea-water to which crystals of chloretone are added slowly from time to time for a period of about 12 hours, the acontia break down, forming a somewhat glutinous mixture in which free undischarged nematocysts occur in great abundance. These were in excellent condition for some of the purposes for which we used them.

In order to store nematocysts for later use, and this was necessary as we secured only one specimen of *Physalia*, and that early in the summer, we desiccated some of the sediment secured from the centrifuge, preserved some in glycerine, some in sea-water, and some in salt solutions of various concentrations. Under these circumstances the material keeps perfectly well, and can later be used for experimental work.

During the course of the experiments carried out at Wood's Hole it became desirable on several occasions to separate the discharged from the undischarged nematocysts, and also to isolate individual capsules. The former was accomplished in two ways, sometimes by means of what might be called a "capillary filter," the discharged nematocysts failing to be drawn up into a capillary tube just large enough to admit undischarged ones; sometimes by taking advantage of the somewhat lighter specific gravity of the exploded capsules. In a dish containing both discharged and undischarged nematocysts, the former come to lie above the latter and may be completely removed by means of a small glass hook.

Isolation of individual capsules, whenever desirable, was accomplished by means of a capillary tube filled with a suspension of nematocysts. By spreading, from the mouth of such a tube, small drops on a glass slide the nematocysts may be distributed so that each drop contains only a few, or perhaps only one. The drops can then be numbered, and the history of the individual nematocysts followed for any desired length of time. A moist chamber was frequently used to prevent the drops from drying.

EXPERIMENTS WITH MONTAGUA

The nematocysts of *Montagua* are derived from its prey, *Tubularia crocea*. The details in this transfer, are being reserved for another paper. For the present purpose it is necessary to know only that these derived nematocysts are stored by certain entodermal cells, the cnidophages, inside the cnidophores of the dorsal cerata, and that when each storage cell has engulfed a certain number it loses its cellular characters and becomes converted, possibly with the assistance of certain neighboring interstitial cells, into a thin transparent bag, the cnidocyst. These loaded cnidocysts lose their connection with the basement membrane to which in earlier stages they are attached, and come to lie free in the lumen of the cnidophore in the distal end of the appendage.

Under certain circumstances the elimination of cnidocysts filled with stinging capsules may be observed under the microscope. If the animal is stimulated mechanically, chemically, or best of all thermally, the extrusion of the cnidocysts takes place. They are shot out of the cnidopores at the tips of the dorsal cerata, not by violent contractions on the part of these appendages, but by unobservable contractions probably of the musculature of the cnidophore. Relaxation of this musculature immediately around the cnidopore is either incomplete, or if complete, is not great enough to allow the easy passage of the cnidocysts. These, while elimination is going on, are often much distorted, but as soon as the pressure from the walls of the cnidopore is relieved, they become spherical. At times they make their appearance as clear bubbles blown by the cnidopore, and they may remain in this condition

until they have been almost completely extruded, when the nematocysts begin to shoot into the visible portion, either one by one, or in groups. When this has happened, the cnidocysts leave their positions at the mouth of the cnidopore, usually on account of the movements of the animal or of its appendages, and may float freely in the water nearby, or may remain adhering to other regions of the ceras.

The nematocysts so extruded, in many instances discharge inside of their enclosures and as their threads penetrate through the wall of the cnidocyst, this may come to resemble a "sperm-bundle," with filaments radiating in all directions. Ultimately the cysts burst, and set free their discharged contents. This, however, is not the usual history—ordinarily the bursting of the cnidocyst and the explosion of its nematocysts take place at the same instant. The questions therefore arise: Why do the cnidocysts burst, and why do the nematocysts discharge? There are involved no living tissues which might be responsible; the nematocysts are not living things, and their enclosing cnidocysts are also dead.

A simple experiment gives the answers. If *Montagua* is stimulated thermally in a concentrated sugar solution, the elimination of cnidocysts takes place as described, only as soon as they come into contact with the surrounding medium they shrivel. None of the cysts burst, and none of the nematocysts discharge. If now the sugar solution is replaced by distilled water, the cnidocysts swell and burst, and the nematocysts discharge. Discharge, however, is rarely complete; a few nematocysts in every collection of them fail to discharge under circumstances under which the majority explode.

If this experiment is modified, and the elimination is forced to occur in distilled water, the bursting of the cnidocysts and the discharge of the nematocysts take place so quickly, that it is impossible to be more than aware of the processes. Even under these conditions some nematocysts may remain undischarged.

The most plausible explanation of these results is that the bursting of the cnidocysts, and the discharge of the nematocysts are due to absorption of water; that introduction into a medium of higher osmotic pressure than the contents of either the cnidocyst,

or the nematocysts, results in the abstraction of water, and that for this reason, the former shrivel and the latter remain intact. Why some of the nematocysts fail to discharge when the majority explode, will be discussed in connection with later experiments.

EXPERIMENTS WITH THE TENTACLES AND ACONTIA OF METRIDIDIUM

The results of Grosvenor, and those just described, lend strong support to the idea that the discharge of nematocysts is due to osmosis, and while none of our experiments seem to indicate that this idea is erroneous, the study of the living tentacles and acontia of *Metridium*, shows that the matter is not quite as simple as might be supposed. In nematocyst-bearing tissues, another factor must be reckoned with, the living nematocyte, the cell which makes the nematocyst and encloses it.

The living tentacles, as well as the acontia of *Metridium* may be removed without discharging the nematocysts; this can be done very easily in the case of the tentacles, not quite so easily with the acontia, but even in this instance, an abundance of intact threads or pieces of threads, is readily obtained. These can then be treated in various ways, and the behavior of the nematocysts studied.

In certain media, many of the nematocysts leave their natural positions in the mother tissue, but do not discharge; media of much higher osmotic pressure than sea water, may bring about discharge, and heat, electricity and mechanical pressure are effective. At first sight these results seem to be strongly antagonistic to the osmotic theory, but careful analysis of them, either changes all of these data into positive supports or at least disarms them.

In the following table is given a résumé of the details of the experiments on the effects of various media and stimuli on living nematocyst-bearing tissues. The material used is mentioned in the first column; the treatment given it, in the second; whereas the effects on the nematocysts are recorded in the third and fourth columns. The word extrusions is used to designate those instances in which nematocysts, without exploding, left their normal positions in the mother tissue. Such extrusions are due either to

a breaking down of the surface of the tentacles or acontia when exposed to certain media, or in some cases to contraction. All of the experiments were repeated several times, and some, many times, so that the reports are based on the behavior of thousands of nematocysts.

Material used	Treatment	Extrusions	Explosions
Metridium tentacles.....	sea-water	none	none
acontia.....	sea-water	none	none
tentacles.....	distilled water	many	many
acontia.....	distilled water	many	many
tentacles.....	saturated sugar solution	none	none
acontia.....	saturated sugar solution	none	none
tentacles.....	idem followed by H ₂ O dist.	many	few
acontia.....	idem followed by H ₂ O dist.	all	none
tentacles.....	saturated sodium chlorid	many	many
acontia.....	saturated sodium chlorid	few	many
tentacles.....	Kleinenberg's picro-sulfuric	few	many
acontia.....	Kleinenberg's picro-sulfuric	none	all
tentacles.....	sublimate-acetic	few	many
acontia.....	sublimate-acetic	none	all
tentacles.....	saturated mercury bichlorid	none	none
acontia.....	saturated mercury bichlorid	none	none
tentacles.....	acetic acid	many	many
acontia.....	acetic acid	none	all
tentacles.....	hydrochloric acid	few	many
acontia.....	hydrochloric acid	none	many
tentacles.....	ammonium hydroxid	few	many
acontia.....	ammonium hydroxid	none	all
tentacles.....	95 per cent alcohol	none	many
acontia.....	95 per cent alcohol	many	many
tentacles.....	chloroform	none	many
acontia.....	chloroform	none	many
tentacles.....	ether	none	many
acontia.....	ether	many	many
tentacles.....	chloretone	none	many
acontia.....	chloretone	many	many
tentacles.....	mechanical pressure	many	many
acontia.....	mechanical pressure	many	many
tentacles.....	heat 100° C.	many	many
acontia.....	heat 100° C.	many	many
tentacles.....	heat 0° C.	none	none
acontia.....	heat 0° C.	none	none
tentacles.....	alternating current	many	many
acontia.....	alternating current	none	all

It is not necessary to give a detailed analysis of the experiments summarized in Table I. In general they indicate that specific chemical effects are not involved, and further that any theory which attempts to explain the discharge of nematocysts, must take account of the nematocyte. This particular phase of the subject, however, can be more profitably discussed after the experiments on isolated nematocysts have been reported. These also will explain some of the above results which at first sight may appear puzzling.

EXPERIMENTS WITH ISOLATED NEMATOCYSTS

A nematocyst is a membranous capsule, one portion of which is prolonged into a thread, ending in a point. In its undischarged state, this thread is introverted, and is stored inside the capsule of which it is an organic part. In addition to the visible filament, the capsule contains certain invisible chemical substances.

On the basis of this knowledge, we may make certain assumptions regarding the causes that bring about eversion of the thread, and these assumed causes can then be tested experimentally. We may assume that in order to bring about discharge, it is necessary to raise the internal pressure of the capsule to a point at which it can overcome the effect due to the uniform external pressure to which the capsule is subject, plus whatever resistance to eversion is offered by the construction of the capsule itself. We may assume further, that the capsule is a membrane, semi-permeable to aqueous solutions, and that it contains substances capable of absorbing water. We may assume also that the membrane is specifically permeable to certain ions, although, if the results of the experiments can be explained without this assumption, postulation of specific permeability becomes unnecessary.

These assumptions were tested experimentally. The results which have been actually obtained appear to be explicable by any one, or any probable combination, of the following factors: increase of internal pressure; decrease of external pressure; reduction in the resistance to eversion due to the construction of the capsule.

Mechanical Pressure

The effect of mechanical distorting pressure was studied by mixing the nematocysts of *Physalia* or the tentacles of *Metridium* with granulated salt and grinding the material between glass plates. Sometimes the salt was omitted, and ground glass plates were used. After treatment in this manner, the nematocysts were examined. In those cases in which salt was used, this was dissolved before observations on the results of the treatment could be attempted. In this way a considerable mechanical distorting pressure was applied to the individual capsules, and though the nematocysts of *Metridium*, on account of their minute size and their delicacy, gave inconclusive results, those of *Physalia* gave very positive ones. Many partial discharges were obtained. Pressure on the cover glass of a preparation of *Physalia* nettles also causes many partial discharges. Such pressure as was used in these experiments distorts the capsules, and is effective because the internal pressure of the nematocysts is raised by distortion.

Uniform External Pressure

That the effects of distorting pressure have been correctly interpreted, is clearly shown by the effect of high uniform external pressure. Such pressure was applied by allowing the nematocysts to be drawn up into a capillary tube provided at one end with a reservoir filled with mercury. The open end of the tube was then sealed and the mercury made to expand.

The pressure obtained in this manner, calculated from the contraction of the air bubble inside the tube, and from the bursting strength of the tube, was from 50 to 100 atmospheres. No nematocysts ever discharged when treated in this way.

Solutions

In Table II are presented in condensed form the results of experiments undertaken to discover the effects on isolated nematocysts of the same solutions which had previously been employed on the living tentacles and acontia of *Metridium*. The isolated

nematocysts of *Physalia* were not used in this series of experiments for reasons which will become clear later—all the results presented in this section are based on isolated *Metridium* nematocysts secured by the maceration method.

TABLE II

Solution	Effect
Sea water.....	none
Distilled water.....	complete instantaneous discharge
Saturated sugar solution.....	none
Idem followed by H ₂ O dist.....	partial and slow discharge
Saturated sodium chlorid.....	none
“ strontium chlorid.....	none
“ zinc sulfate.....	none
“ magnesium sulfate.....	none
“ sodium carbonate.....	none
“ potassium carbonate.....	none
Kleinenberg's picro-sulfuric.....	complete instantaneous discharge
Sublimate acetic.....	complete instantaneous discharge
Saturated mercury bichlorid.....	none
Acetic acid.....	complete instantaneous discharge
Hydrochloric acid.....	complete instantaneous discharge
Ammonium hydroxid.....	complete instantaneous discharge
95 per cent alcohol.....	none
Chloroform.....	none
Ether.....	doubtful
Chloretone.....	none

In every case, except that of sea-water, dilution occurred when the reagents listed above were brought into the fluid of the suspensions. The error due to this, however, is of no consequence in the present connection. With one or two exceptions, to be discussed later, the same solutions, effective in bringing about the discharge of nematocysts within their mother cells, are capable of causing the same effects when the nematocysts are isolated.

An examination of the table shows that these results give strong support to the osmotic theory. The positive effects of distilled water, of dilute acids, such as Kleinenberg's picro-sulfuric, and sublimate acetic, and the negative results from the use of the saturated solutions of sugar, and of sodium, strontium, magnesium,

and potassium and mercury salts, are all to be expected. Some of the other results, however, require a word of comment.

Alcohol, ether, even if effective, chloroform and chloretone, used because employed in the previous experiments on living tentacles and acontia, bear neither way on the osmotic theory. The action of strong acids and of ammonia remain to be explained. Acids are chemically very active, and it is conceivable that upon penetration into the nematocyst they affect a decomposition of the intracapsular contents, thus increasing the number of molecules present, and hence the internal pressure. Since the H ion is the active one, it is possible that the membrane is specifically permeable to it.

The effect of acids, however, may be explained in the same way as the action of ammonia. The latter is effective possibly on account of its power of disintegrating tissues. If the capsule is weakened at the point where the thread is introverted—a point normally weak—eversion is likely to occur, for as will be shown later, the capsular contents themselves exert a high pressure.

The effect of distilled water on nematocysts which have been treated with a saturated solution of sugar, is due to the fact that sugar probably “gums up” the pores of the capsules. Other agents do the same thing, and it is for this reason that the *Physalia* material was not used, although in the course of time it would probably have given the same results. This is indicated by the following observations.

In suspensions made in distilled water, from desiccated *Physalia* nematocysts, as well as from those preserved in glycerine, it was noticed that the older the suspension, the greater the number of completely discharged nematocysts. This increase was so great that in the course of several days the exploded ones began to outnumber those intact. This phenomenon pointed to slow osmotic interchange between the capsular contents and the surrounding medium. Grosvenor, in dealing with pieces of actinian tentacle teased up in a half concentrated sugar solution, found, when the sugar is washed out with distilled water, that “never more than approximately 20 per cent” of the nematocysts discharge themselves. Had he waited, he would no doubt have

found the percentages much higher. The results obtained from the macerated material, in which discharge was complete, and also instantaneous, show that media, such as glycerine, and sugar solutions, either clog the pores, and make diffusion a slow process, or else make the eversion of the thread so difficult that a higher pressure than the normal one is needed to bring about explosion. Both of these causes might be operative together, and, in addition, it must be remembered that the digestive processes in themselves might have the effects suggested, and might also alter the constitution of the intracapsular contents.

Hypertonic Solutions

If the results already described support the osmotic theory, the effect of hypertonic solutions completely demonstrates its correctness. Not only do nematocysts fail to explode in such solutions (Table II) but if left in them for a number of days, they can be made to discharge in media too concentrated to bring about the explosion of normal nematocysts. These results, which will be referred to again in another connection, can be explained only on the assumption that by slow transfusion the intracapsular contents are so changed by the hypertonic solutions, that the nematocysts become able to absorb water from media more concentrated than those toward which they are normally osmotically neutral.

Negative External Pressure

If the explosion of nematocysts is due to pressure from within outward, as the osmotic theory requires, and as the effects of distorting pressure seem to indicate is true, it follows that a negative external pressure might result in explosion, particularly if, as is conceivable, the capsules are in a state of tension. Negative pressure of one atmosphere, produced by suction, gave entirely negative results. This failure, however, is not traceable to a mistake in principle, but to the insufficiency of the negative pressure. The osmotic pressure of sea-water is in the neighborhood of 22 atmospheres (Garrey '04), and as will be shown later, the pres-

sure of the intracapsular fluid must be about the same. It was found that at ordinary temperatures, practically all of the nematocysts discharged in a solution of 70 per cent distilled and 30 per cent sea-water, whereas practically no explosion occurred in a mixture of 60 per cent sea-water and 40 per cent distilled. Since this latter dilution gives $\frac{4.0}{1.00} \times 22$, or 9 atmospheres as the minimum pressure required to bring about explosion, it is easy to see why a simple vacuum proved wholly inadequate.

Heat

Low temperatures hinder discharge, and make it necessary to employ solutions of much greater dilution than are needed at ordinary temperatures. High temperatures on the other hand greatly facilitate discharge, and make it possible to explode nematocysts in media more concentrated than sea-water. These effects in all probability are due to a combination of factors.

In the case of low temperatures, the capsule probably contracts, and thus renders more difficult, not only the absorption of water, but the actual extrusion of the thread through the narrow opening out of which it must be everted. The increase in the viscosity of the medium due to the lowering of the temperature is also a considerable quantity. When dealing with high temperatures on the other hand, the viscosity of the surrounding medium is reduced; the expansion of the capsule not only makes absorption easier, but also the actual process of eversion; further the pressure within the capsules must be raised, partly on account of the increased speed of the molecules in the intracapsular fluid, partly on account of an actual increase in the number of molecules present, for Portier and Richet ('02) have shown that the hypnotoxin breaks down at 55° C.

Alternating Current

Although capable of causing the discharge of nematocysts imbedded in their living mother tissues, when applied to the isolated capsules the alternating current proved ineffective. The result is explained by the fact that an alternating current is inca-

pable of changing the concentration of the solution through which it passes, on account of the compensatory effect of the rapid reversals in direction.

RATE OF EXPLOSION

The fact that the rate at which explosion takes place may be greatly modified by treating the capsules with glycerine and sugar, suggested the possibility of controlling the eversion of the thread in other ways. If the osmotic conception is correct, a moderate increase in the concentration of a solution should reduce the speed of the discharge, and a great increase should prevent explosion altogether. Both of these effects were obtained, though under influence of heat, the capsules continued to discharge in media too concentrated to allow explosion at ordinary temperature.

The reduction in the speed obtained by the use of concentrated sea-water, and other media of high osmotic pressure, made possible certain observations on the eversion of the thread which are in complete harmony with the osmotic theory. In such media, when the dilution is just sufficient to bring about explosion, one can see that during the process of eversion, the thread is cast out suddenly, but only to about two-thirds its length. A brief period—less than a second often—of inactivity, due no doubt to the immediate relief of pressure, ensues, and then the remainder of the thread is everted. To observe this effect one must use a medium only a trifle less concentrated than that from which the nematocysts were taken.

VARIATIONS IN THE EXPLOSIVE PRESSURE

In practically all of the experiments on isolated nematocysts, it was noticed that not all of the threads are everted under circumstances under which most of the capsules explode. At certain concentrations no explosions occur; if the solution is diluted, a few incomplete or slow discharges occur; further dilution increases both the number and the rate of the discharges, and finally a point is reached at which the great majority explode. Even here, however, a few remain unaffected unless the medium is

diluted still further. It follows from this that the pressure necessary to explode nematocysts instantaneously varies with the individual capsule, and as these differences occur in nematocysts prepared by the digestion as well as the maceration methods, it is safe to conclude that the observed facts are normal.

It is conceivable that the porosity of the capsular wall may vary with its age, or may vary independently of this, and the same thing is true of the intracapsular contents. Either of these possibilities would account for the facts. It is also true that other slight differences in the construction of the capsules might affect the pressure needed to explode them, and possibly also, not all of them are in equally good working order. In the eversion of a barbed thread, like that characteristic of the nematocysts of *Meridium*, it would seem that there is ample opportunity for entanglements, capable of being loosened or broken only by increased pressure from within.

APPLICATIONS OF THE OSMOTIC THEORY TO ÆOLIDS AND
CŒLENTERATES

Æolids

The experiments described can leave no doubt that osmotic pressure can account for all of the observed facts. The question now arises, why do the nematocysts of nudibranchs discharge on coming into contact with sea-water, whereas those of cœlenterates remain intact?

While enclosed within their mother cells in the cœlenterate, the nematocysts must be osmotically neutral toward their cellular environment, and since they themselves are neutral toward sea-water, it follows that we must consider the nematocyte also osmotically neutral toward its external environment. This neutrality must be disturbed by the sojourn of the nematocysts within the bodies of the nudibranchs, or some other factor must enter to counteract it. After careful consideration of the possibilities that suggest themselves, we have discarded all but one: by slow trans- fusion, the contents of a nematocyst osmotically neutral toward

sea-water, may be changed, so that it becomes capable of absorbing water, and consequently of raising its internal pressure to the exploding point. To test this idea, isolated nematocysts of *Metridium* were treated with a saturated salt solution for four days. After this time sea-water, which is osmotically neutral toward freshly isolated nematocysts, was as effective in bringing about discharge as distilled water is when applied to unmodified capsules.

Cœlenterates

A comparison of the results obtained from isolated nematocysts, and from those imbedded in their living mother tissues, suggests that the explanations which hold good for the former class hold equally good for the latter; that in the one case we are dealing with an osmotic interchange directly between the capsule and its surrounding medium; in the other case between the nematocyte and the medium, and that the permeability of the cell to the various reagents used, is such that for practical purposes the nematocyte is non-existent. It must be apparent that in most cases it is impossible to show that this, as a generalization, is incorrect, nevertheless, we believe that it is incorrect, and that the nematocyte, the mother cell of the nematocyst, has something to do with its discharge, possibly not under all circumstances (see Tables I and II) but certainly under some, and perhaps always when the nematocyst is discharged in response to stimuli normal in the lives of cœlenterates.

The efficacy of the nematocyte as a factor in the normal discharge of a nematocyst can be shown in at least three ways. A saturated solution of sodium chlorid is incapable of bringing about the explosion of isolated nematocysts. This, however, is not true when the same solution is applied to the living tentacles and acontia of *Metridium*. (Table I.) Under this treatment a complete discharge of all the nematocysts occurs. The alternating current, when applied to isolated nematocysts, is ineffective, but when applied to fresh tentacles and acontia, it brings about the discharge of all the nematocysts present.

These two experiments suggest that the cell is effective, and that

the reason why the nematocysts explode under the conditions named, is because the nematocyte is stimulated to do something which brings about discharge. The correctness of this inference can be established, if without destruction, the nematocyte can be eliminated from possible participation in the chain of events. This can be done by narcotization. The most effective agent to use, if used with moderation and care, is chloretone. If the tentacles and acontia of *Metridium* are narcotized with chloretone, saturated sodium chlorid, 95 per cent alcohol, and chloroform, all of which act as stimuli under normal conditions, do so no longer, and the nematocysts enclosed by their anesthetized mother cells fail to explode. These results seem to point conclusively toward the nematocyte as a factor in the normal discharge of a nematocyst, and this in spite of the fact that distilled water, Klein-berg's picro-sulfuric acid, sublimate acetic, acetic acid, ammonium hydrate, and ether, are as effective on narcotized material as on normal. All of these liquids are highly penetrating, or contain very penetrating elements, or have specific gravities, so little above that of distilled water, that they act under all circumstances, as though the mother tissues, normal or narcotized, were not there. Heat also is effective when applied to narcotized nematocytes, either because the nematocysts under its influence absorb water, or because their contents break down (p. 373.). In addition to the explanations suggested, it is possible that a nematocyte narcotized sufficiently to be unresponsive to certain stimuli, it is not necessarily sufficiently under anesthesia to render all stimuli ineffective.

Why then do the nematocysts of *Cœlenterates* explode under normal conditions? Since they are completely enclosed by the fluid contents of the nematocytes, contraction on the part of these cannot be effective, since a uniform external pressure, no matter how high it may be, is incapable of causing discharge. The possibility of a distorting pressure produced by the nematocyte is not absolutely ruled out, though we know of no mechanism by which it might be produced. Appeal to undiscovered cytoplasmic fibrillæ might be made, but with little profit. The osmotic theory on the other hand can be applied here also even if direct evidence is still wanting.

In making an application of the osmotic theory two possible factors suggest themselves, and these, operative singly or together, will account for the facts. It is conceivable that when stimulated, the nematocyte suddenly generates heat; it is also conceivable that the cytoplasm around the nematocyst undergoes chemical and physical changes of such a nature that the capsules are enabled to absorb water, and to raise their internal pressures to the exploding point. Particularly if heat is liberated at the same time that "dilutation" occurs, this theory offers no insurmountable difficulties. The time element need not be considered, for the chemical and physical changes which stimulation sets up in a muscle occur very quickly, and when the proper reduction in the concentration of the surrounding medium has been made, a nematocyst explodes instantaneously.

THE PHYSIOLOGICAL EFFECTS OF NEMATOCYSTS ON OTHER ORGANISMS

On the chemical side, it has been shown by Portier and Richet ('02) that an aqueous extract made from twenty-nine of the tentacles of a *Physalia* contained enough poison to kill a pigeon within an hour after injection. Curiously enough no inflammation was set up; irritability and temperature were reduced and diarrhœa frequently set in. These experiments, together with the observation that frogs or fish, when placed in contact with the filaments of *Physalia*, make no attempts to escape, led Portier and Richet to name the poison involved, hypnotoxin. Very little is known regarding its chemical nature. It is destroyed by a temperature of 55° C.; can be precipitated with alcohol; and is non-dialysable. Von Fürth ('03) who gives a résumé of Portier and Richet's work, adds that it is necessary to assume that the nettles, in addition to the hypnotoxin, contain a violent "Reizgift," which accounts for the inflammations, which in spite of the observations quoted above, have been observed in other cases.

On the physical side, the conclusions of Iwanzoff ('06) and the earlier ones of Möbius ('66), are opposed in certain important respects. Iwanzoff states that the physiological effects of the

nettles are due to the numerous poisoned threads which surround and penetrate the victim. Möbius distinctly opposes this view as well as others which are current. For instance he considered the idea that the hairs on the filaments are "back hooks," a mistaken one, not only because in the ripe thread they stand out at right angles, but also because they are too delicate to serve the function attributed to them. Möbius might have added that many types of functional nematocysts are devoid of these barbules.

As for the ability of the thread to penetrate into the tissues of the victim, Möbius considered this impossible, in the first place because the thread "unrolled" too slowly, and in the second place, because its point does not strike the victim. In fact, the point is the last portion of the thread to be everted, and it is, of course, cast out with less force than any other part. The great delicacy of the point was also offered as evidence against the validity of the current belief.

The nettling sensations produced by nematocysts, Möbius did not attribute to the minute punctures made by the filaments, but to the fact that these are saturated with some chemical, which on coming into contact with the skin, produces irritation. This chemical remained undetermined, but relying entirely on micro-chemical tests, Möbius concluded that it is neither formic acid, nor any other acid.

The existence of hypotoxin seems to be fairly well established, whereas there is considerable doubt about the inferred "Reizgift." All the phenomena which the "Reizgift" could explain, seem to me to be explicable on the assumption that the filaments, contrary to Möbius' conception of their powers, do actually penetrate the tissues. The idea does not seem to have occurred to him that a thread might penetrate a tissue before being completely everted; he does not seem to have realized at what immense pressures the discharges occur; nor, if he knew of such instances, did he recall that, given sufficient velocity, a stem of hay will shoot through a pane of glass.

Observations, as well as experiments, bearing on the penetrating power of the filaments were made. Thus the acontia of *Metridium* were placed on fresh tissue taken from a clam, and the

nematocysts were then discharged by fixing the preparation in sublimate acetic. The tissues which had been "shot" in this way were then sectioned, and in several regions it was possible to trace the filaments of the nematocysts through the epidermis into the muscle and connective tissues below. Most of the threads however, did not enter the tissues, but seemed to have been warded off, and in the sections lie tangential to the epidermis. This is what might be expected, for unless a filament penetrates while it is at the height of its speed, it fails to make a puncture at all, for the extreme end is everted too feebly, just as Möbius says.

Direct observations on the behaviour of the nematocysts of *Montagua*, while still enclosed within the cnidocysts, are much more favorable for the elucidation of this question. We have reported in an earlier section that the nematocysts may explode before the cnidocyst bursts, and that the discharged filaments are capable of penetrating through their enclosing membrane.² The length of the discharged filament; the position of the nematocysts inside the cnidocyst, and the diameter of the cnidocyst, make it absolutely impossible for the filaments to penetrate the membrane at any other than the early stages of eversion. The cnidocysts are not large enough to allow anything else; nevertheless the filaments penetrate them, which is exactly what they should do if the osmotic theory of discharge, and the considerations brought forward in the preceding paragraphs, are correct.

SUMMARY

1 The material used consisted chiefly of the living tentacles and acontia of *Metridium*, and nematocysts, isolated, by digestive and other methods, from *Metridium* and *Physalia*.

2 The discharge of nematocysts is due to internal pressure. This pressure may be raised to the exploding point by osmosis and by distortion.

² Two months after this paper was written Toppe (*Zoologischer Anzeiger* Bd. xxxiii, Nos. 24/25) published an account of his very careful observations on the manner in which nematocysts discharge, and showed conclusively that the netting threads are able to puncture the chitinous covering of a *Corethra* larva.

3 The explosive pressure varies with the individual nematocysts, and with circumstances. It may be artificially altered. This fact explains why the nematocysts of *Æolids* explode in sea-water, whereas those of *Cœlenterates* do not unless the nematocyte is stimulated.

4 It is impossible to show that the nematocyte is a factor in the discharge of the nematocysts of *Cœlenterates* under all circumstances. Nevertheless, this is true under some circumstances, and perhaps always under the conditions which are normal in the lives of *cnidaria*.

5 The osmotic theory, originally advanced by Grosvenor on very limited evidence, is absolutely supported, as far as isolated nematocysts are concerned, and may be applied to the normal discharge of stinging capsules in *Cœlenterates*, if we suppose that stimulation of the nematocyte inaugurates changes which result in the liberation of heat or in lowering the concentration of the intra-cellular medium immediately surrounding the nematocyst. Both heat and dilution may be operative.

6 The filaments of nematocysts are capable of penetrating the tissues of other animals, contrary to the opinion of Möbius, but in order to do this, must make their punctures before eversion is complete.

Zoological Laboratory
University of Michigan
November 25, 1908

LITERATURE

- GROSVENOR, G. H. '03—On the Nematocysts of *Æolids* Proc. Royal Soc., vol. lxxvii.
- GLASER, O. C. '02—The Nematocysts of Nudibranch Molluscs. Johns Hopkins University Circular, vol. xxii.
- GLASER, C. C. '06—The Nematocysts of *Eolis*. Science, vol. xxiii.
- IWANZOFF '96—Ueber den Bau, die Wirkungsweise, und die Entwicklung der Nesselkapseln der Cœlenteraten. Bull. Soc. Imp. Moscow, 1896.
- GARREY, W. E. '04—The Osmotic Pressure of Sea-water and of the Blood of Marine Animals. Biol. Bull., vol. viii, 1904.
- MÖBIUS, KARL '66—Ueber den Bau, den Mechanismus, und die Entwicklung der Nesselkapseln einiger Polypen und Quallen. Abhand. d. Naturwiss. Verein z. Hamburg 1866 Heft. I Bd. U.
- PORTIER P. ET RICHET C. '02—Sur les effets physiologiques du poison des filaments pecheurs et des tentacules des Cœlenterés (hypnotoxins) Compt. Rend., 1902.
- VOM FURTH '03—Chemische Physiologie d. Niederen Tiere. Gustav Fischer, Jena, 1903.

OBSERVATIONS ON THE LIFE HISTORY OF TILLINA MAGNA

BY

LOUISE HOYT GREGORY

I	Introduction.....	383
II	Material and methods.....	385
III	Morphology and physiology.....	386
IV	Reproduction and encystment.....	392
	Introduction	
	Formation of division cysts	
	Formation of sporulation cysts	
	Formation of permanent cysts	
V	Conjugation.....	399
VI	Observations on the life history.....	401
	The A culture	
	The B culture	
	1 Normal or control culture	
	2 Stimulated cultures	
VII	Regeneration and centrifuging.....	411
VIII	General considerations.....	412
	a Artificial rejuvenescence.....	412
	b Hertwig's "Kernplasma" theory.....	415
IX	Summary.....	427

I INTRODUCTION

Tillina magna was first described in 1879 by Gruber, who found the organism in great numbers in a fresh water culture which had been sent from Vienna to Freiburg, and who regarded it as an intermediate type between Colpoda and Paramecium. Kent, in 1880, placed it in the family Enchelinidæ of the Holotrichous ciliates because of its oral cilia, although he admitted that the pharynx was strikingly like that of *Conchophthirus*. Bütschli, in 1888, mentioned *Tillina magna* merely as a synonym for *Conchop-*

Submitted in partial fulfillment of the requirements for the degree of Doctor of Philosophy, in the Faculty of Pure Science, Columbia University.

thirus magna which he described as the only fresh water form in the genus *Conchophthirus*, the remainder being parasitic in land and fresh water molluscs. Since 1888 no mention of this form has been made in any classification or investigation.

In November, 1906, an infusorian was found in the laboratory of Columbia University, in an infusion of horse manure which had been standing for a month. It was identified by Professor Calkins as *Tillina magna*, and because of its characteristic tongue of cilia in the oral region, in addition to its general coating of cilia, I have classified it in the order Holotrichida, sub-order Trichostomina, family Chiliferidæ, thus taking it from the family Enchelinidæ where Kent had placed it, also from the order Heterotrichida where Bütschli placed it as synonymous with *Conchophthirus*, and with Gruber classifying it as a type closely related to *Colpoda* and *Paramecium*.

Because of its rarity and unusual power of reproduction, resulting in a rapid increase of numbers, and its apparent ease of cultivation in artificial surroundings, Professor Calkins suggested that I study its morphological characteristics, its methods of reproduction, its reaction to stimuli, and the process of conjugation, in fact, as much as possible of the processes taking place in the life history, with the view of verifying the work of some previous investigators, and of offering, if possible, further facts for the discussion of such fundamental problems of biology as reproduction, artificial parthenogenesis, encystment, and the interrelations of nucleus and cytoplasm. I wish to express my thanks to Professor Calkins for his helpful suggestions and criticism throughout the course of my work.

In November, 1906, two strains were started from the wild material. In January, 1907, I endeavored to find more wild stock in the original culture jar, but was unsuccessful. The entire stock had disappeared. For two years I have made and examined cultures, but in no case have I found the organism. Gruber, in his early article, mentioned the fact that the organism remained in the medium for only a short time, disappearing on the appearance of other protozoan forms. This would accord with Peters' idea of a gradual succession of forms in a protozoan

culture, brought forward in 1904. From his observations on the appearance of Stentor in the culture medium, Peters concluded that, as there is a constant change taking place in the growth of a culture caused by fermentation, there is also a corresponding change in the life of the culture. Paramecium, Euglena and others appear at an early period when the fermentation is active. Stentor, on the other hand, does not appear until the extreme acidity has decreased, at which time the earlier forms begin to die out. There must be some other reason, however, to explain the nonappearance of Tillina in the new culture jars, which were examined very frequently. Possibly the organism is an intestinal parasite of the horse, which may also lead a free living existence for a short time. Its non-appearance in the fresh jars might be explained in this case if the culture material was not infected.

II MATERIAL AND METHODS

Since Tillina stock was found in a jar containing a culture of horse manure, in order to have the artificial medium as near like the normal as possible, a solution was made of ten grams of manure in 60 cc. of water. This was brought to a boil, filtered and allowed to stand. In general it was found better to use the medium that was 24 hours old. Fresh medium was made every two or three days and the cultures were examined every day. Attempt was made to find another medium. A hay infusion was prepared according to the method of Calkins ('02). Then the animals were brought gradually into the new medium, starting with a solution of $\frac{1}{4}$ hay infusion, and $\frac{3}{4}$ medium, and increasing the amount of hay each day. In no case could the animals live in pure hay infusion, death occurring almost immediately. I was able to carry a culture for about a month in a solution of $\frac{1}{2}$ hay and $\frac{1}{2}$ medium, but they were not as healthy as those in the straight medium. An oat infusion was tried, with no better success, and the so-called "normal" medium was finally decided upon as best for the experiments.

The methods used in these experiments are the same as those of Calkins ('02) and Woodruff ('05). In brief, a small chamber

was made of a depression slide; two glass supports held the cover glass over the hollow center, covering an area that would hold about twenty drops of liquid. These slides were kept in moist chambers, which were subjected to ordinary room temperature. All possible care was taken to prevent contamination. The slides were washed in boiling water, supports and covers were kept constantly in water, when not in use, and the cloths used in drying were for that purpose only. Capillary pipettes were used for the transference of the individuals, and these were kept separate from those used for other purposes. A large pipette was used expressly for the filling of the chambers.

Both living and fixed material were studied. The living individuals were isolated by means of a fine pipette and studied in a hanging drop. Material was fixed at frequent intervals, and sections as well as total mounts were made. For embedding methods see Calkins ('07). The best fixative was found to be a saturated solution of corrosive sublimate, to which had been added 10 per cent formalin solution in the proportions 10 : 100 cc. saturated solution. The least shrinkage resulted with this method. For staining the total mounts, Heidenhain's hæmatoxylin, and hæmacalcium, gave the best results. Eosin and picro-carmin were fairly good stains. Delafield's hæmatoxylin, saffranin, eosin and methylene blue, were tried, but the results were not good. The sections cut 5 microns in thickness, were stained in general with iron hæmatoxylin, both with and without the counter stain of eosin. Other stains were tried, but none proved to be satisfactory.

III MORPHOLOGY AND PHYSIOLOGY

Tillina magna is a large ciliate having the shape of a bean or a kidney. Gruber in his description states that the average length is 200μ , and that he often found larger forms. In only a few cases, however, have I found it measuring even 200μ in length, and never more than this, the size varying from $100-200\mu$ in length, and from 70 to 180μ in breadth. The average length and breadth of fifty individuals was 160μ and 100μ respectively. The anterior half of the body is broad and blunt, the posterior half tapering. The

posterior region is easily recognized by the presence of a highly characteristic lobe-like process of the dorsal surface, in which lies the contractile vacuole, and which extends out beyond the body proper on all sides, especially at the right posterior edge. A continuation of this edge is extended along a depression on the left side and ventrally into the peristomial region, and appears finally as a tongue-like ridge lying on the floor of the pharynx. This tongue gradually diminishes in width, and disappears near the inner end of the pharynx. While the body in general is composed of colorless protoplasm, pigmentation is found only in this posterior lobe, which normally is filled with a mass of black granules. These granules are present when the young individuals break away from the cyst, and cause the lobe to stand out in sharp contrast from the main portion of the body, which at this time is without food vacuoles, and is practically colorless. The lobe is somewhat similar to that described in *Colpidium colpoda*. It differs in being much more developed, and in being found in the posterior rather than the anterior region (Plate I, Fig. 1).

The mouth is situated on the ventral surface in the anterior half of the body, and extends from the region near the middle line out toward the left side, where the peristomial region runs into it. According to Gruber, the peristome is lacking. This is a mistake, I think, as in every individual the mouth is always in its central position, with a definite peristome leading to it. There is no vestibule; the mouth leads directly into a long tubular, curved pharynx or œsophagus, relatively much longer than that of *Colpoda*. The pharynx, with its ridge-like tongue, bends anteriorly inward toward the right side of the body, then it turns sharply toward the posterior region, and ends just below the nucleus, its walls widening out like a funnel (Plate I, Fig. 2).

The entire surface of the body is covered with many longitudinal bands or striæ, which indicate the insertion lines of the cilia. The striæ are arranged on the surface in a similar manner to that described by Schewiakoff for *Colpidium colpoda*. On the dorsal surface the lines pass from the anterior to posterior end in straight parallel rows, bending toward the left posteriorly. On the ventral surface, however, they converge about the mouth, which, accord-

ing to Bütschli, is the general rule, for when the mouth has shifted from its original, anterior, terminal position to a ventral region, the lines of cilia are moved also. The peristomial and pharyngeal, as well as the membrane or plate region, are covered with long fine cilia, which are easily seen in the pharynx, about the mouth, and along the entire edge of the poster or lobe. These are of uniform size, and three times the length of the cilia covering the body.

The ectoplasm is differentiated into two parts, one, the cuticle, or pellicle, which is a thin membrane covering the entire surface of the body; the second, the cortical plasm or alveolar layer (Bütschli, 1888), which lies directly beneath the cuticle. The cortical plasm is a definite, well differentiated layer, easily distinguished from the endoplasm (see Text Fig. 1 *a*). The cuticle and outer

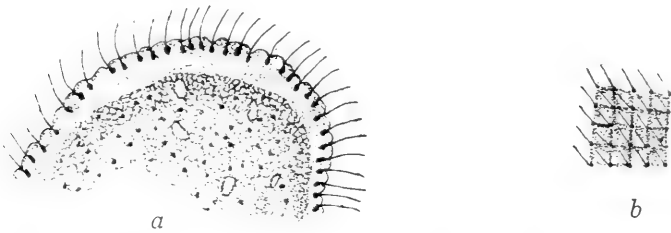

Fig. 1 *a*. Section through the cortical plasm and endoplasm showing the sharp differentiation between the two structures, also the position of the basal bodies in which the cilia take their origin. $\times 1200$.
b. Semi-diagrammatic surface view showing the raised squares and the insertion of the cilia. $\times 1200$.

portion of the cortical layer is raised to form minute papillæ, such as have been described in *Lembadion* (Bütschli '87), *Paramecium* (Bütschli '81, Maier '03, Schuberg '05), *Frontonia* (Schuberg '05), *Colpidium colpoda* (Schewiakoff '87), *Ophryoglena*, *Chilodon*, *Bursaria* (Maier '03), *Opalina*, *Nyctotherus* (Maier '03, Bessenberger '03.)

A surface view or section shows the body to be divided into small squares or hexagons, the "Feldchen" of Maier (Text Fig. 1*b*). These squares are raised in their centers, forming papillæ, which are definitely and clearly seen in profile on the edge of the body. At each corner of the squares is a deeply staining body, the basal granule, from which a cilium takes its origin. Thus the cilia lie

in the furrows, and the striæ truly indicate the lines of cilia insertion. The basal granules are not situated deep in the cortical plasm, but lie near the surface, almost directly under the cuticle, leaving below a wide clear space of granular cortical plasm.

A comparison of the cortical plasm and ciliary structures of *Tillina* with those described in other forms, shows that there may be considerable variation even among related types. In *Paramecium caudatum* and *Frontonia leucas*, according to Maier and Schuberg, the surface of the body is divided into hexagonal or rhomboidal figures. These, however, are not raised in their centers as in the case of *Tillina*, but are hollowed out. The sides of the fields are raised to surround the hollow centers, in which lie the basal granules which give rise to the cilia. The papillæ at the edge of a section, are the raised boundaries of the hollow areas, the striations on the body indicate the lines of cilia insertion. Another variation is seen in the structure of *Colpidium colpoda*, and of *Lembadion*, according to Schewiakoff and Bütschli. These forms agree with *Tillina* in having raised areas, but differ in the fact that the basal granules lie in the centers of the squares, not at the corners, and the striæ represent merely the furrows between the papillæ. In the case of *Opalina*, *Bursaria*, *Ophryoglena* and *Nyctotherus*, according to Maier and Bessenberger, the arrangement is the same as has already been described for *Tillina*.

Below the basal granules in the cortical plasm, there is a layer of clear granular protoplasm. If trichocysts are present, they should be found here, but I have no evidence of their presence; Gruber and Kent mention the layer of definite trichocysts in *Tillina*, but Bütschli ('86) later correctly interpreted this as the alveolar layer. Trichocysts, therefore, are unquestionably absent.

The contractile vacuole is of the simplest type. There is one large vacuole situated in the cortical plasm on the dorsal surface of the posterior lobe, and communicating directly with the exterior. There are no definite canals or reservoirs in communication with the vacuole. It has a membrane and is a stable structure, not being constantly reformed.

The endoplasm is a fine granular substance containing many food vacuoles. Although there is no definite basement membrane

separating the endoplasm from the cortical layer, there is a thickening of the protoplasm that marks the limits of each layer.

As in the majority of infusoria, the nuclear material is differentiated into two structures, a large macro-nucleus, and one or many small micro-nuclei. The macro-nucleus lies dorsal to the pharynx in the anterior half of the body, near the middle line, not in the extreme anterior region as is stated in Gruber's account. Neither is the early statement true, that the nucleus is visible only in young forms in which the protoplasm is less dense. I have been able to see the macro-nucleus at all stages of growth, in the large mature forms as well as in the small young individuals. In the fixed material the nucleus is always visible, staining with different degrees of intensity, and surrounded by a definite membrane. The question of a nuclear membrane has long been a subject of discussion. Many investigators, among whom are Bütschli ('98), and Albrecht ('03), assert that no membrane exists. Bütschli does not consider the membrane of an infusorian a true one, since it is transitory, and may have the same reactions as the cytoplasm. Albrecht, experimenting with sea urchin eggs, found that if the nuclei were forced from the egg by compression, and brought in contact with another, they would flow together, hence he believes that there is no nuclear membrane. Marcus ('07) repeated Albrecht's experiments, using *Actinosphærium*, and obtained opposite results; that is, the nuclei did not flow together. Albrecht probably broke the membrane when compressing the eggs. I have compressed *Tillina*, and both the macro- and the micro-nuclei were forced from the body. They always retained their normal shape, and showed the presence of a membrane. This, however, may vary at times in its definiteness, and in two cases seemed to have been broken, allowing the nuclear fluid and cytoplasm to mingle.

The shape of the macro-nucleus varies. It is usually an ellipsoidal body, the long axis measuring 50μ to 70μ , the short axis 20μ to 30μ . At other times the shape may be spherical or like the letter U (Text Fig. 2, *a, b*). The different forms may all be derived from the normal ellipsoidal one, and may represent a certain stage in the preparation for division. The macro-nucleus

varies in its staining reactions. At one time it may be filled with a vesicular achromatic ground substance in which are embedded many large deeply stained chromatin masses, which often take the form of threads or loops (Text Fig. 3, *a b c*). Another individual may have a nucleus in which the achromatic material is faintly stained, and in which there is no indication of the presence of chromatic material having lost its power of taking the nuclear stain. The micro-nuclei are small spherical bodies 5μ in size, situated close to the macro-nucleus, either embedded in the larger nucleus, or at the edge. The homogeneously staining chromatic mass is surrounded by a clear non-staining area which separates



Fig. 2 Types of nuclei. These may be transition stages between the normal elipsoidal nucleus and the spherical nucleus of the division cyst. $\times 400$.



Fig. 3 Sections through the normal elipsoidal nuclei showing characteristic appearances of the chromatic substance.

it from the membrane always present. They vary from four to ten in number. Many times I have found two in close proximity, indicating a late division. Once only I found what seemed to be a spindle formation. The bodies are so small that it is impossible to distinguish the internal structure.

Intracellular digestion in Protozoa has long been a disputed question. Engelmann ('79) and Le Dantec ('92) concluded from their experiments that the digestion was due to the presence of an acid medium. Mouton and Mesnil ('90) came to the opposite conclusion. Greenwood ('94) made extensive experiments on the digestion of the gastric vacuoles in *Carchesium*, and came to the conclusion that the original vacuole is not the digestive vacu-

ole, but that the food particles are forced in the protoplasm, and later are gathered into the true digestive vacuole where digestion takes place in an acid medium. Metalnikoff ('03) has offered the last suggestion in which the two opposing results are combined. In his experiments on feeding paramecia with alizarin, he finds the beginning of digestion taking place either in an acid medium indicated by the yellow color of alizarin, or in an alkaline medium indicated by the red color of alizarin, the main and final digestive processes, however, always take place in an alkaline medium. Thus the digestive processes of the Protozoa closely resemble those of the Metazoa in which is found the pepsin ferment followed by the pancreatin action. Attempts were made to duplicate these experiments in case of *Tillina*, but in all cases the coloring matter was not taken in.

The endoplasm is well filled with large food vacuoles which are in different stages of digestion. Some are crowded with bacteria, and stain deeply with hæmatoxylin, indicating that digestion has not proceeded far; some show lighter areas at the ends of the vacuoles, an indication of digestion in those regions; in others the process has gone on to a greater extent, and only a slight amount of undigested material remains, which is stained a pale gray in comparison with the black stain of the fresh food particles; finally vacuoles are found with no trace of the presence of food; these can hardly be distinguished from the contractile vacuole, position only being the means of identification.

IV REPRODUCTION AND ENCYSTMENT

Encystment is an expression of certain physiological conditions in the cell during which different functions may be performed. The cyst may be temporary only, and for the purpose of reproduction or digestion, or it may be permanent, affording the organism a condition of rest as well as a protection from an unfavorable environment. The reproductive cysts are of two kinds, those in which simple division takes place, and those in which so-called sporulation occurs.

Cohn, in 1853, described simple division within a cyst, in the case of *Prorodon teres*, one division only taking place. Carter,

in 1856, described a similar process in *Otostoma*, and Stein in 1859 the same for *Colpoda cucullus*. Bütschli, in his work of 1888, has brought together the results of previous investigations, and has classified those forming division cysts into three groups as follows:

Group 1. Those which always form division cysts before simple division takes place: *Colpoda cucullus*, *Holophrya multicilia*, *Amphileptus*, *Trichorhynchus*, *Lachrymaria*.

Group 2. Those in which it is doubtful if cysts are always formed before division: *Prorodon*, *Actinobolus*, *Holophrya gula*, *Enchylys tarda*, *Ophryoglena*, and here Bütschli places *Tillina*, which, I believe, rightly belongs in the first group.

Group 3. Those which may or may not encyst before division: *Leucophrys patula*, *Glaucoma scintillans*.

Today the most complete, and in fact, the only detailed description of division cyst formation is that published by Rhumbler in 1888, in his paper entitled "A Study of Cyst Formation and the Developmental History of *Colpoda cucullus*." The division cysts may be either oval bodies in which the protoplasm divides but once, forming two individuals, or spherical bodies in which one or two divisions may take place, resulting in the formation of two or four individuals. He describes a permanent opening in the surrounding membrane of these division cysts through which the contractile vacuole discharges its contents during the early history of the formation of the cyst. Later the contractile vacuole rotates, and its contents are discharged within the membrane outside of the body. The newly formed individuals make their escape through the opening in the membrane.

Reproduction in the case of *Tillina* takes place exclusively by the formation of spherical cysts in which the protoplasm may divide once or twice, to form two or four individuals. The formation of these cysts varies in frequency depending a great deal upon the amount of food present. Under favorable conditions, when the division energy is normal, and the food has been given at regular intervals, each individual will encyst on the average of once a day, and by two divisions will give rise to four young individuals, the entire process covering a period of about twelve hours. The

record shows that this rate of division may rise to 2.5 divisions per day (25 divisions in ten days), and that it may sink as low as .3 of a division per day (3 divisions in ten days). (These figures represent the average of the division rates of four individuals for ten day periods.) On comparing the frequency of division with that of *Paramecium aurelia*, Calkins ('02, '04), and with that of *Oxytricha fallax*, Woodruff ('05), the records show that the division rate of *Paramecium* varies from a maximum of 1.7 divisions per day, to .07 divisions per day (in other words, from seventeen to seven-tenths division in ten days); while that of *Oxytricha* varies from 3.5 to .2 divisions per day (or from thirty-five to two divisions in ten days). These records show that the division rate of *Tillina* never reaches the height of that of *Oxytricha*, neither is it able to remain at such a low rate without dying out, as that of either *Oxytricha* or *Paramecium*. The protoplasm of *Tillina* seems to lack the responsive as well as the endurance power of these two other forms.

When the young individual breaks from the cyst it is about one-fourth the normal size, but perfectly formed, containing few if any food vacuoles. It swims about, taking in food and growing rapidly until in about six hours it has reached its normal size, and is well filled with food vacuoles, which gives it a dark color. As Bütschli states, it seems probable that these cysts are usually formed after the body has reached its maximum size. This cannot be the only condition, as he cites the case of *Amphileptus*, which encysts in order to digest. I have found cysts varying in size, showing that the capsules may be formed when the maximum size of the individuals has not been reached.

The first indication of a preparation for division is the noticeable change in movement. This gradually becomes slower and slower until finally, the individual comes to rest on the bottom of the depression slide, or near the glass supports. The cilia temporarily disappear. A thin membrane is then secreted covering the entire surface of the body, and rotation begins within the newly formed membrane, indicating the reappearance of the cilia. Excretory particles are discharged from the posterior region. As the rotation proceeds, the normal elongated bean shape is grad-

ually lost, the peristomial region disappears, and the posterior lobe is absorbed and the large elongated macro-nucleus is shifted in position. If, in the changing of position, one end of the nucleus is moved, the U-shaped form, already mentioned, will result. The spherical nucleus may also be explained as a result of the rotation. In these cases, however, the nuclear changes have anticipated division, as the membrane is not yet formed. The mouth, as well as the nucleus, is changed in its position. Finally, when the spherical form has been reached, nothing is visible save the nucleus, contractile vacuole, food vacuoles and the cortical layer, which is still prominent just below the membrane. Bütschli states that the presence of this layer within the cyst is the exception rather than the rule. There is some question in regard to the history of the mouth during the formation of division cysts. The mouth is not visible in the living cysts, possibly being concealed by the presence of many food vacuoles; neither is it always found in sections of the division cysts. It seems most probable that the old mouth disappears at an early stage, and that a new one is formed before the appearance of the first plane of division. This would explain the fact that in sectioned material a mouth is found in some sections and not in others. This division cyst differs from that of *Colpoda cucullus* in being always spherical in form, and in having no definite opening in the cyst wall.

The first indication of division is in the elongation of the nucleus with a slight constriction in the center (Plate II, Fig. 1). Almost at the same time a constriction appears in the membrane, extending toward the center in such a way that the division plane will pass through the nucleus and the mouth. The contractile vacuole lies at one side, and passes to one of the daughter halves, a new one being formed in the other half. After the first division, or more often, before the first division has been completed, there is a shifting of the daughter nuclei and mouths, and the second plane of division appears at right angles to the first (Plate II, Figs. 2, 3, 4). During this process the macro-nucleus divides by simple division. In some cases the chromatin stands out in sharp contrast to the light faintly staining achromatic ground substance. The chromatin may be arranged in lobes or masses, in the central portion of

the nucleus, or at the extreme edge. In a few cases it seemed to have disappeared at one region and the nuclear substance mingled with the cytoplasmic material.

While the micronuclei divide by mitosis, this division is independent of cell division. During the latter process, four micronuclei may pass directly into one daughter cell, and five to the other, or six into one and seven into the other. All of the bodies are of the same character as those described in the normal forms, having a homogeneous central mass, surrounded by a clear area, the whole body being bounded by a thin but definite membrane.

After the planes have cut through, and the four young cells are separated, rotation takes place individually within the membrane, until the normal form is assumed. Usually the young individuals overlap, as the space is not large enough for all four to be on the same plane. As they increase in size, the membrane is broken, and they escape from the cyst fully formed, with the posterior lobe, mouth, contractile vacuole—all organs in position, but of one-quarter the normal size.

The formation of sporulation cysts is not common among the Infusoria. Reproduction takes place, in general, by the simple transverse division of the body, either within or without a cyst membrane. One of the few examples of the formation of sporulation cysts has been described by Rhumbler in the history of *Colpoda cucullus*. The food vacuoles are first eliminated, and then a thin membrane or velum is secreted slowly on the outside of the cell membrane. A space is left between the two membranes into which the contractile vacuole discharges its contents. There is no opening in the membrane, and the cell floats in its own cavity. The body gradually loses its normal form, shrinks to one-half the original size, and assumes a spherical shape. The cilia are lost, the nucleus is invisible, all assimilation particles are eliminated, and finally there is nothing left save a homogeneous mass of protoplasm which ultimately divides to form eight, ten, or twenty spores. Evarts, in 1873, described a somewhat similar process in *Vorticella*.

Under certain conditions, such as a changed environment, unusual heat or cold, or because of some internal stimulus, perma-

ment cysts are formed. If fresh medium is not given, and if many individuals are allowed to remain together in a small space, as is often the case with the oldest reserve stock, then the individuals round up and secrete a definite thick gelatinous membrane. The cysts are usually smaller than the division cysts, both because the former contain few if any food vacuoles, also because the very young individuals may encyst as well as the mature individuals, if the conditions are favorable for such a result. The protoplasm within the cyst is dense, the nucleus is the only part remaining of the normal body, the mouth, pharynx, contractile vacuole, all having disappeared. As the cysts become older, the membrane becomes thicker and harder; a second membrane, however, is not secreted.

Individuals may be induced artificially to form cysts at any period. If they are placed in tap water, or in a sugar solution, encystment will occur within a short time. Changes in temperature will bring about the same result. Cysts will be formed within twenty-four hours if the individuals are subjected to a temperature of 38° C. The same conditions that cause encystment will often result in the disappearance of the membrane, and the renewal of active life. If encysted forms are subjected to the same temperature (38°) that caused the encystment of the free individuals, the majority will lose their membrane, and again lead a free life. Similar results are obtained if the cysts are put in tap water, or in fresh medium rich in food. The age of the cyst is important for this point, for the older the cyst, the more difficult it is to bring the organism out. Twenty-four cysts that were ten days old, were put in fresh medium and twelve were kept at room temperature, the other twelve were put in the water bath at a temperature of 38° . Not one came out of the cysts.

April 6 12 cysts (8 days old) were put into a water bath at a temperature of 38° C.

8 none came out. They were transferred to normal environment.

10 all came out.

11 12 cysts were kept in room temperature.

12 11 came out of cysts.

April 11 12 cysts were put in water bath 38° C.

12 8 came out.

June 13 9 cysts were put in rain water at room temperature.
14 5 came out of cysts.

From these experiments it will be seen that there is no definite rule in regard to the numbers that can be forced from the cyst. There is a great deal of individual difference, and the same processes that will be effective in one case will have no results in another case, even though the age and the environment have been the same. Generally, however, starved forms will always encyst, and a change in environment, either of food or of temperature, will cause the encysted form to assume its free living existence. Minchin has suggested the cause of this may be the influence of salts in the solution upon the membrane, an external cause, or the stimulus may come from the interior of the cyst acting on the membrane, the original stimulation coming from the new environment. It either case the cause would be primarily an external one.

In general, the reproductive and protective cysts differ but little from one another save in the thickness of membrane and presence of food vacuoles. Rhumbler has found a more important difference in the presence of a definite opening in the reproductive cysts of *Colpoda cucullus*. Since Rhumbler's observation is the only evidence, we may consider this an exception. In *Colpidium* also a reproductive cyst may become a permanent protective cyst, and in *Tillina* I have seen individuals that had encysted for division secrete a thicker membrane, until finally a permanent cyst was formed. This may happen either before or after division; in the latter case each individual secretes a thick membrane.

There is also a close relation between the reproduction within the simple division cysts and the sporulation cysts. If the divisions are simultaneous, the process might be regarded as sporulation, if, however, they are successive, the process is division. The conditions in *Tillina* must be considered an intermediate stage, for in reproduction, resulting in the formation of four individuals, the divisions are not simultaneous, but nevertheless, they follow each other so rapidly, that the second plane appears before the first division has been completed, and the four individuals mature at

approximately the same time. In the history of *Colpoda cucullus*, division within the cysts may take place either by forming two, four or eight individuals, by successive divisions, in a similar manner to that observed in *Tillina*, or by forming as many as twenty or more individuals simultaneously, a process of true sporulation.

An interesting question in regard to the reproductive cysts, is the significance of single and double divisions forming two and four individuals respectively. This was found to take place also in *Colpoda*, but not in similarly shaped cysts as in *Tillina*. Rumbler describes the single divisions as taking place only in the oval cysts, and even then, only very seldom. I have tried to find if there is any relation between the number of single divisions and the vitality of the protoplasm. Diagram I shows the number of single and double divisions in the main *B* culture during a period of eight months. At the beginning, when the vitality was high, and the divisions frequent (e.g., periods 1-26) there are more double divisions than single, while in some five-day periods there were no single divisions at all (e.g., period 2, 6, 10, 21). As the vitality decreased, the number of single divisions grew more frequent (e.g., periods 28, 29, 31, 35, 36), and at the end of the history, there were more single than double divisions (e.g., periods 42, 44, 46, 48-50). Thus the appearance of single divisions might be considered an indication of low protoplasmic vitality.

V CONJUGATION

Although the life history of *Tillina magna* was carefully watched throughout thirteen months, or through 546 generations, no conjugations or indications of conjugations were observed. Calkins ('04) was able to bring about conjugation at almost any period by putting in small watch glasses, masses of paramecia that had collected about the edge of the culture jar. Similar attempts were made with *Tillina*, but with no results. Neither individuals of the same nor individuals of different ancestry, starved or well fed, gave any evidence of conjugation. The experiments of Joukowsky ('98), and of Woodruff ('05), show that many hypotrichous ciliates do pass through many generations without conjugation. Joukowsky carried *Pleurotricha lanceolata* through 460

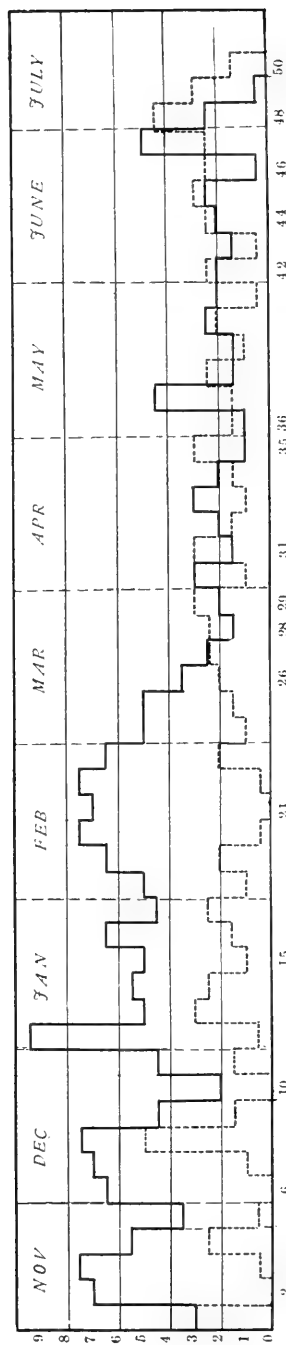

DIAGRAM I

The diagram shows the number of double divisions and its relation to the number of single divisions during the entire history of the control culture B. The average is made for five day periods (six periods to the month). The broken line indicates the double divisions. The continuous line, the single divisions.

generations, and Woodruff watched *Oxytricha fallax* through 860 generations. On the other hand, conjugation has been studied by Maupas in the case of *Colpoda*, which in form is closely related to *Tillina*. There are two possible explanations of the non-appearance of conjugation stages: the first, that the conditions under which the experiments were carried out lacked the proper stimulation for conjugation, the protoplasm never reaching the miscible condition which Calkins described as characteristic of conjugating paramecia; the second possibility is that *Tillina* may be an intestinal parasite, and that the conjugation processes are carried on under very different surroundings from that in which the normal simple division takes place. The fact that the main stock was lost or disappeared from the culture jar, in which they were originally abundant, is the reason that I was not able to experiment with large numbers of wild material.

VI OBSERVATIONS ON THE LIFE HISTORY

The A culture, consisting of four individual lines of the same ancestry (A1, A2, A3, A4) was started on November 7, 1906, and died on March 1, after having passed through 210 generations. Diagram II was made according to the methods of Calkins. The curve represents the average number of divisions per day, of each individual for ten-day periods, thus representing as a whole, the division energy or general vitality of the protoplasm of the A culture.

The curve is similar to those already made for *Paramecium* and *Oxytricha*. There are the same periodic rises and falls in the division rate which Woodruff has termed the "rhythms." The curve is a normal one with the exception of the unusual decrease in the division rate at the fifth period. This, however, is explained by the fact that an unexpected fall in the temperature of the laboratory took place during the Christmas holidays, and during this period many encysted permanently, and all of the lines suffered a marked decrease in vitality. Aside from this exception, there is a gradual downward tendency in the curve, indicating a general decrease in the vitality, and marking the approach of

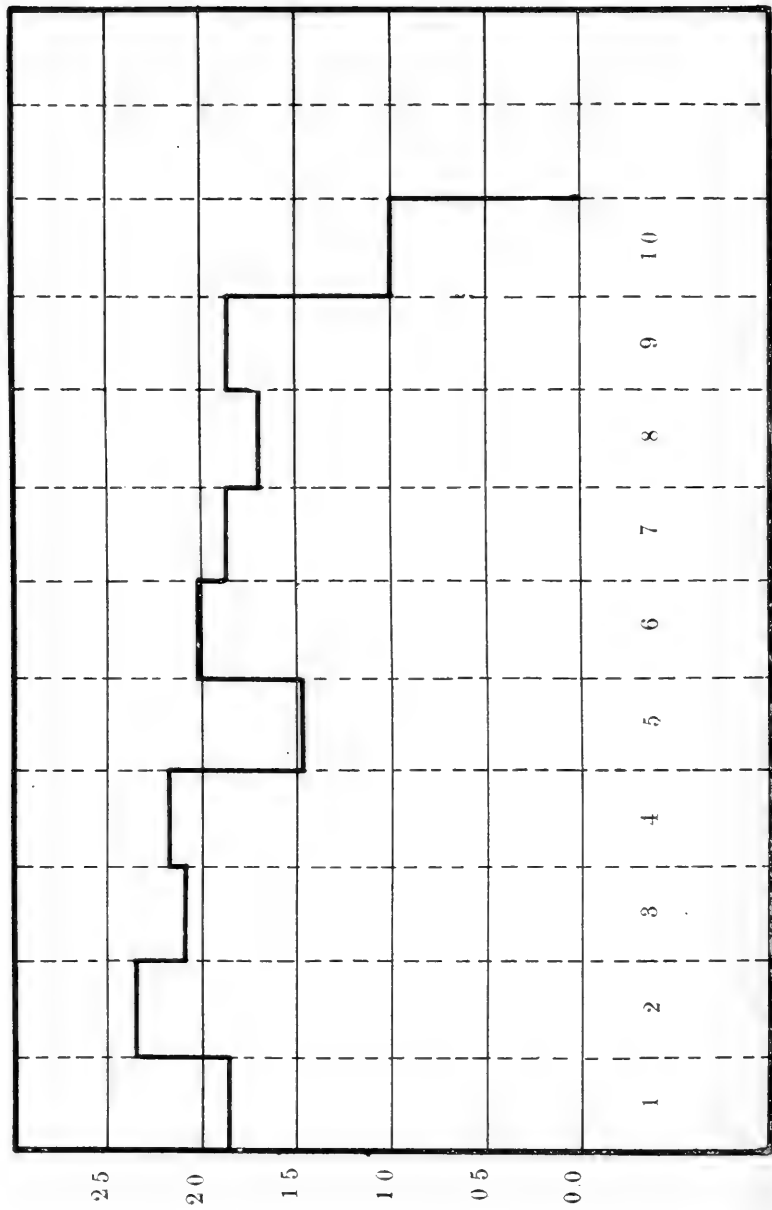

DIAGRAM II

Complete history of *Tillina magna* culture *A* from start (Nov. 7, 1956), to finish (Mar. 1, 1957) in the 210th generation. Rate of division averaged for ten-day periods. The ordinates represent the average daily rate of division of four individuals. The abscissæ represent the numbers of ten-day periods.

the end. The sudden drop at the last period, and the following death of the culture was unexpected, and cannot be explained. In the ninth period the division rate averaged 1.8 per day, then suddenly many began to encyst, and the division rate fell to 1 per day. Beef extract, alcohol, K_2HPO_4 , and KCl were used as stimulants, but with no effect, and the cultures died out March 1, when A2, the last one to divide, had been encysted for twelve days. The stock material was low, otherwise I think the culture might have been saved. The same sudden drop in the division rate, near the end of the life history, has been noted by Maupas in his culture of *Stylonychia*, and by Woodruff in his culture of *Gastrostyla steinii*. In each case a period of comparatively high division rate preceded the sudden death.

The B culture was started at the same time as the A culture, but from different stock. This culture as a whole was carried through 405 days, a period of thirteen months, during which it passed through 548 generations.

The main or control culture, consisting of four lines, B1, B2, B3, B4, lived through 403 generations during 250 days. These lines thus designated were not stimulated at any time in order that the effects of stimulation in the other lines might be more apparent upon comparison. Diagram III shows the life history of this culture. The curve is a normal one, falling naturally into the rhythmical periods already mentioned. There is a gradual decrease in vitality from beginning to end. At the 24th period the rate of division increased to some extent, changing from an average of .87 to 1.37 divisions per day. All the lines increased rapidly in numbers during this period; this was due undoubtedly to the unusual hot weather. At the end of this period the lines were weak, and all save two stimulated lines, died, in spite of extreme efforts to save them.

At the beginning of the 12th period, at the time of the death of the A culture, although the main lines of the B series were dividing on the average of two divisions a day, it was thought best to try the effect of stimulants on the division rate as previous investigators had found that certain stimulants would increase the vitality of the protoplasm, and enable it to renew its life process in

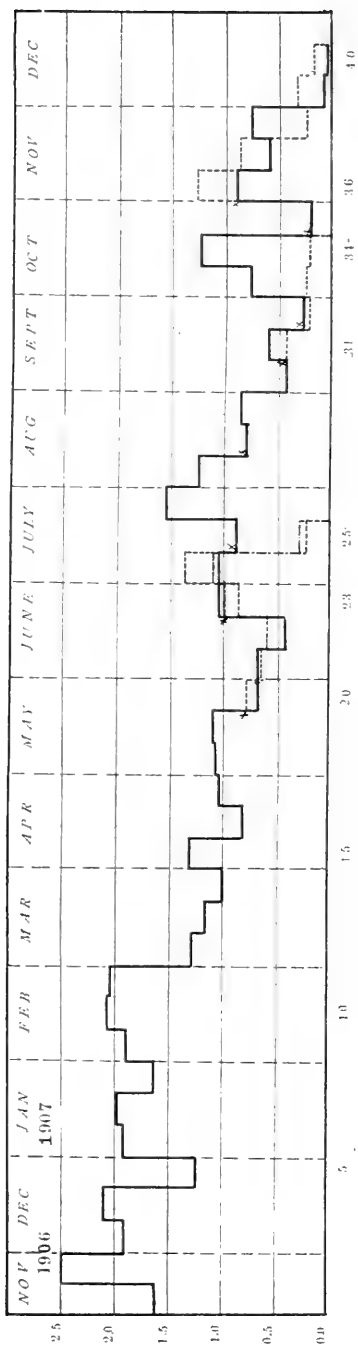

DIAGRAM III

Complete history of *Tillina magna* culture *B* from start (Nov. 7, 1906) to finish (Dec. 16, 1907) in the 548th generation. Rate of division averaged for ten-day periods (three periods to each month). The ordinates represent the average daily rate of division. X = treatment with salts, etc.

20th period — = culture treated with K_2HPO_4 .

--- = control (died during 25th period).

23d period — = culture treated with K_2HPO_4 second time.

— · — = culture not treated with K_2HPO_4 second time.

· · · = control culture.

31st period — = culture treated with K_2HPO_4 fifth time.

· · · = culture not treated with K_2HPO_4 fifth time (died during 34th period).

36th period — = culture treated with K_2HPO_4

· · · = culture treated with beef.

times of depression. Accordingly, six sets of experiments were started.

Experiment 1. B5, B6, were treated with sugar.

Experiment 2. B7 and B8 were treated with tap water.

Experiment 3. B9, B10, B11, B12, were treated with K_2HPO_4 .

Experiment 4. B13, B14, B15, B16, were treated with pancreatin.

Experiment 5. B17, B18, B19, B20, were treated with beef extract.

Experiment 6. B25, B26, B27, B28, were treated with alcohol.

The records for the sugar experiments are as follows: February 26, B5 and B6, from stock of B1 and B2, were put into a solution of $\frac{N}{10}$ sugar plus tap water; February 27, individuals were pale, but normal; fresh solution was given; February 28, both individuals encysted as if for division; March 2, B5 divided unequally, and B6 encysted permanently; March 5, both lost.

Thinking there might be a sufficient amount of salts in ordinary tap water to sustain life, and disregarding the difference in density also, since many well-fed individuals that had become sluggish, had resumed their normal activity when put in tap water, a water culture of two lines, B7 and B8, was started from the stock of B3 and B4. These are the records:

February 26. B7 and B8 transferred to tap water.

February 27. B7 and B8 divided once; individuals pale, and were put in fresh water.

February 28. B7 encysted for division; B8 divided twice.

March 1. B7 divided three times, B8 divided once.

March 2. No division.

March 3. No division; both permanently encysted.

In the case of the experiments with potassium phosphate, four lines were started from the stock of B1, B2, B3, B4. Each was put in a solution containing ten drops of medium and one drop of $\frac{1}{10}$ $\frac{N}{10}$ sol. of H_2PO_4 . B9 was left in the solution one day, B10 two days, B11 three, and B12 four days. B9 and B10 were lost, and the lines were filled in from B12. At the end of the 17th period, a second treatment was given, but this had no effect, and the lines died out at the end of the 20th period.

B13 and B14 were placed in a solution containing ten drops of medium, and one drop of medium plus pancreatin. B16 and B15 were put in a solution containing $\frac{1}{2}$ plain medium and $\frac{1}{2}$ medium plus pancreatin. This last solution proved to be too strong, and both individuals died after four days. These lines were filled in from B13 and B14, both of which were doing well. The variations in this series are abrupt, and the entire set died at the end of the 17th period.

Individuals treated with beef extract seemed to have their vitality increased to a greater extent than those treated with any of the other stimulants. At the 12th period four lines were started from the main culture. These were put in a solution of beef extract (fresh pieces of beef were put in cold water and brought to a boil, then allowed to cool). B17 was treated two days, B18 for three days, and B19 and B20 for four days, the medium being changed on the third day to fresh extract. On April 20, at the end of the 16th period, the vitality seemed to be decreasing, and B19 and B20 were stimulated, B17 and B18 being left untouched. The result is evident, B17 and B18 died at the end of the 20th period, while B19 and B20 lived fifty days longer, dying out on the 25th period, at a time when there was great mortality among all the lines. This period followed one of high rate of division caused by an unusual rise in temperature.

The experiments with alcohol were started on June 23, for which four lines, B25, 26, 27 and 28, were used. One drop of a solution of 50cc. $H_2O + 1$ cc. 100 per cent alcohol was added to the medium in which B25 and B26 were living, and two drops of the above solution were added to the medium in which B27 and B28 were living. This was changed each day. B25 died in four days, the line was filled in from the stock B26. B28 died in three days, and the line was filled from the stock of B27, and all four lines were then treated with two drops of the alcohol solution. This treatment had no stimulating influence, and on July 8, the entire culture died, having lived 16 days. A second culture was started October 1, and died on October 17, this also having lived 16 days.

The results of the first series of experiments may be briefly stated at this point:

The effect of the sugar solution was to lower the vitality, to produce abnormalities, and finally to cause death.

The tap water, likewise, was found not to be a successful medium, though the detrimental effects were not as quickly noticed as those due to the sugar solution. The comparison of the records for B₃ and B₄, the non-stimulated lines, with those of B₇ and B₈ show the effects of the water medium at a glance.

	B ₃	B ₄	B ₇	B ₈
February 27.....	2	0	1	1
February 28.....	2	2	0	2
March 1.....	2	2	3	1
March 2.....	2	2	0	0
March 4.....	1	2	0	0

The effects of the pancreas, potassium phosphate and beef extract are seen best in Diagram IV, where the histories of each treatment together with the non-stimulated cultures, are shown. Of the three curves, the one indicating the pancreatic treatment shows the most abrupt changes or greatest fluctuations. All three curves show a decrease in vitality during the 12th period, The pancreas series recovered most quickly from the depression, changing from a rate of 1.1 divisions per day in the 12th period, to 1.6 divisions in the 13th period. During the following period, it fell again to .9 only to rise again to 1.2 in the 15th period, and then to die out quickly in the 17th period.

The potassium phosphate series is much more gradual in its rises and falls. The curve is very much like that of the main culture. It maintains a slightly higher average, however, throughout its history.

The history of the beef series shows the greatest actual effect. The division rate is higher than normal throughout the life of the culture. That one treatment was not sufficient to carry the series along, is shown by the fact that the lines re-stimulated on the 17th period lived while the lines which received but the one initial stimulus died during the 20th period. Though the main line lived as long as the re-stimulated series, yet its average rate of division was lower, and the general condition of the individuals was much poorer and weaker. The beef extract undoubtedly had a strengthening effect.

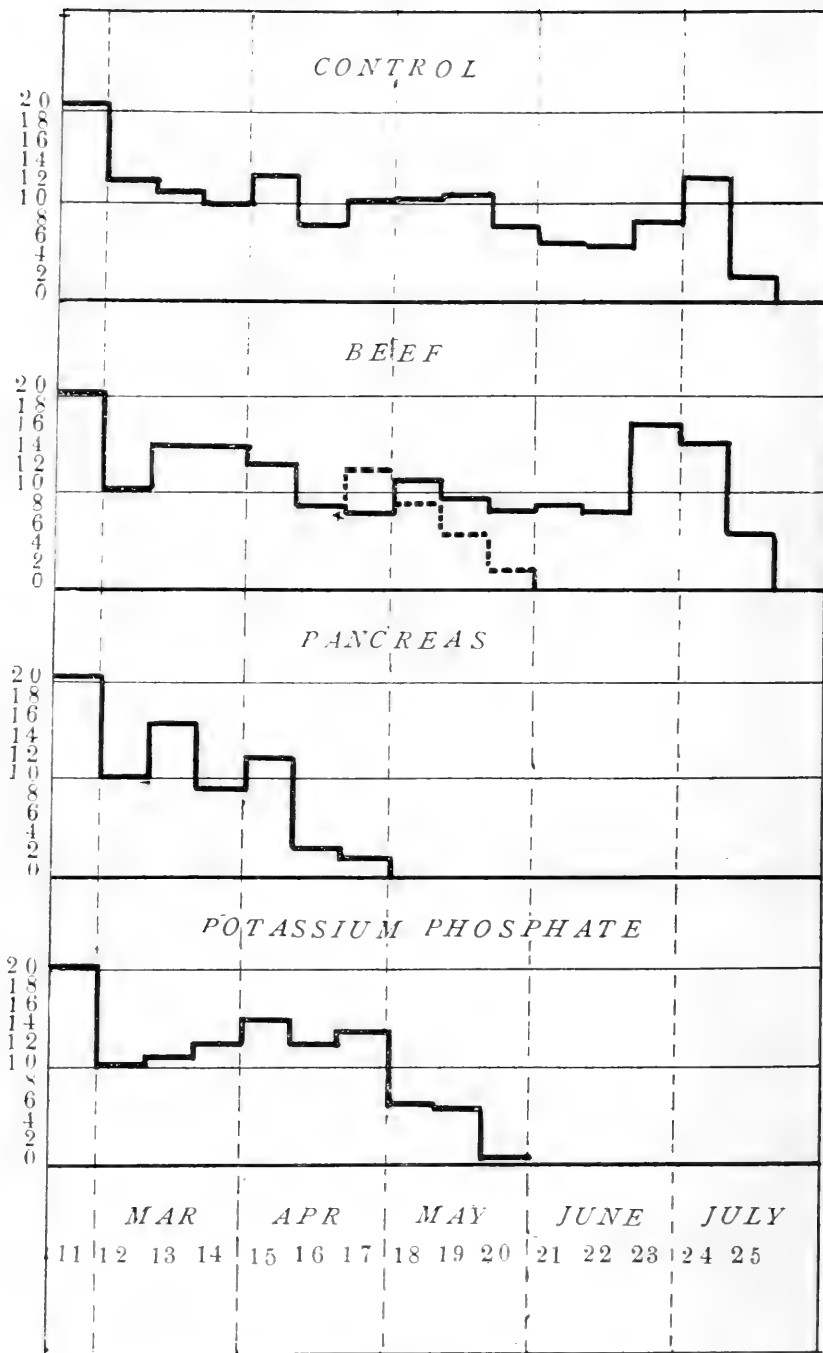

DIAGRAM IV

Histories of treatment with beef, pancreas and potassium phosphate during a period of four and one-half months, together with the history of the control culture during the same period. Rate of division averaged for ten-day periods. In the beef history the broken line indicates the vitality of the individuals that were not treated again at the beginning of the 16th period.

Calkins and Lieb ('03) found that alcohol prevented to some extent the fall into periods of depression, and prevented the extinction of the lines. Woodruff ('08) finds that alcohol may have opposite effects, causing an increase in the division rate at one time, and a decrease at another time. He also states that when an increase in the division rate takes place, this effect is not lasting, but is soon followed by a period of low vitality, even below normal. All experiments treating *Tillina* with alcohol solutions of different strengths proved fruitless. In every case the division rate was lowered, the vitality weakened, and the lines thus treated died out in a short time.

In the 20th period, a second series of K_2HPO_4 experiments was started, the individuals being taken from the main culture, as was the first set, and treated in the same way. This culture proved to be the most successful of all, and was the one to live through the very serious depression period of July, and also furnished the last individual to die on December 15, 1907. As Diagram III shows, at the beginning of the 23d period, this culture was divided, B9 and B10 being left untouched, while B11 and B12 were treated with a second stimulation. As a result of this treatment, the re-stimulated lines lived, while the B9 and B10 lines died.

At the beginning of the 25th period, on July 5, there was a marked decrease in the division rate of all the lines, and the control culture died on July 14. The beef culture was treated again, but succumbed at the same time. An extract of calf's brain was given, but this had no effect. Alcohol also, was found to have no influence. Finally the numbers of stock material and individuals in the K_2HPO_4 culture were reduced to nine, all of which survived this period of extreme exhaustion. This culture, four lines of which became the main culture, was stimulated again on July 11, and again on August 5. At the beginning of the 31st period, the main culture was left untouched, and a new culture of four lines from the stock of B12 was re-stimulated. The diagram shows that the main culture died at the end of the 34th period, while the new culture, which was again stimulated in the 32d period, increased in vitality, the division rate averaged 1.26 divisions per day, the highest point reached during the life history,

with the exception of the 26th period. Finally, in the 35th period, there was a second period during which the vitality suffered, when all save the two lines were lost. Fortunately the stock material was in better condition than in July, and the cultures were renewed. At this time, a third beef culture was started and carried along with the newly stimulated K_2HPO_4 culture. The entire set was again treated on October 21, 31, and November 14. Both cultures seemed to respond to the first stimulus only, and from the 36th period showed a gradual weakening in the vitality. Abnormalities appeared, the division plane not always passing entirely through, or sometimes unevenly through the encysted organism. Calcium and potassium nitrate were used as stimulants (one drop of a $\frac{N}{25}$ solution being added to 10 drops of medium), but nothing seemed effective, and gradually the lines died out, sometimes by the formation of abnormalities, more often by the formation of permanent cysts. Attempts were made with dilute HCL to dissolve this cyst membrane. This was unsuccessful, and the last individual formed its permanent cyst on December 16, the culture having passed through 546 generations in 13 months.

No attempt was made to keep permanent cysts alive after they had been formed for more than ten days. Possibly if some individuals had been kept for longer periods, they might have eventually resumed their normal condition.

During the ten-day periods 26, 27, a few experiments were made to compare the effects of an initial, daily and weekly treatment with one drop of $\frac{1}{10}$ $\frac{N}{10}$ solution K_2HPO_4 . From the few experiments, the results seem to indicate that a repeated treatment increases the vitality to a greater extent than an initial treatment. If, however, the treatment is too frequent, the accelerating effect is lessened, and is finally lost. Woodruff found that in comparison with the control culture, an initial treatment (30 minutes) of a solution of $\frac{N}{100}$ K_2HPO_4 causes a slowing of the division rate, while a daily causes a marked inhibition. The results are practically the same in both series of experiments, though the response of *Tillina* to the treatment was very slight in comparison with that of *Oxytricha*.

VII REGENERATION AND CENTRIFUGING

The experiments of Nussbaum ('88) on *Oxytricha* and *Gastrostyla*, of Gruber on *Stentor*, of Balbiani ('88) on *Trachelius* and *Prorodon*, of Verworn ('95) on *Thalassicolla*, all prove that non-nucleated fragments of protozoa will not develop while nucleated fragments regenerate easily. A few experiments were performed with *Tillina*. A single individual was placed in as small a drop of water as possible. Then by the aid of a simple microscope, transverse, longitudinal or oblique cuts were made with a sharp scalpel. The individuals being minute and constantly moving, made the operation somewhat difficult, and often but one-half would live, the other being crushed by the knife. Eight successful experiments were performed in which a longitudinal cut was made. Of these, six left halves regenerated in 24 hours, and two right halves. Ten transverse cuts were made, and in two cases both halves regenerated. Of the other eight, four posterior and four anterior halves regenerated, showing that there is no difference in the regenerative power of the anterior and posterior regions. In two cases regeneration, growth to normal size, and a single division took place within 24 hours. Only a few oblique cuts were made, and these were unsatisfactory, as one section was too small to regenerate. On the whole, *Tillina* has a remarkably high degree of regenerative power. Regeneration, however, will not take place if the halves are put into tap water. They seem to require the full degree of density in order to recover their normal conditions.

Experiments were made centrifuging four groups of ten individuals each 50, 100, 300, and 500 times respectively. The results were not definite, lack of material preventing extensive experiments. In all the centrifuged individuals, the nucleus tended to be shifted forward. In those centrifuged 100 times practically all of the nuclei were sent to the anterior end of the body. Those centrifuged 300 times showed a scattering of the pigment throughout the body, as well as a shifting of the nucleus. In one case among those centrifuged 500 times, the pigment was sent in a mass to the anterior end, together with the nucleus. In

all cases, the body is shown to be plastic and unstable. Attempts were made to try the power of regeneration in the centrifuged individuals, but this was not successful as the organisms were in too weak a condition, and went to pieces on being cut.

VIII GENERAL CONSIDERATIONS

Artificial Rejuvenescence

Like the division rate of *Paramecium* and of *Oxytricha*, that of *Tillina* shows the same rhythmic variability, representing periodic variations in the vitality of the protoplasm. Unlike *Paramecium* and *Oxytricha*, the division rate of *Tillina* does not indicate as definite a response to treatment with salts. Such substances, apparently successful in other forms, seem to have been effective only in raising the vitality slightly above the normal, and increasing it sufficiently to carry the protoplasm through periods of weakness, and the question arises, has the protoplasm been rejuvenated? According to the definition of Woodruff: "a cycle is a periodic rise and fall in the fission rate, extending over a varied number of rhythms, and ending in the extinction of the race unless it is 'rejuvenated' by conjugation or a changed environment." Following the definition, the first impression would be that the 25th period of the *Tillina* curve marks the end of the first cycle, the stimulation of the K_2HPO_4 of two periods previous, affording the changed environment the influence of which carried one culture through the period of lowered vitality. If this is true, a second cycle ends at the 35th period, and the third at the 40th period. In all, then, there would be three cycles, the first lasting eight months, the second and third three months each. A careful study of the history of *Tillina* has convinced me that the curve of vitality represents one cycle only. As has already been mentioned, there was no markedly high period of activity resulting from a stimulation as in the case of *Paramecium* and *Oxytricha*. The slight impetus that was given was only temporary in its effect, and after a comparatively short time a re-stimulation was necessary to carry the individual along at even a normal rate. From

the beginning to the end of the history there has been a slow decline in the division rate. This was not noticed during the first eight months, yet the diagram shows its presence. At the end of eight months, a stimulus seemed necessary and was given in K_2HPO_4 . This caused a slightly higher rate of division, but it could hardly be spoken of as having caused "rejuvenation," for almost immediately the vitality diminished, and a second, and soon a third stimulus was needed, this exhaustion appearing more and more frequently as the end drew near, and the stimulants having less and less effect on the protoplasm, finally failing absolutely in their potency.

From these observations I am convinced that an artificial rejuvenation of the protoplasm, in the sense of Calkins and Woodruff, has not taken place at any time in the history of *Tillina magna*, and that the effects of the stimulants have been to prolong rather than to renew life.

But after all, is it not a question as to the meaning of "Artificial Rejuvenation?" According to Calkins and Woodruff, this term has been applied to protoplasmic changes induced by chemical or mechanical means, which result in a reorganization of the body indicated by a renewal of metabolic processes and a high division rate. A marked change in the protoplasm of *Tillina* has not taken place after treatment with salts. Nevertheless, some action occurred which enabled the stimulated culture to hold its own, while the non-stimulated cultures died. Is this not practically the same, only to a lesser degree, as that which Calkins and Woodruff found in their so-called artificial rejuvenation of *Paramecium* and *Oxytricha*?

During certain periods in the life history, the vegetative activities of the organisms become exhausted and "physiological death" (Hertwig's term) follows, unless some stimulus is given to renew the vitality of the protoplasm. In such a condition, *Tillina* shows but a slight degree of sensitiveness in its response to the treatment with beef and potassium phosphate. Death is averted and the organism is enabled to hold its own during the period of low vitality. *Oxytricha*, in a similar period of vegetative exhaustion, responds to a greater degree to stimulation, not only is death pre-

vented but the vegetative elements again become active, and a comparatively high division rate follows, though not for a continued period. *Paramecium aurelia* shows a still higher degree of sensitiveness of the protoplasm. As a result of treatment with salts, the protoplasm renewed its activities, a high division rate followed, and this condition continued through a period of six months. Such a marked response to stimulation brings us close to the facts of artificial parthenogenesis. The unfertilized egg may be considered to be in a state of physiological depression, its vegetative activities are undeveloped and unless some stimulus is given, it will die. Experiments have shown that through treatment with salts, the egg renews its activities, divides, and development follows as if normal fertilization had taken place. Thus, if an unfertilized egg is stimulated artificially to develop, the term artificial parthenogenesis is applied. If a protozoan is artificially stimulated to renew its weakened activities, the term artificial rejuvenation is used. Both terms apply to different degrees of the same protoplasmic reaction, and are relative only. Artificial rejuvenation must be applied to the condition found in *Tillina* as well as to those of *Oxytricha* and *Paramecium*. The term cycle, likewise, is relative only. If we can speak of but one in the life history so far known in *Tillina*, why should we speak of more than one in the history of *Paramecium* or *Oxytricha* where the difference in the vitality of the protoplasm is one of degree only? Enough consideration has not been taken of the fact that not only does each individual vary in its degree of sensitiveness at different periods in the life history, suggested by Towle, and shown by the rhythms of Woodruff, but each individual of the same species as well as of different species has its own peculiar protoplasmic reactions.

Woodruff himself, has failed to consider this fact in his last paper on the effects of a varied environment on *Paramecium*. He has carried a culture of *Paramecium* for a year on a medium that has been constantly changed, and so far he finds no indication of any marked periods of weakness such as Calkins found appearing at fairly regular intervals in those forms kept on a constant hay infusion diet. From this Woodruff concludes that the unchanged diet was abnormal, and caused the periods of low vitality which

have been prevented in some way from appearing in the protoplasm of individuals kept on a varied medium. He can not logically compare his results with those of Calkins for he is not dealing with the same protoplasm, and unfortunately he carried no control series on a hay infusion diet. As a result, although his own conclusions are not thoroughly established, he has given added proof of the individuality of the protoplasmic reactions of Paramecium.

Thus we have all gradations in the response of protoplasm in a state of vegetative exhaustion to an artificial stimulus. The facts of the weak response of the slightly sensitive protoplasm of *Tillina* stand at one extreme, and the facts of artificial parthenogenesis involving an extremely sensitive protoplasmic condition, at the other extreme. The terms that have been applied to one set of facts must be applied alike to all and as a result they can have no definite meaning. Above all, the facts of the varying degrees of sensitiveness of the protoplasm of individuals of the same species as well as of different species must be kept in mind in interpreting changes that take place during the life history of an organism.

The "Kernplasma" Relationship Theory.

In 1903, Hertwig stated his theory of the "Kernplasma" relation, which, briefly, is as follows: In a normal condition there is an established balance between nuclear and cytoplasmic mass, brought about by a continual interchange of nuclear and cytoplasmic material. This balance is unstable, and under certain conditions, such as starvation, overfeeding, or change in temperature, it is lost, and there arises an excess of nuclear or of cytoplasmic material as the case may be. As a result of this abnormality, the cell is unable to carry on its ordinary metabolic activities. Finally it falls into a state of depression, which will ultimately result in death unless certain regulatory processes take place, which will restore the normal size relations. This normal condition may be brought about by a self-regulatory process of the cell itself, in which the enlarged nucleus gives up some of its excess material to the cytoplasm, or vice versa; or the normal relations may be restored by the introduction of a foreign element

through conjugation. This is the only means of recovery from deep depressions. Thus conjugation is a regulatory process to bring about the normal relations between the nucleus and cytoplasm. Upon this theory, Hertwig has founded his theory of the origin of sex cells and the determination of sex. Thus Hertwig believes that an excess of nuclear material is the cause of the periods of depression; that conjugation is the means of relieving this depression, and that the conjugating cell is equivalent to a depression cell.

In a recent paper, Popoff ('07), a student of Hertwig, reaches the following conclusions:

A culture of *Stylonychia*, kept from April 1 to July 16, showed periods of high vitality, which alternated with periods of low vitality, or depression periods. These latter periods were accompanied by a cessation of the ordinary life processes, also by morphological changes.

These morphological changes included a great reduction of the body size, from 360-320 to 90-200 μ and also a correspondingly large increase in the size of the macro-nucleus. This change in the size relations he considers the cause of the depression periods.

As the depression periods became more and more serious, fewer individuals were able to rally by a self-regulatory process, which took place by a fragmentation of the nucleus, or by a direct expulsion of nuclear material into the cytoplasm.

The tendency to conjugate is found only in deepest depression periods, and is the means of restoration to normal conditions.

Popoff has made his curve of the general vitality from daily records of the division of ten individuals, and finds that in the life history of three months and a half, five periods of depression appear, the first and second a month apart and the last three two weeks apart. Changes in food or temperature often cause fluctuations in the daily records and a curve made from such records is hardly as reliable as one made from the records averaged for a longer period. If the curve of *Stylonychia* is plotted from average records of five or ten day periods, it will be found to correspond to the curves of *Paramecium*, *Oxytricha* and *Tillina*, each showing the rhythmic periods of high and low vitality. (See Diagram V.)

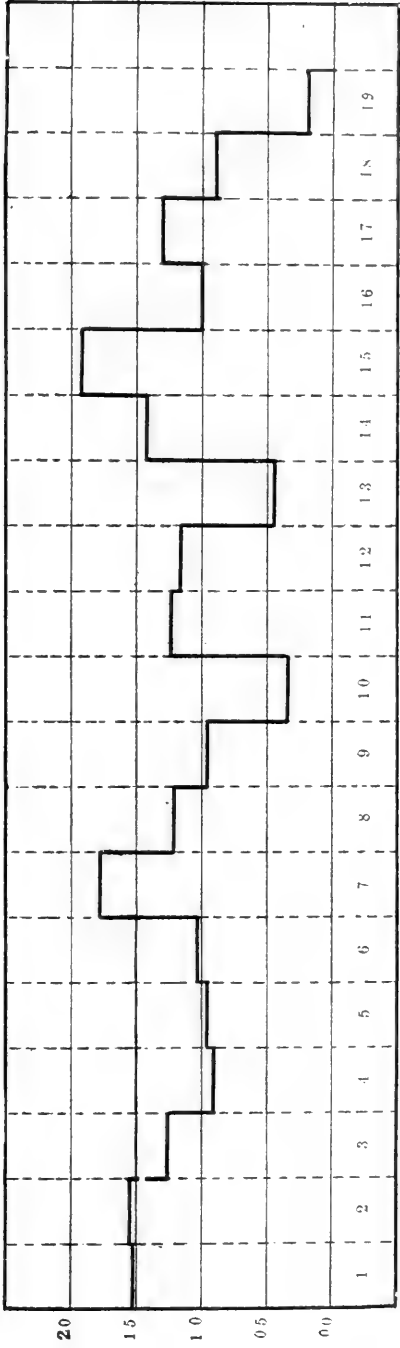

DIAGRAM V

Complete history of *Stylonychia*. The curve is plotted from the records of Popoff. Rate of division averaged for five-day periods. Periods 4, 10, 13, 16 are the "deep depression" periods of Popoff.

The first four of the depression periods of Popoff (e.g., periods 4, 10, 13, 16) are merely the periodic falls in the division rate that occur in the normal rhythms, and from which recovery is autonomous. Such periods are not to be confounded with the serious periods of low vitality, which end in the death of all, unless some external influence, such as artificial stimulation or conjugation takes place.

Calkins found in his study of *Paramecium* that conjugation took place during the period of maturity, after a number of divisions had been passed, and before a decrease in vitality had begun. The cell at this time of maturity is recognized by a certain "miscible" quality of the protoplasm which is characteristic of many conjugating cells. This cell, however, is not a degenerate cell, but a mature cell in a physiological condition such that unless it is stimulated by conjugation or artificially by chemical or mechanical means, it may degenerate and die.

Popoff states that there is a great decrease in size during the periods of low vitality. He states that the size varies from 360μ to 90μ , but he gives no definite data for definite periods, and no data regarding the great increase in the size of the macro-nucleus, or the change in the ratio between the size of the nucleus and that of the cell body.

With the view of investigating the relation of nucleus and cytoplasm to the general vitality, I have made measurements of all the material which I have preserved, obtaining the length and breadth of both nucleus and cell in every case. Unfortunately the accurate dates of the early material were not kept, and could not be used. Material was found, however, which was taken from 20 ten-day periods. The ratio for each individual was computed and the average made from the ratios of all the individuals of that period. An example may make the method more clear. One of the individuals of the 26th period measured 120μ in length (=L) and 70μ in breadth (=W), and the nucleus measured 45μ in length (=l) and 20μ in breadth (=w). The ratio was written as follows: $L : W :: l : w = \frac{120}{70} \times \frac{20}{45} = 761$ the

coefficient or resultant. Eighteen individuals belonged to this period, and the eighteen results were averaged and found to be 825. A curve was then made of the resultants of the twenty periods obtained in a similar manner. If the nucleus ($l:w$) increases in size, the resultant is correspondingly raised; if the nucleus becomes smaller the resultant is decreased, therefore in periods of lowered vitality, when, according to Hertwig and Popoff the nucleus is supposed to have increased greatly at the expense of the cytoplasm, we should expect to find the resultant increased and the curve varying in the opposite direction from that of the general vitality. The two curves in Diagram VI show that the fluctuation of the resultants vary sometimes in the same direction, and sometimes in the opposite direction from those of the general vitality. During the periods 25-31 inclusive, the curve of the resultants is seen to follow that of the division rate, and the actual measurements show that when the body enlarges, the nucleus increases also in size. Usually if the length of the body is longer than the average the length of the nucleus has also increased, and the relationship is the same. During the 26th period, one of fairly high activity, in which the number of divisions per day was 1.6 (16 in ten days), the average length and breadth of eighteen individuals was 132μ and 79μ , of the nucleus, 54μ and 25μ . During a period of slightly less activity, the 36th, when the division averaged 1.3 per day, the average length of six individuals was 126μ , the breadth 77μ , the length of the nucleus 44μ , the breadth 29μ . In this case the size of both the cell and nucleus was diminished.

Again in the 37th period, when the number of the divisions had been reduced almost one-half, the average length of the cell was 148μ , the breadth 96μ , the length of the nucleus 40μ , the breadth 36μ . In this case we see that both the nuclear and the cell size increased, in spite of the fact that the vitality of the protoplasm was diminishing. Finally, in the 38th period, during which the records show almost no division, the beef lines averaging .3 divisions in ten days, the cell body and nucleus enlarged, the length and breadth of the cell body being 183μ and 82μ , and that of the nucleus 56μ and 45μ . The largest individual found belonged to his period, measuring 200μ by 190μ , and the nucleus measuring

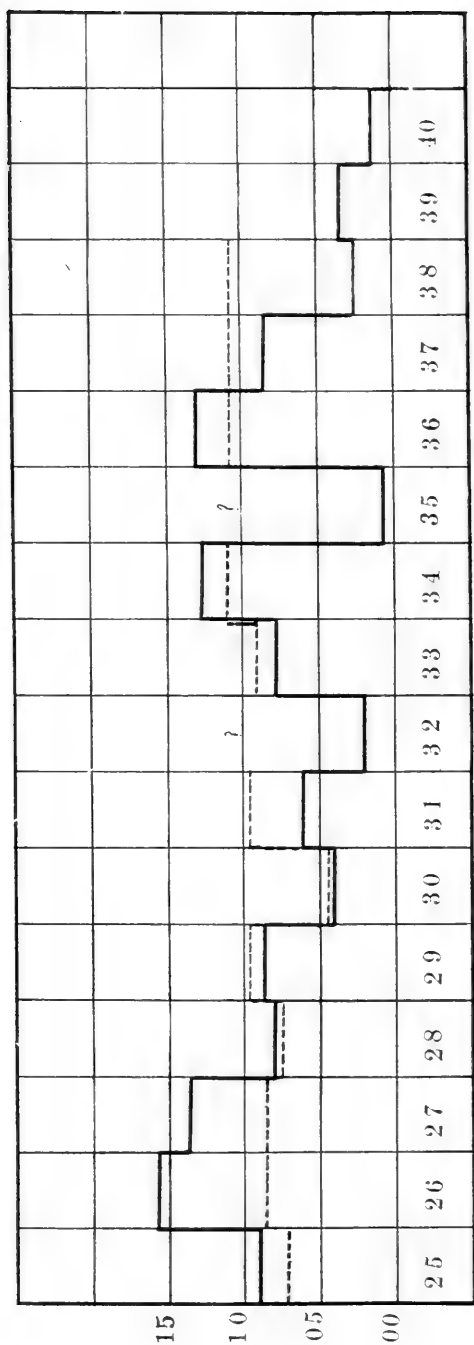

DIAGRAM VI

The continuous line indicates the general vitality of the *B* culture during sixteen ten-day periods. The broken line is the curve made from the averaged results of the ratio $L : W = 1 : w$, obtained from individuals of the corresponding ten-day periods. No records were available for the 32d and 35th periods.

100 μ by 50 μ . These facts seem to prove that there is no relation between the amount of nuclear material in the cell, and the general vitality of the protoplasm. In other words, the periods of weakness are not caused by an excess of nuclear material. The nucleus may or may not increase in size during periods of low activity; if an increase does take place, it is generally found that the cytoplasmic material has increased also, and the ratio between the two is the same as in the periods of high activity. Formerly it was thought that as age advances the cells diminish in size. Woodruff, however, found that there is no diminution in size until just before death, the shrinkage then being normal, since the metabolic functions had practically ceased. I have found a similar condition in the protoplasm of *Tillina*. The size averages of nucleus and cytoplasm are practically the same throughout the life history.

Finally, in order to make my points clear, I will summarize the chief differences between the results of Popoff and my own.

If the curve of *Stylynychia* made from Popoff's data is plotted in the same manner as that of *Tillina*, it will be found that four out of the five so-called depression periods resolve themselves into normal rhythmic fluctuations, from which recovery takes place without external influence, and Hertwig and Popoff are quite wrong in considering them "depression periods" in Calkins' sense. The fifth period which marks the end of the cycle may or may not have been a true period of depression, as all died, not being stimulated in any way.

Actual measurements of *Tillina*, show that during normal fluctuating periods, the so-called "depression periods" of Popoff, as well as in the actual periods of weakness, there is but little and no regular change in the size relations of nucleus and cytoplasm.

The curve plotted from the resultants obtained by averaging the ratios of cell area to nuclear area, shows no definite relation to the curve of vitality as would be expected on the theory of Hertwig and Popoff.

The size of *Tillina* has been found to be practically the same at the end of the life history as at the beginning.

The work of Maupas and Calkins has shown that conjugation does not take place during the depression periods, but prior to

this and at a "period of maturity," a fact indicating that the conjugating cell must not be considered a cell in a state of depression.

Enriques, in a recent paper, has criticised the methods and results of Calkins and Popoff. He is strongly opposed to any theory of physiological and germinal death, and of senile degeneration. He considers all periods of low vitality to be caused by changes in temperature, action of bacteria, or irregularity in giving fresh food medium. In other words, the results of Maupas, Hertwig, Calkins, Popoff and others, he regards as due to poor culture methods.

For the most part, Enriques' criticism has been made with an incomplete understanding of the methods used in these experiments. Popoff, it is true, has given but a meager account of his methods. One *Stylonychia mytilus* was isolated in a watch glass. *Colpidium* was used as food. His methods of preparing and giving the food are as follows:

"Diese Beobachtungen machte ich gelegentlich meiner experimentellen Untersuchungen über das Verhältnis zwischen Kern- und Plasmagrösse bei der Teilung von *Stylonychia mytilus* bei verschiedenen Temperaturen. Genaueres über die in dieser Richtung gewonnenen Resultate werde ich demnächst mitteilen. Dieses holotriche Infusor ist leicht immer in grossen Mengen zu haben, indem man Blätter von Kopfsalat in ein grösseres Glas mit Wasser bringt. Dieselben müssen gut gewaschen sein, um die anhaftenden Cysten möglichst zu entfernen. 2 oder 3 Tage später, nachdem eine schwache Fäulnis in dem Glase sich entwickelt hat, bringt man einige *Colpidien* in die Kultur hinein. Dies genügt, dass nach weiteren 3-4 Tagen die Kultur von *Colpidien* wimmelt. Man muss immer darauf achten, dass die *Stylonychien* eine solche Nahrung nicht vertragen. Man giesst am besten jede 2 Tage die Hälfte von dem Wasser der Futterkultur ab, füllt frisches Brunnenwasser nach und bringt wieder dazu einige frische Salatblätter. Die den *Stylonychien* zugeführte Nahrung muss in kleinen Portionen sorgfältig mit enier starken Lupe durchmustert werden, damit man versichert ist, dass keine anderen Infusorien sich darin befinden. Wird zufällig die Futterkultur durch Oxytrichen oder andere Raubin fusorien verun-

reinigt, so ist sie nicht mehr brauchbar. Das Wasser und die Nahrung der *Stylonychienkultur* muss unbedingt jeden Tag gründlich gewechselt werden."

Enriques makes the following criticism of these methods:

"Die Flüssigkeit ist jeden Tag substituiert, mit Kopfsalatinfus, wo viele *Colpidium* leben; es scheint aber, dass er die kleinen Kulturgläser nicht wechselte; das ist eine sehr wichtige Vorsicht, da die Flüssigkeit die der Glasoberfläche anhängt, oft zu reich an Bakterien ist, so dass es nicht genügt, die Flüssigkeit zu wechseln. . . . Ein Kopfsalatinfus ist kein konstantes Nahrungsmittel, auch wenn es immer eine bestimmte Zeit vor dem Gebrauch präpariert wird; sonst ist auch die Quantität der Nahrungsflüssigkeit nicht konstant, die den Infusorien gegeben wird. Die Temperatur war natürlich nicht konstant. Es folgt von diesen Tatsachen, dass die *Stylonychien* sich mit einer unregelmässigen Frequenz teilen müssen; das wäre nur verhindert, wenn die Infusorien den oben citierten Einflüssen gegenüber nicht so empfindlich wären, wie es zu bekannt ist, um es noch zu betonen. . . . Wir können nicht genau die Zahl der Generationen seiner Versuche berechnen, weil wenn einen Tag 10 *Stylonychien* vorhanden, und später z. B. 15 gefunden, und diese auf 10 wieder reduziert sind, man nicht wissen kann, ob die bleibenden dieselben sind, wie früher, oder Tochterindividuen."

Popoff does not state whether the watch glass was changed at the same time as the medium. If this were not done there would be the possibility of bacterial growth. It is to be supposed, however, that this precaution was taken. Experiments have shown that slight changes in temperature have no effect, in the long run, on the growth of the culture. Popoff states that the temperature varied but 2° during the entire period. Popoff's method of reducing the number of individuals to ten each day is not accurate for daily records. The average for longer periods, however, would be the same whether the number was reduced to ten or one.

Enriques says in regard to Calkins' method:

"Bei Calkins' Versuchen sind die *Paramäcien*, ohne experimentelle Gründe den Bakterien gegenüber als unempfindlich betrachtet; Calkins meint, dass man die Kulturen nur von Zeit

zur Zeit durchsehen brauche, was von seinen Tabellen klar gemacht ist; es ist aber auch klar gemacht, dass genau diejenigen Male, da die Kulturen für mehrere Tage sich überlassen sind, Depressionen erscheinen."

This criticism is based upon a complete misunderstanding of the facts and methods. Calkins says in his studies on the Life History of Protozoa I: "In my experiments one individual is isolated every day or every two days Fresh culture medium is used at every isolation, and a single specimen is transferred to it with as little of the old medium as possible It does no great harm to leave the culture for a longer period than twenty-four or forty-eight hours. The bacterial growth is not detrimental to the Paramecium. The rate of division is, however, slightly reduced on the third day, and very much reduced on the fourth, while the turbidity becomes less and less. If no fresh infusion is added to the slide, division stops altogether, and symptoms of starvation become evident in the Infusoria."

Thus it is not the presence but the absence of bacteria that causes a slower division rate. Periods of low vitality occurred at regular intervals regardless of whether the culture had been examined and changed every day, or every two or three days. Great precaution was taken in all of the experiments to prevent contamination of any kind. "The more apparatus used the greater the danger of injuring the cultures by deleterious foreign matter such as alcohol, acids, other Protozoa, etc. To avoid untold accidents, I am accustomed to wipe dry the slides, cover glasses and cover glass supports, using a clean cloth which is used for no other purpose. The same care is taken with the pipettes I take particular care of the one used for transferring the individual Paramecium from one slide to another."

Enriques may have had some ground for criticising Popoff's methods, and is right in saying "Dass die Versuche von Popoff keine neue Basis für die Degenerationstheorie gebracht haben." The criticism of Calkins' work, however, is based on a false interpretation of the facts, and as a result, is of little value.

The true nature of the relationship between the nucleus and the cytoplasm is still an open question. The results of Gruber, Nuss-

baum, Boveri and others have established long ago, the fact that growth and differentiation cannot take place without the presence of both materials. There has been some evidence that the nucleus actually gives up some of its chromatic material to Protozoa, also in the maturation processes of the egg. Lillie ('02) finds somewhat similar evidence in the developing egg of *Chaetopterus*. In the preparation for the division into two cells, there is a definite flowing of nuclear material into the cytoplasm, to become the granules of the endoplasm. Also in eggs differentiating without cleavage, he finds a definite relation between the microsomes of the cytoplasm and the chromatin of the nucleus, the one originating from the other. These are eggs in an abnormal condition, yet it is of value to find the same processes taking place under forced conditions as in the natural development. Even in *Tillina*, two instances were found where there seemed to be a breaking down of the nuclear membrane at one point, allowing the nuclear material to mingle with the cytoplasm. The individuals were not in an abnormal condition, on the contrary, they were taken at a time of relatively high activity, a condition not to be explained by the theory that the nucleus had become too large in relation to the size of the cell, and was regulating itself by this means.

Boveri ('05) offers what might be considered evidence for Hertwig's theory, namely, that in his experimental studies on larvæ, he finds the cell volume to be proportional to the number of chromosomes, and the number of cells proportional to the chromosomal mass, thus the size of the nucleus would seem to determine that of the cell. He adds, however, that a certain quality as well as quantity of nuclear material is needed to bring about the most favorable results.

Minot in his recent book "Age, Growth and Death" has advanced a theory somewhat similar to that of Hertwig. In brief, he believes that the segmentation of the ovum is a process of rejuvenation, that is, the ovum must be considered an old cell with an excess of protoplasmic material. In order to regain the proper balance between the nuclear and cell size, segmentation takes place, young cells are produced and the nuclear material is increased at the expense of the protoplasm. When this process

ceases there is an excess of nuclear material, and the protoplasm then begins to grow and to become differentiated. This is senescence, which, according to Minot, begins in the two-cell stage. In other words, rejuvenation implies the increase of nuclear material, senescence the increase of protoplasmic material, both processes being due to changes in the size relations of nucleus and cytoplasm. These processes take place especially in the growth and development of the Metazoa. He has little faith in the view that these same processes take place in the Protozoa, and does not accept as final the results of Maupas and Calkins on the degeneration of the protoplasm and the appearance of old age in the life cycle of a protozoan individual. Begging the question, he demands proof of an excess of protoplasmic material in the cells which are in a condition of lowered vitality before he will accept the view of senescence in Protozoa. Hertwig, on the other hand, would have an excess of nuclear material in the cells in a weakened condition. Both investigators are concerned with size relations only, and have failed to recognize the importance of the constant changes taking place in the quality of the nuclear and protoplasmic material. There is certainly a possibility, if not a probability, that they both have confused effect with cause.

In the ordinary metabolic processes of digestion, assimilation, etc., physiological changes are constantly taking place which affect the nature of the nucleus and cytoplasm. If these processes are disturbed in any way, there is, as a result, a detrimental effect upon the character of the protoplasm, and certain morphological changes set in. Calkins has shown that at certain periods in the history of *Paramecium*, the activities connected with the ordinary digestive functions of the cell were affected, and as a result, the macro-nucleus became more dense, and the endoplasm crowded with undigested food particles. This condition would end in physiological death unless salts were given which would stimulate the processes of digestion and enable the cell to resume the normal conditions of growth and division. Again, at a later period, a more serious depression occurred, in which the ordinary digestive functions were not affected, the endoplasm and macro-nucleus being normal, on the other hand the cortical plasm and the micro-

nucleus were abnormal and germinal death followed. In neither case of depression was the size of the nucleus abnormal in its relation to the size of the cell body. Because of these facts, and of those resulting from actual measurements of *Tillina*, it seems more probable that if the nucleus is greatly enlarged as in the case of *Stylonychia*, this must be explained as the result, rather than the cause of the depression, and the definite increase in protoplasmic material which Minot found, is the result of senescence not the cause. In other words, the evidence at the present time seems to indicate that the morphological changes taking place in the cell are due to physiological changes in the metabolic action of the cell.

IX SUMMARY

1 *Tillina magna* is a ciliated infusorian, belonging to the family Chiliferidæ, suborder Trichostomina, order Heterotrichida. Wild material was found but once only in an infusion of horse manure. All attempts to find more material were unsuccessful and the possibility arises that the organism is an intestinal parasite of the horse.

2 The size varies from 100–200 μ in length, and from 70–180 μ in breadth.

3 The organism is recognized easily by the presence of the characteristic dorsal posterior lobe, a portion of which extends as a tongue into the peristomial region, finally disappearing in the floor of the œsophagus. The entire structure is covered with long fine cilia.

4 The surface of the body is covered with striations which indicate the insertion of the cilia. The cilia have their origin in the basal bodies which lie in the cortical plasm at the corners of the raised fields into which the surface of the body is divided.

5 The nuclear structure consists of a large macro-nucleus and a varying number of very small micro-nuclei which lie at the edge of or embedded in the macro-nucleus.

6 Reproduction in *Tillina* takes place by the formation of division cysts, within which the protoplasm divides to form two

or four individuals. This process must be considered an intermediate stage between ordinary division and true sporulation. The formation of two individuals only within the cyst has been found to be an indication of low vitality of the protoplasm.

7 Permanent cysts are formed under certain conditions, such as unusual heat or cold, or lack of food. Experiment shows there is no general rule for the recovery of the normal condition after the organism has formed a permanent cyst. Often the same abrupt changes that caused encystment will bring about the free living condition.

8 Experiments on regeneration also show that *Tillina* possesses a high order of regenerative power. In twenty-four hours an anterior or a posterior half of the body will regenerate its lost half, and divide to form two daughter individuals.

The few centrifuging experiments that were made demonstrate the lability of the protoplasm. In every case the nucleus was shifted forward, and the pigment which ordinarily was present only in the posterior lobe, was scattered throughout the protoplasm, or sent in a mass to the anterior end.

9 Conjugation was not observed, although all possible means to bring about favorable conditions were employed.

10 Two cultures of *Tillina magna* have been carried on. Culture A, consisting of 210 generations, extended from November 1, 1906, to February 18, 1907; culture B extending from November 1, 1906, to December 15, 1907, having passed through 548 generations. The life history of each culture is represented by a curve plotted from the averages of the four lines in each culture, and again for ten day periods.

11 The curve which represents the general vitality of the protoplasm shows the normal rhythmic fluctuations observed by Woodruff.

12 The protoplasm of *Tillina* is not as sensitive to changes in environment as that of other forms. Treatments with K_2HPO_4 , beef, pancreatin, calf's brain, caused only a slight increase in the division rate. Rejuvenation took place, but only to a slight degree. Since the term rejuvenation must be a relative one only, the term cycle loses its value, and we may consider the life histories of *Tillina*, *Paramecium* and *Oxytricha* as composed of one cycle.

13 Each protozoan individual has its own characteristic degree of sensitiveness that differs from all others of the same family, as well as from all others of different species.

14 Actual measurements of nuclear and protoplasmic size, at different stages in the life history, show that there is no relation between an excess of nuclear material and a period of low vitality. Such periods of weakness may or may not be accompanied by changes in the size relations of the nuclear and cytoplasmic material, in no way are they caused by such variations. The true cause must be sought in the physiological not morphological changes taking place within the cell.

Zoölogical Laboratory,
Columbia University,
January, 1909.

LITERATURE

- BESSENBARGER, E. '03—Ueber Infusorien aus asiatischen Anuren. Arch. f. Protistenk.
- BOVERI, TH. '05—Zellenstudien, v.
- BÜTSCHLI, O. '76—Studien über die ersten Entwicklungsvorgänge der Eizelle der Zelltheilung, und der Conjugation der Infusorien. Abh. d. Senckenb. nat. Gesellsch. Frankfurt a.M., x.
- '83—Protozoa. Bronn's Klassen und Ordnungen des Thierreichs.
- '94—Protoplasm and Microscopic Foams.
- CALKINS, G. N., '01—The Protozoa. Columbia University Press.
- '02—Studies on the Life History of Protozoa. I. The Life Cycle of *Paramœcium caudatum*. Arch. f. Entwicklungsmech., xv.
- CALKINS AND LIEB '02—Studies on the Life History of Protozoa. II. The Effect of Stimuli on the Life Cycle of *Paramœcium caudatum*. Arch. f. Protistenk, i.
- CALKINS, G. N. '02—Studies on the Life History of Protozoa. III. The Six-hundred and Twentieth Generation of *Paramœcium caudatum*. Biol. Bull., iii.
- '04—Studies on the Life History of Protozoa. IV. The Death of the "A" Series of *Paramœcium caudatum*. Conclusions. Journ. of Exp. Zoöl., i.
- '06—The Protozoan Life Cycle. Biol. Bull., ii.

- COHN, F. '53—Beiträge zur Entwicklungsgeschichte der Infusorien. Zeit. f. wiss. Zool., iv.
- ENRIQUES, P. '08—Die Conjugation und sexuelle Differenzierung der Infusorien. Archiv. für Protistenkunde, xii.
- EVARTS, E. '73—Untersuchungen an Vorticella nebulifera. Zeit. f. wiss. Zool. xxiii.
- GREENWOOD, M. '94—On the Constitution and Mode of Formation of "Food Vacuoles" in Infusoria, as Illustrated by the History and Processes of Digestion in Carchesium. Phil. Trans., 1894.
- GRUBER, A. '79—Neue Infusorien. Zeit. f. wiss. Zool., xxxiii.
- HERTWIG, R. '03—Ueber Korrelation von Zell- und Kerngrösse und ihre Bedeutung für die geschlechtliche Differenzierung und die Teilung der Zelle. Biol. Cent., Bd., xxiii.
- JOUKOWSKY, D. '98—Beiträge zur Frage nach den Bedingungen der Vermehrung und des Eintrittes der Konjugation bei den Ciliaten. Vehr. Nat. Med. Ver. Heidelberg, xxvi.
- KENT '80—A Manual of Infusoria, ii.
- LILLIE, F. R. '92—Differentiation without Cleavage in the Egg of the Annelid *Chætopterus pergamentaccus*. Arch. f. Entwickl. mech., xiv.
- '06—Observations and Experiments concerning the elementary Phenomena of Embryonic Development of *Chætopterus*. Journ. of Exp. Zoöl., iii.
- MARCUS '07—Ueber den Aggregatzustand der Kernmembran. Gesellschaft Morph. und Phys. München. I.
- MAIER, H. N. '03—Über den Feinen Bau der Wimperapparate der Infusorien. Arch. f. Protistenk., iii.
- MAUPAS, E. '89—Le rajeunissement karyogamique chez les Cilliés, Arch. d. zoöl. expér. et gén. 2me sér., vii.
- '88—Recherches expérimentales sur la multiplication des Infusories ciliés. Arch. d. Zoöl. expér. et gén. 2me sér., vi.
- METALNIKOFF, S. '03—Über die intracelluläre Verdauung. Sebastopol, vi.
- MINCHIN, E. A. '03—The Sporozoa. Treatise on Zoölogy. Lankester, i.
- MINOT, '08—Age, Growth and Death. Putnam, N. Y.
- PETERS, A. W. '04—Metabolism and Division in the Protozoa. Proc. Amer. Acad. Arts and Sci., xxxix.
- POPOFF, M. '07—Depression der Protozœnzelle und der Geschlechtszellen der Metazoen. Arch. f. Protistenk., sup., i.
- RHUMBLER, L. '88—Die verschiedenen Cystenbildungen und die Entwicklungsgeschichte der holotrichen Infusoriengattung Colpoda. Zeit. f. wis. Zool., xlvi.
- SCHEWIAKOFF, '89—Beiträge zur Kenntniss der holotrichen Ciliaten. Bibliotheca Zool. Heft. 5

- SCHUBERG, '05—Ueber Cilia und Trichocysten einiger Infusorien. Arch. f. Protistenk., vi.
- STEIN, F. '83—Der Organismus der Infusionsthiere. Leipzig.
- TOWLE, E. W. '04—A Study of the Effects of Certain Stimuli, Single and Combined, upon Paramecium. Amer. Jour. of Physiol., xii.
- WOODRUFF, L. L. '05—An Experimental Study on the Life History of Hypotrichous Infusoria. Journ. Exp. Zoöl., ii.
- '08—Effects of Alcohol on the Life Cycle of Infusoria. Biol. Bull., xv.
- '08—The Life Cycle of Paramecium when subjected to a varied environment. Am. Naturalist vol. xlii.

PLATE I

Fig. 1 Dorsal view of *Tillina magna* showing general external characteristics as well as the character of cortical plasm, endoplasm, and micro-nuclei lying near, or embedded in the large macro-nucleus. $\times 560$.

Fig. 2 Ventral view of *Tillina magna* showing especially the region of the mouth peristome and œsophagus, with the tongue-like continuation of the posterior lobe on the floor of the peristome and continued through the mouth, disappearing finally in the floor of the œsophagus. $\times 560$.

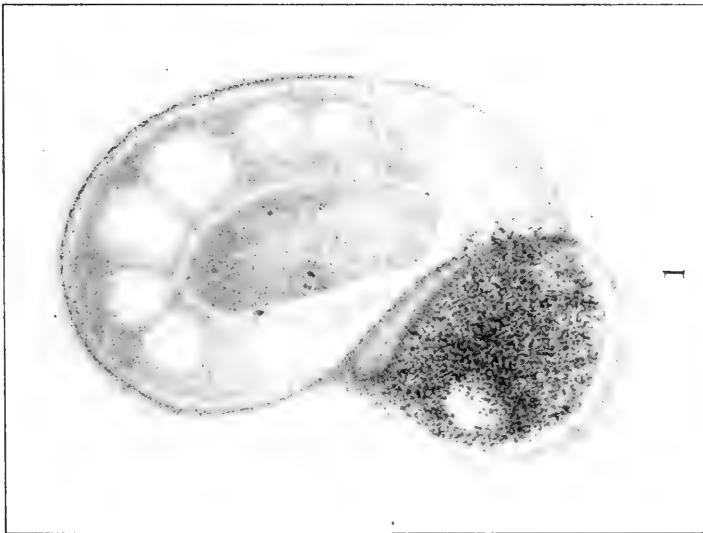
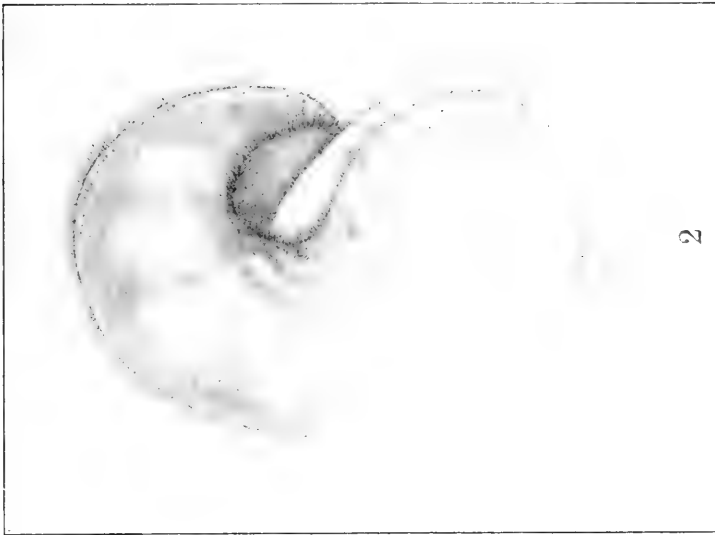

PLATE II

Photographs showing different stages in the process of encystment for division. Figs. 1, 2, 3 were taken with the same magnification. Fig. 4 was taken with a higher magnification.

Fig. 1 A section through an individual encysted for division. The macro-nucleus has elongated and has become constricted. The first division plane is shown appearing at right angles to the long axis of the nucleus. Food vacuoles in different stages of digestion are shown. $\times 450$.

Fig. 2 A section showing the beginning of the second division plane. $\times 450$.

Fig. 3 Section through an encysted form which has divided twice to form four individuals. Portions of the four individuals are seen. The nucleus shows in but two. $\times 450$.

Fig. 4 Section through an encysted form which has divided twice. Three of the four individuals show. The beginnings of the ciliated mouth regions and the nuclei are visible. $\times 530$.

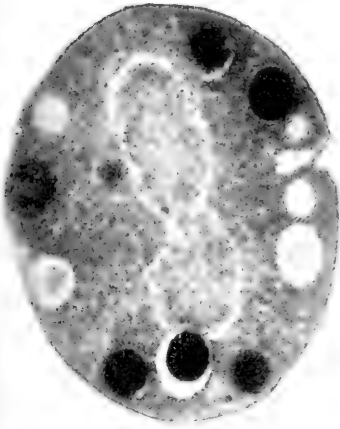

FIG. 1



FIG. 2



FIG. 3

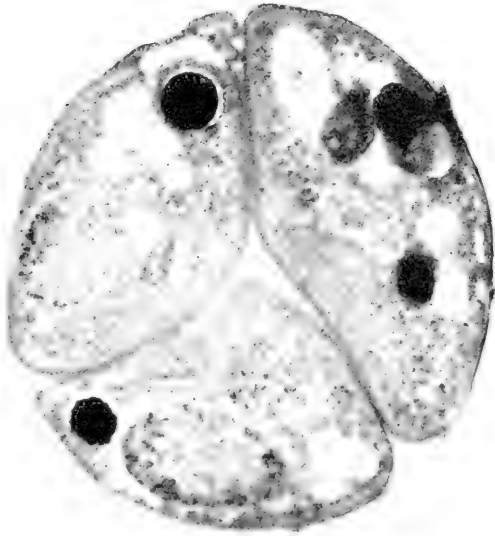

FIG. 4



STUDIES OF TISSUE GROWTH

II FUNCTIONAL ACTIVITY, FORM REGULATION, LEVEL OF THE CUT, AND DEGREE OF INJURY AS FACTORS IN DETERMINING THE RATE OF REGENERATION. THE REACTION OF REGENERATING TISSUE ON THE OLD BODY

BY

CHARLES R. STOCKARD

Pathological Laboratory, Cornell University Medical College, New York City

WITH ONE PLATE AND EIGHT FIGURES IN THE TEXT

I	Introduction.....	433
II	Material and methods.....	434
III	The influence of activity and rest on the rate of regeneration.....	435
IV	Form regulation and arrest of regenerative activity in pieces of the medusa disk.....	438
V	Relation of the level of the cut to the rate of regeneration.....	442
VI	Relation of the degree of injury to the rate of regeneration.....	446
VII	The relation between the rate and amount of regeneration and the physical condition of the animal body.....	462
VIII	Summary and conclusions.....	466
IX	Literature cited.....	468

I INTRODUCTION

The present contribution is the second of a series of studies aiming towards an analysis of the factors controlling the rates and limits of tissue growth. The problem is complex, yet the investigator has full access to experimental methods in considering the processes of regenerative growth. Factors regulating regeneration are probably identical with those determining primary or generative growth and if the former could be identified and controlled it might become possible on the one hand to maintain some forms of growth indefinitely or on the other to suppress certain excessive growths of a pathological nature.

My ('08) previous study on regeneration in the Scyphomedusa, *Cassiopea xamachana*, considered the influences of certain internal factors on the rate of regenerative growth. The present account is also concerned with the rate of regeneration in *Cassiopea* and in addition includes a study of two species of brittle stars, *Ophiocoma riisei* and *Ophiocoma echinata*.

The level at which the cut is made determines the rate of the ensuing regeneration in the three animals employed. The nearer to the center of the body the tissue is removed the more rapidly will the regenerating tissue grow. An arm regenerates at a faster rate when amputated near its base than when amputated at a more distal point. The growth of the new tissue gradually becomes slower, however, as the original size is approached. An analogy is found in embryonic growth, the smaller embryo increases proportionately much more rapidly in size than does the larger and older embryo. The rate of increase becomes continually slower as the adult size is approached and finally growth ceases at this limit.

The relation between the extent of injury and the rate of regeneration will be considered in each of the three species. Finally, the evidence furnished by animals regenerating different amounts of tissue will be reviewed in order to ascertain the nature of the influence exerted by the new growing tissue over the old body substances.

The experimental part of the investigation was conducted in the Biological Station of the Carnegie Institution at Tortugas, Fla. I wish to express my thanks to the Director, Dr. Alfred G. Mayer, for the facilities supplied for this work and for his kindness in preserving the ophiurans after I had gone from the laboratory. The remainder of the work has been done in the Pathological Laboratories of Cornell University Medical College for the Huntington Fund for Cancer Research.

II MATERIAL AND METHODS

The medusæ are abundant in the somewhat stagnant water of the moat surrounding the old fort at Dry Tortugas Islands. This

animal is hardy and very resistant, being kept with ease in aquaria where the water is changed on alternate days. In fact *Cassiopea* remains in better condition when the water is not changed too often since excessive agitation is detrimental to their welfare. They were kept in four-liter battery jars, one or two individuals in each jar, and were not fed during the time of the experiment.

The brittle-stars are also abundant at Tortugas being readily obtained in hundreds on the coral reefs. Four species were selected for experiment, two of which proved unfavorable on account of a tendency to throw off their arms.

It was impossible to keep the ophiurans in a healthy condition in the battery jars which serve so well for *Cassiopea*. Equally unsuccessful attempts were made to keep these species in large aquaria tanks supplied with intermittently running water. Floating "live-cars" were finally resorted to and these proved highly successful. The "live-cars" were about 2 m. long by $1\frac{1}{2}$ m. wide and were divided by means of plank partitions into small compartments about 30 cm. square, thus facilitating the separation of the several groups used in the experiments. In each compartment was placed a small coral rock beneath which the animals might hide, so providing a practically natural environment. These coral rocks contained in their cavities many small animals, crustaceans, worms and molluscs, which doubtless furnished food for the brittle stars, since they all increased in size during the forty-nine days spent in the "live-cars." The conditions of the reef were further imitated by the movements of the waves which kept the water in the cars constantly changing and fresh.

III THE INFLUENCE OF ACTIVITY AND REST ON THE RATE OF REGENERATION

The relation of activity and rest to the rate of regeneration was considered in my first paper on regeneration in *Cassiopea*. The question seemed to be one of some interest since several authors had attributed importance to activity as a probable factor in determining certain qualities in regeneration. The pulsating disk of *Cassiopea* is so exceptional an object for testing such a question

that I determined to repeat my former experiments on a somewhat more extended scale.

The experiments consisted of three sets of equal sized individuals operated upon as follows. With the central point of the disk as a center a circular mass of tissue was removed leaving a pulsating ring of tissue with its outer periphery parallel to the inner cut circle, therefore, all parts of the inner cut are at similar levels (Fig. 1) Some medusæ had the sense organs removed from the periphery so that the entire ring ceased to pulsate (Fig. 2). Other

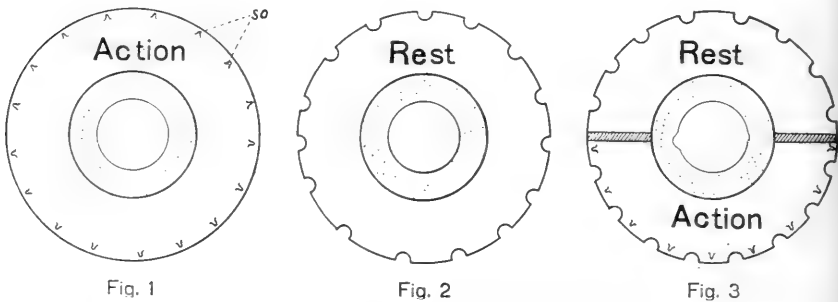

Fig. 1 A medusa disk with the center cut away. The ring pulsates and regenerates new tissue to cover the central space. *SO*, sense organs.

Fig. 2 A similar preparation with the sense organs removed and in a state of inactivity. The central space is covered equally fast by regenerating tissue.

Fig. 3 A ring-preparation with one-half active and the other half inactive. Tissue is regenerated equally fast from the two halves. The new tissue is stippled in all of the figures.

individuals had the sense organs cut from one-half of the periphery and equal sized pieces of tissue from the other half so as to make the extent of injury equal, the half without sense organs was then insulated from the stimulus of the other half by scraping off the oral epithelium between them (Fig. 3). One-half of the preparation now pulsates normally and the other remains at rest. Care was taken to prevent the scraped epithelium from regenerating between the two halves and so reestablishing the pulsation in the quiet half. The conditions in the two halves are as near as possible identical and permit of free comparisons since we are considering two similar parts of one individual which differ only as the experiment provides. The error due to individual differences

which arises when several individuals are compared is in this way eliminated.

Fifteen medusæ 90 mm. in disk diameter were divided, May 21, into three groups of five each. Fifteen others each 105 mm. in diameter were similarly grouped and the three groups prepared as above described.

Two days later, May 23, the average growth from each group was 3 mm. in width. After four days the tissue averaged about 7 mm. in width in each group, the central spaces being almost covered over. The preparations with one-half in motion and one-half at rest had equally wide bands of tissue growing from the two halves. In almost all cases, however, there was a slight indentation in the new tissue just over the place where the insulation was made by scraping the epithelium between the two halves (Fig. 3).

Comparing the average amounts and rates of regeneration in these three classes of preparations it is found that tissue grows from the circular cut to cover the disc center at equal rates from the rings in motion, the rings at rest, and the rings with one-half in motion and the other half at rest. There is no influence due to functional activity on the rate of regeneration in *Cassiopea*. It follows, therefore, that the effort to use an organ or the more urgent need of it probably does not cause its more rapid re-formation.

Zeleny has also performed experiments on *Cassiopea* to test the influence of functional activity on the rate of regeneration. His experiments differ from mine in that all comparisons were made between different individuals and that he established in the specimens a rhythmical pulsation which generally ceased before the close of the experiment. In my work the normal periodic pulsation of the disk was utilized and it, of course, persisted throughout the experiment. Although Zeleny used only a few individuals his results agree with mine in that he finds the specimens at rest to regenerate tissue equally as rapidly as do those in action. In some of his cases the resting specimen had a slight advantage over the one in motion, although this may easily have been due to individual differences since such a source of error is not sufficiently controlled.

My former results are in harmony with those recorded above and all go to indicate that functional activity exerts no influence over the rate of regeneration in *Cassiopea*.

IV FORM REGULATION AND ARREST OF REGENERATIVE ACTIVITY IN PIECES OF THE MEDUSA DISK

Many experiments were performed to test primarily whether heteromorphosis occurs in the regeneration of disk tissue in *Cassiopea*. It was thought, for example, that narrow peripheral strips might regenerate a heteromorphic border or periphery and thus form two parallel lines of sense organs instead of regenerating a new center or an entire disc. No indication whatever of heteromorphic regeneration was observed from strips or pieces cut in various patterns. A most striking regulatory tendency was, however, discovered in these pieces.

Pieces of the disks of various shapes, V-shape, bias-cut strips and equilateral triangles all regenerate new tissue from their cut edges. Before the process of regeneration has proceeded far these pieces begin to twist and bend in such a manner as to approach as nearly as possible the circular disk shape of an entire medusa. After the circular shape is attained the miniature disk pulsates like an ordinary disk. The new regenerative growth which had begun so vigorously suddenly ceases and only the tissue necessary to cement the cut edges into the disc form is proliferated. If, however, any of these pieces be prevented from assuming the circular disk-like shape the regeneration from the cut edges continues for some time forming a broad mass of new tissue. It is conceivable, although it has not been observed, that the new tissue might continue to grow until a disk was formed in which the old piece would occupy an area comparable to its former position in the original disk provided enough reserve substance was present to make so extensive a growth possible.

A long bias-cut strip of disk border (Fig. 4A) regenerates tissue from its cut edge most rapidly at the wide end and gradually slower as the narrow end is approached, being slowest at that point. Such a strip when forced to maintain its linear shape

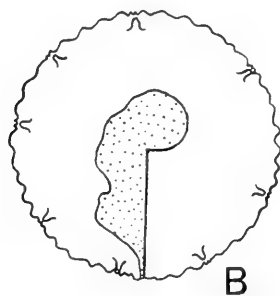
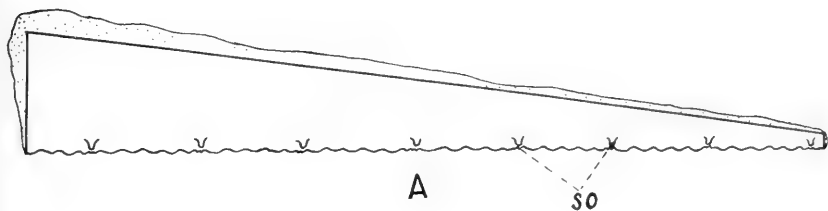
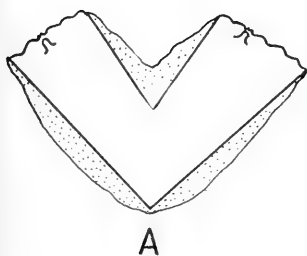
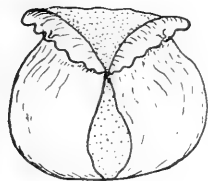

Fig. 4



A



B

Fig. 5

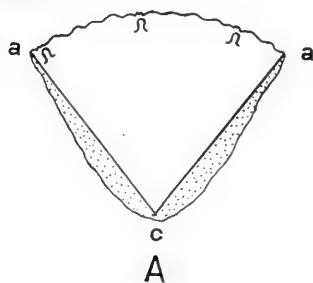

A



B

Fig. 6

Fig. 4 *A*, Bias-cut strip of tissue from the periphery of a Cassiopea disk. Regenerating tissue stippled. *SO*, sense organs. *B*, the form assumed by the strip *A*, its nearest approach to the original disk-shape.

Fig. 5 *A*, V-shaped portion of the Cassiopea disk, regenerating along the cut edges. *B*, a pulsating cup-like body formed by the V-pattern and its newly regenerated tissue.

Fig. 6 *A*, an equilateral triangle cut so that one of its sides contains sense organs from the Cassiopea disk border. *B*, the pulsating cup-shaped body formed by the triangle. Angles *a-a* are brought together and the apex *c* forms the base of the cup. Regeneration in all of the preparations stops when the circular form is completed.

regenerates a wide mass of tissue. When undisturbed the narrow end soon becomes bent around towards the new tissue forming at the wide end and fuses with this in such a way as to finally adjust the entire mass into a circular shape; the original portion of disk border forms the periphery of the miniature disk (Fig. 4B). The narrow end oftentimes folds too far and projects beyond the wide portion. This imperfection is readjusted within a few days by a process of puckering and subsequent flattening out of the tissue. The newly formed tissue serves to unite the cut margins and appears in the body of the small disk as only a limited amount. The new tissue never continues to grow and cause folds or puckers in the surface of the disk after the final assumption of the circular form, but its growth is inhibited and stopped as it were by the attainment of this shape.

A V-shaped piece cut from the periphery towards the center of the *Cassiopea* disk regenerates new tissue from the inner cut angle and from its outer borders. The tops of the two arms are parts of the original disk periphery containing sense organs which cause the entire tissue of the V to pulsate (Fig. 5A). The nearest possible approach to the disk-shape of the medusæ that can be attained by the V-pattern is a circular cup form. Such a form is always assumed and its mode of development is somewhat as follows. The newly regenerated tissues on the sides of the inner angle of the V fuse, the apex then becomes bent owing to a tendency to curl and the direction of this curl determines whether the oral or aboral surface shall form the outer surface of the cup. The new tissues from the outer edges of the V then fuse along their borders as well as with the upturned apex. Thus the circular cup is formed having the folded apex as a base, its wall of the old V-arms and newly regenerated tissue and its peripheral border of the old disk peripheral parts with sense organs and the edge of the new tissue (Fig. 5B). The cup pulsates in a manner similar to a medusæ disk. Here again the regeneration of new tissue is stopped when the walls are completely fused. Growth does not continue and cause the cup wall to be thrown into folds, although the prevention of the cup-shape would allow many times the amount of new tissue present to be formed.

Small equilateral triangles cut so that a portion of the disk periphery forms one side of the triangle (Fig. 6A) will pulsate and finally form cup-shaped bodies. The cup-shape is here again the nearest possible approach to the circular medusa form. New tissue regenerates from the two cut edges, *ac ac*, of the triangle and a tendency of the piece to fold or roll up brings together the apices *a-a* formed by the disk periphery and the cut sides. These two apices of the triangle unite and the third apex *c* folds over so as to form the base of the cup. The wall of the cup is completed by the fusion of new tissue from the two cut sides *ac ac* of the triangle (Fig. 6B). In this case again the new tissue ceases to grow after the cup-shape becomes established.

These experiments with the three differently shaped pieces of medusa-disk were repeated a second time, and in all ten pieces of each shape were employed, but no deviation from the above descriptions was observed. The conclusion is evident that these disk pieces possess a high degree of regulatory ability and in all cases tend to assume as near as possible a circular shape approaching the original disk form. The fact is of importance that this regulatory tendency seems to possess the power of controlling or inhibiting regenerative activity. Regenerating tissue ceases to grow when the circular form is attained.

The writer does not pretend to explain this peculiar fact, though it is probably comparable to the adjustment existing in normal organisms, which prevents certain tissues from growing to an extent that would cause them to become displaced. An excessive proliferation of tissue from any organ would destroy the usual body symmetry but the interaction of some unknown complex of factors maintains a morphological equilibrium and prevents such occurrences. At times this equilibrium is disturbed and hypertrophy or excessive tissues result. It is important to note that these small pieces of medusa disk possess this power of perfect coördination.

V RELATION OF THE LEVEL OF THE CUT TO THE RATE OF REGENERATION

Experimenters have found that the rate of regeneration varies with the level of the cut in such widely different animals as the medusa, earthworm, starfish, fish and amphibians. The nearer the periphery of the body or distal end of an appendage the amputation is made the slower will be the rate of ensuing regenerative growth. The rate of regeneration, therefore, varies directly with the depth of level, the deeper the more rapid will be the rate. A similar principle is found in embryonic growth, the nearer the adult body size is attained the slower is the rate of growth until in many animals growth finally stops entirely. In regeneration the more the normal size or body limit is disturbed by the operation the more rapid will be the growth to reform it and the slower this growth becomes the nearer the regenerating part approaches the original size.

My former paper on regeneration in *Cassiopea* presented many facts in favor of this principle. It was shown that cut surfaces on the same disk when at different distances from the center regenerate new tissue at rates depending upon the level of the cut. In this circular disk-shaped body one is able to compare the rates from different levels on the same individual and so eliminate the common source of error due to individual differences.

The differences in rates of regeneration from different parts of variously shaped cuts in the bodies of these medusæ are comparable to those differences in rates found by Morgan ('06) in similar cuts on the fins of fishes.

To test further the relation of the level of injury to the rate of regeneration additional experiments have been performed on the body of *Cassiopea* and on the arms of the two species of ophiurans, *Ophiocoma riisei* and *Ophiocoma echinata*, with the decidedly positive results given below.

The peripheral borders were cut from ten medusa disks so as to remove strips 10 mm. wide from one-half and 20 mm. from the other (Fig. 7). After regeneration had proceeded for seven days the new tissue was measured. In all specimens it was readily

apparent to the eye that a much wider band of new tissue had grown from that half of the periphery which was cut deeper or nearer the center (Fig.7B). Measurements show that in two cases the band of new tissue from the deep cut is twice as wide as that from the shallow. The average of the eight other cases gives the deep border one and one-half times the width of new tissue from the shallow cut.

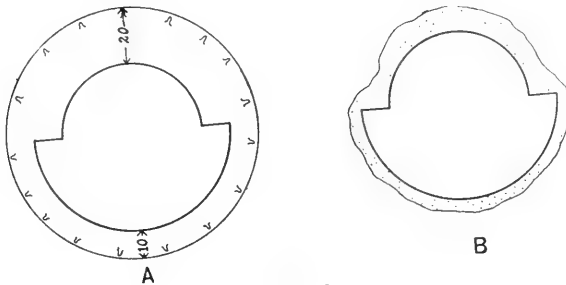

Fig. 7

Fig. 7 *A*, medusa disk with a semi-circular piece 20 mm. wide cut from one-half and a similar piece 10 mm. wide from the other. *B*, the stippled area indicates regeneration to proceed faster from the half cut at the deeper level.

The experiment demonstrates the influence of the level on the rate of regeneration of tissue from two cut surfaces under nearly identical physical conditions. I have shown ('07 and '08) that when a bias-cut strip is removed from the entire periphery of a medusa disk the new tissue regenerating from the strip and that from the remaining disk center is proliferated at the same rate from places on the two preparations which were originally adjacent. The rate of regeneration either towards the periphery or towards the center is, therefore, the same from the same level.

Ten individuals of *Ophiocoma riisei* had four of their five arms removed. One arm was amputated at a point 1 cm. out from its base of attachment to the disk, another 2 cm. from the disk, another 4 cm. and a fourth 5 cm. out. On the same day ten individuals of *Ophiocoma echinata* were similarly operated upon. These brittle-stars have one uninjured arm and the other four cut

at different levels. The extent of injury is the same in all individuals.

Forty-nine days after the operation the specimens were killed, fully extended in chloretone and measured. Tables I and II contain the results of the measurements. The tables show that the arms have regenerated from 25 mm. to 50 mm. in length. Such a length makes the error in measurement slight.

TABLE I

Rates of arm regeneration at different levels in the brittle-star, Ophiocoma echinata

DISK DIA. IN MM.	ARM-STUMP 1 CM. LONG		ARM-STUMP 2 CM. LONG		ARM-STUMP 4 CM. LONG		ARM-STUMP 5 CM. LONG	
	New growth in mm.	Sp. Rate	New growth in mm.	Sp. Rate	New growth in mm.	Sp. Rate	New growth in mm.	Sp. Rate
16	38	2.38	40	2.50	37	2.31	29	1.81
16	33	2.06	31	1.94	35	2.19	23	1.44
16	34	2.13	28	1.75	22	1.38	20	1.25
17	37	2.17	30	1.76	37	2.17	34	2.00
17	32	1.88	31	1.82	26	1.53	25	1.47
17	36	2.12	36	2.12	32	1.88	29	1.71
17	26	1.53	35	2.06	—*	—*	26	1.53
17	35	2.06	38	2.24	34	2.00	—*	—*
18	41	2.28	42	2.33	38	2.11	35	1.94
21	46	2.19	46	2.19	40	1.90	21	1.00
Av.	35.8	2.08±0.05	35.7	2.07±0.05	33.4	1.94±0.07	26.9	1.57±0.07

*Regenerated portion broken and not measured.

The averages for *Ophiocoma echinata* (Table I) show that the nearer the disk the arm is amputated the more rapidly will the subsequent regenerative growth proceed. The arms cut 1 cm. from the disk have grown new buds averaging 35.8 mm. long. The specific amount of regeneration obtained by dividing the length of new tissue by the disk diameters is 2.08. Comparing the average growth from arms cut 5 cm. from the disk, the actual amount of tissue grown is 26.9 mm. or only 75 per cent as much as from the 1 cm. stump and the specific amount is 1.57 against

2.08 for the arms cut 1 cm. out. The table shows positively that the nearer the disk the amputation is made the more rapidly will the regenerating bud grow.

The data from *Ophiocoma riisei* further substantiates the last statement. Comparing the averages it is clearly seen, that the arms cut off 1 cm. from the disk grow most rapidly, those cut 2 cm. out are next in rate, the stumps 4 cm. long grow new buds still more slowly, and those arm-stumps 5 cm. long produce new tissue

TABLE II

Rates of arm regeneration at different levels in the brittle-star, Ophiocoma riisei

DISK DIA. IN MM.	ARM-STUMP 1 CM. LONG		ARM-STUMP 2 CM. LONG		ARM-STUMP 4 CM. LONG		ARM-STUMP 5 CM. LONG	
	New growth in mm.	Sp. rate	New growth in mm.	Sp. rate	New growth in mm.	Sp. rate	New growth in mm.	Sp. rate
17	54	3.18	48	2.82	46	2.71	45	2.65
17	49	2.88	49	2.88	43	2.53	7	0.41
17	50	2.94	43	2.53	41	2.41	38	2.24
18	49	2.72	46	2.56	33	1.83	41	2.28
18	47	2.61	38	2.11	—*	—*	37	2.06
19	43	2.26	30	1.58	—*	—*	32	1.68
19	52	2.74	46	2.42	40	2.11	34	1.79
20	47	2.35	42	2.10	27	1.35	34	1.70
20	49	2.45	48	2.40	45	2.25	45	2.25
20	51	2.55	—*	—*	41	2.05	40	2.00
Av.	49.1	2.67±0.06	43.3	2.38±0.09	39.5	2.16±0.1	35.3	1.91±0.13

*Regenerated portion broken and not measured.

at the slowest rate. The buds in the latter case average only 72 per cent of the length of buds from the 1 cm. stumps.

Miss King ('98) found that in the starfish *Asterias vulgaris* arms were regenerated the more rapidly the nearer the base they were removed. The brittle-stars behave in a similar manner. I know of no exception to the rule that an appendage regenerates at a faster rate the closer to the body the amputation is made.

VI RELATION OF THE DEGREE OF INJURY TO THE RATE OF REGENERATION

The relation of the degree of injury to the rate of regeneration has lately received considerable attention. Zeleny ('03, '05, '07) has held that for the arms of the brittle-star, *Ophioglypha*, the limbs of the crayfish, *Cambarus*, and the oral arms of *Cassiopea* the rate of regeneration of each appendage is faster when several appendages are removed than when only one is cut away. Emmel ('06) has shown in the larval lobster that each limb regenerates more slowly when many are removed and faster when fewer. On the other hand Scott ('07) finds that the fins of the fish, *Fundulus*, regenerate at rates entirely independent of the number of fins removed. The results are, then, not in accord and the disagreement suggests that if the degree of injury does exert any influence on the rate of regeneration such an influence varies for different species and may not be so pronounced as to be an easily determinable factor.

I have shown ('08) that medusæ injured to the same extent regenerate new oral arms at rates differing as widely as do the average rates of medusæ injured to different degrees. Attention was also called to a considerable individual difference between the rates at which the several arms on one individual regenerate. Miss King ('98) also found in *Asterias* that "the rate of growth of the new arms is ordinarily unequal when a disk regenerates two or more at the same time."

The investigations on crustacea are open to the criticism that growth here is not continuous. A new bud begins to grow and completes the amount of growth possible within the rigid chitinous body-wall and then ceases to grow until a molt occurs. Zeleny ('05) found that in the crayfish the time elapsing between molts was longer in animals that had been injured to a lesser degree than in those more injured. Notwithstanding this fact the specific amount of regeneration from all individuals is the same at the time of the first molt independent of the degree of injury, the size of the animal or the time elapsing between the operation and the molt. Each bud thus seems to grow as much as possible and then

stops until the molt occurs. Zeleny takes this constant specific amount of regeneration and divides it by the number of days elapsing between the time of operation and the molt and considers the quotient to be the specific rate of regeneration per day. As mentioned above those specimens most injured molt soonest and therefore give a smaller number of days as a divisor to go into the constant dividend and so their specific rate of regeneration seems faster than that of those individuals less injured which molt slower. This method of calculation is incorrect unless it be proven that the regenerating buds grow continuously during all the days preceding the molt. In Zeleny's experiments the number of days between the operation and the first molt varies from 27 to 181 and yet the specific amounts of regeneration were always the same at the time of this molt. It would seem much more probable that this amount of tissue was formed soon after the operation and then stopped by the limiting body wall, than that one arm had required almost seven times as long to regenerate a given amount as another.

Emmel's ('06) work on the lobster shows that Zeleny neglected an important factor in failing to note the time elapsing between the previous molt and the operation. Emmel found that "the later the time at which regeneration begins after the molt, the greater the length of the entire molting period." Another fact of prime importance shown by Emmel's results was that the regeneration process itself, and not the mutilation, caused the lengthening of the period between molts. "The average length of the molting period for those lobsters in which the mutilations were not succeeded by the regeneration of the limbs, was not only less than the length of the molting period for the regenerating specimens, but also in a large proportion of cases was even shorter than the molting period for the normal lobster." By "molting period" Emmel means the time elapsing between molts, the expression generally means the time at which ecdysis occurs.

The question as to the relation between the rate of molting and the rate of regeneration put by Zeleny ('05, p. 362) is answered by the above paragraph quoted from Emmel. The process of molting is affected directly by the process of regeneration itself and not by the mutilation.

The influences of regeneration seem to be opposite in the two cases studied by Zeleny and Emmel. In the adult crayfish Zeleny finds that the time elapsing between molts is less in those individuals regenerating most tissue and Emmel finds the reverse true in the larval lobsters. In a short review of these papers¹ I attempted an explanation of this contradiction as follows. The larval lobsters are growing at their maximum rate and by necessitating further growth through the removal of limbs the entire growth rate is lowered as Emmel's results show to be the case, and this slower growth of the regenerating specimens brings them more gradually to the condition necessary for the following ecdysis. The adult crayfish, on the other hand, is living and growing at a rate below its possible maximum, it may be said to have a reserve growth energy. The introduction of regenerative processes such as the removal and subsequent regeneration of limbs calls out this reserve (recuperative power) and the rate of growth rises above the normal. The time elapsing between successive molts is thus decreased. This difference in states between the almost stable adult body and the rapidly increasing larva must always be borne in mind when comparing animals in different periods of life.

Finally, there is another cause of error to be guarded against in calculating the specific amounts of regeneration in animals injured to different degrees. This calculation according to the method employed by Zeleny is made by dividing the length of new tissue by the body length of the individual at the time of measuring the new tissue. I find that in some animals injured to different extents, or regenerating different amounts, the body size decreases during the experiment more in those more injured than in others less injured, so that in order to get proper comparisons the original body length must be used in the calculations. For instance, the medusæ which are to be considered below decrease in body size much more rapidly when six or eight oral-arms have been removed than when fewer are cut away, and at the same time may actually regenerate the individual arms faster. The length of new tissue divided by the body length (disk diameter) would

¹ The Influence of Regeneration on Molting in Crustacea. *Am. Naturalist*, XLII, 1908.

give proportionately excessive "specific amounts of regeneration" for these medusæ most injured if one used the final diameters in making calculations instead of the original diameters as measured at the beginning of the experiment.

Our examination shows the unsettled condition of opinion regarding the relation between the degree of injury and the rate

TABLE III

Regeneration of the oral-arms in *Cassiopea*, when one oral-arm is removed

DISK DIA. IN MM. MAY 20	DISK DIA. IN MM. JUNE 6	LENGTH OF ARM-BUD IN MM. JUNE 6	SP. AMT. ORIGINAL DIA.	SP. AMT. FINAL DIA.	DISK DIA. IN MM. JUNE 13	LENGTH OF ARM-BUDS IN MM. JUNE 13	SP. AMT. ORIGINAL DIA.	SP. AMT. FINAL DIA.
55	48	1	.018	.021	41	2	.036	.049
60	55	4	.067	.073				
75	72	4	.053	.056				
77	64	2	.026	.031	55	3	.039	.055
80	80	5	.063	.063	69	6	.075	.087
80	75	3	.038	.040	67	4	.050	.060
95	91	5	.053	.055	82	6	.063	.073
100†	93	0	.000	.000	81*	2	.020	.025
105	101	5	.048	.050	98	6	.057	.061
105	90	0.5	.005	.006				
105	90	1	.010	.011				
115	110	6	.052	.055	105	7.5	.065	.071
115	112	4	.035	.036	111	5	.044	.045
Av. 88.9	82.3	3.4	.039±.004	.041±.004	78.8	4.6	.050±0.004	.058±0.004

*Hole in center of disk due to parasite.

†Not included in the average as no regeneration in 17 days.

of regeneration. I determined, therefore, to perform more extensive experiments on several species of animals. A large number of *Cassiopea xamachana* and *Ophiocoma riisei* and *Ophiocoma echinata* were selected for the purpose.

It is advisable first to consider the species separately since they

respond in dissimilar manners and finally to attempt to harmonize the results.

Seventy-five healthy medusæ were selected and arranged in five groups of 15 individuals each. The average size of individuals in all the groups was approximately equal since the medusæ were first arranged in lots of five equal sized specimens and one from every lot was put into each group. The groups were then operated upon. In the first group one oral arm was cut at its base from each medusa, in the second two arms were similarly removed from each, in the third four arms were cut away, in the fourth six arms were amputated and in the fifth group all of the eight oral-arms were cut off at their bases. The groups are thus alike in every respect except that they are injured to successively greater extents. None of the specimens were fed during the experiment.

Table III presents the record of regenerative growth from the individuals with one arm cut away. The first vertical column contains the original diameters in millimeters of the medusæ disks on the day of operation, May 20; the second column shows the disk diameters 17 days later when the new growing tissue was first measured. The third column shows the lengths of the new arm-buds and the fourth and fifth columns contain the specific amounts of regeneration which are calculated in the fourth column by dividing the length of new tissue by the original disk diameter in each case, and in the fifth column by dividing by the diameters after 17 days. The figures of the fifth column are with one exception greater than those in the fourth since the disks decreased in diameter during the experiment.

The sixth column of the table gives the diameters of nine individuals measured 24 days after the operation. The size of the disks have continued to decrease and the new arm buds have lengthened as shown in column seven. The specific amounts of regeneration, therefore, have also increased. It is unnecessary to calculate a specific rate of regeneration per day since the growth was continuous and each column of specific amounts is given for a certain number of days; obviously the specific amounts are to one another as the quotients would be if they were all divided by the same number of days.

A line of averages is calculated at the foot of the table. The average size of the individuals with one arm removed was at the time of operation 88.9 mm. in disk diameter. After 17 days they had decreased 6.6 mm. in diameter and had regenerated new arm-buds 3.4 mm. long.

Tables IV, V, VI and VII contain similar data arranged from the medusæ regenerating two, four, six and eight oral-arms respectively.

TABLE IV

Regeneration of the oral-arms in *Cassiopea*, when two arms are removed

DISK DIA. IN MM. MAY 20	DISK DIA. IN MM. JUNE 6	LENGTH OF ARM-BUDS IN MM. JUNE 6	SP. AMT.		DISK DIA. IN MM. JUNE 13	LENGTH OF ARM-BUDS IN MM. JUNE 13	SP. AMT.	
			ORIGINAL DIA.	FINAL DIA.			ORIGINAL DIA.	FINAL DIA.
63	53	0-3	.024	.028				
65	53	1-0.5	.012	.014	45	1-2	.023	.033
75	70	2-3	.033	.036				
77	65	3-4	.046	.054	56	5-5	.065	.089
80	70	4-5	.056	.064				
90	80	4-4	.044	.050	71	5-6	.061	.078
90	82	4-5	.050	.055	78	6-6	.067	.077
95	91	4-5	.047	.050	85	5-6	.058	.065
105	95	2-4	.029	.032	90	3-4	.033	.039
105	87	4-4	.038	.046				
110	100	1-3	.018	.020				
115	100	3-4	.030	.035	98	3-4	.030	.036
120	113*	1-0.5	.006	.007	108	1-3	.017	.019

Av. 91.5 | 81.5 | 3 | .033±.003 | .038±.003 | 78.9 | 4.1 | .044±0.005 | .055±0.006

*Hole in disk due to parasites.

A comparison of the regeneration in the several groups of medusæ is facilitated by table VIII, which is a tabulation of the averages contained in tables III to VII. The first column shows the number of individuals composing each of the groups, the second column indicates the number of mouth-arms amputated from each

specimen, column three the original diameters in millimeters of the medusæ disks, column four of the upper half of the table the diameters after 17 days and the lower half contains the diameters after 24 days. The numbers in column five are obtained by subtracting those in column four from those in three and represent the average decrease in diameter of the disks. Column six indi-

TABLE V

Regeneration of the oral-arms in Cassiopea, when four arms are removed

DISK DIA. IN MM. MAY 20	DISK DIA. IN MM. JUNE 6	LENGTH OF ARM- BUDS IN MM. JUNE 6	SP. AMT. ORIGINAL DIA.	SP. AMT. FINAL DIA.	DISK DIA. IN MM. JUNE 13	LENGTH OF ARM- BUDS IN MM. JUNE 13	SP. AMT. ORIGINAL DIA.	SP. AMT. FINAL DIA.
65	54	2-2-2-3	.035	.042	46	4-4-4-4	.062	.087
70	59	4-4-4-4	.057	.068				
73	67	4-4-4-3	.051	.056	57	2-3-3-4	.041	.053
75	62	4-4-4-4	.053	.065	58	4-5-5-6	.067	.086
75	70	0-2-5-5	.040	.043				
80	71	2-2-2-1	.022	.025	61	2-3-3-4	.038	.049
80	65	2-2-2-3	.028	.035				
93	81	2-2-3-3	.027	.031	70	4-5-5-5	.051	.068
98	90	4-4-5-5	.046	.050	79	3-4-5-5	.043	.054
98	76	1-1-2-2	.015	.020				
105	93	4-5-5-5	.045	.051	89	5-6-6-7	.057	.067
115	105*	3-4-4-4	.033	.036	98	3-3-5-6	.037	.043
115	92	4-4-5-5	.039	.049				
120	103*	2-3-4-4	.027	.032	98	3-4-5-5	.035	.043
Av. 90.1	77.7	3.3	.037±.002	.043±.003	72.9	4.3	.048±0.003	.061±0.004

*Hole in disk center.

cates the actual percentage of decrease in diameter in terms of the original size. The seventh column gives the average lengths of new buds in each group. Column eight shows the specific amounts of regenerated tissue calculated by dividing the numbers of column seven, the length of new buds, by the numbers in column three, the original disk diameters. Column nine gives the spe-

TABLE VI
Regeneration of the oral-arms in *Cassiopea*, when six arms are removed

DISK DIA. IN MM. MAY 20	DISK DIA. IN MM. JUNE 6	LENGTH OF ARM-BUDS IN MM. JUNE 6	SP. AMT. ORIGINAL DIA.	SP. AMT. FINAL DIA.	DISK DIA. JUNE 13	LENGTH OF ARM-BUDS IN MM. JUNE 13	SP. AMT. ORIGINAL DIA.	SP. AMT. FINAL DIA.
65	53	2-2-3-3-3	.041	.050	47	3-3-4-4-4	.056	.078*
65	54	2-2-2-3-3*	.037	.044				
70	58	2-3-3-4-4	.048	.058	50	3-4-4-4-4	.055	.077
73	58	0.5-0.5-1-1-1-1	.011	.014	50	1-1-1-2-2-2	.021	.030
75	70	3-4-4-4-4	.051	.055				
80	66	4-4-4-5-5	.054	.066	64	5-5-5-6-6	.069	.086
84	71	3-3-3-4-5†	.042	.049				
95	79	4-4-5-5-6	.051	.061	70	5-5-6-7-7	.065	.088
100	77	2-2-2-3-3*	.024	.031	65	3-5-5-6-6*	.050	.077
100	85	3-3-3-3-3†	.030	.035	85	6-6-7-7-7	.064	.078
105	92	4-4-4-4-4	.038	.044				
105	82	2-3-3-3-3	.027	.035	87	4-4-5-5-7	.044	.058
115	92	3-3-4-4-5-5	.035	.044	96	4-5-6-6-7	.047	.059
120	105	3-3-4-4-4	.031	.035				
Av. 89.4	74.4	3.3	.037±.002	.044±.002	68.2	4.8	.052±0.003	.076±0.004

*Specimen had only seven arms normally and five were amputated.

†Arms begin regeneration as large basal cones plumed on ventral side, usually the initial bud in linear and branched.

TABLE VII
Regeneration of the oral-arms in Cassiopea, when eight arms are removed

DISK DIA. IN MM. MAY 20	DISK DIA. IN MM. JUNE 6	LENGTH OF ARM-HUDS IN MM., SP. AMT. ORIG.-SP. AMT. FINAL		DISK DIA. LENGTH OF ARM-HUDS IN MM. JUNE 13		SP. AMT. ORIG.-SP. AMT. FINAL	DISK DIA.	
		NAL. DIA.	DIA.	IN MM. JUNE 13	IN MM. JUNE 13			
65	49	1-1-2-2-2-3-3-3	.033	.043	40	2-2-5-3-4-4-4	.051	.083
65	55	4-4-4-5-5-5	.069	.082				
72	58	4-4-5-5-5-5	.066	.082				
75	55	2-2-3-3-4-4-4	.042	.057	45	4-4-4-5-5-5	.062	.103
80	65	1-2-3-3-4-4-5	.041	.050	52	2-3-4-4-4-3-5	.045	.070
68*	68*	5-5-6-6-6-5-6-5-7	.076	.089	64*	7-7-8-8-8-8-10	.100	.125
84	68.5	4-4-5-5-5-5	.055	.067				
95	78	4-4-5-5-5-5	.050	.061	68	5-5-5-5-6-6-6	.057	.079
95	77	4-4-4-5-5-5-5	.049	.060				
100	83	2-2-2-3-3-4-4-4	.030	.036	70	4-4-5-5-5-6-6	.050	.071
100	80	3-3-3-4-4-4-5	.038	.047				
103	83	3-4-4-5-5-6-6-5	.048	.060	77	5-6-6-6-7-7-7	.063	.085
115	96	3-3-3-3-4-4-5-5	.033	.039	90	4-4-5-5-6-6-7-7	.048	.061
120	100	4-4-4-4-5-5-5-6	.039	.046	93	5-5-5-6-6-6-7-7	.049	.065
Av. 89.2	72.5	4.1	.048±.003	.059±.003	66.6	5.3	.058±0.004	.082±0.005

*This specimen is also regenerating a part of the disk border, the new tissue is 25 mm. long by 7 mm. wide. This additional regeneration may account for the peculiarly rapid regeneration of the oral-arms.

cific amounts of regeneration when calculated by dividing the lengths of new buds by the final disk diameters. The different results shown by columns eight and nine are obvious and emphasize the error of using the final diameters in the calculations instead of the original diameters. The medusæ most injured, although in this experiment they are actually regenerating at the fastest rate, are also most rapidly decreasing in size and so give a disproportionate divisor in the calculations if their final size is used.

TABLE VIII

Tabulated summary of Tables III to VII showing the rates of regeneration and the decrease in size when *Cassiopea xamachana* regenerates different numbers of oral-arms. The upper half of table shows the conditions after seventeen days, the lower half after twenty-four days

NO. OF SPECIMENS.	NO. OF ARMS REMOVED.	DIAMETERS		ACTUAL LOSS IN SIZE, IN MM.	PERCENT-AGE LOSS IN SIZE.	LENGTH OF NEW TISSUE IN MM.	SP. AMT. OF REGENERATION	SP. AMT. OF REGENERATION
		ORIGINAL DIAMETERS. IN MM.	AFTER 17 AND 24 DAYS, IN MM.				ORIGINAL DIAMETERS.	FINAL DIAMETERS.
12	1	88.9	82.3	6.6	7.4	3.4	0.038±0.004	0.041±0.004
13	2	91.5	81.5	10.	10.9	3.0	.033±0.003	.037±0.003
14	4	90.1	77.7	12.4	13.8	3.3	.037±0.002	.042±0.003
14	6	89.4	74.4	15.	16.8	3.3	.037±0.002	.044±0.002
14	8	89.2	72.5	16.7	18.7	4.1	.046±0.003	.057±0.003
9	1	91.3	78.8	12.5	13.7	4.6	.050±0.004	.058±0.004
8	2	94.6	78.9	15.7	16.6	4.1	.043±0.005	.052±0.006
9	4	91.6	72.9	18.7	20.4	4.3	.047±0.003	.059±0.004
9	6	91.4	68.2	23.2	25.4	4.8	.052±0.003	.070±0.004
9	8	92.6	66.6	26	28.1	5.3	.057±0.004	.080±0.005

Table VIII is divided into two parts the upper part shows the results of the entire experiment 17 days after the operation. The lower part gives the results shown by the number of individuals indicated 24 days after the operation.

The facts of chief importance contained in the tables are: the decrease in size of the medusæ during the experiments in direct relation to the number of arms being regenerated (Fig. 8), and the absence of any significant relation between the number of regen-

erating arms and their rate of growth, with the possible exception of those growing eight arms. Plate I strikingly illustrates this decrease in size in six individuals originally of equal size, and on closer examination also shows the difference in lengths of the regenerated buds in the several specimens shown.

In addition to these facts it should also be noted that the specific amounts and rates of regeneration when calculated on the basis of the original disk diameters gradually increase from those medusæ growing two new arms to those regenerating eight. When the specific amounts of regeneration are calculated on the basis of the final disk diameters a similar but much more exaggerated

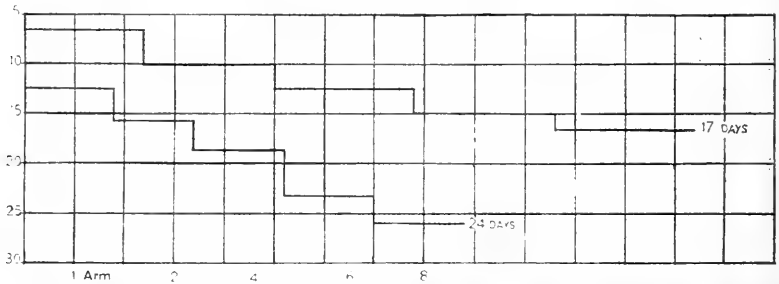

Fig. 8 Curves indicating the decrease in size of medusæ disks when regenerating different numbers of oral-arms; 1, 2, 4, 6 and 8. The upper curve indicates the condition after 17 days, the lower curve after 24 days. The numbers on the vertical line indicate the actual loss in diameter in millimeters.

increase is noted in those medusæ growing the larger number of arms. (This exaggerated increase is only apparent and is due to the fact that those medusæ regenerating many arms have decreased in size to a greater extent than those regenerating fewer arms.) The above increases in specific amounts of regeneration are, however, insignificant as is readily seen by comparing the probable errors. The probable error of the difference between any two groups may be represented by the formula

$$E^1 = \pm \sqrt{E^2 + E^2}$$

i.e., the probable error of the difference in specific amounts of regeneration between any two groups is + or - the square root

of the sum of the squares of the errors of these two specific amounts as given in the table. One finds on making the calculations that the differences are scarcely equal to or even less than the probable errors when comparing the groups regenerating one, two, four or six arms. If any of these four groups be compared with those individuals regenerating eight arms the latter group seems to show a distinct advantage in its rate of growth which is almost three times greater than the expected errors of the differences in the several cases. It may be stated, therefore, that the data for *Cassiopea* shows no relationship between the degree of injury and the rate of regeneration with the possible exception of those individuals regenerating all eight of their oral arms. The latter class seems to grow new arms at a more rapid rate than do specimens injured in any other manner. In consideration of the limited number of individuals and the wide variability within the group even this latter difference may not be generally found.

Zeleny ('07) concluded from a study of a small number of these medusæ that the rate of regeneration was fastest in those specimens having lost six of their oral arms and slower in individuals that had lost more arms, as well as in those growing fewer. It is obvious that my more extended series of experiments on *Cassiopea* fails to show any such advantage for those regenerating six arms over those growing eight arms. Since Zeleny's series is only one-third as great as mine the differences in rates shown in his table are probably, like mine, not significant.

The lower half of Table VIII shows that after 24 days the differences in rates between differently injured medusæ are still not significant.

We may now proceed to a consideration of the regeneration rates of the arms in brittle-stars injured to different extents. A large number of these animals were lost in unsuccessful aquarium experiments. Others were successfully kept in floating "live-cars" where they flourished and increased in size. The "live-car" experiments were started with 150 individuals, 135 of which were available for final measurements. Zeleny ('03) experimented on the brittle-star *Ophioglypha* and in fact on this form first obtained the data from which he suggested the principle that

appendages regenerate more rapidly when three or four are removed than when one or two are cut away. Zeleny's final measurements were made on only 36 animals and these had regenerated very short arm buds. After 46 days only a few of his individuals had new arms even 5 mm. in length. These facts tend of course to increase the probability of error.

The experiments now to be recorded continued for 49 days at the end of which time 135 specimens were measured. The average length of the new arms ranged from 29 to 46 mm. The error in measurements is greatly decreased in arms of such length. (An error of 1 mm. here would equal an error of only 0.1 mm. in Zeleny's measurements. A 1 mm. error is unlikely to occur but errors of 0.1 mm. in measuring brittle-star arms are difficult to avoid.)

Fortunately two species of ophiurans were employed in the experiments since it happens that they differ slightly in their responses to different degrees of injury. The case of *Ophiocoma riisei*, a large black spiny form with reddish tube feet, may be considered first.

Perfect animals were selected and grouped into five lots the individuals of the lots being of the same average size. All arms were amputated 1 cm. out from the disk with sharp scissors. The first lot had one arm cut from each brittle-star, in the second two arms were cut off, the third lost three arms, the fourth four and all five of the arms were cut from each individual in the fifth lot. After 49 days the specimens were expanded and killed in fresh water and chloretone and preserved in alcohol. The new arms plus the old 1 cm. stump were not so long as the original arms nor were they equal to the old ones in thickness.

A correct comparison of all the groups is made by considering the averages of actual new arm lengths shown in Table IX. Originally the average diameters of all the lots were practically the same, therefore, the arm lengths are to one another as the quotients (specific amount of regeneration) would be if they were divided by the originally equal diameters. I have calculated the specific amounts on the basis of final diameters merely to show the erroneous impression obtained by using such a method.

The upper half of Table IX summarizes the data from *O. riisei* and presents the following points of interest. First, *individuals of Ophiocoma riisei when kept under identical conditions increase in body size the slower the more arms the individual is regenerating.* This fact is not likely due to the incapacity of the more injured specimens to secure food since the compartments in which all were confined are small and the individuals seemed equally able to traverse this limited feeding ground. A probable explanation is that the new regenerating tissue possesses an excessive capacity for the assimilation of nourishment and consequently those specimens regenerating more new arms were less able to increase in body size than those regenerating fewer.

Table IX shows secondly, that *the rate of regeneration of each arm bears no relation to the number of regenerating arms, or in other words, the extent of injury.*

Column five gives the specific amounts of regeneration for each arm when calculated by dividing the average arm lengths by the final disk diameters. The last two figures in the column indicate the error of such calculation. Calculating the specific amounts of regeneration on the basis of the original average diameters which were practically equal in all the groups we obtain a series of numbers bearing the same relations to one another as are shown by the numbers in column four.

Ophiocoma echinata, a spiny, grayish, mottled brittle-star, was experimented upon in exactly the same fashion as *Ophiocoma riisei*. Its response to different degrees of injury was much more pronounced than that of the species *riisei*. Again five groups of individuals of the same average size were selected and operated upon so as to remove different numbers of arms 1 cm. from their bases at the disk.

Referring again to Table IX the lower half represents a tabulated summary of the data from *Ophiocoma echinata*. Two facts of importance are here also to be recognized. First, the fourth column giving the average arm lengths for each group shows that *the rate of regeneration decreases as the extent of injury increases.* Each new arm grows fastest from those individuals regenerating a single arm and successively slower in the groups growing two,

three, four and five new arms. These differences in rates are significant when compared with their probable errors.

Secondly, it is to be noted that the average of final disk diameters in *Ophiocoma echinata* is practically equal in all of the groups. This fact might be reconciled with the smaller increase in disk diameters shown in the more injured groups of *Ophiocoma riisei*,

TABLE IX

Tabulated summary showing the rates of regeneration in brittle-stars when regenerating different numbers of arms

<i>Ophiocoma riisei</i>				
NO. OF SPECIMENS	FINAL DISK DIAMETER IN MM.	NO. OF ARMS REMOVED.	AVERAGE LENGTH OF ARM-BUDS AFTER 49 DAYS, IN MM.	SP. AMT. OR RATE OF REGENERATION.
14	18.3	1	42.9	2.34 ± 0.104
13	18.1	2	45.8	2.53 ± 0.060
15	17.3	3	41.8	2.42 ± 0.061
14	17.3	4	41.5	2.40 ± 0.043
15	16.5	5	39.6	2.40 ± 0.049
<i>Ophiocoma echinata</i>				
13	16.6	1	36.9	2.22 ± 0.052
10	16.5	2	34.1	2.07 ± 0.089
14	16.	3	33.5	2.09 ± 0.060
14	16.5	4	31.3	1.90 ± 0.034
13	16.	5	28.9	1.81 ± 0.040

where the rate of regenerative growth is the same in all groups, by supposing that the decrease in growth rates of arms in more injured individuals of *Ophiocoma echinata* is sufficient to allow the disk to increase in size as readily as those disks which are growing only a few arms but at a more rapid rate of regeneration. In *Ophiocoma echinata* arms grow 30 per cent faster in those specimens regenerating only one arm than in those growing five. It is admitted, however, that the actual amount of regenerating tissue

is greater in the individuals growing five arms than in those growing fewer. The above reasoning depends largely upon the rate of regeneration itself as a factor acting upon the old body tissue to inhibit its growth or to cause it to decrease in size. I do not believe that this is entirely important and offer the above suggestion only as a possibility. The facts furnished by the *médusa*, *Cassiopea*, indicate that the decrease in body size is in a greater proportion than the increase in growth rates of new arms in specimens extensively injured as compared with those less injured.

We have now considered the relation between the degree of injury and the rate of regeneration in three different species of animals. The three species clearly show that the extent of injury fails to exert an influence in any one definite direction over the rate of regeneration in all animals. Former experiments which have seemed to indicate that the rate of regeneration is increased in animals injured to greater degrees have either been performed on crustaceans where growth is not continuous and where the influence of regeneration on the molting cycle introduces a complication, as Emmel's work so clearly demonstrates, or else have been conducted with too small a series of animals to justify general conclusions. Scott's study ('07) of the rate of fin regeneration in more than 100 individuals of *Fundulus heteroclitus* shows by careful calculations that the degree of injury exerts no influence either to increase or decrease the rate of regeneration in this fish. These experiments on the fish, along with those of Zeleny on crustacea, an ophiuran and a medusa, Emmel's study of larval lobsters and my experiments on *Cassiopea* and two Ophiurans would seem to justify the following conclusion. *By varying the extent of injury in several animal species there is no definite influence exerted in any one direction on the rate of regenerative growth.*

Morgan ('06, p. 460) draws a resemblance between the differences in rate of regeneration at different levels on an appendage or body and Zeleny's idea regarding the relation between the regeneration rates of the new parts and the number of parts removed. "If the distal end of the tail is removed it regenerates more slowly than when more of the tail is cut off. Thus the more the material removed the greater the rate of regeneration of the new part.

Stated in this form the two results appear to be identical." This resemblance is quite true for the evidence furnished by Zeleny but the more recent work fails to accord. In the larval lobster and some ophiurans it is not true that "the more the material removed the greater the rate of regeneration of the new part."

The influences exerted at different levels over the rate of regeneration cannot be identified with the influences due to different degrees of injury. It must be recalled that Zeleny ('03 and '05) claims that *each* appendage regenerates at a more rapid rate when several are removed than when only one is amputated. This has been shown not to be true for all animals but, on the other hand, the total amount of tissue regenerated from several arm stumps is greater than the amount from one even though the single arm may be regenerating at a more rapid rate. The more material removed up to a certain limit the greater will be the mass of newly regenerated tissue in a given time, irrespective of whether the greater amount of material is removed by cutting at a deeper level or by amputating a larger number of appendages. The statement in this form is supported by the present evidence.

VII THE RELATION BETWEEN THE RATE AND AMOUNT OF REGENERATION AND THE PHYSICAL CONDITION OF THE ANIMAL BODY

In the foregoing pages it has been repeatedly mentioned that individuals regenerating several appendages are at the same time either decreasing in actual body size or are increasing in size slower than other individuals which are replacing fewer lost parts. It seems expedient now to consider such cases collectively in order to determine whether there is any actual tendency on the part of regenerating tissue to appropriate nutriment at the expense of the general body vigor.

Emmel ('06) showed that the process of regeneration retarded the growth of young lobsters sometimes as much as 24 per cent. He demonstrated that the retardation was due to the process of regeneration and not to mutilation or other causes: Since "the average length of the molting period for those lobsters in which the mutilations were not succeeded by the regeneration of the

limbs, was not only less than the length of the molting period for the regenerating specimens, but also in a large proportion of cases was even shorter than the molting period for the normal lobster," Emmel finally concludes, that the process of regeneration by retarding both the frequency of molting and the increase in size retards the growth of lobsters.

After an examination of the relation between the increase in size in normal and in regenerating salamanders Morgan states ('06):

"That a newly regenerating part has the power to take from the blood the materials that it needs for growth, even when the amount present in the blood has fallen so low that the rest of the tissues cannot maintain themselves, but break down to supply the blood with a certain amount of nutriment. If this idea expresses approximately the relation that exists, it follows that while the new part requires a certain amount of food in order to continue growing, it can take advantage of a condition that the older or differentiated tissues cannot make use of; in fact, when the latter slowly lose ground. . . . Since in regeneration the new part is formed directly out of the old tissues we may assume that this property (excessive capacity of assimilation) of young parts is something connected with their lack of differentiation, which is lost when differentiation takes place, and is regained again when the differentiation is lost."

Morgan's ideas are most suggestive when considered from the standpoint of the conditions found in malignant growths. In Ewing's ('08) survey of the latter subject he calls attention to the fact that the energies of cells are normally divided between proliferation and specialized function, between work and growth, both being limited by blood supply. Examples of cells set apart for growth are the germ center cells of lymph nodes, the cells at the bases of intestinal villi and the basal cells of the epidermis. Ewing states that "it is just from these cells, subject to marked variations of the demands for growth, that tumors arise. It is clear that deficient demands for function on the part of derived cells would leave their energies unconsumed and further available for growth. These conditions surround the inception of cancer in the atrophying breast."

Adami ('01) has also presented the general importance of this point of view, designating the tumor process as the cumulative "habit of growth replacing the habit of work."

Considering both these statements and Morgan's, one may express the case as follows. Undifferentiated tissue is that which has not begun to function and so employs all of its energies in growth. When a limb is removed the tissue at its base can no longer function so that it gives up its differentiation and begins to grow again. I agree with Morgan when he states that "because a tissue had become differentiated it has not lost the potentiality of becoming young again, provided it gives up its differentiation." However, neither Morgan nor Emmel have drawn any similarity between the action of regenerating tissues and malignant growths. The one difference I wish to point out, however, between regenerative growths and tumor growths is that the former sooner or later stop on account of differentiation and function having begun while the latter are not inhibited by such forces and so continue to grow indefinitely.

I believe that additional evidence in support of the above views is furnished by the medusa and perhaps also by the brittle-star.

The medusæ in all cases were unfed and decreased steadily in size during the experiment. The decrease in size was without exception greater in those specimens which were regenerating a larger number of arms when compared with others regenerating fewer. In passing through the series each group was smaller than the preceding groups regenerating fewer oral-arms but always larger than the following groups which were regenerating a greater number of arms. The series is illustrated in plate I, a photograph of six medusæ each regenerating successively greater numbers of parts. The specimens were all equal in size at the beginning of the experiment but are now successively smaller as the number of regenerating parts is increased.

It may be argued that the greater removal of tissue lowers the possible food supply to be drawn on by other parts. It is equally true, however, that when more parts are removed fewer remain to require nourishment from any source.

The oral arms which are supplied with nematocysts normally

move to surround the prey and are not entirely passive but probably in comparison with the disk tissue use a proportionate share of the available material in starved individuals. It would seem in consideration of the great loss in size that the new regenerating arms require an unusually large amount of nutriment. The medusæ growing six new arms, for example, show a much greater decrease in the size of their disks over those growing two new arms than would be balanced by the difference in amounts of new tissue in the two cases. In other words, the regenerating tissue, if it be the real cause of loss in body size, exerts a peculiarly great exhaustive influence. The influence is in fact almost malignant in nature.

The brittle-stars do not fall completely into line with the above discussion but on closer examination they also seem to supply facts in this direction. In *Ophiocoma riisei* the rates of regeneration for individual arms in specimens injured to various degrees are practically equal (Table IX). The influence of the new tissue would be expected to show itself most markedly in the specimens growing many arms and gradually less in those growing fewer. This is found to be a fact. All individuals were feeding and growing during the experiments but those regenerating five arms increased least in size although they had the smallest total amount of tissue to feed and those growing only one or two arms increased most.

The other species of brittle-star, *Ophiocoma echinata*, regenerates each arm at a rate varying inversely with the extent of injury. When five arms are regenerating each arm grows only 78 per cent as fast as when only one arm is being regenerated. The increase in size of these ophiurans was uniform in all the groups. A possible adjustment of this fact to accord with the medusa and *Ophiocoma riisei* might be accomplished by assuming that the more rapid growth of the smaller number of arms inhibited the general body increase in size to the same extent as did the larger number of less rapidly regenerating arms. By increase in size is meant the increase in the disk size. When several appendages are removed there is less tissue to draw on the food supply and the disk might be expected to increase more rapidly in size under such a

condition than it would when four or five long arms are present to be fed. Recognizing this, it might be possible for the specimens regenerating four or five arms to increase in size so as to equal those regenerating fewer arms and at the same time the larger number of regenerating arms may have inhibited the increase in size to a greater extent than did the fewer new arms. The actual amount of new tissue formed is much more in the specimens growing the larger number of arms even though the rate of growth for each arm is less.

It seems then that the regenerating tissue in medusæ and ophiurans exerts a debilitating influence over the old body tissue in consequence of an excessive power to absorb nutriment. This excessive ability to appropriate nutriment seemingly possessed by regenerating tissue is most significant and deserves careful investigation. Experiments are now under way which I trust may add something towards an analysis of this problem.

VIII SUMMARY AND CONCLUSIONS

1 Circular preparations made from the disks of the medusa *Cassiopea*, regenerate tissue at equal rates whether in periodic pulsation or in a condition of rest. Circular preparations in which one-half pulsates and the other half is at rest regenerate tissue at equal rates from the two halves. The halves are as near as possible identical, being equal portions of one individual still organically connected. Therefore, the process of regeneration in *Cassiopea* not only takes place independently of functional activity but the rate of regeneration is also uninfluenced by such a factor.

2 Peripheral pieces of the disk of *Cassiopea* cut in sundry patterns, bias-strips, equilateral triangles and V's show decided regulatory ability and tend to assume the original circular shape of the entire disk in the most direct way that their forms will permit. The attainment of a circular form either a disk or a cup-shape inhibits the process of regeneration in the pieces, yet regeneration will continue for a much longer time if such shapes be prevented. The factors here evinced are probably comparable to those which coördinate the growth of tissues and organs in such a manner as to insure the specific body form.

3 The rate of regeneration from a peripheral cut on the *Cassiopea* disk is faster the nearer the disk center the cut is made. In the brittle-stars *Ophiocoma riisei* and *Ophiocoma echinata* new arms regenerate faster as the old arms are cut off nearer their base of attachment to the body-disk. The nearer the distal end a portion of arm is amputated the slower will a new part regenerate.

These experiments and those of several other workers all show that the rate of regeneration in diverse species of animals varies with the level of the cut, being faster as the cut surface is nearer the body center.

4 The rate of regeneration does not bear the same definite relation to the extent of injury in all animal species.

The medusa, *Cassiopea*, regenerates each oral arm at a rate which is independent of the degree of injury when replacing either one, two, four or six of its arms. If, however, eight arms are amputated each arm is regenerated at a rate which, after taking account of the probable error, is significantly greater than the regeneration rates in medusæ injured to any less extent.

The brittle-star, *Ophiocoma riisei*, regenerates either one, two, three, four or all five arms at rates which are not significantly different. In other words, there is no relation between the rate of regeneration of the individual arms and the degree of injury in this species.

The rate of regeneration for individual arms in *Ophiocoma echinata*, another species of ophiuran, is fastest when only a single arm is regenerating and successively slower when two, three, four and five arms are being replaced. The rate of regeneration is slower the greater the extent of injury.

The facts show that the rate of regeneration does not increase with an increase in the extent of injury in all animals but may actually respond in an opposite manner, or the rate of regeneration may even be independent of the extent of injury.

5 The unfed disk of *Cassiopea* decreases in size during regeneration in direct relation to the number of regenerating arms. Thus while the disks which are regenerating eight new arms grow them at the most rapid rate these disks are also decreasing in size most rapidly.

In *Ophiocoma riisei* when all of the individuals are growing, those regenerating a larger number of arms increase in size slower than the specimens regenerating fewer arms.

Ophiocoma echinata regenerates each arm faster when only a few arms are cut and such individuals increase in size at about the same rate as do those which are regenerating each arm more slowly although more arms are being replaced.

Regenerating tissue possesses an excessive capacity for the absorption of nutriment and may do so even to the detriment of the old body tissue.

LITERATURE CITED

- ADAMI, J. G., '01—The Causation of Cancerous and Other New Growths. *Brit. Med. J.*, London, 1901, i, 621-628.
- EMMEL, V. E., '06—The Relation of Regeneration to the Molting Process in the Lobster. 36th Ann. Rep., Inland Fisheries of Rhode Island, 258-313.
- '07—Relation Between Regeneration, the Degree of Injury and Molting in Young Lobsters. *Science*, n. s. xxv, 785.
- EWING, J. '08—Cancer Problems. *Arch. Intern. Med.*, i, 175-218.
- KING, H. D., '98—Regeneration in *Asterias vulgaris*. *Arch. Entwickl.-Mech.*, vii, 351-363.
- MORGAN, T. H., '02—Further Experiments on the Regeneration of the Tail in Fishes. *Arch. Entwickl.-Mech.*, xiv, 539-561.
- '06—The Physiology of Regeneration. *J. Exper. Zoöl.*, iii, 457-500
- SCOTT, G. G., '07—Further Notes on the Regeneration of the Fins of *Fundulus heteroclitus*. *Biol. Bull.*, xii, 385-400.
- STOCKARD, C. R., '07—Preliminary Report on Regeneration in *Cassiopea*. Year Book, No. 6, Carnegie Institution, 118-119.
- '08—Studies of Tissue Growth, I. An Experimental Study of the Rate of Regeneration in *Cassiopea xamachana*. Carnegie Institution, Publication No. 103, and *Science*, n. s., xxvii, 448.
- ZELNY, C., '03—A Study of the Rate of Regeneration of the Arms in the Brittle Star, *Ophioglypha lacertosa*. *Biol. Bull.*, vi, 12-17.
- '05—The Relation of the Degree of Injury to the Rate of Regeneration. *J. Exper. Zoöl.*, ii, 347-369.
- '07—The Influence of Degree of Injury, Successive Injury and Functional Activity upon Regeneration in the *Scyphomedusa*, *Cassiopea xamachana*. *J. Exper. Zoöl.*, v, 265-274.

EXPLANATION OF PLATE I

Six specimens of *Cassiopea xamachana* regenerating successively greater amounts of material. At the beginning of the experiment the individuals were equal in size, 24 days later the photograph shows that they have decreased in size in direct relation to the amount of material being regenerated. The specimens which are growing eight arms and have decreased most in size, although weak and emaciated, regenerate each arm at a faster rate than do those growing fewer arms.

CHARLES R. STOCKARD

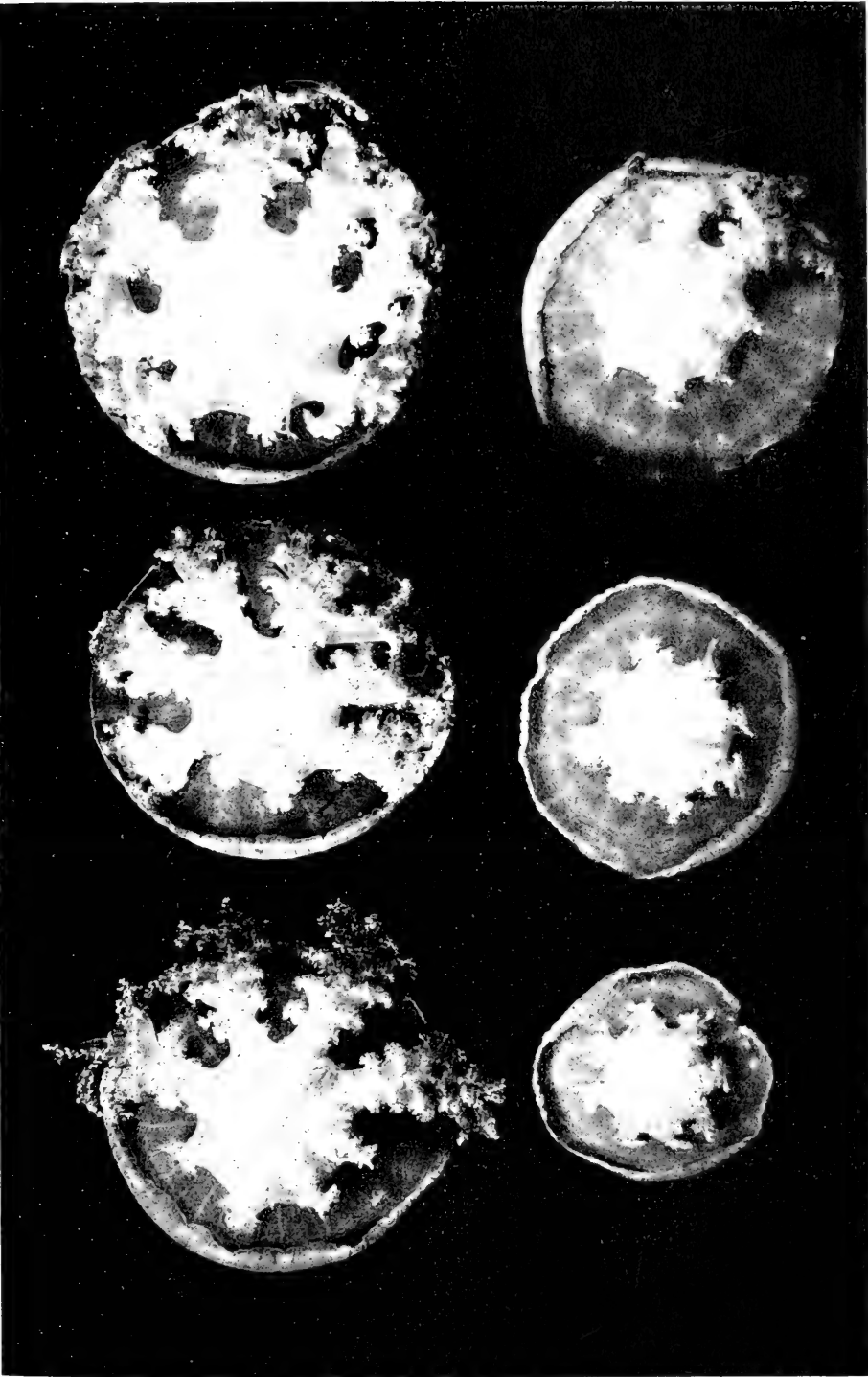

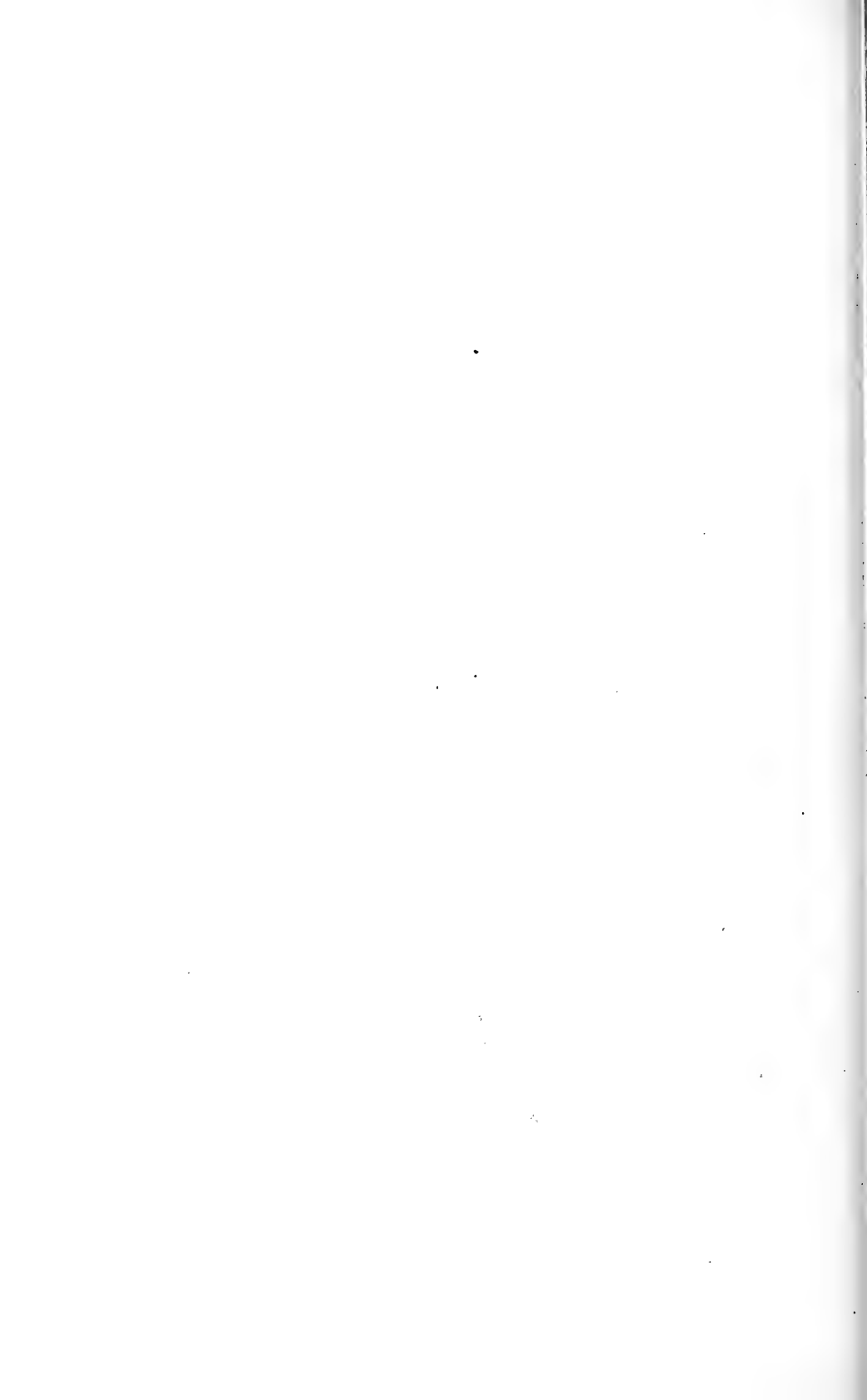

FACTORS OF FORM REGULATION IN HARENACTIS ATTENUATA

I WOUND REACTION AND RESTITUTION IN GENERAL AND THE REGIONAL FACTORS IN ORAL RESTITUTION

BY

C. M. CHILD

(WITH TWENTY-FOUR FIGURES)

The present paper is concerned with a part of the data obtained by the writer on form regulation in *Harenactis attenuata* (Torrey, '02) during a stay of several months in the autumn and winter of 1905-06 at the laboratory of the San Diego Marine Biological Association at La Jolla, California. This actinian occurs in great numbers in the fine sand or mud of the tide-flats of False Bay and San Diego Bay and is extremely hardy in the laboratory. Its usual form and habit and the regulatory changes which occur under certain changed environmental conditions have been described elsewhere (Child, '09) and only one or two points require mention here. Figs. 1 and 2 are diagrammatic outlines about two-fifths of the natural size, of the shape of individuals in the extended condition, Fig. 1 being a condition approaching maximum extension and distension in large individuals and Fig. 2 a size and shape nearer the average. Extension and distension to the degree indicated in these figures occur only when the animal is in its burrow in the sand. When removed from its burrow and kept without sand during several months it gradually undergoes regulation into a shape resembling that of the "sessile" actinians (Child, '09). Under the usual conditions of life the circular muscles of the body-wall are well developed and the mesenteries bear powerful longitudinal retractor muscles inserted distally on the walls of the œsophagus, whose contraction invaginates the disc and tentacles (Fig. 3). The mesenteries, the mesenterial filaments and the longitudinal muscles, particularly the latter, occupy

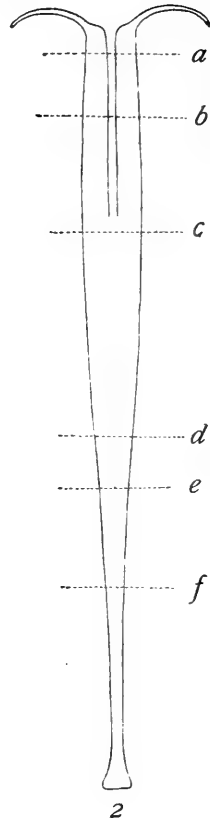
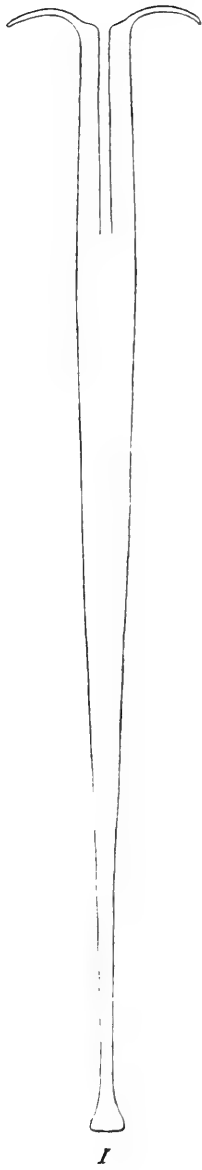

a considerable space in the enteric cavity, so that even when the water has been almost entirely forced out of the cavity by extreme contraction, the body still retains its cylindrical shape, because the cavity is filled by the large muscles and other organs. The twenty-four tentacles vary in length from twenty to forty millimeters according to the degree of distension and various other conditions. Apparently there is no close correlation between the size of the animal and the length of the tentacles, for in small individuals the length of the tentacles is very commonly nearly or quite as great as in large (Cf. Child '05b, pp. 272-274).

For certain lines of experiment the species has proved to be most favorable material, though the power of invagination of the oral end and the presence in the enteron of the large muscles are complicating factors in many cases. In my experiments the animals were kept in bowls containing one to two liters of water according to the number of animals. The experiments extended over four and a half months and many individuals were kept during the whole time. No attempt was made to feed the animals: probably they obtained a certain small amount of food from the water, which was renewed every few days, but a considerable decrease in size was observed during the experiments. Aside from this decrease in size and the change in shape (Child '09), however, a large number, both of whole individuals and of the products of experiment were apparently in perfectly good condition at the end of the time.

In the present paper the wound reaction and the course of restitution under certain varied conditions, including section at different levels are described. The figures are diagrammatic: Figs. 1 and 2 are about two-fifths natural size, the other figures except Figs. 4 and 5 and 23 and 24 about one-fourth to one-third above natural size.

I THE REACTIONS TO THE WOUND

In *Harenactis*, as in other actinians which I have examined, the first reaction to the wound consists in contraction of the regions adjoining the wound. This reaction seems to be characteristic

of all parts of the body. Usually it results in a decrease in the size of the opening made by the wound, but it is not at all difficult to cut the body-wall in such manner that closure of the wound is impossible because of the contraction which occurs. In these cases the wound reaction occurs in exactly the usual manner, but the conditions of the experiment determine the character of the result as regards closure or non-closure of the wound. The case is very similar to that of *Cerianthus* which was considered in an earlier paper (Child '04a). In both species, as well as in many other actinians, the same reaction which brings about closure of the wound in certain cases, renders it impossible in others. Under certain other conditions closure of the wound may occur in such manner that return to the usual form is impossible (Child '04d, pp. 205-207; '08b, pp. 41-45).

The actual closure of the wound by new tissue is the result of proliferation and growth of cells adjoining the cut surfaces of the body-wall mesentery or other organ. But in *Harenactis*, as in *Cerianthus* (Child '04a, pp. 66-74, '04b, pp. 276-279, '08, pp. 30-32), the outgrowth from a cut surface of new tissue with a free margin does not occur to any appreciable extent except under certain special conditions. This point cannot be too strongly emphasized since it is one of the most important features of regulation in these and many other actinians. In the papers referred to above, I have shown that the growth of the new tissue begins in the angles of the inrolled portions of the cut surface, and also, and this is the most important point, that it ceases almost immediately unless the tissue is subjected to some degree of stretching or tension. The indefinite outgrowth of new tissue from a cut surface until it meets new tissue growing out from another surface does not occur in these forms. In short we may say in general terms that *the growth and differentiation of new tissue in the body-wall, the tentacles and the mesenteries is possible only when the regions concerned are subjected to a certain degree of mechanical tension or stretching.* It is unnecessary to cite at length the data concerning this point for *Harenactis* since they are quite similar to those presented in my earlier papers for *Cerianthus*. Closure of the wound in *Harenactis* as in *Cerianthus* can occur only under

the following conditions: First, approximation of at least certain parts of the cut surfaces, in such manner that when the cells of these regions become "embryonic" after the wound has been made union may occur; and second, the existence in the thin membrane thus formed of a certain degree of mechanical tension or stretching. The diagrammatic Figs. 4 and 5 will serve to illustrate the point: Fig. 4 represents a region of the body-wall adjoining a wound, the dotted area indicating the region in which the loss of the original differentiation occurs, i.e., in which the cells become "embryonic." In case the cut margin is straight as in Fig. 4 and no other cut surface is in contact with it, no further growth occurs and the wound is never closed. The cut margin simply heals over, though as I showed for *Cerianthus* (Child '04a, p. 70) it retains for a long time and probably indefinitely, the power to unite with another cut surface if contact between the two occurs.

As a matter of fact, however, in most cases except extensive longitudinal wounds, the contraction of the regions about the wound brings about more or less "puckering" of the cut margin. In cases of transverse section of the body the cut end commonly appears very much as if drawn together as the mouths of bags are often closed by a "draw-string." Fig. 5 is a diagram of a portion of such a cut surface in a state of moderate contraction. Various angles are formed between the different parts of the surface and there is of course more or less elevation or depression of different parts perpendicular to the plane of the figure. Under these conditions the cells immediately adjoining the cut lose their original differentiation as in the preceding case, but the process does not stop here. These cells form thin membranes across the most acute portions of the angles between different parts of the cut surface, i.e., these angles gradually become less deep by the extension from their apices of the thin membranes of new tissue. The dotted lines in Fig. 5 indicate various stages in this process. It will be noted that no appreciable growth occurs where the cut margin is convex. In a case where the wound was so widely open as in Fig. 5 growth of the new tissue would probably not proceed much beyond the stage indicated in the figure, i.e., closure of the wound would never occur unless other conditions arose. Commonly,

however, the contraction following the wound is so great that the various parts of the circumference of the wound are closely approximated. In such cases the margin of the thin new tissue, after it has filled the various angles of the puckered margin, forms a circle. If this circle is not too large, i.e., if its curvature is sufficiently great, growth of the new tissue continues, the circular opening becomes smaller and is finally closed (Fig. 6). If the opening is above a certain size the new tissue ceases to grow and an opening remains permanently, or until other conditions are estab-

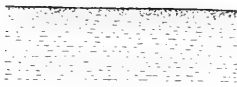

4

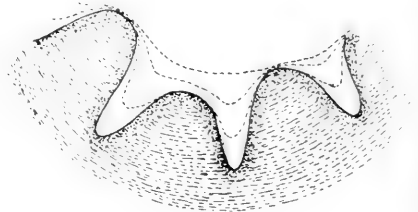

5

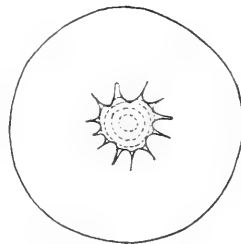

6

lished. In my earlier paper I called attention to the similarity between the growth of these thin membranes of new tissue and the behavior of a fluid or semi-fluid film, and suggested that surface-tension probably constituted a factor in the process of out-growth (Child '04a, pp. 66-74). The fact that the rapidity of growth of the new tissue increases with the concavity of the free margin or the acuteness of the angle between two portions of the margin (Fig. 5) and, on the other hand, ceases as the margin

approaches a straight line or becomes convex, is of special interest, in that it shows very clearly the dependence of the process upon physical conditions of some sort. Moreover, the thin membrane when formed is always under a certain degree of tension, and this condition together with the other facts again suggests surface tension. While this factor is apparently sufficiently important to determine under certain conditions whether growth of new tissue and wound closure shall occur or not, the process of growth itself, when it does occur, is of course very different from the behavior of a fluid or semi-fluid film. After the wound is closed the mechanical conditions of tension favorable to further growth arise from the distension of the enteron with water.

Thus far it has been impossible to discover any very great regional physiological difference either in the method or the rate of wound closure, though apparently the rapidity of the reactions is greatest in the oral regions and decreases aborally. In a given region of the body the method of closure of aboral wounds does not differ essentially from that of oral wounds. Certain incidental regional differences in the method and rate of wound closure do, however, appear; these are due primarily to the anatomical structure of the animal, and secondarily to the general occurrence of contraction of the tissues as a wound reaction. The factors chiefly concerned in these differences are briefly considered in the following sections.

I The Mesenteries

The contraction following the wound involves not only the body-wall but any mesenteries which may have been injured. In a terminal wound in the œsophageal region, for example, the mesenteries extend from body-wall to œsophagus, and after section the mesenteries contract, as well as the body-wall and the œsophagus. It is this contraction of the transverse cut surface of the mesenteries that brings the cut margins of the body-wall and the œsophagus together with such uniformity in œsophageal regions (Figs. 7 and 8). In consequence of the presence and arrangement of the mesenteries, it is impossible for the cut end of the body-wall to close over the end of the œsophagus. In all cases where section

of the body occurs in the œsophageal region, whether it be at the oral or aboral end of a piece, Figs. 7 and 8, Fig. 13, the body-wall and œsophagus unite so that the œsophagus remains widely open to the exterior.

Aboral to the œsophagus the mesenteries play little or no part in closing terminal wounds since they hang free in the enteron and their contraction after injury can produce no marked mechanical effect on the body-wall. In these regions oral or aboral ends close

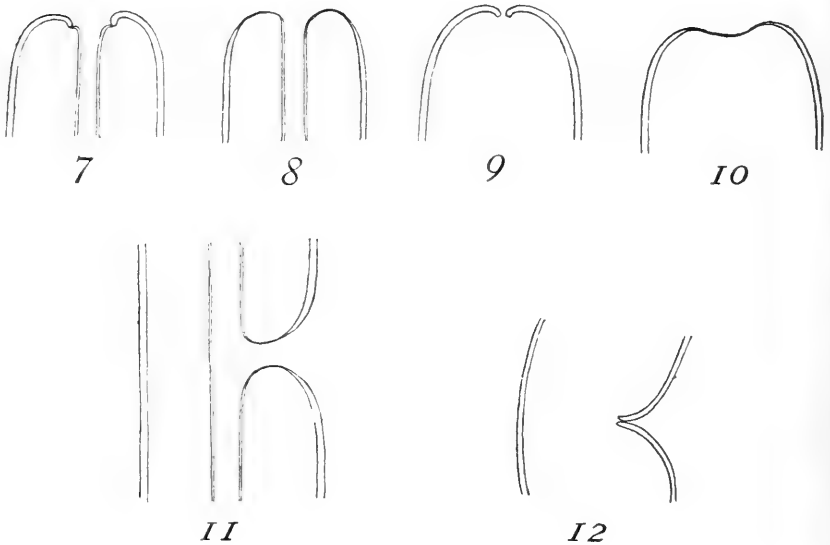

by approximation and inrolling of the cut margins (Figs. 9 and 10), but the closure requires a longer time and is imperfect or retarded much more frequently than in the œsophageal region.

In cases of partial transverse section of the body, i.e., of transverse lateral wounds, the method of wound-closure depends on whether the œsophagus is involved in the wound or not. When such a wound in the œsophageal region is deep enough to cut through a part of the wall of the œsophagus, the cut surfaces of the mesenteries, oral and aboral to the wound, contract exactly as in the case of a terminal wound, and œsophagus and body-wall

are drawn together and unite (Fig. 11). In this manner the lateral mouths and lateral partial discs are formed.

If, however, the lateral wound is not sufficiently deep to involve the œsophagus, or if it is in the subœsophageal region, closure occurs, if it occurs at all, by approximation of the cut margins of the body-wall (Fig. 12). If the wound is not deep enough to sever the mesenteries of the side of the body, their contraction aids in bringing the cut edges together and closure occurs in a very short time. This is always the case in transverse wounds in the œsophageal region which do not involve the œsophagus, and in the subœsophageal region when the mesenteries are not completely severed. If, however, a wound in the subœsophageal region is deep enough to sever some of the mesenteries their contraction can no longer aid in bringing the cut margins of the body-wall together. As a matter of fact, such wounds are commonly rather slow in healing and closure usually occurs from each end of the transverse wound toward the middle. Since the body is cylindrical it is evident that a lateral transverse wound varies in depth from each end toward the middle, being deepest in the middle. In those regions of the wound where the mesenteries are not completely severed their contraction will aid in bringing the cut edges of the body-wall together, while in other regions no such factor will exist. Consequently closure at the ends of such a wound will occur much more readily and rapidly than elsewhere. Frequently the middle regions of these lateral wounds remain open for a long time, since the cut surfaces are not sufficiently approximated for the formation of new tissue between them.

Longitudinal wounds of any considerable length in the body of *Harenactis* very often remain open indefinitely. The margin of the body-wall on each side usually rolls inward spirally so that approximation of the cut edges is impossible, or in some cases one margin precedes the other and the whole body rolls into a single spiral with longitudinal axis. In either case closure of the wound can never occur. The usual failure of the cut margins of the body-wall to approximate each other after a longitudinal wound is due simply to the fact that there is nothing in the structure of the body which serves to draw the margins together or to prevent their

attaining some other position. In the case of a terminal or lateral transverse wound, continued spiral inrolling of the cut margin of the body-wall is impossible both because of mechanical conditions in the wall (i.e., the region nearest the wound contracts most strongly) and because of the presence of more or less voluminous organs in the enteron. Moreover, as pointed out above, the mesenteries are important factors in bringing the cut margins together in certain cases. In the case of longitudinal wounds, however, none of these factors can serve to bring the margins together, consequently closure of such wounds occurs only rarely. In the case of short longitudinal wounds the mechanical conditions on the body-wall prevent any great degree of inrolling, and the cut margins, especially near the ends of the wound, usually approach each other sufficiently to permit the formation of new tissue and closure.

On the other hand, it is possible to induce experimentally peculiar methods of wound closure and union of the cut margins in such manner that anything like return to the usual form is impossible. Such results can be attained simply by altering the relations between the various mechanical factors involved in approximation of the cut surfaces. One case of this kind, which is of especial interest, will serve to illustrate the point. Pieces of the body from the region between the lines *c* and *d*, Fig. 2, contain the large retractor muscles and when contraction occurs after isolation of the pieces (e.g., by two transverse cuts) parts of the muscles and mesenteries usually protrude from one or both ends of the piece (Fig. 14). In such pieces it is possible, with a little care, to remove completely the retractor muscles and the parts of the mesenteries in which they are imbedded. In this operation two results important for the further history of the piece are attained, viz: first, the mass of the enteric organs in the piece is much reduced; and, second, the removal of the axial portion of each mesentery leaves a longitudinal wound involving the whole length of each mesentery (see the dotted lines in Fig. 14), besides the transverse wounds made when the piece was isolated. In these pieces the wounded edges of the mesenteries contract and the result is the approximation of *oral and aboral cut margins of the body-wall* and their union (Fig. 15). This method of closure

gives rise to a ring without any opening between the enteron and the exterior (except of course the cinclides), without any oral and aboral end—since these two ends have fused, and in fact without any of the features of shape and relation of parts characteristic

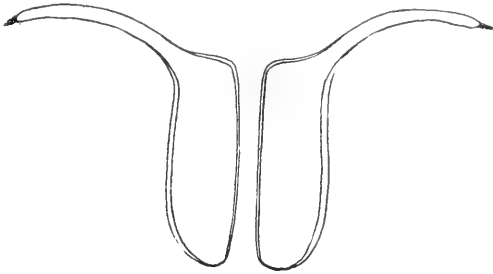

13

of the species. There is no difficulty in obtaining these pieces. They result almost invariably when the conditions described above are established. Their further history is of great interest but will be considered in another connection. Extrusion of the œsophagus sometimes occurs in short pieces from the œsophageal

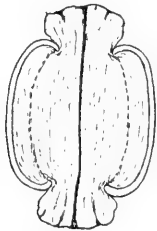

14



15

region (e.g., between *a* and *b*, Fig. 2). If the extruded structures are cut away rings are formed as in the cases just described and for the same reason.

The relation between the mesenteries and closure of the wound in *Harenactis* does not differ very widely from that existing in *Cerianthus* (see Child '04a, wound-closure after different kind

of wounds; '04d, wound closure in œsophageal pieces; '05a formation of lateral mouths).

2 *The Œsophagus*

In the œsophageal region the œsophagus and the mesenteries supplement each other: the walls of the œsophagus constitute one of the points of attachment of the mesenteries, and the contraction of the latter draws the cut margins of œsophagus and body-wall together. Both are essential factors in the result, viz, the union of the cut edges of œsophagus and body-wall. Figs. 7-12 and Fig. 13, together with the explanations of these figures in the preceding section, will suffice to make clear the relations of parts.

3 *Mass Effects of the Enteric Organs*

The mesenteries, with their large longitudinal muscles and mesenterial filaments constitute a mass of considerable size in the post-œsophageal region of the enteron. In most cases of section of the body in regions between the aboral end of the œsophagus and the attenuated region, i.e., between *c* and *e* Fig. 2, the contraction following the wound is sufficient to force the mesenterial organs out through the cut end to a greater or less extent, where they form a plug which often delays or prevents closure of the wound or in other cases becomes infected and frequently brings about the death of the whole piece. In pieces with cut ends both orally and aborally (Fig. 14) the mesenterial organs often protrude from both ends, and such pieces are absolutely incapable of closing and undergoing regulation. The effect of removal of these organs, i.e., the formation of "rings" (Fig. 15), was discussed above. If the organs are not removed the extruded portion is sometimes gradually constricted off from the remainder by the continued contraction of the cut end of the body-wall about it. If the external decaying portions do not infect the rest of the piece before they separate regulation proceeds in the usual manner after the plug has dropped off. On the other hand, in some cases, especially when the piece is intact aborally, more or less elongation usually follows the extreme contraction produced by the wound, and in

some of these cases the mesenterial organs which were extruded are again drawn into the enteron and the cut end closes over them without any marked delay or other departure from the usual method.

Since the degree of contraction of the body-wall following a wound is in some degree proportional to the intensity of the stimulus, pieces cut at both ends extrude their mesenterial organs more frequently and to a greater extent than those with one end intact. Not infrequently, if contraction is considerably greater or more rapid at one end than at the other such pieces turn completely inside out. In this position regulation in the usual manner is of course impossible, and so far as I am aware, pieces which have turned inside out do not succeed in turning back again, but remain in this position until death occurs.

As was noted above in Section 1, even the œsophagus may be forced out of the end of the piece in some cases: this occurs only in short pieces within the œsophageal region, i.e., in which the body-wall and œsophagus are cut at both ends (e.g., pieces between levels *a* and *b*, Fig. 2). If the œsophagus is cut away such pieces form rings; if it remains, closure of the wound and restitution are impossible.

The mass of the enteric organs is a much more important factor in determining the occurrence or non-occurrence and the method of restitution in *Harenactis* than in *Cerianthus* where these organs are relatively much smaller and very rarely protrude from a cut end.

4 *The Nature and Significance of the Wound-Reactions*

It is evident that the contraction of the cut surface which follows a wound is a general property of the tissues of *Harenactis*. It is not in all cases simply a muscular contraction, for it may occur in regions where muscle fibers are not differentiated or at right angles to the direction of the fibers. Of course where muscle fibers are injured, they become involved in the reaction. In the case of *Cerianthus*, where the wound reaction is also apparently independent of muscle fibers and otherwise very similar to that in

Harenactis I suggested that the contraction was due primarily to a difference in the elasticity of the different layers of the body-wall, though undoubtedly complicated and modified by other factors (Child '04a, pp. 55-65). It is possible the physiological as opposed to the purely mechanical aspects of this reaction were not sufficiently emphasized in that paper, though my work on Harenactis has not brought about any essential modification of my views concerning this point. Here, as in *Cerianthus*, the in-rolling of the body-wall which follows a wound may be interpreted as the result of a difference in elasticity of the different layers of the wall, though it is probable that the physical condition of the wall may be altered by various conditions, including the wound itself.

But the point which seems to me of greatest importance is that the reaction does not appear to possess an adaptive character, either in Harenactis or in *Cerianthus*. Attention was called to this point in my earlier paper (Child '04a, pp. 62-65), but a brief further consideration seems desirable. I am unable to find any basis for the conclusion that the contraction following the wound is an adaptive reaction directed toward bringing the cut margins together and so producing conditions which permit the closure of the wound. Closure may be prevented even more easily in Harenactis than in *Cerianthus* by the form or position of the wound. In every case where a wound is made the wounded surfaces of the tissues contract, whether closure of the wound results from contraction or not. Whether the wound is closed and how it is closed depend, not upon the contraction which follows the wound, but upon the conditions under which that contraction occurs. In the above consideration of the mesenteries, the œsophagus and the mass of the enteric organs as factors in the closure it is sufficiently evident that the contraction may lead to very different results under different conditions. In the œsophageal region, for example, union of the body-wall and œsophagus occurs (Fig. 7, 8, II), not because this is the process best fitted to bring about return to the "normal form," but because any other method of closure is physically impossible under the conditions. The contraction of the cut mesenteries must bring the margin of body-wall and

œsophagus together. This result occurs with the same certainty at the aboral as at the oral end (Fig. 13), though closure of the aboral end in this manner renders a return to the normal form absolutely impossible and the animal is condemned by its own reactions to a death by starvation since there is no opening between the enteron and the exterior.

On the other hand, in the subœsophageal region the plug of muscles and mesenterial filaments which is forced out of the wound by the contraction (e.g., Fig. 14) often serves to prevent absolutely the closure of the wound. The formation of the "rings" (Fig. 15) when these plugs are cut away has been described above: these rings are as naturally and necessarily the result under certain conditions of the contraction following the wound as is the "normal" method of closure under other conditions.

Contraction follows longitudinal wounds just as it does transverse, but in longitudinal wounds of considerable length closure almost never occurs, simply because there is nothing in the structure of the animal which serves to bring the cut edges together. Often in such cases the body rolls up in a spiral about either a longitudinal or a transverse axis and closure becomes absolutely impossible. Figs. 10-24 of my *Cerianthus* paper (Child '04a) show some of the reactions to longitudinal wounds in *Cerianthus*. In *Harenactis* the results are in general similar, though more or less modified by the greater volume of the enteric organs.

In short, if we limit our consideration of the wound-contraction to certain cases it may seem to be more or less "teleological," but if we include all cases it becomes evident at once that the result of the reaction differs very greatly according to conditions, even in some cases making continued existence impossible.

The growth of new tissue following the wound does not appear to be an adaptive or teleological reaction any more than the contraction of the tissues. The conditions under which it occurs have been described above; apparently it occurs wherever these conditions exist, without any relation to the result produced. The growth of new tissue between the cut margins of œsophagus and body-wall occurs as readily at the aboral (Fig. 13) as at the oral end of a piece, although in the former case continued existence

becomes impossible because of this growth. The same may be said concerning the formation of the "rings" (Fig. 15) and various other "abnormal" results.

On the other hand, closure of the wound by new tissue may be delayed for months, or may fail entirely to occur simply because the wound possesses a certain direction or because of certain relations existing between it and parts of the body.

The facts cited seem to force the conclusion that various reactions which result under certain conditions in the closure of the wound by new tissue are not adaptively directed toward "restoration of the normal form" or any other end. On the contrary, they are very evidently in no way concerned with such restoration for they occur just as readily, provided the proper physical conditions are present, in cases where their occurrence renders restoration of the normal form impossible and leads inevitably to death.

It is of interest in this connection to note that Moszkowski in a recent paper takes a very different position. In summing up, he says:

"Die Ersatzreaktionen bei Actinien lassen jedenfalls erkennen, dass dem Actinienkörper ein immanentes Bestreben innewohnt, erlittene Verletzungen wieder gut zu machen, und zwar stehen diesen Formen mannigfache Arten des Ersatzes zu Gebote. Welche Ersatzreaktion gewählt wird, hängt von der Höhe ab, in der operirt wird. Es scheint aber, dass ein weiteres Bestreben vorwaltet, immer diejenige Art des Ersatzes zu wählen, bei der die Restitutio ad integrum am schnellsten erfolgt. Auch wenn verschiedene Arten des Ersatzes in Konkurrenz miteinander treten, wird immer diejenige obsiegen, welche die rascheste Erreichung des zielees garantiert. Es liegt den Ersatzreaktionen bei Actinien also ein exquisit teleologisches Prinzip zugrunde, wobei es vorläufig noch unausgemacht bleiben soll, ob dieses Prinzip als ein *primäres* oder *sekundär erworbenes* anzusehen ist" (Moszkowski '07, p. 432). It is impossible to discuss this paper at length here, but the actual results of experiment do not differ very widely from those recorded by others with other species. After careful study of the paper I can say only that the facts cited do not seem to me to afford a basis for conclusions such as

that quoted. I believe that much more extensive series of experiments are necessary as a foundation for such a conclusion and it is my experience that the more varied and extensive the experimentation, the less teleological do the reactions appear. In certain cases, at least, the "choice" of a method of reaction, of which Moszkowski speaks, is nothing more than the fact, clothed in teleological language, that the structure of the animal is such that only a certain reaction is possible. It might be said for *Cerianthus* and *Harenactis*, for example, that in the œsophageal region, the reaction is chosen which brings the cut edges of body-wall and œsophagus together and so hastens restitution. However, when we find that such a reaction occurs aborally as readily as orally although in this case it renders continued existence impossible, it becomes evident that there is nothing adaptive or teleological about it. When we actually analyze it instead of assuming its teleological character, we find that it results primarily simply from the fact that all tissues of these species contract when wounded and freed from the tension resulting from enteric fluid. This being the case, the anatomical arrangement of parts determines that the method of closure shall be different in the œsophageal and the subœsophageal regions. The reaction occurs in the characteristic manner in each region, whether it leads to the death of the individual or to complete restitution. Something more convincing than the facts recorded in this paper of Moszkowski's are necessary before we can accept his conclusions.

II THE DIFFERENTIATION OF NEW PARTS

The visible stages of the differentiation of new structures requires only brief consideration because *Harenactis* does not differ widely from *Cerianthus* (Child '03a). The disc and tentacles are formed by redifferentiation of the most distal portions of the body-wall of the piece, together with the new tissue which closes the wound (Figs. 16-17). When the level of section is in the œsophageal region the union of the cut edges of body-wall and œsophagus leaves the distal end of the old œsophagus widely open as a mouth (Figs. 8 and 16), but in the subœsophageal region the œsophagus

is formed anew from the central portion of the new terminal region (Fig. 17). The new tentacles arise from that region of the body-wall which was originally just aboral to the wound, not from the cut surface itself (Figs. 16 and 17). The diameter of the disc is at first considerably less than the diameter of the column, but as growth proceeds it increases (Figs. 17 and 18). Except in certain special cases to be considered later the number of tentacles is always twenty-four, i.e., the same as the number of mesenteries, and in restitution as in ontogeny, the tentacles arise over those regions which in the new position of the body-wall following inrolling become the oral ends of the intermesenterial chambers. Since *Harenactis* possesses a definite number of mesenteries, twenty-four, which extend the whole length of the body,

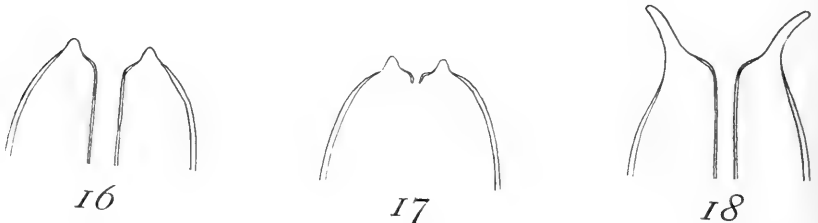

new mesenteries are not formed in restitution, though extensive redifferentiation of the old mesenteries may occur, e.g., in the case of restitution of an oral end in the suboesophageal region, where the formation of an oesophageal region is involved.

In *Cerianthus* the new tissue, or at least the regions where growth is most rapid, differ in color from others, but in *Harenactis* new tissue or regions of rapid growth very soon become indistinguishable from the other parts. In the case of oral restitution it is quite impossible to determine how far the formation of new material is localized in the oral region after the formation of disc and tentacles.

In the healing of wounds and restitution where the formation of new tentacles and disc does not occur, i.e., in lateral wounds not involving the oesophagus and in aboral restitution, the new tissue formed is at first distinguishable from the old by greater

transparency and delicacy, but there is no sharp boundary between it and the old and the differences of the earlier stages soon disappear, so that in these cases also it is impossible to determine exactly to what extent localized growth occurs. The foot-region does not differ from other parts of the body-wall in its gross anatomical characteristics, therefore the only certain proof of the restitution of the foot-region is attachment.

Localized growth of new tissue can be greatly increased by repeated operation, i.e., the growth-reaction after each operation is much the same. It is possible in this manner to alter the shape of the body to a very considerable degree. Figures 19 and 20

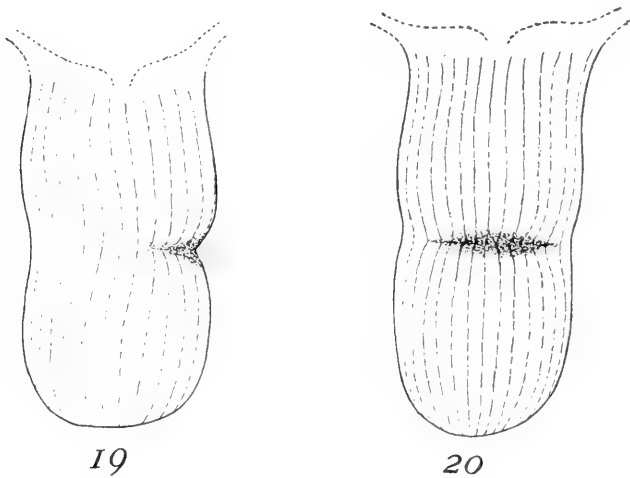

show the usual method of closure of a lateral transverse wound not involving the œsophagus and not renewed after healing has occurred the first time. The shaded region in the figures indicates approximately the extent of the new tissue. In Figs. 21 and 22 two cases are shown in which the lateral cut was repeated a number of times, in each case after the preceding wound had healed. Each healing involved more or less localized growth in the region of the wound, and deformation of the body was the result. The two figures show different processes of deformation depending on the character of the wound. In Fig. 21 the wound was deep

and terminal cut edges of considerable extent existed after each operation. Each time the wound healed the new tissue extended a little further along the cut edges of the mesenteries, so that separation of the regions oral and aboral to the wound was gradually taking place. In Fig. 22, on the other hand the cut was not deep and affected chiefly the body-wall, the mesenteries being but little involved. Here the growth which follows each operation brings about a bulging of the body-wall instead of a depression, as in

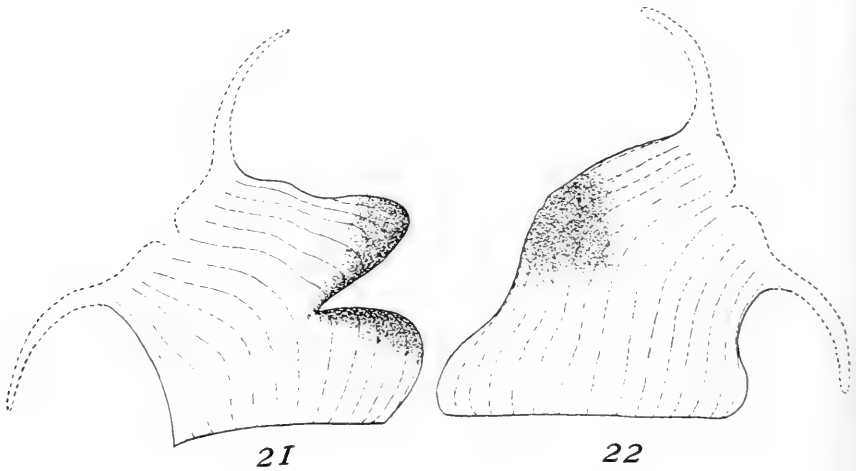

the preceding case. In these two cases the reaction is exactly the same, so far as can be determined, and the difference in the result is due simply to the different physical conditions under which the reaction occurs.

In cases like Fig. 22 more or less regulation of the shape usually occurs if the animal is finally left undisturbed, but a shape like that in Fig. 21 is, at least relatively, permanent, though regulation may perhaps occur very slowly.

III REGIONAL FACTOR IN ORAL RESTITUTION

I *The Limits of Restitution and the Limits of Experiment*

The high degree of contractility of the body-wall, and the volume of the mesenterial organs constitute together an obstacle to the isolation of small pieces of the body of *Harenactis*. In the middle region of the body, between the œsophagus and the attenuated aboral region it is usually impossible to obtain normal restitution from pieces of less than one-third or one-fourth of the whole length of the body. In such pieces a wound is present at each end and the immediate wound-reaction is so violent that the mesenteries and muscles are forced out of one or both ends of the piece by the contraction following the wound, and form a plug preventing closure, or die and disintegrate and apparently infect other regions. or occasionally the whole piece turns inside out and remains in that condition until death. If the protruding plug be cut off the stimulation produces further contraction and other masses of the mesenterial organs take the place of those removed. The result of the removal of all these organs, viz: the formation of "rings" (Figs. 14 and 15) has already been mentioned. In the œsophageal region short pieces with a wound at each end often extrude the œsophagus. All of these conditions make it practically impossible to determine the regulatory capacities of most regions of the body by isolation of small pieces. The phenomena in rings, which will be described later, afford good reason for believing that even very small pieces of the body are physiologically capable of complete restitution, but usually fail to undergo such restitution simply because closure of the wound is physically impossible after the extrusion of the enteric organs. In the attenuated aboral region the volume of the enteric organs is not great and closure of the wound usually occurs even in very short pieces. Here, however, as will appear below, the physiological capacity is lacking or very much less than elsewhere and restitution is much retarded, or does not occur at all.

In pieces with a wound at only one end, i.e., pieces possessing the original oral or aboral end, the contraction following the wound

is usually not as violent as in the above cases and the enteric organs are extruded only slightly and temporarily, or not at all. In these cases restitution is complete at the same levels at which it is impossible in pieces with both ends cut, though the physiological capacity may be the same or almost the same in both.

The non-teleological character of the regulatory reactions following removal of a part appears very clearly in these relations. In the regions where the body is physiologically capable of complete restitution, even in small pieces, the physical conditions resulting from the wound interfere with and prevent restitution in certain cases. In the extreme aboral region, on the other hand, where the physiological capacity for restitution is very slight no such physical obstacles to closure of the wound exist.

2 *The Experimental Data*

Regional Difference in Rapidity and Amount of Restitution

As was noted above, the presence or absence of the œsophagus determines to a certain extent the method of wound-closure and the time at which the restitution proper may begin. This, however, is merely an incidental anatomical factor: another regional factor more fundamental in character and quite independent of the œsophagus exists, as is evident from the decreasing rapidity of restitution with increasing distance from the oral end.

The time of appearance of the tentacles and the rapidity of their growth are the most conspicuous features of this regional difference. Measurements of the length of the tentacles cannot of course possess any exact value for the length of the tentacles varies within wide limits according to the degree of distension. In individuals kept under similar or identical conditions, however, the degree of distension is likely to be more or less similar, and observation and measurement of a large number of individuals have shown very clearly that a comparison of tentacle-lengths is possible. Such measurements do not show anything that cannot be discovered by direct observation; they merely afford a means for recording briefly the results of observation.

TABLE I

Time of appearance and length of tentacles in mm. at different levels

SERIES	3 DAYS	8 DAYS	14 DAYS	26 DAYS	136 DAYS
I (a, Fig. 2).....	1-2	7-10	20-25	12-20	6-12
II (b, Fig. 2).....	0.5	6-8	10-15	12-15	8-10
III (c, Fig. 2).....	0.	5-7	5-10	12-18	7-15
IV (d, Fig. 2).....	0.	0.	2	10	6
V (f, Fig. 2).....	0.	0.	0.	0-5	degenerating

Table I gives the results obtained in five series of three pieces each. The level of the oral end of each series is indicated in the table by the reference to Fig. 2. In all cases the pieces include all that portion of the body proximal to the level of the section, consequently they are of very different sizes: in Series I, for example they include practically the whole body except the extreme oral end, and each of the following series includes less of the body than the preceding until in Series V only the attenuated aboral end is included, and the pieces are only a small fraction of the size of Series I. The tentacle measurements given in the table are maximum and minimum measurements for all pieces of the series: the tentacles of a single piece are usually very nearly equal in length. In Series IV only one piece out of three closed and produced tentacles: in Series V two pieces closed but only one produced tentacles.

As regards the time of appearance of the tentacles, the table is not exact since the pieces were not examined every day, but it shows clearly enough that the length of time between the operation and the appearance of the tentacles increases with increasing distance of the level of section from the oral end. That the presence or absence of the œsophagus is not responsible for this difference is evident from the fact that a difference exists both between levels within the œsophageal region (Series I and II) and between those entirely aboral to the œsophageal region (Series IV and V).

The tentacles in all series attained their maximum length in fourteen to twenty-six days after the operation. As a matter of

fact it so happens that approximately the maximum lengths appear in these series either at fourteen or twenty-six days, thus making it unnecessary to give in the table the measurements of intervening or immediately following dates. In other words, the tentacles in Series I reach their maximum length fourteen days after section and are considerably reduced at twenty-six days. In the other series the maximum is reached somewhere between fourteen and twenty-six days, but reduction of the tentacles does not begin until later. In Series II the maximum length is almost attained at fourteen days, in Series III the tentacles are scarcely more than half their maximum length after fourteen days, in Series IV almost the whole growth of the tentacles occurs after fourteen days and in Series V the tentacles do not appear within fourteen days (as a matter of fact, not until nineteen or twenty days) and soon cease to grow.

Series I to III show very clearly that the rapidity of growth of the tentacles decreases with increasing distance from the oral end, i.e., the tentacles not only require a longer time for the first stages of differentiation, but after their differentiation grow more slowly. In Series I a growth of 20–25 mm. occurs within fourteen days, in Series II 10–15 mm. and in Series III 5–10 mm. in the same time. The time of first appearance of the tentacles in these three series differed by only about two days, yet the difference in the amount of growth after fourteen days is considerable; in Series IV and V, however, the rate of growth after the tentacles appear does not differ very greatly from that of Series III: in Series IV the tentacles appeared after about twelve days and grew 10 mm. in the next fourteen days, and in Series V they appeared after about nineteen days and grew 5 mm. in the next seven days. These pieces from the aboral region of the body are always very irregular in time: in some other series the rapidity of growth in such pieces is less than half that in pieces like Series III. However, all the data which I have obtained on the subject indicate that there is a marked difference in the rapidity of growth between distal and proximal regions, and that such difference is independent of gross anatomical features in the different regions.

The table shows that after twenty-six days the difference in the

length of the tentacles in the different series is much less than after fourteen days: in Series I the tentacles have undergone reduction, in Series II slight growth has occurred in the pieces with shortest tentacles, and in Series III the tentacles have almost doubled their length between fourteen and twenty-six days. In Series IV and V most or all of the growth of the tentacles has occurred during this period. The chief point of interest in this connection is that after twenty-six days there is no great difference in the length of the tentacles in Series I, II, and III, although the difference in size of pieces in the three Series, especially I and III is considerable: moreover, in Series IV the length of the tentacles (10 mm.) is almost as great as the minimal length of tentacles in Series I (12 mm.), though the pieces of Series IV are less than half as long as those of Series I (Fig. 2). In Series V, where the pieces include only the proximal fifth or fourth of the body, the tentacles are only half as long as those in Series IV. It should be noted in passing that in most cases such pieces as those of Series V simply close and do not form tentacles at all. Series V shows the greatest development of any case observed.

Evidently the length of tentacles produced is not proportional to the size of the piece, though larger pieces do produce somewhat longer tentacles. The smaller pieces, however, except in extreme proximal regions produce relatively longer tentacles than the larger.

One other point remains to be considered in connection with these series, viz: the much more rapid reduction in length of the tentacles after they have reached their maximum length, in Series I than in the other series. Between fourteen and twenty-six days the tentacles in Series I decrease in some cases almost half their length (from 20-25 mm. to 12-20 mm.), while in the other series the decrease in length during four months is in most cases less than this (see Table I, last two columns). In another paper (Child '09) I have called attention to the change of shape and behavior which *Harenactis* undergoes when forced to live without sand or mud in which to imbed itself. Decrease in the length of the tentacles is one of the features of this regulation, the atrophied tips often being visible on the tentacles in such cases. In

the case of Series I of Table I the decrease in length of the tentacles between fourteen and twenty-six days is a part of this regulatory process. The growth of these tentacles was so rapid that they attain a much greater length than the tentacles of the other series, consequently as the altered environment made itself felt, the tentacles in Series I were much more affected by it than those of the other series, which had grown more slowly.

To sum up: my observations on the regional differences in oral restitution in *Harenactis* show that rapidity of formation and growth in length of the new tentacles decrease proximally in the body; that the amount of tentacle-restitution is not proportional to the size of the piece nor directly correlated with the region of the body, for smaller pieces produce relatively longer tentacles than larger, even though the level of restitution may be much farther proximal in the former than in the latter.

Attention may be called in passing to the fact that in pieces of very different length, but with oral ends at the same level of the body, the rapidity and amount of tentacle-restitution are approximately the same, except when the differences in size are extreme, in which case the tentacles of the smaller piece do not attain quite the length of those of the longer piece. In *Harenactis* the results in small pieces are often complicated by the extrusion of enteric organs, so that it is difficult to obtain satisfactory data for pieces of very small size. In general the regional differences in rapidity and amount of tentacle-restitution and the relations between amount of restitution and size of piece are much the same in *Harenactis* as in *Cerianthus* (Child '03b): the later series of data confirms the earlier.

Regional Differences in the Number of Tentacles

In normal individuals of *Harenactis* the number of tentacles and mesenteries is twenty-four: the tentacles form a single row about the margin of the disc and arise as is usual over the inter-mesenterial chambers. The twenty-four mesenteries are arranged in twelve pairs, consisting of two cycles of six pairs each, the members of the two cycles alternating with each other (Torrey '02).

The mesenteries of the second cycle are smaller than those of the first, their retractor muscles are less developed and they bear gonads only occasionally. Both cycles, however, extend the whole length of the column, so that twenty-four mesenteries are present in any cross-section. Thus no new mesenteries are formed in restitution from a distal cut surface at any level and the number of tentacles never exceeds and is very rarely less than twenty-four.

Pieces from the proximal fifth or fourth of the body, however, when they produce tentacles at all produce a smaller number than twenty-four. Usually such pieces simply close after a considerable time but produce no tentacles. In only four cases of this kind has the formation of tentacles been observed.

One of these cases, a piece consisting as nearly as could be determined, of that portion of the body proximal to the line *e* in Fig. 2, gave rise at first to ten tentacles and very soon after to two more, twelve in all (Fig. 23). The ten tentacles were first visible fourteen days after section and the two additional appeared within the following week. Of the twelve tentacles as shown in Fig. 23 eleven are about equal in length and one is much shorter. A month later the piece possessed fourteen tentacles, thirteen long and one short. Unfortunately the position and sequence of new tentacles was not determined. Though the piece was kept for two months more no more tentacles were produced.

A second case in which the piece included approximately the region proximal to the line *f* in Fig. 2, gave rise after twenty days to twelve tentacles which attained a length of 5-6 mm. No additional tentacles were produced by this piece and the tentacles present underwent gradual reduction during two months following, after which the piece began to degenerate.

In two other cases in which the level of section was somewhere in the region of the line *d*, Fig. 2, the tentacles appeared after sixteen days. Their number was not determined at first, but ten days later it was found to be twenty-one in each case. A diagram of the disc of one of these cases is shown in Fig. 24: fifteen long and six short tentacles are present, and it is clear that the short tentacles belong to both cycles and are not definitely related as regards position to the siphonoglyphe. In the other case similar

irregularities are present, likewise without definite relation to the axes of symmetry. During two months following no additional tentacles were produced and then death occurred.

These cases present a problem of considerable interest. In all cases twenty-four mesenteries were present in the pieces at the time of section: have some of these mesenteries degenerated or does the usual relation between tentacles and mesenteries or inter-mesenterial chambers not exist in these pieces? Microscopical examination would of course answer this question at once, but since I was desirous of determining whether these pieces were capable of producing more tentacles they were kept alive as long as possible. Several attempts to obtain other pieces of the sort after

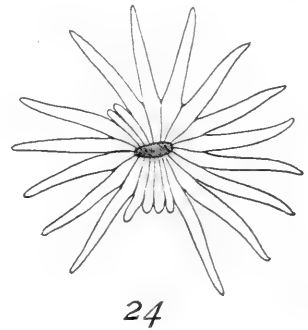
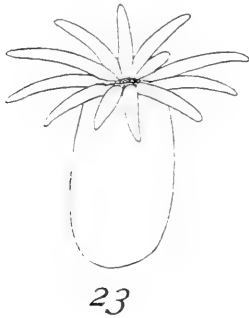

their importance became evident failed, the pieces closing but producing no tentacles. I hope to return to the matter in the future and to decide this question.

I believe, however, that the reasons for the reduced number of tentacles are not far to seek. In the first place, reduction in the number of tentacles may be brought about in more than one way: two different sorts of reduction undoubtedly occur in the pieces described. In the first piece (Fig. 23) and in the second, twelve tentacles arise—in the first piece two of them are later than the others—and there is no external indication of the other twelve. The tentacles present are regularly arranged and, except for one short tentacle in the first piece about equal in length. In consequence of the slight distension the body-wall was rather opaque

and the number of mesenteries could not be determined with certainty by external examination.

This form of reduction in the number of tentacles is due, I believe, to the small size of the individual formed from the pieces. In *Harenactis*, as in other actinians, more or less definite space-relations exist between the mesenteries. This can only mean that the correlations between a mesentery and adjoining regions are of such a nature that other mesenteries are prevented from developing within a certain distance of the already existing mesentery. Consequently if the size of a region in which mesenteries are present undergoes a real physiological decrease, the mesenteries are brought "too near" each other. In cases of this sort, where two organs come into physiological conflict, we commonly find, at least in the lower forms, either that one of them undergoes atrophy, resorption, or separation, or that both are more or less reduced.

In the two cases under consideration these conditions are present. The closure of the pieces after section is very slow, consequently they remain collapsed for a long time. The body-wall and mesenteries of *Harenactis*, like those of other actinians with which I have worked, undergo more or less complete atrophy in the absence of the functional stimulus arising from distension of the body by fluid (Cf. Child '04b, '04c, '04d, '04e, 05a, '08, '09). There is then in such pieces a real physiological decrease in size. I think it probable that under these conditions the mesenteries of the second cycle, i. e., the six pairs of smaller, less highly developed mesenteries, undergo atrophy or degeneration. This of course reduces the number of the inter-mesenterial chambers and consequently the number of tentacles by one-half. By this method of reduction in number every alternate tentacle disappears: apparently that is exactly what has occurred in the two pieces with twelve tentacles. One of these pieces produced two more tentacles after a considerable time: in this case it may be that the atrophy of some of the second cycle of mesenteries was not complete, or else that with the functional growth following renewed distension the reappearance of the mesenteries of the second cycle or of some of them becomes possible again.

In the other two cases described only three tentacles were entirely absent, but a number of others in irregularly arranged groups about the margin of the disc appeared later and were for a long time much smaller than the remainder (Fig. 24). In these cases no definite relations exist between the mesenterial arrangement and the regions where tentacles are lost or reduced in size.

In my work on *Cerianthus* I showed that local inhibition of tentacle-formation might occur as the result of folds in the body-wall (Child '04b, pp. 281-284). If these folds persist for any considerable length of time atrophy of the region occurs. This is especially noticeable in *Cerianthus æstuarii* (Child '08) where complete degeneration and disintegration of the body-wall in folds and compressed regions often occurs.

The reason for this local atrophy in folded or wrinkled regions lies in the fact that even in "collapsed" pieces, i.e., in pieces with an artificial opening into the enteron which prevents normal distension, some slight degree of distension exists so long as the pieces are undisturbed (Child '04b, '04c, etc.). In *Cerianthus* the wound becomes plugged by the slime secretion, in *Harenactis* by slime and in certain regions by the cut ends of muscles and mesenteries. Consequently some degree of distension arises, as can easily be shown experimentally, but the pressure cannot attain anything like that in normal animals for as soon as it exceeds a certain small amount water escapes through the wound. Such slight distension is not sufficient to remove the folds and wrinkles from the body-wall, and these regions are consequently not subjected even to the slight degree of tension existing elsewhere, therefore they undergo more reduction or atrophy than the other regions. Experimental demonstration of these facts is not in the least difficult. I have observed and established experimentally these conditions in a very large number of cases, especially in *Cerianthus æstuarii*.

The two pieces of *Harenactis* are simply further examples of local inhibition of tentacle-formation in consequence of local atrophy. Since closure is retarded in these pieces they remain collapsed for a much longer time than is usual in more distal pieces, and during the period of collapse the body becomes variously

folded and greatly reduced in size. There is no doubt that a greater or less degree of atrophy occurs in the most compressed regions: if the period of collapse is sufficiently long the local atrophy may bring about complete disappearance of certain mesenteries. When distension occurs and tentacles develop the tentacles corresponding to these mesenteries will be absent, or if the mesenteries reappear after the normal functional conditions are reestablished, these tentacles may develop later, and perhaps remain of small size for a longer or shorter time. In short, these cases of local absence or retardation of development of tentacles in short proximal pieces are the result of local reduction or atrophy of body-wall and mesenteries which in turn is the result of compression or of absence of tension in wrinkled or folded regions of collapsed or almost collapsed pieces.

As regards regional localization of these phenomena in the body, irregular reduction in number and size of tentacles may occur at any level of the body if the proper conditions arise, but in pieces from the more distal regions closure and distension usually occur so rapidly, if they occur at all, that there is no time for atrophy such as occurs in these proximal pieces.

Regular reduction to half the number of tentacles has been observed only in the two proximal pieces above described (fig. 23), but, as was shown in preceding sections, the course of restitution in small pieces from other regions of the body is so highly modified by the presence of the œsophagus in the more distal regions and the large mass of enteric organs in other regions that it is impossible to obtain any accurate data as to the physiological capacities of these regions. It is probable, however, that the mesenteries, and especially those of the second cycle disappear more readily in the proximal regions of the body than elsewhere, because they are much smaller and less highly differentiated there than elsewhere.

IV GENERAL CONSIDERATIONS

It has been pointed out above that the contraction following the wound is not adaptive in character; apparently it is merely the direct result of the stimulus of the wound, and it occurs in essen-

tially the same manner whatever parts are concerned. It is not even directly related to the closure of the wound, for under certain conditions it renders closure impossible.

The process of closure of the wound by new tissue is likewise not related to any "purpose" such as the return to the normal form but is determined like any other physico-chemical process by constitution and conditions. In many cases the process of wound closure renders absolutely impossible any "return" and leads inevitably to death. Whether closure of the wound shall occur in such manner as to render possible continued existence and restitution of the part lost depends very largely upon the anatomical structure of the region involved, i.e., the arrangement of mesenteries, the œsophagus, the enteric organs, etc. It is also dependent on the character of the wound contraction, for in many cases this contraction establishes physical conditions which render closure impossible.

Physiologically the character of the wound reaction complex is apparently much the same in different regions of the body, though its morphological results may be very different, according to the anatomical relations of parts. The only regional physiological difference which I have been able to discover is a slight decrease in rapidity of the growth of new tissue with increasing distance from the oral end.

The closure of the wound, at least a provisional closure or plugging, is a necessary condition for the occurrence of anything like normal restitution, for in the absence of distension, atrophy of the body-wall and other parts occurs instead of growth. The growth of new tissue in general occurs only under a certain degree of mechanical tension: restitution proper consists therefore, almost entirely of localized differentiation in a continuous sheet of tissue rather than of outgrowth from a cut surface.

The regional differences in oral restitution are apparently chiefly difference of quantity. The rapidity of restitution decreases with increasing distance from the oral end of the body. This difference is apparently physiological in character and independent of the gross anatomical relations of parts. It is, I believe, an expression of a physiological characteristic common

to at least many forms with well marked polarity. In such forms the anterior or oral end and the regions adjoining it are commonly the regions of most rapid or most intense reaction to external conditions, and are usually more frequently or more continuously affected by these conditions and their changes. In short the anterior or oral end is commonly dominant functionally in the body (Child '08a). Regions adjoining this pole share to a greater or less extent in its activity, and their physiological character is more or less completely determined by their correlations with it. In the more complex forms these correlations may be very definite in character and localization, and structural localization may be correspondingly definite, but in simple forms like the actinians the degree of correlation between the anterior or oral region and other parts is apparently more or less nearly proportional to the distance between them, i.e., the greater the distance between the oral end and a given region the less the physiological similarity between them. If the body of such a form, e.g., *Harenactis*, be cut into pieces the oral end of each piece is, so far as "oral processes" are concerned, the dominant region. Since visible morphological differentiation is to be regarded as the expression of the functional processes in the system, the development of the morphological structures characteristic of an oral end may be expected to occur in the most oral region of the piece, if anywhere. Such development will occur, provided the region is sufficiently similar to the original oral region in its physiological capacities or becomes sufficiently similar in consequence of its new position and correlations as the most oral region of the body. No exact limit can be established for the occurrence or non-occurrence of restitution in a given case: we can only say that if the region in question is or becomes so far similar physiologically to the part removed, that it can take the place of the latter to a certain extent in the system, it will develop a morphological structure approaching that of the part removed. The completeness of the restitution will depend upon the completeness with which the substituted region takes the place of the old in the system.

In *Harenactis* all levels of the body except the extreme aboral region are capable of substitution for the original end in sufficient

degree to give rise to the characteristic structures. But the rapidity of morphological restitution decreases as the distance of the level of restitution from the original oral end increases. As I have attempted to show above, this means simply that physiological likeness to the oral end decreases with increasing distance from that end.

This change in physiological likeness with difference in level is not uniform: in the oral half or two-thirds of the body it is not very great, but further aborally the rapidity of oral restitution decreases rapidly until it becomes zero, i.e., in the extreme aboral region the distal end of the piece is incapable of physiological substitution for the original oral end in sufficient degree to produce visible morphological results.

That such substitution is not a purposive or adaptive act but merely a necessary consequence of the constitution of the system and particularly of the correlations of its parts, I have pointed out elsewhere (Child '08a).

In my discussion of polarity in *Tubularia* I called attention to the fact that polarity might appear in quantitative and qualitative regional differences as well as in the oral-aboral or anterior-posterior differences which are commonly termed polar differences (Child '07. These regional differences in the rapidity of restitution in *Harenactis* are as a matter of fact one expression of the physiological differences along the axis which we commonly group together under head of polarity. But discussion along this line is postponed until after the presentation of further data.

SUMMARY

1. The wound-reactions and the general course of restitution in *Harenactis* do not differ widely from those processes in *Cerianthus*. The contraction following the wound is certainly not purely muscular: it is apparently characteristic of the tissues in general and is probably, at least in part, the consequence of certain physical properties of the tissues. The result of this contraction depends upon incidental factors, at least in large measure: under certain conditions the contraction approximates the margins of

the wound and renders possible its closure by new tissue, but under other conditions closure becomes physically impossible, although contraction occurred in the usual manner.

2 Growth of new tissue occurs only under a certain degree of mechanical tension, therefore, no appreciable degree of growth occurs on a single free cut surface. Closure of wounds by new tissue occurs only when two cut surfaces, or two parts of a cut surface are closely approximated to each other or partly in contact. The conditions determining the extension over the opening of the thin membrane of new tissue are such as to indicate that the physical factor of capillarity plays an important rôle in the process.

3 Union may occur between any two cut surfaces which happen to come into contact, without any relation to the "normal" form. Under the usual conditions the gross anatomical feature of the region concerned in a particular case, e.g., the œsophagus, the mesenteries, the retractor muscles, etc., determine whether and how closure shall occur under certain conditions, e.g., in pieces from the œsophageal region, these anatomical factors determine that closure shall occur in such a manner that continued existence becomes impossible.

4 As in *Cerianthus*, the tentacles are not outgrowths from a wound, but localized differentiations in a continuous sheet of tissue.

5 The rapidity of wound closure and of oral restitution decreases with increasing distance of the level from the original oral end. This decrease is not uniform, being small in amount in the oral two-thirds of the body and much greater in the aboral third. In small pieces from the extreme aboral end oral restitution does not occur, but closure of the wound may take place sooner or later, the reaction being slow.

6 In cases where oral restitution does occur in small pieces from the proximal region of the body the number of tentacles is sometimes twelve instead of twenty-four. This development of only half the usual number of tentacles is probably a result of disappearance of the secondary cycle of mesenteries in these very small pieces, i.e., a phenomenon of size rather than of region,

though mesenterial atrophy or resorption probably occurs more readily in the proximal region than elsewhere.

BIBLIOGRAPHY

- CHILD, C. M.—Form Regulation in *Cerianthus*.
 '03a—I. The Typical Course of Regeneration. *Biol. Bull.*, vol. v, no. 5, 1903.
 '03b—II. The Effect of Position, Size and Other Factors upon Regeneration. *Biol. Bull.*, vol. v, no. 6; vol. vi, no. 1, 1903.
 '04a—III. The Initiation of Regeneration. *Biol. Bull.*, vol. vi, no. 2, 1904.
 '04b—IV. The Rôle of Water-Pressure in Regeneration. *Biol. Bull.*, vol. vi, no. 6, 1904.
 '04c—V. The Rôle of Water-Pressure in Regeneration: Further Experiments. *Biol. Bull.*, vol. vii, no. 3, 1904.
 '04d—VI. Certain Special Cases of Regulation and their Relation to Internal Pressure. *Biol. Bull.*, vol. vii, no. 4, 1904.
 '04e—VII. Tentacle-Reduction and Other Experiments. *Biol. Bull.*, vol. vii, no. 6, 1904.
 '05a—VIII. Supplementary Partial Discs and Heteromorphic Tentacles. *Biol. Bull.*, vol. viii, no. 2, 1905.
 '05b—IX. Regulation, Form, and Proportion. *Biol. Bull.*, vol. viii, no. 5, 1905.
 '07—An Analysis of Form-Regulation in Tubularia. VI. The Significance of Certain Modifications of Regulation; Polarity and Form-Regulation in General. *Arch. f. Entwicklungsmech.* Bd. xxiv, H. 2. 1907.
 '08—The Physiological Basis of Restitution of Lost Parts. *Journ. Exp. Zoöl.*, vol. v, no. 4, 1908.
 '08b—Form Regulation in *Cerianthus Æstuarii*. *Biol. Bull.*, vol. xv, no. 1, 1908.
 Regulation of *Harenactis attenuata* in Altered Environment. *Biol. Bull.*, vol. 00, no. 00
- MOSZKOWSKI, M. '07—Die Ersatzreaktionen bei Actinien (*Actinia æquina* und *Actinoloba dianthus*). *Arch. f. Entwicklungsmech.* Bd. xxiv, H. 3, 1907.
- TORREY, H. B. '02—Papers from the Harriman Alaska Expedition. xxx. Anemones, with Discussion of Variation in *Metridium*. *Proceedings of the Washington Acad. of Sci.*, vol. iv, 1902.

THE EFFECTS OF CENTRIFUGAL FORCE UPON THE EGGS OF SOME CHRYSOMELID BEETLES¹

BY

R. W. HEGNER

WITH TWENTY-FOUR FIGURES

CONTENTS

I	Introduction.....	507
II	Material and methods	508
III	The orientation of the eggs of <i>Calligrapha bigsbyana</i>	510
IV	The effects of gravity upon the development of the eggs of insects	511
V	A brief account of the normal embryonic development of <i>Calligrapha bigsbyana</i>	512
VI	The structure of the egg of <i>Calligrapha bigsbyana</i> at the time of deposition	516
VII	The effects of centrifugal force upon eggs centrifuged after deposition.....	517
VIII	The effects of centrifugal force upon eggs laid by centrifuged beetles.....	538
	1 Experiments with <i>C. bigsbyana</i>	538
	2 Experiments with <i>Leptinotarsa decemlineata</i>	539
IX	Review of the effects of centrifugal force upon developing eggs.....	540
	1 The distribution of the egg contents.....	540
	2 The restitution of the egg substances after centrifuging.....	546
	3 The age of the egg when centrifuged.....	547
	4 The rate of development.....	547
	5 Eggs centrifuged before deposition.....	548
X	Summary.....	548
XI	Literature.....	550

I INTRODUCTION

It has been found that insect eggs are definitely oriented within the ovaries and the exact position of the future embryo seems to be determined already at this early period. This fact has led many embryologists to believe that the eggs of insects are very highly organized. If this is true a redistribution of the contents of the egg would have a profound effect upon the development of the embryo. In order to obtain a rearrangement of material a centrifugal machine was used successfully, as is shown by the experiments described in Part VII of this paper.

¹ Contributions from the Zoölogical Laboratory of the University of Michigan. No. 125.

During the course of the study of the germ-cells in some chrysomelid beetles² a disc-shaped mass of granules (Fig. 9, *g, c, d*) was discovered in the freshly laid eggs suspended in the peripheral layer of cytoplasm at the posterior end. I have called this structure the "pole-disc." These granules are taken up by the germ-cells in the course of their migration and apparently determine the character of these cells; on this account I have called them "germ-cell determinants" (Hegner '08 *b*). It was hoped by means of centrifugal force to scatter the granules of the pole-disc and obtain an embryo either without germ-cells or with germ-cells in various parts of the body. It was also thought possible that the pole-disc might move as a whole and, becoming massed in some other region of the egg, might influence at this point cells which would ordinarily become body-cells. As will be seen later some data were secured but not enough to warrant any definite conclusions.

So far as I have been able to learn from the literature no experiments with centrifugal force upon the eggs of insects have ever been performed successfully and in only one case has any arthropod egg been tested in a centrifugal machine (Lyon '07). Lyon merely says: "The ovarian eggs of the common garden spider could be separated by one minute's centrifugalizing into two layers" (p. 169).

The experiments described below were begun at the University of Wisconsin in the spring of 1908 and were continued at the Marine Biological Laboratory at Woods Holl, Mass., where I occupied a room subscribed for by the Wistar Institute of Anatomy and Biology. The material was further studied at the Zoölogical Laboratory of the University of Michigan.

II MATERIAL AND METHODS

During the course of this work eggs of the following beetles were used for experiments: *Calligrapha multipunctata*, *C. bigsbyana*, *C. lunata*, *Leptinotarsa decemlineata* and *Lema trilineata*. The posterior ends of these eggs are fastened to the leaf on which they

²The Origin and Early History of the Germ-Cells in Some Chrysomelid Beetles. Accepted for publication by the Journal of Morphology.

are laid. In the case of *Calligrapha multipunctata* and *C. bigsbyana* the eggs can be definitely oriented as is explained in the next part of this paper. A number of beetles were kept in the laboratory and the eggs were marked on the anterior-ventral surface with a small spot of waterproof india ink. The exact time of deposition was recorded in all cases. The eggs are not always in the same stage of development at the time of laying, but all those in one batch are approximately in the same condition. When the eggs had developed to the desired point they were placed in small indentations in a block of paraffin. The entire block containing the eggs was then lowered to the bottom of a glass tube of an ordinary water-power centrifugal machine. The eggs were then 15 cm. from the axis of rotation. The number of revolutions per minute was not accurately determined, but was probably between 1500 and 2000, although in some cases (those described in experiments C. M. 1 and L. D. 1 and 2) a slower rate of speed was used (360 revolutions per minute). The eggs when taken from the centrifugal machine were left in the cavities in the paraffin block with the heavy end down until they were fixed. In previous work I found a modification of Petrunkevitch's fluid the best for killing and fixing the eggs. This was used entirely for the centrifuged material, although control eggs were fixed in a number of the common mixtures. Eggs were stained in toto with Mayer's hæmalum acidulated with 2 per cent of glacial acetic acid, or with alum cochineal. Sections were stained on the slide principally with hæmalum followed by Bordeaux red.

One difficulty in doing experimental work with the eggs of *Calligrapha* is that only a few are laid at one time (eight is the average number) and, as the conditions of the experiments frequently are responsible for the destruction of some of these, no series contains very many successive stages.

There are also causes for trouble in making preparations. In some instances the eggs stuck fast to the chorion at the outer end, where the contents had been strongly driven against it; the chorion could not be removed from these without injury to that part of the egg. After eggs have been centrifuged they are more difficult to section than before because the large deutoplasmic spheres collect

at the end away from the axis of rotation and a breaking out is frequent in this region.

III THE ORIENTATION OF THE EGGS OF CALLIGRAPHA BIGSBYANA

It has been known for more than twenty years that the eggs of insects are definitely oriented within the ovaries of the adults. Haliez in 1886, finding this to be true of the ova of *Hydrophilus* and *Locusta*, expressed the fact in his "Loi de l'orientation de l'embryon chez les Insectes" as follows. "La cellule-oeuf possède la même orientation que l'organisme maternel qui l'a produit: elle a un pôle cèphalique et un pôle caudal, un côté droit et un côté gauche,

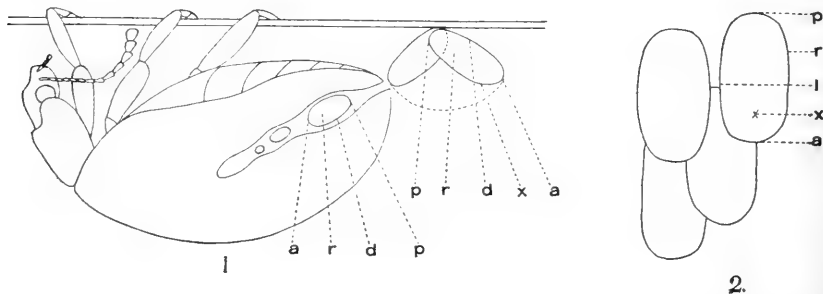

FIG. 1 A diagrammatic drawing of *C. bigsbyana* clinging to the under side of a willow leaf and showing the orientation of the egg in the ovarian tubule and after deposition.

FIG. 2 Four eggs of *C. bigsbyana* laid in two rows. *a.* = anterior. *d.* = dorsal. *l.* = left. *p.* = posterior. *r.* = right. *x.* = anterior ventral surface where the spot of India ink was placed as a guide for orienting the eggs during the experiments.

une face dorsale et une face ventrale; et ces différentes faces de la cellule-oeuf coincident aux faces correspondantes de l'embryon."

No difficulty is experienced in distinguishing the anterior from the posterior end of the eggs of Chrysomelid beetles as it is always the posterior end which first emerges from the vagina. This end is fastened to the leaf on which the egg is laid and subsequently becomes the posterior end of the embryo, regardless of the position of the leaf. In only two species (*Calligrapha multipunctata* and *C. bigsbyana*) of the many Chrysomelid beetles examined could the right and left sides of the egg be accurately determined. The egg laying of these insects is as follows: "The beetle selects

a leaf and clings to its under surface. The tip of the abdomen moves rhythmically up and down about fifteen times at intervals of a little less than one second. This results in the exudation of a drop of viscid, colorless fluid about one-third the transverse diameter of the egg. The egg is forced out a moment later and carries with it this drop of fluid by means of which it is fastened to the leaf. When the egg reaches the leaf it is pushed back away from the beetle (Fig. 1), which then moves to one side and again begins the rhythmical movements which precede the laying of another egg. In this way eggs are laid in a double row as shown in the accompanying figure (Fig. 2), but frequently three or more may be laid in one row. The intervals between the layings of the individual eggs average one minute and twenty seconds" (Hegner '08 a). Two to nineteen eggs are laid at one time, the average number being eight. Fig. 1 indicates the orientation of the egg of *C. bigsbyana* lying in the ovary and also the final position after it has been laid.

IV THE EFFECTS OF GRAVITY UPON THE DEVELOPMENT OF THE EGGS OF INSECTS

That the position of the insect egg after laying has no influence upon the development of the embryo was proved by Wheeler (1889) in the case of *Blatta*. This author kept capsules from fourteen to twenty days in the following positions:

"1 Resting with the lateral faces perpendicular and crista uppermost.

"2 Resting on the crista with the lateral faces perpendicular.

"3 Resting on the left lateral face.

"4 Resting perpendicularly on the anterior end.

"5 Resting perpendicularly on the posterior end.

"In all these cases the eggs developed normally, without the slightest indication of displacement in position or alteration of shape in the embryo; whether they were forced to develop with their heads pointing up or down." The conclusion reached was that "the force of gravitation has no perceptible effect on the development of the eggs of *Blatta*"

Wheeler also proved that the antero-posterior differentiation of the embryo of *Leptinotarsa decemlineata* is not affected by changes in the position of the egg after laying, but is predetermined in the ovary.

During the course of my work with *Calligrapha*, eggs were taken as soon as laid and placed in every possible position. The embryos were found to be in no way affected by the orientation of the egg with respect to gravity.

The only exception to the rule that gravity has no influence upon the development of insects' eggs seems to be that of *Hydrophilus aterrimus* reported by Megušar ('06). The eggs of this water beetle are laid in a boat-like cocoon which is kept in an upright position in the water by means of a peculiar mast. Megušar found that if these cocoons were inverted, thus also inverting the eggs within, the development of the eggs was retarded and a deformity in the embryos resulted. The small number of larvæ that hatched lived for only a short time.

V A BRIEF ACCOUNT OF THE NORMAL EMBRYONIC DEVELOPMENT OF *CALLIGRAPHA BIGSBYANA*

Eggs that have just been laid contain polar bodies in various phases of formation; these are given off into a thickening of the "Keimhautblastem" at a point slightly anterior to the median transverse axis of the egg. The female pronucleus lies in an amœboid accumulation of cytoplasm among the yolk-globules. It moves inward and conjugates with the male pronucleus at a point level with the polar bodies. Here the first cleavage divisions take place. As cleavage progresses a separation of the nuclei into two sections occurs. The nuclei of one group form a more or less regular layer equidistant from the periphery; these pre-blastodermic nuclei (Fig. 17, *pbl. n*) move outward and fuse with the "Keimhautblastem." Cell walls now appear for the first time and a blastoderm is formed of a single layer of regularly arranged cells. The nuclei of the other group (vitellophags), remain behind scattered throughout the yolk (Fig. 17, *vt*). Eight of the nuclei that reach the posterior end of the egg do not remain

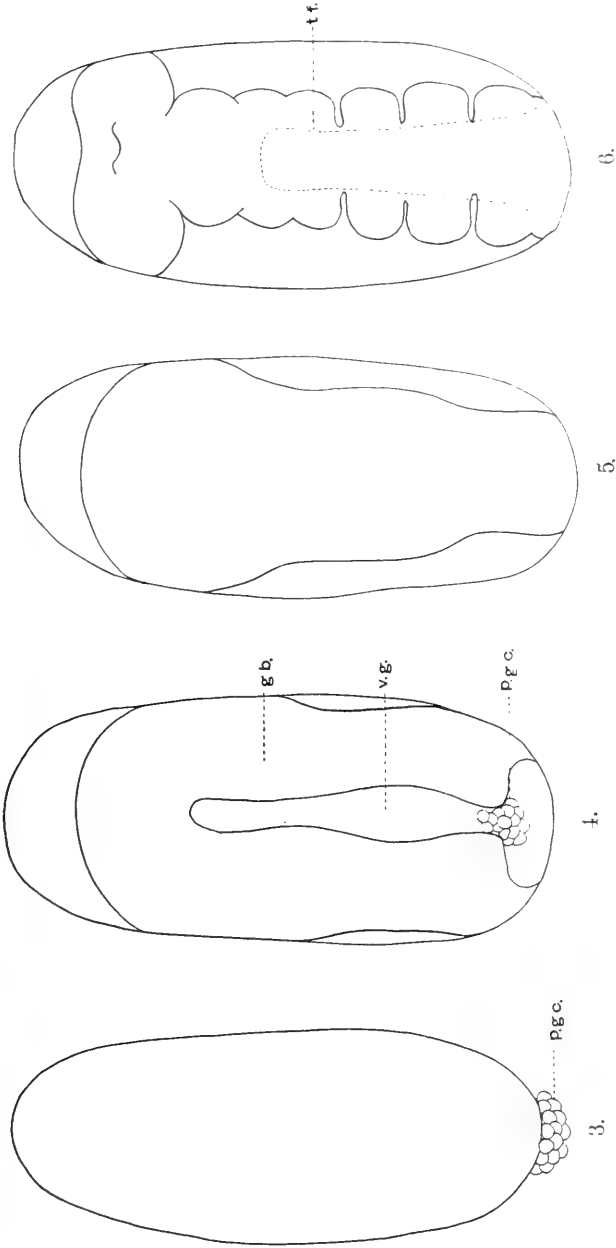

FIG. 3 Surface view of an egg of *C. bigsbyana* twenty-four hours after deposition. The primordial germ-cells form a group at the posterior end.
 FIG. 4 View of the ventral surface of an egg of *C. bigsbyana* thirty-two hours old showing the germ band and the ventral groove.
 FIG. 5 An embryo of *C. bigsbyana* just beginning to segment.
 FIG. 6 An embryo of *C. bigsbyana* showing the tail-fold half-way up on the dorsal surface. p.g.c. = primordial germ-cells. g.b. = germ-band. v.g. = ventral groove. t.f. = tail-fold.

in the peripheral layer, but collect about them a number of granules (germ-cell determinants, Fig. 17, *g c d*) which they encounter in this region and continue their migration until they are entirely separated from the blastoderm. These are the primordial germ-cells (Fig. 3, *p, g c*). The first change noticed in the blastoderm is a crowding together of the cells on the ventral surface of the egg. This results in the formation of a broad longitudinal band of closely aggregated cells, the ventral plate. The edges of this plate are

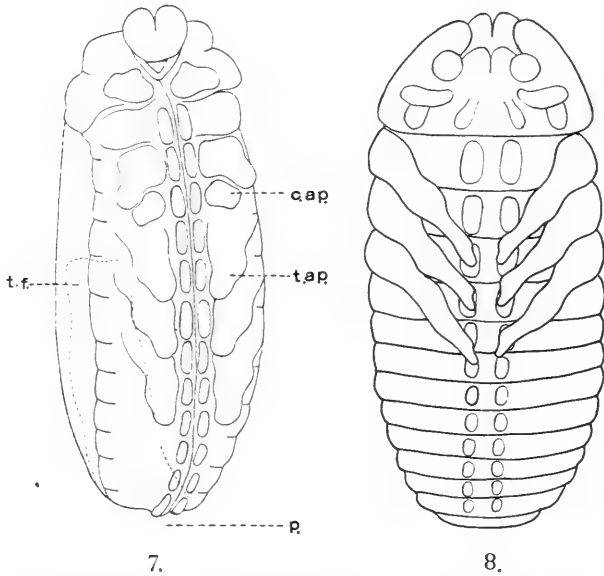

FIG. 7 Surface view of embryo described in Series C.B. 2, *c*. The embryo has begun to broaden and shorten.

FIG. 8 An embryo of *C. bigsbyana* in which the tail-fold is coincident with the posterior end of the egg. *c.ap.* = cephalic appendage. *p.* = posterior. *t.ap.* = thoracic appendage. *t.f.* = tail-fold.

thrown up into two folds; these spread out in the posterior region extending to the end of the egg where they pass around the primordial germ-cells and meet on the dorsal surface. The ventral plate now decreases both in length and in breadth and a longitudinal concavity, the ventral groove, appears. The germ-band can now be recognized; it covers the entire ventral surface of the egg except a wedge-shaped area anterior to the groove (Fig. 4, *g b*).

The germ-band becomes narrower as development advances; its posterior end pushes around that end of the egg and up on the dorsal surface. The lateral folds gradually cover over the ventral groove and the amnioserosal fold grows forward from the posterior

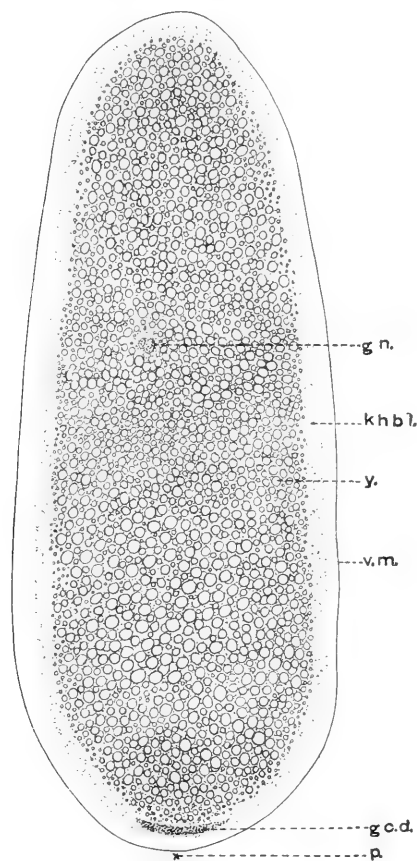

FIG. 9 Longitudinal section through an egg of *C. bigsbyana* four hours after deposition. *g.c.d.* = germ-cell determinants. *g.n.* = germ-nuclei copulating. *k.h.b.l.* = "Keimhautblastem." *p.* = posterior. *v.m.* = vitelline membrane. *y.* = yolk.

end to meet the anterior fold (Fig. 5). The segmentation of the germ-band and the lengthening of the entire embryo now progresses rapidly. The cephalic extremity extends almost to the

anterior end of the egg and the tail-fold extends a little more than half-way up on the dorsal surface (Fig. 6). The tail-fold now begins to recede as the embryo shortens and broadens (Fig. 7) and in a short time coincides with the posterior end of the egg. The embryo now grows laterally around the yolk (Fig. 8), its various parts being situated approximately in the positions they occupy at the end of about six days when it hatches as a larva.

VI THE STRUCTURE OF THE EGG OF CALLIGRAPHA BIGSBYANA AT THE TIME OF DEPOSITION

At the time of laying the eggs of *Calligrapha bigsbyana* are not always in the same stage of development, although usually polar body formation is taking place. The egg figured (Fig. 9) was fixed four hours after deposition. The polar bodies have already been produced in this egg and the male and female nuclei are in the act of conjugation. The egg consists of a large central mass of yolk and a comparatively thin peripheral layer of cytoplasm, the "Keimhautblastem" of Weismann. The interdeutoplasmic spaces are filled with cytoplasm which is connected with the "Keimhautblastem" by delicate strands of the same material. The enormous amount of yolk contained in the eggs of these insects makes the identification of other substances extremely difficult. The yolk-globules range in size from large deutoplasmic spheres to small granules, and, as the dissolution of some of them is continually taking place, one is unable to determine where yolk ends and cytoplasm begins. The only accumulations of cytoplasm large enough for examination are those surrounding the nuclei within the yolk mass, and the peripheral layer, the "Keimhautblastem." No differences in composition or staining qualities were observed between the cytoplasm of these two regions. The "Keimhautblastem" consists of a fluid ground substance in which are suspended very fine granules. It is a homogeneous layer of cytoplasm everywhere except at the posterior end of the egg. At this point there is a disc-shaped mass of larger granules imbedded within the inner portion of it. These granules stain deeply with hæmatoxylin. They are easily seen not only in sections but also

in eggs that have been properly stained in toto. Because of their ultimate fate, as explained in the introduction, I have called these granules the germ-cell determinants (Fig. 9, *g c. d.*).

VII THE EFFECTS OF CENTRIFUGAL FORCE UPON EGGS CENTRIFUGED AFTER DEPOSITION

Table I presents in concise form the main points in the series of experiments which have been selected for detailed description. Besides the thirteen series noted here there are also two tables (XI and XII) which give the results of a number of other series of experiments which were not considered of sufficient importance to describe at length.

TABLE I

List of the experiments described in detail

Name	Number of series	Age when centrifuged	Length of time centrifuged	Orientation
<i>C. bigsbyana</i>	C.B. 4.	o	15 min. to 4 hrs.	post. end in
"	C.B. 3	o	4 hours	ant. end in
"	C.B. 10	o	6 hours	side in
"	C.B. 9	o	6 hours	post. end in
"	C.B. 2	14 hours	1 hour	"
"	C.B. 5	21 hours	2 hours	"
<i>C. multipunctata</i>	C.M. 1	o	16 hours	"
<i>C. lunata</i>	C.L. 2	1 hour	12 hours	"
"	C.L. 1	9 hours	12 hours	ant. end in
<i>L. decemlineata</i>	L.D. 1	2 hours	5 min. to 2½ hrs	post. end in
"	L.D. 1	o	5 days	"
"	L.D. 2	o	7 days	"
<i>Lema trilineata</i>	L.T. 1	o	2 hours	"

Series C.B. 4—Table II

The eggs of this series were centrifuged as soon as laid. They were held in place with their posterior ends towards the axis of rotation. Two eggs were removed at the intervals indicated in Table II; one of these two was fixed immediately, the other was allowed to develop. If the latter did not hatch within a period several days longer than the normal hatching time it was fixed.

TABLE II
Calligrapha bigsbyana—Series C.B. 4

Number of experiment	Age when centrifuged	Length of time centrifuged	Interval between end of experiment and fixation	Orientation	Remarks
C.B. 4, a	Control				
C.B. 4, b	o	15 minutes	o		
C.B. 4, c	o	30 minutes	o		
C.B. 4, d	o	1 hour	o		
C.B. 4, e	o	2 hours	o	Posterior end toward axis of rotation	
C.B. 4, f	o	4 hours	o		
C.B. 4, g	o	15 minutes	6 days		Normal larva
C.B. 4, h	o	30 minutes	6 days		Normal larva
C.B. 4, i	o	1 hour	10 days		Did not hatch
C.B. 4, j	o	2 hours	10 days		Did not hatch
C.B. 4, k	o	4 hours	10 days		Did not hatch

The progressive effect of a centrifugal force upon the distribution of the contents of the egg is shown by these experiments. They also furnish data concerning the amount of disturbance necessary to prevent the hatching of a normal larva.

C.B. 4, a. Sections of the fresh control egg of this series show a condition similar to that illustrated in Fig. 9.

C.B. 4, b. An egg centrifuged for fifteen minutes is very slightly affected. The "Keimhautblastem" has apparently not been changed at all. The yolk shows a partial redistribution; the larger, heavier globules have begun to move toward the outer end of the egg, *i. e.*, the end away from the axis of rotation, and the inner portion of the yolk mass is almost entirely composed of the smaller globules. The pole-disc occupies its normal position at the posterior end of the egg; all about it are small, irregular vesicular spaces which are no doubt caused by the accumulation of the lighter fats in this region. No polar bodies could be discovered in the sections of this egg, but no significance can be attached to this fact as they cannot always be found in normal eggs.

C.B. 4, c. The effects of centrifugal force applied to this egg for thirty minutes are similar to those just recorded for C. B. 4, b.; the changes however are more pronounced. We find that there are

more of the large yolk-globules near the outer end and less of them at the other pole. There is also a slight thickening of the "Keimhautblastem" at the sides of the egg near the inner end. The pole-disc is present in its usual position, but it is surrounded by a greater number and larger, irregular vesicles than in C.B. 4, *b*.

C.B. 4, *d*. An egg taken from the centrifugal machine at the end of an hour is definitely stratified, two distinct layers being visible. There is a small cap of orange-colored material situated at the extreme inner end, while the rest of the egg representing the other layer has changed in color because of the redistribution of the yolk. The intense yellow color of the outer end is due to the invasion of a vast number of large deutoplasmic spheres into that region. No definite layers can be distinguished in this large portion, since the change in color from bright yellow at the outer end to pale yellow at the inner end is gradual. A longitudinal section through this egg is shown in Fig. 10. Most of the large yolk-globules lie in the outer region; the interdeutoplasmic spaces are entirely free from the cytoplasm which usually fills them. The "Keimhautblastem" has been forced almost entirely away from the outer end and from the periphery of the outer third of the egg and has added its mass to that of the inner region. At the extreme inner end one large, bud-like protrusion (one-third the short diameter of the egg) and several smaller ones have formed. They are covered externally by a thin layer of "Keimhautblastem" and are composed of a great number of vesicles. A similar vesicular portion was noted in the two eggs described above (C.B. 4, *b* and *c*), but it has in this egg reached such proportions that we shall hereafter call it the vesicular zone. This is the material which appeared bright orange in color in the living centrifuged egg. Only one nucleus could be discovered in the entire egg. This is situated at one side near the inner end, as shown in Fig. 10, *n*. The pole-disc has moved from its position at the end and has traveled *en masse* away from the axis of rotation. It has carried that portion of the "Keimhautblastem" in which it is suspended along with it, producing a distinct depression at one side of the inner end of the egg. The sections containing the pole-disc fell outside

of the vesicular zone so that a figure has been introduced to show the change in position of this structure (Fig. 11, *g c. d.*).

C.B. 4, e. A third layer makes its appearance if a fresh egg is centrifuged for two hours. Before fixation this appears as a

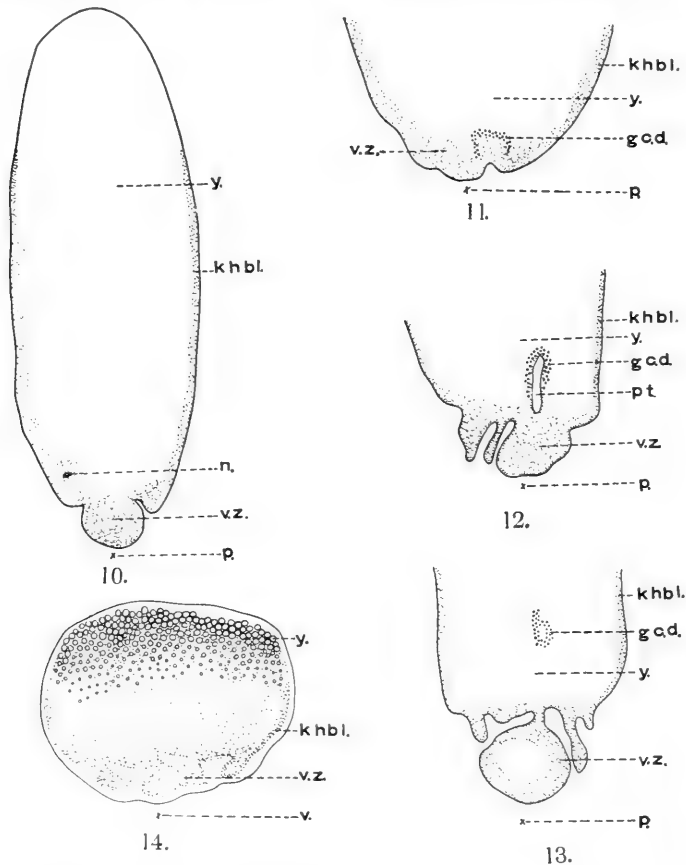

FIG. 10 Longitudinal section through egg C.B. 4, *d.*

FIG. 11. Longitudinal section through the posterior end of egg C.D. 4, *d*, showing the effects of centrifugal force applied for one hour upon the position of the pole-disc (*g.c.d.*).

FIG. 12 Longitudinal section through the posterior end of egg C.B. 4, *e*, showing the effects of a centrifugal force applied for two hours upon the position of the pole-disc.

FIG. 13 Longitudinal section through the posterior end of egg C.B. 4, *f*, showing the effects of a centrifugal applied for four hours upon the position of the pole-disc. *g.c.d.* = germ-cell determinants (pole-disc). *khbl.* = "Keimhautblastem." *n.* = nucleus. *p.* = posterior. *pt.* = pathway made by the outward movement of the pole-disc. *v.* = ventral. *v.z.* = vesicular zone. *y.* = yolk.

FIG. 14 Transverse section through egg C.B. 10, *c.*

colorless cap at the outer end. The sections show it to consist of a small mass of gray material which is heavier than the large yolk-globules. I shall call this the gray cap. It is composed of very small granules, does not stain like yolk nor as intensely as the cytoplasm of the "Keimhautblastem." The pole-disc has moved forward during the second hour the egg was centrifuged, and now lies anterior to its original position about one-fourth of the total length of the egg. In its progress it has pushed its way forcibly through the yolk mass, leaving a long, narrow, open pathway behind it (Fig. 12, *pt*). No nuclei were found in the sections.

C.B. 4, f. This egg was centrifuged for four hours and then fixed. A surface view of the egg stained in toto revealed a large central, colorless bud at the posterior (inner) end surrounded by a number (at least seven) of smaller buds. These are produced by wrinkles or folds in the surface of this region, due either to poor fixation or to a decrease in turgidity at the inner end. The entire egg seems to have been shortened slightly antero-posteriorly by the continued application of centrifugal force. The longitudinal sections made of this egg are not perfect, certain portions of the outer end being lost because of the accumulation of large yolk-globules (yolk which is not imbedded in cytoplasm is liable to break on the knife in cutting). I cannot be positive, therefore, of the presence of a gray cap in this egg. There is little doubt, however, that this structure was not absent in this instance, since the other eggs similarly treated possess a gray cap. The vesicular zone has increased in size during the last two hours this egg was centrifuged, and has been folded into larger bud-like prominences than were noted in the last egg described (*C.B. 4, e*). The pole-disc has made further progress in its journey away from the inner end. It has now reached a point about one-third of the total length of the egg anterior to its original position (Fig. 13, *g c. d*). The open pathway which was observed behind it in *C.B. 4, e*, has become closed and the "Keimhautblastem" that was pulled in with it has passed back and taken part in the vesicular layer.

C.B. 4, g. A normal larva hatched from an egg centrifuged for fifteen minutes with the posterior end towards the axis of rota-

tion. The hatching period of approximately six days is the normal one for eggs of this species.

C.B. 4, h. This egg, which was centrifuged for thirty minutes, also developed normally, the larva hatching in six days.

C.B. 4, i, j and k. None of these eggs continued its development farther than the early cleavage stages.

TABLE III
Calligrapha bigsbyana—Series C.B. 3

Number of experiment	Age when centrifuged	Length of time centrifuged	Interval		Orientation	Remarks
			between end of experiment and	fixation		
C.B. 3, a	Control					
C.B. 3, b	o	4 hours		o	Anterior end	
C.B. 3, c	o	4 hours		37 hours	toward axis of	Did not develop
C.B. 3, d	o	4 hours		61 hours	rotation	"
C.B. 3, e	o	4 hours		96 hours		"
C.B. 3, f	o	4 hours		6½ days		"

Series C.B. 3—Table III

Series C.B. 3 will serve to show the effects of a centrifugal force applied for four hours to fresh eggs with their anterior ends toward the axis of rotation.

C.B. 3, a. The control egg was normal and in a stage slightly younger than that shown in Fig. 9.

C.B. 3, b. When taken from the centrifugal machine at the end of four hours this egg appeared stratified in a manner exactly like that of C.B. 4, e. Longitudinal sections show a gray cap at the heavy outer end, a middle zone of yolk and an inner light vesicular zone. The distribution of the "Keimhautblastem" is also similar to that in an egg centrifuged with the opposite (posterior) end toward the axis of rotation, *i.e.*, it has moved toward the lighter end of the egg. The inner pole is creased and folded as in C.B. 4, e. One nucleus is present near the vesicular zone. The pole-disc remained at the posterior end of the egg near one side;

it fell outside of those sections containing parts of the gray cap so that I was unable to determine whether it is of greater or less specific gravity than the later substance.

C.B. 3, c, d, e, and f. These eggs did not develop very far, although the youngest (*3, c*) contained a number of nuclei in the course of disintegration. Sections of the other eggs (*3, d, e* and *f*) show a further dissolution of the nuclei, the vacuolation of the "Keimhautbastem" and other evidences of catabolism.

TABLE IV

Calligrapha bigsbyana—Series *C.B. 10*

Number of experiment	Age when centrifuged	Interval		Orientation	Remarks
		Length of time centrifuged	time between end of experiment and fixation		
<i>C.B. 10, a</i>	Control				
<i>C.B. 10, b</i>	o	4 hours	o	Right side in*	
<i>C.B. 10, c</i>	o	4 hours	o	Ventral side in	
<i>C.B. 10, d</i>	o	4 hours	36 hours	Right side in	
<i>C.B. 10, e</i>	o	4 hours	48 hours	Right side in	
<i>C.B. 10, f</i>	o	4 hours	60 hours	Ventral side in	
<i>C.B. 10, g</i>	o	4 hours	9 days	Right side in	
<i>C.B. 10, h</i>	o	4 hours	9 days	Ventral side in	

* *This means that the right side of the egg was placed toward the axis of rotation.*

Series *C.B. 10*—Table IV

These experiments were undertaken to determine if the position of the embryo upon the egg can be changed by altering the distribution of the cytoplasm. Four of the eggs were oriented in the centrifugal machine so that their right sides were toward the axis of rotation, the other three with their ventral surfaces toward the center.

C.B. 10, a. The control egg was in an early cleavage stage.

C.B. 10, b and c. No differences could be discovered between an egg centrifuged with its right side turned inward and one with its ventral surface in the same direction, either before or after

fixation. The sections also show a similar arrangement of materials. Fig. 14 represents a transverse section through C.B. 10, *c*. There is a light vesicular zone at the side which was turned toward the axis of rotation; this is folded into bud-like prominences just as we found to be the case in C.B. 4, *e*, and others. The yolk-globules are distributed in the usual manner, the large ones being on the heavy side. The "Keimhautblastem" has moved away from the side of greater specific gravity and toward the lighter side. No gray cap could be found. It is probable that the material which produces this zone has all been thrown to the outer side, but the area is too great to allow of any perceptible accumulation.

C.B. 10, e, f, g and h. No one of these eggs developed beyond an early cleavage stage. The nuclei then disintegrated and the amœboid masses of cytoplasm in which they lay became vacuolated as did also the "Keimhautblastem."

TABLE V

Calligrapha bigsbyana—Series C.B. 9

Number of experiment	Age when trifuged	Interval		Orientation	Remarks
		cen-Length of time between end of centrifuged	experiment and fixation		
C.B. 9, <i>a</i>	Control				
C.B. 9, <i>b</i>	o	6 hours	o		
C.B. 9, <i>c</i>	o	6 hours	41 hours	Posterior end	
C.B. 9, <i>d</i>	o	6 hours	65 hours	toward axis of	
C.B. 9, <i>e</i>	o	6 hours	89 hours	rotation	
C.B. 9, <i>f</i>	o	6 hours	10 days		

Series C.B. 9—Table V

Although these eggs were taken as soon as laid, sections through C.B. 9, *a* show that they were in a rather advanced cleavage stage when the experiments were begun. They represent a condition intermediate between those of series C.B. 2 (Fig. 17) and C.B. 4 (Fig. 9), resembling in structure an egg ten hours old.

C.B. 9, b. Three zones are recognizable in this egg corresponding to those already described in egg *C.B. 4, e* and, although centrifuged for six hours, no noticeable difference is discernible in the distribution of material in this egg and one of nearly the same age which was centrifuged for only one hour (*C.B. 2, b*). The nuclei of many of the vitellophags are distorted or disintegrating. The granules of the pole-disc have, as in normal eggs, become imbedded in the cytoplasm of the primordial germ cells; the latter occupy their usual position at this stage between the vitelline membrane and the blastoderm at the posterior pole.

C.B. 9, c. Two eggs were fixed forty-one hours after they were taken from the centrifugal machine. One of these did not develop, its nuclei disintegrating and the "Keimhautblastem" becoming vacuolated; the other carried an embryo with a distinct ventral groove (Fig. 15). Superficially this embryo resembles that of a normally developed egg of this age except that it does not reach as far anteriorly on the ventral surface, but extends farther around the posterior end and up on the dorsal surface (compare Figs. 4 and 15). It is evident that under the influence of centrifugal force the nuclei and "Keimhautblastem" have become massed in the posterior half of the egg, where development has continued. This egg if it had been allowed to develop would no doubt have produced an embryo resembling that described under *C.M. 1, b* (Fig. 21). Sections of this egg show a rearrangement of the yolk-globules, a condition being reached similar to that illustrated in Fig. 9. The gray cap and vesicular zone are still present.

C.B. 9, d. One of two eggs preserved sixty-five hours after being taken from the centrifugal machine did not develop; the other produced a shapeless mass of tissue, no definite organs being distinguishable. Fig. 16 is a diagram of a sagittal section through this egg. The gray cap and vesicular zone are still present, the former at one side of the outer end of the egg, the latter just dorsal to the embryonic tissue.

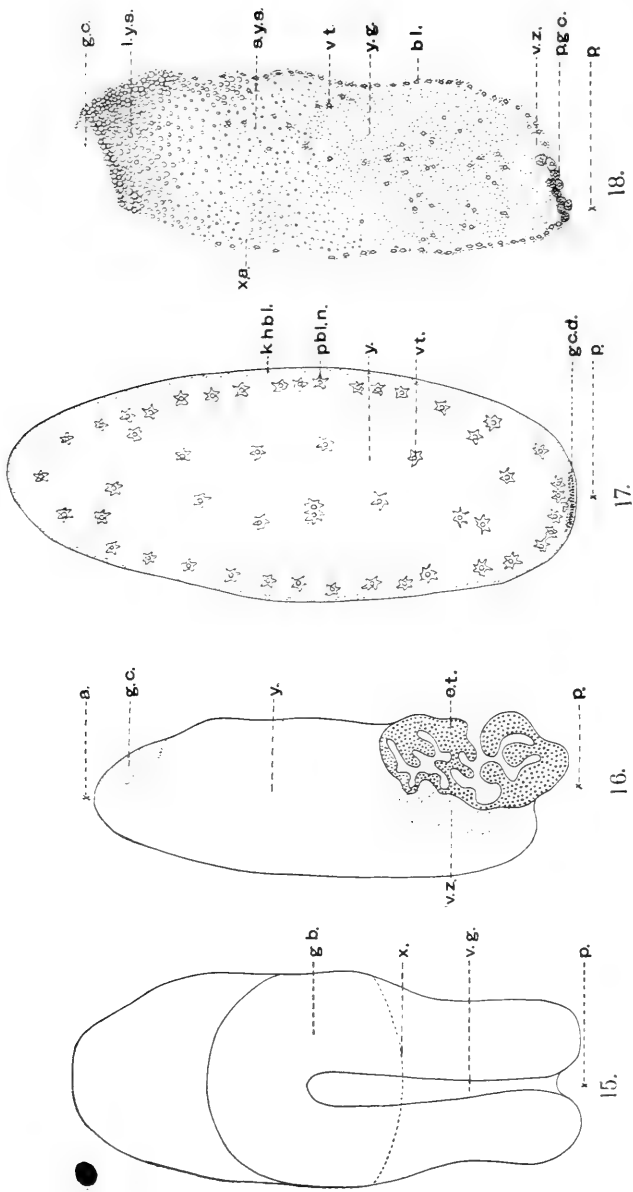

FIG. 15 Ventral surface of egg C.B. 9, c. Compare with Fig. 4.

FIG. 16 Longitudinal section through egg C.B. 9, d, showing a shapeless mass of tissue at the posterior end.

FIG. 17 Longitudinal section through egg C.B. 2, a, showing the normal distribution of the "Keimhautblastem," nuclei and pole-disc fourteen hours after deposition.

FIG. 18 Longitudinal section through egg C.B. 2, b, showing the effects of a centrifugal force applied for one hour upon the distribution of the contents of an egg in the stage of Fig. 17. a. = anterior. bl. = blastoderm. et. = embryonic tissue. gb. = germ-band. g.c. = gray cap. g.c.d. = germ-cell determinants. k.hbl. = "Keimhautblastem," l.y.s. = large yolk spheres. p.bl.n. = preblastodermic nuclei. p.g.c. = primordial germ-cells. s.y.s. = small yolk spheres. v.g. = ventral groove. vt. = vitellophages. v.z. = vesicular zone. x. = posterior end of germ-band on dorsal surface. x.a. = anterior ventral surface where egg was injured in orienting it. y. = yolk. y.g. = yolk granules.

TABLE VI

Calligrapha bigsbyana—Series C.B. 2

Number of experiment	Age when centrifuged	Length of time centrifuged	Interval between end of experiment and fixation	Orientation	Remarks
C.B. 2, <i>a</i>	control			Posterior end	
C.B. 2, <i>b</i>	14 hours	1 hour	o	toward axis of	
C.B. 2, <i>c</i>	14 hours	1 hour	48 hours	rotation	normal embryo
C.B. 2, <i>d</i>	14 hours	1 hour	6 days		normal larva

Series C.B. 2—Table VI

The eggs used in these experiments were laid at 7 p.m. on July 19. One egg was fixed at the end of fourteen hours; the others were at the same time placed in the centrifugal machine with their posterior ends toward the axis of rotation and subjected to the usual number of revolutions for one hour.

C.B. 2, a. Fig. 17 shows the "Keimhautblastem," the pole-disc and the distribution of the nuclei in the control egg, aged fourteen hours. The yolk is not included in this figure, as its distribution is similar to that of the freshly laid egg (Fig. 9). The two groups of nuclei, those which form a more or less regular layer near the periphery and will fuse with the "Keimhautblastem" in a few hours producing the blastoderm (*pbl. n*), and the vitellophags (*vt*) scattered about in the yolk, are quite clearly marked at this stage. When taken from the centrifugal machine a colorless layer of material was observed at the outer end of the egg; this is the gray cap occupying a position similar to that noted under C.B. 4, *e*. The color of the egg was deep yellow posterior to the gray cap and gradually faded out toward the inner end until near that pole it was almost colorless. A bright-yellow cap, the vesicular layer, occupied the extreme inner end. A sagittal section of this egg is shown in Fig. 18. At the anterior end is the heaviest substance in the egg, the gray cap. Just posterior to this we find the largest deutoplasmic spheres which gave to the living egg its bright-yellow color. The spaces among these are

free from cytoplasm. The yolk-globules become smaller and smaller posteriorly until they cease altogether in the middle region, where smaller and lighter yolk granules take their place. At the posterior end there are many irregular vacuoles caused by the accumulation of fat in this region. During the hour the egg was under the influence of centrifugal force the preblastodermic nuclei (Fig. 17 *pbl. n*) migrated outward until they fused with the "Keimhautblastem" forming the blastoderm. The "Keimhautblastem" in the mean time flowed away from the anterior end of the egg, adding this portion to that posterior to it and producing a blastoderm in the latter region decidedly thicker than usual. The nuclei in the blastoderm seem to have been influenced by the centrifugal force; those near the central region have apparently been drawn out of their normal spherical shape and are now oval. As the inner pole is approached the nuclei become less and less oval until at the extreme end they are spherical as normally. The vitellophags have migrated toward the axis of rotation and the outer end is free from them altogether, while a greater number than usual are present near the posterior end. The centrifugal force used has apparently had no effect upon the position of the nuclei of the vitellophags in relation to the mass of cytoplasm which surrounds them, as in every case the nucleus is in or near the center. The direction of division of these vitellophags, however, seems to have been influenced for we find in almost every instance that the daughter cells produced by a recent division lie one posterior to the other, *i.e.*, in the direction of the centrifugal force. The germ-cell determinants have found their way as usual into the primordial germ-cells at the extreme posterior end of the egg (Fig. 18, *p. gc*).

C.B. 2, c. A normal embryo (Fig. 7) was produced by this egg, which was fixed forty-eight hours after being centrifuged. Not the slightest difference could be discovered between an *in toto* preparation of this egg and a normally developed egg of the same age (63 hours). Sagittal sections show that the yolk has undergone segmentation and that the yolk-spheres and yolk-granules are equally distributed throughout the entire yolk mass. The germ-cells have migrated from the posterior amniotic cavity through the

pole-cell canal and into the embryo and lie near the end of the tail-fold. The gray cap has not entirely disappeared, but what I take to be a remnant of it is situated at the dorsal anterior surface.

C.B. 2, d. A normal larva hatched from this egg in the average length of time required for eggs of this beetle when developed under natural conditions.

TABLE VII
Calligrapha bigsbyana—Series C.B. 5

Number of experiment	Age when centrifuged	Length of time centrifuged	Interval between end of experiment and fixation	Orientation	Remarks
C.B. 5, a	control				
C.B. 5, b	21 hours	2 hours	0	Posterior end toward axis of rotation	
C.B. 5, c	21 hours	2 hours	27 hours		normal embryo
C.B. 5, d	21 hours	2 hours	6 days		normal larva

Series C.B. 5—Table VII

This series of experiments was performed in order to discover if centrifugal force would have any appreciable effect on an egg in which the blastoderm has already been formed, and if so whether or not the egg would at this late stage continue to develop and eventually produce a larva.

C.B. 5, a. The eggs of *C. bigsbyana* at the age of twenty-one hours have usually reached a stage in which a blastoderm of a single layer of cells completely covers the central yolk mass. Scattered about irregularly among the yolk-globules are numerous vitellophags. At the posterior pole are a number of cells lying in a closely packed group between the vitelline membrane and the egg (Fig. 3, *pgc.*); these are the primordial germ-cells (pole-cells) which a few hours earlier migrated through that part of the posterior end occupied by the pole-disc, taking the granules of which this is composed along with them.

C.B. 5, b. The application of centrifugal force for two hours has very little effect upon an egg twenty-one hours old as seen in

surface view. The surface at the inner end is creased and folded just as was found to be the case with younger eggs (C.B. 4, *e*). Longitudinal sections through this egg present a distribution of material similar to that with which we are already familiar. A gray cap is present at the outer end (Fig. 19, *g. c.*); the largest deutoplasmic spheres are adjacent to the gray cap, and there is a gradual decrease in the size of the yolk-globules until near the inner end where these are lacking altogether giving way to the vesicular zone. Most of the vitelliphags have passed into the

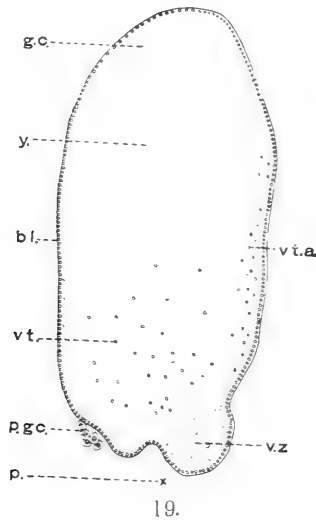

FIG. 19 Longitudinal section through egg C.B. 5, *b.*, showing the effects of a centrifugal force applied for two hours upon an egg covered by a blastoderm. Explanation of letters same as Figs. 15-18. *vt.a.*, = vitelliphags which have fused with the blastoderm.

inner half of the egg; a number of them seem to have fused with the "Keimhautblastem" in the equatorial region. As was the case with the "Keimhautblastem" in the younger eggs (C.B. 4, *e*) the superficial layer (blastoderm) has become thinner at the outer heavy end until it is barely visible at certain points; its mass has been added to that toward the inner end. The primordial germ-cells occupy their normal position at the posterior end of the egg.

C.B. 5, c. An egg in the condition just described was allowed

to develop for twenty-seven hours and then preserved. Externally the embryo it carried appeared to be normal in every respect.

It was in a slightly younger stage than that of C.B. 2, *c*, shown in Fig. 7. Upon sectioning it was found that the vesicular zone had disappeared entirely, that the yolk had segmented and both this and the vitellophags had regained their normal distribution, but that there still remained a small amount of the heavy gray cap. The embryonic tissue seems to have sustained no ill effects from the centrifugal force.

C.B. 5, d. A normal larva hatched from the remaining egg of this series in the average period, six days.

Series C.M. 1.

Two freshly laid eggs of *Calligrapha multipunctata* placed with their posterior ends inward were centrifuged for sixteen hours at a rate much slower than that applied to the eggs in most of the other experiments. At the end of this period three perfectly distinct zones could be recognized by their colors. The nearly uniform pale-orange color of the normal egg had given way at the inner end to bright orange; at the opposite pole was a whitish cap, while the comparatively large central zone faded gradually from bright yellow at its outer end to pale yellow where it joined the inner orange stratum.

C.M. 1, a. An in toto preparation of one of these eggs which was fixed immediately after being taken from the centrifugal machine shows that the three zones do not differ in color only, but are composed of three different substances. Sections of this egg show a stratification similar to that already described for *C. bigsbyana* (C.B. 4, *e*). The stage of development, however, is unlike that of any egg so far examined. Fig. 20 shows the nuclei aggregated in the inner portion of the egg. The "Keimhautblastem" at the sides of the egg and surrounding the folded vesicular zone contains many nuclei producing a kind of blastoderm. The vitellophags have accumulated in the inner portion of the central zone. Many of these are either dividing by amitosis or seem to have recently completed such a division.

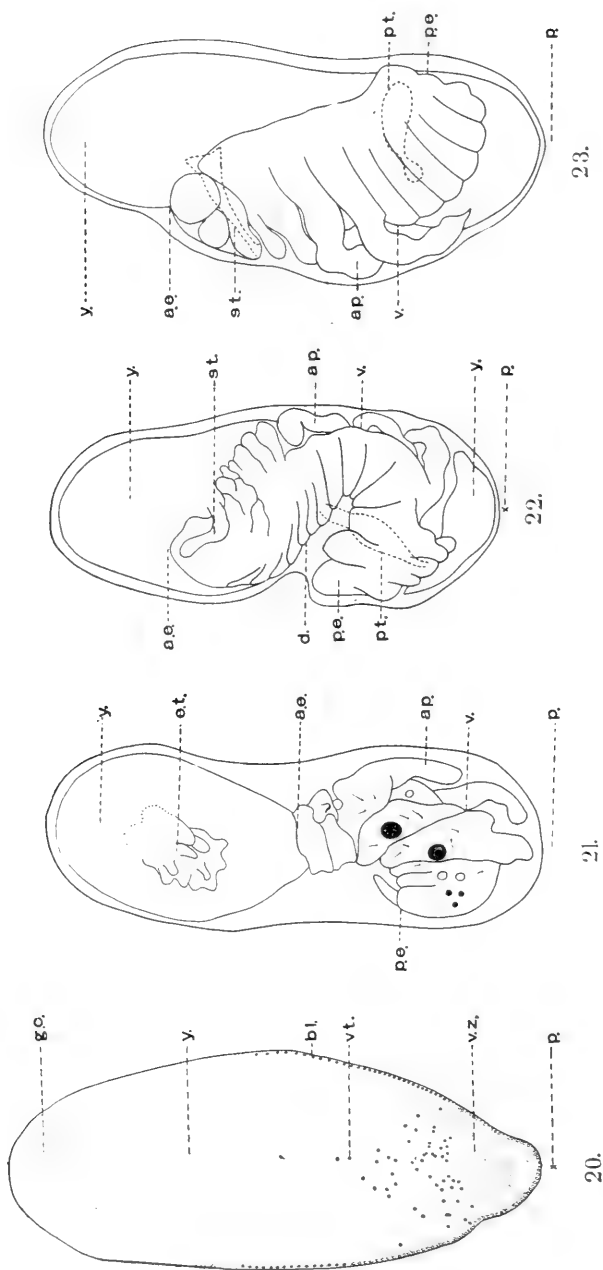

FIG. 20 Longitudinal section through egg C.M.I. *a*.

FIG. 21 Lateral surface view of egg C.M.I. *b*, showing the development of a dwarf embryo outside of the yolk at the posterior end.

FIGS. 22 and 23 Side surface views of eggs from Series L.D.I. showing embryos which have developed outside of the yolk. *ae.* = anterior end of embryo. *ap.* = appendage. *bl.* = blastoderm. *d.* = dorsal. *et.* = embryonic tissue. *g.c.* = gray cap. *p.* = posterior. *pe.* = posterior end of embryo. *pt.* = proctodeum. *st.* = stomodaeum. *v.* = ventral. *vt.* = vitellophag. *v.z.* = vesicular zone. *y.* = yolk.

C.M. 1, b. Fig. 21 represents a surface view of the right side of an egg like that just described which was allowed to develop for nine days. The embryo has continued to develop at the inner (posterior) end. Its orientation is normal except that the entire embryo has shifted its position posteriorly so that the posterior end instead of being coincident with the posterior end of the egg is now part way up on the dorsal surface. A small mass of embryonic tissue is imbedded in the large mass of yolk. Normally this yolk would be surrounded by the embryo and become included within the mid-intestine; in this case a dwarf embryo has developed without growing around the nutritive material.

TABLE VIII
Calligrapha lunata—Series *C.L., a*

Number of experiment	Age when centrifuged	Length of time centrifuged	Interval between end of experiment and fixation	Orientation	Remarks
<i>C.L. a, 1</i>	1 hour	12 hours	0	Posterior end	
<i>C.L. a, 2</i>	"	"	55 hours	toward axis of	
<i>C.L. a, 3</i>	"	"	79 hours	rotation	
<i>C.L. a, 4</i>	"	"	{ 24 days 18 day larva		hatched in 6 days

Series *C.L. a*—Table VIII

The effects of centrifugal force upon the eggs of *C. lunata* are shown by this series of experiments. The results, as may be seen from a comparison of the above table and the following descriptions, differ only in minor details from those recorded for eggs of *C. bigsbyana* similarly treated.

C.L. a, 1. This egg was stratified by the centrifugal force into three layers, a gray cap at the outer heavy end, a middle yolk zone with large deutoplasmic spheres at the outer end gradually decreasing in size toward the inner pole and a light vesicular layer at the extreme inner end. Longitudinal sections resemble those of *C. M. 1* shown in Fig. 20. There are a number of nuclei present scattered about among the yolk-granules near the inner end of the middle zone. Each nucleus is approximately in the

center of the amœboid mass of cytoplasm in which it lies embedded; the whole apparently has moved *en masse* toward the lighter end of the egg. The pole-disc is situated between the vesicular layer and the middle zone; it is probable that its change of position is due, not to any movement of the granules, but to the accumulation of lighter fats posterior to it.

C.L. a, 2. The only redistribution of material that has taken place since this egg was taken from the centrifugal machine is a movement of the "Keimhautblastem," resulting in several large accumulations at the periphery in the middle region. The nuclei have disintegrated and the "Keimhautblastem" has the vacuolated appearance indicative of its early dissolution. No larva could possibly have developed from this egg.

C.L. a, 3. Sections of this egg show a continuation of the catabolic processes mentioned in *C. L. a, 2.*

C.L. a, 4. The only egg which was not fixed before the end of the hatching period seems to have developed normally, as it produced a normal larva. I can account for this only on the assumption that the eggs of this series were differently affected by the centrifugal force and that *C.L. a, 2* and *C.L. a, 3* were too severely injured to continue their development while *C.L. a, 4* was able to readjust itself to the new conditions imposed by the change in the position of the egg contents. A perfect series of sagittal sections was made through this larva; they showed no irregularities in the size, position or structure of the internal organs. The reproductive organs (female) are in their proper positions.

TABLE IX
Calligrapha lunata—Series *C.L.I.*

Number of experiment	Age when centrifuged	Length of time centrifuged	Interval between end of experiment and fixation	Orientation	Remarks
<i>C.L.I. a</i>	control			Anterior end	
<i>C.L.I. b.</i>	9 hours	12 hours	0	toward axis of	
<i>C.L.I. c</i>	"	"	24 hours	rotation	
<i>C.L.I. d</i>	"	"	48 hours		
<i>C.L.I. e</i>	"	"	4 days		hatched

Series C.L. 1—Table IX

The effects of centrifugal force upon the eggs of *C. lunata* when oriented with their anterior ends toward the center are shown by these experiments.

C.L. 1, a. The control egg of this series proved to be in a stage similar to that already described for *C. B. 9, a.*

C.L. 1, b. After being centrifuged for twelve hours this egg showed the customary three strata. Longitudinal sections resemble those of *C. M. 1* (Fig. 20); they differ from them only in the absence of a well-defined blastoderm in the inner region.

C.L. 1, c. During the twenty-four hours since this egg was taken from the centrifugal machine the yolk has had time to redistribute itself to some extent and many of the larger globules are present at the lighter end. Development has proceeded and the inner half of the egg is one large syncytium in the center of which is the vesicular zone containing a few nuclei.

C.L. 1, d. Sections of this egg may be compared with that of *C.B. 9, d*, shown in Fig. 16. There is a mass of tissue at the inner end which is thrown up into folds, but no definite structures are distinguishable in it.

C.L. 1, e. The only egg that was allowed to develop throughout the entire hatching period produced a larva at the end of six days. This larva is apparently normal. It was preserved when three days old.

TABLE X

Leptinotarsa decemlineata—Series L. D. 1

Number of experiment	Age when centrifuged	Length of time centrifuged	Interval between end of experiment and fixation	Orientation	Remarks
L.D. 1, 1	control				
L.D. 1, 2	2 hours	5 minutes		Posterior end	hatched in 6 days
L.D. 1, 3	"	10 minutes		toward axis of	"
L.D. 1, 4	"	20 minutes		rotation	"
L.D. 1, 5	"	45 minutes			"
L.D. 1, 6	"	1½ hours			"
L.D. 1, 7	"	2½ hours			"

Series L.D. 1.—Table X

The above table (Table X) shows the results of a graded series of experiments upon eggs of *Leptinotarsa decemlineata* centrifuged from five minutes to two hours and one half. These eggs, including the control (L. D. 1, 1) all hatched at the same time, showing that the amount of centrifugal force has no perceptible influence upon the rate of development.

Series L.D. 1

L.D. 1. A number of fresh eggs of the potato beetle, *Leptinotarsa decemlineata*, were centrifuged at a low rate of speed (360 revolutions per minute) for five days. They were oriented with their posterior ends toward the axis of rotation. The resulting embryos (Figs. 22 and 23), which of course would not have hatched, are very similar in appearance to that described under C. M. 1, *b*. The heavy substances in these eggs are apparently non-essential for the development of the embryo, being made up principally of nutritive yolk. When deprived of this material a dwarf embryo is produced at the inner end of the egg.

Series L.D. 2

Another batch of potato beetles' eggs were centrifuged at the same rate of speed for seven days. Dwarf embryos developed at the inner light end in every case. No sections were made of these embryos.

Series L. T. 1

A number of eggs of *Lema trilineata* were centrifuged with their posterior ends turned inward. In all cases the stratification induced resembles that of the eggs of *C. bigsbyana* similarly treated.

Table XI presents the data obtained from a number of experiments which have been selected from fifteen series of the eggs of *Calligrapha lunata*. Eight of these centrifuged eggs produced larvæ in the normal hatching period; of these, four were centrifuged with their posterior poles toward the axis of rotation, three with their anterior ends toward the center and one with its side turned

TABLE XI
Calligrapha lunata

Number of experiment	Age when centrifuged	Length of time centrifuged	Interval between end of experiment and fixation	Orientation	Remarks
C.L. d, 3	o	2½ hours		post. pole in	hatched in 6 days
C.L. u, 3	o	1 hour	8 days	"	} did not hatch, high speed
C.L. e, 2	½ hour	3 hours	7 days	"	
C.L. a, 4.	1 hour	12 hours		"	hatched in 6 days
C.L. j, 2	1 hour	13 hours	7 days	"	did not hatch
C.L. 7, f	8 hours	13 hours	11 days	"	"
C.L. h, 3	24 hours	2 hours		"	hatched in 6 days
C.L. x, 5	47 hours	6 hours	7 days	"	did not hatch
C.L. s, 2	50 hours	2 hours		"	hatched in 6 days
C.L. q, 2	o	2 hours	7 days	ant. pole in	did not hatch
C.L. n, 2	½ hour	½ hour		"	hatched in 6 days
C.L. i, e	9 hours	12 hours		"	"
C.L. i, 2	14 hours	2 hours	7 days	"	did not hatch
C.L. k, 2	14 hours	2 hours		"	hatched in 6 days
C.L. b, 2	1 hour	20 minutes		on one side	} hatched in 6 days high speed

TABLE XII
Leptinotarsa decemlineata

Number of experiment	Age when centrifuged	Length of time centrifuged	Interval between end of experiment and fixation	Orientation	Remarks
L.D. c, 5	½ hour	2 hours	7 days	post. pole in	did not hatch
L.D. c, 6	"	"	10 days	"	"
L.D. e, 4	½ hour	4 hours	6 days	"	"
L.D. e, 5	"	"	8 days	"	"
L.D. d, 5	1 hour	1½ hours		"	hatched in 6 days
L.D. b, 5	2½ hours	1 hour		"	"
L.D. k, 5	24 hours	2 hours		"	"
L.D. n, 6	24 hours	½ hour		"	"
L.D. h, 5	o	3 hours	7 days	ant. pole in	did not hatch
L.D. i, 2	o	"		"	hatched in 6 days
L.D. n, 7	24 hours	½ hour		"	"

inward. The age when the eggs were centrifuged ranges from freshly laid to fifty hours. The length of time centrifuged ranges from twenty minutes to twelve hours. It is obvious that there is no definite total amount of centrifugal force which will prevent the hatching of the egg. The orientation of the egg is apparently of no importance.

The data given in Table XII have been selected from eleven series of experiments upon the eggs of *Leptinotarsa decemlineata*. There are too few items in this list to warrant any general conclusions, but the experiments tend to show that an older egg has greater chances of producing a larva after being centrifuged than does one experimented upon a short time after deposition. Both eggs oriented with the posterior end toward the axis of rotation and those with the anterior end toward the center gave rise to normal larvæ.

VIII THE EFFECTS OF CENTRIFUGAL FORCE UPON EGGS LAID BY CENTRIFUGED BEETLES.

I *Experiments with C. bigsbyana*

Series C.B. 12

A female *C. bigsbyana* was centrifuged at the usual rate of speed for two hours and fifteen minutes with her posterior end toward the axis of rotation. When taken from the machine she seemed to suffer no ill effects but proceeded to walk about and feed as usual. Three days later, July 24, five eggs were laid; two of these were fixed at once and the other three allowed to develop. The former showed no outward signs of any disturbances due to centrifugal force. Sections also failed to disclose any rearrangement of materials. The eggs that were left to develop were fixed at the end of eight days. A superficial view of one of these is shown in Fig. 24; a shapeless mass of tissue lies imbedded within the disintegrated yolk mass.

Series C.B. 13

The same beetle as that of Series C. B. 12 laid a second batch of five eggs two hours after the first five were deposited. Two of

these which were fixed immediately showed no effect of centrifugal force; the other three hatched in six days.

2 *Experiments with Leptinotarsa decemlineata*

Series L.D. f

At 3:30 p.m. on July 17 a female *L. decemlineata* was centrifuged for one hour with her posterior end toward the center.

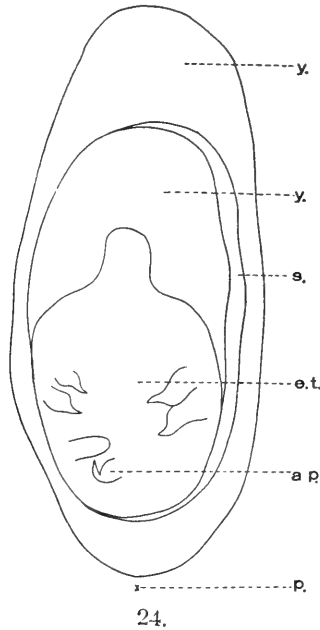

FIG. 24. Surface view of egg C.B. 12 laid by a centrifuged beetle. *ap.* = appendage. *e.t.* = embryonic tissue. *p.* = posterior. *s.* = space between two yolk masses. *y.* = yolk.

One egg was laid an hour after being centrifuged and others were laid at irregular intervals until 9:30 the next morning, when the total number reached seventy. The first egg laid, as well as all of the others in the series, showed a stratification produced by centrifugal force. Only two layers, however, resulted, no gray cap being discovered in the sections. The vesicular zone is not as large as in older eggs centrifuged outside of the body of the mother for a

similar length of time, but the yolk-globules have a distribution almost exactly like that induced in the latter. Many of the eggs were allowed to develop; all of these hatched in six days.

Series L.D. *m*

The same beetle as that of Series L.D. *f* laid a batch of eggs at 7 p.m. July 19, *i.e.*, fifty-one hours after she was centrifuged or thirty-three and one-half hours after the first lot were deposited. No effects of centrifugal force could be discovered in sections of these eggs. Normal larvæ hatched from those eggs which were not preserved.

Series L.D. *o*

A third batch of eggs were laid by the beetle of L.D. *f* at 1 p.m. July 20. The preserved eggs showed no effects of centrifugal force; the others hatched in six days.

Series L. D. *q*

A fourth lot of eggs were laid by the same beetle as in L.D. *f* on July 22. These agreed in every respect with those described in Series L.D. *m*.

IX REVIEW OF THE EFFECTS OF CENTRIFUGAL FORCE UPON
DEVELOPING EGGS

I Distribution of the Egg Contents

The most noticeable result obtained by centrifugal force is the redistribution of the materials contained in the egg because of the differences in their specific gravities. A number of cases have been reported of eggs whose contents are normally visibly different and localized in particular regions. For example, Boveri ('01, *a*, p. 145, Fig. 1, and '01, *b*, Taf. 48 and 49, Figs. 6-22) found three horizontal zones present in both unfertilized and fertilized eggs of *Strongylocentrotus lividus*. These zones could still be recognized in young blastulæ. Wilson ('04, p. 68) states that, "The Dentalium egg shows from the beginning three horizontal zones, an equatorial pigment-zone and two white polar areas. Each of the

polar areas includes a specially modified protoplasmic area probably comparable to a polar ring." Conklin ('05, *a*, p. 211) says of the Ascidian egg (*Cynthia*): "All the principal organs of the larva in their definite positions and proportions are here marked out in the 2-cell stage by distinct kinds of protoplasm," and again on p. 216 this author states that "the substances of the ectoderm, mesoderm and endoderm are recognizable in the unsegmented egg." In another place (Conklin '05, *b*, p. 220) we find the statement that, "Three of these substances are clearly distinguishable in the ovarian egg and I do not doubt that even at this stage they are differentiated for particular ends."

Many other eggs that do not exhibit a normal stratification and are apparently homogeneous throughout take on a zone-like appearance under the influence of a strong centrifugal force. Morgan ('06) found that when the unsegmented eggs of *Rana sylvatica* are revolved 1600 times per minute for seven minutes the pigment and yolk are driven to the top of the egg, leaving a clear polar field. Similar results were obtained in toads' eggs in three minutes. Lyon ('06, '07) was able to induce four layers in the egg of the sea-urchin, *Arbacia*. Two layers were obtained in eggs of the starfish, *Asterias* (Lyon, '07). The annelid, *Chætopterus*, exhibited three layers. The same author also centrifuged the eggs of the Ascidian, *Cynthia*, the Gephyrean, *Phascolosoma*, and the common garden spider; the eggs of *Cynthia* and *Phascolosoma* were stratified into three layers, those of the spider into two. Lillie ('06) found that not only in the unsegmented eggs of *Chætopterus* but also in the two, four and eight celled stages three zones appeared in each cell when placed under the influence of centrifugal force. The contents of the egg of the mollusk, *Cumingia*, may be separated into three zones (Morgan, '08).

The eggs of the rotifer *Hydatina senta* were centrifuged by Whitney ('09) while still within the mother. Three distinct layers resulted: a pink zone, a clear middle zone and a gray zone.

The eggs of *Calligrapha bigsbyana* are when laid of a nearly uniform pale-yellow color. When subjected to a strong centrifugal force for a sufficient length of time three zones are distin-

guishable: (1) a bright-orange light zone at the inner end (the vesicular zone, Fig. 20, *v. z.*), (2) a comparatively large central mass composed of yolk globules which are largest at the outer heavy end, gradually becoming smaller until indistinguishable from cytoplasm at the inner end, and (3) a colorless layer (the gray cap, Fig. 20, *g. c.*) at the extreme heavy end. These three zones are produced when the eggs are oriented either with their posterior (C.B. 4, *e.*) or their anterior (C.B. 3, *b.*) ends toward the axis of rotation. When placed with their sides toward the center only two layers are induced, the vesicular zone and the yolk zone. Three layers may be obtained in fresh eggs (C.B. 4, *e.*) in eggs which have reached a late cleavage stage (C.B. 2, *b.*, Fig. 18) and in eggs which are covered by a blastoderm (C.B. 5, *a.*, Fig. 19).

The gray cap. The material of the gray cap is the heaviest of the egg contents. It is composed of very fine granules whose positions before being driven to the heavy end of the eggs could not be determined. A fresh egg when centrifuged for one hour does not exhibit this layer (C.B. 4, *d.*, Fig. 10). At the end of two hours, however, a distinct gray cap is present (C.B. 4, *e.*). Eggs in late cleavage stages require a lesser amount of centrifugal force in order to produce this structure (C.B. 2, *b.*, Fig. 18). We conclude from this that either the gray cap material is liberated during development and the egg fourteen hours old (C.B. 2, *b.*) contains a greater quantity of it, or else some condition of the yolk mass at this age allows it to pass more rapidly toward the heavier end. Longitudinal sections through egg C.B. 2, *c.* (Fig. 7) show that although the embryo has developed normally the material of the gray cap is still at the heavy end where it was driven by the centrifugal force. A like condition also exists in a slightly younger egg (C.B. 5, *c.*). It is evident that the gray cap substance is not necessary for the normal development of the embryo.

The vesicular zone. The light fats which probably produce the vesicular zone at the inner end of the egg collect very quickly under the influence of centrifugal force. An egg centrifuged for only fifteen minutes (C.B. 4, *b.*) has a small number of vesicular spaces near the pole-disc. Continued application of centrifugal force results in a greater number of these vesicles until at the end of

one hour a very distinct zone may be recognized (C.B. 4, *d*, Fig. 10). The surface of the egg in this region is in every case wrinkled and folded as though the volume had decreased at this end and the firm layer of "Keimhautblastem" had become pulled in (C.B. 4, *d*, Fig. 10; C.B. 4, *f*, Fig. 13; C.B. 10, *c*, Fig. 14; C.B. 5, *a*, Fig. 19). This may, however, be due to poor fixation, as these folds are not visible in the eggs before they are killed.

The vesicular zone is present as such for some time after the eggs are taken from the centrifugal machine. It is not visible in sections through eggs C.B. 2, *c*, and C.B. 5, *c*, which carry normal embryos, but is present in C.B. 9, *d* (Fig. 16), which has produced a shapeless mass of tissue at the inner (anterior) end. This would indicate that the material of which this region is composed is required for normal development. However, I do not believe that this is established by the few cases observed.

The yolk zone. A very slight amount of centrifugal force is necessary to cause a noticeable disturbance in the large central yolk mass. The largest yolk spheres, as shown in C.B. 4, *b*, are thrown to the outer heavy end within fifteen minutes after the egg is centrifuged. A more marked distribution of yolk globules results from a longer application of centrifugal force. A redistribution takes place very quickly after the eggs are removed from the machine; this is shown distinctly in sections through eggs C.B. 2, *c*, and C.B. 5, *c*. No redistribution took place in eggs revolved at a slow rate of speed for a long period; the yolk remained at the heavy end in these cases and the embryos, failing to grow around it, became dwarfed as shown in Figs. 21, 22 and 23. The yolk has been shown to be the densest substance in the eggs of other animals; for example, in the frog's egg the white yolk is the heaviest material, as Born ('85) proved by sectioning those that had been rotated.

The cytoplasm. The peripheral layer of cytoplasm is lighter than the gray cap material or the yolk; continued application of centrifugal force causes it to rise to the inner end of the egg (C.B. 4, *d*, Fig. 10), where it becomes part of the vesicular zone. The cytoplasm filling the interdeutoplasmic spaces also accumulates in this region.

The cytoplasm of the beetle's egg is not made incapable of development by centrifugal force, since an embryo may be produced after a profound change in its arrangement. Gurwitsch ('04, '05) concludes, from his experiments upon the eggs of amphibians and echinoderms, that no vital structure of the cytoplasm is destroyed by the forcible passage of yolk granules through it. Morgan's conclusions from his experiments with the eggs of *Rana palustris* are, on the contrary ('02, p. 306), that "The most important effect, however, of a strong centrifugal force is the direct injury to the protoplasm of the lower hemisphere of the egg."

The nuclei. In C.B. 4, *d* (Fig. 10) one nucleus was found near the inner end of the egg. The nuclei of eggs which are in late cleavage stages rise toward the lighter pole (compare Figs. 17 and 18). In later stages the nuclei of the blastoderm are not affected, but the vitellophags move through the yolk toward the inner end. In every case the nucleus with its amœboid accumulation of cytoplasm moves as a whole, the nucleus remaining approximately in the center of the cytoplasmic mass. Lyon ('06) found that the nucleus in the egg of the sea-urchin, *Arbacia*, is less dense than most of the other constituents. In centrifuged eggs of *Asterias* and *Phascolosoma* the nucleus is next to the lightest substance (Lyon '07); this is also the case in *Hydatina senta* (Whitney '09, p. 135). In *Paramecium caudatum* the nucleus is heavier than the endosarc and is driven to the outer end by the centrifugal force (McClendon '08). Similarly Andrews ('03) has found that in seeds the nucleus is always of higher specific gravity than the cytoplasm, cell sap and oil drops.

When the membrane dissolves the nuclear sap escapes, leaving the heavier chromatin behind. Thus we find that the spindle does not rise toward the lighter end of the egg. Lillie ('06, p. 179) found in *Chætopterus* that the maturation figure is not moved by centrifugal force, but is usually fixed at the periphery. Sometimes, however, it was torn loose (p. 184), when it moves as a whole, the chromosomes and spindle never being separated by the centrifugal force. The same is true of *Hydatina senta* (Whitney '09, p. 155). Morgan ('08, p. 446) makes the following statement after a study of the effects of centrifugal force upon the eggs

of the mollusk, Cumingia: "In general, a resting nucleus may be forced to the lighter pole of the cell owing to the presence in the nucleus of nuclear sap, but the chromosomes and the spindle are more difficult to move, since they have nearly the same specific gravity as cytoplasm. When they move they do so as a whole, which shows that the spindle figure when present is a definite structure."

It is seldom that mitotic figures are found in sections of beetles' eggs and none was present in any of the many centrifuged eggs that I have examined. The nucleoli of the centrifuged eggs of Chrysomelid beetles seemed not to be affected, but were found in all parts of the nuclei irrespective of the direction of the centrifugal force. The nucleolus is heavier than the nuclear sap in the ova of the lobster. Its eccentric position was noted by Bumpus ('91, p. 225); later Herrick ('95, p. 155) proved that it falls to the lower side of the nucleus "like a shot within a tennis ball." Lyon ('07, p. 168) reports that the germinal vesicle is forced to the light end when unmaturing eggs of *Asterias* are centrifuged, but that the nucleolus is heavier.

The germ-cell determinants. Figs. 11, 12 and 13 are from longitudinal sections through the posterior ends of eggs which had been centrifuged one hour, two hours and four hours respectively. They show that the pole-disc moves *en masse* toward the heavy end of the egg and that it carries with it the "Keimhautblastem" in which it is suspended. In Fig. 11 there is a slight indentation in the surface at the posterior end; in Fig. 12 the pole-disc has penetrated farther into the yolk, leaving an open pathway (*pt*) behind it. This pathway is really unbroken, but appears cut across in the figure. A third stage is shown in Fig. 13, where the pathway has become closed and the group of germ-cell determinants is on its way toward the anterior pole. The eggs (Series C.B. 4) were oriented with their posterior ends toward the axis of rotation. No definite conclusion could be reached concerning the comparative specific gravity of the pole-disc, but a section through an egg centrifuged with its anterior end toward the center (C.B. 3, *b*) leaves little doubt that it lies between that of the gray cap and the yolk. The fact that the pole-disc moves as a whole,

likewise the vitellophags, seems to show that, contrary to what Lillie ('09) finds to be the case in annelid eggs, there is here good evidence of mass movements of protoplasmic areas.

2 *The Restitution of the Egg Substances After Centrifuging*

The results obtained by several investigators from experiments with centrifugal force upon the eggs of a number of species of animals seem to prove that, as Conklin has recently stated ('08, p. 94), "when different substances of the egg are displaced by strong centrifuging they tend to come back to their normal positions unless prevented by partition walls which have formed in the mean time."

Morgan ('06) found that the pigment of the toad's egg does not return to its original position after the removal of the egg from the centrifugal machine. In *Arbacia* if the centrifuged eggs are left unfertilized readjustment begins and the eggs appear nearly normal after several hours (Lyon '07, p. 163). In fertilized eggs of *Arbacia*, Morgan and Lyon ('07, p. 157) claim that the materials displaced by centrifugal force do not become rearranged to any extent before cleavage begins. In *Cumingia* the induced distribution of the egg contents is to a large extent retained (Morgan '08). Very little redistribution of the egg materials takes place before the first cleavage in *Hydatina senta* (Whitney '09, p. 135). The nuclei of *Paramecium caudatum*, as reported by McClendon ('08), slowly regain their normal positions after removal from the centrifugal machine; in some cases this took several generations. Andrews ('03) states that the contents of centrifuged seeds gradually return to their original arrangement, but if kept dry this process may take several months.

There are no cell walls in the eggs of beetles when in the process of cleavage to hinder the rearrangement of materials that have been driven out of their normal positions by centrifugal force. Nevertheless readjustment takes place very slowly if at all. The yolk globules which are the first to become displaced are also the first to redistribute themselves, and we find them occupying their usual positions twenty-seven hours after the end of the experiment (C.B. 5, c). The substance of the gray cap does not become rearranged. The vesicular zone in some cases disappears in a

short time (C.B. 5, *c*, and C.B. 2, *c*); in other cases it is still present after sixty-five hours (C.B. 9, *d*, Fig. 16). The cytoplasm undergoes a partial restitution, but in those cases where most of it has accumulated in the inner region the embryo is formed at this place (Figs. 16, 21, 22 and 23).

3 *The Age of the Egg when Centrifuged*

The general statement may be made that the older the egg the more chances there are of its normal development after centrifuging. Morgan ('02, p. 265) states that the eggs of frogs "which have divided once or twice will withstand a greater rate of revolution than those that have not divided. Moreover, eggs that have segmented a number of times, so that the content is divided by cell walls, will develop normally at rates of revolution that kill or produce abnormalities in unsegmented eggs, or eggs just beginning to segment." The age of the egg also determines to a certain extent the amount of stratification. In the eggs of *Chaetopterus* (Lillie '06, p. 184) the stratification is not so pronounced before the breaking down of the germinal vesicle and there is no gray cap formed. Lyon ('07, p. 168) could not distinguish any layers in unmaturing eggs of *Asterias*.

The beetle's egg becomes stratified more quickly if centrifuged when in a late cleavage stage than when fresh (compare C.B. 4, *d*, Fig. 10, and C.B. 2, *b*, Fig. 18). Eggs that have reached the blastoderm stage are more difficult to influence (C.B. 5, *a*, Fig. 19). The experiments described in this paper show that eggs in the blastoderm stage or older almost always produce normal embryos and some times larvæ (C.B. 2, *c*; C.B. 2, *d*; C.B. 5, *c*; C.B. 5, *d*; C.L. *h*, 3; C.L. *s*, 2; C.L.k. 2; L.D.k. 5; L.D. *n*, 6; L.D. *n*, 7).

4 *The Rate of Development*

The effect of agitation upon the rate of development is not certain because in several of the experiments reported the temperature was not carefully regulated. Meltzer ('03, p. 250) states that the eggs of the sea-urchin, *Arbacia*, develop into an advanced cleavage stage more quickly than normally if they are violently

shaken. Some experiments by Morgan ('04, p. 96) upon the toad's egg seem to show that agitation hastens the development. Whitney ('06, p. 47) finds that "mechanical shocks and vibrations are not effective in accelerating the early segmentation of the fertilized eggs of *Arbacia*, *Asterias*, *Fundulus* and *Ctenolabrus*." The development of the eggs of *Hydrophilus aterrimus* is retarded if their position is reversed with respect to gravity (Megušar '07). The sea-urchin egg develops more slowly than is normal after being centrifuged; this is probably due to the resistance to cleavage offered by the cap and pigment (Lyon '07, p. 166). McClendon ('08) found the rate of division of centrifuged *Paramecia* to be greater than that of normal animals. When seeds are centrifuged and restitution is slow the growth is retarded (Andrews '03).

Centrifugal force seems to have no influence upon the rate of development of those beetles' eggs that produced normal embryos and larvæ. A large number of observations give the average period for the development of the eggs of *C. multipunctata*, *C. bigysbyana* and *C. lunata* as five and two-thirds days (Hegner '08, a). In a great many cases normal eggs do not hatch under six and one-half days. Practically all of the centrifuged beetles' eggs hatched in six days.

5 *Eggs Centrifuged Before Deposition*

In the majority of cases the eggs laid by centrifuged beetles show no rearrangement of material and the production of an embryo or larva is not impeded. The exceptions to this are the eggs described as Series C.B. 12; here two abnormal embryos were produced by eggs which had been centrifuged within the mother before the germinal vesicles had broken down. No definite cause can be given for this irregularity.

X SUMMARY

1 Eggs of Chrysomelid beetles when oriented in a centrifugal machine with either their posterior or anterior ends toward the axis of rotation, and subjected to 1500-2000 revolutions per minute for from one to twelve hours, become stratified into three layers: (1) a light vesicular zone at the inner end, (2) a heavy granular

gray cap at the outer end, and (3) a comparatively large intermediate mass of yolk, the larger globules lying at the outer end of this layer.

2 The gray cap is induced by a lesser amount of centrifugal force in an egg containing many cleavage nuclei than in a fresh egg. Either the gray cap material is liberated during development or else some condition of the yolk mass in the older egg allows it to pass more rapidly toward the heavier end. The gray cap material is not necessary for the normal development of the embryo.

3 The vesicular zone becomes visible after fifteen minutes of centrifuging. It is composed of fat imbedded in cytoplasm. This zone disappears during development.

4 The yolk globules are distributed throughout the intermediate region of the egg; the largest spheres are at the outer heavy end. It takes very little centrifugal force to cause this rearrangement. Restitution to the normal condition takes place soon after the egg is removed from the centrifugal machine.

5 The cytoplasm is lighter than the gray cap material or the yolk, but heavier than the fat of the vesicular zone. The passage of the cytoplasm to the light end of the egg does not incapacitate it for the production of an embryo.

6 The nuclei are apparently equal in specific gravity to the cytoplasm. Cleavage nuclei and vitellophags rise to the inner end of the egg; the nuclei of the blastoderm of older eggs are not visibly influenced by centrifugal force.

7 The germ-cell determinants move *en masse* from their usual position at the posterior end toward the anterior end when the former is placed inward. The further history of these granules has not been traced.

8 Restitution takes place very slowly. Those substances easily displaced are also the first to redistribute themselves. The cytoplasm seldom regains its normal position, but produces a dwarf embryo outside of the yolk at the light end of the egg.

9 The age of the egg determines the susceptibility to centrifugal force and the future growth of the embryo. In general an egg in a late cleavage stage becomes stratified sooner than a

fresh egg. Eggs centrifuged when in the blastoderm stage or older almost always produce normal embryos and sometimes larvæ.

10 Centrifugal force has no influence upon the rate of development of eggs which produce normal embryos or larvæ.

11 The orientation of the embryos produced by centrifuged eggs is not affected by centrifugal force. Dwarf embryos, however, are frequently formed at the posterior ends of the eggs; these never produce larvæ.

12 In the majority of cases the eggs laid by centrifuged beetles produce normal larvæ.

13 The eggs of insects, although supposed by many embryologists to be the most highly organized of any animal eggs, may have their contents profoundly disturbed without preventing the production of a normal embryo. The cytoplasm and nuclei of centrifuged eggs are forced out of their usual positions, but often normal development takes place. This would indicate that a high degree of organization does not prevent the egg from adapting itself to changed conditions.

The University of Michigan.

February 19, 1909.

LITERATURE

- ANDREWS, F. M. '03—Die Wirkung der Centrifugalkraft auf Pflanzen. *Jahrb. wiss. Bot.*, Bd. 38.
- BORN, E. '85—Biologische Untersuchungen. I. Ueber den Einfluss der Schwere auf das Froschei. *Arch. f. mikr. Anat.*, Bd. 24.
- BOVERI, TH. '01, *a*—Ueber die Polarität des Seeigeleies. *Verh. der Phys. Med. Ges. zu Würzburg, N. F.*, Bd. 34.
- '01, *b*—Die Polarität von Ovocyte, Ei und Larve des *Strongylocentrotus lividus*. *Zool. Jahrb. Abth. f. Anat. u. Ontog.*, Bd. 14, Heft 4.
- BUMPUS, H. C. '91—The Embryology of the American Lobster. *Journ. of Morph.*, vol. 5.
- CONKLIN, E. G. '05 *a*—Organ-forming Substances in the Eggs of Ascidians. *Biol. Bull.*, vol. 8.
- '05 *b*—Mosaic Development in Ascidian Eggs. *Journ. Exp. Zoöl.*, vol. 2.
- '08—The Mechanism of Heredity. *Science, N. S.*, vol. 27.

- GURWITSCH, A., '04—Zerstörbarkeit und Restitutionsfähigkeit des Protoplasmas des Amphibieneies. *Anat. Anz. Ergänzungsheft z.*, Bd. 25.
- '05—Ueber die Zerstörbarkeit des Protoplasmas im Echinodermenei. *Anat. Anz.*, Bd. 27.
- HALLEZ, P. '86—Loi de l'orientation de l'embryon chez les insectes. *Compt. rend.*, tome 103.
- HEGNER, R. W. '08, *a*—Observations on the Breeding Habits of Three Chrysomelid Beetles, *Calligrapha bigsbyana*, *C. multipunctata* and *C. lunata*. *Psyche*, vol. 15.
- '08, *b*—The Effects of Removing the Germ-Cell Determinants from the Eggs of Some Chrysomelid Beetles. *Biol. Bull.*, vol. 16.
- HERRICK, F. H. '95—The American Lobster: a Study of its Habits and Development. *Bull. U. S. Fish. Com.*
- LILLIE, F. R. '06—Observations and Experiments Concerning the Elementary Phenomena of Embryonic Development in *Chætopterus*. *Journ. Exp. Zööl.*, vol. 3.
- '09—Polarity and Bilaterality of the Annelid Egg. Experiments with Centrifugal Force. *Biol. Bull.*, vol. 16.
- LYON, E. P. '06—Some Results of Centrifugalizing the Eggs of *Arbacia*. *Am. Journ. Physiol.*, vol. 15.
- '07—Results of Centrifugalizing Eggs. I. The Specific Gravity of Eggs and the Changes in Specific Gravity Occurring During Development. II. Effects of Centrifugalizing Unfertilized Eggs on their Development. *Arch. Entw'm.*, Bd. 23.
- MCCLENDON, J. F. '08—The Effects of Prolonged Centrifugal Force on *Paramecium*. *Am. Journ. Physiol.*, vol. 21.
- MEGUŠAR, F. '06—Einfluss abnormaler Gravitationswirkung auf die Embryonalentwicklung bei *Hydrophilus aterrimus* Eschscholtz. *Arch. Entw'm.*, Bd. 22.
- MELTZER, S. J. '03—Some Observations on the Effects of Agitation upon *Arbacia* Eggs. *Am. Journ. Physiol.*, vol. 9.
- MORGAN, T. H.—'02 The Relation between Normal and Abnormal Development of the Embryo of the Frog as Determined by Injury to the Yolk Portion of the Egg. *Arch. Entw'm.*, Bd. 15.
- '04—The Dispensability of the Constant Action of Gravity and of a Centrifugal Force in the Development of the Toad's Egg. *Anat. Anz.*, Bd. 25.
- '06—The Influence of a Strong Centrifugal Force on the Frog's Egg. *Arch. Entw'm.*, Bd. 22.
- '08—The Effects of Centrifuging the Eggs of the Mollusc *Cumingia*. *Science, N. S.*, vol. 27, pp. 66-67 and 446.

- WHEELER, W. M. '89—The Embryology of *Blatta germanica* and *Doryphora decemlineata*. *Journ. of Morph.*, vol. 3.
- WHITNEY, D. D. '06—An Examination of the Effects of Mechanical Shocks and Vibrations upon the Rate of Development of Fertilized Eggs. *Journ. Exp. Zoöl.*, vol. 3.
- '09—The Effects of a Centrifugal Force upon the Development and Sex of Parthenogenetic Eggs of *Hydatina senta*. *Journ. Exp. Zoöl.*, vol. 6.
- WILSON, E. B. '04—Experimental Studies in Germinal Localization. I. The Germ-Regions in the Egg of *Dentalium*. *Journ. Exp. Zoöl.*, vol. I.

CONTRIBUTIONS TO EXPERIMENTAL ENTOMOLOGY¹

I. JUNONIA CÆNIA HÜBNER

BY

WILLIAM REIFF

Towards the end of September I received, through the kindness of Mr. Jacob Doll, of Brooklyn, N. Y., a considerable number of caterpillars of *Junonia cœnia* Hübner which had been found near Brooklyn in a portion of Long Island that is rather damp and overgrown with bushes and low plants. Here the butterflies had been rather abundant one or two months previously. Mr. Doll assures me that the frequency of *J. cœnia* in this region is not at all the rule. Although the butterflies are never completely absent in any year, there are usually only a few caterpillars to be found. *J. cœnia* in the northern states belongs, therefore, to the category of butterflies that appear in great numbers only during certain years. It is, moreover, probable that the abundance of this form is due to migration from the south, and that this migration to the north would be the stronger the dryer and hotter the season. The summer of 1908 would seem to justify this supposition.

The caterpillars, which, as I have said, were present in numbers, fed on *Gerardia purpurea* L., which is cited as their favorite food-plant by Scudder in his work on "The Butterflies of New England." As I could obtain no material of *Gerardia*, I gave them *Linaria linaria* Karst, *Plantago media* L., and *Plantago major* L. *Plantago media* was not eaten at all; *Linaria linaria* only unwillingly, but *Plantago major* with evident relish.

A considerable portion of the material unfortunately died of flacherie (flaccidenza). As soon as I recognized the disease I, of

¹Contributions from the Entomological Laboratory of the Bussey Institution, Harvard University, No. 1.

course, isolated the apparently healthy animals, but too many of them had already contracted the disease. The first symptom of flacherie appeared as a complete apathy, both in feeding and in movement. Later the animals crept slowly up the walls of the breeding cage and remained motionless under the lid, where they died in the course of a couple of days. As a rule, one pair of prolegs was fastened to the gauze of the wall, while the anterior and posterior portion of the caterpillar hung down on the right and left side. The dead caterpillar at once decomposed, and often dropped into several pieces at the least touch.

The caterpillars were reared at out-of-door temperature. Pupation began the sixth of October. The time of pupation, that is, the time which elapses between the attachment of the caterpillar and the completed pupa, differs according to the prevailing temperature. At 23° C. pupation took place in from 10 to 12 hours; 18° C. caused the caterpillars to pupate in 17 hours; 9° C. in about 48 hours; 6° C. in 60 hours, and below $+4^{\circ}$ C. pupation did not take place at all. The caterpillars, which I subjected for a long time (up to 8 days) uninterruptedly to a lower temperature, varying between 0° and $+3^{\circ}$ C., died, no matter in what stage they happened to be. I used for this purpose caterpillars of all ages: animals that had not yet completed their second moult, up to those which had all attached themselves for pupation.

In the original locality Mr. Doll had found caterpillars of all sizes as late as the end of October. Indeed, there were even some freshly hatched butterflies, together with flown specimens of the preceding generation. In his letter to me he suggested the question as to whether the caterpillars might not hibernate, since it was obviously impossible for the majority of them to pupate during this same year, as the food-plant was mostly frozen and the temperature was becoming lower from day to day. I am now of the opinion, after the above experiments, that *J. cœnia* never passes the winter in the northern states as a caterpillar, but that all caterpillars die as soon as the temperature sinks to $+3^{\circ}$ C. for several days. The pupa is not quite so sensitive to continued cold as the caterpillar, but still to a considerable degree. All the pupæ which I exposed to a constant low temperature (-5° C. or

below), for more than forty-eight hours, died.² Still, very pronounced cold, for example -15° C., never injured the pupæ if they were exposed to it only about an hour, even when the experiment was repeated as often as three times daily for several successive days. Hence, *J. cœnia* could not hibernate in the northern states even as a pupa since a constant temperature of -5° C. or below for several days is by no means rare in winter.

Through the influence of cold the pupa takes on a very dark ground color, while the white punctate markings increase in distinctness and also in size. If one exposes pupæ to higher temperatures ($+38^{\circ}$ C. and above) all the colors pass over into a light red in which one sees small black dots. In both cases the newly acquired color persists till the butterfly hatches.

If caterpillars attacked by flacherie still have the strength to pupate, the progress of the disease becomes apparent in the color of the pupa, which is a uniform blue-black. The decomposition process is like that of the caterpillars. Just as caterpillars of all ages may die of flacherie, the period at which it occurs in the pupa also differs with different individuals. I had, for example, a pupa which died about six hours before it should have hatched as a butterfly. The head, thorax and legs were completely developed, the marking of the wings was almost perfect, but the body was decomposed. In this case, therefore, only the body of the animal was affected with the disease, and this, for some peculiar reason, had not spread to all parts of the pupa. But that the disease always first makes its appearance in the abdomen was shown by the reddish pupæ obtained from experiments with high temperatures. When these had flacherie the progress of the disease from the tip of the abdomen to the head could be accurately followed in the increasing change of color.

All the pupæ used in the experiments and the control were kept in the room at a temperature of about 22° C. and care was taken to provide the necessary amount of moisture in the receptacles containing them. All the butterflies hatched after being kept in the room from ten to thirteen days, both the control pupæ and the

²In all experiments I used pupæ that were 10 to 12 hours old. Perfectly fresh pupæ, with their chitinous investment still soft, died within 12 hours at -2° C.

pupæ that had been treated experimentally with cold or heat. I must call attention to the fact, however, that only experiments with *intermittent* temperatures were undertaken, and that subjection to the excessive temperatures never extended beyond three days. No experiments were made with high *constant* temperatures, while the experiments with lower temperatures gave no butterflies when I subjected them to a cold of -3° C. for seven days. The hatching of the butterflies usually took place about noon between 11 and 2 o'clock, and, moreover, only when the weather outside was fine. Although the pupæ were kept in a warm room, not a single butterfly hatched when the barometer was low.

I come now to an account of the color peculiarities of the butterflies hatching from pupæ exposed to different temperatures.

EXPERIMENTS WITH HIGH TEMPERATURES

An incubator was used for this purpose and accurate regulation of the heat was accomplished by means of a thermostat. Care was taken to keep the air in the apparatus moist.

All the pupæ which I exposed to a temperature of 45° C. for more than two hours, or such as were exposed to 44° C. for more than five hours, died. Of all the pupæ which remained in the apparatus five hours at 43° C., only one later produced a butterfly, but this was a complete cripple. All the pupæ endured very well for several hours a temperature of from 40° to 42° C. My method was to expose the pupæ on the first day to a temperature of 40° C. for four hours, the second day to 41° C. for five hours, and on the third day to 42° C. for four hours.

All the butterflies which I obtained from these heat experiments differ from the normal form by their sharper and more vivid coloration. The otherwise chocolate-brown ground color of the wings is more blackish, so that both the white and red markings stand out more strongly. In some individuals the white cross-band on the anterior wings is somewhat broadened. The orange-colored band between the margin and the eye-spots of the hind wing is more luminous, broader and crosses not only the hind wing, but also sometimes shows itself in the form of an uninterrupted pro-

longation to the tip of the anterior wing. The eye-spot markings of the hind-wing remain rather constant, while the eye-spots of the anterior-wing vary more or less. With the enlargement of the white apical spot there is a correlated great accentuation of the small eye-spot lying immediately behind it. The ring of the second and larger eye-spot further back was in some cases suffused with black scales. It often happens that the elements of a new pattern are added; thus, for example, one cannot overlook the tendency to add to the row of eye-spots already existing other markings of the same kind. Moreover, black dots, which are often surrounded by a feeble ring, make their appearance. The lower surface of the hind-wings is, without exception, deep reddish-brown and has a scarcely recognizable pattern. This coloration is not, however, the result of higher temperatures, for it is present in all of the individuals taken in late autumn in the northern states, as I have been able to ascertain by an examination of a large amount of material which Mr. Doll kindly permitted me to study. Specimens from the more southerly range of the species have a much lighter lower surface.

EXPERIMENTS WITH LOWER TEMPERATURES

For producing lower temperatures I used a mixture of pounded ice and cooking salt, and the experiments with intermittent temperatures consisted in subjecting the pupæ three times daily for periods of two hours to a low temperature which, in most cases, was for the first day -7° C., for the second day -8° C., and for the third day -9° C. In the intervals the pupæ were left at $+6^{\circ}$ C., and after the last exposure were taken into the room temperature.

All the healthy pupæ produced butterflies which in the coloration and marking are a complete contrast to those which I have described in the foregoing paragraphs. In these specimens, too, the ground color of the wings is dark, but this deepening of color extends over all the elements of the pattern. The white cross band of the anterior wings is evanescent so that it is represented only by a distinct, light-colored cloud. The orange-colored band,

which runs parallel with the outer margin, is almost completely supplanted by the dark ground color of the posterior wings, and is no longer to be detected in the anterior wings. The small white apical spot is very variable. Although it has all disappeared in rather light-colored specimens, it continues to remain more distinctly visible in dark specimens. All the eye-spots are diminished in size through the effects of cold. Instead of there being new adventitious markings, the markings already existing have begun to disappear. The most posterior eye-spot of the hind wings often consists only of a tiny dot, while the remaining eye-spots towards the outer margin lose their rings, and the ground color, therefore, goes over into the inner marking. The two red spots towards the anterior border of the fore-wing are least influenced by these changes. The inferior surface of the anterior wings corresponds to that of the upper surface. That of the hind wings is uniform silver gray, with a pale brownish tint and a scarcely perceptible pattern.

WHAT CONCLUSIONS MAY BE DRAWN FROM THESE EXPERIMENTS ?

We may assume as established beyond question that the genus *Junonia* had its origin in the tropical zone, where even today most of the species of the genus are to be found, and whence the species migrated and spread in the direction of the two poles till a limit was set to their expansion by the coming of the glacial period. The more the northern regions were covered with ice, the more *Junonia* had to retreat to the south. The conditions in the subtropical zone, in which the genus was able to spread in all directions without meeting with any obstacle, were different. After the glacial period, and hence not so very long ago, a gradual northward migration again began.

There are species of *Junonia* in the tropics both of the old world and the new world, but they are to be found in the north temperate zone only in North America, where the north is not separate from the south by mountain ranges, although it has been shown that North America passed through a longer glacial period than Europe (J. Hann, *Handbuch der Klimatologie*, Stuttgart,

1883). The species of *Junonia* differ, therefore, from those of the very closely related, ubiquitous genus *Pyrameis* Hb., which, according to Standfuss (*Handbuch der palæarkt. Gross-schmetterlinge*, Jena, 1896), also had their origin in the tropics. Generally speaking, however, the species of *Junonia* are less adaptable than those of *Pyrameis*.

The only northern representative of the genus *Junonia* is a member of the *cœnia* group, and I believe that this species had already developed as an independent form before the glacial period, while it was advancing towards the north, and had at least become sufficiently stable to remain as a species after it had been pushed back to the south. When later the road to the north was again open, it was all the easier for this species to follow the path of its ancestors and take possession of the region which the preceding generations had to leave on the approach of the ice age.

If we now glance at the species of *Junonia* which are exclusively peculiar to the tropical fauna of America, we are surprised to find that no single species of the group is at all as brilliantly colored as *cœnia*. All of them have a rather dull coloration and fewer or at any rate smaller eye-spots. The most nearly allied form from which *cœnia* could be supposed to have arisen, is *J. genoveva* Cramer. Jamaica seems to be the true home of this species, but it has already spread so far over South America that the northernmost limit of its range coincides in part with the southernmost limit of that of *J. cœnia*. Its pattern, which everywhere remains constant, except for the sporadic appearance of slight differences in shade of color, proves that *genoveva* is phylogenetically a very old form. That *genoveva* and *cœnia* are to be regarded as two decidedly *distinct* species and are not to be united in one species, as, for instance, Dyar has done in his "List of North American Butterflies" (Washington, 1902), is proved by the facts, first that there are no true transitions between the two species; second, that from none of the experiments with high temperatures did there result a butterfly which even approximated to the *genoveva* type. Nevertheless, at least a partial reversion to the primitive form should have taken place through high temperatures if *cœnia* were not a species that had been fixed for a long time, for, since the

tropics are the original home of its ancestors, atavism could be produced only through the influence of heat. I could obtain no reversional forms by this means, but, on the contrary, all the butterflies departed still further from the series of forms which we have been considering; hence, the supposition lies near at hand that in the north temperate zone *cœnia* has become so far detached from its original home that the species has already lost the ability, or has already become too old to produce atavistic forms. This would agree with the view which I have previously stated, that *cœnia* had already become a stable species in the nearctic fauna before the glacial period, and that it continued to exist further south as *cœnia* during this period, and then again took possession of the north after the expiration of the ice age without change in its coloration or markings. Another fact that lends support to this view is that the nearly related *Pyrameis atalanta* L., and *P. cardui* L., react much more decidedly to the influence of temperature, so that the phylogenetic age of these species must be much less than that of *J. cœnia*. Nor does the distribution of these species contradict this view, for *atalanta*, and especially *cardui*, belong to the best flyers among the butterflies.

If, therefore, the forms which one obtains through heat, and which are more or less decidedly modified in one direction, show no reversions, they must necessarily be regarded as *progressive* forms. It could be objected, perhaps, that heretofore in the experiments of European investigators, progressive forms, so far as heating the pupæ is concerned, have been produced by *constant* and only *moderately* high temperatures, but we must bear in mind that in the middle zone of the United States, where *J. cœnia* is most abundant, the temperature that prevails during by far the greater portion of the year is the one which was artificially produced in the European experiments. Hence I was, of course, obliged to expose the pupæ to a relatively higher temperature. The experiments of European investigators have shown, however, that in one and the same species, pupæ exposed for a certain time to moderate abnormal temperatures, may produce in a correspondingly shorter time the same varieties as are produced by employing high temperatures. If the heat forms that have been obtained

of *J. cœnia* are really to be regarded as progressive, no case of atavism should appear among them, but, on the contrary, new markings should make their appearance, such as have not been found heretofore in other *Junonia* species of this group. The absence of all reversion was considered above, and I have also, while describing my experiments, called attention to the appearance of new characters in the pattern. These differences in the markings consist mainly, to repeat once again, of the decidedly broader and more vividly colored, reddish orange band on the hind wings, in the appearance of the band in the anterior wings and the origin of new ocellate markings in the characteristic row of eye-spots. Through the kindness of Mr. Doll, of Brooklyn, I have been able to examine a large series of *Junonia* species, which were partially caught and partially bred under natural conditions. Now, among the many individuals of the *cœnia* group in this collection, there are a few which show very clearly the characters just mentioned. One specimen, in fact, has on its hind wings a completely normal, fully-developed, third eye-spot. I regard it, therefore, as highly probable that *J. cœnia* is even now in the process of changing in the direction indicated. This is suggested also by the rather frequent occurrence in nature of the difference in the breadth of the orange-yellow band of the hind wings, for if the progressive form were to be conceived as still to be initiated in the indefinite future, the characters described should not be found in nature and *cœnia* should be much more constant in its pattern in the southern portion of its range than it is.

But how are we to regard the cold forms that have been obtained experimentally? These could not be cases of atavism, since a reversion through the influence of cold would be impossible in a species whose original home is in the south. No doubt *J. cœnia* is in the act of adapting itself to cold. If, through my experiments, diametrically aberrant forms had arisen, there would be great difficulty in reaching a conclusion; but as only *one* direction of variation is observable, we can place all the specimens in a single common group, which has just the opposite coloration from that of the warm forms. The principal characters may be again reviewed; the general darkening of the upper surface of the wings,

the white and red scale formations are replaced more or less by black, eye-spots all smaller and tending to disappear, and the disappearance of the halo surrounding the eye-spot so that the center begins to shade over into the ground color. It is to be noted also that the two red spots on the anterior border of the anterior wing are scarcely changed in the slightest degree, either in these or in the experiments with warmth, and this must point to a great phylogenetic age for this portion of the markings which is so characteristic of the species of *Junonia*. If, however, as I have said, there is no atavism in these cold forms, we must regard the changed specimens as being without doubt progressive forms. It seems peculiar, and certainly it may be advanced as an objection, that one species of butterfly can have two prospective forms, which nevertheless, are in strongest contrast to each other. Let us examine this question more closely.

As I have stated before, *J. cœnia* will probably take on, in the not very distant future, a somewhat different coloration and pattern in the portions of North America which it has *continuously* inhabited. In these regions and because of the mild winters, there has been no obstacle to the survival of the species, but the conditions have been quite different in the northernmost portions of its range, for here *J. cœnia* can never become indigenous on account of the severe cold of winter unless the species acquires the habit of hibernating. As I have said in the beginning of this paper, caterpillars and pupæ of *cœnia* die at what would be a very slight fall of temperature for the northern winter. Hibernation of the eggs can hardly come into the question, for the last generation of our *Pyrameis* species, which, as I have several times remarked, are closely related to *Junonia*, does not pair till spring. Moreover, it is also known that butterflies pair, as a rule, only after having flown for a considerable period. For the generation of *cœnia* which hatches in its northern range from the end of October on, there would not be sufficient time to attain sexual maturity, but this insect does not, as a rule, hibernate in the north even as an imago. No doubt the last generation attempts this, but only a few specimens survive the winter. How could we otherwise understand that in spring the butterfly is a great rarity in

places where it was found in great numbers during the previous fall? A good parallel to this case is that of the *Pyrameis atalanta* L., and *P. cardui* L., of which Standfuss says verbally in his "Handbuch der palæarktischen Gross-schmetterlinge," Jena, 1896: "Although individuals of *atalanta* and *cardui* may be observed during high summer and fall as a rule in quite as great numbers and sometimes even greater numbers than the butterflies of *antiopa*, *polychloros*, *c-album*, *io*, and *urticæ*, these two species are in general very much more rarely seen in the spring than the series just mentioned. Only after very mild winters are *atalanta* and *cardui* found to occur frequently in spring. Our severe winters evidently kill off most of the individuals of these two species, which have not yet sufficiently acclimated themselves to such low temperatures, and are also much more rarely seen hibernating than the numerous species we have supposed to originate in northern latitudes. Although the second generation of *atalanta* and *cardui* is not exactly rare during most years, this is due to the extraordinary flying powers of these species, which continually push forward from milder into more inclement regions." (p. 302.)

We may, therefore, agree with the view which Scudder advances in his "Butterflies of New England," that hibernation is extremely rare in *J. cœnia* throughout its northern range. It would seem that, notwithstanding the much greater phylogenetic age of *cœnia* than of *atalanta* and *cardui*, it is much more difficult for the former species to accommodate itself to severe cold. But if *cœnia* is to take permanent possession of the northern portions of its range, and not be continually recruited in this range by specimens from the south, it *must* acquire the ability to hibernate. It seems probable that the imaginal insect is destined to do this, although it is not impossible that the pupa may acquire the ability, for, as I have stated at the beginning of my paper in connection with the data received from Mr. Doll, caterpillars of all sizes are found in the field till late in the fall, and this, of course, means also the presence of pupæ. If such pupæ should hibernate the butterflies arising from them would certainly not have the same color pattern as those whose whole development occurs during the warm sea-

son. We should expect, therefore, to see the two generations of *J. cœnia* taking on a seasonal dimorphism in their northern range, and the causes of this would be just the opposite of those which have operated in the production of the seasonal dimorphism of the European *Araschnia levana* L. Concerning the importance and origin of the seasonal dimorphism in this latter species, A. Weismann has given an extended and clear account in his "Studien zur Descendenz-Theorie," Leipzig, 1875.

I am, therefore, of the opinion that the *cœnia* which I obtained from experiments with cold, show the direction which the coloration and markings of the winter form will take in future time, if the pupa should acquire the ability to hibernate. That this time is still very far distant, is shown, for example, by Doll's collection of *cœnia*, which among its great riches, shows only one specimen that approximates to the cold forms.

If we now bring together what has been shown by the experiments with warmth and cold, we come to what is certainly the correct conclusion, that *J. cœnia* Hb. is about to produce a local form in its southern range, and that in its northern range it will bring forth a seasonal dimorphic species after a considerable period of time if the pupa, instead of the imago, should acquire the ability to hibernate.

A few words may be said about the melanistic form of *Junonia cœnia*, the *ab. negra* Felden. Through the kindness of Mr. Doll, of Brooklyn, and Mr. H. H. Newcomb, of Boston, I have been able to examine a fine series, together with transitions, of this aberration, which is known only from the southern and south-western range of the species. Its origin in nature is probably to be traced to extremely *dry* heat acting on the pupa, but this can only be decided by further experimentation. It is certain, however, that *negra* is not to be placed in the same group with the darker cold forms, since even in the most strongly melanistic specimens the eye-spots are still distinct and of normal size, whereas in the cold forms, even in light-colored specimens, there is always a diminution or incipient dissolution of these spots. Whether it would be right to regard the *ab. negra* as a partial reversion to *J. gonoveva*, I will not undertake to decide. Apart from the

small differences in the form of the wing and in the pattern of the upper surface, the lower surfaces of both series of individuals present such a strong contrast to the *ab. negra* that it would seem impossible to draw any conclusion without more extensive investigation.

In conclusion I would call attention to some aberrative specimens of *J. cœnia* which I raised from normally treated pupæ, which, however, had an abnormally strong depression in the wing cases. The eye-spots are all greatly enlarged, in part elongated and so large on the posterior wing that they come in contact with each other. Mr. Doll has in his collection several specimens that exhibit the same peculiarity, and were probably produced by the same causes. Another pupa, left under normal conditions, also, probably in consequence of some pressure to which it had been subjected during pupation, exhibited a slight but sharp depression in the right anterior wing case. The butterfly which hatched from this pupa showed an absence of scales in the corresponding region of the wing.

Experiments undertaken for the purpose of ascertaining the effect of sulphuric ether vapor on the developing coloration of the butterfly led to no result, as the pupæ died.

In conclusion I wish to express my gratitude to Mr. Jacob Doll, Mr. H. H. Newcomb and especially to Prof. W. M. Wheeler for their kind aid in my investigations.

II. TWO CASES OF ANABIOSIS IN *ACTIAS SELENE* HÜBNER

In his second volume of *Experimentelle entomologische Studien*, Sophia, 1907, Prof. P. Bachmetjew discusses on pp. 684-686 the anabiotic condition in insects. By means of calorimetric measurements on Lepidopterous pupæ he established the fact that the juices of the insect body do not completely congeal till they have been reduced to -4.5° C., but that at this temperature the insect does not yet die. Permanent cold rigor, or death, sets in, on the contrary, under very different conditions, as the author has shown in the first volume of the work to which I have referred.

If, now, the juices are congealed, Bachmetjew further states,

the insect is in a condition in which no metabolism can take place, for the circulation of the blood has then become impossible. An insect without metabolism cannot be regarded as being still alive, but nevertheless it is not dead, since it has not reached the point of permanent cold rigor. It is, therefore, in a transitional condition, a lifeless or anabiotic stage. To aid in the understanding of the conception of anabiosis Bachmetjew's explanation may be repeated in his own words: "The anabiotic condition is not one of lethargy, for in lethargy metabolism still takes place, although very slowly, till the insect finally dies of inanition. The condition under discussion can be better compared with that of a clock in which the pendulum has been intentionally stopped. Of course, the clock has not been injured, but it does not go. On pushing the pendulum the clock shows that it is still intact; and just as the clock with a motionless pendulum can remain uninjured for an indefinitely long period of time, so, presumably, an insect could remain for an indefinitely long time in the anabiotic condition without dying." (Vol. ii, p. 685.)

From some pupæ of *Actias selene* imported in November, 1908, for hybridization experiments during the coming summer, there hatched as early as the twentieth of November a female moth, which I left out-of-doors in a wire cage till November 22d inclusive. At this time the temperature for several days had been unusually high, and was undoubtedly responsible for the premature hatching of the insect. From the twenty-third of November on I subjected the moth to a continuously low temperature, varying from -3° C. to -6° C. Daily observation showed that the moth remained unchanged and motionless, with spread wings, on one of the walls of the wire cage, and that it responded to no external stimuli. It should be noted, however, that the stimuli were never sufficiently severe to injure the specimen. In order to ascertain whether it was still alive, I carried it over on the third of January, 1909, to the outside temperature, which was on that day about $+5^{\circ}$ C. Although the moth retained the same attitude as before, it nevertheless moved its antennæ and legs when it was stimulated, but the slight rise in temperature was not sufficient to cause it to move spontaneously, nor did January 4, with an average temperature

of about $+7^{\circ}$ C., produce any change. Only when the unusually warm fifth of January arrived, which had an average temperature of about 17° C., did the moth, of its own accord, move its antennæ, legs and wings and wander about languidly in its cage in the manner so often observed in the females of the allied Saturniids. On the evening of the fifth of January, I placed the insect in a moderately heated room in order that it might not be subjected to a sudden change of temperature that has been predicted by the Weather Bureau. On the following morning, however, it was dead. Contrary to my expectations, this female selene did not lay a single unfertilized egg during her whole life period. An examination of the very much swollen and unchanged abdomen, showed, however, that the ovaries were perfectly normal.

On the third of January, 1909, which was a mild day, there escaped from the *Actias selene* pupæ that had been left out-of-doors another specimen, which proved to be a male. This specimen was left till the fifth of January, inclusive, in a cage of its own out-of-doors, and was then treated from the sixth of January to the fourth of February inclusive, in the same manner as the former specimen. On the fifth of February, which had an average temperature of $+6^{\circ}$ C., I took the moth out of doors again, where it remained till the afternoon of the seventh of February, when it died. The temperature of the sixth of February averaged about $+13^{\circ}$ C., while the average for the seventh of February was about $+4^{\circ}$ C. With the single exception that in this second experiment the insect reacted more readily and in a more pronounced manner to the rise in temperature—the males of the allied Saturniids are always very lively—and even made attempts to fly about its cage on the warmest day (the sixth of February) the conditions coincided with those of the individual on which I first experimented.

Summarizing the results from the time of hatching of both moths we have the following table:

ACTIAS SELENE HUBNER	EX. LARVA ON	IN TEMPERATURE ABOVE 0° C.	IN ANABIOSIS - 3° TO - 6° C.	AGAIN IN TEMPERATURE ABOVE 0° C.	DEATH OCCURRED	TOTAL LENGTH OF LIFE INCLUDING ANABIOSIS (IN PARENTHESES).
♀	Nov. 20, 1908	Nov. 20-22, 1908 = 3 days	Nov. 23, 1908 to Jan. 2, 1909 = 41 days	Jan. 3-5, 1909 = 3 days	Jan. 6, 1909 a.m.	6 + (41) = 47 days
♂	Jan. 3, 1909	Jan. 3-5, 1909 = 3 days.	Jan. 6-Feb. 4, 1909 = 30 days.	Feb. 5-7, 1909 = 2½ days.	Feb. 7, 1909 p.m.	5½ + (30) = 35½ days.

The normal length of life for the species of *Actias* and the more closely allied Saturniids averages about 7 or 8 days. In the experiments above described this normal period of life was represented by the period in which the blood of the insect could circulate unhindered by the low temperature, and coincided with the days on which the temperature rose above 0° C. If from the total length of life of the specimens on which I experimented we subtract the time of the anabiotic condition, we obtain for the female 6 and for the male 5½ days of normal life. Neither of the specimens reached the normal mean of 7 to 8 days. Instead of regarding this condition as being due to the individual constitution of the specimens, I believe it is more correct to attribute the shortening by one to two days to the anabiotic state. According to the work of Bachmetjew cited above, this investigator established that the insect juices do not completely congeal till a temperature of -4.5° C. is reached, whereas 88 per cent of the juices congeal at -3° C. and 97 per cent at -4° C. Since in my experiments the minus temperatures varied between 3° C. and 6° C. there must have been periods when small portions of the juices (up to 12 per cent) were not congealed. At such times metabolism, although of a very feeble sort, could occur in the animal and this would not have taken place, if, during the anabiotic condition, the temperature had remained constantly at -4.5° C. In such a case metabolism could have gone on only before and after it had been in the anabiotic condition, and certainly both moths would

have attained a longer life by one or two days under the influence of the plus temperatures.

I believe that these observations, although carried on with so few individuals, nevertheless justify us in assuming that Bachmetjew's supposition that an insect may remain without dying for an indefinitely long period in an anabiotic condition, has received its *first* experimental support. But we must not forget to limit this statement to the adult insects, for the pupæ of *Actias selene* die even after a few days if they are subjected to freezing temperatures.



ADAPTATION AND IMMUNITY OF LOWER ORGANISMS TO ETHYL ALCOHOL

BY

J. FRANK DANIEL

A phenomenon of surpassing biological interest is the adjustment of living substance to its surroundings. That living things should so act as to promote their own welfare is indeed wonderful; that such acts are common is evident on every hand.

The darkened plant creeping toward the needed light, the arctic hare at the approach of winter changing its coat of gray for one of white, living tissue in battle against arsenic or alcohol or toxins securing life against an amount perchance many times in excess of the once fatal dose—these are phenomena in adjustment common to observation, yet of the utmost significance to the well-being of the organism.

Within recent years the study of these adjustments or adaptations has received unusual attention. The subject of immunity alone, developed especially by the schools of Ehrlich and Metchnikoff has within the past two decades almost attained the proportions of a science within itself.

Research in adaptation and immunity has been confined largely to the higher forms of life. These because of their complexity, offer many difficulties. A study even of an individual group of cells in these, as for example the red blood corpuscles, has to take into account a most complex medium—the blood stream. The protozoa on the other hand are comparatively simple and live in a medium which is as a rule readily subject to control. Because of these facts and for the added reason that a knowledge of the

single cell is fundamental, the following series of experiments have to do with the adjustment and immunization of different types of lower organisms to various kinds of substances.

The fact that the same species of protozoa may be found under widely differing environmental conditions—in fresh water or in alkaline lakes—suggests at once that what protoplasm is in kind depends much upon the experiences through which it has passed. If this be true the toleration of different environmental conditions just mentioned would probably be due to the gradual adjustment of the organisms to slight but constant changes in the surroundings. By such a process different members of a single race might finally come to live and prosper as separate types under conditions so widely different as to be mutually destructive.

That such extremes of adjustment are possible may be demonstrated in the laboratory.

Various investigators by subjecting organisms for a time to heat or cold have rendered them immune to great extremes of temperature.¹ Thus Dallinger² in a continuous series of experiments lasting through a period of several years so increased the resistance of various Flagellates to heat as to raise the killing point from 23° C. to the extreme of 70°, so that the organisms lived at a temperature 47° higher than that which formerly destroyed them.

Experiment with poisonous chemicals likewise shows that substances which are extremely destructive to living protoplasm may be rendered less injurious if the animal is subjected gradually to increasing concentrations. Davenport and Neal³ have shown that the unicellular organism *Stentor coerulesus* after being kept for a few days in a weak concentration of corrosive sublimate, is able to survive a stronger solution several times as long as can a control animal of the same series.

A beautiful case of adaptation has been shown by Hafkine.⁴ In his experiments a drop of natural water containing different

¹ For a reference to the literature, see Davenport and Castle. 1895, Arch. f. Entw. mechan., II Band, 2 Heft, pp. 227-249.

² Dallinger, W. H., 1880, Jour. Royal Mic. Soc., III, pp. 1-16.

³ Davenport, C. B., and Neal, H. V., 1896, Arch. f. Entw. mechan., II Band, 4 Heft, pp. 564-583.

⁴ Hafkine, W. M., 1890, Ann. de l'institut Pasteur, iv, pp. 363-379.

species of organisms was placed on a slide; near this was put two or three times as much of an artificial infusion in which animals were living. Upon connecting the two, both the animals in the natural water and those of the infusion died with marked violence. Animals from these divergent media, however, were brought by gradual change to live with impunity under the once mutually destructive conditions.

I have never found organisms under sufficiently divergent natural conditions to obtain Hafkine's results with minimal amounts of media, but with a small quantity of a normal culture plus a larger volume of a foreign medium, I have observed similar phenomena.

My study of adaptation in lower organisms falls naturally into two divisions. Part I⁵ deals with the adjustment of *Paramecia* to distilled water. Part II, the present study, has to do with the adjustment and immunity of *Stentor* and *Spirostomum* to ethyl alcohol.

At this point I should like to express to Prof. H. S. Jennings, under whose direction the following researches were made, my highest appreciation for the sincere sympathy he has shown at all periods of my work upon this subject.

IMMUNITY OF STENTOR AND SPIROSTOMUM TO ETHYL ALCOHOL

I INTRODUCTION

The effect of alcohol upon living matter has long been a subject for observation and experimentation. Its marked influence upon man makes it a problem of the greatest practical concern to the race. Aside from this, the nature of its action, especially in the case of its use in moderation, is of the highest scientific interest.

Within the past decade notable advancement has been made in this latter direction. Probably the work of no single investigator has been farther reaching in its results than has that of Atwater.⁶ From his extensive and thorough-going investigations we have

⁵ Published 1908, *Amer. Jour. Physiol.*, xxiii, pp. 49-63.

⁶ Atwater, *Physiological Aspects of the Liquor Problem*, vol. ii, 1903.

learned much of the real nature of the relation that alcohol bears to the process of metabolism. The former notion that alcohol facilitated the storing up of fat by retarding metabolism has largely given place to the view that alcohol is itself oxidized in the body, thus preventing or retarding the oxidation of other materials. Further than the fact of its oxidation but little is known.

In the following investigations I have undertaken a study of the general effects of alcohol upon single-celled organisms. For work of this sort much depends upon the type of cell selected. Probably no single requisite is more important than that the organism be of sufficient size to permit ready determination of the moment of death. The blue Stentor (*S. coeruleus*) meets this requirement admirably. In addition, its habit of attachment gives it a marked advantage over more active infusoria, and its characteristic reaction to light makes it easily obtainable in larger numbers relatively free from débris.

In determining the fatal dose of alcohol for Stentor it will be well briefly to survey the effects of weak percentages in general.

II PRELIMINARY EXPERIMENTS

A Effects of Minimal Amounts of Alcohol

Alcohol even in very low percentages is generally regarded as a "protoplasmic poison." Its deleterious effects in small doses depend much, however, upon the kind of organism studied.

Hodge⁷ in experimenting upon developing yeast found a decrease in division, in solutions containing as low as $\frac{1}{100}$ of 1 per cent of alcohol, the average number of cells in this strength being only 992 per cubic centimeter as compared with 2061 under normal conditions. On the other hand Maltaux and Massart⁸ for *Chilomonas* and Woodruff⁹ for "one period of the life cycle" in *Paramecium* have shown that alcohol increases the division rate. In *Paramecium* it is further important to note that the increase was lost after a time.

⁷ Hodge, 1897, Pop. Sci. Monthly, vol. 1, pp. 594-603.

⁸ Maltaux, Marie et Massart, Jean. 1906, Recueil de l'Institut Botanique, vi, pp. 269-421.

⁹ Woodruff, L. L., 1908, Biol. Bull., xv, pp. 85-104.

Richardson¹⁰ in determining the death-point for a fresh-water medusa found that from $\frac{1}{30}$ per cent to $\frac{1}{10}$ per cent of alcohol proved lethal to this form within a short period of time.

Reid Hunt¹¹ in his fascinating *Studies in Experimental Alcoholism* has obtained in higher animals the first positive evidence, so far as I am aware, of direct injury due to minimal doses of alcohol. These experiments upon white mice made it evident that amounts of ethyl alcohol far too small to produce indications of intoxication are capable of rendering the animal more susceptible to a definite poison,—acetonitrile.

In my experiments I have found protozoa comparatively resistant to weak concentrations of alcohol. In solutions of 1 per cent or lower, the organisms often lived in a prosperous condition for weeks at a time. Solutions of alcohol as high as 4 per cent in strength were in all cases early destructive of the protoplasm of Stentor and percentages of 2 and 3 per cent produced death after a period of six and two hours, respectively.

B Reaction to Stronger Percentages

I Description

In the following study two very different strains of Stentor—which we may designate as E and F—were employed. These showed marked differences in their reactions to ethyl alcohol.

Type E, composed of cells of immense size, deeply pigmented, and actively free-swimming, came from a black infusion of decayed vegetable material. Type F on the other hand—composed of cells of medium size, and usually attached, grew in a clear medium of tap water and Chara. These latter cells maintained a sturdy condition with slow rate of division for long periods of time.

The two types in a sublethal medium (e.g., 1 per cent alcohol) showed the following characteristic differences in behavior. The large cells E upon subjection to the alcohol were stimulated to

¹⁰ Richardson, 1888 (July), *Asclepiad*.

¹¹ Hunt, Reid, 1907, *Bull. No. 33, Hyg. Lab. U. S. Pub. Health and Mar. Hosp. Serv., Washington, D. C.*

marked activity. After having remained in the medium for a day an acceleration in division was observed which resulted in cells of smaller size. Type F, on the contrary, in this weak solution of alcohol showed slight increased activity upon subjection, and practically no increase in the rate of division upon remaining in the medium for a short period of time.

When these two types had been kept in a weak solution for some time, and were then placed in stronger alcohol, they showed still more important differences. Type F gained a marked immunity as a result of remaining in the weak solution, while type E showed very little effect of this sort. This difference will be brought out in full in the following investigations.

2 Method of Studying Immunity

Tests for the immunity resulting from a weak solution of alcohol may be made in one of two general ways. Either (1) the comparative resistance period of alcoholized and control (normal) animals to a known fatal percentage may be determined, or (2) the ability of alcoholized animals to live in a solution which was previously destructive may be tested.

The two may be stated more comprehensively in the following questions:

1 What is the effect produced upon the general resistance of an organism by rearing it in a weak chemical, for example alcohol, and testing it to a strong solution of the same substance.

2 Can animals by living in a weak concentration of a substance be made to survive a stronger percentage of the same? For example, can an organism which is normally killed within a few hours by a 2 per cent solution of alcohol be made to live in the same strength?

3 Experimental

As has been mentioned, the answer to these questions depends upon the animals used. Type E, kept for different periods of time in a weak medium and then tested to a stronger percentage, did not give marked evidence for immunity on either of the tests mentioned above. Type F, on the other hand, reared similarly,

gave clear evidence of immunity when tested by either of the methods. This will be seen from the two experiments which follow.

The first of these, in which F was tested for an increased resistance to a fatal dose, was made in the following way:

Into each of two dishes, designated respectively as A and C, was put 5 cc. of a natural culture medium, containing twenty normal Stentors. To A was then slowly added 1 cc. of 6 per cent alcohol, forming a 1 per cent acclimatizing medium. After a few days the animals from A (acclimatized to 1 per cent alcohol) and from C (control) were tested to a 6 per cent concentration—each experiment consisting of a drop (either of A or of C, containing a single Stentor) added to 1 cc. of 6 per cent alcohol. The death-point was taken as the instant at which ciliary movement ceased.¹² The period of resistance—the number of seconds that the organism survived—was marked in seconds.

The experiment shows the following comparative results:

Experiment I.

RESISTANCE OF STENTOR OF TYPE F TO 6 PER CENT ALCOHOL AFTER LIVING 4 DAYS IN 1 PER CENT ALCOHOL

<i>A Four Days in 1 Per Cent Alcohol</i>		<i>C Control Animals</i>	
	<i>Seconds</i>		<i>Seconds</i>
Exp. 1 cilia stop.....	150	Exp. 1 cilia stop.....	100
2 cilia stop.....	130	2 cilia stop.....	145
3 cilia stop.....	300	3 cilia stop.....	120
4 cilia stop.....	720	4 cilia stop.....	120
5 cilia stop.....	220	5 cilia stop.....	275
6 cilia stop.....	300	6 cilia stop.....	225
7 cilia stop.....	410	7 cilia stop.....	150
8 cilia stop.....	160	8 cilia stop.....	115
9 cilia stop.....	350	9 cilia stop.....	225
10 cilia stop.....	270	10 cilia stop.....	150
	Average resistance = 301		Average resistance = 162.5

Thus the animals which had been kept for a brief time in a 1 per cent solution resisted 6 per cent alcohol on the average 301

¹² It will be observed from following work that the cilia in different regions of the body show different powers of resistance, depending upon the substance used. Thus, in the case of ethyl alcohol the peristomal cilia are usually active longest, while in glycerine the body cilia continue long after the peristome is lost.

seconds, while normal animals survived but 162.5 seconds—an increase of resistance for the acclimatized individuals of nearly 2 to 1.

Experiment II. Equally satisfactory evidence of immunization appeared in Stentors of this type when tested as to their ability to live in stronger solutions of alcohol. In this experiment the following method was used:

Stentors of type F were kept for more than three weeks in a 0.5 per cent solution of alcohol. These were then put into 1 per cent for three days. From this they were transferred after two days to a 2 per cent concentration. We have already seen (p. 575) that 2 per cent alcohol kills unacclimatized Stentors of this type within six hours. But those transferred from the 1 per cent solution were in good condition at the end of the following day. At the end of the second day the animals were still in normal condition. At this time fourteen of them were transferred a third time, to a solution 3 per cent in strength. On the following morning twelve of these were dead; two, however, were alive and swimming at a rapid rate. These survived the greater part of the day.

Thus both methods of testing show that an increased resistance was produced by remaining in the weak alcoholic solution. It is evident that this caused some marked regulatory change in the animals by which they were better able to resist the ill effects of the stronger percentages of alcohol.

Following the same general plan we may now make a closer study of both types E and F.

III DETAILED EXPERIMENTS

A Method and Technique

Following the preliminary experiments, a second series was made in which the greatest care was taken to control the possible sources of error, such as evaporation and dilution of the killing fluid, fluctuations in temperature and variations in the organisms themselves.

In order to prevent error due to a weakening of the alcohol only freshly made solutions were employed. A coverslip which could be sealed in case of prolonged experimentation was used throughout the series.

Upon adding the organisms to the killing fluid considerable dilution is possible. To avoid weakening of the killing fluid either by the addition of more of the culture medium or less of the test fluid a definite amount of culture medium—a capillary drop—was added to a fixed quantity—one-fourth cubic centimeter—of the killing fluid.

Another source of error, more difficult to control, derives from the condition of the organisms themselves. A study of different strains of *Paramecia*¹³ has shown that animals adjusted to different media may react very differently to a given stimulus. Only animals of the same strain, therefore, should be used when a comparative study of the effects of different concentration is desired.

It is further of importance that a careful selection of typical animals, even from the same strain, be made. In these experiments the greatest care has been exercised to reject as abnormal all organisms showing division, regeneration, marked variations in color, considerable differences in size¹⁴ and the like.

The striking differences in reaction seen in animals tested at different degrees of temperature make the control of variable temperatures of the greatest importance.

In a room rapidly heated and ranging from 20° to 22° C. I have often found the culture media and reagents as low as 16° or 17° C. In a condition of this kind the organisms will during the experiments be tested at temperatures varying four or five degrees. With extremes so great as these marked fluctuations in resistance follow which make imperative the discarding of "room temperature" as manifestly too indefinite to be of service in work of this kind. In the following series all materials—reagents, culture media and the like—were kept at a constant temperature of 23° C.

¹³ In part i. *Loc. cit.*

¹⁴ It should be remarked that small cells are not necessarily weaker or less resistant than larger ones; the opposite is often the case. In this selection the condition sought was uniformity of size.

I wish here to express my sincerest appreciation to Professor Morse, of the Johns Hopkins Chemical Laboratory, for his helpfulness in planning a constant temperature apparatus highly satisfactory for this purpose.

B Experimental

With the various sources of error controlled in the way just set forth, the two types E and F may now be studied in detail.

1 Study of Type E

In my attempts at acclimatizing Stentors of type E to alcohol various plans have been resorted to. These will be described in their proper connections.

Both methods by which type F was readily immunized to ethyl alcohol were tried for type E. The method of testing the ability of alcoholized animals to live in a stronger percentage of alcohol gave slight results for type E. Although this type was transferred with great care it was difficult to get it to live in a stronger medium than 1.5 per cent in strength. The other method in which the resistance period of the normal and acclimatized animals was compared, was adopted as the more satisfactory of the two. To test for immunity by this latter method the animals of type E were allowed to remain for short periods of time in a 1 per cent solution made by adding 6 per cent ethyl alcohol to their normal culture medium.¹⁵ The organisms were then tested as to their resistance to a fatal dose.

The results of the tests are shown in the experiments which follow:

¹⁵ Different percentages were tried for making up the acclimatizing medium and 6 per cent was adopted as less likely to produce injury when first added.

Experiment III

RESISTANCE OF STENTORS OF TYPE E TO 6 PER CENT ALCOHOL AFTER LIVING 3 DAYS IN 1 PER CENT ALCOHOL

<i>A Three Days in 1 Per Cent Alcohol</i>		<i>C Control</i>	
	<i>Seconds</i>		<i>Seconds</i>
Exp. 1 cilia stop.....	225	Exp. 1 cilia stop.....	235
2 cilia stop.....	250	2 cilia stop.....	250
3 cilia stop.....	225	3 cilia stop.....	300
4 cilia stop.....	390	4 cilia stop.....	320
5 cilia stop.....	435	5 cilia stop.....	405
6 cilia stop.....	480	6 cilia stop.....	330
7 cilia stop.....	535	7 cilia stop.....	360
8 cilia stop.....	285	8 cilia stop.....	240
9 cilia stop.....	595	9 cilia stop.....	140
10 cilia stop.....	330	10 cilia stop.....	240
	<hr/>		<hr/>
	Average resistance = 375		Average resistance = 282

From this experiment at least two things are evident. First, the resistance of normal animals of this strain is unusually high as compared with that of type F, and secondly, the evidence for immunity is far less marked.

These animals, however, had remained in the acclimatizing medium only three days. Possibly a longer period is needed for the acclimatization of so strong a strain.

The same series at the end of the fifth day gave the following result:

Experiment IV

RESISTANCE OF STENTORS OF TYPE E TO 6 PER CENT ALCOHOL AFTER LIVING 5 DAYS IN 1 PER CENT ALCOHOL

<i>A Five Days in 1 Per Cent Alcohol</i>		<i>C Control</i>	
	<i>Seconds</i>		<i>Seconds</i>
Exp. 1 cilia stop.....	255	Exp. 1 cilia stop.....	255
2 cilia stop.....	395	2 cilia stop.....	240
3 cilia stop.....	520	3 cilia stop.....	360
4 cilia stop.....	230	4 cilia stop.....	380
5 cilia stop.....	315	5 cilia stop.....	150
6 cilia stop.....	380	6 cilia stop.....	330
7 cilia stop.....	410	7 cilia stop.....	205
8 cilia stop.....	210	8 cilia stop.....	405
9 cilia stop.....	490	9 cilia stop.....	260
10 cilia stop.....	300	10 cilia stop.....	330
	<hr/>		<hr/>
	Average resistance = 350.5		Average resistance = 291.5

Instead of giving clearer evidence, this shows the maximum resistance found for control animals in the entire study, and an increase for the acclimatized animals which is lower than in the first experiment.

Whether a high normal resistance in any way obscures the degree of immunity actually present is a further question which may be tested by the use of a stronger killing fluid—thus reducing the period of resistance.

Animals kept in a 1 per cent acclimatizing medium for four days, then tested to an 8 per cent killing solution should be satisfactory for a determination of this point. Such a condition follows:

Experiment V

RESISTANCE OF STENTORS OF TYPE E TO 8 PER CENT ALCOHOL AFTER LIVING 4 DAYS IN 1 PER CENT ALCOHOL

<i>A Four Days in 1 Per Cent Alcohol</i>		<i>C Control</i>	
	<i>Seconds</i>		<i>Seconds</i>
Exp. 1 cilia stop.....	120	Exp. 1 cilia stop.....	125
2 cilia stop.....	30	2 cilia stop.....	30
3 cilia stop.....	30	3 cilia stop.....	20
4 cilia stop.....	25	4 cilia stop.....	35
5 cilia stop.....	30	5 cilia stop.....	20
6 cilia stop.....	30	6 cilia stop.....	30
7 cilia stop.....	40	7 cilia stop.....	60
8 cilia stop.....	20	8 cilia stop.....	35
9 cilia stop.....	105	9 cilia stop.....	60
10 cilia stop.....	35	10 cilia stop.....	30
Average resistance = 46.5		Average resistance = 44.5	

The results as given in the foregoing experiment, however, show that no advantage in this case followed shortening the period of resistance. On the other hand, the experiment gives much less evidence for immunity than either the first or the second.

After trying many cases all terminating as did Experiments III to V in marked variability from slight to doubtful acclimatization, it was thought that the low degree of increase might be due to injury resulting from rapid subjection to a 1 per cent acclimatizing medium. To obviate this, a method was adopted by which small and increasing amounts of alcohol were added so gradually to the normal media as to insure no injury from a too rapid sub-

jection. This method consisted in the addition on succeeding days of 4, 6 and 10 cc. of a 6 per cent concentration to 100 cc. of a normal culture medium.

Animals thus carefully reared on a gradually increasing scale for the same number of days as Experiment III gave the following results:

Experiment VI

RESISTANCE OF STENTORS OF TYPE E TO 6 PER CENT ALCOHOL AFTER 3 DAYS IN AN ACCLIMATIZING MEDIUM GRADUALLY BROUGHT UP TO 1 PER CENT

<i>A. Three Days in Weak Alcohol</i>		<i>C. Control</i>	
	<i>Seconds</i>		<i>Seconds</i>
Exp. 1 cilia stop.....	265	Exp. 1 cilia stop.....	230
2 cilia stop.....	170	2 cilia stop.....	240
3 cilia stop.....	305	3 cilia stop.....	230
4 cilia stop.....	340	4 cilia stop.....	250
5 cilia stop.....	255	5 cilia stop.....	355
6 cilia stop.....	240	6 cilia stop.....	340
7 cilia stop.....	90	7 cilia stop.....	360
8 cilia stop.....	160	8 cilia stop.....	75
9 cilia stop.....	330	9 cilia stop.....	245
10 cilia stop.....	420	10 cilia stop.....	255
	Average resistance = 257.5		Average resistance = 258

From the above it is reasonably certain that the low increase in resistance shown in Experiment III was not due to an injury attributable to the 1 per cent acclimatizing fluid, for in the same strength, to which the animals were subjected so gradually as to be without injury, no acclimatization whatsoever resulted.

Since no injury and very doubtful acclimatization is evident in a medium of 1 per cent strength, the question naturally follows: May not the low degree of immunity be due to the fact that the medium is too weak to produce an immunizing effect?

To test this, Stentors were brought through a graduated series of transfers to the highest percentage in which they could live without apparent injury—a 1.5 per cent solution. A test to 8 per cent alcohol of animals from this medium resulted as follows:

Experiment VII

RESISTANCE OF STENTORS OF TYPE E TO 8 PER CENT ALCOHOL, AFTER LIVING 4 DAYS IN 1.5 PER CENT ALCOHOL

<i>A Four Days in 1.5 Per Cent.</i>		<i>C Control</i>	
	<i>Seconds</i>		<i>Seconds</i>
Exp. 1 cilia stop.....	40	Exp. 1 cilia stop.....	50
2 cilia stop.....	90	2 cilia stop.....	35
3 cilia stop.....	45	3 cilia stop.....	75
4 cilia stop.....	75	4 cilia stop.....	55
5 cilia stop.....	30	5 cilia stop.....	30
6 cilia stop.....	35	6 cilia stop.....	105
7 cilia stop.....	45	7 cilia stop.....	130
8 cilia stop.....	35	8 cilia stop.....	115
9 cilia stop.....	50	9 cilia stop.....	35
10 cilia stop.....	35	10 cilia stop.....	25
	Average resistance = 48.		Average resistance = 65.5

In Experiment VII, although the animals had been kept in the strongest medium that they could withstand, still no immunity was shown. On the contrary, the alcoholized animals were actually less resistant than were those of the control.

Briefly summarizing the results of the five experiments (III to VII) it is to be noted that only III and IV gave evidence of immunity; that V, although positive in resistance, was so low as to fall easily within the experimental error; while VI showed no increase whatsoever, and VII gave a higher resistance in its control than in its alcoholized animals.

It will be observed that the foregoing series of experiments on type E were made from the third to the fifth days of acclimatization. The same general results are obtained, however, if tested either earlier or later.

A final study of this type may be added in which tests were made after the second, fifth and seventh days of acclimatization. These animals were reared in a fluid gradually brought up to 1 per cent, and were tested to a 6 per cent solution of alcohol.

The results are briefly shown in seconds of resistance in the following study made on the different days:

Experiment VIII

RESISTANCE OF STENTORS OF TYPE E TO 6 PER CENT ALCOHOL AFTER LIVING IN 1 PER CENT ALCOHOL. A = ANIMALS THAT HAVE LIVED IN ALCOHOL. C = CONTROL ANIMALS

Second Day		Fifth Day		Seventh Day	
A	C	A	C	A	C
Seconds	Seconds	Seconds	Seconds	Seconds	Seconds
410	175	310	260	220	210
265	135	275	280	425	270
175	215	410	190	235	355
220	290	255	350	330	125
95	360	190	460	350	380
120	115	310	280	230	135
290	375	305	110	385	250
450	120	160	355	250	390
250	330	320	150	225	220
340	425	275	220	320	250
Average resistance = 261.5		281	265.5	297	258.5

The outcome of this series adds little, if any, evidence for acclimatization. While in the three cases the animals of A, as in preceding experiments, show a slight increase in resistance, this is not sufficiently high, with a possible exception of the seventh day, to be at all convincing.

In summarizing the entire work done upon type E, it will be recalled that when reared for different periods of time either in weak or in stronger percentages of acclimatizing media and tested to different strengths of the killing fluid, this type gave considerable increase in resistance in only a few cases. A discussion of its tolerance may, therefore, be confined largely to a consideration of the first two (III and IV) and to the last experiment (VIII). The others, although often positive, fall easily within the possible experimental error, and may, as a consequence, be classed as unconvincing.

Since what is true for III is true also for Experiments IV and VIII, our study may further narrow itself down to a consideration of Experiment III alone.

The highest increase found during the entire study of E is that

given in Experiment III. This gives a ratio of 1.3297 + to 1 for the resistance period of the acclimatized animals as compared with that for the controls. This, however, as we shall see later, is much less marked than the results of even the least striking experiments for type F. But in degree it might well be classed as a case of immunity were it but constant. Ranging, however, from this maximum down were other experiments of the same kind which showed less or even no increase in resistance whatsoever. The latter extreme is shown in Experiment VI.

This variability of results was so noticeable that at no time has the evidence for the immunity of this type been convincing.

2 Study of Type F

From the preliminary study we saw that the animals of type F responded to acclimatization in a weak medium of alcohol by an increase in the resistance to a known fatal dose from a period of 162 seconds to 301 seconds. Further, when this type was kept for a longer period in a weak medium which was gradually increased in strength, it finally came to live in a concentration sufficient to have proved destructive before acclimatization.

We may now proceed to a study of type F, in which something of the nature of the immunization—when it begins, when it reaches its maximum degree of increase, and the like—may be sought.

The method employed in the preliminary experiment as modified in the study of type E, was followed in detail. Of the two tests for immunity given, that depending upon the increased period of resistance to a fatal dose was adopted as being the more advantageous, especially in point of time.

Incipient immunity may vary considerably as to the time of its appearance. In this range of variability several factors are involved.

One strain of animals at a given time may show immunity slightly advanced before another strain of the same type has ceased being stimulated to activity from subjection to the medium. What is true of different strains is equally true of individuals of the same strain. In other words single cells, like higher forms, show marked

individual differences in their susceptibility to alcohol—some quickly adjusting themselves to it, others doing this with greater difficulty.

Similar variability in results may be due to the fact that the acclimatizing medium is too strong or too weak. In either case there may be entire lack of immunity, or immunity may be deferred. Lack of immunity may be due either to a medium too weak to produce any effect, or one so strong as to produce lasting injury. Deferred immunity may be due to the fact that the medium is so weak that a long period is necessary for producing an acclimatizing effect, or it may come in a stronger solution when the first effect is injurious, but is later replaced by the acquirement of immunity.

In several cases I have noticed that animals tested soon after subjection to the acclimatizing medium showed a decrease in resistance. This in some cases lasted several hours; in others it was of short duration and was followed by evident adjustment.

In an acclimatizing fluid of medium strength, an early evidence of immunity may be expected from average animals by the end of the fourth or fifth hours.

The degree of possible tolerance reached evidently depends upon factors similar to those which we have just set forth. Among these may be especially mentioned—the effects of different percentages of the acclimatizing media, the period of time during which the animals are subjected to such media, and the condition of the organisms at the time of subjection.

In my work upon type F, a medium of 1 per cent alcohol has been found most satisfactory. It has, therefore, been adopted as the standard acclimatizing fluid in which all of the animals of A, with but few exceptions, have been reared. If the medium in which the animals are kept be of a strength lower than 1 per cent the immunity produced by it may be expected to be proportionately less in degree at a given time than that from a 1 per cent medium—provided, of course, the strain suffers no permanent injury from this latter strength.

Using then a 1 per cent solution of alcohol as a unit we may pro-

ceed to experiments which determine the relation that slightly differing strengths bear to different degrees of immunity.

In a solution of 0.5 per cent the evidence for adjustment to alcohol though sometimes slight is usually clear after a short time. In this strength evidence may be expected which by the end of the fourth day is definite. By this time the degree of immunity produced by two acclimatizing media—for example one of 0.5 per cent and the other of 1 per cent strength—should be sufficient to be compared, and their differences noted.

An experiment follows in which animals from 0.5 per cent and 1 per cent media were tested to 6 per cent killing fluid. Both were further controlled by the resistance of normal animals.

Experiment IX

RESISTANCE OF STENTORS OF TYPE F TO 6 PER CENT ALCOHOL AFTER LIVING 4 DAYS IN SOLUTIONS OF DIFFERENT STRENGTHS

<i>A Four Days in 1 Per Cent Alcohol</i>			
		<i>Seconds</i>	
Exp. 1	cilia stop.....	190	
2	cilia stop.....	330	
3	cilia stop.....	140	
4	cilia stop.....	180	
5	cilia stop.....	350	
6	cilia stop.....	160	
7	cilia stop.....	195	
8	cilia stop.....	180	
9	cilia stop.....	240	
10	cilia stop.....	330	
	Average resistance =	229.5	
 <i>A Four Days in 0.5 Per Cent Alcohol</i>			
		<i>Seconds</i>	
Exp. 1	cilia stop.....	120	
2	cilia stop.....	185	
3	cilia stop.....	260	
4	cilia stop.....	325	
5	cilia stop.....	130	
6	cilia stop.....	80	
7	cilia stop.....	130	
8	cilia stop.....	160	
9	cilia stop.....	200	
10	cilia stop.....	135	
	Average resistance =	172.5	
			<i>C Control</i>
			<i>Seconds</i>
Exp. 1	cilia stop.....	130	
2	cilia stop.....	85	
3	cilia stop.....	285	
4	cilia stop.....	160	
5	cilia stop.....	90	
6	cilia stop.....	110	
7	cilia stop.....	110	
8	cilia stop.....	265	
9	cilia stop.....	230	
10	cilia stop.....	70	
	Average resistance =	153.5	

Stentors of this type with a normal resistance averaging 153.5 seconds show in a 0.5 per cent solution a gain in resistance which though slight is nevertheless constant and typical. In a 1 per cent medium the resistance is increased to 229.5 seconds. Although the experiment was selected as one giving low results for the type, nevertheless it denotes for the animals of the 1 per cent solution a substantial gain over animals both of the control and of the 0.5 per cent medium.

But the point of most interest is that the two media, though differing but slightly in strength, show a corresponding difference in degree of immunity. From this it is seen that subjection to two media of different strengths for a definite time gives corresponding differences in the increase of immunity.

Time as a Factor in the Degree of Immunity Produced. We have now established two points. These are that at the end of four or five hours immunity normally begins and that at the end of the fourth day this is definite and considerable. The progress from the one to the other may now be noted.

The difference in degree of adjustment due to the same medium at the end of a few hours and again at the end of a few days, shows that immunity increases as the period in the acclimatizing fluid is lengthened. This is true, however, for only a limited time.

In an acclimatizing medium of average strength the adjustment which as we saw comes on at the end of the first few hours has by the end of the first day become sufficiently clear not to be mistaken. As an example of this and its subsequent history a test series may be given, which gave the highest immunity found for the type. In this the animals had at the end of the first day a resistance of 166 seconds. The resistance had on the third day increased to 249 seconds. On the fourth day a notable rise was shown in which the killing time for the acclimatized organisms reached a maximum of 334 seconds, the control at the same time showing a resistance of 160 seconds.

By the fourth day in this and subsequent experiments it was found that immunity had reached a high degree of constancy. For this reason, in the following experiments on this type, the fourth day has been selected as the time at which tests requiring a maximum degree of immunity were made.

The progress of immunity from the first to the fourth day, while showing various fluctuations, increases with a considerable degree of constancy. This may be shown in the following experiment, which is in general typical for others of the same series. In this the animals were reared in a 1 per cent medium and tested to 6 per cent alcohol on the first, second, third and fourth days of their acclimatization.

Experiment X

RESISTANCE OF STENTORS OF TYPE F TO 6 PER CENT ALCOHOL AFTER DIFFERENT PERIODS IN 1 PER CENT ALCOHOL. A = ACCLIMATIZED ANIMALS. C = CONTROLS

First Day		Second Day		Third Day		Fourth Day			
A	C	A	C	A	C	A	C		
Seconds	Seconds	Seconds	Seconds	Seconds	Seconds	Seconds	Seconds		
220	155	150	65	210	225	330	275		
170	80	420	120	215	90	370	80		
145	140	75	100	435	75	210	190		
170	120	375	145	175	155	490	115		
125	120	205	150	210	140	270	140		
150	155	215	165	380	195	225	100		
135	130	290	125	410	195	150	120		
110	105	110	205	190	165	410	130		
235	180	100	70	330	175	300	135		
180	80	300	180	190	240	240	145		
Average resistance =		164	126.5	224	132.5	274.5	165.5	299.5	143

The two extremes—the first and fourth days—are in this experiment especially typical. On the third day—as was seldom the case—almost as high a degree of immunity is represented as on the fourth. On this day, as well as on the fourth day of the test example, the control also showed a considerable increase. In both of these cases, however, the degree of increase for the control does not approximate that attained by the acclimatized animals.

It is thus seen that the same animals kept in a given percentage of acclimatizing medium give different degrees of immunity at different periods of time.

The variability which was seen to be a prominent feature in beginning immunity is nowhere seen more strikingly than in a study of the maximum degree of immunity.

Type F illustrates this in a clear way. Animals of the same strain kept under similar external conditions and for a like period of time, varied at different times in their reactions to the same concentration. Thus type F, kept in a 1 per cent medium for four days, gave at different times average resistance periods to 6 per cent alcohol of 229.5, 301, 299.5 and 334 seconds—a difference of more than 100 seconds between the two extremes, though their controls, 153.5 and 160, were practically equal at the different times.

But not alone did type F show varying degrees of resistance at different times when tested to the 6 per cent alcohol, but it manifested to a more remarkable degree the same variability when tested to a stronger concentration. Type E as we may recall, while it showed unusually high resistance to a 6 per cent killing fluid, showed low resistance when tested to 8 per cent. Type F, on the contrary, though low to 6 per cent alcohol, sometimes gave a resistance to 8 per cent which was but little short of that given to a 6 per cent solution.

This may be shown in the following experiment:

Experiment XIa

RESISTANCE OF STENTORS OF TYPE F TO 8 PER CENT ALCOHOL, AFTER LIVING 4 DAYS IN 1 PER CENT ALCOHOL

<i>A Four Days in 1 Per Cent</i>		<i>C Control</i>	
	<i>Seconds</i>		<i>Seconds</i>
Exp. 1 cilia stop.....	315	Exp. 1 cilia stop.....	135
2 cilia stop.....	190	2 cilia stop.....	150
3 cilia stop.....	380	3 cilia stop.....	85
4 cilia stop.....	215	4 cilia stop.....	160
5 cilia stop.....	160	5 cilia stop.....	100
6 cilia stop.....	155	6 cilia stop.....	135
7 cilia stop.....	120	7 cilia stop.....	30
8 cilia stop.....	210	8 cilia stop.....	135
9 cilia stop.....	210	9 cilia stop.....	95
10 cilia stop.....	140	10 cilia stop.....	90
	209.5		111.5

Finding the normal resistance so high, I was interested to see whether acclimatization to a 0.5 per cent solution would show,

when compared with the effects of a 1 per cent solution, differences similar to those shown in Experiment IX (p. 588).

To this end some of the same type which had been kept in a 0.5 per cent medium were tested at the same time, with the same control.

This experiment resulted as follows:

Experiment XIb

RESISTANCE OF STENTORS OF TYPE F TO 8 PER CENT ALCOHOL, AFTER LIVING 4 DAYS IN 0.1 PER CENT ALCOHOL

<i>A Four Days in 0.5 Per Cent</i>	<i>Seconds</i>	<i>C Control</i>
Exp. 1 cilia stop.....	90	
2 cilia stop.....	120	
3 cilia stop.....	140	
4 cilia stop.....	105	
5 cilia stop.....	180	
6 cilia stop.....	100	C..... = 111.5
7 cilia stop.....	140	
8 cilia stop.....	160	
9 cilia stop.....	140	
10 cilia stop.....	100	
Average resistance		= 127.5

While the increase is only slightly higher than that of the control yet this is much more constant as will be seen in the slight range of variability (90 to 180 seconds). This constancy shows that in this case also different concentrations produced different degrees of immunity.

3 General Discussion of Types E and F

The degree of increase in resistance due to remaining in weak alcohol is as we have seen, very different in the two types E and F. Type E in no place indicated more than a slight and occasional evidence of immunity to alcohol. Type F on the contrary gave an increase of resistance which was considerable and constant. A low average period of resistance in type F was 229.5 seconds, while that of the control was 153.5 seconds (a ratio of 1.4951 to 1). If the same average increase of resistance were

produced in E, the latter should show in such a case as that given in Experiment III, p. 581 (the highest ever observed for E), a resistance of 421.6 seconds (control 282×1.4951) instead of 375, as actually appeared. Thus the immunity indicated was at best of a low degree. This low degree taken in connection with the inconstancy of the results for that type makes the evidence for its immunization scanty indeed. In type F, on the other hand, the increase in resistance was marked and constant, so that the immunization due to a residence in weak alcohol is evident.

Evidence as to the existence of immunity to alcohol shows itself in various other ways, besides an increase in the period of resistance. The two types E and F showed also many differences in these other respects. Thus in type E the normal resistance of the control specimens was remarkably high and constant. The average period of resistance to 6 per cent alcohol of 100 experiments with unacclimatized specimens of type E was 267.9 seconds. If this be compared with the resistance period for the controls of E, as given in the foregoing experiments, the similarity is very striking. On the other hand, the increase of resistance in type E, due to keeping the animals in weak alcohol, was very inconstant.

In these respects the animals of type F offer a contrast to those of type E. In type F the natural resistance of the control animals varied considerably at different times, but the increase in resistance due to remaining in weak alcohol was uniform, so that there was an almost constant ratio between the resistance periods of the unacclimatized and the acclimatized specimens.

Furthermore, the response of the acclimatized animals of type F to the killing fluid was different from that of unacclimatized forms. It might be supposed that an increase in resistance would manifest itself especially in making the animals better able to preserve themselves intact from the action of the drug. Such was not my observation. On the contrary the acclimatized animals of type F usually suffered an early distortion. In these animals life, to outward appearances, was well nigh extinct at the end of a few seconds—the cilia beating unsteadily. Near the end of the first minute, however, they revived and death was delayed often for a considerable period of time.

This behavior may be shown in no better way than by a detailed description of what took place in a single individual. This cell is given in preliminary Experiment 1 (individual 4), and is entirely typical of the general proceedings, excepting that its resistance period was unusually long.

Upon first subjection to the killing fluid the body of this cell remained motionless; at the end of 10 seconds a strong anterolateral bulging occurred in the aboral region; the cilia continued to beat up to 45 seconds though their action was slow and uncertain. After surviving the shock incident to subjection to the fluid, a gradual increase in strength of stroke of the cilia followed, which finally caused the whole mass of protoplasm to vibrate in wavelike rhythm, until within a few seconds of death (at 720 seconds).

We may then say that the effects of strong alcohol upon acclimatized animals of type F were different from those upon type E in at least three ways: (1) In showing a higher degree of increase, (2) in producing greater constancy of action, and (3) in manifesting a definite method of reaction in the protoplasm.

With these considerations we may now pass to a study of another cell with the single remark that never during the months that I have worked upon type E, have I been entirely able to assure myself of its adjustment to alcohol, and at no time have I had reason to doubt such adjustment in type F.

4 A Study of Spirostomum

A further study of acclimatization to alcohol was made upon one of the largest of the single celled organisms, *Spirostomum* (*S. ambiguum*).

While this form is not found attached as in the case of *Stentor*, the disadvantage due to its activity is fully compensated for by the most definite of death-points. Subjected to a chemical stimulus *Spirostomum* begins backing, as is characteristic of many of the ciliates. If the chemical into which the organism is introduced be of sufficient strength to cause death the first sign of injury appears as a rupture at the extreme anterior end. Disintegration, beginning at this point, travels rapidly towards the posterior end

(following the direction the organism is moving) until it has consumed the entire body—leaving in its path only a granular mass of disintegrated protoplasm. Death is that unmistakable point at which the last trace of form is destroyed and at which the last cilium can be clearly seen to stop moving.

The fact that this organism can be obtained in large numbers and kept for long periods of time, together with the fact that it gives so definite a death-point, makes it in some respects preferable even to *Stentor* for work of this sort.

The *Spirostoma* of the following studies grew in a medium in which the decayed vegetable material had settled to the bottom, leaving the organisms in a relatively clear liquid. In this they flourished in great abundance, furnishing most satisfactory material for comparative studies for months at a time.

Individual variation in resistance to chemicals is in the case of *Spirostomum* most marked. Animals from the same culture, when tested to a low fatal dose, may be divided roughly into two groups—one dying within two to three minutes, the other (a smaller group) surviving in the same fluid a much longer time.

In work upon this form the larger group above mentioned has been taken as the more representative and organisms with a resistance exceeding seven minutes have not been counted. This would seem likely to produce error, for if animals with a normal resistance approaching seven minutes be raised by acclimatization to or above this maximum they would be rejected as abnormal. Those of the control, on the other hand, would not thus increase above this maximum and would therefore be counted. The elimination of the one and the counting of the other would result in a ratio between the two that would indicate less immunity than was actually present.

As a matter of fact error of this sort has been largely controlled in the following work. This was done by the use of a stronger killing fluid, which shortened the period of resistance. In an 8 per cent killing fluid it was found that only a few lived longer than seven minutes.

With these considerations we may now pass directly to the experiments.

The method and technique developed for the study of Stentor were used as satisfactory also for a study of Spirostomum. The animals were kept in a low percentage of alcohol (1 per cent) for a short time and were then tested for their resistance to a stronger concentration. The conditions—such as the maintenance of constant temperature and the like—were similar in all respects to those of Stentor.

Experiment XII. In determining the effect of a low fatal percentage of alcohol upon Spirostomum a 6 per cent solution was first used. In this, however, it was found that, although normal animals succumbed, nine out of ten of those acclimatized were alive at the end of thirty minutes.

From this it was obvious that in order to get a quantitative statement of the resistance a stronger test fluid was needed. Thereupon an 8 per cent medium was employed with the following typical results:

Experiment XII

RESISTANCE OF SPIROSTOMA TO 8 PER CENT ALCOHOL AFTER LIVING 4 DAYS IN 1 PER CENT ALCOHOL

<i>A Four Days in 1 Per Cent Alcohol</i>		<i>C Control</i>	
	<i>Seconds</i>		<i>Seconds</i>
Exp. 1 cilia stop.....	110	Exp. 1 cilia stop.....	80
2 cilia stop.....	145	2 cilia stop.....	50
3 cilia stop.....	220	3 cilia stop.....	65
4 cilia stop.....	45	4 cilia stop.....	55
5 cilia stop.....	90	5 cilia stop.....	50
6 cilia stop.....	150	6 cilia stop.....	60
7 cilia stop.....	210	7 cilia stop.....	180
8 cilia stop.....	165	8 cilia stop.....	50
9 cilia stop.....	240	9 cilia stop.....	135
10 cilia stop.....	190	10 cilia stop.....	80
	156.5		80.5

From Experiment XII it is seen that the increase is much like that given in type F of Stentor. Although in Spirostomum there is a greater range of variability yet the striking feature in the many cases observed was that although the normal animals varied in their resistance from time to time the ratio between acclimatized and unacclimatized (control) animals remained practically the same.

From experiments in an 8 per cent solution, another point of extreme interest was observed.

Organisms often showed the first signs of injury within the usual time—one to two minutes—and disintegration followed in the usual way. Upon reaching mid-body, however, this was suddenly stopped. At the point of injury a round plug of protoplasm formed, filling up the wound. Thereupon the cilia resumed a backward stroke and the body moved forward in a normal fashion.

This phenomenon was observed again and again as the method by which the organisms often prolonged life for considerable periods of time.

In the same way that type E of Stentor was tested on the second, fifth and seventh days, we may test Spirostomum to see the general indications of resistance.

These results, shown in a condensed way in the following table, are different from those obtained in type E of Stentor.

Experiment XIII

RESISTANCE OF SPIROSTOMA TO 8 PER CENT ALCOHOL AFTER LIVING IN 1 PER CENT ALCOHOL. A = LIVING IN 1 PER CENT ALCOHOL. C = CONTROL

<i>Second Day</i>		<i>Fifth Day</i>		<i>Seventh Day</i>	
A	C	A	C	A	C
<i>Seconds</i>	<i>Seconds</i>	<i>Seconds</i>	<i>Seconds</i>	<i>Seconds</i>	<i>Seconds</i>
45	90	195	50	210	45
205	150	240	220	260	55
110	45	75	70	195	100
55	190	70	90	330	40
90	65	215	110	55	50
200	150	255	50	90	50
120	105	70	70	190	85
95	65	255	60	60	50
225	90	205	70	190	60
95	90	70	45	105	120

Average resistance 124 104 165 83.5 168.5 65.5

In the foregoing series only a slight increase for the acclimatized animals is shown on the second day. It will be noted, however, that the normal resistance (104 seconds) is high. In other cases

a better increase was shown at the end of the first day than is here given on the second. Probably the most typical results for the series are those on the fifth day. On the seventh a slightly higher average obtains for A, but C is less resistant. Had it been typical, however, there would still be a ratio slightly above two to one.

Another point may be noted in passing. The control animals, unlike those of Stentor, instead of increasing in resistance, showed a gradual decrease.

A further study was made in Spirostomum of the immunity shown at considerably later periods of time.

The greatest difficulty encountered was in keeping the acclimatizing medium A at its usual strength. In order to do this two plans were tried. In one the culture was changed every few days; in the other it was kept in ground glass vessels which were sealed and set at constant temperature until the time of experiment. The latter method was adopted as giving better results.

An experiment under these conditions follows in which the organisms were tested after eleven days in the acclimatizing and control media.

Experiment XIV

RESISTANCE OF SPIROSTOMUM TO 8 PER CENT ALCOHOL, AFTER LIVING 11 DAYS IN 1 PER CENT ALCOHOL

A 11 Days in 1 Per Cent Alcohol			C Control		
	Seconds			Seconds	
Exp. 1	190	Exp. 1	30		
2	50	2	70		
3	85	3	25		
4	95	4	160		
5	95	5	120		
6	390	6	30		
7	45	7	65		
8	285	8	60		
9	150	9	50		
10	70	10	30		
	<hr/>		<hr/>		
	145.5		64		

We see from this that although the resistance of the control was low, the acclimatized animals have retained their immunity for this period of time.

A later series at the end of the second week gave the following similar results:

Experiment XV

RESISTANCE OF SPIROSTOMA TO 8 PER CENT ALCOHOL AFTER 14 DAYS IN 1 PER CENT ALCOHOL

<i>A 14 Days in 1 Per Cent Alcohol</i>		<i>C Control</i>	
	<i>Seconds</i>		<i>Seconds</i>
Exp. 1 cilia stop.....	215	Exp. 1 cilia stop.....	25
2 cilia stop.....	60	2 cilia stop.....	125
3 cilia stop.....	180	3 cilia stop.....	30
4 cilia stop.....	75	4 cilia stop.....	50
5 cilia stop.....	250	5 cilia stop.....	55
6 cilia stop.....	230	6 cilia stop.....	50
7 cilia stop.....	65	7 cilia stop.....	95
8 cilia stop.....	55	8 cilia stop.....	30
9 cilia stop.....	95	9 cilia stop.....	120
10 cilia stop.....	50	10 cilia stop.....	30
	127.5		61

From these two experiments it appears probable that immunity remains as long as the killing fluid is not markedly weakened.

A study of Spirostomum shows a marked degree of similarity between its reaction and that of type F of Stentor. In both there was a well marked immunity which by the end of the fourth day had reached a degree of constancy.

The experiments just described show further that the immunity which was constant on the fourth to the seventh day was still present when tested at a much later date.

With this we may conclude the present study and pass to a consideration of another phase of the nature of immunity.

IV SPECIFICITY OF IMMUNITY

Ehrlich¹⁶ found that white mice which were immunized to *ricin* were still susceptible to another poison—that of *abrin*. The immunity conferred by the one substance in this case did not carry with it protection against a different substance. In other words its action was specific.

¹⁶ Ehrlich, P., 1891, Deutsche med. Wochenschrift no. 12 (ricin), no. 14 (abrin).

Whether the same specificity holds in the case of single cells where a lower degree of immunity obtains, is a question to which considerable interest attaches. The problem may be stated thus: Will *acclimatized* unicellular organisms, which show a stronger resistance to alcohol, also demonstrate an increased resistance when tested to a fatal dose of another and different substance?

To determine the point in question organisms which I have found could be rendered immune to ethyl alcohol have been tested: (1) to substances radically different from alcohol and (2) to substances in a way related to alcohol. In the first case normal and acclimatized animals of both *Stentor*¹⁷ and *Spirostomum* were tested to hydrochloric acid and to sodium hydroxide. In the second, they were subjected to other alcohols—methyl alcohol and glycerin.

In these studies attention has been directed to two things: First, to the physiological effects—that is, to what the organism did; and secondly, to the chemical effects, or to what changes the chemical produced.

The first point was to see whether normal and acclimatized animals acted in the same way or differently in the same killing medium. A second was to determine whether there was any difference in chemical effect upon the two sets—the acclimatized and control animals.

If such differences were noted either in behavior on the part of the organism or in action on the part of the chemical, a further proposition would be to see if any relation exists between the two.

A *The Action of Ethyl Alcohol (C₂H₅OH)*

As a standard for subsequent observation and experiment we may repeat earlier experiments in order to see what takes place when control and acclimatized animals are subjected to a fatal dose of ethyl alcohol.

Normal unacclimatized Stentors (type F) when thus subjected to a 6 per cent killing fluid showed slight or no bodily movement. At from 15 to 35 seconds there was a strong antero-lateral (aboral)

¹⁷ In this study when *Stentor* is mentioned type F is meant unless otherwise stated.

bulging and extrusion of the protoplasm, followed by a rapid loss of color. The body cilia ceased moving early, but the membranellæ continued with strong stroke until nearly the time of death.

Acclimatized Stentors, on the other hand, upon subjection to the 6 per cent alcohol usually remained motionless. Early distortion, then uncertain beat of cilia up to 45 seconds, was followed by an increase in ciliary activity. This finally became so vigorous as to shake the whole body mass of protoplasm. In this, as in our previous study, an extreme tenacity of life was manifest.

Thus both in behavior and in chemical action differences were produced. The relation the one bears to the other, however, is difficult to see.

Notwithstanding the fact that a stronger external effect was produced upon the acclimatized animals than upon the controls, the former survived a greater period of time in a lethal percentage of alcohol than did those of the control animals.

We may now examine the phenomena in acclimatized and control animals when hydrochloric acid is used as the killing fluid.

B The Action of Hydrochloric Acid (HCl)

I General Effects

Unacclimatized Stentors tested to an $\frac{M}{800}$ solution. In a concentration of this strength an early rotation was noted which ceased soon after injury began (15 to 30 seconds); the membranellæ stopped early. The body upon losing its color became brown. A little later contortions of the protoplasm were followed by a splitting away of the body mass from the cell wall and a forming of this mass into a coagulum.

After this action no ciliary motion was seen excepting in the buccal cavity.

Acclimatized Stentors. With the exception that a slightly greater activity was shown in these than in normal *Stentors* no difference either physiological or chemical could be detected.

The most striking phenomenon of the above study, observed both in normal and acclimatized animals, was the peculiar way in which ciliary activity was stopped. Just before death, pro-

nounced contortions of the protoplasm were the forerunners of a wave-like action which passed posteriorly, splitting away the endoplasm from the pellicula and forming of the endoplasm a typical coagulum. As a result of this action, all ciliary movement ceases, excepting that of the buccal pouch. (At this location, pellicula and endoplasm were not early separated.)

Destruction came about more rapidly in the case of acclimatized animals than of the controls; this may be seen from the following experiment upon resistance (Stentor). But the reason for a much earlier splitting and coagulum formation in the one case than in the other is by no means clear.

2 Effects Upon Resistance

In the following experiments upon both Stentor (type F) and Spirostomum, a notable difference was seen between normal and acclimatized animals when tested as to their endurance in a lethal dose of hydrochloric acid.

In both cases the acclimatized animals were reared in a 1 per cent medium of alcohol. These at the end of four days showed an increased resistance to 6 per cent alcohol. They were then tested to $\frac{M}{800}$ and $\frac{M}{100}$ concentrations of HCl, respectively.

Experiment XVI

RESISTANCE OF STENTOR AND SPIROSTOMUM TO HCl AFTER ACCLIMATIZATION IN A 1 PER CENT SOLUTION OF ALCOHOL

a Stentor			b Spirostomum		
Tested in $\frac{M}{800}$ Sol. HCl			Tested in $\frac{M}{100}$ Sol. HCl		
	A	C		A	C
	Acclimatized to Alcohol	Control		Acclimatized to Alcohol	Control
	Seconds	Seconds		Seconds	Seconds
Exp. 1 cilia stop.....	60	170	Exp. 1 cilia stop.....	150	150
2 cilia stop.....	210	210	2 cilia stop.....	160	160
3 cilia stop.....	180	230	3 cilia stop.....	140	140
4 cilia stop.....	50	180	4 cilia stop.....	180	180
5 cilia stop.....	40	140	5 cilia stop.....	160	235
6 cilia stop.....	40	285	6 cilia stop.....	155	150
7 cilia stop.....	40	270	7 cilia stop.....	140	160
8 cilia stop.....	50	195	8 cilia stop.....	200	180
9 cilia stop.....	70	390	9 cilia stop.....	145	260
10 cilia stop.....	45	420	10 cilia stop.....	160	170
	<hr/>	<hr/>		<hr/>	<hr/>
Average resistance.... =	78.5	249	Average resistance.... =	159	178.5

Both for Stentor and Spirostomum not only was there no increase in resistance of acclimated animals when tested to hydrochloric acid but there was—especially in Stentor—a clear and unmistakable weakening. Animals which normally resisted $\frac{M}{800}$ HCl for 249 seconds, if first accustomed to alcohol, showed an average endurance of only 78.5 seconds. Spirostomum, while showing less injury, in no case showed advantage by first being acclimatized to alcohol.

For Spirostomum it will be noticed that a much lower susceptibility to HCl was shown. Although its controls were tested in a medium eight times as concentrated as that used for Stentor, they gave a resistance period almost as long as did normal animals of Stentor; while its acclimatized animals were much more resistant to this solution than were similar acclimatized Stentors in the much weaker solution.

This lack of susceptibility to acid on the part of Spirostomum has in large part its explanation in the contour of the cell. In Stentor it was seen that in the formation of the coagulum the large rounded mass of endoplasm was drawn away from the pellicula, and that this separation is what causes the cessation of ciliary movement. In Spirostomum, however, the mass of endoplasm is long and columnar and forms into a coagulum more slowly and with a much less destructive effect. The coagulum in passing along the body becomes shorter and thicker. This rounding together with slight constrictions in the cell wall impedes its course, thus allowing the posterior cilia to continue beating often for long periods of time.

Thus we see that while the formation of a coagulum is destructive to Stentor, the same process gives advantages to Spirostomum when tested to a fatal percentage of hydrochloric acid.

C The Action of Sodium Hydroxide (NaOH)

I General Effects

Normal unacclimatized Stentors in a solution of $\frac{M}{100}$ NaOH gave the following characteristic reactions: Slight movement for a brief time (15 seconds) followed by a loss of the membranellæ

and a prominent protrusion of the membranellar plates. Color—a beautiful sea green—extruded. Body usually burst and rapid destruction followed—the cilia remaining active as long as a particle of form remained.

Acclimatized Stentors. Stentors which had been acclimatized in 1 per cent alcohol, upon subjection to $\frac{M}{100}$ NaOH turned rapidly around and around for a few seconds. The body wall then gave way and destruction followed with extreme rapidity.

In a comparison of acclimatized and unacclimatized Stentors two differences are noticed. Acclimatized animals show a greater activity upon subjection to sodium hydroxide and this chemical acts with greater rapidity upon the acclimatized forms.

The most notable thing observed in the study of sodium hydroxide was in relation to the pellicular membrane. If the pellicula remained intact, life was often prolonged for a remarkable period of time; if on the other hand the pellicular wall gave way, the cell was dissolved with extreme rapidity—leaving only traces of protoplasmic granules in the surrounding medium.

Rapidity of death to those animals which have remained for a brief period of time in alcohol has a possible explanation in the fact, previously noted, that acclimatized Stentors, even in alcohol, show an early distortion. A rupture of the pellicula in NaOH means immediate death. If the process of acclimatization to alcohol makes a rupture of this sort more probable, it would naturally follow that if the organisms are first subject to a weak percentage of alcohol and then tested to a fatal dose of sodium hydroxide they would meet an earlier death. This is in agreement with what is seen in Experiment XVII.

2 Effects upon Resistance

In the following experiment acclimatized and unacclimatized animals of both Stentor and Spirostomum were tested to see the period of time that they could withstand an $\frac{M}{100}$ solution of sodium hydroxide:

Experiment XVII

RESISTANCE OF STENTOR AND SPIROSTOMUM TO $\frac{M}{100}$ NaOH AFTER ACCLIMATIZATION IN 1 PER CENT ALCOHOL

a Stentor			b Spirostomum		
	A	C		A	C
	Acclimatized to 1 Per Cent Alcohol	Control		Acclimatized to 1 Per Cent Alcohol	Control
	Seconds	Seconds		Seconds	Seconds
Exp. 1 cilia stop.....	90	220	Exp. 1 cilia stop.....	35	30
2 cilia stop.....	180	225	2 cilia stop.....	40	30
3 cilia stop.....	135	110	3 cilia stop.....	20.	35
4 cilia stop.....	215	420	4 cilia stop.....	20	20
5 cilia stop.....	60	270	5 cilia stop.....	25	30
6 cilia stop.....	90	45	6 cilia stop.....	30	35
7 cilia stop.....	195	255	7 cilia stop.....	25	50
8 cilia stop.....	45	220	8 cilia stop.....	20	60
9 cilia stop.....	130	330	9 cilia stop.....	35	40
10 cilia stop.....	60	225	10 cilia stop.....	40	60
	—	—		—	—
Average resistance. =	126	232	Average resistance. =	29	39

It will be seen that Stentors are much less susceptible to sodium hydroxide than they were to hydrochloric acid. In a solution of NaOH eight times as concentrated ($\frac{M}{100}$) practically the same control resistance was shown as in ($\frac{M}{800}$) HCl (232 seconds, 249 seconds respectively). But that this is in no sense general for single cells may be seen from Spirostomum, which was more resistant to the acid than to an equal concentration of the base.

This similarity of susceptibility to equal concentrations of acid and base was not in Spirostomum due alone to the retarding action of the coagulum in acids, but partly also to the fact that in bases the body burst early and disintegrated with great rapidity.

In both of the foregoing studies acclimatized animals which gave an increased resistance to alcohol, when tested either to hydrochloric acid or to sodium hydroxide showed no such increase. On the contrary they invariably demonstrated a lower degree of endurance. Thus the immunizing action of the alcohol was in these cases clearly specific.

We shall now turn to a consideration of the second group of substances.

Whether animals acclimatized to weak concentrations of alcohol have gained a benefit which will help them when tested to a fatal dose of a substance kindred to alcohol is a question of closer interest. We shall first study this in one of the lower alcohols.

D *The Action of Glycerin* $C_3H_5(OH)_3$

I General Effects

Normal unacclimatized Stentors. Subjected to a molecular concentration of glycerin ($\frac{M}{7}$) the animals remained motionless for an instant, then suddenly began backing and contracting rapidly. Membranellæ became non-functional, usually within 45 seconds. The peristome (membranellæ) was soon lost. Signs of plasmolysis—especially in the posterior part of the body—followed. The color was retained to a marked degree. Long after the membranellæ had stopped beating the body cilia continued in activity (the opposite effect from that of ethyl alcohol).

Stentors acclimatized in 1 per cent alcohol. In the same concentration of glycerine these gave reactions which could not be distinguished from those described above.

A single peculiarity in acclimatized animals may be mentioned. In a number of cases these assumed a characteristic pipe-shaped appearance, similar to that seen when normal Stentors were kept in water of very great purity.

The most characteristic phenomenon observed from the action of glycerin was the loss of the peristome or membranellæ. This was noted alike in acclimatized and unacclimatized animals and in solutions varying in concentration from a molecular solution to a concentration of one-fourth molecular strength.

The first signs of injury to the organism came as a stoppage of these peristomal cilia. The peristome then became detached in a ribbon-like fashion and either hung from a point of attachment or, as was more usual, was entirely lost.

A phenomenon of great interest was the regeneration of the peristome after its loss in the manner just described. In a sub-lethal concentration those animals which gave off the peristome in the afternoon had by the following morning regenerated a new one.

Johnson¹⁸ has shown that the process of regeneration in Stentor is similar to what occurs in the intricate process of division. In the cases of loss of the peristome which I have just described, however, no active condensing and separating of the nodes of the meganucleus took place. A part of the body simply constricted off and the meganuclear nodes were seemingly undisturbed.

2 Effects upon Resistance

The animals in the following experiment were reared in 1 per cent alcohol and then tested in comparison with control specimens to a molecular solution of glycerin:

Experiment XVIII

RESISTANCE OF STENTOR AND SPIROSTOMUM TO $\frac{M}{T}$ GLYCERIN, AFTER ACCLIMATIZATION IN 1 PER CENT ALCOHOL

a Stentor			b Spirostomum		
	A	C		A	C
	Acclimatized to	Control		Acclimatized to	Control
	1 per cent			1 per cent	
	Alcohol			Alcohol	
	Seconds	Seconds		Seconds	Seconds
Exp. 1 cilia stop.....	180	240	Exp. 1 cilia stop	120	240
2 cilia stop.....	240	450	2 cilia stop.....	240	180
3 cilia stop.....	150	255	3 cilia stop.....	150	240
4 cilia stop.....	120	330	4 cilia stop.....	180	300
5 cilia stop.....	100	285	5 cilia stop.....	180	200
6 cilia stop.....	135	300	6 cilia stop.....	210	240
7 cilia stop.....	205	250	7 cilia stop.....	180	240
8 cilia stop.....	190	340	8 cilia stop.....	200	180
9 cilia stop.....	150	225	9 cilia stop.....	180	250
10 cilia stop.....	165	300	10 cilia stop.....	210	240
	<hr/>	<hr/>		<hr/>	<hr/>
Average resistance. =	163.5	297.5	Average resistance. =	185	231

While, as we have before seen, no difference either in behavior or in chemical action could be detected as between unacclimatized and acclimatized animals, yet in this study on comparative resistance a difference was noticed. In a solution of the above strength both cases gave clear evidence of the specificity of the immunity

¹⁸ Johnson, Herbert P., 1893, Jour. of Morphol., viii, pp. 467-562.

due to acclimatization in 1 per cent alcohol. The resistance to $\frac{M}{4}$ glycerin was decreased by remaining in alcohol.

In a weaker solution, however, while *Spirostomum* showed a similar specificity, *Stentor* was far less regular. In an $\frac{M}{2}$ solution in one case it showed a slight advantage in its acclimatized animals ($A = 516''$, $C = 462''$). Study in a weaker solution ($\frac{M}{4}$) gave results still more difficult to interpret. Animals reared in 1 per cent alcohol gave a resistance to $\frac{M}{4}$ glycerin of 1293 seconds; those in 0.5 per cent, 1696 seconds, and those reared in normal culture medium, 1600 seconds.

Even in these cases a certain degree of specificity of immunity is evident, for in no place is there a degree of increase in the resistance to glycerin approximating that given to ethyl alcohol.

E The Action of Methyl Alcohol (CH_3OH)

I General Effects

In methyl alcohol, a lower member of the alcohol group, the following condition was found:

Normal unacclimatized Stentors subjected to an 8 per cent solution: Movement slight or animal altogether quiet; body bulging antero-laterally much as in the case of ethyl alcohol. Loss of body color; strongly marked distortion in 80 to 105 seconds; membranellæ around groove persistent; frontal field retaining color and its cilia active after the posterior part of the body was colorless.

Acclimatized Stentors. *Stentors* acclimatized in 1 per cent ethyl alcohol when subjected to 8 per cent methyl alcohol showed the following effects:

Early movement; membranellæ stopped somewhat as in glycerin; an occasional animal with membranellæ lost, but the peristome was not cast off in a ribbon-like band as occurred in glycerin.

Slight, if any, difference could be seen in the behavior of the acclimatized and the control animals in the above comparison. In both, the membranellæ had a resistance mid-way between that shown in ethyl alcohol and in glycerin.

A considerable difference was seen between the action of methyl alcohol and that of glycerin upon the color and cilia of the frontal field. Both color and ciliary activity of this region were long retained in methyl alcohol while in the glycerin both were lost at a comparatively early time.

2 Effects upon Resistance

In Stentor and Spirostomum, the comparative resistance for both normal and acclimatized animals is shown in Experiment XIX which follows. In this Stentor was tested to an 8 per cent concentration and Spirostomum to a 10 per cent solution of methyl alcohol.

Experiment XIX.

RESISTANCE OF STENTOR AND SPIROSTOMUM TO METHYL ALCOHOL, AFTER LIVING IN 1 PER CENT ETHYL ALCOHOL

a Stentor			b Spirostomum		
Tested to 8 Per Cent CH ₃ OH			Tested to 10 Per Cent CH ₃ OH		
	A	C		A	C
	Acclimatized to 1 per cent Ethyl Alcohol	Control		Acclimatized to 1 per cent Ethyl Alcohol	Control
	Seconds	Seconds		Seconds	Seconds
Exp. 1 cilia stop.....	480	240	Exp. 1 cilia stop.....	25	25
2 cilia stop.....	240	360	2 cilia stop.....	50	35
3 cilia stop.....	180	240	3 cilia stop.....	20	30
4 cilia stop.....	270	105	4 cilia stop.....	45	30
5 cilia stop.....	120	270	5 cilia stop.....	70	80
6 cilia stop.....	210	360	6 cilia stop.....	35	40
7 cilia stop.....	180	300	7 cilia stop.....	25	60
8 cilia stop.....	360	270	8 cilia stop.....	30	30
9 cilia stop.....	180	180	9 cilia stop.....	60	50
10 cilia stop.....	180	270	10 cilia stop.....	45	65
	—	—		—	—
	240	259.5		40.5	44.5

Thus remaining in ethyl alcohol did not increase the resistance to methyl alcohol. In both animals, indeed, the resistance to the methyl alcohol was slightly decreased by previous subjection to ethyl alcohol. The immunity due to the latter is in this case also specific.

While in glycerin and methyl alcohol there was often little evidence of decrease in resistance due to the previous acclimatization in ethyl alcohol, there was clearly no marked advantage or increase of resistance due to this cause. In both acid and alkali, on the other hand, the resistance of the animals was lowered in a marked degree by previous acclimatization to ethyl alcohol, although this had greatly increased the resistance to alcohol itself. This demonstrates in the clearest way the specificity of the immunity due to a residence in alcohol.

V SUMMARY AND CONCLUSIONS

The foregoing investigations consist of a study of the acclimatization of infusoria to ethyl alcohol, and the effects of this acclimatization on their resistance to other chemicals.

1 In certain strains of *Stentor cœruleus*, and in *Spirostomum ambiguum*, it was found that living for a few days in 1 per cent ethyl alcohol increases the resistance of the animals to a stronger solution of the same substance—ethyl alcohol. This increased resistance is shown (1) in the fact that the organisms are not so quickly killed in a lethal solution, (2) in the fact that they may continue to live in a solution stronger than that in which they could live before acclimatization.

2 Different species of infusoria and different strains of the same species, living under dissimilar environmental conditions showed various degrees of normal resistance to alcohol, and very different capacities for becoming acclimatized to it.

In *Stentor cœruleus* one strain designated as E manifested a high normal resistance, but this resistance was increased little or not at all by remaining in 1 per cent alcohol; while another strain F had a low normal resistance which was readily increased by living in a weak acclimatizing medium.

Incidentally, similar differences in the resistance of different sorts of infusoria to other chemicals were observed. Thus, *Spirostomum* withstood about eight times as concentrated a solution of hydrochloric acid as did *Stentor*. Marked differences are likewise observable among individuals of the same culture when tested for resistance to different chemicals.

3 Acclimatization to alcohol is shown not alone in an increase of resistance to a stronger solution but in changes in the behavior of the organisms. The unacclimatized animal responds to the stronger chemical by powerful motor reactions while the acclimatized organism shows much slighter activity.

4 In a weak solution of alcohol (1 per cent) the beginning of acclimatization is usually evident within a few hours. This increases in a fairly uniform ratio until about the fourth day, at which time a maximum degree of immunity may be expected.

5 The degree of resistance produced corresponds in a measure to the strength of the alcohol used as an acclimatizing medium. As compared with the resistance produced by a 1 per cent medium that due to $\frac{1}{2}$ per cent is lower in degree. In a medium much stronger than 1 per cent the correspondence does not hold, since stronger solutions decrease the resistance by producing injury to the organism.

6 The fact that in these experiments some strains show little or no capacity for becoming acclimatized to alcohol although tried for long periods of time and with refined methods makes it questionable whether acclimatization takes place so readily and to so high a degree as is commonly supposed.

Dr. Jennings informs me that extensive work in other chemicals carried on under his direction points to the same conclusion that I have just set forth—much of the work having given entirely negative results.

7 Tolerance, or acclimatization, to ethyl alcohol does not increase the resistance of the organisms to other chemicals. On the contrary it usually renders the animals *less* resistant to other agents. This matter was studied in detail in *Stentor* and *Spirostomum* for an acid, an alkali, and for two substances belonging to the group of alcohols, namely, glycerin and methyl alcohol. In all cases the animals which had acquired an increased resistance to ethyl alcohol as a result of living in a 1 per cent solution showed no increase or an actual decrease of resistance to other chemicals. Thus the immunity produced by ethyl alcohol is specific; it does not produce protection against all chemicals.

2852 4



QL
1
J68
v.6
cop.2

1909
Biological
& Medical
Serials

The Journal of experimental
zoology

PLEASE DO NOT REMOVE
CARDS OR SLIPS FROM THIS POCKET

UNIVERSITY OF TORONTO LIBRARY

