

Digitized by the Internet Archive
in 2009 with funding from
University of Toronto

39

THE JOURNAL

OF

EXPERIMENTAL ZOÖLOGY

EDITED BY

WILLIAM E. CASTLE

Harvard University

EDWIN G. CONKLIN

Princeton University

CHARLES B. DAVENPORT

Carnegie Institution

HORACE JAYNE

The Wistar Institute

HERBERT S. JENNINGS

Johns Hopkins University

FRANK R. LILLIE

University of Chicago

JACQUES LOEB

Rockefeller Institute

THOMAS H. MORGAN

Columbia University

GEORGE H. PARKER

Harvard University

EDMUND B. WILSON,

Columbia University

and

ROSS G. HARRISON, Yale University

Managing Editor

VOLUME 11

1911

122350

10 15-112

THE WISTAR INSTITUTE OF ANATOMY AND BIOLOGY
PHILADELPHIA, PA.

QL
1
J68
v. 11
cap. 2

CONTENTS

1911

No. 1. JULY 5

- H. S. JENNINGS. Assortative mating, variability and inheritance of size, in the conjugation of *Paramecium*. Sixteen figures..... 1
- LORANDE L. WOODRUFF AND GEORGE A. BAITSELL. The reproduction of *Paramecium aurelia* in a 'constant' culture medium of beef extract. Two figures..... 135

No. 2. AUGUST 20

- RUTH B. HOWLAND. Migration of retinal pigment in the eyes of *Branchipus gelidus*. Four figures..... 143
- DAVENPORT HOOKER. The development and function of voluntary and cardiac muscle in embryos without nerves. Fifteen figures..... 159

No. 3. OCTOBER 5

- C. M. CHILD. Studies on the dynamics of morphogenesis and inheritance in experimental reproduction. II. Physiological dominance of anterior over posterior regions in the regulation of *Planaria dorotocephala*. Twenty-one figures..... 187
- C. M. CHILD. Studies on the dynamics of morphogenesis and inheritance in experimental reproduction. III. The formation of new zooids in *Planaria* and other forms. Thirty-six figures..... 221
- H. V. WILSON. On the behavior of the dissociated cells in Hydroids, *Acyonaria* and *Asterias*. Thirty figures..... 281

No. 4. NOVEMBER 20

LORANDE LOSS WOODRUFF AND GEORGE ALFRED BAITSELL. Rhythms in the reproductive activity of Infusoria. Thirteen charts.....	339
G. H. PARKER AND H. M. PARSHLEY. The reactions of earthworms to dry and to moist surfaces.....	361
T. H. MORGAN. An attempt to analyze the constitution of the chromosomes on the basis of sex-limited inheritance in <i>Drosophila</i> . One colored plate (four figures).....	365
E. J. LUND. On the structure, physiology and use of photogenic organs, with special reference to the Lampyridae. Nine figures.....	415
STEWART PATON. Experiments on developing chicken's eggs.....	469

INDEX

- A**LCYONARIA and Asterias, On the behavior of the dissociated cells in hydroids, 281.
- Asterias, On the behavior of the dissociated cells in hydroids, Aleyonaria and, 281.
- B**AITSELL, G. A., L. L. WOODRUFF and. The reproduction of *Paramecium aurelia* in a 'constant' culture medium of beef extract, 135.
- BAITSELL, G. A., L. L. WOODRUFF and. Rhythms in the reproductive activity of Infusoria, 339.
- Beef extract, The reproduction of *Paramecium aurelia* in a 'constant' culture medium of, 135.
- Branchipus gelidus*, Migration of retinal pigment in the eyes of, 143.
- C**ARDIAC muscle in embryos without nerves. The development and function of voluntary and, 159.
- Cells in hydroids, Aleyonaria and Asterias, On the behavior of the dissociated, 281.
- Chickens' eggs, Experiments on developing, 469.
- CHILD, C. M. Studies on the dynamics of morphogenesis and inheritance in experimental reproduction. II. Physiological dominance of anterior over posterior regions in the regulation of *Planaria dorotocephala*, 187.
- III. The formation of new zooids in *Planaria* and other forms, 221.
- Chromosomes on the basis of sex-limited inheritance in *Drosophila*. An attempt to analyse the constitution of the, 365.
- Conjugation of *Paramecium*, Assortative mating, variability and inheritance of size, in the, 1.
- Culture medium of beef extract, The reproduction of *Paramecium aurelia* in a 'constant,' 135.
- D**OMINANCE of anterior over posterior regions in the regulation of *Planaria dorotocephala*. II. Physiological, 187.
- Drosophila*, An attempt to analyse the constitution of the chromosomes on the basis of sex-limited inheritance in, 365.
- Dynamics of morphogenesis and inheritance in experimental reproduction, Studies on the, 187, 221.
- E**ARTHWORMS to dry and to moist surfaces. The reactions of, 361.
- Eggs, Experiments on developing chickens, 469.
- Eyes of *Branchipus gelidus*, Migration of retinal pigment in the, 143.
- H**OOKER, DAVENPORT. The development and function of voluntary and cardiac muscle in embryos without nerves, 159.
- HOWLAND, RUTH B. Migration of retinal pigment in the eyes of *Branchipus gelidus*, 143.
- Hydroids, Aleyonaria and Asterias, On the behavior of the dissociated cells in, 281.
- I**NFUSORIA, Rhythms in the reproductive activity of, 339.
- Inheritance in *Drosophila*, An attempt to analyse the constitution of the chromosomes on the basis of sex-limited, 365.
- Inheritance in experimental reproduction, Studies on the dynamics of morphogenesis and, 187, 221.
- Inheritance of size in the conjugation of *Paramecium*, Assortative mating, variability and, 1.
- J**ENNINGS, H. S. Assortative mating, variability and inheritance of size, in the conjugation of *Paramecium*, 1.
- L**AMPYRIDAE, On the structure, physiology and use of photogenic organs, with special reference to the, 415.
- LEND, E. J. On the structure, physiology and use of photogenic organs, with special reference to the Lampyridae, 415.
- M**IGRATION of retinal pigment in the eyes of *Branchipus gelidus*, 143.
- MORGAN, T. H. An attempt to analyse the constitution of the chromosomes on the basis of sex-limited inheritance in *Drosophila*, 365.

- Morphogenesis and inheritance in experimental reproduction, Studies on the dynamics of, 187, 221.
- Muscle in embryos without nerves, The development and function of voluntary and cardiac, 159.
- P**ARAMECIUM, Assortative mating, variability and inheritance of size in the conjugation of, I. *Paramecium aurelia* in a 'constant' culture medium of beef extract, The reproduction of, 135.
- PARKER, G. H. and PARSHLEY, H. M. The reactions of earthworms to dry and to moist surfaces, 361.
- PARSHLEY, H. M., PARKER, G. H. and. The reactions of earthworms to dry and to moist surfaces, 361.
- PATON, STEWART. Experiments on developing chickens' eggs, 469.
- Photogenic organs, with special reference to the Lampyridae, On the structure, physiology and use of, 415.
- Planaria and other forms, III. The formation of new zooids in, 221.
- Planaria dorotocephala, II. Physiological dominance of anterior over posterior regions in the regulation of, 187.
- R**EGULATION of Planaria dorotocephala, II. Physiological dominance of anterior over posterior regions in the, 187.
- Reproduction of *Paramecium aurelia* in a 'constant' culture medium of beef extract, 135.
- Reproduction, Studies on the dynamics of morphogenesis and inheritance in, experimental, 187, 221.
- Reproductive activity of Infusoria, rhythms in the, 339.
- Retinal pigment in the eyes of *Branchipus gelidus*, migration of, 143.
- Rhythms in the reproductive activity of Infusoria, 339.
- S**EX-LIMITED inheritance in *Drosophila*, An attempt to analyse the constitution of the chromosomes on the basis of, 365.
- V**OLUNTARY and cardiac muscle in embryos without nerves, The development and function of, 159.
- W**ILSON, H. V., On the behavior of the dissociated cells in hydroids, Alcyonaria and Asterias, 281.
- WOODRUFF, L. L. and G. A. BAITSELL. Rhythms in the reproductive activity of Infusoria, 339.
- WOODRUFF, L. L. and G. A. BAITSELL. The reproduction of *Paramecium aurelia* in a 'constant' culture medium of beef extract, 135.
- Z**OIDS in Planaria and other forms. III. The formation of new, 221.

ASSORTATIVE MATING, VARIABILITY AND INHERITANCE OF SIZE, IN THE CONJUGATION OF PARAMECIUM¹

H. S. JENNINGS

From the Zoological Laboratory, Johns Hopkins University

SIXTEEN FIGURES

CONTENTS

Problems outlined.....	3
I. The facts as to relative size, variability, and assortative mating in conjugation.....	6
Methods.....	7
Fundamental measurements.....	9
Relative size of conjugants and non-conjugants.....	11
Relative variability of conjugants and non-conjugants.....	16
Causes of the lessened variability of conjugants.....	17
1 Gametic differentiation.....	17
2 Equalization.....	18
3 Growth.....	18
Increase in size and variability of the conjugants before fission.....	20
4 Racial differences.....	22
Assortative mating.....	23
Pearl's explanation.....	23
Observation of the process of conjugation.....	24
Correlation in size in the members of pairs of conjugants.....	28
Meaning of the coefficients of correlation.....	28
Correlation in different classes of cultures.....	37
Wild cultures, of unknown racial composition.....	37
Cultures containing pairs belonging to two different species.....	39
Conjugation within pure races.....	41
Mixtures of two known races.....	44
To what is due the incompleteness of correlation?.....	46
1 Slight differences of less effect than great ones.....	46
2 Different categories of pairs following different rules.....	51
Unevenness at the anterior ends.....	52

¹ Third of a series of papers on Heredity, Variation and Evolution in Protozoa.

Causes of the correlation.....	60
1 Assortative mating.....	60
a Correlation between the length anterior to the mouth and the total length.....	61
b High variability of the posterior region.....	63
c Low correlation of parts before and behind mouth.....	64
d Correlation of pairs greater for parts anterior to mouth.....	64
e Low correlation of parts posterior to mouth.....	64
f Region in front of the point where the two conjugants separate....	65
2 Equalization during mating.....	65
Correlation of pairs after separation.....	67
Change in variability and correlation of parts after separation.....	70
Correlation of pairs not due to equalization.....	73
3 Change of size during union.....	74
4 Differential contraction due to killing fluid.....	77
5 Local or temporal differentiations in the culture.....	80
6 Other suggested causes.....	82
7 Correlation in breadth.....	82
a Flattening at the time of conjugation.....	83
b Correlation in breadth in pairs after separation.....	84
c Correlation in breadth not due to equalization.....	85
8 Historical and comparative.....	85
9 Conclusions on assortative mating.....	89
II Consequences of the differentiation of the conjugants and of their assortative mating.....	89
Consequences of the decreased size and lessened variability.....	90
1 Are the extreme specimens excluded from the new generation?.....	90
2 Relative size of progeny of conjugants and non-conjugants; changes in size due to conjugation.....	92
a Comparison of progeny of conjugants and non-conjugants in pure races.....	93
b Comparison of progeny of conjugants and non-conjugants in a wild culture.....	97
Historical.....	100
c Exceptional case.....	101
d Summary.....	103
3 Increase in variability as a result of conjugation.....	104
4 Do pairs of different size give progeny of different size?.....	104
5 Inheritance from unequal pairs.....	106
Summary.....	106
Literature cited.....	109
Appendix: tables of measurements.....	110

INDEX OF TABLES

1.....	9	18.....	62
2.....	10	19.....	69
3.....	11	20.....	72
4.....	12	21.....	73
5.....	12	22.....	75
6.....	17	23.....	76
7.....	21	24.....	76
8.....	32	25.....	79
9.....	36	26.....	84
0.....	40	27.....	84
11.....	47	28.....	94
12.....	50	29.....	95
13.....	54	30.....	96
14.....	55	31.....	97
15.....	56	32.....	99
16.....	57	33.....	102
17.....	59	34-68, Appendix.....	110

PROBLEMS OUTLINED

The second paper of this series dealt with variation and inheritance of size in *Paramecium* during reproduction by fission. The present paper is an experimental and observational study of the size relations in conjugation. A later contribution will deal with the relation of conjugation to vitality and reproduction.

Results presented with biometrical analysis have unfortunately come to incur in many quarters the suspicion that mathematical treatment has been substituted for accurate experimental and observational investigation. The numerical analysis of results should of course be an addition, not a substitution; but the experimenter should realize that without this addition experimental results may sometimes be as misleading as statistics without experimentation ("which is putting it strong"). Adequate experimentation with adequate numerical analysis is the ideal; toward this ideal my efforts, however short they may fall, have been directed in the present investigation.

In taking up the relation of conjugation to genetic problems, I have thought it best to become acquainted at first hand, so

far as possible, not only with matters that have not been hitherto treated, but even with those that have been dealt with by previous investigators, in the latter case confirming or criticizing their results. This does not imply a precedent suspicion as to the accuracy of the work thus gone over; it is done only in pursuance of a general policy, for one often finds matters of great import where they are least expected. Furthermore, the recent discovery of the existence of many diverse races in *Paramecium* makes it needful to reëxamine many phenomena in relation to the part played in them by these different races. In any case, in this difficult field independent confirmation of another's results is decidedly worth while.

It will be well to set forth here an outline of the questions with which a thorough investigation of the size relations in conjugation would have to deal.

To Pearl ('07) we owe the discovery of certain most interesting relations between the conjugating individuals of *Paramecium*. By an elaborate statistical investigation he showed (1) that the conjugants of a culture of *Paramecium* are much less variable than the non-conjugating population, and have (as had before been noticed) a smaller mean size; (2) that there is a marked degree of correlation in size between the members of pairs in *Paramecium*; smaller individuals being found mated with smaller, larger with larger. With these important matters, particularly in their relation to the existence of diverse races, we shall have to deal thoroughly. The precise questions here are as follows:

1. What are the facts as to the relative variability and size of conjugants and non-conjugants, and what is their relation to the existence of races of diverse size?

2. What are the facts as to assortative mating; its determining conditions, its peculiarities and limitations; its relation to the existence of diverse races?

3. What are the results, in inheritance, variability and evolution, of the smaller size and decreased variability of the conjugants, as compared with the non-conjugants? If we breed from a number of the conjugants, do they give progeny that are (a) smaller, or (b) less variable, than the progeny of the larger, more

variable non-conjugants? Does conjugation thus act as a process of excluding from the line of evolution individuals that vary from the usual size?

4. What are the results, in inheritance, variability and evolution, of the assortative mating of *Paramecium*? If we isolate (a) large, and (b) small, pairs of conjugants, keeping them under identical conditions, do they produce, respectively, large and small races? Is there any difference between the progeny of (a) pairs in which the two members are equal, and (b) pairs in which the two members are unequal?

5. What relation has conjugation as a physiological process to the size of the individuals of the stock undergoing it? Does the size differ characteristically in different parts of the life cycle, as is sometimes set forth? Are the individuals at the end of the life cycle (just before conjugation) larger or smaller than those at the beginning of the cycle (just after conjugation)?

6. What are the facts of inheritance in conjugation? If the two conjugants of a pair differ, are the progeny of these two conjugants alike and intermediate between the two? Or will for example the larger member continue to produce large individuals like itself, the small one small individuals like itself? Or is there some third possibility? The laws of inheritance have never been worked out for this peculiar reciprocal fertilization, where both parents may continue reproduction.

These questions we shall take up in detail. On most of them I hope to present data of importance, though on the extremely important problem last raised I have as yet been unable to get clear results on some of the points of greatest interest.

In dealing with most of these questions, the existence of diverse races of *Paramecia*, as set forth in former papers,² will be found of extreme importance. In *Paramecia* multiplying by fission there are many races or lines, differing in size and in other respects. A considerable number of these races were isolated; the mean length of the largest being more than double that of the smallest, with many intermediate races. As will be recalled, each race

² See Jennings '08, and Jennings and Hargitt '10.

shows within itself many variations, due to differences in growth and environmental action, but these variations within the race are not as a rule inherited, and under the same conditions of growth and environment the race is uniform and constant. In all work with conjugation, the question whether we are dealing with a pure race or with a mixture of races is of the greatest importance; the significance of the phenomena observed is quite different in the two cases.

I. THE FACTS AS TO RELATIVE SIZE, VARIABILITY AND ASSORTATIVE MATING IN CONJUGATION

The data given by Pearl ('07) would seem amply sufficient to show that in a conjugating culture the conjugants are smaller and less variable than the non-conjugant population, and that there is a high degree of assortative mating in *Paramecium*. A further study of the facts is needed, however. On the one hand it is desirable that Pearl's interesting results should be confirmed by independent observation, or refuted. The correctness of some of his results has been called in question (Lister '06, Pearson '06, Pearl '07). Further, there are a number of conditions not dealt with by Pearl that might produce a correlation in size between the members of pairs; these need to be subjected to experimental test. Beyond this, many important relations in this matter remain as yet unknown; we need a knowledge of the variations and limitations of assortative mating, of the conditions on which it depends, of its relation to the existence of diverse races, and particularly of its consequences in the later history of the stock.

I have therefore examined and made measurements of a number of conjugating cultures with reference to these matters. After a number of cultures had thus been studied, it became necessary to test by comparative examination of cultures under controlled conditions, one after another, many factors that suggested themselves as possibly producing the observed relations (particularly the correlation between members of pairs). As a result, the quantity of material available for study of these matters becomes

very great, consisting of more than thirty lots, averaging more than one hundred pairs each. Some of these lots were 'wild' cultures, containing a number of diverse lines or races, belonging in some cases all to caudatum or all to aurelia; in other cases belonging partly to caudatum, partly to aurelia. Other lots consisted entirely of members of a single race or 'pure line,' having descended from a single individual; other lots consisted of mixtures of two known races. The relations observed are naturally somewhat different in these diverse cases. I have dealt mainly with the measurements of length, since it is here that the phenomena of primary importance appear; certain studies of the breadth relations will however be found on later pages (table 20).

METHODS

The special methods for the diverse experiments will be mentioned in the course of the paper. Here it will be well to mention mainly the methods of killing and of measurement.

The animals to be measured were brought into a drop of water at the bottom of a watch-glass, then overwhelmed with the killing fluid. For killing I used mainly Worcester's fluid (10 per cent formalin saturated with corrosive sublimate). I have later found that chrom-osmic acid (1 per cent osmic in 1 per cent chromic) has advantages in some respects. Both these fluids kill without distortion if properly used. The animals were measured either in the killing fluid, or after transference to water or to 25 per cent glycerine. Careful comparative measurements before and after transference showed that no change is made by placing in water or weak glycerine. The most satisfactory method is to remove with pipette a portion of the killing fluid from the watch glass, then to add 25 per cent glycerine; in this the specimens are kept till measured. With the Worcester's fluid there is sometimes an objectionable deposit of fine crystals, in the course of time; this does not happen with the chrom-osmic.

In the early part of the work the animals were measured on the slide, with the ocular micrometer. This becomes very wearing

on the eyes; later the measurements were made by the aid of the Edinger drawing and projection apparatus, which cannot be too highly recommended for the purpose. The animals are projected much enlarged, on the drawing board, where they are measured with a millimeter ruler. I used a magnification of 500 diameters, so that each millimeter of the ruler corresponded to 2 microns (0.002 mm.). The best method I found to be as follows: the animals were placed on a thin slide in a flat drop of the 25 per cent glycerine, with no cover (so that there was no danger of flattening), projected, and measured. Without the glycerine in the fluid this method cannot be used, owing to the convection currents and the rapid evaporation produced.

In the measurements of conjugants the unit of grouping was 4 microns, so that each group in the tables contains individuals varying from 2 microns below to 2 microns above the dimension at the head of the column or row. In the original measurements, in many cases, the unit employed was but 2 microns.

The constants of variation were computed according to the methods and formulae set forth in my paper of 1908 (page 397). In the present paper however we are dealing with cases where the two things to be compared (the two members of a pair) are alike, so that either one might be entered in the rows or in the columns of the correlation table. In such cases double or symmetrical tables have commonly been employed. In a recent note ('11) I have shown that this is unnecessary, and that the computations are performed with much less labor without the use of symmetrical tables. The method of computation set forth in this note was used in the present paper. In accord with this, I have formed the tables of correlation by entering in every case the larger member of the pair in the vertical columns, the smaller in the horizontal rows.

FUNDAMENTAL MEASUREMENTS

Table 1 gives the important constants for the length of conjugants as compared with non-conjugants in a number of cultures developed in material brought into the laboratory from ponds or pools, so that the racial composition is unknown. Table 2 gives the same constants for cultures consisting entirely of a single 'pure line' or race,—all the individuals being derived from the fission of a single one; also those for certain mixtures of known races. Table 3 gives the constants for a number of lots of con-

TABLE 1

Constants of variation in length for conjugants and non-conjugants of Paramecium, from wild cultures, of unknown racial composition. (The original measurements of length for all these will be found in table 34 of the appendix; the tables of correlation for the conjugants, in the appendix, are indicated in the column headed 'table')

LOT	DATE		NUMBER OF INDIVIDUALS	NUMBER OF PAIRS	TABLE	RANGE OF VARIATION IN MICRONS	MEAN LENGTH IN MICRONS	STANDARD DEVIATION IN MICRONS	COEFFICIENT OF VARIATION	COEFFICIENT OF CORRELATION BETWEEN MEMBERS OF PAIRS
A. "Wild" cultures										
1	Nov. 4, '07	a. Conjugants.....	360	180	11	148-260	199.02±0.54	15.28±0.38	7.68±0.19	0.398±0.030
		b. Non-conjugants ..	360		34	132-320	222.86±0.87	24.57±0.62	11.03±0.28	
2	June 20, '09	a. Conjugants.....	284	142	36	130-206	165.04±0.53	13.20±0.37	8.00±0.23	0.268±0.057
		b. Non-conjugants....	87		34	134-198	164.12±1.00	13.84±0.71	8.43±0.43	
3	Dec. 13, '07	a. Conjugants	164	82	37	161-236	196.10±0.71	13.54±0.50	6.91±0.26	0.507±0.049
		b. Non-conjugants ...	476		34	161-288	228.36±1.23	24.20±0.87	10.60±0.39	
4	Mar. 21, '08	a. Conjugants	84	42	38	116-160	139.29±0.70	9.56±0.50	6.86±0.36	0.499±0.055
		b. Non-conjugants ...	152		34	100-244	155.40±1.39	25.42±0.98	16.36±0.65	
5	Mar. 26, '08	a. Conjugants, descended from 4-a...	16	8	34	116-144	130.50±1.33	7.90±0.94	6.05±0.72	
		b. Non-conjugants descended from 4-a...	100		34	101-200	143.80±1.29	19.08±0.91	13.27±0.64	
6	Jan. 29, '08	a. Conjugants.....	272	136	39	128-216	181.49±0.54	13.32±0.39	7.34±0.21	0.428±0.033
		b. Non-conjugants ...	318		34	132-248	186.10±0.79	20.97±0.56	11.27±0.31	
7	Apr. 3, '09	a. Conjugants.....	158	79	40	128-204	168.71±0.63	11.66±0.44	6.91±0.26	0.333±0.048
		b. Non-conjugants ...	131		34	148-224	182.20±1.03	17.43±0.73	9.57±0.40	
B. Descended from selected parts of wild cultures										
8	Feb. 17, '08	a. Conjugants descended from 10 small 6b.....	54	27	42	120-152	134.89±0.64	7.02±0.46	5.20±0.34	0.612±0.057
		b. Non-conjugants, from same.....	56		35	124-168	148.93±0.98	10.89±0.69	7.31±0.47	

TABLE 2

Constants of variation in length for conjugants and non-conjugants of *Paramecium*, from cultures of pure races, descended from a single individual or a single pair, or from mixed cultures of known racial composition. (The measurements of length for these will be found in table 25 of the appendix; the tables of correlation for the conjugants, in the appendix, are indicated in the column headed 'table')

LOT	DATE	RACE		NUMBER OF INDIVIDUALS	NUMBER OF PAIRS	TABLE	RANGE OF VARIATION IN MICRONS	MEAN LENGTH IN MICRONS	STANDARD DEVIATION IN MICRONS	COEFFICIENT OF VARIATION	COEFFICIENT OF CORRELATION BETWEEN MEMBERS OF PAIRS
A. Pure lines from one individual (all aurella)											
9 Sept. 25, '07		c	a. Conjugants.....	250	125	43	120-180	150.50±0.48	11.13±0.34	7.39±0.22	0.132±0.042
			b. Non-conjugants.....	200	35		124-200	158.80±0.58	18.38±0.62	11.58±0.40	
10 Feb. 20, '08		k	a. Conjugants.....	52	26	44	112-144	127.23±0.67	7.14±0.47	5.61±0.37	-0.193±0.090
			b. Non-conjugants.....	43	35		120-160	140.19±0.99	9.65±0.70	6.89±0.50	
11 Feb. 26, '08		k	a. Conjugants.....	28	14	45	96-136	116.71±1.13	8.87±0.80	7.60±0.69	-0.137±0.125
Forenoon			b. Non-conjugants.....	100	35		96-152	133.68±0.79	11.64±0.56	8.70±0.42	
12 Sept. 12, '08		k	a. Conjugants.....	156	78	46	104-140	124.08±0.41	7.51±0.29	6.05±0.23	0.367±0.047
			b. Non-conjugants.....	100	35		104-180	143.72±0.96	14.25±0.68	9.91±0.48	
Afternoon		k	a. Conjugants.....	336	168	47	92-156	129.58±0.40	10.96±0.29	8.46±0.22	0.184±0.036
13 Sept. 12, '08			b. Non-conjugants.....	100	35		88-168	140.20±0.97	14.35±0.68	10.23±0.49	
14 Mar. 31, '08		N _{1/2}	a. Conjugants.....	42	21	35	124-148	136.95±0.58	5.53±0.41	4.03±0.30	0.295±0.095
			b. Non-conjugants.....	34	35		132-168	144.59±0.92	7.92±0.65	5.48±0.45	
15 Apr. 4, '08		N _{1/2}	a. Conjugants.....	50	25	35	116-148	132.88±0.64	6.66±0.45	5.01±0.34	0.257±0.089
			b. Non-conjugants.....	31	35		120-188	147.61±2.20	18.18±1.56	12.31±1.07	
16 Sept. 14, '08		C ₂	a. Conjugants.....	300	150	49	100-160	128.67±0.47	11.97±0.33	9.30±0.26	0.507±0.029
			b. Non-conjugants.....	100	35		96-168	134.20±1.04	15.37±0.73	11.45±0.55	
17 Sept. 16, '08		C ₂	a. Conjugants.....	138	69	49	88-148	121.91±0.66	11.46±0.47	9.40±0.39	0.318±0.052
			b. Non-conjugants.....	110	35		104-164	132.18±0.87	13.53±0.62	10.23±0.47	
Forenoon		a	a. Conjugants.....	168	84	50	104-152	123.57±0.41	7.80±0.29	6.31±0.23	0.251±0.049
18 Sept. 25, '08			b. Non-conjugants.....	100	35		88-180	131.32±1.21	17.97±0.86	13.68±0.67	
Afternoon		a	a. Conjugants.....	174	87	51	96-152	118.28±0.52	10.11±0.37	8.55±0.31	0.323±0.048
19 Sept. 25, '08			b. Non-conjugants.....	118	35		88-180	135.35±1.02	16.49±0.72	12.18±0.54	
B. Mixtures of two known races											
20 Mar. 3, '08		C ₂ + i	a. Conjugants.....	124	62	53	100-156	129.58±0.62	10.31±0.44	7.95±0.34	0.115±0.060
			b. Non-conjugants.....	149	35		84-176	122.44±1.37	24.71±0.97	20.18±0.82	
21 Nov. 6, '08		L ₂ + k	a. Conjugants.....	98	49	54	108-136	120.25±0.46	6.68±0.32	5.56±0.27	0.408±0.064
			b. Non-conjugants.....	156	34		104-264	173.10±2.25	41.67±1.59	24.07±0.97	

jugants where the corresponding non-conjugants were not examined. The original measurements on which these constants are based will be found in the tables of the appendix; the more important ones in tables 34 and 35.

TABLE 3

Constants of variation in length for a number of lots of conjugating *Paramecia* in which the non-conjugants were not measured. The column headed 'table' gives the number of a table to be found in the appendix, in which the distribution of the measurements is shown. The measurements are here given in microns

LOT	DATE		NUMBER OF IN-DIVIDUALS	NUMBER OF PAIRS	TABLE	RANGE OF VARIATION	MEAN LENGTH	STANDARD DEVIATION	COEFFICIENT OF VARIATION	COEFFICIENT OF CORRELATION BETWEEN THE MEMBERS OF PAIRS
1910										
22	Aug. 31	Wild culture, caudatum	204	102	55	152-208	176.14±0.48	10.05±0.34	5.72±0.19	0.359±0.041
23	Sept. 21	Wild, caudatum	296	148	22 and 23	152-208	179.80±0.41	10.42±0.29	5.80±0.16	0.245±0.037
24	Sept. 11	Race <i>k</i> (aurelia)	244	122	59	100-144	118.92±0.33	7.54±0.23	6.34±0.16	0.210±0.041
26	Sept. 11	Mixed caudatum and aurelia	62	31		84-200	145.81±2.44	28.49±1.73	19.54±1.23	0.939±0.010
27	Sept. 13	Mixed caudatum and aurelia	340	170	10	108-236	161.19±1.27	34.70±0.84	21.53±0.54	0.940±0.004

With certain exceptions, to be considered later, the results given in these tables confirm Pearl's results (1) that the conjugants are smaller than the non-conjugant population of a culture; (2) that they are less variable than the non-conjugants, and (3) that there is a marked positive correlation in size between the members of the pairs, so that on the whole larger individuals are found mated with larger, smaller individuals with smaller. We shall take up these matters separately.

RELATIVE SIZE OF CONJUGANTS AND NON-CONJUGANTS

If we examine in the seven 'wild' cultures of table 1 the relative mean lengths of the conjugants and non-conjugants of a culture, we find, as shown in table 4, that in every case *save one* the conjugants are smaller than the non-conjugants. In lots 1, 4 and 5, the difference between the means for the conjugants and non-conjugants is about 10 per cent of the mean length of the non-conjugant population; in lot 3 it is 14 per cent. But in lot 6 the difference is slight, being but 2.5 per cent of the mean for the

non-conjugants, and in lot 2 the mean length of the conjugants is actually the greater, by a very small amount, though here the difference is not significant in comparison with the probable error. In this culture then the conjugants are not perceptibly differentiated in size from the non-conjugants.

In the four lots studied by Pearl ('07) the conjugants were in all cases smaller than the non-conjugants, by amounts varying from 11.5 per cent to 16.4 per cent of the mean of the latter, and

TABLE 4

Differences in length between conjugants and non-conjugants of wild cultures. (The 'relative difference' in the fourth column shows what percentage the difference is of the non-conjugant mean)

LOT	NON-CONJUGANT MEAN	CONJUGANT MEAN	ABSOLUTE DIFFERENCE	RELATIVE DIFFERENCE
				Per cent
1	222.86±0.87	199.02±0.54	23.83±1.02	10.7
2	164.12±1.00	165.04±0.53	-0.93±1.13	-0.54
3	228.36±1.23	196.10±0.71	32.27±1.42	14.1
4	155.40±1.39	139.29±0.70	16.11±1.56	10.4
5	143.80±1.29	130.50±1.33	13.30±1.85	9.2
6	186.10±0.79	181.49±0.55	4.61±0.96	2.5
7	182.20±1.03	168.71±0.63	13.49±1.20	7.4

TABLE 5

Differences in length between conjugants and non-conjugants of pure races and mixtures of pure races

LOT	RACE	NON-CONJUGANT MEAN	CONJUGANT MEAN	ABSOLUTE DIFFERENCE	RELATIVE DIFFERENCE
					Per cent
9	<i>c</i>	158.80±0.88	150.50±0.48	8.30±1.00	5.2
10	<i>k</i>	140.19±0.99	127.23±0.67	12.95±1.20	9.2
11	<i>k</i>	133.68±0.79	116.71±1.13	15.97±1.38	11.9
12	<i>k</i>	143.72±0.96	124.08±0.41	19.64±1.04	13.7
13	<i>k</i>	140.20±0.97	129.58±0.40	10.62±1.05	7.6
14	<i>Nf</i> ₂	144.59±0.92	136.95±0.58	7.64±1.08	5.3
15	<i>Nf</i> ₂	147.61±2.20	132.88±0.64	14.73±2.29	10.0
16	<i>C</i> ₂	134.20±1.04	128.67±0.47	5.53±1.14	4.1
17	<i>C</i> ₂	132.18±0.87	121.91±0.66	10.27±1.09	7.8
18	<i>g</i>	131.32±1.21	123.57±0.41	7.75±1.28	5.9
19	<i>g</i>	135.35±1.02	118.28±0.52	17.08±1.15	12.6
20	<i>C</i> ₂ + <i>i</i>	122.44±1.37	129.58±0.62	-7.14±1.50	-5.8
21	<i>L</i> ₂ + <i>k</i>	173.10±2.25	120.25±0.46	52.86±2.30	30.6

it has been practically the universal testimony of observers that the conjugants are smaller than those not conjugating. Our own results, as we have seen, confirm this for most cases, but not for all. How is the fact to be accounted for that in some cultures the conjugants are not smaller?

Light on this question will best be obtained by examining the relative sizes of conjugants and non-conjugants in cultures composed of pure races, and in mixtures of known racial composition. The data are given in table 2 and in table 5. In all the eleven cases of table 2 in which we can compare the conjugants and non-conjugants of a pure race, we find the conjugants smaller, by amounts varying from about 4 per cent up to more than 12 per cent, of the mean for the non-conjugant population. All of these are races of aurelia, as I had no opportunity to make a careful study of the conjugants of a pure race of caudatum. But the fact that in wild cultures consisting mainly if not entirely of caudatum, as was the case with all of Pearl's material, and of our lots 1, 3, 4 and 5, the conjugants are as a rule markedly smaller than the non-conjugants, indicates strongly that this would hold generally for caudatum also. We may then take it as established for aurelia, and practically so for caudatum, that within any given race the conjugants average smaller than the non-conjugants. Why in some wild cultures the conjugants may not be found smaller is shown by examination of the data for our mixed cultures (lots 20 and 21, table 2). Lot 20 consisted of a mixture of two races of aurelia, *i* and C_2 . The race *i* was smaller, averaging usually about 100 microns in length, while the usual mean for C_2 was about 125 microns.³ When conjugation took place in this mixture, the conjugants were all of the size characteristic for the conjugants of C_2 (as shown by comparing lots 16, *a* and 20, *a* of table 2), measuring 129.58 microns. Conjugants in a pure race of *i* had been found to be much smaller, varying from 92 to 98 microns in length. Thus it was clear that in the mixture *only the race C_2 was conjugating*, and the measurements

³ For measurements of these races under various conditions, see Jennings '08, and Jennings and Hargitt '10.

for the conjugants are of that race alone. But the random sample of non-conjugant population contains representatives of both *i* and C_2 , and its mean size (122.44 microns), therefore lies between that of the two races. It is therefore less than that of the conjugants. The conditions in this case are illustrated in fig. 1. They are well brought also by a comparison of the measurements of the conjugants and non-conjugants of lot 20, as given in table 35.

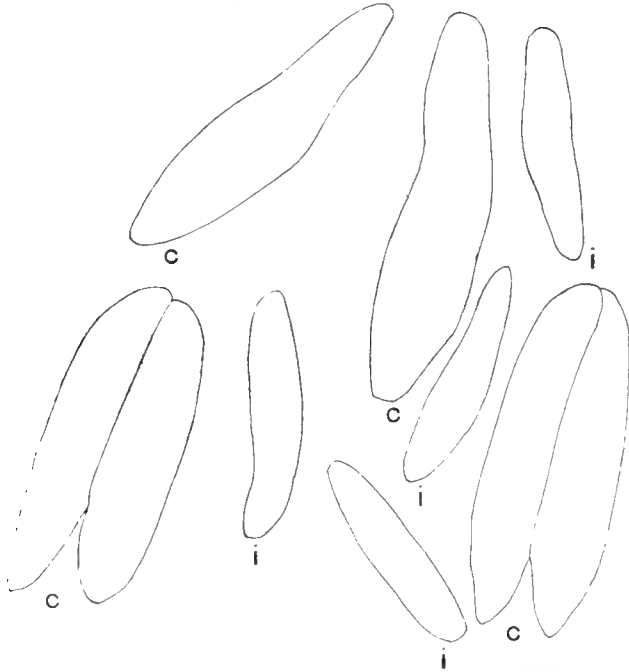

Fig. 1 Typical group of specimens from a culture consisting of a mixture of the large race C_2 and the small race *i* (both aurelia). Conjugating pairs all C_2 . $\times 333$.

The reverse condition is given by the mixture of L_2 and *k* (lot 21, tables 2, 5 and 34). Here the conjugation was only in the smaller race *k*, while the non-conjugant sample includes also many of the large race L_2 . As a result the conjugants are very much smaller than the mean for the mixture as a whole, the difference being 30.6 per cent this mean.

These cases show that when more than one race is present in a mixture, the members of one race alone may conjugate. If this is a large race, the mean size of the conjugants may be equal to that of the population as a whole, or even larger than this. This is doubtless the explanation for lots 2 and 6, tables 1 and 4; here we are dealing with cultures of unknown racial composition. As a matter of fact I did, by selection and propagation, isolate a number of races of diverse size from lot 6; from it came the races k and L_2 , as well as a number of others.

Thus when we are dealing with a single race the conjugants are always smaller than the non-conjugant population, by amounts varying from 4 per cent to 13 per cent (or more) of the mean for the latter. The variation in the proportional difference between the two in different cases is readily accounted for the fact that sometimes multiplication is occurring during an epidemic of conjugation, at other times not. In the former case many young will be present, reducing the mean length for the non-conjugants, but not affecting that for the conjugants. It is to be noted however that the mean size of the conjugants may differ a certain amount under different conditions in the same race. In the race k the mean size at the epidemic of February 26, 1908, was 116.71 microns (table 2, lot 11) while at the epidemic of September 12, 1908, it was, in the afternoon, 129.58 microns (lot 13), a difference of 11.02 per cent of the smaller mean size. This is the greatest difference in mean size observed between the conjugants of a given race. It is to be observed that this difference is not one arising progressively over long periods, for but a week before the minimum, the conjugants of this same race showed practically the maximum size (compare lots 10 and 11, table 2). The difference is undoubtedly due to the varying nutritive conditions at the time of conjugation.

But in cultures of unknown racial composition, the conjugants may be very much smaller than the average for all (as in lot 21), or they may be equal to or larger than the average for all, depending on the relative size of the races present, and upon which of these races the conjugants belong to.

The consequences in heredity of the decreased size of the conjugants will be taken up later.

RELATIVE VARIABILITY OF CONJUGANTS AND NON-CONJUGANTS

Examination of tables 1 and 2 confirms further Pearl's discovery that the conjugants are not only smaller, but also less variable than the non-conjugant population. A comparison of the original measurements for the conjugants and non-conjugants, as given in tables 34 and 35 of the appendix, renders this difference in variability at once evident to the eye. In every one of the cases given by these tables, both the absolute variation (as shown by the standard deviation) and the relative variation (as shown by the coefficient of variation) are less in the conjugants. In a few cases the difference is but slight and would perhaps be hardly significant, taking each of these cases separately, in comparison with the probable errors. But the fact that it is always the conjugants which show the lesser variability is very significant, especially when we consider the much more numerous cases in which the variability of the conjugants is much less than that of the non-conjugants.

The difference between the variability of conjugants and non-conjugants itself varies greatly in different cases; in other words, sometimes the conjugants are but little less variable than the non-conjugants, while in other cases they are very much less variable. This is exhibited in table 6. In some of the wild cultures the coefficient of variation of the conjugants is but 5.1 per cent less than that of the non-conjugants (lot 2, where the difference is indeed of no significance in comparison with the probable error); from this minimum it varies up to a difference in lot 4 of 58.1 per cent,—the coefficient of variation for the conjugants being less than half that for the non-conjugants. In the pure races the least difference between the coefficients for the conjugants and non-conjugants is 8.1 per cent of that for the non-conjugants (lot 17), rising to 59.3 per cent in lot 15. If we make an average of these numbers showing the difference in variability for the eleven lots of these races in table 6, we find it to be 33.01 per cent.

CAUSES OF THE LESSENED VARIABILITY OF CONJUGANTS

What is the cause of this lessened variation among the conjugants? A number of different possible factors may be considered.

1. Gametic differentiation

Lister ('06) suggested that the cause was as follows: The conjugants are differentiated gametes. In measuring them we are dealing only with this particular class, while in the non-conjugant population we include many gametes, many in the process of differentiation into gametes and many that are not gametes; hence the non-conjugants are a heterogeneous lot and must give

TABLE 6
Difference in variability between conjugants and non-conjugants

LOT	RACE	STANDARD DEVIATION				COEFFICIENT OF VARIATION			
		Non-conjugants	Conjugants	Abs. difference	Rel. difference	Non-conjugants	Conjugants	Abs. difference	Rel. difference
<i>A. Wild cultures</i>									
					%				%
1		24.57±0.62	15.25±0.38	9.29±0.73	37.8	11.03±0.28	7.63±0.19	3.35±0.34	30.4
2		13.84±0.71	13.20±0.37	0.64±0.80	4.6	8.43±0.43	8.00±0.23	0.43±0.49	5.1
3		24.20±0.87	13.54±0.50	10.66±1.00	44.0	10.60±0.39	6.91±0.26	3.69±0.47	34.8
4		25.42±0.98	9.56±0.50	15.86±1.10	62.4	16.36±0.65	6.86±0.36	9.50±0.74	58.1
5		19.08±0.91	7.90±0.94	11.18±1.31	59.0	13.27±0.64	6.05±0.72	7.22±0.96	54.4
6		20.97±0.56	13.32±0.39	7.65±0.68	36.5	11.27±0.31	7.34±0.21	3.93±0.37	34.9
7		17.43±0.73	11.66±0.44	5.77±0.85	33.1	9.57±0.40	6.91±0.26	2.65±0.48	27.7
8		10.89±0.09	7.02±0.46	3.87±0.83	35.5	7.31±0.47	5.20±0.34	2.11±0.58	28.9
<i>B. Pure races</i>									
9	c	18.38±0.62	11.13±0.34	7.45±0.71	40.6	11.58±0.40	7.39±0.22	4.19±0.46	36.2
10	k	9.65±0.70	7.14±0.47	2.51±0.84	25.9	6.89±0.50	5.61±0.37	2.28±0.62	33.1
11	k	11.64±0.56	8.87±0.80	2.77±0.98	23.8	8.70±0.42	7.60±0.65	2.10±0.81	24.1
12	k	14.25±0.68	7.51±0.29	6.74±0.74	47.3	9.91±0.48	6.05±0.23	3.86±0.53	39.0
13	k	14.35±0.68	10.96±0.29	3.39±0.74	23.7	10.23±0.49	8.46±0.22	1.77±0.54	17.3
14	Nf ₂	7.92±0.65	5.53±0.41	2.39±0.77	30.2	5.48±0.45	4.03±0.36	1.45±0.54	26.5
15	Nf ₂	18.18±1.56	6.66±0.45	11.52±1.62	63.4	12.31±1.07	5.01±0.34	7.30±1.12	59.3
16	C ₂	15.27±0.73	11.97±0.33	3.40±0.80	22.1	11.45±0.55	9.30±0.26	2.15±0.61	18.8
17	C ₂	13.53±0.62	11.46±0.47	2.07±0.78	15.3	10.23±0.47	9.40±0.39	0.83±0.88	8.1
18	g	17.97±0.86	7.80±0.29	10.17±0.91	56.6	13.68±0.67	6.31±0.22	7.37±0.71	53.9
19	g	16.49±0.72	10.11±0.37	6.38±0.81	38.7	12.18±0.54	8.55±0.31	3.53±0.62	29.0
<i>C. mixed</i>									
20	C ₁ +i	24.71±0.97	10.31±0.44	14.40±1.07	58.3	20.18±0.82	7.95±0.34	12.23±0.89	60.6
21	L ₂ +k	41.67±1.59	6.68±0.32	34.99±1.62	84.0	24.07±0.97	5.56±0.27	18.51±1.01	76.9

a greater coefficient of variation. This suggestion contained perhaps the germ of a correct explanation, but erred in emphasizing a supposed differentiation of the gametes from ordinary adults. Pearl showed that in cultures which are not conjugating, nor near a period of conjugation, the coefficients of variation are as great as for the general population of those containing conjugants ('07, p. 231), and my own extensive data ('08) confirm this fully. In such cultures there are no gametes and no specimens in the process of differentiation into gametes, so that heterogeneity on this score cannot account for their greater variation as compared with the conjugants.

2. *Equalization*

Pearl ('07, p. 262) discusses the possibility that a process of equalization has occurred during conjugation; "that the pro-conjugants were simply a random sample from the general population having equal variability with it," and that the decrease in variability is due to "a pronounced tendency toward equalization in size of the two members." He adduced evidence to indicate that such a process of equalization does not occur to any considerable degree. A tendency to equalization does exist, as we shall see later, but (as will later appear) it is not of such a character or degree as to account for the greatly decreased variability and smaller size of the conjugants. Moreover, as we shall immediately see, such an explanation is gratuitous, since there is a fully adequate explanation on other grounds.

3. *Growth*

In my paper of 1908, I showed that a large proportion of the variation in an ordinary culture of *Paramecium* is due to growth. A random sample of the population includes young individuals, that are very small; individuals in all stages of growth up to the largest sizes and individuals that have again decreased in length preparatory to fission. Now, the conjugants include neither the young, small individuals, nor the largest ones. Hence they show

much less variation than the population as a whole. The same thing would be found true (in possibly a less degree) for man or any higher animal; mated couples would be found on the whole less variable than a general sample of the population that included children. In one respect the condition in the infusorian is peculiar; the conjugants do not grow so large as the individuals that are to undergo fission without conjugation. Thus the conjugants represent a rather definite, limited stage of growth, excluding the extremes at both ends. That this is fully sufficient to account for the lesser variability of the conjugants is demonstrated by the fact that non-conjugants at a definite growth stage show as little variability as do conjugants. The coefficients of variation in length for conjugants range as a rule from 5 to 8 per cent, as shown in tables 1 and 2, and in Pearl's tables. In my paper of 1908, I showed that individuals beginning fission (and therefore at a fairly definite growth stage) show coefficients of variation as small as those for conjugants, and differing as much from those of the general population (p. 454). Coefficients of variation as low as 4.5 were found for samples of a definite age. The low variability of conjugants is then fully accounted for by the fact that conjugation does not occur till a certain stage of growth has been reached; and that conjugation occurs before the animals have reached the largest size, that precedes fission.

One of the most striking things to be observed in a conjugating culture is the existence along with the conjugants of many individuals of much greater size than the conjugants. This will best be seen by comparing the measurements of conjugants and non-conjugants of given lots, as exhibited in tables 34 and 35 of the appendix; it is indicated in tables 1 and 2 by the fact that the range of variation invariably extends to much higher limits in the non-conjugants than in the conjugants, as well as by the fact that the mean is higher for the former. Fig. 2 shows a collection of conjugants and non-conjugants from a culture of the race *k*; the specimen marked *e* shows one of the very large non-conjugants. It is easy to isolate from a conjugating culture many non-conjugants that are larger than any of the conjugants.

Increase in size and variability of the conjugants before fission. Further evidence as to the significance of the decreased size of the conjugants will be reached by asking the following question: Do the conjugating individuals remain smaller than the non-conjugants; or do they increase in size before they divide, till they finally reach the size of the large non-conjugants? A parallel question may be asked regarding the variability of the conjugants; does this increase to the normal amount before the ex-conjugants divide?

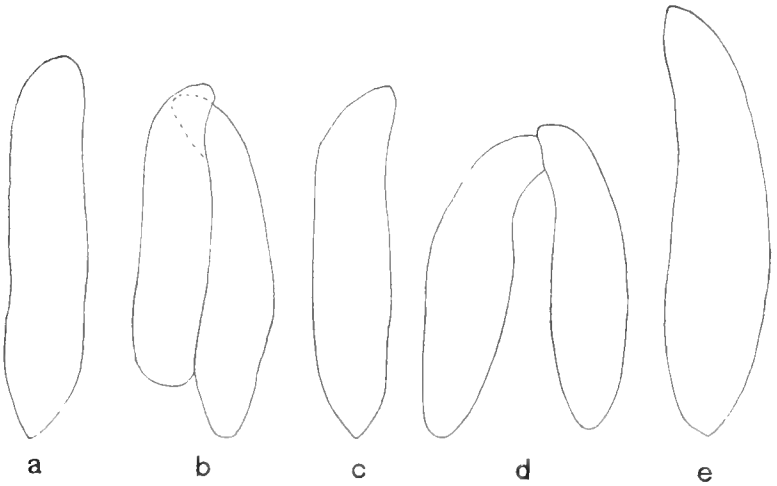

Fig. 2 Conjugants (*b* and *d*) and non-conjugants (*a*, *c* and *e*) from the race *k*, showing the relative sizes. $\times 333$.

On these points observations were made for a number of cultures; those for lot 6 (of table 1) are the most complete. From this lot I selected fifty of the largest non-conjugants, all larger than any of the conjugants, and compared their dimensions with the dimensions of conjugants about 36 hours after separation; also with random samples of conjugants and non-conjugants. The results are given in table 7.

As this table shows, the conjugants before dividing increased in size till they were fully equal to the selected largest non-con-

jugant individuals. The mean dimensions of the conjugants increased before fission from 181.49 by 48.11, to 214.48 by 64.24. These later dimensions of course exceed greatly the mean for the non-conjugant population.

More extensive data on the increase in size of the conjugants before fission, though without comparison with the non-conjugants, is given in table 19, on page 69. Here the conjugants of the two wild lots (22 and 23) had increased in length 20.62 per cent and 11.76 per cent, respectively, after separation; those of

TABLE 7

Changes in size and variability of the conjugants before they divide, in comparison with non-conjugants, from lot 6 (wild culture)

DATE	LENGTH				BREADTH			
	No.	Mean	Standard deviation	Coefficients of variation	No.	Mean	Standard deviation	Coefficients of variation
Jan. 30, '08 Non-conjugants, random sample...	318	186.10±0.79	20.97±0.56	11.27±0.31	200	49.98±0.49	10.21±0.34	20.43±0.72
Feb. 1, '08 Largest non-conjugants...	50	211.52±1.99	20.84±1.41	9.85±0.67	50	62.48±1.17	12.29±0.83	19.66±1.37
Jan. 30, '08 Conjugants, random sample.....	272	181.49±0.54	13.32±0.39	7.34±0.21	38	48.11±0.87	7.94±0.61	16.51±1.31
Feb. 1, '08 Conjugants, 36 hours after separation....	50	214.48±2.09	21.92±1.48	10.22±0.70	50	64.24±1.06	11.09±0.75	17.27±1.20

race *k* (lot 24) had increased 21.82 per cent. Comparing the size of the separated conjugants of race *k* as given in table 19 with the size of the non-conjugants as given in table 2 (lots 10-13), we find that the conjugants have become before fission fully as large as the non-conjugant population.

Tables 7 and 19 show also that the variability of the conjugants likewise increases considerably after they separate. In lot 6 (table 7) the variability in length of the separated conjugants approaches that of the non-conjugants. The coefficients of variability for the separated conjugants of table 19, while considerably larger than those for the united conjugants, are somewhat below those usual for the non-conjugating population, as

shown in tables 1 and 2. There is of course an intelligible reason for their variability remaining less than that of the non-conjugant population, for the latter includes young individuals as well as old ones, while the ex-conjugants consist entirely of old individuals. There is no indication of a real differentiation of the conjugants from the non-conjugant population in respect to variability save as a result of this exclusion of young specimens from the conjugants.

The general conclusion would therefore seem to be justified that the conjugants are not differentiated from the non-conjugants of the same race, save temporarily, the differences disappearing practically before the first fission of the conjugants.

4. *Racial differences*

We have seen the cause of the lessened variability of the conjugants within a pure race. Another ground for less variability in the conjugants, when the culture is not limited to a single race, is seen on examination of the data for the mixed cultures (lots 20 and 21, table 2). Here the coefficients of variation for the conjugants are respectively 60.6 per cent and 76.9 per cent less than that for the non-conjugants; or to put it another way, in lot 20 the variability of the non-conjugants is 2.54 times as great as that for the conjugants; in lot 21 it is 4.33 times as great. The remarkable differences become evident to the eye on comparing the measurements of the conjugants and non-conjugants of these lots, as shown in tables 34 and 35 of the appendix. These great differences in variability are due to the fact that but one of the two races present conjugated; so that the non-conjugant sample included members of two diverse races, the conjugant sample but one. As shown elsewhere (Jennings '10), it frequently happens that in a mixture of races but one race conjugates. This must often greatly affect the relative coefficients of variation in wild cultures of unknown racial composition.

We conclude therefore that the less variability of conjugants as compared with non-conjugants is due (1) to the fact that the conjugants include only a limited number of growth stages, inter-

mediate between the largest and the smallest; (2) to the fact that in mixed cultures not all the races conjugate at the same time.

The consequences of the lessened variability of the conjugants will be considered later.

ASSORTATIVE MATING

Pearl's explanation

Pearl ('07) concluded from his study of conjugating *Paramecia* that there is a marked degree of assortative mating in these animals, *i.e.*, that large individuals tend to mate with large ones, small individuals with small ones. This is an extremely important matter (as Pearl well recognized) for the understanding of heredity, variation and evolution in these organisms, and we must examine into the matter with care. Is there actually assortative mating? What are its degrees and limitations; what are its causes; what its effects in heredity and variation?

In the study of these matters the method used by Pearl, and the one we shall to a large degree follow him in using, is to study the correlation between the members of pairs. We shall however endeavor to put to the test of experiment such questions as are open to it, and to combine the statistical and experimental study with the results of direct observation. We shall take up first Pearl's explanation of how assortative mating occurs; then give an account of direct observations of the process of conjugating, in their bearing on this explanation. We shall then enter upon a statistical and experimental analysis of the facts.

Pearl showed that when we measure the individuals making up the pairs in a lot of conjugants, there is a rather high correlation between the two members; that is, large individuals are found mated with large, small with small. The details and degrees of this we shall take up later. Pearl's explanation of this correlation is that there is a real assortative mating—larger individuals mating with larger, smaller with smaller. The way in which this assortative mating is brought about, according to Pearl, is essentially the following: In a typical conjugation the

two individuals first place their anterior ends together; these adhere. Then the two bodies are brought in line, and if the two mouths come in contact, they adhere, and conjugation becomes complete. Now it is evident that if the two animals are not of approximately the same length, mouth and anterior tip will not both come into contact, and conjugation will therefore not be completed; in this case "the individuals separate again or die, and no conjugation results." Hence it is only individuals of approximately the same size that will conjugate.

This explanation of Pearl's is based to a certain extent on observation of the process of conjugation, and its essential correctness seems highly probable. But Pearl himself was able to make but few observations on the behavior in the process of conjugating (as he notes on p. 266 of his paper), and it will be well therefore to add what we can along this line. Some of the details are of much importance for understanding the limitations as well as the potentialities of the assortative mating. We shall examine first the typical cases, then some of the variations.

OBSERVATION OF THE PROCESS OF CONJUGATING

The first contact between the individuals about to conjugate is very commonly at the anterior tips, and I am able to give figures of a number of pairs in which the process had gone no farther than this (fig. 3, *a*, *b*, *c*). The two tips where they meet form projections and depressions, which interdigitate and hold the two together. This I have often noticed in the living specimens, and it is indicated in fig. 3, at *b*. Then the bodies themselves are brought together. There is at first no union except at the anterior tip, until the mouths are reached. These then unite, so that the animals are held together at two points only. This stage in the process is represented by *e*, *f*, *g* (fig. 3), drawn from preserved material.

Then the bodies become closely applied to each other throughout the stretch from anterior tips to mouth, and for a certain distance behind the mouths. Apparently however the union is not so firm elsewhere as at the anterior tips and the mouth;

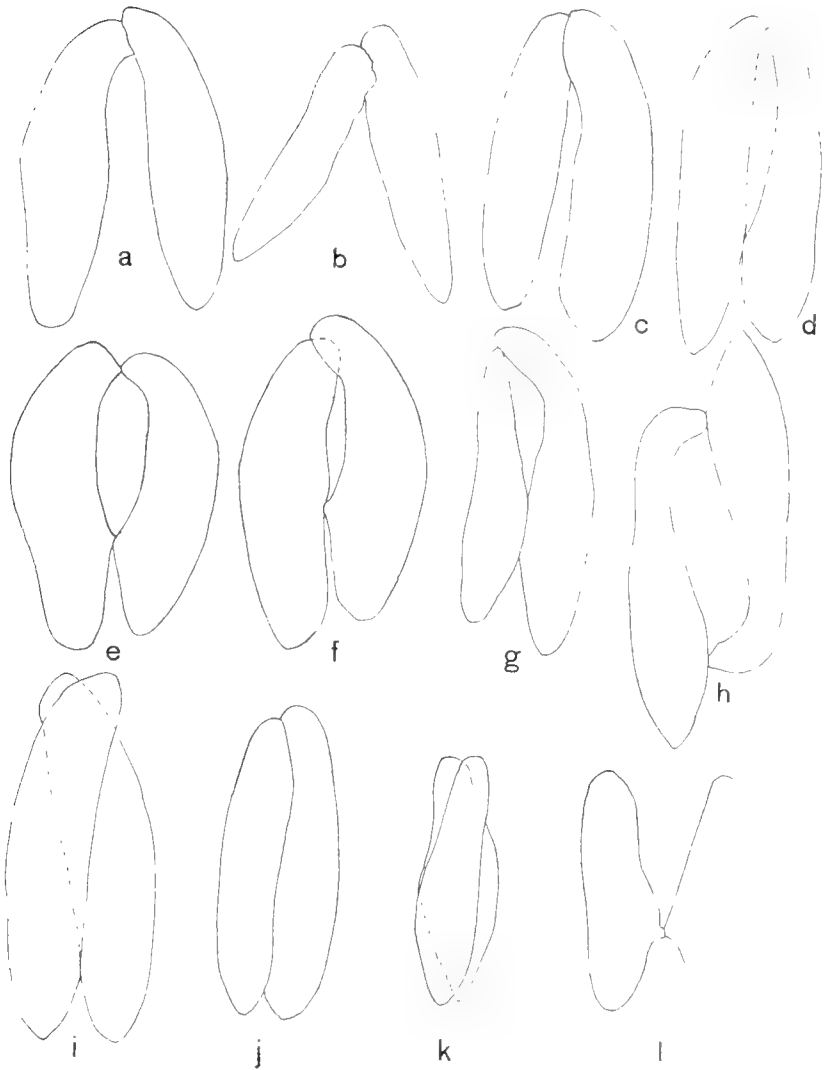

Fig. 3 Characteristic attitudes in conjugation. All are drawn with the projection apparatus from fixed specimens, save *h*, which is a free-hand sketch from a living pair. *a, e, f* belong to the race *k*; *c, d, g, i, j* to the race *C₂*; *b, k* and *l* to the race *c* (all aurelia); *a, b*, and *c*, stages with only the anterior tips in contact; *e, f, g*, anterior tips and mouths in contact; *h*, reversed pair, at beginning of conjugation; *i, j*, most complete union; *k*, view of pair in profile, showing the crossing (also seen in *i*); *l*, last stage, just before complete separation. Magnification (for all but *h*), 333 diameters.

specimens not in contact elsewhere than at these points are frequently seen. These facts are noted by Pearl ('07).

But this state of full contact is by no means reached without variation and active movements. On the contrary, there is frequently a period of twisting, turning, contracting, and shifting about, before the final result is reached. Certain points are important.

1. At first apparently only the anterior tip (and possibly the mouth) is adhesive. The anterior tip of one specimen may adhere, at least temporarily, to almost any part of the body of another; certainly to any part of the oral surface. Thus one often sees most irregular adhesions, the first specimen perhaps transverse or oblique to the second, adhering by its tip to the middle of the oral groove of the second; or one specimen is attached to the posterior half of another, trailing behind it; or three or four may be irregularly attached. Sometimes the animals become attached in reversed position—the anterior tip of one to the posterior part of the other, as in fig. 3, *h*. Such irregular attachments have frequently been described and figured.

2. If irregularly attached, the animals begin to pull, twist, contract, and shift, till the relative positions are many times changed. Not rarely one sees a pair completely separate, to reunite in a new position. More often they remain in contact, but the relative position and the parts in contact are changed by gliding and pulling. I have frequently seen pairs in the reversed position of *h*, fig. 3, that finally came into the normal positions, and underwent a typical conjugation. On the whole the period of 'fitting' in conjugation is one of great and varied activity.

3. Among the movements at this period of 'fitting' are contractions and bending. One gets the impression that the animals are making an active 'effort' to bring the mouths into contact. A certain amount of curving of the anterior tips is common even before the mouths have come in contact. If when the bodies are brought in contact the mouths do not match, the curving and bending becomes very marked as in *e*, *f*, *g*, *h*, fig. 3. This is of course most necessary when the two individuals are not of the same length; the longer then may become curved (as in *f* and *g*, fig. 3,

and in *e* and *h*, fig. 15); so that a considerable degree of equalization in length may occur. In measuring the animals it is difficult to detect or allow for this curving, as the animals in conjugation are slightly oblique to each other in any case (owing to the obliqueness of the oral grooves). In actual practice, most such equalized pairs are measured by simply taking the distance from anterior to posterior tips, in the two specimens. This tends of course to produce a correlation that did not exist before the union.

It is however important not to exaggerate the generality or amount of this equalization, and especially to remember that it is only one phase of a process of fitting, the remainder of which would lead to real assortative mating.

4. All of this shifting and contraction may be insufficient for producing a proper fit: in such cases the animals separate. *Such separation is often observed.* This is of course an essential point for producing real assortative mating. It appears clear that individuals of nearly the same size must fit readily, and that the more unequal they are, the less likely they are finally to fit and remain united.

5. From the description thus far, it is clear that the first attachment may not be at the anterior tips of both individuals. It is more likely to be here, because both anterior tips are adhesive, while most of the rest of the body is not. But the anterior tip of one may come in contact with the oral surface of the other some distance behind the anterior tip of the latter. If the two animals are equal, of course the two mouths will now not come together, until the positions have been shifted; but if the two animals are unequal,—if the one lying more to the rear is shorter,—the mouths may then come in contact, and complete conjugation will take place between unequal specimens. Thus the assortative mating, or the correlation in size between two members of a pair, cannot be expected to be complete, since many unequal pairs are found. A number of such are shown in fig. 15, page 53.

Thus on the whole direct observation of the process of conjugation and of the conjugated pairs is favorable to Pearl's view that real assortative mating occurs, and to his explanation of the way it occurs. One important point, not brought out by Pearl,

results from our description,—namely, that there is a real tendency toward equalization in length of the two members of the pair. This of course tends to produce correlation where it would otherwise not exist; in other words it gives, so far as it goes, another explanation of at least a portion of the correlation, and one which would deprive the process of its significance for variation, heredity and evolution. So far as direct observation goes, however, this factor may be of very slight value, accounting for but little of the observed correlation, but it must be kept in mind in the statistical and experimental work, and evidence as to its real value obtained if possible.

CORRELATION IN SIZE IN THE MEMBERS OF PAIRS OF CONJUGANTS

We will now examine the facts as to the correlation in size of the members of a number of lots of conjugants. The data are given in tables 1, 2 and 3, pages 9 to 11, table 3 giving the facts for a number of lots in which only conjugants were measured, while tables 1 and 2 relate to lots in which a comparison was made between conjugants and non-conjugants. In all these tables the data are for conjugating pairs measured while still united; later will be found the facts regarding correlation in pairs measured after separation (tables 19 and 20).

MEANING OF THE COEFFICIENTS OF CORRELATION

In all these tables the degree of correlation is stated in terms of the coefficient of correlation; coefficients will be found varying from -0.193 to $+0.940$. In order to grasp clearly what is meant by correlation, and by the different coefficients of correlation, it will be helpful to examine the pairs shown in fig. 4, and the diagram of fig. 5.

Fig. 4 shows a number of pairs selected in such a way as to exhibit the condition of affairs in the case of marked positive correlation. Where one member of a pair is large, the other is likewise large, and at the other end of the series both members are

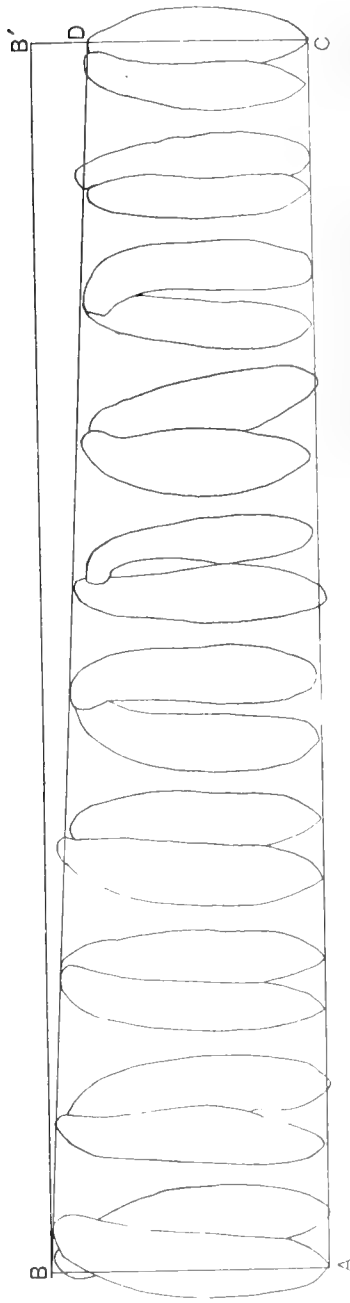

Fig. 4. A selected group of pairs from a culture of the race C_2 (aurelia), March 3, 1908, so placed as to exhibit the positive correlation in size, the large individuals having large mates, the small ones small mates. The lines $A-C$ and $B-B'$ are parallel. Magnification, 250 diameters.

small. Thus if we select the pairs according to the size of one member only, we shall nevertheless find the other member to have nearly the same size.

If in all the pairs of varying size the two members of each pair were precisely equal in length, then the correlation would be complete; the coefficient of correlation would be unity (1.000).⁴ But what is meant by coefficients of correlation less than 1.000; by such coefficients as 0.398 (lot 1, table 1), or 0.507 (lot 3, table 1)? And what is the difference between the two latter cases? Why should lot 3 be given precisely the coefficient 0.507, in place say of 0.275 or 0.860? It is this question that the diagram of fig. 5 is intended to assist in answering.

Suppose we take all the 360 individuals forming the 180 pairs of lot 1 (table 11, page 47) and group them according to their lengths into groups at intervals of four microns. We thus obtain 29 groups, the smallest 148 microns long, the largest 260 microns long. We then place these 29 groups side by side, beginning with the largest and proceeding to the smallest, as in fig. 4. But instead of giving the actual outlines as we did in fig. 4, we use merely lines giving the length of each group. This gives us the vertical lines of fig. 5. The length of the largest individuals being represented by the line *A-B*, that of the smallest by the line *C-D*, the others by the intermediate lines. Then the ends of these lengths form the oblique line *B-D*. The average length of all is shown by the line *O-O'*.

Now suppose we examine the mates of the individuals of these groups—getting the average length of the mates for each group. If correlation were complete (coefficient 1.000) the mates would be of the same lengths as the first individuals (which we may call the *principals*); their upper ends would lie on the same line *B-D*.

⁴ It is worthy of special notice that in the particular case of correlation with which we are dealing, where the two members are of the same sort, this absolute equality of the two members of the varying pairs is the necessary condition for producing the coefficient 1.00. In other cases of correlation this is usually not the case. Thus it would be possible to study the correlation between the bodily stature and the length of the little finger in man. In this case complete correlation (coefficient 1.00) would mean that the same proportion of one to the other was present in all the varying cases.

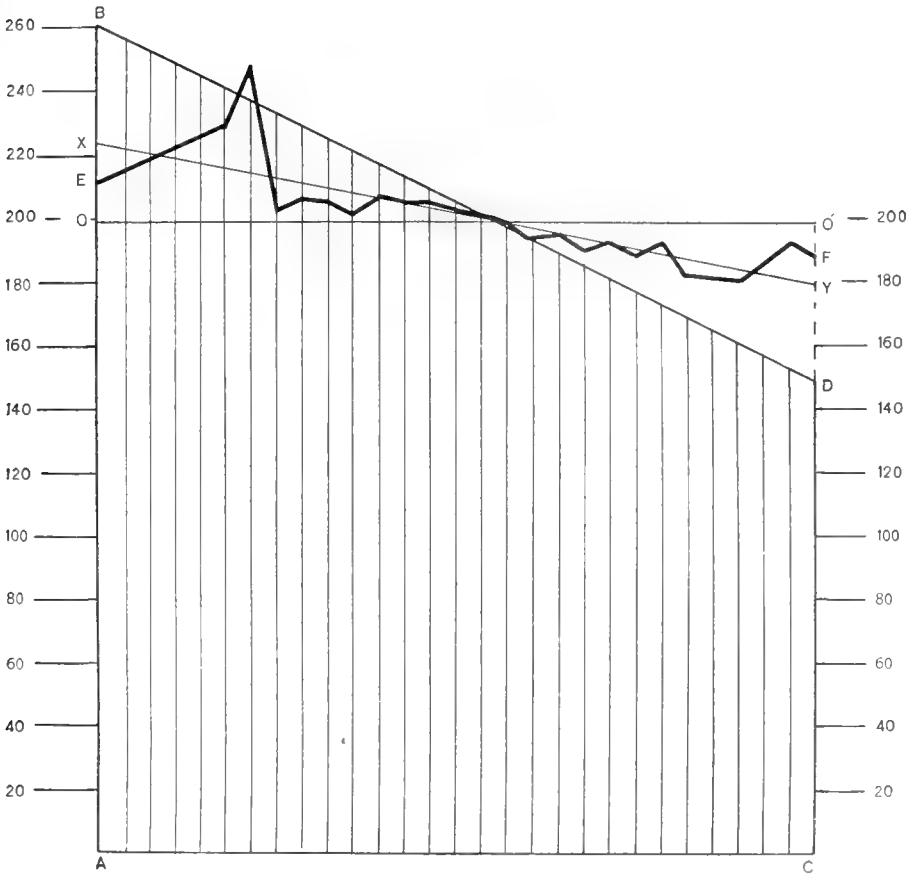

Fig. 5 Diagram to illustrate correlation in size between the members of pairs in lot 1 (see explanation in the text and compare fig. 4). The vertical lines represent the lengths of individuals of the different classes arranged in order from longest (260 microns) to shortest (148 microns), their terminations tracing the oblique line *B-D*. The distance from *A-C* to *O-O'* shows the average length for all. The distance from *A-C* to the broken line *E-F* shows the lengths of the *mates* of the classes of individuals represented by the vertical lines. The general trend of this line *E-F* is shown by the line *X-Y* ('regression line'). The value of the coefficient of correlation is given by the proportion which the line *O-X* is of the line *O-B*.

But in fact we find that the mates are not of exactly the same lengths as the principals. Thus in lot 1 (table 11, page 47), the two individuals having the length 160 microns (40 units)

have mates respectively 164 microns and 196 microns in length, so that the average of the mates is 180 microns. We thus work out the average length of the mates for each length of the principals; this gives us the results shown in table 8. As this table shows, the length of the mates increases on the whole as the length of the principals increases (though not at the same rate), so that larger individuals have somewhat larger mates.

Now we mark on the diagram of fig. 5 the lengths of the mates corresponding to the lengths of each group of principals represented by the vertical lines; we find that these lengths of the mates

TABLE 8

Mean lengths in microns of the mates for the individuals of diverse given lengths, in the 180 pairs of lot 1

NUMBER OF PAIRS	LENGTH OF PRINCIPAL	MEAN LENGTH OF MATES
1	148	188.0
1	152	192.0
2	160	180.0
4	164	181.0
2	168	182.0
4	172	192.0
11	176	188.4
23	180	192.3
19	184	190.0
29	188	194.9
36	192	194.2
35	196	198.9
41	200	200.6
38	204	202.4
34	208	204.2
31	212	205.0
15	216	207.5
15	220	201.6
6	224	205.3
4	228	206.0
4	232	202.0
1	236	248.0
1	240	228.0
2	248	222.0
1	260	212.0

are distributed on the irregular (heavy) line $E-F$. The course of this line shows that the smaller individuals, near the side $C-D$, have mates larger than themselves; that the larger individuals (near $A-B$) have mates smaller than themselves, while the intermediate individuals have mates of nearly their own size. But it is on the whole clear that the line $E-F$ does slope a little in the same direction as $B-D$, only less; large individuals in the left half of the diagram do have larger mates than the smaller individuals, in the right half. That is, there is a certain degree of positive correlation between the size of individuals and the size of their mates. To show how marked this is, we may draw a straight line $X-Y$, showing the general trend of the slope of the broken line $E-F$. (The method by which this line is drawn will be taken up later.) The line $X-Y$ shows approximately what would be the course of the line $E-F$ if we had an infinite number of cases; the irregularities in $E-F$ are due to the limited number of pairs with which we must deal. We may therefore look upon $X-Y$ as showing us the real mean lengths of the mates of the individuals having the lengths shown by the vertical lines.

The position of this line $X-Y$ with relation to the position of the line $B-D$ is now the important point for determining the degree of correlation. We see that $X-Y$ rises above the mean ($O-O'$) where $B-D$ rises above it, and falls below the mean where $B-D$ falls below it, thus sloping in the same general direction as $B-D$. If $X-Y$ did not slope with $B-D$, but were instead quite horizontal (coinciding with $O-O'$), then there would be no correlation (coefficient 0), since this would show that small individuals and large individuals had mates of the same average size. On the other hand, if $X-Y$ not only sloped in the same direction as $B-D$, but actually coincided with it (so that all specimens had mates equaling them in size), then the correlation would be complete and the coefficient would be 1.00. But as a matter of fact $X-Y$ falls neither at $O-O'$, nor at $B-D$, but between the two,—and its precise position is what determines the numerical value of the coefficient of correlation. The line $X-Y$ cuts off at X just 0.398 of the entire distance from O to B (that is, it cuts off 0.398 of the angle between the lines $O-O'$ and $B-D$); therefore the coefficient

of correlation is 0.398. If X fell half way between O and B , the coefficient of correlation would be 0.500; if it fell nine-tenths of the distance from O to B , the correlation would be 0.900, etc.⁵

In place of measuring the proportion of the distance $O-B$ cut off by X , we could of course measure on any of the vertical lines of the diagram the portion of the distance from the line $O-O'$ to the line $B-D$ that is cut off by $X-Y$; the result would be the same.

Fig. 5 may be used further to illustrate negative correlation. If the line $X-Y$ sloped in the opposite direction from $B-D$, falling below $O-O'$ where $B-D$ rises above it, this would of course show that the larger the individual the smaller its mate; *i.e.*, we should have negative correlation. To produce complete negative correlation (coefficient, -1.00) the line $X-Y$ would make the same angle below $O-O'$ that $B-D$ makes above it, and *vice versa*. The degrees of negative correlation would then be determined in the same way as those of positive correlation.

All this may be clearly illustrated if we make a diagram representing only the upper part of fig. 5, above D (that is, including only the varying portions of the lines); such a diagram is given in fig. 6. On this diagram are shown the various positions of the line $X-Y$ corresponding to different degrees of positive and negative correlation when the heavy line $B-D$ shows the dimensions for the principals (also complete positive correlation in the mates).³ (The diagram in fig. 6 is made on a somewhat different scale from that of fig. 5, the vertical distances being greater

⁵ This exposition would not hold, in its present form, for cases where we seek the correlation between unlike things (as between the stature and the length of the finger in man). In such cases the coefficient of correlation depends partly on the relative variability of the two sets of things compared. In the case of correlation between likes, with which we are dealing (where in fact the two classes compared are composed of the *same* individuals), this complication does not come in; the means, standard deviations, and coefficients of variation are the same for the two classes, so that the coefficient of correlation is identical with the coefficient of regression. For such cases our exposition holds without modification.

⁶ Some authors report coefficients of correlation greater than 1.00. This is of course due to arithmetical errors, since when the measurements all fall on the same straight diagonal line passing through the mean, the coefficient is but 1.00, and it is decreased when any of the measurements fall elsewhere than on this line.

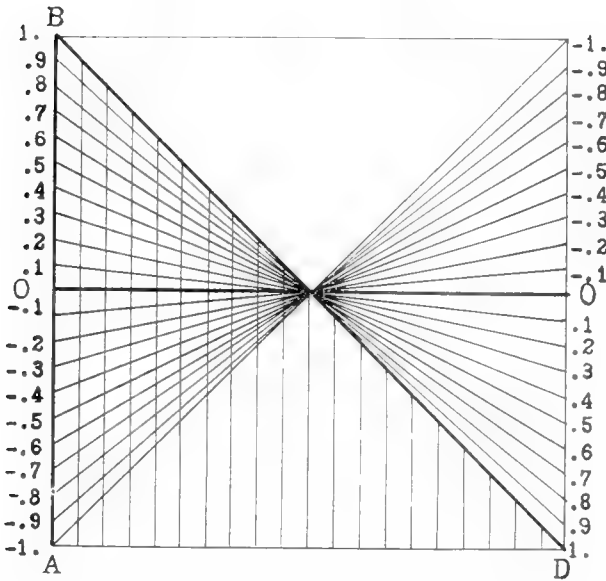

Fig. 6 Diagram illustrating the significance of different coefficients of correlation (should be compared with fig. 5, to the upper portion of which it corresponds). The vertical lines are the terminal portions of the lines representing the lengths of various classes of individuals, arranged according to their size, the largest (*A-B*) at the left. The terminations of these diverse lengths trace the oblique line *B-D*. *O-O* marks the position of the mean length of all. The lines *B-D* and *O-O* and the other oblique lines show the positions of the theoretical average dimensions for the mates of individuals of the given sizes, in case of different coefficients of correlation. If the dimensions of the mates fall in the same line *B-D* as those of the principals, the correlation is 1.000; if they fall at the mean *O-O* the correlation is 0; if they fall at right angles to *B-D*, the correlation is -1.00 . If they fall in a line dividing *O-B* into equal parts, the correlation is 0.500. The coefficients, from $-1.$ to $+1.$, by tenths, are illustrated in the diagram, the numbers at the extremity of a given line showing the coefficient to which it corresponds.

in proportion to the horizontal distances.) We shall use similar diagrams for showing the correlation in the various lots studied. From figs. 5 and 6, it will readily be conceived what is meant when such coefficients of correlation are mentioned as appear in the last columns of tables 1, 2 and 3.

The position of the line *X-Y* is determined in practice simply by finding the coefficient of correlation, then marking off the equivalent proportion of *O-B* above *O*, and of *O'-D* below *O'*,

and connecting these two points by a line. (In the case of correlation between unlike things, modification of this procedure would be necessary; a coefficient of regression is derived from the coefficient of correlation, and this gives the position of the line X - Y . But in such cases as we are dealing with the value of the coefficients of correlation and of regression are the same.)

The method of finding the coefficient of correlation is of course described in text-books of statistical methods. For computing correlation under the particular conditions with which we are here dealing, an improvement over the usual methods is described in a recent paper by the present author ('11).

TABLE 9

Coefficients of correlation in length between the members (A and B) of pairs in the different classes of cultures of Paramecium (compare tables 1-3)

WILD CULTURES, OF MIXED RACIAL COMPOSITION				PURE RACES				
Lot	Table	Number of pairs	Coefficient of correlation	Lot	Race	Table	Number of pairs	Coefficient of correlation
1	11	180	0.398±0.030	9	<i>c</i>	43	125	0.132±0.042
2	36	142	0.268±0.057	10	<i>k</i>	44	26	-0.193±0.090
3	37	82	0.507±0.049	11	<i>k</i>	15	14	-0.137±0.125
4	38	42	0.499±0.055	12	<i>k</i>	46	78	0.367±0.047
6	39	136	0.428±0.033	13	<i>k</i>	47	168	0.184±0.036
7	40	79	0.333±0.048	24	<i>k</i>		122	0.210±0.041
22	55	102	0.359±0.041	14	<i>Nf</i> ₂		21	0.295±0.095
23	22	148	0.245±0.037	15	<i>Nf</i> ₂		25	0.257±0.089
	and			16	<i>C</i> ₂	48	150	0.507±0.029
	23			17	<i>C</i> ₂	49	69	0.318±0.052
				18	<i>g</i>	50	84	0.251±0.049
				19	<i>g</i>	51	87	0.323±0.046
<i>Mixtures of two species, both conjugating</i>								
		31	0.939±0.010					
	10	170	0.940±0.004					
<i>Mixtures of two species, only one conjugating</i>								
	54	49	0.408±0.064					

CORRELATION IN DIFFERENT CLASSES OF CULTURES

Turning now to an examination of the coefficients of correlation of the various lots, as shown in tables 1, 2 and 3, we find that we may distinguish four different classes: (1) wild cultures, of unknown racial composition; (2) wild cultures known to contain pairs of the two species, aurelia and caudatum; (3) cultures consisting of a single pure race; (4) mixtures of two known races. It will be well to consider these separately. The coefficients of correlation for these classes are summarized in table 9.

Wild cultures of unknown racial composition

Tables 1, 3 and 9 give us the correlation for eight lots of this class. We find positive correlation in every case, the coefficients ranging from 0.245 to 0.507, with an average for the entire eight

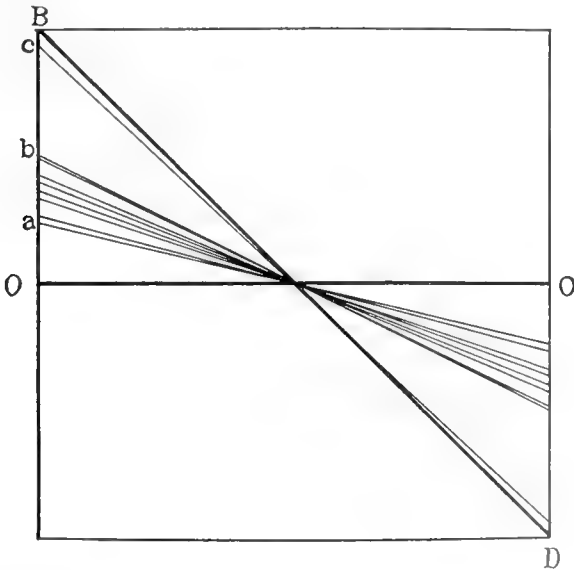

Fig. 7 Diagram illustrating the extent of correlation in the eight 'wild' cultures of tables 1 and 3 (at *a* to *b*), and in the mixture of two species in lot 27 (at *c*). Beginning at *a* the lines show in order the coefficients of correlation for lots 23, 2, 7, 22, 1, 5, 4, 3, (at *b*); then that for the mixture of two species at *c*.

O-O, mean and line of no correlation; *B-D*, line of complete positive correlation (compare figs. 5 and 6).

of 0.380. In the five series studied by Pearl the coefficients were higher, ranging from 0.430 to 0.794, with an average of 0.614. Fig. 7, *a* to *b*, illustrates the correlation in our eight wild cultures. The actual relations of the individuals of various lengths to their mates are shown for lot 1 in table 11 and fig. 5; for lot 3 in table 37 and fig. 8.

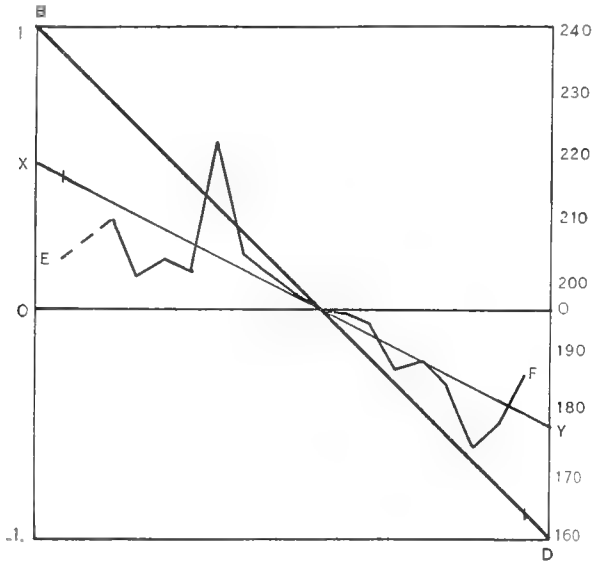

Fig. 8 Diagram illustrating correlation in lot 3 ('wild' culture). *B-D*, lengths of the classes of individuals in order of size. *E-F*, lengths of the mates for these classes. *X-Y*, regression line showing the general trend of the broken line *E-F*, and indicating by the proportion of the line *O-B* which it cuts off, the value of the coefficient of correlation (0.507). *O-O*, mean length for the entire lot. The numbers at the right show lengths in microns.

Since we now know that wild cultures often contain a number of races of diverse sizes, the question arises whether the correlation may not be a result of this fact. If members of large races conjugated only with other members of large races, and members of small races likewise mated only together, there would result a positive correlation, provided that more than one race were undergoing conjugation at the same time. If such interracial selectiveness were the only basis for the correlation, we should

of course find no correlation on studying conjugating pairs that all belonged to a single pure race. To get light on this matter, we may examine the correlation (a) in cases where there were known to be two greatly differing races (two so-called species); (b) in cases where members of but one race are present.

Cultures containing pairs belonging to two different species

In two cases I was able to obtain conjugants from cultures containing both *Paramecium caudatum* and *P. aurelia*. These two species, as is well known, differ considerably in size, but very little in other external features.⁷ What happens when members of the two species, mingled together, conjugate at the same time?

Simultaneous conjugation of the two was obtained as follows: Material known to contain *Paramecium caudatum* in large numbers was brought into the laboratory, and mixed with cultures of the *aurelia* race *k*. About a week after the mixture was made, the conditions became favorable for conjugation, and both species mated. The resulting matings are shown, for the culture from which the largest numbers were measured, in table 10.

From this table it is clear that the large individuals of *caudatum* mated exclusively with other *caudatum*; the small individuals of *aurelia* only with other *aurelia*. The two cultures of this sort that were examined gave coefficients of correlation in length, of 0.939 ± 0.010 and 0.940 ± 0.004 , respectively; so that the correlation was almost perfect. Careful examination of all the pairs measured gave no single case in which it appeared, to the practiced eye, that *caudatum* had mated with *aurelia*.

Thus when *caudatum* and *aurelia* are present together in a culture, they do not intermix in conjugation,—certainly not to any marked extent, and apparently not at all. (Simpson, '01, saw two cases of what he believed to be conjugation between *aurelia* and *caudatum*. The ex-conjugants' died after one fission. It is of course possible that crosses might be induced by proper isola-

⁷ For a detailed account of the differences between the two, see Jennings and Hargitt, '10.

tion, even though they do not occur in nature, or occur there but rarely).

Our results with two species are then favorable to the idea that correlation is produced by members of related races conjugating together. We now turn to the records for conjugation within a single race.

TABLE 10

Correlation table for the lengths of 170 pairs from a culture containing pairs of both aurelia and caudatum (correlation, 0.940 ± 0.004). The unit of measurement is four microns (0.004 mm.,) (so that the first pairs to the left have members measuring 112 and 108 microns in length)

	28	29	30	31	32	33	34	35	36	37	38	39	40	41	42	43	44	45	46	47	48	49	50	51	52	53	54	55	58	59			
27	2	1	2																												5		
28	1	3																														4	
29		1	3	2	1	1																										8	
30			4	1	1		1	1																								8	
31				4	2	2	2	1	1																							12	
32					3	4	4	1																								12	
33						4	3	2	2	1																						12	
34							1	5	2	3	2																					13	
35								2	4	1	1	2																				10	
36									1	1	1	1																				4	
37										2	3	1																				6	
38											1		1																			2	
39																																	
40													1																			1	
41																																	
42															1	2					1											4	
43																1	1	1														3	
44																						1	1	1	1	1						5	
45																							1	1	1							3	
46																						1	1	1	1							4	
47																						2	2	2	1		1					8	
48																						3	1	3	2	1		1				12	
49																						2	3	1	4			1				11	
50																						2	1	2	2							7	
51																						1	1	2								4	
52																							2	2	1	1		1	1			7	
53																							1		2		1	1				4	
54																																	
55																																	1
	3	5	5	10	7	10	12	11	10	5	6	5	2	2	1	1	3	1	1	8	5	13	9	14	6	2	3	5	1	1	1	170	

Conjugation within pure races

The coefficients of correlation in length for twelve conjugations within pure races (all the conjugating individuals being derived originally, in each case, from a single specimen) are given in tables 2, 3 and 9; they are illustrated in the diagram of fig. 9.

Examination of the tables and the diagram shows that the correlation is indeed considerably less in the pure

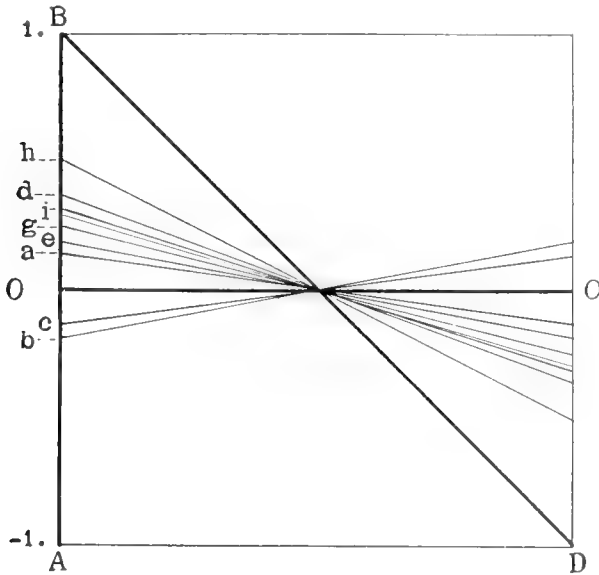

Fig. 9 Diagram illustrating the correlation in the eleven lots composed of pure races, of table 2. *O-O*, mean and line of no correlation; *B-D*, line of complete positive correlation. *a*, lot 9; *b*, lot 10; *c*, lot 11; *d*, lot 12; *e*, lot 13; *g*, lots 15 and 18; *h*, lot 16; *i*, lots 17 and 19. Just beneath *i* is the line for lot 14.

racess than in the wild cultures. This is seen in comparing fig. 9 with fig. 7. From the first three coefficients of table 2 (0.132, -0.193, and -0.137) we might conclude indeed that significant correlation is quite absent within a pure race. But on examining the entire twelve lots from pure races, we find that this conclusion will not hold. In all save the two lots just mentioned the correlation is positive; and these two in which it

was found negative are small, containing respectively but 26 and 14 pairs; they have been included in our account merely to illustrate the results reached if insufficient numbers are employed. Other, much larger lots of this same race k (lots 12, 13 and 24 of tables 2 and 3) gave significant positive correlation. Further, we have in lot 16, from the pure race C_2 , a large lot (150 pairs) giving the high correlation of 0.507 ± 0.029 .

We must conclude then that there is really positive correlation in length in the members of pairs even when all belong to the same race. The fact that it is much less in amount than in mixed cultures is however of much significance. Fig. 10 illustrates the very slight correlation in the large sample of lot 9 (race c) while fig. 11 shows a similar diagram for lot 17 (race C_2). The average coefficient for the twelve lots from pure races is but 0.251, as against 0.380 for our eight wild cultures, and 0.614 for Pearl's wild cultures. The difference in these averages is illustrated in fig. 12.

The smaller correlation found in pure races, as compared with mixed cultures, casts much light on the causes of the correlation. It indicates most directly, of course, that in wild cultures individuals belonging to the same race, or to races of similar size, tend to mate together. The bearing of this most important conclusion on other problems we shall bring out later. Here we shall take up certain other evidence indicating this tendency of members of the same or like races to conjugate together.

In wild cultures it is frequently found that members of diverse races are conjugating at the same time. This is demonstrated by isolating pairs of different sizes, and finding that they produce progeny of permanently different characteristic sizes. We may cite here a single case, described in an earlier paper (Jennings, '08, p. 494). Six races of diverse size (including the large race L_2 with average length of about 200 microns and the small race C_2 , with average length of about 125 microns) were derived from six differing pairs of conjugants taken from a single culture January 29, 1908.

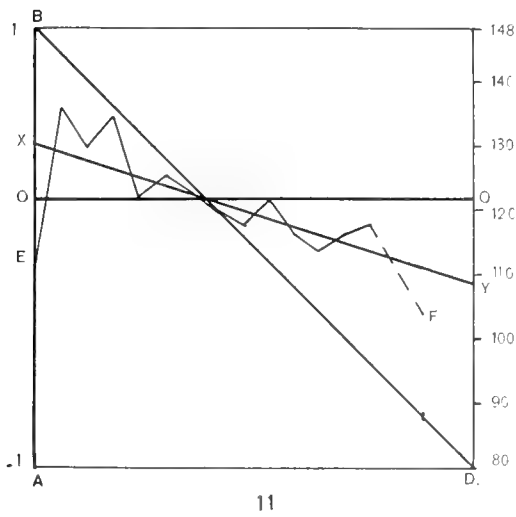
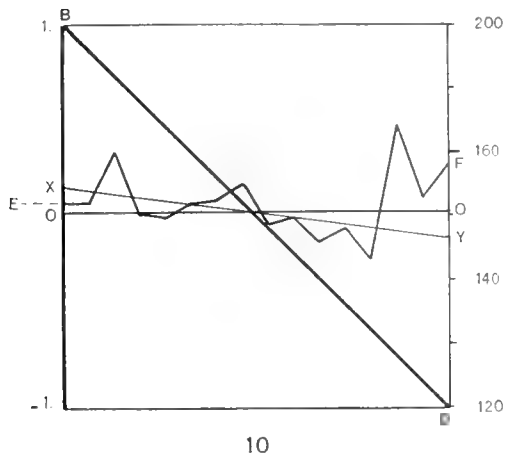

Fig. 10 Diagram for correlation (0.132) in the pure race *c* of lot 9. For explanation, compare fig. 8, page 38.

Fig. 11 Diagram for correlation (0.318) in the pure race *C*₂ of lot 17. Lettering as in fig. 8, page 38.

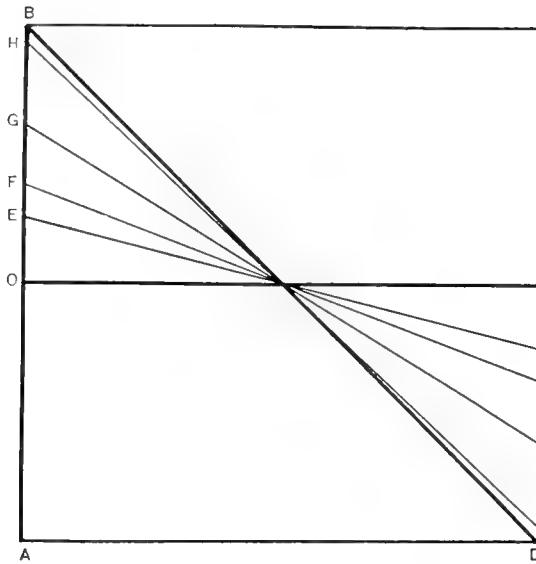

Fig 12 Diagram showing the average correlation in length between the members of pairs in wild cultures of one and of two species, and in pure races. $O-O$, mean; also line of no correlation; $B-D$, line of complete positive correlation. E , average correlation (0.250) for the twelve pure races of tables 2 and 3. F , average correlation (0.380) for the eight wild cultures of the present paper (tables 1 and 3). G , average correlation (0.614) in the five wild cultures studied by Pearl ('07). H , average correlation (0.940) for the two lots of table 3 where two species were present, both conjugating.

Mixtures of two known races

When cultures are formed by mixing two or more diverse races of known characteristics, it is extremely difficult to induce the members of both races to conjugate at the same time. I kept many such mixtures for months but only once did I succeed in getting both races to conjugate at once. This was in a culture containing the races i and k (both aurelia). The race i is very small, averaging but 95 to 100 microns in length, while k is larger, averaging about 125 microns in length.⁶ The two races had been living together in the same culture about five months (from

⁶ For measurements of these races, see Jennings '08.

November 8, 1908) when conjugation was observed in the culture March 1, 1909. Unfortunately the conjugation was scanty, so that only five pairs were found. Three of these measured respectively 78 x 76, 78 x 76, 82 x 76 microns; the other two 138 x 138 and 138 x 140 microns (compare fig. 13). It is clear that the first three pairs belonged to *i*, the last two to *k*. Had we a large number of pairs of these two races, it is clear that we could form a correlation table from the culture as a whole that would

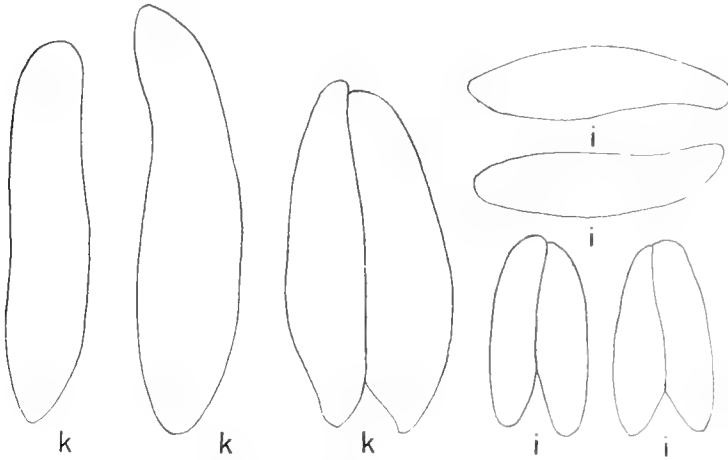

Fig. 13 Conjugants and non-conjugants from a culture composed of a mixture of the two aurelia races *k* and *i*, showing that each pair is composed of individuals of but one race,—either of *k* or *i*. $\times 333$.

show a high degree of correlation. The *i*'s would all fall in the upper left-hand corner of the correlation table, the *k*'s in the lower right-hand corner.

Thus in this case the individuals of each race conjugated only with members of their own race. In most cases where conjugation occurs in a culture containing two known races, it is limited to the members of one race, as I have already set forth (p. 22). This fact that two races conjugate at different times has of course the same tendency as assortative mating, in preventing admixture of races.

Before proceeding to further discussion of the causes and effects of the correlation of the conjugating individuals, it is important to examine certain other points.

TO WHAT IS DUE THE INCOMPLETENESS OF CORRELATION?

As we have seen (tables 1, 2, 3, etc.), correlation between the members of pairs is never complete, but in most cases is a certain positive amount, less than 1.000. It is important to realize as nearly as possible to what biological relations this corresponds. Why, if there is correlation at all, should it not be complete correlation?

Incompleteness of correlation may be due to a number of different conditions, the more important of which we must consider.

1. *Slight differences of less effect than great ones*

Perhaps the most probable cause for incomplete correlation, at least in such material as we are dealing with, would be this: that slight differences in size between the members of pairs do not prove a marked obstacle to their union, while greater differences prevent their uniting. If this is the state of affairs, we should find but slight correlation in collections or parts of collections in which there are but small differences among the individuals; higher correlations where the differences between individuals are great. The highest degree of correlation would be found in the case of a collection composed of two sets, those of each set not differing much among themselves, but the two sets differing considerably.

That the condition we have sketched is the real condition in the conjugation of *Paramecium* is shown in two different ways:

a. We have already seen that when the conjugating culture contains two sets differing greatly (as when *aurelia* and *caudatum* are both present), the correlation is very high; when numbers of less differing races are present, as in ordinary wild cultures, the correlation is less, but still marked; when only the closely

similar members of the same race are present, the correlation is still less.

b. It is shown further when we compute the correlation for portions of the various lots. Take for example lot 1 (tables 8 and 11.) Here we have 360 individuals varying from 148 to 260 microns in length; in the tables these are arranged in 29 classes in order of size. The mean lies at almost exactly 200 microns.

TABLE 11

Correlation table for the lengths of the pairs in lot 1, with lines to show the 'medium' and 'extreme' pairs described in the text and illustrated in fig. 14.

(1) The pairs containing exclusively medium specimens are those in the small square enclosed by the lines a-b-c-d (correlation 0.104). (2) Pairs at least one member of which is of medium size (correlation 0.229) are between the lines c-g and c-e on the one side; b-h and b-f on the other. (3) Pairs at least one member of which is extreme (correlation 0.439) include all those outside the square a-b-c-d. (4) Pairs consisting exclusively of extreme specimens (correlation 0.678) lie outside all the lines drawn within the table.

The unit of measurement is four microns—so that the length 37 for example signifies 148 microns.

	41	42	43	44	45	46	g	h																		
37							1		1																	
38							1		1																	
39									0																	
40	1								2																	
41							1	1	3																	
42							1	1	2																	
43							2		4																	
44							2 2 2	1	10																	
45							3 2 1 2	3 1	19																	
46							1 4 1 1 1	1	11																	
47							a 1 2 5 2 3 2 2	b	20 f																	
48							3 2 6 1 3 1	1 1 1 1	20																	
49							5 5 3 4	2 2	22																	
50							2 6 5 4	3 2	22																	
51							4 4 7	1 1	17																	
52							2 2	3 2 1	12																	
53							1	3 2 1	8																	
54							c	d 1 2	3 e																	
55									1																	
56									0																	
57									1																	
58									0																	
59									1																	
	1	0	0	1	4	8	9	16	13	19	21	22	23	12	14	6	3	4	0	0	1	2	0	0	1	180

Now, suppose that in this culture there existed no specimens near this mean size, but only the larger and smaller specimens. What would be the nature of the correlation? To determine this we must omit all pairs containing medium specimens, and compute the correlation only for those containing extreme individuals. If there were no correlation, no tendency for like to mate with like, we should among these extreme individuals find large specimens matched as often with small as with each other; the correlation would be 0.

Let us consider as 'medium' specimens all those included in the three groups above and the three below the group containing the mean; that is the seven groups nearest the mean, in table 11; these are marked off by the lines *a*, *b*, *c*, *d*. Then the extreme specimens are those lying entirely outside these lines. There are twenty-three pairs containing only such extreme individuals; computing the correlation for these, we find it to have the high value of 0.678 ± 0.054 . For the lot as a whole the correlation is but 0.398 ± 0.030 . If in the same way we compute the correlation for all pairs in which no extreme individuals are present (the 87 pairs within the small square enclosed by the lines *a*, *b*, *c*, *d* in table 11) we find a still smaller coefficient, of but 0.104 ± 0.051 .

To complete the picture, we may ask what the correlation is when we select *all* medium individuals as principals, and compute their correlation with their mates, whether the latter are 'medium' or 'extreme,' and do the same for *all* extreme individuals. We find that there are 157 pairs belonging to the former group, 93 to the latter. The 157 'medium' individuals are correlated with their mates to the extent of 0.229 ± 0.036 ; the 93 'extreme' individuals are correlated with their mates to the extent of 0.439 ± 0.056 .

Thus we find that there is a steady increase in the positive correlation as we include more and more 'extreme' individuals, the coefficient beginning at 0.104, and becoming successively 0.229, 0.398, 0.439 and 0.678. This is exhibited in the diagram of fig. 14.

These relations are general. I have worked out the correlation for the 'extreme' and 'medium' specimens for a number of

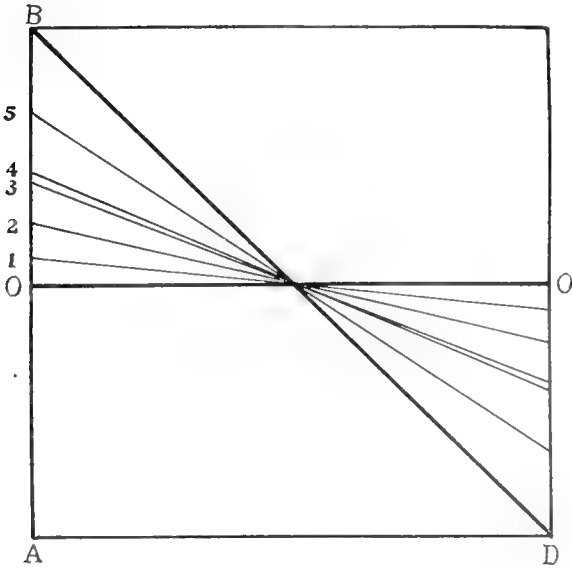

Fig. 14 Diagram showing the different degrees of correlation between members of pairs in lot 1 (table 11), according as we examine the mating of individuals of medium sizes or of those of extreme sizes. *O-O*, mean and line of no correlation; *B-D*, line of complete positive correlation. 1, Correlation (0.104) for pairs consisting exclusively of individuals of 'medium' size. 2, Correlation (0.229) when we take all specimens of medium size as principals, and compare them with their mates. 3, Correlation (0.398) when all specimens, of all sizes, are included. 4, Correlation (0.439) when we take all specimens of 'extreme' size as principals and compare them with their mates, of whatever size. 5, Correlation (0.678) for pairs consisting exclusively of individuals of extreme sizes. (For the sizes considered 'medium' and 'extreme' see table 11).

the lots mentioned in tables 1 and 2. The results are shown in table 12. Column 1 answers the question: What would be the correlation if no extreme specimens existed? Column 2 gives the correlation for the culture as a whole, while column 3 answers the question: What would be the correlation if no specimens of medium size existed?

As appears from the table, in every case the extreme individuals show higher correlation than the 'medium' ones, as well as higher correlation than the culture as a whole. In all cases save

TABLE 12

Correlation between the members of pairs (a) for extreme individuals only, as compared with the correlation for (b) medium individuals only, and (c) for the entire collections, including both medium and extreme specimens. (Column IV shows what are arbitrarily considered 'medium.' specimens for the lot in question; the extreme specimens are those lying outside the limits designated medium)

LOT	I		II		III		IV CONSIDERED 'MEDIUM'
	MEDIUM PAIRS		ALL PAIRS		EXTREME PAIRS		
	Num- ber of pairs	Coefficient of correlation	Num- ber	Correlation	Num- ber	Correlation	
<i>(Wild culture)</i>							
1	87	0.104±0.051	180	0.398±0.030	20	0.678±0.054	188-212
2	45	0.320±0.064	142	0.268±0.057	29	0.518±0.092	157-173
3	39	0.015±0.076	82	0.507±0.049	16	0.830±0.052	184-204
6	59	0.421±0.072	136	0.428±0.033	19	0.614±0.096	172-192
7	27	0.021±0.130	79	0.333±0.048	22	0.477±0.111	160-172
<i>(Pure races)</i>							
9	36	-0.127±0.111	125	0.132±0.042	34	0.176±0.112	144-156
16	49	0.256±0.090	150	0.507±0.029	41	0.843±0.022	120-136
19	27	0.052±0.129	87	0.323±0.046	16	0.681±0.090	112-124
<i>(Random mating)</i>							
.A ₁₁	45	0.051±0.100	105	-0.108±0.046	16	-0.192±0.162	163-177
C ₁₁	29	0.187±0.121	101	0.045±0.047	27	0.000±0.092	167-182

one, the correlation for the 'medium' individuals is less than that for the culture as a whole. Further, on the whole, the greater the correlation of the lot as a whole, the greater the difference between the correlation of the 'medium' and the 'extreme' specimens.

It may be well to note that this greater correlation of the extremes is by no means a necessary result of mere arrangement in a correlation table. If the individuals are merely paired at random, there is no significant correlation either in the culture as a whole, or in the extreme pairs. This may be illustrated from the random pairings made by Pearl ('07). Pearl wrote on separate slips of paper the lengths of all the individuals concerned in the pairs; mixed these together, and drew out two at a time, forming thus 'random pairings.' He did this for two lots, A and C, containing respectively 105 and 101 pairs of conjugants. I have worked out the correlation for the medium and extreme specimens for the tables so formed (Pearl's tables A 11 and C

11). The results are given in the last two rows of our table 12. As there appears, the extreme pairs do not show positive correlation, any more than do the rest of the collection.

It is further to be noted that this higher correlation between the extreme specimens than between the specimens of medium size is not a necessary consequence of the existence of a considerable degree of positive correlation in the table as a whole, — though it is doubtless a very common accompaniment of such positive correlation. But it is easy to form tables showing a marked degree of positive correlation, in which the correlation of the extreme parts is not greater than that of the medium parts.

Why small differences between the individuals should not act so precisely in determining correlation as do large differences will be clear to anyone who considers carefully the process of mating, as described on previous pages. The difficulty in pairing caused by slight differences between the two individuals concerned is readily overcome by slight curving, shifting, etc., while great differences are not so easily remedied. Hence specimens differing much do not often unite, while those differing but little unite readily. Thus the correlation tables may be expected to exhibit many pairs in which the two members differ slightly, — and this of course prevents the correlation from being complete.

2. Different categories of pairs following different rules

A second condition that would result in incompleteness of correlation would be the existence in the lot of different categories of pairs, following different rules. A certain set might, taken by themselves, give complete or nearly complete positive correlation, while another set, following different rules of union, might show little or no positive correlation, or even negative correlation. The lot might then give as a whole but a moderate degree of positive correlation.

Is there any ground for suspecting the existence of such diverse categories of pairs in our material?

Careful examination of the pairs shows that there is such ground. The assumption on which is based the explanation

of the existence of positive correlation is that the pairs in conjugation place their anterior tips in contact, so that in the pairs as we find them the anterior ends of the two members should be even, as in fig. 3, *c*, *e*, *i*, etc. Pearl ('07, p. 267) notes that this is on the whole approximately true in most pairs; he does not give measurements on this point. But examination of a large number of cases shows that (as Pearl further noted) the anterior tips are not always even.

Now, if placing the anterior tips evenly together results (as it should) in high positive correlation, then if in any cases the anterior tips are not placed evenly together; if the anterior tip of one individual is placed some distance from the tip of the other individual (as in fig. 15, *b*, *c*, *e*), then this would naturally result, for such pairs, in less positive correlation, or in no correlation, or even perhaps in negative correlation.

We might perhaps then expect to find at least two categories of pairs, giving different results so far as correlation is concerned: (1) those with anterior tips even; (2) those in which the anterior tip of one individual projects beyond that of the other.

I have made an analysis of certain cultures with relation to this matter, with the following results:

First, as we have before seen, observation shows that the two members of a pair are by no means always equal, but that numbers of unequal pairs are found. A number of such are shown in fig. 15. Cases of extreme inequality sometimes occur, but such are rare. In one of the pairs of lot 2 (table 1), the anterior tip of one individual extends forward thirty microns beyond that of the other—that is, about one-fifth of the length of the latter. Fig. 15, *b*, shows a pair in which the smaller is less than three-fourths the length of the larger.

Unevenness at the anterior ends. In four lots of conjugants I undertook to measure the differences between the anterior tips of the pairs. The measurements taken are necessarily somewhat gross in comparison with the minute absolute amounts that one individual projects beyond the other, but by using large numbers we may get results that will be accurate enough to indicate the real conditions. We may call the individual that

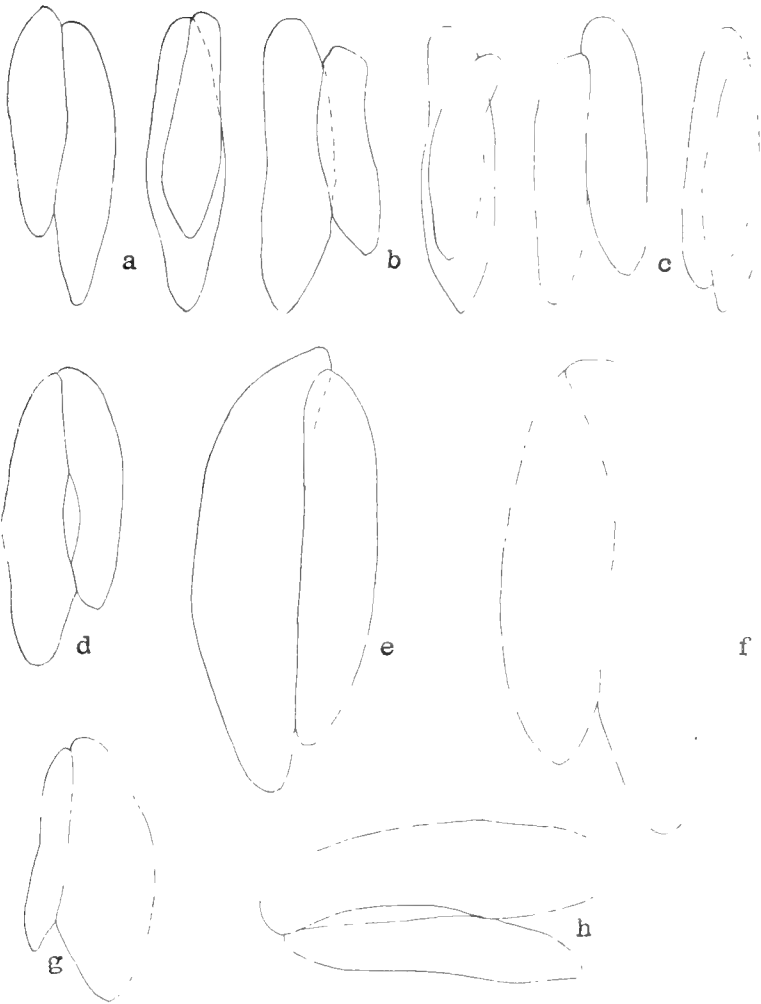

Fig. 15 Unequal pairs. *a* to *d*, pairs of the aurelia race *c*; *e* and *f*, pairs of caudatum; *g* and *h*, pairs of the aurelia race *C*₂. *a*, *b*, and *c* give each two views of certain unequal pairs. $\times 333$.

projects farther anteriorly *A*, the other *B*; the measurements then show, beside the total length of *A* and *B*, the amount that *A* projects in front of *B*. One of the four lots thus analyzed was a 'wild' culture, the others were pure races.

The wild culture examined was lot 2 (table 36); the unit of measurement in this case was 2 microns. Pairs in which the difference at the anterior ends was less than 1 micron were considered even. The results for lot 2 are given in table 13.

TABLE 13

Distance that one member (A) of a pair projects in front of the other (B), in a 'wild' culture (lot 2, table 36)

	0	2	4	6	8	10	12	14	16	18	30	TOTAL NUMBER OF PAIRS	MEAN LENGTH OF ALL, IN MICRONS
Projection of <i>A</i> in microns.....													
Number of cases.....	61	9	23	15	15	10	4	2	1	1	1	142	165.04
Per cent of total number of pairs....	43.0	6.3	16.2	10.6	10.6	7.0	2.8	1.4	0.7	0.7	0.7		

Thus of the entire 142 pairs, 61 (or 43 per cent) were even at the anterior tips, while 81 (57 per cent) were more or less uneven. The amount of projection of *A* was rather slight; in 123 pairs, or 86.6 of all, it was less than 5 per cent of the mean length of the individuals.

From pure races there were examined from this point of view one lot from race *C*₂ and two lots from race *g*. These are both races of aurelia, and of about the same size, the mean length of the conjugants falling, in all three lots, between 118 and 124 microns. In these cases the unit of measurement was 4 microns instead of 2. The facts are given in table 14.

In these cases we find respectively 33.3, 45.2 and 46 per cent in which the anterior ends are even. The amount of difference at the anterior end is again rather slight. A difference of 8 microns is about 6.5 per cent of the means length in these cases; this difference is exceeded, in the three lots, respectively by 11.5, 1.2 and 8 per cent, of all.

TABLE 14

Amount that one member (A) of a pair projects beyond the other (B), in three lots from pure races

Projection of A, in microns....							TOTAL NUMBER OF PAIRS	MEAN LENGTH
	0	4	8	12	16	20		
Lot 17: Race <i>C</i> ₂								
Number of cases.....	23	24	14	5	3		69	121.91
Per cent of all.....	33.3	34.8	20.3	7.2	4.3			
Lot 18: Race <i>g</i>								
Number of cases.....	38	37	8	1			84	123.37
Per cent of all.....	45.2	44.0	9.5	1.2				
Lot 19: Race <i>g</i>								
Number of cases.....	40	30	10	6	1		87	118.28
Per cent of all.....	46.0	34.5	11.5	6.9	1.1			

Now, from the theory as to the cause of the correlation, we should expect to find that the individual *A*, projecting in front of *B*, is as a rule larger than *B*. (We shall later show that the length from anterior tip to mouth is so correlated with the entire length that this must be true.) This being so, we should perhaps expect that the individual *A*, which projects farthest forward, should likewise project farthest backward, thus overlapping *B* at both ends. (If however the two specimens merely came together at random, and any parts of the oral surfaces united, then there is no reason why the specimen projecting anteriorly should be larger, and as a rule the specimen that extended farthest forward would not extend so far backward,—one specimen being merely displaced forward as a whole, with reference to the other).

Examination of a number of cultures from this point of view shows that as a rule it is true that the specimen extending farthest forward is the larger and likewise extends farthest backward. The facts for five cultures are given in table 15.

As the table shows, the specimen *A*, projecting anteriorly, is larger than *B* in from 83 to 91 per cent of all unequal pairs, while it is smaller than *B* in but 2 to 11 per cent. Further, *A* projects beyond *B* backward as well as forward in 51 to 67 per cent of all, while *B* extends beyond *A* in the rear in but 10 to 28 per cent of all.

TABLE 15

Proportional number of cases in which the individual A, which projects in front, is larger than B, and projects behind it as well as in front

LOT	TOTAL NUMBER OF PAIRS	NUMBER OF PAIRS UNEQUAL	A LARGER		A SMALLER		A PROJECTS BEHIND		B PROJECTS BEHIND	
			Absol- ute no.	Per cent	Absol- ute no.	Per cent	Absol- ute no.	Per cent	Absol- ute no.	Per cent
2	142	81	68	84.0	9	11.1	54	66.7	23	28.4
7	79	36	30	83.3	5	13.9	26	72.2	6	16.7
17	69	46	40	87.0	2	4.3	28	60.8	8	17.4
18	84	46	41	89.1	1	2.2	31	67.4	5	10.9
19	87	47	43	91.5	1	2.2	24	51.1	5	10.6

Thus, where one member of a pair extends further forward than the other, that member is usually larger. We should therefore expect that in pairs where one member extends further forward than the other the difference in length between the two members would be greater than in the case where the two are even at the anterior end. We should further expect that the difference in size between the two members would be greater, the greater the amount that *A* projects anteriorly beyond *B*. The facts with regard to these points are given in table 16.

The difference between the two members was taken in units 2 or 4 microns, in different lots; in the table the grouping is by intervals of 4 microns. The number of pairs showing the larger differences is of course small; on this account I have thought it well to give the probable errors, as well as the number of pairs in each case.

The table shows clearly that the difference between the members of the pairs is greater in pairs in which one individual projects anteriorly in front of the other, and the greater the projection, the greater the difference. These things are by no means matters of course; if it were merely necessary for the animals to coalesce by any part of the oral surfaces that came in contact, they would not be true.

TABLE 16

Average difference in length, in microns, between the members of pairs, in relation to the distance that one member (A) extends in front of the other (B)

DISTANCE A PROJECTS IN FRONT OF B, IN MICRONS	(ANTERIOR ENDS EVEN)													
	0		2-6		6-10		10-14		14-18		18-22			
LOT	TOTAL NUMBER OF PAIRS	MEAN DIFFERENCE IN LENGTH	NUMBER OF PAIRS	MEAN EXCESS OF A IN LENGTH	NUMBER OF PAIRS	MEAN EXCESS OF A IN LENGTH	NUMBER OF PAIRS	MEAN EXCESS OF A IN LENGTH	NUMBER OF PAIRS	MEAN EXCESS OF A IN LENGTH	NUMBER OF PAIRS	EXCESS OF A IN LENGTH	NUMBER OF PAIRS	
2	142	8.62±0.70	61	10.20±1.37	40	12.30±1.57	27	18.80±3.35	10	9.33±3.50	3	34.00	1	
7	79	8.56±0.66	43	10.46±1.26	26	12.00±2.02	9			12.00			1	
17	69	6.96±0.94	23	6.00±0.79	24	17.16±1.20	14	19.20±1.13	5	16.00±5.52	3			
18	84	3.79±0.35	38	8.86±0.76	37	15.00±1.00	8	16.00		1				
19	87	5.64±0.52	39	7.87±0.84	31	15.20±1.45	10	20.00±1.39	6			9.00	1	

We may now pass to an examination of the correlations in the uneven sets, as compared with those for the even sets, and for the cultures as a whole. As before remarked, we should expect the correlation to be greatest in pairs that are even at the anterior end, least in those uneven at the anterior end. This is because pairs of the former sort will, from what we have already shown, have members nearly equal, which is the condition that produces high correlation; while the latter set will be unequal, giving low correlation. The facts for four cultures are given in table 17.

To understand table 17, it is necessary to recall the method of computing correlation in the case of pairs composed of two similar members. In all such cases the correlation is referred to the mean of *all* the individuals; it shows whether, when one individual diverges from the common mean of all, the other individual tends likewise to diverge from this mean in the same direction. The correlations computed in this way are shown in the first three columns of the table; only the values given in these three columns are strictly comparable. As shown in these three columns, the correlation in the case of the pairs in

which one individual extends anteriorly beyond the other (as in fig. 15, *b*, *c*, *e*) is much less than in the pairs that are even at the anterior end, when the correlation is measured in the same way in the two cases. It is also much less than in the lots taken as wholes (column 1). In three of the four lots no correlation is detectable in the uneven pairs (column 3), the coefficients computed being less than the probable errors.

In the case of the uneven pairs (such as shown in fig. 15), the two members have of course a distinguishing mark, since the individual *A* projects in front of the individual *B*. We may then properly ask whether the assortative mating does not show its effect even in these cases, if we compare the *A*'s with the *B*'s. As the projecting individual *A* becomes larger, does not the other individual *B* likewise become larger? This is not shown by the correlation computed with reference to the common mean of all, as in the first three columns. To discover whether, when *A* increases in size, *B* likewise tends to increase, we must compute the correlation using the independent means and standard deviations of *A* and *B*, as in ordinary correlation work with unlike units in the two classes. The results are shown in the fourth column of table 17. Here we see that the correlation is rather high; as *A* becomes larger, *B* likewise becomes larger.⁹ The effects of the assortative mating are therefore seen in the pairs that are not even at the anterior ends, as well as in those that are.

Another point is worthy of particular notice. Although the correlation in total length, in the case of pairs that are even at the anterior end, is greater than for the culture as a whole, it is by no means complete, or even approximately complete. Now, in these pairs, the distance from anterior end to mouth is the same in the two individuals. Since the correlation in total length is not complete, it is evident that the remainder of the length, behind the mouth, is not the same in the two individuals. This is further shown in table 16, which gives in the first column

⁹ In the case of the infusoria in which it is known that a large individual regularly mates with a smaller one, probably the correlation would have to be computed as in the fourth column of the table. This would certainly be the case if the two members had other distinguishing marks.

TABLE 17

Correlation in length of members of pairs (1) in which the two anterior ends are even; (2) in which the anterior end of one individual (A) extends in front of that of the other (B)

LOT	TABLE	TOTAL NUMBER OF PAIRS	CORRELATION FOR ALL PAIRS		ANTERIOR ENDS EVEN		ANTERIOR END OF A PROJECTING IN FRONT OF THAT OF B	
			1	2	NUMBER OF PAIRS	2	NUMBER OF PAIRS	3 Correlation referred to mean of all (A + B), as in columns 1 and 2
2	36	142	0.268±0.057	61	0.547±0.043	34	-0.033±0.082	0.315±0.104 (see note)
7	40	79	0.333±0.048	43	0.449±0.058	36	0.232±0.075	0.552±0.078
17	49	69	0.318±0.052	47	0.591±0.045	22	-0.091±0.101	0.318±0.052 (see note)
18	50	84	0.251±0.049	38	0.762±0.032	46	0.032±0.070	0.503±0.074

Note: In lots 2 and 17 the method of subdivision was varied, in order to determine the effect on the correlation. In lot 2 the set with 'anterior end of A projecting' includes only those in which A extended beyond B eight microns or more. In lot 17 the set 'anterior ends even' includes those in which the anterior end of A extended not more than six microns beyond that of B, the other set the rest. In the other lots the division was as precisely as possible into even and uneven sets.

the average differences in total length for the individuals whose anterior ends are even. Thus conjugant individuals that are equal in length from the anterior end to the mouth are not necessarily equal in entire length. This might be due either to (1) an equalizing of the parts in contact, in individuals where they were not originally equal, or (2) to variation in the proportion of the parts anterior to and posterior to the mouth, in different individuals, before conjugation began. The point will come up again later.

Thus, we have shown that the incompleteness of the correlation in length between the members of pairs is due (1) partly to the fact that small differences between the individuals do not much affect the mating, while large differences do; (2) partly to the fact that while in certain pairs the anterior ends are placed evenly in juxtaposition, giving high correlation, in others they are not, giving little or no correlation. But even in the latter cases we found that there is marked correlation if we ask whether

when A increases in size, B does not increase also, thus referring the correlation to separate means.

We shall find other factors affecting the degree of correlation, in the next matter to be treated.

CAUSES OF THE CORRELATION

From our account thus far, there can be no doubt of the existence of some degree of correlation in size between the members of pairs, in the collections of conjugants which we measure. We have seen that Pearl explains this as due to assortative mating. But this is not the only condition which might produce such correlation, so that we must now enter upon a critical examination, with experimental tests, of the various possible explanations. The following have been suggested, or are possible causes:

1. Assortative mating.
2. Equalization during mating.
3. Change of size during union.
4. Differential contraction due to the killing fluid.
5. Local or temporal differentiations in the culture from which the pairs are taken.

These we shall take up in series, concluding with a discussion of the light thrown on this matter by the correlation in breadth.

1. Assortative mating

We have already seen much of the evidence for holding that the correlation is due to actual assortative mating. Here we enter upon a more precise analysis of the relations involved.

If assortative mating occurs and is the cause of the correlation, as set forth by Pearl, then, as Pearl remarks, it depends primarily on the relative lengths of the animals from the anterior end to the mouth, since these are the regions that must fit together in mating. The correlation between the total lengths of the conjugants would be a secondary result of this; it would be due to the fact that "individuals in which the distances from the anterior end to the mouth are equal would not be greatly different in total

length, and hence their lengths will be correlated" (Pearl'07, p. 267). That is, the total length should be on the whole proportional to the distance from anterior end to the mouth; in other words, there should be a marked correlation between these two dimensions.

Examination of our figures will show that this proportionality is by no means invariable or absolute. In fig. 15, *d* and *f*, for example, where the distance from anterior end to the mouth is the same for the two members of each pair, the total lengths are very different.

a. *Correlation between the length anterior to the mouth and the total length.* In order to determine what degree of correlation actually exists between the length anterior to the mouth and the

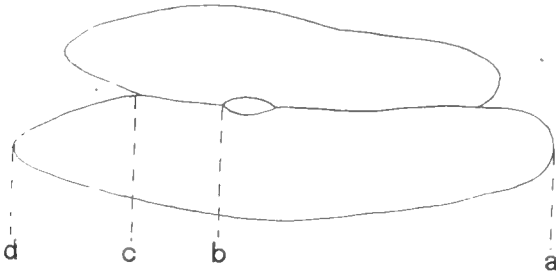

Fig. 16 Diagram to illustrate the measurements taken. See text.

total length, I made measurements of the two dimensions in question, and of certain other dimensions, in a number of lots of conjugants and non-conjugants. The other measurements made were, for certain cases, the distances from the anterior end to the point where the bodies of the two conjugants separate behind. The measurements made and the constants deduced from them throw an important light on conjugation, as well as on the general variation of Paramecium. They are therefore presented in table 18.

The measurements given in table 18 will be understood from an examination of fig. 16, where the measurements taken are shown for one individual of the pair. The measurements are; (1) the total length; (2) the distance from the anterior end

TABLE 18

Dimensions, proportions and correlations of certain lots of conjugants and non-conjugants, with relation to the problems of assortative mating. The two individuals of a pair are denominated A and B

		WILD CULTURE, LOT 7		RACE G, LOTS 18 AND 19		
		158 conjugants, (table 40)	94 non- conjugants, (table 41)	168 conjugants, lot 18 (table 50)	174 conjugants, lot 19 (table 51)	118 non- conjugants, lot 19 (table 52)
(A) Total length	Mean	168.71±0.63	183.79±1.24	123.57±0.41	118.28±0.52	135.35±1.02
	Standard deviation	11.66±0.44	17.79±0.88	7.80±0.29	10.11±0.37	16.49±0.72
	Coefficient of variation	6.91±0.26	9.68±0.48	6.31±0.23	8.55±0.31	12.18±0.54
(B) Length in front of mouth	Mean	108.81±0.34	115.49±0.70		74.21±0.30	82.61±0.62
	Standard deviation	6.30±0.24	10.11±0.50		5.77±0.21	9.98±0.44
	Coefficient of variation	5.79±0.22	8.76±0.43		7.78±0.28	12.08±0.51
(C) Length behind mouth	Mean	59.90±0.44	68.30±0.69		44.07±0.32	52.75±0.50
	Standard deviation	8.24±0.31	9.92±0.49		6.31±0.23	7.98±0.35
	Coefficient of variation	13.76±0.52	14.53±0.73		14.31±0.52	15.14±0.68
(D) Length to point where the pairs separate behind	Mean			99.77±0.39	92.78±0.47	
	Standard deviation			7.52±0.28	8.68±0.32	
	Coefficient of variation			7.54±0.28	9.36±0.35	
(E) Length posterior to point where pairs separate behind	Mean			23.81±0.32	25.58±0.37	
	Standard deviation			6.22±0.23	7.18±0.26	
	Coefficient of variation			26.10±1.02	28.09±1.11	
(F) Proportion of entire length lying in front of mouth (mean index)	65.00±0.16%	62.95±0.19%		62.85±0.15%	61.10±0.19%	
(G) <i>Coefficients of Correlation</i>						
1. Total length of individual A— with same of B	0.333±0.48			0.251±0.49	0.323±0.046	
2. Part before mouth in A—with same in B	0.840±0.016				0.626±0.031	
3. Part behind mouth in A—with same same in B	0.036±0.053				0.157±0.050	
4. Part before mouth, with total length of same individuals	0.743±0.024	0.894±0.014			0.832±0.016	0.919±0.010
5. Part before mouth, with part behind mouth of same indi- viduals	0.261±0.050	0.570±0.047			0.383±0.046	0.671±0.034
6. Part anterior to point of separa- tion with total length of same, individual				0.676±0.028	0.723±0.025	
7. Part anterior to point of separa- tion with part posterior to same				0.378±0.045	-0.217±0.049	

a to the mouth b (the distance was taken to the posterior angle of the mouth); (3) the distance from the mouth (posterior side), to the posterior tip ($b-d$, fig. 16); (4) the distance from the anterior tip a to the point c , where the bodies of the two conjugants separate behind; (5) the distance from this point c to the posterior tip d . These two dimensions (4) and (5) were not taken in all cases.¹⁰ The measurements illustrated in fig. 16 were of course made for both members of the pairs, as well as for non-conjugants, so far as applicable to these. Such measurements were made for one wild culture, of unknown racial composition (lot 7 of table 1), and for two lots of the pure race g (lots 18 and 19 of table 2). The results are given in table 18.

The first point in which we are interested is the correlation between the entire length, and the length from anterior tip to the mouth, as given at G , 4, in the table. This correlation is high, the coefficients being 0.743 and 0.832, respectively, for the two lots of conjugants, 0.894 and 0.919 for the non-conjugants. It would therefore seem amply sufficient to account for the degree of correlation found between the total lengths of the two members of the pairs. Indeed, possibly we should expect, on this basis alone, that the latter correlation should be higher than it is, since it is but 0.333 and 0.323 in the two lots of conjugants just mentioned. We have however seen certain reasons why the correlation in total length is relatively low, and a further study of the data of table 18 gives other grounds for this.

b. *High variability of the posterior region.* We find in the conjugating pairs that while the length of that part of the body lying in front of the mouth is relatively uniform (coefficients of variation 8.76 and 7.78 in lots 7a and 19a), that part lying behind the mouth is much more variable (coefficients 13.76 and 14.31 in lots 7a and 19a); the variation is almost twice as great in the latter.

¹⁰ It is often very difficult to determine the exact position of the mouth, so that it was at first thought that the point where the two members of the pair separate behind (c , fig. 16) would serve the same purpose. This turned out not to be the case, since the two do not follow the same rules. It was later found that by placing the animals in weak glycerine the position of the mouth could usually be determined. The measurements to the point of separation have some interest in themselves, and are therefore given in the table.

c. *Low correlation of parts before and behind mouth.* Furthermore, the correlation between the length in front of the mouth, and that behind the mouth is low, amounting to but 0.261 and 0.383 for the conjugants in question (table 18, *G*, 5). Thus two individuals that are equal in the distance from anterior end to the mouth will often be unequal in the remainder of the body. As a result, although they conjugate accurately, they will be unequal in total length, thus tending to make the correlation of length to length less than 1.00 in the collection to which they belong. This point came up earlier, in connection with tables 16 and 17 (p. 58).

d. *Correlation of pairs greater for parts anterior to mouth.* The point just made is further illustrated by another fact. If we compute for the pairs the correlation of the lengths anterior to the mouth in the two individuals (table 18, *G*, 2) we find this correlation much higher than that for the total lengths (*G*, 1). The correlation of the two individuals for lengths anterior to the mouth is 0.840 and 0.626, respectively, as against 0.333 and 0.323 for total lengths. The great decrease in the latter as compared to the former is evidently due to the variable proportions of the posterior part of the body to the anterior part,—this variable proportionality being either original, or produced by equalization of the parts anterior to the mouth during conjugation (a matter for later consideration).

e. *Low correlation of parts posterior to mouth.* Conversely to the point made in the preceding paragraph, we find the correlation of the parts posterior to the mouth for the two members of a pair (table 18, *G*, 3) to be much less than that for the total lengths. In lot 7*a* correlation between the posterior parts is lacking or too slight to be detected (coefficient, 0.036 ± 0.053); in lot 19*a* it is very small (coefficient 0.157 ± 0.050).

The correlation of total length in the two members is then due almost entirely to the correlation between the distances from anterior tip to the mouth in the two. This correlation might be due either to equalization in the process of uniting, or to assortative mating; a point which we shall take up in a moment.

f. *Region in front of the point where the two conjugants separate.* With regard to the distance from the anterior end to the point where the two individuals separate behind (*a-c.* fig. 16), table 18 shows (1) that this distance is more variable than that from the anterior tip to the mouth (and more variable than the total length) (lot 19); (2) that its correlation with the total length (table 18, *G*, 6) is less than in the case of the distance from anterior tip to mouth; (3) that the length of the part *behind* the point of separation is extremely variable, the coefficient of variation rising to 26.10 and 28.09 in the two lots examined; (4) that the correlation between the length anterior to the point of separation, and that behind the point of separation is *negative* (table 18, *G*, 7),—so that on the whole the greater the length of the region where the two animals are in contact, the shorter the region behind this, where they are free. All this shows, of course, that the point to which the union of the two individuals extends is not a constant and predetermined one, but that on the contrary, the relative length of the united regions differs greatly in different cases. If this were not the case, the correlation between the length anterior to this point and that posterior to it would be positive, as is the case for the length anterior to the mouth and that posterior to it. Evidently, while in conjugation there is always union as far back as the mouth, the further distance to which the union extends is extremely variable.

2. *Equalization during mating*

Certain important points as to what occurs in conjugation and how the positive correlation is brought about, appear on comparing in table 18 the conjugants with the non-conjugants.

We find that about the same proportion of the body lies in front of the mouth in both conjugants and non-conjugants, the mean proportion varying from 61 to 65 per cent in the different cases (*F*, table 18). In the conjugants, as we have seen, this region anterior to the mouth is much less variable than that posterior to the mouth,—the coefficients of variation from the former being 5.79 and 7.78, as opposed to 13.76, 14.53 and 14.31 for the latter.

But in the non-conjugants the variability of the part anterior to the mouth is much less reduced; the coefficients are 8.76 and 12.08, as opposed to 5.79 and 7.78 for the corresponding conjugants. The variability of the part posterior to the mouth is about the same in the non-conjugants as in the conjugants (coefficients for the former 14.53 and 15.14; for the latter, 13.76 and 14.31). Thus, *in the conjugants the variability of the region anterior to the mouth has been reduced, while that posterior to the mouth has not.* Furthermore, *the correlation between the length anterior to the mouth, and that posterior to the mouth, (table 18, G, 5) is much diminished in conjugants* (coefficients of correlation for the conjugants, 0.261 and 0.383, as compared with 0.570 and 0.671 for the corresponding non-conjugants). Remembering that it is the parts anterior to the mouth that become fitted together in conjugation, while those behind the mouth do not, it is clear that these two facts indicate strongly that *there has been an equalization of the two regions in contact*, by curving, contraction, stretching, etc., for this would reduce both the variation, and the correlation with the unchanged posterior part, exactly as we find to be the case. It would likewise result in making the correlation between the posterior parts of the two conjugants much less than that of the anterior parts, as table 18 shows to be the case. Such equalization we have before seen to occur, by direct observation of the conjugants (see above, p. 27); here we see that it affects the measurements and constants to a marked degree.¹¹ This agrees with a number of facts previously set forth in this paper; we have repeatedly had occasion to point out that an equalization in the region anterior to the mouth would wholly or partly account for some of the relations described. To it are partly, if not mainly, due the fact that individuals which conjugate with anterior ends even are not completely correlated in length (p. 59); the related fact that conjugants that are equal in the region from anterior end to the mouth are not equal in the

¹¹ It is perhaps worth while to note the fact that the account of the equalization based on direct observation (pp. 26, 27) was written exactly as it stands, before the computations that indicate the same thing were made, and before I had even suspected that the measurements would show it.

remainder of the body; the much greater variability of the part posterior to the mouth, as compared with that anterior to the mouth, in conjugants; the low correlation between the part anterior to the mouth and that posterior to the mouth, in conjugants; the very much greater correlation between the lengths of the two conjugants from anterior end to mouth, than between total lengths, or between parts posterior to the mouth.

We have here a fact of capital importance; there occurs in conjugation a process of equalization, of such a character as would produce correlation in length between the two individuals, even if such correlation did not exist before the two united. And this equalization affects strongly our statistical results.

The question of course at once arises: Is not this the entire explanation of the correlation between the members of pairs? Is there any reason for assuming assortative mating at all?

Correlation of members of pairs after separation. To answer this question requires further experimentation. If the correlation is due to the contraction, extension and curving of the body undergone in the process of union, it will be found only in the animals that are actually united. As soon as the contraction, curving, etc., ceases, the correlation will disappear. Now, careful observation shows that the contraction, curving, etc., do cease after the pairs separate; the animals regain completely their normal form, and increase much in size, as we have seen. If therefore, we measure the members of the pairs some considerable time after they have separated, we shall be able to determine whether the correlation is due merely to the actual conditions during the period of union.

I have carried out this operation in a number of cultures, some of them pure races, others 'wild' mixtures. For this purpose the pairs are isolated in hollow ground slides and kept, all under identical conditions, till the two animals separate. After separation they are further kept until about time for the first fission to occur. Then the pairs are killed separately and measured, usually in comparison with a considerable number that had been killed before separation. In this way, further, one can study

the correlation of the parts anterior and posterior to the mouth, in the separated conjugants, determining whether the peculiarities in these dimensions found in the conjugating individuals are due to the fact of union or to actual differentiation of the conjugants.

The constants for variation and correlation for the two members of pairs that have separated some time before the measurements were made are shown in table 19, together with comparative data for the unseparated conjugants.

The pairs were isolated in the morning. A certain number of them were killed at once. The rest were kept alive. At 6 p.m. it was found that the pairs were separating, many being already apart. The animals were then kept till noon the next day. Thus they were killed at least twelve, and probably eighteen, hours after separation.

Examination of table 19 shows clearly that the correlation is not due to the contraction, extension and curving involved in the process of conjugation, nor does it depend in any way upon the state of actual union, for it persists undiminished for twelve hours or more after separation has occurred. Careful examination of the animals shows that the contraction, curving, etc., has quite disappeared in the separated individuals (and this is further demonstrated by the measurements to be set forth later).

Indeed, not only is the correlation undiminished in the separated pairs; it is actually greater in every case than in the pairs still united. This greater correlation after separation might be due to a number of different causes:

a. Possibly it indicates that the alterations in form during conjugation actually decrease the correlation instead of increasing it. If the correlation of the undistorted members were considerable, then irregular contraction and curving such as occurs in the process of union, would decrease it.

b. A more probable ground for the greater correlation of the separated pairs lies in the greater accuracy with which they can be measured. The two members of a united pair are not accurately parallel, but lie oblique to one another, owing to the obliqueness of the oral grooves by which they are united. This

TABLE 19

Constants of variation and correlation in length for members of pairs of conjugants killed some hours after separation, as compared with those for pairs from the same cultures killed while still united

LOT	DATE 1910	NUMBER OF INDIVIDUALS	NUMBER OF PAIRS	TABLE	RANGE OF VARIATION	MEAN LENGTH	STANDARD DEVIATION	COEFFICIENT OF VARIATION	CORRELATION							
22	Aug. 31	Wild; caudatum														
		a. Conjugants still united.....	12	204	102	55	152-208	176	14±0	48	10	08±0	34	5.72±0	190.359±0.041	
23	Sept. 1	b. Same about 12 hours-after separation.....	12	276	138	56	155-260	212	46±0	69	16	07±0	49	7.99±0	230.411±0.034	
		Wild;caudatum														
	Sept. 21	a. Conjugants still united.....	12	296	148	22+23	152-208	179	80±0	41	10	42±0	29	5.80±0	160.245±0.037	
		b. Same about 12 hoursafter separation.....	12	268	134	57	152-252	200	04±0	79	19	18±0	56	9.34±0	280.358±0.036	
24	Sept. 11	Race <i>k</i> (aurelia)														
		a. Conjugants still united.....	41	244	122	59	100-144	118	92±0	33	7	54±0	23	6.34±0	19.0.210±0.41	
25	Sept. 19	b. Same about 12 hoursafter separation.....	41	266	134	60+61	88-168	144	87±0	40	9	59±0	25	6.62±0	190.432±0.033	
		Race <i>k</i> (aurelia)														
		Conjugants killed about 12 hours after separation	41	355	178	67+68	100	168	132	96±0	43	12	07±0	31	9.08±0	230.231±0.031

obliqueness is very evident when the pairs are examined with a binocular microscope; it is indicated in fig. 3, *i* and *k*. As a result of it, when the entire length of one member of a pair is shown, the other will be a little foreshortened. Thus the measurements taken will indicate that the two are less nearly equal than they really are, and this of course will reduce the correlation. In the case of the separated pairs, this difficulty is not met, since the two individuals are measured separately.

c. Another cause, which might actually increase the measured correlation after separation, would lie in the increase of size which takes place after the separation of the pairs (see page 21). If the interval of time since separation varies in the different pairs (as is of course the case), then some will have increased in size more than will others. But the interval since separation will of course always be the same for the two members of a given pair. The result will then be a series of pairs differing in size, giving thus marked positive correlation between the members. It seems probable that this is the chief ground for the actual increase in correlation after the pairs separate.

Observation shows however that the relative sizes during union are retained after separation (so far as this can be shown without actual measurements of the living united pairs). In many cases I noted that certain pairs, when first seen, were unusually large or unusually small, or unequal. When they were measured, twelve to eighteen hours after separation, this was still true.

In any case it is clear that the correlation in the united pairs is not due to the temporary change of form during union, since it persists after union ceases. The correlation is not due to the equalization in mating.

Change in variability and in correlation of parts after separation. In a preceding section we saw that the individuals of the united pairs differ very markedly in certain respects from non-conjugants. We have now an opportunity to determine whether these peculiarities of the united conjugants are due to a differentiation of these conjugant individuals, existing quite independently of the act of union; or whether they are merely the result of the exist-

ence of the union, with its accompanying change of form. These peculiarities of the conjugants were as follows:

a. The variability of the part anterior to the mouth is greatly reduced, as compared with the case of the non-conjugants.

b. The correlation between the length anterior to the mouth, and that posterior to the mouth, is greatly reduced in the united conjugants.

c. The correlation of the two members of a pair is much greater for that part of the body anterior to the mouth than it is for the total length of the body.

If these peculiarities are, as our previous examination had seemed to indicate, merely the result of the changes during union, then they should disappear after the pairs have separated and the individuals have reassumed their usual form. We may therefore get light on this matter by comparing these relations in the conjugants before separation and in those after separation. The data for this comparison are given in tables 18 and 20. These show the following:

1. The variability of the part anterior to the mouth is not greatly changed after the conjugants separate (table 20, *B*). In the wild culture of lot 22 the variability did indeed increase after separation, from 5.60 to 7.28, but in the pure race (lot 24) it remained substantially the same. Of course the separated conjugants include no young specimens, while the non-conjugants (table 18) include both young and old. It is therefore not to be expected that the variability will reach the same degree in the former as in the latter. The data do not indicate that there is any great change in the variability of this part, owing to the mere act of conjugation.

2. The reduction of the correlation between length anterior to the mouth and that posterior to the mouth quite disappears after the cessation of union. In the united conjugants we find in tables 18 and 20 coefficients of correlation between these parts of but 0.261, 0.383 and 0.277, while in the separated conjugants the correlations are 0.649 and 0.488 (table 20, *G*, 5). The same lot that shows a coefficient of 0.277 while conjugating, has a coefficient of 0.488 after conjugation has ceased. This is additional

TABLE 20

Dimensions, proportions and correlations of conjugants after separation, as compared with those for pairs still united. The two individuals in a pair are denominated A and B. Compare table 19

	WILD CAUDATUM OF AUG. 31-SEPT. 1, 1910 LOT 22		WILD CAUDATUM OF SEPT. 21-22, 1910 LOT 23		RACE k (AURELIA) OF SEPT. 11-12, 1910 LOT 24		RACE k (AURELIA) OF SEPT. 19, 1910		
	102 pairs still united Table 55	Conjugants after separation, 276 specimens Table 56	148 Pairs still united Tables 22+23	134 Pairs after separation Tables 57 and 58	122 Pairs still united Tables 59, 62, 64	134 Pairs after separation Tables 60+ 61, 63, 65, 66	178 pairs after separation, Tables 67+68		
A. Total length	Mean	176 14±0.48	212.46±0.61	179 80±0.41	200.94±0.79	118.92±0.33	144.87±0.40	132.96±0.43	
	Stand. dev.	10 08±0.34	16.97±0.46	10 42±0.29	19 18±0.56	7.54±0.23	9.59±0.28	12.07±0.31	
	Coef. of var.	5.72±0.19	7.99±0.23	5.80±0.16	9.54±0.28	6.34±0.19	6.62±0.19	9.08±0.23	
B. Length in front of mouth	Mean	111 02±0.44	128.64±0.38			71.33±0.20	86.76±0.23		
	Stand. dev.	6 21±0.31	9.37±0.27			4.58±0.14	5.60±0.16		
	Coef. of var.	5.60±0.28	7.28±0.21			6.42±0.20	6.45±0.19		
C. Length behind mouth	Mean	66 13±0.51	83.83±0.38			47.59±0.21	58.10±0.22		
	Stand. dev.	7 22±0.36	9.34±0.27			4.75±0.15	5.43±0.16		
	Coef. of var.	10.91±0.56	11.14±0.32			9.98±0.31	9.35±0.28		
D. Proportion of entire length lying in front of the mouth		63.0%	60.6%			60.0%	59.9%		
E. Breadth	Mean	29 21±0.18	43.08±0.19		47.96±0.27	29.02±0.16	45.97±0.16		
	Stand. dev.	2 66±0.12	4.58±0.13		6.59±0.19	2.81±0.11	3.89±0.11		
	Coef. of var.	9.11±0.43	10.63±0.31		13.75±0.41	8.98±0.39	8.47±0.25		
F. Proportion of mean breadth to mean length		16.6%	20.4%		23.9%	24.4%	31.7%		
G. Coefficients of correlation									
1. Total length of individual A with same of B		0.359±0.041	0.411±0.034	0.245±0.037	0.358±0.036	0.210±0.041	0.432±0.033	0.231±0.034	
2. Part before mouth in A with same in B			0.400±0.034			0.435±0.035	0.370±0.036		
3. Breadth of A with same of B			0.356±0.034		0.295±0.038		0.325±0.037		
4. Part before mouth with total length (of same individual)			0.912±0.007			0.820±0.014	0.886±0.006		
5. Part before mouth with part behind mouth (of same individual)			0.649±0.024			0.277±0.040	0.488±0.031		
6. Total length with total breadth (of same individual)			0.622±0.025		0.648±0.024		0.504±0.031		

proof of the fitting and change of form in the anterior region during the union.

3. This same thing is still more clearly shown by the change in our third point. In the two members, *A* and *B*, of the united pairs, the correlation of the parts anterior to the mouth (that of *A* with that of *B*) is double the correlation between the total lengths of *A* and *B*. But after separation the correlation is practically the same for the two dimensions. This is shown in table 21.

TABLE 21

Correlation of parts anterior to the mouth, as compared with correlation of total length, in conjugants (1) during union, and (2) after separation

1. CONJUGANTS DURING UNION	CORRELATION BETWEEN PARTS ANTERIOR TO MOUTH	CORRELATION BETWEEN TOTAL LENGTHS
Lot 7, table 18	0.840±0.016	0.333±0.048
Lot 18, table 18	0.626±0.031	0.323±0.046
Lot 24, table 20	0.435±0.035	0.210±0.036
2. CONJUGANTS 12 HOURS AFTER SEPARATION		
Lot 22, table 20	0.400±0.034	0.411±0.034
Lot 24, table 20	0.432±0.033	0.370±0.036

From all these facts it is clear that the parts anterior to the mouth are fitted to each other during union, giving high correlation. After separation the change of form that brought about the fitting disappears, so that the correlation for this part becomes no greater than that for the body as a whole. The correlation for the entire body however persists undiminished.

Correlation of pairs not due to equalization. These facts of course demonstrate completely that the correlation in total length is not due to the contraction, curving, stretching, etc., that takes place in fitting one conjugant to the other, for this correlation is fully as great after the change of form due to this fitting has quite disappeared. There is clearly an assortative mating that is quite independent of this fitting process, larger individuals mating with larger, smaller with smaller.

Another conceivable method of equalization is discussed by Pearl ('07). He suggests that this might occur by a passage of fluid from the larger to the smaller individual of the pair. He points out that this would be a process requiring some time, and that therefore, if this were the explanation of the correlation, the latter should be higher in pairs that have been in conjugation for some time, than in those in the early stages of the process. By sorting out those in early stages of the process (as shown by the nuclear conditions), and comparing them with those in later stages, Pearl showed that this is not the case. The same thing will be shown experimentally later in this paper; pairs taken in the earliest stages of conjugation give as high a coefficient of correlation as those which have been united several hours (see table 24 and the adjoining discussion).

Of course there is absolutely no indication from any source whatever that any appreciable quantity of cytoplasm passes from one member of the pair to the other. Thus the suggestion of equalization by this means is one so entirely without foundation as to hardly require for its disproof the evidence above given.

3. Change of size during union

A cause that might conceivably produce correlation between the members of pairs is the following: The conjugants might change in size in some typical way, either decreasing or increasing, during the period in which union continues. Thus, if they decrease in size, the pairs at the beginning of the period of conjugation would be large; those near the end of the period would be smaller, and intermediate ones would show intermediate sizes. If we took then a collection containing pairs in various stages of this process, we should find a marked degree of correlation in size.

It is therefore important to determine whether such a typical change of form occurs during union. For this purpose I tried the following experiment. A wild culture of *Paramecium caudatum* was placed, on the evening of September 20, 1910, under conditions favorable for conjugation (many specimens in a shal-

low watch glass). At this time there were no conjugants in the lot. Now, as Maupas ('89, p. 171) has noted, under such conditions *Paramecium caudatum* begins conjugation in the early morning. At five o'clock the next morning rare scattering pairs were found. Others were beginning to unite, so that as I watched them the number of pairs increased rapidly. Beginning at six a.m. I picked out about 200 pairs as quickly as possible; all these were isolated, with no admixture of non-conjugants, before seven

TABLE 22

Correlation table for lengths of conjugants of lot 23 in the earliest stages of conjugation. (Unit of measurement, 4 microns)

	40	41	42	43	44	45	46	47	48	49	50	51	52
38						1							1
39	2			1				1					4
40	1			1				1					3
41		1	2	2	1			2					8
42			3	4	2	2	2	1		1			15
43				7	2	2	1	3	1				16
44					2	2	5		1		1		11
45						3	4	2	3	1		1	14
46							1		3	3	2		9
47								2	6	1	1	1	12
48										1			1
49											1		1
	3		1	7	15	11	14	11	17	8	5	2	1 95

a.m. At this hour I killed about one-half the lot; their measurements are given in table 22. This includes pairs in only the early period of union. The remainder were kept for five hours, till noon; then these were killed; their dimensions are given in table 23. If there is any typical change of size during conjugation, comparison of these two tables will show it, since in the latter table the animals have been in conjugation five hours longer than in the former. Furthermore, if such change of size is the cause of the correlation, then a table comprising both sets together should give a higher coefficient of correlation as well as a higher coefficient of variation than either of the tables alone; and notably higher

than the coefficients for the pairs in the early stages of union (table 22). The data for the two lots separately and for both together are given in table 24.

As table 24 shows, there was no change in size during the five hours of union between the taking of the first and second sets.

TABLE 23

Correlation table for lengths of conjugants of lot 23 in later stages of conjugation. (Unit of measurement, 4 microns)

	42	43	44	45	46	47	48	49	50	51
40							1			1
41	2	1			2	1				6
42	2	1	5	1	1		1	1	1	13
43			1		3	3				7
44				1	2	1	1			5
45				2	5	1		1	1	10
46					1	2	2	1		1 7
47						1	1	1		3
48										
49									1	1
	4	2	6	4	14	9	6	4	3	1 53

TABLE 24

Constants of variation for the pairs of lot 23, after different periods of union

	NUM- BER OF PAIRS	MEAN	STANDARD DEVIATION	COEFFICIENT OF VARIATION	COEFFICIENT OF CORRELATION IN LENGTH
Pairs in the earliest stage of union: 7 a.m.....	95	179.79±0.53	10.79±0.37	6.00±0.210	303±0.044
Pairs that have been united more than five hours: 12 m....	53	179.81±0.64	9.72±0.45	5.41±0.250	118±0.065
Pairs in early and late stages of union taken together (sum of the two foregoing)....	148	179.80±0.41	10.42±0.29	5.80±0.160	245±0.037

The mean lengths for the two sets are perhaps nearer together than one would usually hope to get them for two samples of the same material. Further, there is no increase of variation nor of correlation when we unite the pairs that have been but a short time in conjugation with those that have been united a long time. In fact the coefficients for the two sets taken together are slightly less than for the lot in the first stages of union, though the differences are merely those that might be expected when two samples of the same material are examined. It is clear therefore that the correlation is not due to any characteristic change in size as union continues.

4. *Differential contraction due to killing fluid*

Another cause which might conceivably produce correlation between the members is the following: A contraction or other change of form due to the action of the killing fluid might vary among the different pairs, owing to the impossibility of all coming in contact with the same concentration of the fluid at the same relative instant. If such differences occurred, they would always be between different pairs, and not between two members of the same pair, because both members of a pair keep together, and would therefore be subjected to identical influences. Thus we should have some pairs that were contracted and therefore short; other longer; the result, when all were taken together, would be to give a correlation in length between the members of pairs.

Any change of form due to the killing fluid is evidently very slight, if it occurs at all; nevertheless, Paramecium does possess a certain contractility and it seemed best to test carefully this possibility. For a time indeed I was inclined to attach considerable importance to it. An opportunity for a test is given by the experiments already detailed, in which the conjugants were measured after they had been separated at least twelve hours. After the pairs have separated of course the two will no longer be subjected to identical action of the killing fluid: all correlation should therefore disappear, if it depends on this action. As a matter

of fact, as we have seen, the correlation does not disappear, and is not even lessened under these conditions.

However, in such experiments, the two members of a given pair are usually killed together in a single minute drop—each pair separately. It might still be maintained that there are accidental differences in the action of the killing fluids on the different drops, causing different degrees of contraction in the different pairs; this would therefore still give us correlation.

In order to test this, in a number of lots, I killed the two individuals of each pair separately, in separate drops. If the factor we are discussing plays any part, it would now act strongly *against* correlation, since the two members of a pair would contract diversely. There should be no correlation in such pairs, if correlation is due to diversity in action of the killing fluid.

In certain lots I had three sets of pairs: (1) those killed while united; (2) the two members separated, but killed together; (3) the two members separated and killed separately. Comparison of these will enable us to set at rest absolutely the question of the part played by any differential contraction due to the killing fluid. The pertinent data are given in table 25.

As this table shows, the correlation persists even when the separated members of pairs are killed separately. Thus the correlation is certainly not due to any differential action of the killing fluid on the different pairs.

One peculiar case in the table requires mention. In lot 24, we find that for the separated pairs in which the two members were killed in the same drop, the coefficient of correlation (0.506) is much greater than for the case where the two members were killed in separate drops (0.230). This taken by itself would seem to indicate that the killing of the two members together does have a decided influence in increasing the correlation. But further examination shows that there is no such indication. First, in this same lot the correlation for the separated pairs killed separately is *greater than for the pairs still united*. It is clear therefore that the positive correlation of the latter is not due to the fact that the two members of the pair were killed together; and this is precisely the question we are putting to the test. Second, in

TABLE 25
 Comparison of conjugants to test a possible production of correlation through differential action of the killing fluid

TABLE	NUMBER OF PAIRS	MEAN LENGTH	STANDARD DEVIATION FOR LENGTH	COEFFICIENT OF VARIATION FOR LENGTH	COEFFICIENT OF CORRELATION FOR LENGTH OF A WITH BREADTH OF A	COEFFICIENT OF CORRELATION WITH BREADTH OF B	
22	Wild; caudatum						
	{ a. Conjugants still united	102	55	176.14 ± 0.48	10.08 ± 0.34	5.72 ± 0.190	359 ± 0.041
	{ b. Separated; killed together	138	56	212.46 ± 0.69	16.97 ± 0.49	7.99 ± 0.230	411 ± 0.0340
23	Wild; caudatum						
	{ a. Still united	148	22 + 23	179.80 ± 0.41	10.42 ± 0.29	5.80 ± 0.160	245 ± 0.037
	{ b. Separated; killed separately	134	57	200.94 ± 0.79	19.18 ± 0.56	9.54 ± 0.280	358 ± 0.036
24	Aurelia (k)						
	{ a. Still united	122	59	118.92 ± 0.73	7.54 ± 0.23	6.34 ± 0.190	210 ± 0.041
	{ b. Separated; killed together	69	60	143.83 ± 0.64	11.16 ± 0.45	7.76 ± 0.320	506 ± 0.052
	{ c. Separated; killed separately	65	61	145.97 ± 0.44	7.41 ± 0.31	5.07 ± 0.210	230 ± 0.056
	{ d. All separated (b+c)	134	60 + 61	144.87 ± 0.40	9.59 ± 0.28	6.62 ± 0.190	432 ± 0.0350
25	Aurelia (k)						
	{ a. Separated; killed together	87	67	151.33 ± 0.60	11.74 ± 0.42	8.90 ± 0.320	254 ± 0.048
	{ b. Separated; killed separately	91	68	133.93 ± 0.62	12.305 ± 0.44	9.19 ± 0.350	202 ± 0.048
	{ c. Sum of a and b	178		132.96 ± 0.43	12.07 ± 0.31	9.08 ± 0.230	231 ± 0.034

the case of the separated pairs killed together, not only is the coefficient of correlation greater, but the variation is likewise much greater than in the case of those killed separately. In the former the coefficient of variation is 7.76, and the range of variation was from 88 to 168 microns, while in the latter the coefficient of variation is but 5.07, and the range was from 128 to 164 microns. Now this great difference in variation cannot possibly be due to the fact that the two members of the pairs were killed together in one case, separately in the other; there is absolutely nothing in this procedure to change the variation. Clearly, the difference between the two lots is purely accidental. Among those taken for killing the two members together, it happened in this particular case that all the extreme specimens fell, leaving the medium individuals for the other lot. Both samples are rather small, so that this is not particularly surprising. Now, we have seen on previous pages that collections containing only specimens of medium size give a lower degree of correlation than do collections containing extreme specimens. This is clearly the explanation of this peculiarity. Such fluctuations in the coefficient of correlation due to the accidents of random sampling are not particularly rare. In one case, random matings of the component dimensions of a series of 125 pairs gave me a negative coefficient of correlation of somewhat beyond -0.500 , though there was absolutely nothing in the process of drawing the numbers from a hat that would tend to induce correlation of any sort.

5. Local or temporal differentiations in the culture

An important possible cause of the production of correlation in the members of pairs is set forth by Pearl ('07) as follows:

It might be maintained that since at different points in the culture and at different times the environment no doubt differs slightly, there would be a corresponding local differentiation of the *Paramecia* in each local culture unit. Then, even though the pairing were quite at random in each locality, yet if the records for several such localities were mixed, a spurious homogamic correlation would arise (p. 256).

Larger pairs would come from one part of the culture, smaller from another, giving of course a positive coefficient of correlation. This result would be much accentuated if the pairs were taken from the cultures at different times, as was actually the case in the study made by Pearl.

Pearl attempts to meet this by taking the two non-conjugant individuals nearest to each pair, and hence from the same environment, pairing these, and making a table of the results. Such pairs give no positive correlation.

I am not convinced that Pearl's procedure fully meets this difficulty. In the non-conjugant population we have to deal with the great variability due to growth. Of the two single individuals lying nearest a pair, one might be old and large, the other young and small. The difference might be much greater than any differential effect of the environment. In the case of the conjugants, on the other hand, this difference in growth plays little or no part. That is, in the non-conjugants we have an important source of variation that is independent of the environment, while in the conjugants we have not. It would appear likely therefore that local environmental differentiations would have much more effect on the correlation of conjugants than on that of non-conjugants.

In the case of the conjugants studied in the present paper this source of error was completely excluded for most of the lots examined, through the method by which they were taken. On the evening before the day the conjugants were desired a great number of individuals, none of whom were conjugating, were taken from the large culture and placed together in a small watch glass. They were thoroughly stirred and mixed in the process. The watch glass contained only water, besides the infusoria. On the following day the animals were conjugating in multitudes. There had been absolutely no opportunity for local differentiations such as might give origin to correlation, yet collections so made showed the same degree of correlation as did others taken from larger vessels. In the case of collections of conjugants taken from large cultures, I removed individuals from only one small region and

all at the same time, so that the results of local differentiation were avoided in these cases also.

The fact that the coefficients of correlation for my samples are notably less than they were for Pearl's (see page 38) perhaps indicates that these local differentiations may have played some part in Pearl's results. As Pearl himself remarks "the samples used in this (his) work were taken in just such a way as would make most pronounced any spurious correlation due to local differentiation resulting from time or place factors. Small samples, a drop or two of culture fluid, were taken from different parts of the culture at intervals of time" (l.c., p. 256). But the results of the present paper show that the effects of this were limited to increasing to a certain extent the degree of correlation observed. They do not account for the existence of the correlation.

6. Other suggested causes

Pearl raises the question "whether these correlations represent any true assortative pairing or merely arise because conjugation goes on within a limited, differentiated portion of the population, which portion, as has been shown above, is much less variable than the non-conjugant population" ('07, p. 254).

It is not apparent how this last mentioned condition could produce correlation, since the latter is not affected in any way by the characteristics of that part of the culture which is not conjugating, and low variation has no tendency to cause correlation. However, Pearl demonstrates fully that this is not the cause of the correlation. He makes random pairings between the measurements of the conjugating individuals, and shows that these exhibit no correlation, as they must do if the explanation just mentioned is correct.

7. Correlation in breadth

In the present paper I have dealt mainly with correlation of the two conjugants in length. It is here that the most important relations show themselves. Furthermore, as Pearl pointed out,

the measurement of breadth in conjugating pairs is very inaccurate, owing to the flattening that takes place as conjugation occurs. Also, the ridge forming the right side of the boundary of the oral groove of one specimen fits into the oral groove of the other, producing an interlocking which makes it almost impossible to determine correctly the breadths of the two individuals.

On these accounts I have not thought it worth while to deal with the breadth in any such full way as I have dealt with the length. Anyone who is interested in a careful analysis of the breadth relations of the two conjugants will find it in the paper of Pearl ('07). I shall take up only a few points not brought out by Pearl.

a. *Flattening at the time of conjugation.* Pearl states that at the time of conjugation there is frequently a dorso-ventral flattening of the two individuals, such as would result from pressing the two together; he gives however no measurements on this point. I have endeavored to obtain some precise data on the matter in certain cases.

In the small race *c* (*aurelia*) (lot 9 of table 2), I measured the amount of flattening in fifty pairs. This was done as follows: The breadth was first measured as the two members of the pair lie side by side, in the usual position. This gives the dorso-ventral breadth. Then the animals were turned till one lies directly above the other; they were kept in this position by placing them in a jelly made from quince seeds in water. In this position the lateral breadth (at right angles to the dorso-ventral breadth) was measured. In almost all cases the lateral breadth was notably greater than the dorso-ventral breadth, showing that the animals were distinctly flattened. The two breadths are shown for these one-hundred conjugants in table 26.

I made the same measurements also for fifty non-conjugants of this same culture. These were likewise flattened in the same way, indicating that the flattening was not due to the pressing of the two conjugants together, but that it existed in this culture independently of conjugation. The dorso-ventral and lateral breadths are given for the non-conjugants in table 27. The conjugants are flattened a little more than the non-conjugants;

TABLE 26

Lateral and dorso-ventral breadths (or thicknesses) of 100 conjugants of lot 9 (race c). (Unit, 4 microns)

		Lateral							
		7	8	9	10	11	12	13	
Dorso-ventral	6		3	1				4	
	7	1	3	6	4	1		15	
	8	1	2	12	11	3	1	30	
	9				15	20	4	39	
	10					9	1	1	11
	11						1		1
		2	8	19	30	34	6	1	100

TABLE 27

Lateral and dorso-ventral breadths (or thicknesses) of 50 non-conjugants of lot 9 (race c)

		Lateral								
		7	8	9	10	11	12	13		
Dorso-ventral	4				1			1		
	5	1			1			2		
	6	1			2			3		
	7	2	1	4	1			8		
	8		2	6	3			11		
	9			2	5		1	8		
	10					4	4	8		
	11					2	3	1	6	
	12						2	2		
	13							1	1	
			4	3	16	9	6	10	2	50

in the former the mean dorso-ventral breadth is 83.4 per cent of the mean lateral breadth; in the latter it is 86.5 per cent.

Thus in certain conjugating cultures there is a notable difference between the dorso-ventral and lateral breadths, even in non-conjugants. It is important however to bring out clearly the fact that *in most cultures of Paramecium, whether conjugating or not, there is no such flattening*. I have made measurements in the same way of several other cultures, and have examined many more, and in no other case have I found any such marked flattening. In this culture of the race *c*, the animals were thin and showed every appearance of being in process of starvation. I believe that this is the explanation of their exceptional dorso-ventral thinness. In most cultures the animals are nearly or quite circular in cross-section.

b. *Correlation in breadth in pairs after separation.* Pearl gives the coefficients of correlation in breadth for three lots of pairs that are still united. It seems worth while to add here the breadth correlations for certain lots measured after the pairs have separated. In such cases there is no such difficulty in making accurate measurements of breadth as we find in the case of pairs still

united. The correlation in breadth for three such separated lots is given in table 20 (*G*, 3). The values for the coefficients (0.356, 0.295 and 0.325) are not far from those found by Pearl for unseparated pairs (0.218, 0.342, and 0.349).

c. Correlation in breadth not due to equalization. It is worth pointing out that the correlation in breadth of the two members of a pair could not be produced by that equalization of the pairs through stretching, contraction, curving, etc., which we have discussed so fully in the foregoing pages. For as the length of the two was made more nearly equal by this process, the breadths would inevitably become more unequal. The shorter member, stretching to match the longer, would become more slender; the longer specimen, contracting to match the shorter, would become broader, thus increasing the differences already existing (existing as a result of the fact that the longer specimens are already broader than the shorter specimens, a fact demonstrated by Pearl ('07) and the present author ('08). Thus the existence of marked correlation in breadth between the members of pairs is in itself a demonstration that the correlation is not due to the equalizing during union; a demonstration made on other grounds elsewhere in this paper (pp. 65-74).

8. *Historical and comparative*

Pearl ('07) was apparently the first to notice the assortative mating in any infusoria, and his study of the matter was more thorough than any other made previously to the present paper. We have dealt so fully with his work in the body of this paper that we need not dwell further on it here.

Collin ('09) observed that in the conjugation of *Anoplophrya branchiarum*, a parasitic ciliate living in the blood of *Gammarus*, the two members of a pair are usually of nearly equal size, although the different pairs differ much in size. He thinks that there is real assortative mating, larger individuals mating with larger, smaller with smaller, as in *Paramecium*. However, a part of the greater similarity of the two members of a pair is in *Anoplophrya* due to the fact that as conjugation progresses the individ-

uals of the culture become smaller. Hence the first individuals that conjugate form large pairs; later ones form smaller pairs, still later ones still smaller pairs,—(although the size of a given pair does not change during conjugation). This does not, Collin thinks, account fully for the similarity in size of the two members of a pair, for even among the individuals that conjugate at any given period one finds much greater resemblance between the two members of a given pair, than between members of diverse pairs. Collin does not give measurements.

Enriques ('08) studied conjugation in *Chilodon uncinatus*, with relation to the problem of assortative mating. He found that a change in form takes place during conjugation, by which the left member of the pair becomes shorter than the right; further, the evidence indicated that the left-hand member was even before conjugation somewhat smaller than the right-hand one. This latter relation would result from the fact that in the process of conjugation, owing to certain peculiarities of form in *Chilodon*, the larger individual always becomes the right-hand member, the smaller one the left-hand member.

Assortative mating was studied with relation to the question whether the two members of a pair tend to be of the *same* size or not. That is, if the member *A* diverges from the mean of *all*, does the other individual *B* likewise diverge in the same direction from the same mean? Enriques studied this question by determining the mean difference between the two individuals of the pairs, and comparing this with the mean difference in length when matings are made at random. In case of assortative mating in the sense above defined, the former value should be less than the latter. Enriques found that in most of his (rather small) samples it was not less; so that there was no indication of assortative mating in the sense defined. But in samples taken toward the end of an epidemic of conjugation, the members of pairs were more alike than were individuals taken at random, so that a degree of correlation is indicated. For two of his lots Enriques worked out the coefficient of correlation; for the early sample the coefficient was zero; for the later one it was 0.4. Thus in the later periods of an epidemic there is an actual correlation in

size between members of pairs. Enriques explains this difference between the early and the late stages of the epidemic in the following way: In the late stages of the epidemic many of the pairs are formed (wholly or partly) of individuals that have already conjugated once in the same epidemic. This fact is determined by studying the nuclear conditions of the pairs; some individuals are found to be undergoing the changes consequent on a previous conjugation. Now, Enriques found in *Chilodon* (as we have found in *Paramecium*) that the ex-conjugants increase in size. Hence those that are conjugating for the second time in any epidemic are larger than those that are conjugating for the first time. Further, Enriques found (by studying the nuclear conditions) that for some reason these ex-conjugants are likely to conjugate together. Thus we get certain pairs, consisting of ex-conjugants, in which both members are large; other pairs, consisting of individuals that have not before conjugated, in which both members are small. This of course results in the production of some considerable degree of positive correlation when the entire lot is examined.

Evidently, the question of main interest is: Why do the large ex-conjugants tend to conjugate together on the one hand; the small individuals on the other? There is clearly assortative mating of some kind. If (as appears probable) it takes place on the basis of relative size, as in *Paramecium*, then the interpretation of the facts in *Chilodon* would be the following: In the early stages of the epidemic the differences in size among the individuals are not great enough to affect the mating, which therefore takes place at random. But in the later period of the epidemic, owing to the appearance of the large ex-conjugants, the differences in size become so great as to prevent the union of the largest and smallest individuals. Hence assortative mating occurs, giving rise to a certain degree of correlation between members of pairs.

Enriques raises the question whether re-conjugation among larger ex-conjugants may not be the cause of the correlation in *Paramecium*. It is quite clear that this is not the case. (1) Pearl ('07) shows that the correlation exists when one includes only individuals showing early stages in the nuclear processes

attendant on conjugation. (2) We have shown above (p. 75) that when pairs are taken in the very first stages of an epidemic, before it has been in progress more than two or three hours, there is still correlation in size in the members of pairs. It may be noted that there appears to be no evidence that in *Paramecium* re-conjugation ever takes place among ex-conjugants.

Attention should be called to the fact that the method used by Enriques does not furnish a test for another possible kind of assortative mating. In *Chilodon*, the right and left members of the pair are morphologically differentiated and the right one is usually larger. Now, it is possible that assortative mating may so occur that when the right member is larger than usual, the left member must also be larger than usual, though it need not be so large as the right one. That is, when the right hand member is above the average size *for right-hand members*, the left member may be above the average size *for left-hand members*. This might still be true, even though the average size for right-hand members were considerably greater than that for left-hand members. If this were the case, then the average difference between the two members of a pair would be greater than the average difference between members of random matings, and yet this would not be evidence against the kind of assortative mating we have mentioned. This kind of assortative mating could be tested by determining the coefficient of correlation between all the right-hand members (entered as X) on the one hand, and all the left-hand members (as Y) on the other, each set being referred to its own mean (as in the usual computation of correlation), instead of to the mean of all. A parallel case for this is set forth for *Paramecium* on p. 58 of the present paper. Unfortunately, Enriques has not given us the correlation tables for the actual measurements of his pairs, so that the existence of this kind of correlation can not now be tested for *Chilodon*.

9. *Conclusions on assortative mating*

The results of our examination of the causes of the correlation between the members of pairs (an examination that can perhaps fairly be designated exhaustive) is to confirm Pearl's conclusion that there is actual assortative mating in *Paramecium*—larger individuals mating with larger, smaller with smaller. This shows its effect in three main categories:

1. When the two species *caudatum* and *aurelia* are conjugating at the same time in the same culture, they do not inter-cross; *caudatum* conjugates only with *caudatum*, *aurelia* with *aurelia*. Since the two species differ in size, this gives very high coefficients of correlation (0.940, in length). The only reason that the coefficient is not actually 1.000 is the fact of incomplete correlation *within* each of the two component species.

2. When races of different size are present, as is usually the case in 'wild' cultures even of a single species, the members of the larger races tend to conjugate together, on the one hand; of the smaller races on the other. The correlation (in length) thus arising is less than when two species are present; it averages about 0.380, in the wild cultures of the present paper.

3. When members of but a single race are present (all descended from a single individual), there is still a notable correlation, larger individuals mating with larger; smaller individuals with smaller. But this process of assortment is considerably less accurate than when diverse races are present; for pure races the coefficient of correlation averages but about 0.250, as against 0.380 for mixtures of races, and 0.940 for mixtures of species.

II. CONSEQUENCES OF THE DIFFERENTIATION OF THE CONJUGANTS AND OF THEIR ASSORTATIVE MATING

What effects in the further history of the organisms result from the occurrence of conjugation? What are the consequences in inheritance, of the decreased size and variability of the conjugants, as compared with the non-conjugants? What consequences follow from the assortative mating of the conjugants?

CONSEQUENCES OF THE DECREASED SIZE AND LESSENERED
VARIABILITY1. *Are the extreme specimens excluded from the new generation?*

Does the decreased size and lessened variability of the conjugants indicate that extreme individuals of the race are excluded from taking part in the new generation, conjugation tending thus to maintain the average racial type unchanged?

As we have seen, the non-conjugant population includes many individuals that are larger, and some that are smaller than any of the conjugants. Are these smaller and larger individuals excluded from participation in the further development of the race?

a. As to the smaller individuals, examination of the comparative tables (tables 34 and 35 of the Appendix) will show that the non-conjugant population usually contains but few individuals smaller than the conjugants, its main differentiation lying in the opposite direction. Now, we have already shown that these small non-conjugants are merely young specimens, that have not yet reached the size for conjugation. A few hours will of course remedy this. The small individuals are then not excluded from conjugation.

b. The main difference between conjugants and the general population is that the latter contains many specimens much larger than the conjugants. Are these larger individuals excluded from conjugation, and so from the further progress of the race? Or are these larger individuals merely temporarily differentiated, their progeny becoming conjugants later?

This matter was tested in a number of cases by removing from a conjugating culture a considerable number of the large non-conjugants, each much larger than any of the conjugants, and keeping them under conditions favorable for conjugation.

Thus, January 30, 1908, I removed from the conjugating culture of lot 6 (table 34) one hundred of the large non-conjugants. On the next day fifty of these were killed and measured; they had a mean length of 211.52 ± 1.99 microns; a mean breadth of

62.48 ± 1.17 . They had multiplied a little during the night, so that this is really less than the original size. The conjugants at the same time had a mean length of but 181.49 ± 0.54 ; mean breadth 48.11 ± 0.87 . The remaining large non-conjugants were allowed to multiply, and on February 24 their progeny were found to be conjugating. The conjugants which they gave were of sensibly the same size as those of the culture as a whole. The mean length, from 21 pairs, was 179.91 ± 0.88 microns; mean breadth 48.19 ± 0.51 (as compared with 181.49 by 48.11 for the culture as a whole).

Thus in this case the large non-conjugants were by no means excluded from conjugation and the farther development of the race. They represented merely a temporary stage, not as yet prepared for conjugation, but ready to enter upon it after a few fissions.

Similarly, from a wild culture *N* there were isolated on March 21, 1908, one hundred of the largest non-conjugants, and a considerable number of pairs of conjugants. Half of each were killed at once; the fifty large non-conjugants showed mean dimensions of 224.16 by 53.36 microns, while the sixty-six conjugants measured 139.94 by 38.55 in mean length and breadth. On the following day numerous conjugants were found among the progeny of the remaining fifty non-conjugants. The large individuals were thus but temporarily excluded from conjugation.

A similar experiment was tried with the small pure race *c* (*aurelia*). On September 27, 1907, I isolated from a conjugating culture ten of the larger non-conjugants (larger than any conjugants); also five pairs of conjugants. These were cultivated side by side, under the same conditions. On September 30 there were conjugants among the progeny of the ten large non-conjugants. (On the following day there were likewise conjugants among the progeny of the pairs.)

Again, from the pure race Nf_2 , I isolated, March 31, ten of the largest non-conjugants; on the following day there were conjugants among these.

Thus, it is clear that the large non-conjugants may later divide, take on the size characteristic of conjugants, and themselves conjugate.

2. *Relative size of progeny of conjugants and non-conjugants; changes in size due to conjugation*

Do the progeny of the large non-conjugants differ in size and variability from the progeny of the (much smaller) conjugants?

The answer to this question is bound up with that to another, so that the two will be considered together. This other question is:

Are there characteristic changes in size resulting from conjugation, so that a race just before conjugation is smaller or larger, or otherwise characteristically different from the same race just after conjugation?

The answer to this question will tell us whether there are characteristic changes in form and size in the different periods of the reproductive cycle (from conjugation to conjugation), for just before conjugation the animals are at the end of the cycle; just after they are at the beginning of it.

To answer these questions experiments were carried out on a number of different cultures. The plan of experimentation was in most cases as follows: From a conjugating culture a sample of non-conjugants was removed; also a sample of conjugating pairs. Part of each of these was killed and measured, thus giving the initial size for each. Then each set was allowed to multiply farther, under rigidly identical conditions for the two sets. Samples of the progeny of each were killed at intervals, and compared as to size. The method of work was varied in different cases, in ways that will be set forth.

This plan of work, simple as it sounds, in reality presents great difficulties in its execution. Each individual must be kept separate, in order that we may know that there has been no conjugation save in the case of the original pairs; and also in order that we may know to what generation of the progeny a given individual belongs. Owing to these and other difficulties, it is not possible to obtain under these absolutely controlled conditions large numbers for comparison of the progeny of conjugants and non-conjugants, though the numbers given in the following are sufficient for answering the main questions.

It will be well to examine first the results in the case of pure lines or races, then to take up 'wild' cultures.

a. *Comparison of progeny of conjugants and non-conjugants in pure races.* The first comparison was made between the progeny of conjugants and non-conjugants all descended from the single individual Nf_2 . In the progeny of this individual conjugations occurred March 31 and April 4, 1908. In each case a random sample of the conjugants and non-conjugants was killed and measured; the relative sizes and variabilities are given in the first four lines of table 28. The non-conjugants were as usual considerably longer, and more variable than the conjugants. On March 31 there were picked out five pairs of conjugants and ten of the largest non-conjugants. In this case the individuals were not kept isolated, but the ten conjugants were kept together in one watch-glass, the ten large non-conjugants in another, under identical conditions. Ten days later (April 10) samples of each of these were measured, giving the results shown in the fifth and sixth rows of table 28. The progeny of the pairs were now a little larger than the progeny of the non-conjugants.

The progeny of the very smallest pair observed on March 31 was kept separate from the remainder. On April 20 its progeny were compared with those from the ten large non-conjugants taken on the same day. The results are given in the last two rows of table 28. The size of the two sets was now very nearly the same (those derived from the small pair were a trifle longer and thinner). The variability of the two sets was now practically identical.

All together this experiment shows the following facts:

1. The progeny both of the small conjugants and of the large non-conjugants increased somewhat in size beyond the original mean for the non-conjugants. This was probably due to the nutritive conditions.

2. The progeny of conjugants became fully equal in size both to the original non-conjugants and to the progeny of these non-conjugants. They were in fact a little larger than the progeny of the non-conjugants, and the difference appears to be significant in comparison with the probable error (at least on April 10).

TABLE 28
Relative size and variability of conjugants and non-conjugants and of their progeny. All derived originally from the single individual Nf₂ (aurelia)

DATE	NUMBER OF SPECI- MENS	RANGE OF VARI- ATION IN MI- LENGTH IN MI- GONS	MEAN LENGTH	STANDARD DEVI- ATION	COEFFICIENT OF VARIATION	RANGE OF VARI- ATION IN BREADTH	MEAN BREADTH
1 Mar. 31, '08 Conjugants	42	124-148	136.95±0.56	5.53±0.41	4.03±0.29	24-44	35.52±0.50
2 Mar. 31, '08 Non-conjugants	34	132-168	144.50±0.92	7.92±0.65	5.48±0.45	28-44	34.00±0.45
3 April 4, '08 Conjugants	50	116-148	132.88±0.64	6.66±0.45	5.01±0.34	23-40	31.08±0.30
4 April 4, '08 Non-conjugants	31	120-188	147.61±2.20	18.18±1.56	12.31±1.07	23-44	35.10±0.53
5 April 10, '08 Progeny of 5 small pairs of Mar. 31	61	120-172	148.20±1.09	12.65±0.77	8.52±0.53	24-56	42.30±0.53
6 April 10, '08 Progeny of 10 large non-conjugants of Mar. 31	65	104-172	137.97±1.16	14.90±0.82	10.07±0.60	28-64	44.00±0.59
7 April 20, '08 Progeny of 1 small pair of April 4	108	120-188	160.85±0.80	12.36±0.57	7.68±0.35	36-56	42.04±0.32
8 April 20, '08 Progeny of 10 large non-conjugants of April 4	103	132-192	156.48±0.78	12.05±0.55	7.50±0.35	36-56	43.82±0.52

3. The variability of the progeny of the conjugants increased and became sensibly the same as that of the progeny of the non-conjugants.

From September 16 to September 26 a similar experiment was carried out with the race of *Paramecium aurelia* that I have called C_2 . The measurements for conjugants and non-conjugants of September 16 are shown in the first two rows of table 29; the non-conjugants are considerably larger. At this time four pairs of conjugants were placed in each of twelve watch-glasses; eight of the large non-conjugants in each of twelve others; the two sets were kept under identical conditions and treated in the same way. The table gives the sizes of the progeny at certain later dates.

As the table shows, the progeny of the conjugants were larger than those of the non-conjugants on September 18; less so on September 23, and smaller on September 26. Possibly the only conclusion clearly justified is that the progeny of the conjugants are not on the whole smaller than the progeny of the (larger) non-conjugants.

From September 25 to 29, 1908, a similar experiment was undertaken with the *aurelia* race g , which is closely similar to C_2 . In this case the second and third generations of the progeny were

TABLE 29

Relative size of conjugants and non-conjugants and of their progeny from the pure line C_2 (aurelia)

DATE	NUMBER OF SPECIMENS	RANGE OF VARIATION IN LENGTH	MEAN LENGTH	RANGE OF VARIATION IN BREADTH	MEAN BREADTH
1 Sept. 16, '08 Conjugants	138	88-148	121.91 ± 0.66		
2 Sept. 16, '08 Non-conjugants	110	104-164	132.18 ± 0.87	24-52	34.91 ± 0.34
3 Sept. 18, '08 Progeny of conjugants	15	108-140	128.00 ± 1.67	28-36	31.20 ± 1.19
4 Sept. 18, '08 Progeny of non-conjugants	70	96-136	116.17 ± 0.73	24-52	31.20 ± 0.45
5 Sept. 23, '08 Progeny of conjugants	56	120-156	132.93 ± 0.84	28-48	35.84 ± 0.42
6 Sept. 23, '08 Progeny of non-conjugants	37	108-152	129.62 ± 1.13	24-48	35.52 ± 0.67
7 Sept. 26, '08 Progeny of conjugants	11	92-136	112.36 ± 1.18	20-40	29.50 ± 1.34
8 Sept. 26, '08 Progeny of non-conjugants	52	100-148	122.15 ± 1.11	28-44	34.81 ± 0.61

compared for the two sets. The results are shown in table 30. In this case the progeny of the conjugants were larger in the second generation; smaller in the third. The numbers obtained were small in this experiment, and under such conditions the size depends much on how recently fission has taken place. The conjugants divided more slowly than the non-conjugants, and the six individuals of the third generation were all apparently young. The results of this experiment then merely show that there is no very marked preponderance of size in the progeny of either set.

TABLE 30

Relative size of conjugants and non-conjugants and of their progeny in the second and third generations, in the race g (aurelia)

DATE	NUMBER OF SPECIMENS	LENGTH		BREADTH	
		Range	Mean	Range	Mean
1 Sept. 27, '08	Conjugants (table 34, lot 19)	174	96-152 118	28±0.52	
2 Sept. 27, '08	Non-conjugants (table 34, lot 19)	118	88-180 135	35±1.02	
3 Sept. 29, '08	Generation 2f from conjugants	15	140-180 154	93±2.11	40-60 45.33±0.97
4 Sept. 29, '08	Generation 2f from non-conjugants	9	132-168 148	89±2.52	40-56 50.22±1.05
5 Sept. 30, '08	Generation 3f from conjugants	6	128-148 135	33±2.24	32-40 36.00±0.64
6 Sept. 29, '08	Generation 3f from non-conjugants	10	144-168 156	40±1.64	40-56 49.60±0.95

A more extensive and precise experiment was carried out with the race *k* (aurelia) from October 19 to 30, 1908. In this experiment the progeny of each of the original individuals was kept isolated. The lengths of conjugants and non-conjugants of this race on September 12 are shown in the first two rows of table 31, while in the remainder of the table the first seven generations of the progeny are compared, generation by generation, for the two sets.

In this case the progeny of the conjugants were larger in the first and second generations. Thereafter the results varied, neither set having a uniform preponderance. On October 30, the last day of the experiment, the progeny of the conjugants averaged a little larger than did those of the non-conjugants.

Thus in these experiments with pure races, we find that the progeny of the (small) conjugants are not smaller than those of

TABLE 31

Relative size of conjugants and non-conjugants and of their progeny for seven generations, in the race k (aurelia)

DATE		NUMBER OF SPECIMENS	LENGTH		BREADTH	
			Range	Mean	Range	Mean
1 Sept. 12 '08	Conjugants (table 34, lot 13)	336	92-156	129.58±0.40		
2 Sept. 12, '08	Non-conjugants (table 34, lot 13)	100	88-168	140.20±0.97		
3 Oct. 21 '08	Generation 1f—from conjugants	37	132-172	152.00±0.87	36-60	45.84±0.75
4 Oct. 21, '08	Generation 1f from non-conjugants	17	136-156	144.94±0.91	36-52	44.47±0.71
5 Oct. 22-25 '08	Generation 2f from conjugants	32	120-164	146.50±1.18	36-56	44.00±0.60
6 Oct. 22, '08	Generation 2f from non-conjugants	31	120-156	138.19±1.15	28-52	38.58±0.70
7 Oct. 25, '08	Generation 3f from conjugants	27	108-160	130.52±1.48	28-52	36.44±0.80
8 Oct. 24, '08	Generation 3f from non-conjugants	17	124-160	143.76±1.60	32-48	41.88±0.81
9 Oct. 25, '08	Generation 4f from conjugants	5	104-144	120.00±5.00	28-40	36.00±1.53
10 Oct. 24, '08	Generation 4f from non-conjugants	27	116-156	133.19±1.38	32-56	42.96±0.91
11 Oct. 26-28, '08	Generation 5f from conjugants	32	108-156	130.25±1.44	28-44	35.38±0.52
12 Oct. 28, '08	Generation 6f from conjugants	39	112-156	131.38±1.12	28-48	35.49±0.52
13 Oct. 28, '08	Generation 6f from non-conjugants	10	128-148	136.00±1.32	32-48	37.60±1.09
14 Oct. 28, '08	Generation 7f from conjugants	95	96-156	129.14±0.72	24-52	35.75±0.41
15 Oct. 28, '08	Generation 7f from non-conjugants	2	140	00		40.00
16 Oct. 30, '08	All existing progeny of conjugants	25	100-152	128.16±1.59	24-52	36.32±0.96
17 Oct. 30, '08	All existing progeny of non-conjugants	28	104-144	123.71±1.26	28-44	34.14±0.60

the (larger) non-conjugants; that in fact the first measurements taken after fission show in every case the progeny of the conjugants to be a little larger; and that the animals of the culture as a whole are a little larger after conjugation than before. With these should be compared the following results of an experiment on a wild culture, in which the conjugants and non-conjugants compared were fundamentally the same.

b. *Comparison of the progeny of conjugants and non-conjugants in a wild culture.* On June 20, 1909, a wild culture that apparently consisted entirely of *caudatum* was found to be in conjugation. Samples of the conjugants and of the non-conjugants were measured, with the results given in the first two rows of table 32. At the very beginning of the conjugation, in the early morning, a large number of pairs were picked out. Many of these had as yet become united only by the anterior parts of the body.

These were separated by manipulation with a pipette, and the two individuals isolated. Other pairs were allowed to complete conjugation, the individuals being isolated only after separation in the natural course of events.

Thus we have in this experiment two sets for comparison, both of which were ready for conjugation; both indeed had taken the first steps in actual union. Both sets of course came from the same culture, and had thus been living under identical conditions. Both sets were kept throughout the experiment under identical conditions, the progeny of each individual in a separate concavity of a hollow ground slide, the culture fluid changed every day. The only difference between them is that one set was allowed to complete conjugation, while the other was not. We have therefore the conditions perfectly fulfilled for determining just what difference conjugation makes.

The pairs which had been separated before conjugation was complete may be designated 'unpairs'; of these there were sixty-four of the original specimens. Of the 'pairs' (conjugation completed) there were forty-eight individuals. Thus 112 lines of propagation were followed. I compared generation by generation, so far as possible, the first seven generations produced by fission. Furthermore, the individuals present in each set on certain days (June 22, June 23) were compared as to size, without regard to the generation to which they belonged. It may be noted that at this time the weather was extremely hot, so that fission took place in both sets with very great rapidity. The results of the experiment, so far as size is concerned, are summarized in table 32.

Examination of table 32 shows that in all of the nine sets compared, except one, the progeny of the individuals that had been allowed to conjugate are larger than the progeny of those that had not been allowed to conjugate. In all these cases the difference is very marked, even in comparison with the somewhat large probable errors (due to the relatively small numbers). In the single case where the progeny of those that had conjugated are smaller (second generation), the difference is small in proportion to the probable error, and therefore without much

TABLE 32

Relative size of the progeny of pairs that had completed conjugation ('pairs'), and of those that were separated at the beginning of mating ('unpairs'). The first two lines give the dimensions for the conjugants and non-conjugants of the culture from which all came. The measurements given are the lengths, in microns.

GENERATION	DATE 1909		NUMBER	MINIMUM	MAXIMUM	EXTENT OF RANGE	MEAN	DIFFERENCE IN FAVOR OF "PAIRS"		COEFFICIENT OF VARIATION
								In microns	Percent of "unpair" mean	
	June 20	Conjugants.....	284	130	206	76	165.04±0.53			
		Non-conjugants..	87	134	198	64	164.12±1.00			
f ₁	June 22	Pairs.....	30	156	240	84	201.20±2.48	33.35±3.14	20.17	9.99±0.88
	June 21	Unpairs.....	27	148	196	48	167.85±1.93			8.85±0.82
f ₂	June 22-23	Pairs.....	30	128	224	96	155.87±3.14	-5.57±3.31	-3.45	16.37±1.46
	June 22	Unpairs.....	64	120	184	64	161.44±1.06			7.75±0.47
f ₃	June 22-23	Pairs.....	37	140	228	88	189.73±2.62	25.73±4.01	15.69	12.47±0.99
	June 22	Unpairs.....	22	128	200	72	164.00±3.03			12.85±1.33
f ₄	June 22-23	Pairs.....	61	124	216	92	178.89±1.79	26.40±2.15	17.31	11.56±0.72
	June 22	Unpairs.....	74	108	188	80	152.49±1.20			10.05±0.56
f ₅	June 22-23	Pairs.....	58	128	212	84	174.83±1.60	20.92±2.39	13.60	10.35±0.66
	June 22	Unpairs.....	23	132	180	48	153.91±1.78			8.22±0.82
f ₆	June 23	Pairs.....	95	136	212	76	175.62±0.94	12.12±2.43	7.41	7.71±0.38
	June 23	Unpairs.....	24	128	196	68	163.50±2.29			9.97±0.98
f ₇	June 23	Pairs.....	36	164	228	64	187.44±1.68	24.34±1.89	14.92	7.98±0.64
	June 23	Unpairs.....	62	144	196	52	163.10±0.86			6.13±0.37
	June 22	All pairs.....	72	124	240	116	172.17±2.45	17.28±2.66	11.16	17.86±1.04
	June 22	All unpairs.....	119	108	200	92	154.89±1.03			10.77±0.48
	June 23	All pairs.....	275	128	228	100	181.02±0.73	17.81±1.14	10.91	9.92±0.29
	June 23	All unpairs.....	86	128	200	72	163.21±0.88			7.41±0.38

significance. Owing to the small numbers measured in some of the cases, differences in the absolute age of the individuals must cause considerable fluctuations in the mean measurements, so that on the whole it is rather surprising that the results should be as uniform and unambiguous as they are. A considerable proportion of the thirty specimens in the second generation from the pairs were evidently young animals.

Not only is the mean size practically uniformly greater in the progeny of those that were allowed to conjugate, but in every case without any exception the extreme size reached is greater in the descendants of the conjugants.

Furthermore, the range of variation is in every case greater in the descendants of those allowed to conjugate. If we measure the variation by the coefficient of variability, we find that in all

cases except two the descendants of the conjugants are the more variable. In these two cases (generations 3 and 6) the difference between the coefficients of variability for conjugant and non-conjugant progeny is small, while in a number of cases the excess for the conjugant descendants is very great. The greater variability of the descendants of the conjugants is on the whole marked and unmistakable.

I may add that a considerable number of other experiments similar to that summarized in table 32 were carried out for other purposes, and in all cases the greater size and greater variability of the descendants of those that had conjugated was very noticeable, although measurements were not made.

Historical. There has been considerable divergence of statement regarding the relative sizes of infusoria at different periods of the life cycle, so that precise measurements were much needed. It is of course generally agreed that the conjugating individuals are smaller than the average, but this is a point somewhat diverse from the one we are now considering. Woodruff ('07) emphasizes the fact that there are in *Oxytricha* variations in size in different periods of the cycle, but does not state at what periods the size is large; at what period small. Calkins and Cull ('07, p. 380) state plumply that the smallest forms in the life history are "characteristic of the first two generations after separation and before the young individuals have had an opportunity to take food." This is quite in opposition to our measurements and if the implication is that the supposed small size is due to the fact that no food is taken between the time of the separation of the conjugants and the first two fissions, this also is a mistake; in individuals of race *k* food was taken within two hours after separation, as shown by the ingestion of India ink. (Maupas, ('89, p. 199,) notes that the ex-conjugants take food 'some hours' after separation.) Richard Hertwig ('89, p. 189) remarked, with his usual correctness, though without giving measurements, that after conjugation the animals grow rapidly, so that they may reach a size not otherwise seen.

The fact that the size is greater immediately after conjugation appears opposed to the common experience of students of the life

cycle; the remark is often made that the animals are smaller after an epidemic of conjugation has occurred. This, as a matter of fact, under the conditions usually prevailing, is true. If we measure a sample of a culture just before (or during) conjugation, and another sample after, we shall usually find that the size has decreased. Thus, in a culture of the aurelia race *c* the mean size (of the non-conjugants) during an epidemic of conjugation was 158.80 ± 0.88 by 32.78 ± 0.17 microns. Five days after the epidemic, the mean size was 129.64 ± 0.87 by 35.44 ± 0.40 . But this great decrease in length is due to the cultural conditions, not to the fact that conjugation has occurred. I have shown in a former paper ('10, p. 29) that conjugation commonly occurs under conditions in which the animals are decreasing in size; conditions of decrease of nutrition, as has often been noted. These conditions produce their effect on the size irrespective of the occurrence of conjugation. But if the nutritive conditions are kept good, the descendants of the conjugants actually increase in size, as compared with the descendants of the non-conjugants. The only way that we can determine the effect of conjugation itself on size is of course to compare two sets which differ in no other way, save in the fact that one has been allowed to conjugate, the other not. In such experiments, as we have seen, the progeny of the conjugants are, for a time at least, the larger.

c. Exceptional case. We are now prepared to understand an apparent (though not a real) exception to the results set forth. We have seen that in the case of a pure race, the large non-conjugants do not give larger progeny than the small conjugants. We have however previously seen that in mixed cultures sometimes one race conjugates while another does not. Numerous examples of this are given in my paper of 1910, p. 283. Now, if it so happens that a small race conjugates, while a large one does not,—then of course we shall find that the progeny of the small conjugants are smaller than the progeny of the large non-conjugants,—contrary to what we find in a pure race. The difference is however due, not to the conjugation, but to the difference in race. This case is realized in certain experiments on the wild

culture *N*, carried out March 21 to April 6, 1908; these are summarized in table 33.

In this case the mean length of the conjugating pairs was 139.29. A hundred of the largest non-conjugants were selected, all larger than any of the conjugants; their mean length (from a sample of fifty) was 224.16. The remainder of these large non-conjugants were allowed to multiply, side by side and under the same conditions, with an equal number of the conjugants, from March 21 to March 26. On the latter date part of each were killed and

TABLE 33

Relative sizes of the conjugants and large non-conjugants, and of their progeny, in the wild culture N (lot 4, table 1)

DATE 1908		Number	LENGTH		Number	BREADTH						
			Range	Mean		Range	Mean					
1	Mar. 21	Conjugants, sample	84	116-160	139	29=0	70	86	24-48	37.91=0	37	
2	Mar. 21	Non-conjugants, sample	152	100-244	155	40=1	39	148	28-64	43	11=0	38
3	Mar. 21	Largest non-conjugants	50	200-252	224	16=1	06	50	32-72	55	36=0	62
4	Mar. 26	Progeny of conjugants	100	104-200	143	80=1	29	100	32-56	39	28=0	40
5	Mar. 26	Progeny of largest non-conjugants	100	148-240	198	52=1	40	100	36-72	48.68=0	52	
6	April 6	Progeny of conjugants	100	100-172	137.16=0	84	100	100	24-56	34	24=0	38
7	April 6	Progeny of largest non-conjugants	100	136-208	172.48=0	28	100	100	32-72	47.02=0	52	

measured, as shown in the table, while the rest were kept till April 6. The progeny of the non-conjugants were much larger than the progeny of the conjugants—the former averaging 172 to 198 microns, the latter 137 to 143. It is clear that there existed in the culture diverse races, and that only certain smaller races were conjugating. This is confirmed by the fact that I actually isolated from this culture a number of lines that were permanently diverse. It is further shown by the fact that when conjugation occurred in the progeny of the large non-conjugants (which happened March 22), the pairs were large, averaging 182.33 microns in length, as opposed to 139.29 for the pairs first taken. Thus what we have really done in this case is to compare large and

small races; these (as is the rule) retained their relative sizes irrespective of conjugation. Where the racial composition of conjugants and non-conjugants is the same, the progeny of the conjugants are the larger, as we have seen.

d. *Summary.* We may summarize our results from the experiments with pure races, and that with a wild culture, as follows:

1. There is no tendency for the progeny of the (small) conjugants to be smaller than the progeny of the (larger) non-conjugants.

2. On the contrary, in every case the first measurements taken after fission show the progeny of the conjugants to be larger than the progeny of the non-conjugants. In the wild culture of table 32, this difference was still very marked in the seventh generation after conjugation; in other cases the two sets had apparently become equalized at this time.

This greater size of the progeny of conjugants is apparently due, partly, if not entirely, to the slower fission after conjugation. The conjugants usually do not divide for 24 to 48 hours after separation, and in the meantime they grow rapidly large, as we have before seen (table 19, etc.). Conjugants of k were observed, by the use of India ink, to begin feeding within two hours after separation. Meanwhile, those that have not conjugated are dividing regularly, so that they have no opportunity to become so large as the ex-conjugants. When the latter divide, their progeny for a number of generations are therefore larger than the progeny of the non-conjugants. The slower fission of the ex-conjugants may continue for a long time, thus giving them an opportunity to remain larger for many generations, as in table 32.

3. There is a characteristic difference in size between individuals at the end of the cycle (before conjugation), and those at the beginning of the cycle (after conjugation). The size is somewhat greater at the beginning of the cycle. The difference, in the case of a pure race, is not very great, and is not such as to conceal the more marked differences between different races; the latter persist throughout the cycle.

3. *Increase in variability as a result of conjugation*

In the wild culture of table 32, the progeny of the conjugants are on the whole decidedly more variable than the progeny of the non-conjugants. It appears therefore that *conjugation increases the variability*. This result is of extreme importance; for this reason I have made an extensive study of the relations involved. This matter is inextricably bound up with the problem of the significance of conjugation and its relation to vitality and rejuvenation. It appears best therefore not to enter upon a detailed account of these things in the present paper, which has grown to a considerable length, but to reserve them for a separate paper. The questions to be answered from our present standpoint are:

a. Is it the rule that conjugation increases variation? Is it true both for wild cultures and for conjugation within pure races?

b. In what characteristics is the increased variation shown? Does it appear in other matters besides size?

c. Are the variations thus produced heritable? Are there in this way new races produced, differing in heritable characters from the race or races that entered conjugation?

Reserving then these important questions for another paper, we take up here certain other points that are naturally treated in the present connection.

4. *Do pairs of different size give progeny of different size?*

On the answer to this question of course depends the decision whether assortative mating has any effect in inheritance; in the production or perpetuation of permanent differentiations. The question has already been answered in my paper of 1908. It is there shown that six pairs, of different sizes, isolated from culture *M*, gave six races differing permanently in size—four belonging to caudatum, two to aurelia (pp. 494–496). This fact, taken in

connection with the demonstration that larger specimens mate with larger, smaller with smaller, shows that assortative mating has clearly the effect of keeping differentiated races from mixing; of perpetuating such racial differences as already exist. When a culture containing two species conjugates, the two as a result of the assortative mating remain quite distinct, as we have before seen. When races of diverse size are present, these likewise tend to remain distinct in spite of the occurrence of conjugation.

But what is the result when all of the conjugating individuals belong to the *same* race? Do large pairs then give large races, small pairs small races—so that as a result of conjugation we get hereditary diverse strains from a single race?

The answer to this question turns out to be bound up with the general problem as to the physiological effects of conjugation on the stock. I therefore reserve its full treatment for a paper which is to deal with that matter, merely stating here in a summary way certain points.

a. When we select large and small pairs from a culture of a pure race (all derived from a single individual), we do not find that as a rule the larger pair gives a larger race, the smaller a smaller one. Usually the two give a race of the same size.

b. Yet hereditary differentiations do arise as a result of conjugation within a pure race; certain pairs or individuals give strains that differ permanently from the strains produced by others. These differences are most noticeable in the matters of general vitality and rate of multiplication, but differences in sizes are likewise to be observed,—possibly due to the differences in general vigor. The extreme importance of these matters requires a full treatment on a paper devoted to the subject, where the experimental data may be properly set forth, in their relation to other phenomena. The indications are that these differentiations within a single race are not connected with assortative mating, and hence that the latter has no marked consequences when occurring within the limits of one race derived from a single individual.

5. Inheritance from unequal pairs

The last question raised in our introductory outline was in regard to the rules of inheritance when the two members of a pair are of different size. This matter again turns out to be complicated by its relation to the problem of the physiological effect of conjugation on the stock; furthermore, on some of the most important points I have as yet been unable to get experimental data. Adequate treatment must therefore be deferred; and I give here merely categorical statements on certain points.

a. The assortative mating of course tends to prevent the mating of individuals differing in size. Yet this does occur at times.

b. The only way to get the rules of inheritance in a satisfactory way would be to get matings between individuals belonging to two diverse stocks, the inherited characteristics of each of which were known beforehand. Such matings between known races I have not yet succeeded in getting. This is owing to the following facts: (1) diverse races usually conjugate under different conditions, so that it is very difficult to induce two such to conjugate at the same time. (2) In the rare cases where two races have conjugated in the same culture at the same time, they have not inter-crossed, owing to assortative mating. Hence, in spite of much work, I have not been able to determine this point. (3) The progeny of the two members of a pair often differ hereditarily, particularly in vigor and rate of reproduction; sometimes also (as a secondary result?) in size. Such differences in vitality have been previously noted by Calkins ('02, p. 175) and by Miss Cull ('07). Their significance is bound up with the problem of the effects of conjugation on the stock; they will therefore be taken up in a later paper on that matter.

SUMMARY

1. The members of conjugating pairs are, as Pearl had set forth, smaller and less variable than the non-conjugants of the same culture. This is true in cultures consisting entirely of the progeny of a single individual. It is likewise true, as a rule, in cul-

tures consisting of a mixture of races. But exceptions may occur in the latter case, owing to the fact that only one of the races present may conjugate. If this happens to be a large race, the conjugants may be larger in size than the non-conjugants.

2. The small conjugants increase in size after conjugation, until they are as large as the large non-conjugants of the same race. Also, the large non-conjugants later divide and themselves conjugate. Hence there is no permanent or fundamental distinction between the two sets, but only a temporary physiological differentiation, which is of no consequence in the later history of the stock.

3. The lessened variability of the conjugants is due (in the case of a single race) to the facts that: (1) they include no young individuals; (2) they do not grow so large as the non-conjugants. The latter, including young (and therefore small) individuals as well as large ones, together with all intermediate stages, must show more variation than the conjugants. But this greater variation is due to temporary physiological differentiations, of no consequence in the later history. The progeny of the conjugants are fully as variable as the progeny of the non-conjugants (see paragraph 7).

In cultures containing several races, the conjugation is often limited to but one of these. The less variability of the conjugants is then due chiefly to this fact. The progeny of the conjugants (all belonging to a single race) will naturally then be less variable than the progeny of the non-conjugants (belonging to several races). In this case therefore the less variability of the conjugants shows its effect in the later history.

4. As Pearl sets forth, larger individuals are usually found to be mated with larger, smaller individuals with smaller, so that there is a considerable degree of correlation in size between the members of pairs. This correlation is greatest in cultures containing pairs belonging to the two species, *caudatum* and *aurelia*; considerably less in cultures consisting of many races of a given species; still less in cultures consisting of a single race, though even here the correlation is considerable.

An exhaustive analysis of the various factors which might produce such correlation (the details of which are given in the text) shows that it is due to real assortative mating (as Pearl maintained): larger individuals mate with larger, smaller with smaller. There is a certain amount of equalization occurring during the process of conjugation, but this is not sufficient to account for the correlation; the latter persists after the equalizing process has ceased to be effective; and correlation is shown in certain dimensions that would not be affected by the equalization.

The assortative mating shows itself in the three following effects:

a. When the two species *caudatum* and *aurelia* are present in a conjugating culture, *caudatum* conjugates only with *caudatum*, *aurelia* only with *aurelia*. Hence crossing is prevented.

b. When races of different size are present (as is usually the case in 'wild' cultures), the members of large races tend to conjugate together, on the one hand; of the smaller races on the other. Thus the assortative mating tends to prevent the admixture of races and their reduction to a single type.

c. Even where members of but a single race are present, larger individuals tend to mate with larger, smaller with smaller. It is not clear that this has any consequences for the later history, though this is not yet disproved.

5. Isolation from a wild culture of large pairs gives large races; of small pairs, small races. Thus it is clear that assortative mating has most important consequences in the later history of the organisms, tending to preserve the existing differentiations of species, races, etc.

6. Conjugation results in certain slight but characteristic changes in size. For a few generations after conjugation the progeny of the conjugants are a little larger than the progeny of those of the same race that have not conjugated. This is apparently due to the slower fission of the progeny of the conjugants. This difference in size is much less than the difference in size between diverse races, and after a few generations the progeny of conjugants and non-conjugants as a rule show no characteristic differences in this respect.

7. The progeny of conjugants are more variable, in size and in certain other respects, than the progeny of the equivalent non-conjugants. Thus conjugation increases variation (a matter to be dealt with in full in another paper).

8. Hereditary differentiations arise as a result of conjugation within members of the same race (all derived from the fissions of a single individual) (to be dealt with in full later).

9 The progeny of the two members of a pair sometimes show hereditary differences (to be dealt with in full later).

LITERATURE CITED

- CALKINS, G. N. 1902 Studies on the life-history of Protozoa. I. The life-cycle of *Paramecium caudatum*. Arch. f. Entw.-mech., Bd. 15, pp. 139-186.
- CALKINS, G. N. AND CULL, S. W. 1907 The conjugation of *Paramecium aurelia* (*caudatum*). Arch. f. Protistenkunde, Bd. 10, pp. 375-415, pl. 12-16.
- COLLIN, B. 1909 La conjugaison d'*Anoplophrya branchiarum* (Stein) (*A. circulans* Balbiani). Arch. d. Zool. Expér. et Gén. (5), tome 1, pp. 345-388.
- CULL, SARA W. 1907 Rejuvenescence as a result of conjugation. Jour. Exp. Zool., vol. 4, pp. 85-89.
- ENRIQUES, P. 1908 Die Conjugation und sexuelle Differenzierung der Infusorien. Zweite Abhandlung. Wiederconjugante und Hemisexe bei *Chilodon*. Arch. f. Protistenkunde, Bd. 12, pp. 213-276, Taf. 17-18.
- HERTWIG, R. 1889 Ueber die Conjugation der Infusorien. Abhdlg. d. II. Cl. d. königl. bayr. Akad. d. Wiss., Bd. 17, (Abth. 1), pp. 151-233, 4 Taf.
- JENNINGS, H. S. 1908 Heredity, variation and evolution in Protozoa. II. Heredity and variation of size and form in *Paramecium*, with studies of growth, environmental action and selection. Proc. Amer. Philos. Soc., vol. 47, pp. 393-546.
- 1910 What conditions induce conjugation in *Paramecium*? Jour. Exp. Zool., vol. 9, pp. 279-300.
- 1911 Computing correlation in cases where symmetrical tables are commonly used. Amer. Nat., vol. 45, pp. 123-128.
- JENNINGS, H. S. AND HARGITT, G. T. 1910 Characteristics of the diverse races of *Paramecium*. Jour. Morph., vol. 21, pp. 497-561.
- LISTER, J. J. 1906 Biometry and biology; a reply to Professor Pearson. Nature, vol. 74, pp. 584-585.

- MAUPAS, E. 1889 La rajeunissement karyogamique chez les ciliés. Arch. d. Zool. Expér. et Gén. (2), tome 7, pp. 149-517, pl. 9-23.
- PEARL, R. 1907. A biometrical study of conjugation in Paramecium. Biometrika, vol. 5, pp. 213-297.
- PEARSON, K. 1906 The latest critic of biometry (etc.) Nature, vol. 74, pp. 465-466; 608-610; 636.
- SIMPSON, J. Y. 1901 Observations on binary fission in the life-history of Ciliata. Proc. Roy. Soc. Edinburgh, vol. 23, pp. 401-421.
- WOODRUFF, L. L. 1907 Variation during the life-cycle of infusoria in its bearings on the determination of species. Science, vol. 25, pp. 734-735.

APPENDIX

TABLES OF MEASUREMENTS

In the following tables the measurements are given, except in certain cases specifically mentioned, in units of 4 microns each, so that to get the measurements in microns or thousandths of a millimeter the measures given are to be multiplied by 4. Thus, in table 34, lot 1, the first individual is 33 units or 132 microns (0.132 mm.) long. But in certain measurements of breadth (tables 57 and 65), and in lot 2 of tables 34 and 36 the unit of measurement is 2 microns; this is specified in the proper places.

In the tables of correlation for the pairs, the larger individual is entered always in the vertical columns, the smaller in the horizontal rows, each pair being entered but once. This is done in accordance with my note of 1911, showing that double or symmetrical tables are unnecessary for such cases.

On some of the lots a number of different measurements were taken, and these were divided up and classified variously, so that a large number of the ordinary correlation tables would be required for bringing out the diverse relations developed. In such cases I have given, in order to save space, a classification of the original measurements, from which correlation tables can readily be formed for all the dimensions dealt with. Such is the case in tables 36, 40, 49, 50, 51, 55 and 56.

The two individuals of a pair are denominated *A* and *B*. In cases where one of the pair projects anteriorly in front of the other, this projecting individual is called *A*, the other *B*.

Tables 1 to 33 are found in the text.

TABLE 34

Comparative measurements of conjugants and non-conjugants from wild cultures (lots 1-7) and from a mixture of two species (lot 21). C, conjugants; N, non-conjugants. Unit of measurement 4 microns, except in lot 2, where it is 2 microns

LOT	1		3		2		4		5		6		7		21	
Length	C	N	C	N	Length	C	N	Length	C	N	C	N	C	N	C	N
33		1			64	1		25		1						
37	1				65			26			3					2
38	1				66		2	27							6	1
39		1			67	1		28		1	3					13
40	2	1			68	2	2	29	1	4	1	3				19
41	4	1	2	1	69	1	1	30	2	1	2					23
42	2	1	2		70	1		31	4	8	1	4				16
43	4	2	5		71			32	9	7	4	9	1	1		11
44	11	2	7	2	72	7	3	33	10	11	3	10		1		9
45	23	3	7		73	6	2	34	7	7	2	11		3		1
46	19	3	17	2	74	11	6	35	19	12	1	10		1		14
47	29	9	15	2	75	3	2	36	13	9	2	5	1	2	4	
48	36	14	13	1	76	25	4	37	7	9		6	1	5	5	1
49	35	14	21	7	77	6	2	38	7	7		6	3	6	7	1
50	41	14	22	7	78	26	4	39	2	10		9	6	9	9	6
51	38	14	17	12	79	18	5	40	3	13		5	6	11	11	9
52	34	33	18	8	80	8	2	41		8		4	12	19	22	8
53	31	27	2	7	81	13	5	42		4		5	20	20	31	14
54	15	29	4	13	82	11	7	43		12		32	21	20	10	
55	15	25	6	14	83	22	5	44		2		1	27	26	22	11
56	3	23	3	12	84	18	3	45		5		2	30	18	5	8
57	4	18	2	13	85	12	3	46		6		25	8	10	11	
58	4	20		11	86	21	6	47		3		3	31	21	3	8
59	1	16	1	9	87	9	6	48		2		31	25	6	12	
60	1	18		6	88	15	4	49				17	27	1	8	
61		16		9	89	7	4	50		3		1	15	25		5
62	2	16		6	90	7	2	51				8	17		1	4
63		6		2	91	3	1	52		1		4	16		4	
64		10		4	92	7		53		2		12			2	
65	1	8		7	93	4		54				2	7		6	
66		4		7	94	4	4	55		1			5		2	
67		3		4	95	3	1	56					2			1
68		1		4	96	4		57					5			
69		3		4	97	2		58					1			
72				2	98	2	1	59		2			1			
73		1			99	1	1	60					2			
77		1			100	1		61		1			1			
78					101			62					1			
79		1			102	1		63								
80		1						64								
								65								
								66								

Total number 360 360 164 176 284 87 84 152 16 100 272 318 158 131 98 150

TABLE 35

Lengths of conjugants and non-conjugants of lots 8-20 (mainly cultures of pure races of aurelia, or mixtures of such cultures). C, conjugants; N, non-conjugants. Unit of measurement, 4 microns

RAVE	8	9	10	11	12	13	14	15	16	17	18	19	20
Lot	C N C	C N C	C N C	C N C	C N C	C N C	C N C	C N C	C N C	C N C	C N C	C N C	C N C
Length	C N C	C N C	C N C	C N C	C N C	C N C	C N C	C N C	C N C	C N C	C N C	C N C	C N C
21						1					1	1	1
22													11
23											2	1	12
24				1	1				1	3		1	13
25				1	1				2	2	2	1	1
26				1	2	2	1	6		1	1	9	1
27				2	1	5	5	3	8	1	9	4	6
28				1	7	5	13	3	12	1	16	5	16
29				5	3	2	12	1	24	1	2	4	13
30				6	1	4	2	20	3	45	5	1	33
31				2	9	3	5	11	38	6	41	6	1
32				3	16	4	3	8	30	4	44	7	5
33				11	12	10	7	5	10	24	2	45	9
34				9	5	12	13	3	1	17	10	11	51
35				11	2	23	11	3	7	17	2	10	23
36				7	5	40	19	2	6	12	16	25	10
37				1	9	38	14	8	7	12	15	9	2
38				10	40	18	3	5	10	6	4	4	7
39				6	19	19	2	2	6	2	10	1	3
40				7	31	11	1	1	3	7	1	1	1
41				3	14	15	5	3	2	3	2	1	3
42				1	17	8	1	1	1	1	1	1	1
43				3	7								
44				3	14								
45				1	6								
46				12									
47				5									
48				7									
49				3									
50				3									

Total number 54 56 250 200 52 43 28 100 156 100 336 100 42 34 50 31 300 100 138 110 168 100 174 118 124 149

TABLE 36

Measurements (in units of two microns) of the 142 pairs of lot 2 (wild culture), classified according to the distance that A projects in front of B. The first column gives a classification of the various lengths of the projecting individual A; the other columns give the lengths of their mates B for each pair, under the different anterior projections of A. Thus, there are eight pairs with A 76 units long; their mates B measure respectively 75, 73, 74, 76, 76, 72, 74, 74 units; in the first four the anterior tips of A and B are even; in the others A projects in front of B 2, 4 and 7 units, respectively

A	LENGTH OF MATES, B, WHEN THE DISTANCE A PROJECTS BEYOND B, IS										
	0	1	2	3	4	5	6	7	8	9	15
73			70								
74	72, 73										
75											
76	(2)73, 74, (2)76		72		74			74			
77											
78	(2)68, 72, (2)74, (3)76		73, 74, 76	78	72			72			
79	78, 79					64					
80			(2)76		72			66			
81	78, (2)79, 80		76, 79	80		77					
82	78, 81			78	74						
83	78, 79, 82	79	80	75, 76, 78	78, 81	81				82	
84	74, 76, 78, 79	77, 83		77	69, 74, 84						
85	75, 85	81	79, 81		79						
86	75, 79, (2)83, 84, 85, (3)86	77	85	76, 83	85						
87	77, 86	83		79		76			66		
88	76, (2)83, (2)84	88	82	87	83	82	76				
89	85, 86				86	86	73				72
90	87, 88		80, 88	79							
91	84		79	82							
92	84, 90		78, 87, 92								
93	85	82									
94	82, (2)93				76						
95	92					77, 84					
96		90	78		79		76				
97			83	79							
98				88		89					
99	78										
100			83								
101											
102						84					

TABLE 37

Lot 3 (wild culture). Length of A by length of B

	43	44	45	46	47	48	49	50	51	52	53	54	55	56	57	58	59
41			1			1											2
42	1			1													2
43	1	1		1													3
44		1		2	1					1							5
45			1		1			2	1								5
46				1	3	2	3	2						1			12
47						1	4	3	1				1				10
48						1	2	1	1	1		1	1				8
49							2	3	2	2		1					10
50									5	4			1	1			11
51									2	2							1 5
52										2		1	2		1		6
53												1			1		2
54																	
55														1			1
	2	2	2	5	5	5	11	11	12	12		4	5	3	2	1	82

TABLE 38

Lot 4 (wild culture). Length of A by length of B

	31	32	33	34	35	36	37	38	39	40
29		1								1
30			1			1				2
31	1	2								3
32		1	1		3					5
33			1		3	2			1	7
34				2	2	1				5
35					2	3		3	1	9
36						1	2	2		5
37							1	1	1	4
38									1	1
	1	4	3	2	10	8	3	6	2	42

TABLE 39

Lot 6 (wild culture). Length of A by length of B

	35	36	37	38	39	40	41	42	43	44	45	46	47	48	49	50	51	52	53	54	
32	1																				1
33																					
34																					
35																					
36																					
37															1						1
38			1	1												1					3
39					1	1	2	1						1							6
40							1	1	1	1			1								5
41						2		4		2							1				9
42							1	4	2	1	3	4	2	1							18
43								3	3	5	2	1	1	2	2						19
44									4	3	5	2	1								15
45										1	4	4	4	3							16
46											1	1	2	1	3	1					9
47												4	7	1	1		1		1		15
48														1	4	2	3	1			11
49																4					4
50																	1			1	2
51																		2			2
1					1	3	2	13	12	14	16	16	20	13	13	6	4			2	136

TABLE 40

Lot 7 (wild culture). Measurements, length from anterior end to mouth, and total length; classified with relation to the distance that A projects in front of B. (The lengths "To mouth" are not repeated when successive pairs are the same in this respect.) (1 unit = 4 microns)

ANTERIOR ENDS EVEN				ANTERIOR ENDS EVEN				PROJECTION 1				PROJECTION 1			
To Mouth		Total		To Mouth		Total		To Mouth		Total		To Mouth		Total	
A	B	A	B	A	B	A	B	A	B	A	B	A	B	A	B
25	25	37	36			46	42	25	24	39	37			51	45
		40	37	28	28	41	41			41	38				
		42	40			42	40			42	36			PROJECTION 2	
26	26	39	38			42	41	26	25	40	39	25	23	38	36
		40	39			43	40			40	41	27	25	39	36
		41	40			43	42	27	26	38	39			41	41
		42	41			43	42			40	38	28	26	44	38
		42	42			43	42			43	37			44	38
		42	42			43	42			44	41	29	27	42	43
		43	39			43	43			44	42			44	40
		43	41			44	42			44	42			48	44
		44	37			48	44	28	27	41	39			48	45
		45	42	29	29	43	42			41	42				
		46	41			46	42			42	41			PROJECTION 4	
		46	41			46	43			42	43	26	22	44	32
27	27	41	41			46	44			44	41				
		42	41			47	42			44	42				
		42	41	30	30	46	45			44	42				
		43	40			47	42			44	42				
		43	41			48	45			48	40				
		44	41			49	46	29	28	43	39				
		44	43	31	31	47	44			46	44				
		44	43					31	30	48	44				

TABLE 41

Lot 7 (wild culture). Non-conjugants; length before mouth with length behind mouth

Length before mouth

	24	25	26	27	28	29	30	31	32	33	34	35
12				1		1						2
13	1		1	3		1		1				7
14		2	1		1							4
15		3	2	1	1		1	1				9
16	1	1	2	3	5	1	2	3	1			19
17		3		1	2	4	2	4	1			17
18		1	2	1	1	1	3	2	2			13
19					2	1	1	1	1			6
20						1		2	3			6
21								1	2	1	1	6
22									3			3
23				1					1			2
	2	10	8	11	12	10	9	15	14	1	1	94

TABLE 42

Lot 8. Length of A by length of B

	31	32	33	34	35	36	37	38
30		2						2
31		3						3
32					1			1
33	1	2	1	2	2	1		9
34			1	1	1	2		5
35					2	2	1	5
36				1				2
	1	7	2	4	6	5	1	27

TABLE 43

Lot 9 (race c). Length of A by length of B

	33	34	35	36	37	38	39	40	41	42	43	44	45	
30					1					1				2
31			1	1						2				4
32										1				1
33	2	2	1		2			3						10
34		1	2	1	1	1				2		1		9
35			2	3	4	5		3						17
36				2	7	3	5	6						23
37					3	7	4	3		3				20
38						2	2	5	5	6	1		1	22
39							1	2	2	2				7
40								1	2	2	1	2		8
41									1					1
42												1		1
	2	3	6	7	18	18	12	23	13	16	3	3	1	125

TABLE 44

Lot 10 (race k). Length of A by length of B

	30	31	32	33	34	35	36	
28				1				1
29				1	2	1		1
30	1	2	2					5
31			5		1	1	1	7
32			2	1	1	1		5
33				2				2
34						1		1
	1	2	11	5	1	3	2	26

TABLE 45

Lot 11 (race k). Length of A by length of B

	28	29	30	31	32	33	34
24			1				1
25	1						1
26				1			1
27				1	1		2
28	1	1	1	1	1		5
29		1					1
30				1		1	2
31					1		1
	2	2	2	4	3	1	14

TABLE 46

Lot 12 (race k). Length of A by length of B

	28	29	30	31	32	33	34	35	
26	1				1			2	
27	2		1	1	1			5	
28		2	3	3	2			10	
29		1	1	4	2		1	9	
30			3	3	6			12	
31				3	7	9	5	24	
32					3	3	2	8	
33						4	2	2	8
	3	3	8	14	22	16	10	2	78

TABLE 47

Lot 13 (race k). Length of A by length of B

	26	27	28	29	30	31	32	33	34	35	36	37	38	39	
23				1											1
24															
25	1														1
26				2		1	1		1						5
27		1						1	2	1					5
28			1	2				1	3	3			1		11
29			1	2	1	1	6	7	1						19
30				1	12	6	3	6		1	1				30
31					3	4	5	4	1	5	1		1		24
32						5	5	4	3	5	3		2		27
33							4	4	6	2	2		2		20
34								5	3	4	2			1	15
35									1	1	1		1		4
36										2	3				5
37														1	1
	1	1	5	5	17	17	25	36	19	20	14	6	2	168	

TABLE 48

Lot 16 (race C₂). Length of A by length of B

	26	27	28	29	30	31	32	33	34	35	36	37	38	39	40	
25	1															1
26									1							1
27		1	1	3	1			1								7
28				5	4	2	1	1	2							15
29				5	7	5	2	3	3	1	1	1				28
30					3	5	4	4	2							18
31						2	4	4	2		5		2	1	1	21
32							8	3	1	2	4	1	1			20
33								1	1	3			1			6
34									5	3	2	1				11
35										3	3	2	2			10
36											1	5		2		8
37												3	1			4
	1	1	1	13	15	14	19	17	17	12	16	13	7	3	1	150

TABLE 49

Measurements of length for the 69 pairs of lot 17 (race C₂), classified according to the distance that A projects in front of B. Unit, 4 microns. (Compare the explanation of table 36)

A	LENGTH OF MATES, B, WHEN THE DISTANCE A PROJECTS BEYOND B IS				
	0	1	2	3	4
26		24	22		
27		27, 28			
28	28	27	25		
29	29	24, 25, 28, 29, 30	27		
30	26, 28, 30, 32	28	25, 27, 28		
31	26, 30	(2)31	27, 28		
32	(2)31, 30	(3)29, 20, 31			31
33	24, 30, 31, (2)32 33	30, 31, (2)32	27, (2)28, 30	27, (3)28, 30	
34	(2)32, 34	33			
35	(2)33, 35	33, 34	29		26
36					34
37			28		
Total number.....	23	24	14	5	3

TABLE 50

Measurements of length for the 84 pairs of lot 18 (race *g*), classified according to the distance that *A* projects in front of *B*. Unit of measurement 4 microns. (Compare the explanation of table 36)

A	LENGTHS OF MATES, <i>B</i> , WHEN THE DISTANCE <i>A</i> PROJECTS BEYOND <i>B</i> IS			
	0	1	2	3
28	27			
29	(2)28, 29	27, 28		
30	28, (4)29, (4)30	27, 28, 29, (2)30, 32	27	
31	(2)29, (6)30, (3)31	28, 29, (2)30, 31		
32	(2)31, 32	27, 28, (5)29, (3)30, 31, 32	27, 28, 29, 30	
33	30, (2)31, (2)32	26, 29, 31, (3)32	30	29
34	(2)33, (2)34	30, (2)31, 33		
35	32, 33		(2)30	
36		31		
37				
38		33		
Total number.	38	37	8	1

TABLE 51

Lot 9 (race g). Measurements of conjugants in length from anterior end to mouth, and total, classified according to the distance that A projects in front of B. (The lengths "to mouth" are not repeated when successive pairs are the same in this respect.) Unit of measurement, 4 microns. (Thus, in the first pair, the distance from anterior end to mouth is 64 microns in both individuals, the total length of A is 100 microns, that of B, 96 microns)

ANTERIOR ENDS EVEN				PROJECTION 1				PROJECTION 2			
To Mouth		Total		To Mouth		Total		To Mouth		Total	
A	B	A	B	A	B	A	B	A	B	A	B
16	16	25	24	17	16	27	26	17	15	29	26
		28	26			27	26	18	16	29	27
17	17	27	27			27	26	19	17	28	26
		28	27			27	27			29	25
		28	27			28	30			29	28
		28	28	18	17	27	26			34	29
18	18	27	27			28	27			34	30
		27	27			28	27	20	18	32	27
		28	26			29	28			34	29
		28	27			29	28	21	19	36	29
		28	30			30	30				
		29	28			31	29				
		29	30	19	18	28	27				
		29	30			29	25	17	14	29	24
		30	27			29	27	19	16	31	28
		30	28			30	28	20	17	32	28
19	19	29	29			31	27	21	18	33	28
		29	29			31	29			35	29
		29	30			32	28	23	20	38	31
		30	29			32	28				
		30	30			32	29				
		31	29			32	30				
		31	29	20	19	29	28	22	17	35	26
		31	30			29	29				
		31	30			32	28				
		31	31			32	31				
20	20	31	33			33	28				
		32	29			33	31				
		32	30			34	29				
		32	30			35	29				
		32	32	21	20	33	32				
		33	30								
		33	30								
		33	33								
		34	32								
21	21	33	30								
		35	30								
		35	35								
22	22	35	31								

TABLE 52

Lot 19 (race g). Non-conjugants; length behind mouth with length before mouth
Length behind mouth

	9	10	11	12	13	14	15	16	17	18	19	20
13	1	1										2
14												
15												
16	1	1										2
17		1	3	3	1							8
18		2	3	2	1	1		1				10
19		1		11	3	3						18
20			4	2	6	3						15
21		1	1	4	6	5	1	1				19
22			1	2	1	6	2	2		1		15
23		1			1	3	4	2		1		12
24					2	1	5		2		1	11
25					1		2				1	4
26					1			1				2
	2	8	12	24	23	22	14	7	2	2	1	118

TABLE 53

Lot 20; conjugants from mixture of races C₂ and i. Length of A with length of B

	29	30	31	32	33	34	35	36	37	38	39	
25		1									1	
26				1							1	
27	1				1		1				3	
28						1	1	1			3	
29		1	2	1	1	1			1		7	
30		2	1	3	2	4					12	
31				1	2	2					5	
32				3	2	3		2	1	1	12	
33					1	5	2	1			10	
34						1	2	2			5	
35								1	1		2	
36												
37									1		1	
	1	4	3	9	9	17	6	7	4	1	1	62

TABLE 54

Lot 21; conjugants from mixture of races L₂ (caudatum) and k (aurelia). Length of A with length of B

	28	29	30	31	32	33	34
27	5		1				6
28	1	3	1		2		7
29		3	2	4	1	2	13
30			5	5	3	1	14
31				2	2	1	5
32					1	1	2
33						2	2
	6	6	9	11	9	7	49

TABLE 55

Lot 22; 102 pairs of unseparated conjugants; measurements of length to mouth, total length, and breadth, for A and B of each pair. (In some of the pairs only the total length was measured, as the table shows.) Unit, 4 microns

TO MOUTH		TOTAL LENGTH		BREADTH		TO MOUTH		TOTAL LENGTH		BREADTH	
A	B	A	B	A	B	A	B	A	B	A	B
26	25	44	45	7.5	7.5	30	28	45	42	8	9
26	26	42	42	7	7			47	44	7	7
		43	43	8	8	30	29	47	43	8	7
27	25	43	43	7	6.5			49	48	7.5	8
		44	42	7	6.5	31	28	49	44	7.5	7
27	26	39	40	6.5	7	31	29	47	45	7	7
		43	40	7	7	32	29	48	44		
		46	43	8	7	32	30	47	43	7	7
27	27	43	43	7	7	33	26	48	42	8	6
		43	42	7.5	6.5			39	38	7	7
		44	42	8	6.5			43	42	6.5	6
		44	43	7.5	8			43	43	8	7
		44	44	7	6.5			45	42	7	7
		45	44	8.5	8			45	43	8	7
		46	46	7	7			47	45	8	7.5
		46	46	7	8			49	44	7	7
28	25	47	44	7	6			51	45	7	7
28	26	41	42	7	7						
		42	44	7	8						
		43	42	7.5	7.5						
28	27	45	44	7	7						
		46	41	8	6						
		46	44	7	6.5	4	41	38, (3)40			
		47	43	8	7	3	42	39, 40, 41			
28	28	46	43	8.5	6	7	43	39, 40, (3)42, (2)43			
29	26	44	44	8	7.5	6	14	41, (2)42, 43, (2)44			
		45	41	7	7	10	45	40, (2)41, 42, (2)43, (2)44, (2)45			
29	27	46	41	7	7						
		46	43	6.5	7	8	46	38, (3)42, (2)43, (3)45			
29	28	43	39	7	7						
		45	43	8	7	6	47	42, 44, (2)45, (2)46			
		46	46	7	7.5	2	48	44, 45			
		46	47	7	8.5	2	50	44, 48			
		47	47	8	10	1	52	49			
		50	43	9	7.5						
29	29	49	45	8.5	8						

Only total length measured

NO. OF PAIRS A LENGTHS OF MATES, B.

TABLE 57

Lot 23 (wild culture). Conjugants killed (in separate drops) about 12 hours after separation. Correlation in length of the two members of pairs. Unit, 4 microns

	40	41	42	43	44	45	46	47	48	49	50	51	52	53	54	55	56	57	58	59	60	61	62	63	
38	1																							1	
39					2																				3
40		2						1																	3
41									1																2
42										1															1
43			1				2																		6
44				1	1	2																			10
45					1	2	2	1	1	2															15
46					1	2	3	2	1	3	1														1
47					1	2	2	1	1	1															8
48					1	1	1	1	1	3	1														12
49					1	2	1	2	1	1															8
50									1	2	3	1													14
51										2	1	1													9
52											1	2													9
53											1	2													12
54											1	3	1												8
55													3	2	1										7
56													3		1										3
57															2										1
58																									1
59																									1
	1	2	1	1	6	9	7	8	9	13	14	9	13	9	8	5	6	4	5	3					1 134

TABLE 58

Lot 23 (wild culture). Correlation in breadth of A with B in pairs about 12 hours after separation, the individuals killed in separate drops. Unit, 2 microns

	16	17	18	19	20	21	22	23	24	25	26	27	28	29	30	31	32
16	1								1								2
17						1	1		1								3
18			1	1				3	2								7
19					3			3		1		1					8
20							1	1	5	1	4		1	1	1		15
21						1	1		5	2	1		1				11
22							1	4	10	2	5	1	2		2		28
23								1	2	2	3	2	1	1	1		14
24									4	7	3	1	1	2			18
25											4	1	1	1	1		10
26											1	1	4				7
27													2		1		3
28													3	1			5
29														1	1		2
30																1	1
	1	1	1	3	2	10	8	29	14	22	6	16	7	7	1	6	134

TABLE 59

Lot 24 (race k). Unseparated pairs, length of A by length of B. Unit, 4 microns

	26	27	28	29	30	31	32	33	34	35	36
25		1	1								2
26	1		1		1						3
27		2	3	4	3	2		1			15
28			3	12	5	4	1	3		1	29
29				8	11	6	4	2	1		32
30					8	7	7	2		2	3
31						6	1	2			9
32								2			2
33									1		1
	1	3	8	24	28	25	13	12	2	3	122

TABLE 60

Lot 24 (race k). Separated conjugants, both members of a pair killed in the same drop of fluid. Length of A by length of B

	29	30	31	32	33	34	35	36	37	38	39	40	41	42
22	1													1
23														
24														
25														
26			1											1
27														
28														
29														
30					1	1								2
31			1	1										2
32					1		1		1					3
33						1				2				3
34						1	1	7	1	1	1			12
35							2	5	4	4	1			16
36								4	3		3			2 12
37									2	2	5		1	10
38											1	2		3
39											2	1	1	4
	1	1	1	2	3	4	17	10	8	15	3	2	2	69

TABLE 61

Lot 24 (race k). Separated pairs, the two members of each pair killed in separate drops. Length of A by length of B

	34	35	36	37	38	39	40	41	
32	1	1							2
33		1	1	1		1		1	5
34	1	1	4	2					8
35		3	3	4	3	1	1	1	16
36			6	4	3	1			14
37				3	5	3	1		12
38					3	2			5
39						1	1		2
40									
41								1	1

	2	6	14	14	14	9	3	3	65

TABLE 62

Lot 24 (race k). Unseparated pairs; length to mouth in A by same in B

	16	17	18	19	20	21	22	
15	3	2	1					6
16	2	10	6		1			19
17		10	17	4	3			34
18			27	15	6	1	1	50
19				8	2	1		11
20					1	1		2

	5	22	51	27	13	3	1	122

TABLE 63

Lot 24 (race k). Conjugants about 12 hours after separation; length before mouth in A by same in B

	17	18	19	20	21	22	23	24	25
14			1						1
15									
16	1								1
17					1				1
18			1	2					3
19			3	1		1			5
20			2	4	5	5	1	1	18
21				11	33	9	1		54
22					17	13	8	1	39
23						4	5	1	10
24							1	1	2
	1	1	6	18	56	31	17	4	134

TABLE 64

Lot 24 (race k). Unseparated conjugants; length behind mouth by length in front of mouth, in the same individual

Length Behind Mouth.

	8	9	10	11	12	13	14	15	16
15			1		3	1	1		6
16		1	3	10	9	1			24
17		1	3	14	25	11	2		56
18		2	12	25	40	16	4	2	101
19			4	6	15	8	4	1	38
20	1			1	3	7		2	15
21						1	1	1	3
22							1		1
	1	4	23	56	95	45	13	6	244

TABLE 65

Lot 24 (race k). Conjugants about 12 hours after separation; length behind mouth with length before mouth in the same individual

		Length Behind Mouth																
		6	7	8	9	10	11	12	13	14	15	16	17	18				
Length Before Mouth	14							1									1	
	15																	
	16	1															1	
	17							1			1						2	
	18							2	1								3	
	19							2	1	2	1						6	
	20							4	5	6	6	2	1				24	
	21							2	18	21	22	9					72	
	22						1		15	30	29	15	4	1			95	
	23								2	6	13	16			4		41	
	24							1	1	2	10	4	1				19	
	25											1	1	2			4	
1							1	13	43	67	83	47	8	5		268		

TABLE 66

Lot 24 (race k). Conjugants about 12 hours after separation; breadth of A by breadth of B. Unit, 2 microns

		Breadth of B										
		19	20	21	22	23	24	25	26	27	28	
Breadth of A	14	1									1	
	15											
	16											
	17	1									1	
	18				1						1	
	19					1					1	
	20		2	1	7	2	2	1	3		18	
	21			1	6		4				11	
	22				20	9	17	2	6		54	
	23					1	15	1	4	1	2	24
	24						4	3	6	3	1	17
	25							1	2		1	4
26								1			1	
27												
28										1	1	
2		2	2	2	34	13	42	8	22	4	5	134

TABLE 67

Lot 25 (race k; aurelia). Correlation table for lengths of conjugants about 12 hours after separation, the two members of any pair killed together, in the same drop

	27	28	29	30	31	32	33	34	35	36	37	38	39	40	41	
25	1	1	1													3
26				1												1
27			1			1										2
28					1	2										3
29		1		1		2	1									5
30						5	1	3	2		1					12
31					1	1	4	1	1	2	1	2				13
32						1	2	4	2	3	1	2	1	1		17
33							4	2	2	1	2	1	1	1		14
34								3	1	4	2					10
35										2	2				1	5
36										1	1					2
	1	1	3	1	3	8	15	14	8	13	10	5	2	2	1	87

TABLE 68

Lot 25 (race k; aurelia). Correlation table for lengths of conjugants about 12 hours after separation, the two members of any pair killed in separate drops

	27	28	29	30	31	32	33	34	35	36	37	38	39	40	41	42	
25	1		1			1											3
26															1		1
27		1								1							2
28				2													2
29				1		2											3
30					1	1	2			3	2					1	10
31						2	1	4	3			1		1			12
32						2	7	1	3	1	1	5	1				21
33								4	4	3	2		1				14
34								1		5	2	1	1				10
35										1	1	4		1			7
36												1	2		1		4
37													1	1			2
	1	1	1	4	1	9	8	13	12	12	11	9	5	3	1	91	

THE REPRODUCTION OF PARAMAECIUM AURELIA IN A 'CONSTANT' CULTURE MEDIUM OF BEEF EXTRACT

LORANDE LOSS WOODRUFF AND GEORGE ALFRED BAITSELL

Sheffield Biological Laboratory, Yale University

TWO FIGURES

Previous work¹ with pedigree cultures of *Paramecium aurelia* and *Paramecium caudatum* has apparently shown that the life history of these forms, when bred continuously on infusions of hay made up exactly the same from day to day, tends to run in a cycle which terminates with the death of the culture. Previous work has also shown that *Paramecium aurelia*² may be bred indefinitely on a culture medium which is frequently varied.

In view of these results the following question suggests itself: Is the longevity of *Paramecium* on a 'varied environment' dependent upon intrinsic stimuli from the frequent changes of the medium, or is a 'constant' medium of hay infusion unfavorable because it lacks some elements which are essential for the continued existence of this protozoön?

To test this point it is necessary to find, if possible, a suitable 'constant' culture medium which contains all the elements which the organism demands, and to determine its effect on the vitality of *Paramecium* when subjected to it for a considerable length of time. If such a suitable medium is secured on which *paramecia* will live indefinitely, it is apparent that the possible continual daily stimulation afforded by 'varied' culture media is

¹ Calkins: *Jour. Exp. Zool.*, vol. 1, no. 3, 1904. Woodruff: *Biol. Bull.*, vol. 17, no. 4, 1909.

² L. L. Woodruff: Two thousand generations of *Paramecium*. *Archiv für Protistenkunde*, Bd. 21, 3, 1911.

not the crucial factor in the determination of the longevity of paramaecia cultures. Further, and aside from this interesting theoretical consideration, such a favorable 'constant' culture medium would be valuable for breeding paramaecia in various lines of experimental work, since it is clear from many investigations that the reactions of paramaecia to various reagents, etc., are greatly modified by their past and present environment.³

In the present paper are briefly outlined the results which have been secured, thus far, in an effort to answer the question suggested above, and to provide a suitable culture medium which investigators can employ in breeding cultures of this organism.

The animals used in this study were from the pedigree culture of *Paramecium aurelia* which one of us⁴ has had under daily observation for more than four years, and which has attained, up to the present time (May 1, 1911), 2370 generations under the conditions of a 'varied environment,' without conjugation or artificial stimulation.

The favorable results secured first by Calkins⁵ with strong solutions of beef extract as a temporary stimulant for his degenerating cultures of *Paramecium caudatum* in infusions of hay, and later by Woodruff⁶ with *Oxytricha fallax* under similar conditions, suggested the use of a weak extract of beef as a 'constant' culture medium. Further, beef extract should afford all the elements required for the continued life of protoplasm. The results of chemical analyses have shown that Liebig's extract of beef is

³ For example, Greeley (Biol. Bull., vol. 6, 1904, p. 1), in a study of the effect of various chemicals on the protoplasm of *Paramecium*, wrote: "Maximal dilutions can only be approximate, as the action of identical solutions is not the same on paramaecia from different cultures, because no two are exactly alike in respect to chemical composition and osmotic pressure;" and Miss Towle in a similar study (Amer. Jour. Physiol., vol. 11, no. 2, 1904, p. 235) said: "The first step toward a clearing of the haze that envelops the subject will be found, I believe, when an effort is made to unify the conditions under which different investigators are working."

⁴ Woodruff: Loc. cit.

⁵ Calkins: (Archiv für Entwick.-Mechan., Bd. 15, 1, 1902). "The lean beef was boiled in tap-water for fifteen minutes and allowed to stand until cool. The clear fluid was then used without dilution."

⁶ Woodruff: Jour. Exp. Zool., vol. 2, no. 4, 1905.

remarkably constant in composition, and therefore this standard preparation, which is available for all investigators, was used as the basis of our culture medium.

Having decided on Liebig's extract of beef, it was necessary to make a series of experiments to determine the strength of solution which was most favorable for *Paramaecium*. The solutions were made by weighing out one gram of the extract and diluting this with varying amounts of distilled water. The different concentrations of beef extract showed that a solution of approximately 0.025 percent gave the best results. Accordingly a quantity of this solution was made up which was sufficient to provide culture medium for the organisms for a period of seven months. This length of time was decided upon for this work as the final results of Calkins' experiments led him to conclude that the cycle of *Paramaecium caudatum*, in a constant environment of hay infusion, was not of more than six months duration.⁷ The medium when made was put into over one hundred test tubes, and these were plugged with cotton and sterilized. The solution in the various tubes remained sterile until it was used, and the inoculation of the medium with bacteria which were transferred with the paramaccia afforded an ample supply of food for the animals.

The regular experiment was begun on October 1, 1910, by the isolation of a specimen from each of the four lines of the pedigree culture I of *Paramaecium aurelia* at the 2012th generation. Each of the organisms was placed on a depression slide in five drops of the beef extract solution, and in this manner was started a culture designated *Paramaecium IB*. This culture was continued by isolating an organism every day from each of the four lines of the culture, and placing it in fresh culture medium on a sterile depression slide. The number of divisions during the previous twenty-four hours was recorded at the time of isolation. From this record the average daily rate of division of the four lines

⁷ It may be noted that animals from this same pedigree culture of *P. aurelia* were bred on a 'constant' medium of hay infusion from February to June, 1909, and died out after 107 days subjection to this condition. (Cf. Biol. Bull., vol. 17, no. 4, 1909, fig. 4).

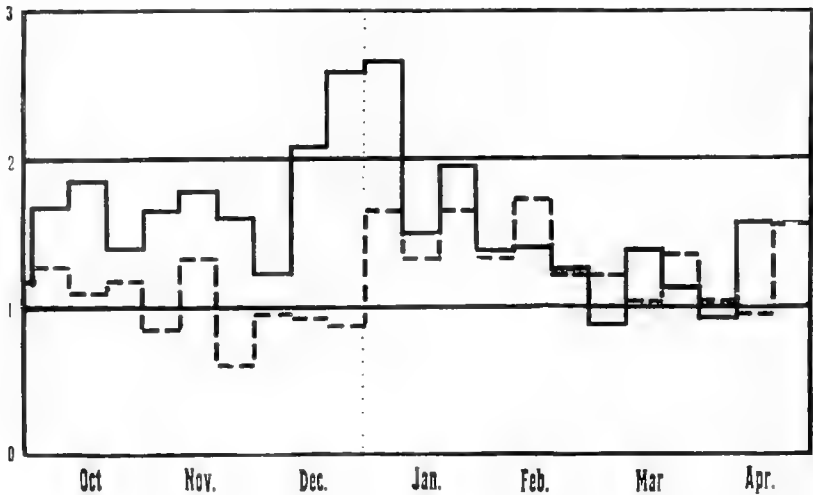

Fig. 1 Graph showing the rate of division of *Paramaecium aurelia*, Culture I and Culture IB, from October 1, 1910, through April 29, 1911. The ordinates represent the average daily rate of division of the four lines of the respective cultures, again averaged for ten day periods. Culture I = ———; Culture IB = - - - - -

of the culture, again averaged for five- and ten-day periods, was computed, and the result is graphically shown in figs. 1 and 2.

The original pedigree culture on a varied environment was, of course, continued, and served as a control for the culture on beef extract, since the method of carrying on the two cultures was identical, except that the medium used was not the same in each case. The original pedigree culture was bred on infusions of grass, hay, pond weeds, etc., made up with water from various sources. The infusions were boiled before being used to prevent the introduction of 'wild' paramaecia into the pure lines.⁸

The various preparations were kept in moist chambers to prevent evaporation, and the temperature of the air in these chambers was recorded by a maximum and minimum registering thermometer. Obviously this method of recording the temperature gives only the extremes to which the cultures were subjected.

⁸ For further details of the method employed, cf., Woodruff, loc. cit.

and does not take into account the length of time during which any particular temperature was maintained. However, the method is sufficiently exact for the problem at hand. Studies on the relation of temperature to the 'rhythms' in the rate of reproduction of paramaecia are now in progress. During the first three months of the work, culture I ('varied' culture medium) and culture IB (beef) were kept in different rooms, and therefore during this time the cultures were subjected to different temperatures. From January 1 to the present time, both cultures were kept in the same place and consequently each was subjected to the same temperature.

There were, then, two pedigree cultures of Paramaecium, each comprising four lines, being conducted simultaneously. One of these had been bred on a 'varied' culture medium for forty-one months, and was continued under the same conditions during the following seven months, *i.e.*, to the present time. The other culture, isolated line by line from the first culture, was carried on for seven months (to date) on a 'constant environment' of beef extract. The chemical composition of this medium was identical from day to day as it was all made up and sterilized at the same time. The only variation, therefore, in the medium used for these organisms on beef extract was the fluctuations in the bacterial flora due to infections from the air, and slight variations in the multiplication of the bacteria due to temperature changes. This, however, was so small that it is negligible from the standpoint of these experiments.

A study of figs. 1 and 2 gives a clear idea of the comparative rate of division of the two cultures, and shows that, at the end of the seven months work, the rate of division, and therefore presumably the vitality, of the two series of animals is practically the same. Neither of the cultures shows any indications of loss of vigor, and the rate of division of each at the end of the experiment is practically the same as at the beginning—such fluctuations as have occurred being merely 'rhythms'.

During the first three months of the work, the rate of division of the beef series was considerably lower than that of the other series, but this is obviously explained by the considerably higher

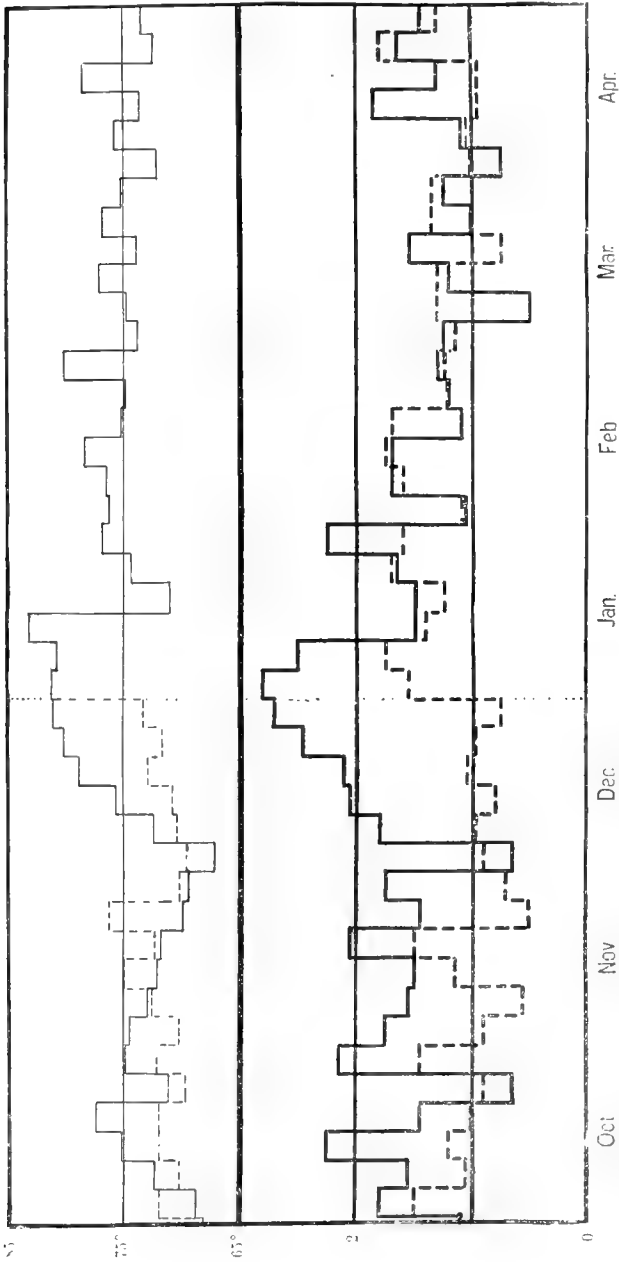

Fig. 2 Graph showing (below) the rate of division of *Paramaecium aurdia*, Culture I and Culture IB, from October 1, 1910, through April 29, 1911; and also (above) the average temperature to which the cultures were subjected. The ordinates represent the average daily rate of division of the four lines of the respective cultures, again averaged for five day periods; and also the average temperature ($^{\circ}$ F) for the corresponding periods. Culture I = ———; Culture IB = - - - - -

temperature to which the latter was subjected during this period (cf. temperature curves in fig. 2). During this period of three months, culture I advanced from the 2012th to the 2188th generation, or 176 generations, whereas culture IB advanced from the 2012th to the 2120th generation, or 108 generations. A comparison of the rate of division from January 1 to April 29, 1911, when both cultures were subjected to identical temperature conditions, shows that culture I advanced from the 2188th to the 2365th generation, or 177 generations, while culture IB advanced from the 2120th to the 2287th generation, or 167 generations. Therefore the net variation in the number of generations attained by the two cultures during the last four months, when under the same conditions of temperature, was only ten. Further, the appearance and behavior of the paramaecia in the two cultures were identical.

It is evident, then, that the 'constant' medium of beef extract employed has proved (during the seven months of this experiment) to be practically as favorable a medium for the reproduction of this pedigree culture of *Paramaecium aurelia* as the 'varied environment' medium,⁹ and therefore, the conclusion seems justified that this culture of *Paramaecium* can, in all probability, be continued indefinitely on this 'constant' medium. It therefore appears fair to conclude that it is the 'composition' of the medium rather than the 'changes' in the medium which is conducive to the unlimited development of this culture without conjugation or artificial stimulation.

It is not suggested that every culture of *Paramaecium* would have the potential to attain more than two thousand three hundred generations under the conditions of a 'varied environment,' nor is it suggested that every culture of *Paramaecium* would thrive for over seven months on a 'constant' environment of beef extract. "For undoubtedly there are strong and weak strains

⁹ Experiments are now in progress to determine if this culture of *Paramaecium* will develop indefinitely on infusions of *hay* which are not made up the same from day to day, *i.e.*, if hay infusion, in which there is a slight daily variation, may not be substituted for the decidedly varied culture medium which has been used during the past four years.

among Infusoria as among other classes of animals. Again, it is possible that the different races of paramaecia which Jennings has been able to isolate may have a physiological as well as a morphological basis of distinction."¹⁰ But it is believed that these experiments clearly show that beef extract (in the concentration used) is a suitable environment for the continued reproduction of this pedigree culture of *Paramecium*, and that beef extract, in this or closely similar solutions, will prove to be a favorable medium for use in many investigations on the physiology of *Paramecium*.¹¹

¹⁰ Woodruff: Biol. Bull., vol. 17, no. 4, September, 1909, p. 303.

¹¹ After the completion of the seven months experiment (April 29, 1911), a new lot of the beef extract medium was made up exactly the same as before and the culture has been continued on this without noticeable change in its reproduction to date of correcting proof, June 20, 1911.

MIGRATION OF RETINAL PIGMENT IN THE EYES OF BRANCHIPUS GELIDUS

RUTH B. HOWLAND

FOUR FIGURES

INTRODUCTION

The general subject of pigment migration has received much attention during recent years. While it is not the purpose of this paper to deal with the movements of melanophore pigments, we can not disregard the effect which the study of this problem has had upon the study of the migration of retinal pigment. There can be no doubt that an intimate relation exists between the movements of the two forms of pigment, as there is no doubt concerning the morphological similarity existing between pigment spots and the eye spots of many of the lower animals.

The striking changes in coloration exhibited in chameleons early led to investigations as to the physical factors involved. Conclusive evidence showed that the movements of melanophore pigment was brought about largely by variations in light intensity and temperature. The work of Carlton ('03), Parker and Staratt ('04), and Parker ('06) is sufficiently well known to need only brief mention. Carlton found, in the case of *Anolis*, the outward migration of pigment in the pigment spots to be directly dependent on the action of the sympathetic nervous system, and the inward migration simply a return to the resting state.

In chameleons the migration was found to be under the control of the spinal nerves.

As these observations have been made only upon the marine crustacea, it was suggested to me by Professor C. W. Hargitt that a series of comparative studies upon a fresh water crustacean might be of some value. The occurrence of the Phyllopod, *Branchipus*, in a pond near Syracuse, and its especially promi-

ment eyes made it a very favorable object for the investigation. In the spring of 1908 these crustacea could not be found at Syracuse, but material for experiments was obtained from Jordan, a small town seventeen miles west, and this supply was supplemented by material from Potsdam and the West, and fresh specimens from Syracuse in the spring of 1909. Experiments were made and subsequent study conducted with a view to determining the effect of varied heat and light on the migration of retinal pigment in these eyes.

HISTOLOGICAL METHODS

The methods of preparation which gave the best results are, in brief, as follows:

1. For killing and fixing, hot picro-acetic acid was used. The animals were dipped in and held for a few seconds, then transferred to 80 per cent alcohol. Formalin proved unsatisfactory for fixation, and also rendered the material hard to stain in some cases. Corrosive sublimate fixation was also inferior to picro-acetic.

2. *a.* Ehrlich's haematoxylin *in toto* or section gave the best results of any of the stains tried. If used for staining *in toto*, a period of at least sixteen hours was necessary. When the sections were stained upon the slide, a minimum staining of ten minutes was allowed. The one stain was sufficient to show all features clearly, but eosin was occasionally used as a counter stain.

- b.* Iron-haematoxylin with counter stain of Bordeaux red also gave satisfactory results. The slides were treated as follows: left in iron-haematoxylin, a minimum of fifteen minutes; plunged into a Fe_2Cl_6 solution until sufficiently differentiated; washed in water; stained in aqueous solution of Bordeaux red for three minutes; dehydrated; cleared and mounted.

- c.* Borax carmine failed to give the desired differentiation.

- d.* Haidenhain's triple stain was temporarily satisfactory, but was not permanent.

3. Xylol proved to be the best clearing agent. Cedar oil was not so good. Material *in toto* required an hour at the mini-

imum for clearing. Infiltration of at least one and one-half hours was necessary. Paraffin melting at 62° C. permitted sectioning at from 3 to 5 microns.

4. To see clearly the nuclei of the reticular cells which in the normal eye are obscured by large masses of pigment, the following method of depigmentation was used:

Two or three drops of hydrochloric acid were poured over a few crystals of potassium chlorate. When the green color of the evolving chlorine appeared, a few cubic centimeters of 70 per cent alcohol were added. The eyes were allowed to stand in this bleaching fluid over night and subsequent staining revealed the reticular nuclei clearly.

NORMAL STRUCTURE OF THE EYE

Before entering upon a discussion of the experimental work, a brief description of the normal eye is essential.

The eye of this form is one of the simplest of compound crustacean eyes. It is stalked, and of such large size as to be a very prominent feature. The structural elements are fundamentally the same as those of other crustacean eyes, the unit being the ommatidium.

The histology of the eye of *Branchipus vernalis* is described in brief by Parker ('91) and others, and a more detailed account of the eye of *Branchipus stagnalis* is given by Nowikoff ('05).

The outer surface of the eye is covered with a structureless cuticula, presumably a secretion of the underlying hypodermal cells. In *Branchipus vernalis* it is obviously faceted, having the form of concavo-convex elevations.

According to Patten, the hypodermal cells in *B. grubei* are of indefinite arrangement, but Claus and Nowikoff find in *B. stagnalis* a regular arrangement which the latter shows diagrammatically in the following way: the hypodermis covers the distal end of each ommatidium as a cuticular cap made up of six equal cells extending radially from the center to the circumference of the circle. The nuclei are oblate, and lie upon one side. The intervening space is filled by two cells with round nuclei. These nuclei are extremely large and extend at an acute angle into that

part of the cell lying between the cone cells. This arrangement as well as the faceted condition of the cuticula (both disputed points) have been observed in my preparations of the species found here.

The cone cells are four in number, of equal size and regular form. The crystalline cones are ellipsoidal and their mass in comparison with that of the cone cells is large. The nuclei of the cone cells were not found by Claus in the adult, and only indistinctly seen in the larvae. Nowikoff, however, states that they are well defined in his preparations, lie close under the crystalline cones at the proximal ends and are sphere shaped, while Patten finds these nuclei lying over the distal end of the cells like a cap.

In regard to the exact location of these nuclei, it seems to me that there has been a great deal of confusion arising from incomplete knowledge of the histology of the hypodermal cells. Patten, as I have previously stated, regarded the hypodermis as consisting of a "layer of indefinitely arranged cells" and the four cone cell nuclei as forming a cap over the crystalline cones. These nuclei, described as forming a cap over the crystalline cones, might be those of the hypodermal cells in their characteristic radial arrangement as shown by Nowikoff. If this were the case, Patten's description would agree with *B. stagnalis* as to the location, but not as to the number of the hypodermal nuclei. Nowikoff, however, goes a step further in identifying the cone cell nuclei.

I regret to have to say that in my own preparations I have been unable to confirm Nowikoff's or Patten's statement as to the location of these nuclei, though I have directed special attention to this point. It is a most peculiar circumstance that cells of this size and importance should fail to show clearly a definite nuclear structure.

A peculiar condition in one series may be worth considering in connection with this point. This series, cut at 5 microns, shows, under the one-sixth inch objective, structures which even upon critical examination appear as nuclei of the cone cells at the level of the distal ends of the reticular cells. A slight enlarge-

ment of the rhabdom at this place furthers the impression that we are looking at nuclear structures. Similar structures, though less evident, can be seen scattered elsewhere at various levels. They are of comparatively large size and appear round and very similar to the nuclei pictured by Nowikoff in *B. stagnalis*. Nuclear structures, if present in this level, would easily escape even careful observation; for unless the section be extraordinarily thin and exactly in the plane parallel to the rhabdom, the ends of the pigmented reticular cells would obscure them.

However, a closer study under a one-twelfth inch oil immersion lens shows these structures rather as reticulated fibrils of the cytoplasm of the cone cells with scattered pigment granules forming pseudo-nucleoli. Had these structures been constant in all of my slides, I would have been assured of the fact that they were nuclei, but their scarcity, the reticulated structure of the cytoplasm of these cells, and their appearance under the oil immersion lens forces the conclusion that they are artifacts.

The rhabdom is slender and in continuation with the cone cells (Nowikoff); it extends approximately three-fourths of the entire length of the ommatidium terminated proximally by the basement membrane, and is surrounded its entire length by the five reticular cells. The reticular cells contain a large quantity of pigment granules. Their cytoplasm is fibrillar, extending below the basement membrane as fibrils. The nuclei are oval and lie in the larger distal ends of the cells.

The nucleated basement membrane separates the retinal and nerve-fiber regions. It is perforated where the retinal cells penetrate it (Nowikoff, '05).

Blood corpuscles are found in varying numbers between the ommatidia, and especially upon the ventral side of the eyes. This was particularly noticeable in a large number of preparations, and is doubtless due to the close proximity of a large ventral sinus.

A comparison of sections of the eyes of *B. vernalis* and *B. gelidus* with the plates and descriptions of *B. stagnalis* given by Nowikoff show no differences of structure. The nuclei of the cone cells I was, of course, unable to compare.

An article by Dietrich ('09) came to my notice after the completion of the above discussion. It comprises an extensive description of the faceted eyes of diptera, and contains points of general interest in their bearing upon the problem under discussion. Mention is made of the fact that deep-sea crustacea have a greater number of elements in each ommatidium—possessing as a rule seven—than do the crustacea of a more pelagic habit, whose ommatidial elements have been reduced to five. An explanation of this is offered by the fact that the difference in intensity of light which these two extremes receive has possibly led to the reduction as an adaptive feature.

Another feature which calls forth comparison with the structure of the phyllopod eye is the location of the nuclei of the cone cells. In some species of diptera, these are found directly beneath the pseudocones, while in others they lie further proximally. Their appearance in the latter case closely resembles the structures in my preparations already described, which closer study revealed as artifacts.

EXPERIMENTS

An account of the experiments tried may perhaps best be given in tabulated form:

SPECIES	HOW KILLED	LIGHT OR DARK	TIME	TEMP.
				<i>Deg. C.</i>
<i>B. gelidus</i>	Corrosive sublimate	Dark	9 hrs.	5.5
<i>B. gelidus</i>	Corrosive sublimate	Dark	8 hrs.	20.0
<i>B. gelidus</i>	Hot picro-acetic	Dark	4½ hrs.	24.0
<i>B. gelidus</i>	Corrosive sublimate	Diffuse light	8 hrs.	17.0
<i>B. gelidus</i>	Corrosive sublimate	Diffuse light	9 hrs.	55.0
<i>B. gelidus</i>	Hot picro-acetic	Sunlight	Killed at six o'clock	19.0
<i>B. gelidus</i>	Hot picro-acetic	Sunlight	1¾ hrs.	21.0
<i>B. gelidus</i>	Hot picro-acetic	Dark	16 hrs.	21.0
<i>B. vernalis</i>	Hot formalin	Dark	5 hrs.	?
<i>B. vernalis</i>	Picro-acetic	Dark	5 hrs.	?
<i>B. gelidus</i>	Hot picro-acetic	Dark	30 min.	19.0
<i>B. gelidus</i>	Hot picro-acetic	Dark	15-20 min.	19.0
<i>B. gelidus</i>	Hot ipero-acetic	Dark	2 hrs.	5.0
<i>B. gelidus</i>	Hot picro-acetic	Dark	2 hrs.	21.0

The animals were taken from the pond and experiments made upon them without delay, for the character of all reactions was noticeably modified by keeping them for twenty-four hours in an aquarium. A loss of vitality, fading out of color, etc., became evident within a day unless the aquarium was kept at very low temperature, with a supply of soft mud in the bottom.

In all the experiments, the largest, most active specimens of both sexes were chosen. The experiments in light and dark were conducted as follows:

a. A few animals were placed in the direct sunlight, after allowing them to stand in a warm room until the water had been gradually raised to room temperature. In the early part of the season this method was found to be impossible. The maximum temperature at which they will live changes with the advancing season, and while early in the season the room temperature of 21° C. will kill them almost immediately, later the maximum is raised to from 26° C. to 29° C. The range of temperature between the optimum and the maximum for these animals, however, does not seem to vary. With a higher optimum, a higher maximum temperature ensues, but the range between these two appears to have a certain constancy of $5-8^{\circ}$ C.

b. On a cloudy day, an aquarium with a few specimens was set out of doors and allowed to stand for nine hours. The average temperature for that time was 5.5° C. and the few degrees of variation above or below were not considered of sufficient value to appreciably modify the result. The same experiment was twice repeated with aquaria upon a table in the center of the room, out of the direct rays of the sun, at temperatures of 17° C. and 20° C. for periods of eight hours.

c. In conducting the experiments in the dark, the greatest care was taken to exclude every means of access of light rays. The animals were placed in a tall glass dish, which was wrapped in light-proof paper. This was then either placed in a tin box and covered tightly, or left in the photographic dark room for the required length of time. The paper was then removed, and a flash of light thrown into the jar to assure the fact that all were

alive. The water was at once drained off and the specimens thrown into the killing fluid, heated to 60° C.

In preparing the eyes for sectioning it was found that the liability to injury from handling was greatly reduced by dehydrating and clearing the entire animal before separating the eyes from the body. After infiltration was complete, the eyes were removed from the body and imbedded with special attention as to orientation for transverse or longitudinal sections as desired.

CONDITIONS FOUND

A discussion of the conditions found in the material sectioned falls naturally under three heads: first, the effect of light; second, the effect of heat variation; and third, the relation of pigment migration to phototropism.

1. In these examinations care was taken to compare those sections cut at equal thickness, and to select those parts of the sections (long) where the plane of cutting was parallel to the long axis of the rhabdom.

a. In eyes which have been killed after exposure to the sun for a period of one and three-fourths hours the pigment is in the following condition: In the distal parts of the reticular cells the granules are accumulated in great quantities, so that it is impossible to distinguish the nuclei of these cells, which are located here. The entire length of the rhabdom is closely protected with a heavy layer of pigment, and here the lateral portions of the cells are much clearer as compared with the distal part. In the proximal third of the cells there are proportionately smaller quantities. Pigment is also heavily deposited below the basement membrane, and for a short distance along the nerve fibers. In eyes exposed to sun for longer periods, the conditions are identical. (Figs. 1 and 3.)

b. In diffuse light for eight hours, the pigment granules are still heavily deposited in the distal ends of the cells, and along the rhabdom. The lateral portions of the reticular cells, as in the case of sunlight, are much clearer than the densely pigmented region close to the rhabdom. The direct sunlight thus seems to produce no appreciably greater response of pigment than the diffuse light of a partly cloudy day.

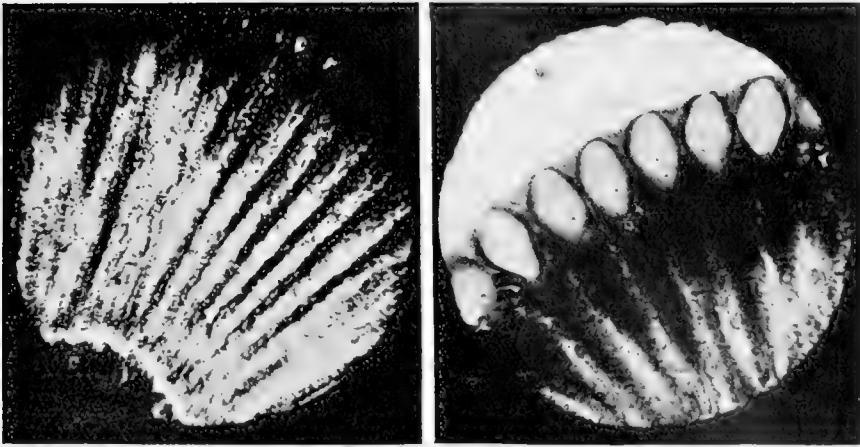

1

2

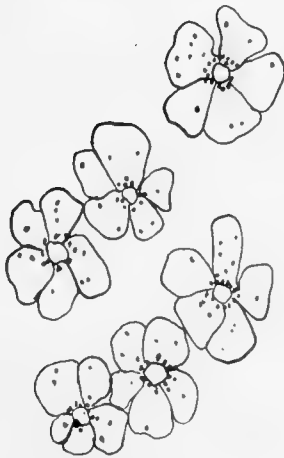

3

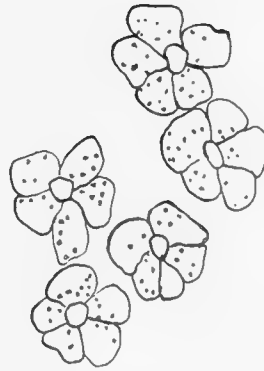

4

Fig. 1 Pigment conditions after exposure to sun until 6 p.m. on a sunny day. Rhabdoms covered with pigment.

Fig. 2 Pigment conditions after remaining in dark four and one-half hours. Readjustment of pigment through a lateral migration leaves rhabdoms exposed.

Fig. 3 Transverse section of ommatidia after exposure to sun for five hours. Conditions as in fig. 1. (Oil immersion, camera lucida.)

Fig. 4 Transverse section of ommatidia after remaining in dark four and one-half hours. Conditions as in fig. 2. (One-twelfth oil immersion, camera lucida.)

c. Eyes sectioned after remaining in the dark fifteen minutes, twenty minutes, and a half hour, show no appreciable movement or migration of pigment granules. The conditions do not vary from those in diffuse light to any appreciable degree. Pigment is heavily deposited for a short distance down the nerve fibers below the basement membrane.

d. In the eyes which have been in the dark for two hours, the pigment has begun its lateral migration and forms an intermediate stage between the two extremes *a* and *e*.

e. The eyes which have been in the dark four and a half hours, show the pigment closely packed in the distal ends. The granules are not packed close to the rhabdom as in sun and diffuse light, but are scattered laterally in the cytoplasm by a lateral migration or a readjustment. The outline of the rhabdoms is thus not so clearly defined by a heavy boundary of pigment granules, but their surfaces are more exposed. The entrance of light rays would result in a more intense stimulus than under the previously described conditions. A dense accumulation of pigment occurs below the basement membrane and proximally down the nerve fibers (fig. 2 and fig. 4).

f. In eyes left in the dark from eight to sixteen hours, these variations in pigment location become less and less evident, and in general the eye assumes the appearance of those killed in direct sunlight. The distal pigment is closely packed around the rhabdom and the reticular nuclei, the pigment in the proximal part lying close to the rhabdom. Eyes which have been in the dark for eight hours or more were thus not considered in drawing conclusions as to the effect of light and dark.

The adaptive movement of pigment granules in these eyes would thus appear rather as a rearrangement or readjustment of the pigment granules in the reticular cells than as a pronounced migration proximally in the dark, and distally in the light. A proximal migration in the dark would result necessarily in an accumulation of pigment below the basement membrane, which would increase gradually from the light conditions to the completion of the migration. The pigment masses beneath the membrane would thus vary in a graded series, a condition which

does not occur in my preparations. The pigment deposited beneath the membrane is quite as dense in sunlight as in dark. The distal pigment in all my preparations is densely packed around the rhabdom and the reticular nuclei, and shows no sign of movement due to light or temperature changes.

The protective function of the pigment is accomplished in a different way. A lateral movement of the granules exposes the rhabdom in the dark, while an opposite movement in the light brings them close against the rhabdom. Since these eyes have no accessory pigment cells, which in other crustacean eyes serve as a reflecting apparatus in the dark, the cytoplasm of the reticular cells must perform this function.

So, unlike the eyes of *Cambarus* and *Gammarus*, the proximal and distal migrations of pigment granules are not found in *B. gelidus*, but are replaced by a lateral migration, outward in the dark, centrally toward the rhabdom in the light, while the protective function of the pigment remains the same.

2. The temperature changes, so far as I have been able to note, produced no appreciable effect on the migration of the pigment. High temperatures were of course impracticable in experimental work, causing almost immediate death. In eyes exposed to diffuse light at 5.5° C. and 17° C. no difference could be noted in the distribution of the pigment.

3. Experiments were made with a view to determine the degree of phototactic response, and also its possible bearing on the movement of the pigment.

a. A dozen animals, which had just been brought in from the pond, were put into an aquarium in a large amount of pond water at 21° C. Of this number, five were young specimens, the others adults. Light from a 16-candle power lamp was thrown into the aquarium from above with the following results:

11 were strongly positive. 1 female was indifferent.

The two youngest specimens made frantic efforts to approach nearer the light beating their heads against the sides of the aquarium. The light was then placed below the jar. Nine responded at once by following the light. One male, one female, and one young specimen were indifferent for a period of three minutes,

when they too went to the bottom. If the light were held below the jar, the tendency to orient themselves with their long axes perpendicular to the source of light was stronger than the habit of swimming with the appendages upward, and they stood upon their heads making futile efforts to reach the light.

b. A larger number of animals was then put into the jar and the same experiments repeated. The younger ones showed a much quicker and more positive response than the adults. The depth of the water effected no change in the character of the response. Special attention was given to the occurrence of the animals in their natural habitat, to determine whether the responses given in the laboratory were merely artificial or whether, even in the natural environment, the direction of the light rays had a noticeable effect on the location of these crustacea. On a bright, sunny afternoon, when the water was 11° C. a much larger number of specimens was found swimming on the west side of the pond than on the east side. They were not, however, very active, on account of the low temperature, but for the most part were swimming slowly along the bottom about an inch above the mud. For some time, the direction of the wind was thought to have a marked influence on the distribution in the pond, but the wind on this day was blowing from the northwest, and the animals must have gone almost directly against the wind in order to appear in such large numbers on the western side of the pond.

c. The temperature of the water in one jar was gradually raised by the addition of small amounts of hot water. Pond water was heated for this purpose to guard against the addition of any chemical which might influence the response. When the water reached 24.9° C. to 25.5° C., the light was placed above the jar. The animals responded positively as in *b.* They became very active, and the branchipeds greatly increased their rate of motion. As the temperature reached 27° C., convulsive jerkings became frequent, jerking the animals almost out of the water when they came to the top in response to light. Between 27° C. and 29° C. they became less and less active and sank to the bottom of the jar. At 31° C. they were all dead. The increase in temperature does not, therefore, cause a negative response, but merely

a greater activity which finally leads to spasmodic muscular contraction and death.

Numerous reports of photomechanical changes in retinal pigment have appeared referring to amphibia, cephalopoda, and arthropoda. Exner ('91) and Parker ('97 and '99) record the effect of changes in light intensity on retinal pigment in *Palaemon* and *Gammarus*.

These reports have led without exception to the conclusion that the same laws of migration which hold true in the case of melanophore pigment apply as well to the migration of retinal pigment under various degrees of illumination. The uniformity of the effect of heat, however, has only recently been acknowledged. Kühne ('79) observed that the retinal pigment in frogs' eyes in darkness was withdrawn further proximally in a high than in a low temperature. Herzog ('05) confirmed and amplified these results, and further stated that while increased heat produced a proximal migration, decreased temperature a distal migration between 0° and 18° C., above this temperature exactly the reverse took place. The question of temperature influence was resumed several years later by Congdon ('07) in the case of Arthropod eyes. Experiments on *Palaemonetes* and *Cambarus* confirmed the previously published results of Kühne and Herzog. Response to raised or lowered temperature in these crustacea is much weaker than photomechanical response, and probably of no functional importance, as the migration due to temperature change occurred much above normal conditions.

As to the physiological importance of retinal migrations due to varied light conditions, there is no doubt that the distribution of the pigment along the sensitive parts of the eye protects it from too intense illumination by the absorption of light rays; while on the other hand, the withdrawal of pigment from them gives easy access to the non-injurious rays of diffuse light. In eyes which possess, in addition to the dark pigment cells, whitish accessory pigment cells (*Palaemon*, according to Congdon, '07) these cells serve to reflect light rays into the rhabdom on withdrawal of the pigment in diminished light.

In addition to this protective result the migration of retinal pigment has a bearing upon the phototropic response of animals in which this occurs. *Gammarus annulatus* shows (Smith, '05) pronounced migration of pigment, and accompanying this a marked change in behavior toward the light stimuli. The close correlation of these two facts in matter of time, points towards the fact that the change from negative phototropism to a marked positive response is due to the exposure or protection of the rhabdom by movement of the pigment.

d. The effect of a moving light was then tried. A light was held above the jar until the usual response was given, and the number of negative or indifferent specimens counted. Then it was moved slowly around the jar. In every case the positive response was greater, and more definite with the moving than with the stationary light.

e. A larger number of animals was placed in an aquarium and allowed to stand in the dark for an hour at room temperature. They were then exposed to light. They remained indifferent for a short period before any definite response was noted, but then gave a positive response.

Another aquarium was tightly wrapped in black paper and made thoroughly light-proof. This was placed out of doors (about 19° C. and allowed to remain for five hours. It was then taken to a photographic dark room and opened under a light of 16-candle power intensity. The majority of the specimens were negative for a period of from two to three minutes, but after remaining in the light, gradually became positive as under the usual conditions.

The same specimens were at once placed in the dark and left for two hours longer. When exposed to the light, the negative reaction was even more definite than before.¹

¹In a recent paper on phototropic responses of *Branchipus* (McGinnis, '11) the statement is made that *Branchipus* is never negative to light, even after exposure to darkness, but no record is made of the time necessary to bring about the normal response after this exposure. The peculiar "reversal of geotropic response" recorded in the same paper (p. 237) may have been influenced by negative response to light, the other positive responses to gravity being, as suggested, simply the natural falling of bodies.

The reversal of the response in my experiments is obviously related to the movement of the pigment in the eyes. As the previous results have shown the condition of the eye at the end of five hours to be one in which the sensitive rods are exposed to the fullest extent, the sudden entrance of a strong light would naturally cause a negative reaction. The fact that in the first experiment an exposure to 16-candle power light did not cause this negative response is doubtless due to the incomplete migration of the pigment in the shorter period of time.

SUMMARY OF RESULTS

1. The effect of light and dark on the movement of pigment granules in the eye of *Branchipus gelidus* is in the nature of a readjustment rather than a proximal and distal migration.
2. The distal pigment is not influenced by variation in light intensity.
3. In light, the pigment granules collect closely around the rhabdoms, protecting them from too intense stimulation.
4. In the dark, the granules move laterally and are readjusted so that they become more evenly distributed through the cytoplasm of the retinular cells.
5. The time occupied in complete readjustment is between four and one-half and five hours.
6. The cytoplasm of the retinular cells serves as a reflecting apparatus in a weak light in the absence of accessory cells.
7. Changing temperatures have no appreciable effect upon pigment migrations, higher temperatures causing almost instant death.
8. *Branchipus gelidus* is positively phototropic. Animals exposed to light after remaining in the dark five hours were negatively phototropic.

BIBLIOGRAPHY

- CARLTON, F. C. 1903 The color changes in the skin of the so-called Florida chameleon, *Anolis Carolinensis* Cuv. Proc. Amer. Acad. Arts and Sci., vol. 39, no. 10, pp. 237-276, 1 pl.
- DAHLGREN AND KEPNER 1908 Principles of animal histology.
- DIETRICH, WILHELM 1909 Die Facettenaugen der Dipteren. Zeit. für wiss. Zoöl., Bd. 92, Heft 3.
- HAY, O. P. AND W. P. 1889 A contribution to the knowledge of the genus Branchipus. Am. Nat. February, vol. 23, no. 266, pp. 91-95.
- HERZOG, H. 1905 Experimentelle untersuchungen zur Physiologie der Bewegungsvorgänge in der Netzhaut. Arch. f. Anat. u. Physiol., Physiol. Abt. Jahrg. Heft 5-6, pp. 413-464, Taf. 5. (Original not available.)
- KÜHNE, W. 1879 Chemische Vorgänge in der Netzhaut. M. L. Hermann, Handbuch der Physiol., Bd. 3, Theil 7, pp. 235-342. (Original not available.)
- MCGINNIS, MARY O. 1911 Reactions of *Branchipus serratus* to light, heat and gravity. Jour. Exper. Zoöl., vol. 10, no. 2, pp. 227-239.
- NOWIKOFF, M. 1905 Über die Augen und die Frontalorgane der Branchiopoden. Zeit. für wiss. Zoöl., Bd. 79, Heft. 3, pp. 432-464, Taf. 2.
- PACKARD, A. S. 1878 A monograph of the phyllopod crustacea of North America, with remarks on the order phyllocarida. U. S. Geol. and Geog. Survey of the territories of Wyoming and Idaho, 1879, pp. 295-514. Part 1, 39 pl.
- PARKER, G. H. 1891 Compound eyes in crustacea. Bull. Mus. Comp. Zoöl., Harvard Coll., vol. 21, no. 2, pp. 45-140, 10 pl.
- 1897 Photomechanical changes in the retinal pigment cells of *Palaeomonetes*, and their relation to the central nervous system. Bull. Mus. Comp. Zoöl., Harvard Coll., vol. 30, no. 6, pp. 273-300, 1 pl.
- 1899 The Photomechanical changes in the retinal pigment of *Gammarus*. Bull. Mus. Comp. Zoöl., Harvard Coll., vol. 35, no. 6, pp. 141-148, 1 pl.
- 1906 The influence of light and heat on the movement of the melanophore pigment, especially in lizards. Jour. Exper. Zoöl. Vol. 3, no. 3, pp. 401-414.
- PARKER, G. H. AND STARATT, S. A. 1904 The effect of heat on the color changes in the skin of *Anolis Carolinensis* Cuv. Proc. Amer. Acad. Arts and Sci., vol. 40, no. 10, pp. 455-466.
- ROGERS, C. G. 1906 A chameleon-like change in *Diemyctylus*. Biol. Bull., vol. 10, no. 4, March.
- SMITH, GRANT 1905 Effects of pigment migrations on phototropism of *Gammarus annulatus*. Am. Jour. Physiol., vol. 13.

THE DEVELOPMENT AND FUNCTION OF VOLUNTARY AND CARDIAC MUSCLE IN EMBRYOS WITHOUT NERVES¹

DAVENPORT HOOKER

From the Sheffield Biological Laboratory of Yale University

FIFTEEN FIGURES—ONE PLATE

INTRODUCTION

The influence of the nervous system upon development has been much studied and discussed, and it is natural, owing to the complicated nature of the subject and the close relation of the nervous system to the rest of the body, that the views that have been held have been diverse and conflicting.

The literature on this subject up to 1904 has already been fully reviewed by Harrison ('04) and Goldstein ('04), and the reader is referred to their papers.

Harrison ('03, '04), using much earlier stages than Schaper ('98) had used, removed the entire spinal cord from embryos of *Rana sylvatica*, *virescens* and *palustris* before visible differentiation of the axial musculature had begun and found that the muscle tissue subsequently differentiated normally. The irritability of the nerveless muscle was not fully tested, however, though one of the operated embryos did give response to uni-polar electric stimulation, showing its independent irritability. Harrison also found that muscle tissue would develop normally when embryos of the frog were kept anaesthetized in acetone-

¹The results detailed in this paper were reported in brief at the May meeting of the Society for Experimental Biology and Medicine, 1910, and an abstract appears in its proceedings. A more detailed account was reported before the American Association of Anatomists, at the Ithaca meeting in 1910.

chloroform during their development. In this way, the motor nerve impulses normally transmitted to the developing muscle were eliminated.

Goldstein ('04) published a comprehensive paper after repeating Shaper's experiments with improved technique. The embryos which he used were of the same age as Shaper's and, even though the whole spinal cord and hind-brain were removed, the experiments are therefore open to the same objection as Shaper's, viz.: that the first nervous connections had been established before the operation. Goldstein found that the operated embryos developed normally and that their muscle tissue would respond to direct stimulation.

Wintrebert ('03-'05) removed the cord from frog and *Amblystoma* embryos at various stages and found that they developed normally. He described the presence of contractility in the muscle tissue before the nerves reach it. He states that he observed not only contraction of the myotomes, but also movement on direct stimulation of the fingers of the hind extremity of the frog larva, from which extremity all nerve tissue had been removed.

The most recent work directly bearing on this problem is that of Paton in 1907. He concluded that the first movements of the embryo take place before there is any true nervous connection between the muscle tissue and the central nervous system, and used this as an argument in favor of the Hensen theory of nerve development.

The purpose of the experiments detailed in the present paper was to determine the following: (1) Does differentiation of muscle fibrillae and the establishment of the nervous connection with the central nervous system precede or follow the acquisition of contractility in the myotomes in the normal embryo? (2) Will voluntary muscle which has developed without the influence of nerves respond to stimuli and, if so, must the stimuli be applied directly or may they be transmitted by non-nervous paths? (3) Will cardiac muscle differentiate and function independently of nervous control? (4) Will the gross form of the heart, developing under such conditions, be normal?

METHODS

The operations were performed on frog embryos at the stage of development immediately following the closure of the neural folds (fig. 1). At this time they are from 2.25 to 3.75 mm. in length, according to species, and there are absolutely no nerve fibers in the central nervous system nor any traces of peripheral nerves. The embryos operated upon by Shaper and Goldstein were much older and the chances of nerve contamination were correspondingly greater.

The instruments used were: a pair of Noyes' iridectomy scissors, an iridectomy knife, forceps and needles, the points of all being ground down to a more than hair-like fineness. All operations were performed under a Zeiss binocular microscope.

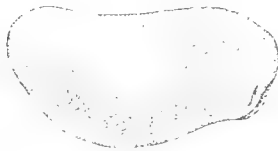

Fig. 1 Embryo of *R. sylvatica*, to show the stage of development used in the beginning of the experiments. $\times 9\frac{1}{2}$. (After Harrison.)

For the study of the voluntary muscle, it was necessary to remove the source of nerve supply to the myotomes. The cord, hind-brain and skin of the dorsal region were removed by Harrison's method. The wound surface produced by this operation is so small and heals so readily, that no skin graft was made.

For the experiments to study cardiac muscle, a much more complete operation is necessary. Not only must the cord, hind-brain and skin of the dorsal region be removed, but the fore- and mid-brain, the primordia of the cranial ganglia (fig. 2) and the skin of the entire head region must be taken out as well.

The cardiac plexuses receive such a large contribution from the tenth nerve, according to the work of Kuntz ('09), that it is especially necessary to extirpate its ganglia. In operating, the first step is to remove the dorsal structures as in the previous

experiment. The embryo is then laid on its side and the skin cut from the dorsal wound surface to the ventral aspect of the body behind the branchial region. When this has been done on both sides, the skin is dissected away from the entire head down to the suckers and removed by a circular cut just above them. The remainder of the nervous system of the embryo which has not been previously removed is thus completely exposed and may be taken off with the knife or needles.

As may be well imagined, the cut surface in such an operation is considerable, and, to prevent disintegration, a skin flap from the abdomen of another embryo is grafted over the wound.

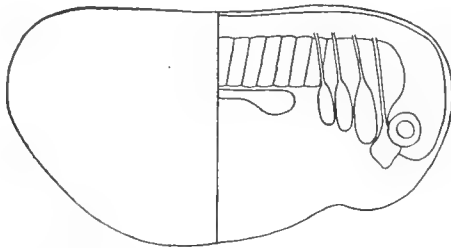

Fig. 2 Diagrammatic sketch to show the cranial ganglia present at the stage of operating—They are, from before backwards, the ganglia of the 5th, 7th—8th complex, 9th and 10th.

The flap is held to the embryo by piling silver wire about it to prevent movement, after the method of Born.

The embryos were operated in 0.5 per cent saline solution and were kept in it for one or two days after. They were then transferred to water.

Histological examination showed that the nervous system was entirely removed (fig. 3), except in four cases in which a small portion of the infundibulum was found to have been left in. These cases were carefully examined for nerves, but no trace of any were found. In view of the fact that no differences were found between the action of the heart in these and in the embryos absolutely without any nerve tissue, they were not rejected.

Mechanical and electrical stimulation were used to determine the irritability of the voluntary muscle. The embryos were stimulated with a human hair, according to Coghill's method, and with finely pointed steel needles. All stimulating was done under the binocular microscope.

For observations upon the heart, the embryos were placed on the stage of an ordinary microscope and the region just behind

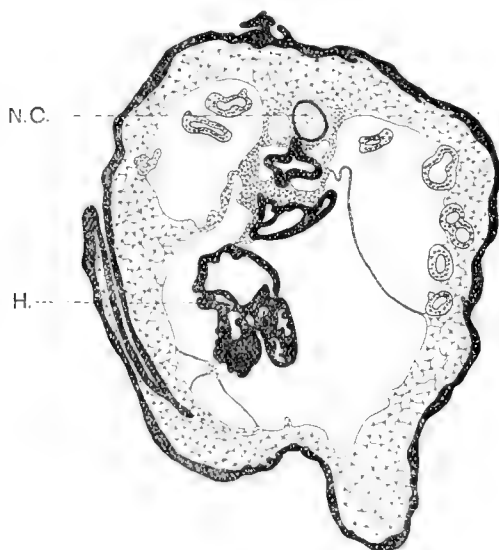

Fig. 3 Diagrammatic cross-section of the body of an embryo of *R. palustris* from which the entire nervous system was removed. *H*, Heart; *N.C.*, Notochord; notice the absence of the spinal cord above it.

the mouth watched for the beat. This method is a very accurate one, as the slightest action of the heart is noticeable by the movement of the skin. At later stages in *palustris* embryos, the skin becomes transparent and the heart itself may be seen.

The embryos were killed in a sublimate-acetic mixture, sectioned and stained either with iron haematoxylin or with Held's molybdic acid haematoxylin. Those stained by the former method were usually counterstained with Congo red.

The experiments detailed in this paper were performed on the embryos of *Rana sylvatica*, *palustris* and *pipiens*. The embryos of *Rana sylvatica* are the least desirable for operating, owing to the strong dorsal curvature of the body. *Rana palustris* and *Rana pipiens* have nearly straight backs, but in the former there is a greater contrast between the nervous tissue and the surroundings, so that they may be easily distinguished from one another even macroscopically. For this reason *palustris* is preferable to the more diffusely colored *pipiens*.

MOVEMENTS OF NORMAL EMBRYOS

The movements of frog embryos in response to stimulation vary greatly according to their age. If embryos are carefully watched in their development and stimulated at short intervals, a stage will be found where some will respond to stimulation and some will not. The reaction is characteristic. As pointed out by Harrison ('04) "it consists of a sharp tonic contraction of the myotomes on the same side of the body and immediately at the point of the application of the needle prick." It is necessary that the stimulus be given with a needle sharp enough to penetrate to the myotomes. The stimulus, then, is a direct one, but it is likely that the mechanical effect of the contraction of one myotome may sometimes stimulate neighboring myotomes to contract.

This non-nervous type of response is very different from the nervous type which is found in slightly later stages. The characteristics of this later type were pointed out by Harrison in 1904 and have since been more thoroughly studied by Coghill ('09). At this stage, the response is asymmetrical, the contraction first being away from the side stimulated, then toward it, the result being a swimming motion.

A number of embryos taken at the first appearance of the early or non-nervous type of response, some of which moved and some did not, were fixed separately and cut into serial sections. On examination, it was found that the development both of those which responded and of those which did not was at essentially the same stage. In both, the fibrillation of the voluntary muscle

had begun and motor nerve connections between the spinal cord and myotomes were present. Thus it was evident that contraction on stimulation is a function normally acquired in the axial musculature of the frog just after the beginning of the process of fibrillation and after establishment of the connection with the central nervous system. In the muscles of the limbs the case is different, for Braus ('05) found that the muscles in Bombinator do not respond to stimulation until a much later phase of development is reached and not until spontaneous contraction takes place.

Harrison ('04) showed that fibrillation was not dependent on nervous connection. For proof that contraction is not dependent on it, we must turn to the experiments.

MOVEMENTS OF CORDLESS EMBRYOS

Effect of mechanical stimulation

For the experiments on mechanical stimulation of voluntary muscle, 77 embryos were operated, of which 34 died, were abnormal, or were imperfectly operated. Of the remaining 43 embryos which showed no abnormalities, 27 moved on stimulation and 16 did not. It is interesting to note that three-quarters of the latter died later from some organic deficiency, while less than half of those that moved failed to live, indicating, perhaps, that the relatively large number which did not react as compared with the number which did was due to vital disorganization of some sort.

Each of these embryos was placed on the stage of the binocular every twelve to twenty-four hours and stimulated with a human hair (Coghill, '09) or with a very finely pointed needle. The former method was finally rejected, since the operated embryos did not respond to skin stimulation as do normal ones with an intact reflex arc. The latter method was very satisfactory, as it permitted the direct stimulation of very minute areas of muscle tissue without any profound injury to the embryo.

Of those embryos which responded to stimulation, the irritability began on the first day after the operation in 9 individuals, on the second in 16 and on the third in 2. In no case did any

embryo begin to show reactions later than the third day after the operation. The reaction was a single quick contraction toward the side stimulated with the point of stimulation as the center of contraction. In no case was there a response unless the needle point penetrated the skin. Three specimens gave a tremor-like response, but microscopic examinations showed these to have nerve tissue present in the trunk region. Spontaneous movement was never observed in operated individuals. This is contrary to the results of Shaper and Goldstein, both of these authors having claimed that spontaneous movement is to be observed in the ventral half of embryos which have been cut longitudinally. I have repeated their experiments, operating at an earlier stage, however, but have not been able to confirm their results in this respect.

One of the most striking features of this experiment is that the embryos do not continue to be irritable for an indefinitely long period but cease to respond after a day or two. The irritability to mechanical stimulation lasted but one day in 20 individuals, two days in 5, and but one embryo responded during a three-day period and one during a period of four days.

Embryos killed at the end of the first day and examined for their histological structure, show that muscle fibrillation is well under way and that the entire development of the body is at the same stage as those of normal embryos in which contraction in response to stimulation is beginning to occur. The nervous system is, of course, lacking, but in general the stage of development is the same.

Microscopical examination of the embryos killed and preserved from six to eight days after the operation, shows, as brought out by Harrison, that the muscle differentiation is practically completed, though not quite so fully as in the normal embryo, that there is no nervous tissue posterior to the mid-brain and that, with the exception of the absence of the hind-brain and cord, the embryos are essentially normal. The principal abnormal feature of these embryos is their oedematous condition, plainly visible in the embryos as a whole and shown microscopically by the presence of many vacuoles in the muscle tissue.

Effect of electrical stimulation

For the experiments on electrical stimulation of voluntary muscle, 15 embryos were operated, all of which remained in the best of condition until killed. They were each stimulated, at least once daily, by a weak faradic current. The embryos were carefully watched through a binocular microscope while the stimulation was applied. Each embryo was placed on a small platinum plate in water, a fine platinum wire being used to form the other electrode. On each stimulation, the embryo responded by a single tonic contraction toward the side stimulated, the point of stimulation being the center of contraction. The type of contraction exhibited was exactly the same as that shown when the operated embryos were stimulated mechanically.

The embryos were killed after four or five days, during which time response to mechanical stimulation had ceased. Up to the time they were killed, all the specimens responded in the manner described above whenever stimulated electrically.

Microscopical examination of sections of these embryos shows that the cord was entirely removed. The embryos were in every respect similar to those used in the experiments on mechanical stimulation.

EXPERIMENTS TO DETERMINE THE MODE OF TRANSMISSION
OF THE STIMULI

Wintrebert ('04, '05) has described a 'sensibilité primitive' existing in embryos of *Rana esculenta* during a period of four days beginning at the stage following the closure of the neural folds. He says that if an embryo during this stage is cut through the back in the posterior part of the body, so that the spinal cord, notocord and part of the yolk are severed, leaving the two halves connected by the skin and yolk of the ventral region only, the front part will respond on stimulation of the posterior part. After the heart begins to beat, a cut near the anal region severs the animal into two independent parts, of which the anterior will not respond on stimulation of the posterior. Up to this time

there are no peripheral nerves, and the yolk will not transmit stimuli, so Wintrebert concludes that it must be the skin which acts as the transmitter.

To test these results, three sets of experiments on frog larvae and additional ones on *Amblystoma* were made. They were (1) a repetition of Wintrebert's experiments, (2) exposure and stimulation of the yolk, and (3) girdling of the skin around the body and stimulation of the posterior half with and without cutting the cord.

Embryos with the cord cut. In repeating Wintrebert's experiments (table 1 and fig. 4), it was found that no reaction was obtained in normal embryos of the first stage named by him. A 4.5 mm. *Rana palustris* embryo in which stage the tail bud is quite pronounced was the smallest from which a response was obtained. The discrepancy may, however, be due to the difference between European and American forms. Furthermore, in all

TABLE 1
Repetition of Wintrebert's experiments

EMBRYO	SIZE		RESPONSES													
	mm.															
1.....	4.25	0 0 0	0	0	0	0	0	0	0	0	0	0	0	0	0*	0
2.....	4.50	0 0 0	0*	0	+	†	0	0	0	0	0	0	0	0	0	0
3.....	4.75	0 0 0	0	0	0	0	0	0	0	0	0	0	0	0	0	0
4.....	4.75	0 0 0	0	0	0	0	0	0	0	0	0	0	0	0	0	0
5.....	5.00	0 0 *	*	0	+	°	0	+	°	0	0	0	0	0	0	0
6.....	5.00	0 0 +	0	+	+	+	0	+	0	+	0	+	+	+	+	+
7.....	6.00	+° +° +°	+°	+°	0	0	0	0	0	0	0	0	0	0	0	0
8.....	6.00	0 0* 0 0	0	0	0	0	0	0	0	0	0	0	0	0	0	0

Intervals of stimulations 15 seconds.

*Spontaneous contraction without stimulation. Where this is found above a negative response, it indicates that a contraction took place in the interval of stimulation following.

†Contraction slow in following stimulation.

°Contraction obviously due to shaking.

Total number of stimulations96

Total number of positive responses.....15

Total number of spontaneous contractions..... 5

Total number of contractions due to shaking..... 7

but one case, the number of times when responses were obtained from operated embryos was much less than the number of times when no reaction occurred. The older embryos frequently move spontaneously, however, and the probabilities are that some will move during the time that they are under observation. Many times the embryo moved just before it was to have been stimulated. That the movement may occur apparently as a result of stimulation, when it would have taken place without it, is absolutely certain. Several times, while an embryo was being stimulated at regular intervals and a large number of reactions was being obtained, the omission of two or three stimulations showed that the embryo was contracting more or less rhythmically, whether stimulated or not, the periods of the rhythm being the same as the intervals of stimulation.

This, however, is not the only explanation which can be offered for the contractions which take place. On careful analysis of the conditions preceding the contraction, three factors can be seen at work: (1) tension of the skin over the whole body produced by pressure with a dull needle, (2) shaking the embryo during the stimulation, and (3) hindering the locomotion of the embryo due to the action of its cilia. Whenever a needle sharp enough to penetrate the skin without increasing the tension elsewhere was used, no contraction resulted unless the myotomic area was stimulated. The shaking of the operator's hand will clearly cause contractions, so that great care must be taken to avoid this. Frequently the needle sticks after penetration and the embryo is shaken as it is withdrawn. This also produces contractions. Where the embryo's progress, caused by its own cilia, is suddenly stopped, a contraction almost always ensues. This is avoidable by slowly checking the motion.

Stimulation of the yolk

In the second series of experiments, an opening was made in the skin at the side of the animal (fig. 5) and the yolk stimulated through it. Out of a total number of 100 stimulations, 29 contractions were obtained. Of this number, 14 were obviously

due to shaking the embryo by running the needle through the body to the skin of the opposite side. This impaled the embryo, withdrawal of the needle was difficult and in every case the embryo was shaken. One embryo was contracting freely between the stimulations and the large number of responses given by it may be accounted for to some extent in this manner. Table 2 demonstrates the details.

The results show that the yolk, *per se*, as Wintrebert stated, will not transmit impulses, but contractions may result from shaking the embryo during stimulation.

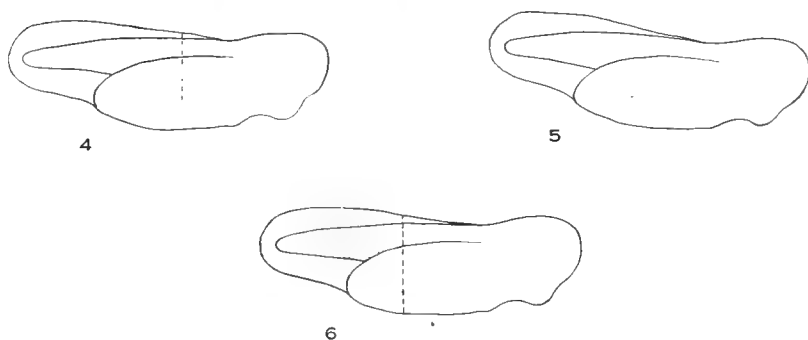

Fig. 4 Diagram of a frog embryo to show position of cut (by dotted line) used in the repetition of Wintrebert's experiments.

Fig. 5 Diagram of a frog embryo to show opening through which the yolk was stimulated in the second series of experiments to determine the mode of transmission of stimuli.

Fig. 6 Diagram of a frog embryo to show "girdling" of the skin around the body and the area in which stimuli were effective when the cord was uncut.

Girdled embryos

In the third series of experiments, the skin only was cut around the entire body, thus girdling it (fig. 6).

Stimulation in the region of the cord (within the dotted area indicated in the figure) when the latter is uncut, will nearly always produce a response in the anterior end of the body (table 3). If the cord is cut, there is no transmission of stimuli from the posterior part to the anterior. When the skin is girdled, the cord alone may serve for the transmission of mechanical shocks to the anterior

half, such as those produced by shaking the embryo. If the cord is also cut, the yolk has not consistency enough to admit of shaking the anterior half by disturbances in the posterior, consequently no contractions result.

TABLE 2
Stimulation of the yolk only

EMBRYO	SIZE		RESPONSES											
	mm.													
1.....	5.00	+ + 0 0	+ 0 0 0	0 0 0	+ + + 0 0	+ 0 0 0	0 0 +* + 0 0	0 0 0	0 0 0	0 0 0	0 0 0	0 0 0	0 0 0	
2.....	5.50	0 +* 0 0	+* 0 0 0	0 0 0 0	0 0 0 0	0 0 0 0	0 0 0 0	0 0 0 0	0 0 0 0	0 0 0 0	0 0 0 0	0 0 0 0	0 0 0 0	
3.....	5.75	0 0 0 0	0 0 0 0	0 0 0 0	0 0 0 0	+ † + † 0	0 0 0 0	0 0 0 0	0 0 0 0	0 0 0 0	0 0 0 0	0 0 0 0	0 0 0 0	
4.....	6.00	0 0 0 0	0 0 0 0	0 0 0 0	0 0 0 0	+ † + † 0	0 0 0 0	+ † 0 0	+ † 0 0	+ † 0 0	+ † 0 0	+ † 0 0	+ † 0 0	
5.....	6.00	0 0 0 0	+* +* +* +* +* +* +*	0 0 0	0 0 0	+* 0 +* 0 0	+* 0 +* 0 0	+* 0 +* 0 0	+* 0 +* 0 0	+* 0 +* 0 0	+* 0 +* 0 0	+* 0 +* 0 0	+* 0 +* 0 0	

Intervals between stimulations 15 seconds.

† Spontaneous contraction without stimulation.

* Needle pierced animal and embryo was shaken.

Embryo 1 contracted frequently between stimulations.

Total number of stimulations.....	100
Total number of positive responses.....	8
Total number of spontaneous contractions.....	7
Total number of contractions due to shaking.....	14

TABLE 3

Stimulation of the posterior portion of the embryo after 'girdling.' Cord intact.

EMBRYO	SIZE		RESPONSES											
	mm.													
1.....	4.50	0 0 0 0	0 0 0 0	0 0 0 0	0 0 0 0	0 0 0 0	0 0 0 0	0 0 0 0	0 0 0 0	0 0 0 0	0 0 0 0	0 0 0 0	0 0 0 0	
2.....	5.00	+* 0	+* +* +* +*	0 0 0 0	0 0 0 0	0 0 0 0	0 0 0 0	0 0 0 0	0 0 0 0	0 0 0 0	0 0 0 0	0 0 0 0	0 0 0 0	
3.....	5.50	0 0 0 0	0 0 0 0	0 0 0 0	0 0 0 0	0 0 0 0	0 0 0 0	0 0 0 0	0 0 0 0	0 0 0 0	0 0 0 0	0 0 0 0	0 0 0 0	
4.....	5.50	+* 0	+* +* 0	+* +* +*	0 0 0 0	0 0 0 0	0 0 0 0	0 0 0 0	0 0 0 0	0 0 0 0	0 0 0 0	0 0 0 0	0 0 0 0	
5.....	6.00	0 0 0 0	0 0 0 0	0 0 0 0	0 0 0 0	0 0 0 0	0 0 0 0	0 0 0 0	0 0 0 0	0 0 0 0	0 0 0 0	0 0 0 0	0 0 0 0	

Intervals of stimulation 15 seconds.

* Stimulations within dotted area shown in fig. 4.

Total number of stimulations.....	60
Total number of positive responses.....	1
Total number of spontaneous contractions.....	0
Total number of contractions due to stimulation of the cord.....	24

Judging from the results obtained, it would appear that, as Wintrebert claimed, the yolk will not transmit stimuli, but on the other hand, contrary to Wintrebert, there is no evidence that the skin will act as a transmitter of impulses other than those of a mechanical nature.

EXPERIMENTS ON THE HEART

For the experiments on the heart 45 embryos were operated. Of these, 16 died; in 2 it was impossible to see whether the heart functioned or not; and in 2 others the operation was imperfect. Of the remaining 25, the heart-beat was observed in 21, while it was found not to beat in 4 individuals.

The pulse rate

The beat usually becomes visible on the second or third day after the operation, though in a very few cases it begins earlier or later than this. The beating of the heart begins in normal individuals about twenty-four hours before it is visible in the operated embryos. The pulse-rate in the normal ones begins at 25 to 40 per minute and gradually increases to from 60 to 70. This latter rate is held approximately throughout the entire developmental life of the embryos. It is, however, difficult to give any definite rate as being the normal, owing to the fact that certain factors tend to vary it greatly. Temperature changes cause great fluctuations, and activity on the part of normal individuals tends to accelerate the heart. The comparisons between normal and operated embryos are not affected by temperature since controls and operated embryos are kept under the same conditions, but the muscular activity of the control, which often cannot be prevented, may seriously alter the validity of a comparison with the operated individual in its enforced permanent inactivity, the higher rate of the active normal being more nearly equivalent to the pulse of the operated embryo than is the rate in an animal which has been resting quietly. The rate in the operated individuals begins at 28 to 42 and rises slowly to

from 60 to 65 during the first few days, then the rate increases gradually to as high as 80, dropping soon after to about 50, shortly after which the embryo dies.

Two reasons may be given for this rise of pulse-rate.

Up to the time when the external gills would normally form, the rate is normal; but since the epithelium of the branchial region is removed by the operation, no gills ever develop, and a slow asphyxiation of the embryo results. This would ordinarily bring about acceleration of the pulse. Evidence of asphyxiation is found in the fact that all the embryos were oedematous, a condition, according to Fischer ('10), produced by a lack of oxygen to the tissues. To aid in aeration of the blood, some embryos were kept in water under an atmosphere of oxygen. These were not as oedematous as embryos not under oxygen, and they lived longer. The rise of pulse-rate finally took place, however.

Another explanation which can be given for the increased pulse-rate is that the time when the rate begins to increase beyond the normal is nearly coincident with the establishment of the connection of the vagi with the heart in normal embryos. It would be interesting if it could be proved conclusively that the absence of the inhibitory action of the vagi is responsible for the increased pulse.

A number of experiments were performed to attempt an elucidation of this point. In one series the skin of the branchial region was removed, leaving the embryos with an intact nervous system, but preventing the formation of external gills. The pulse-rate was carefully counted in both operated and control individuals. While the beat was distinctly higher in the operated embryos during the first few days, the difference decreased as time went on, probably in consequence of the development of internal gills, which would tend to bring the operated embryos back to normal condition. The results of these experiments indicate, then, that it is the disturbance of the respiratory function that causes the increase in the pulse-rate, though they are not conclusive with reference to the possible further effect of the withdrawal of the action of the vagi.

In another set of experiments, certain embryos were grafted by the dorsal wound surface to the lateral abdominal region of normal individuals, in the hope that the nurse would aerate the blood for the operated specimen. This was in a measure successful, the life of the parasite being prolonged, though not for an indefinite period. The position of the parasite upon the host was not favorable, however, for the observation of the heart, and the nature of the observations desired precluded the use of anaesthetics.

Differentiation of the heart muscle

Histological examination of these embryos demonstrated that the heart was in every case well developed and that the differentiation of the cardiac muscle was progressing normally. In the heart of normal individuals, the differentiation of the muscle tissue had progressed much farther and many more striated fibrillae were present, but one would naturally expect, as was the case with the voluntary muscle described by Harrison, that the differentiation of the heart would be retarded by the abnormal condition of the embryo. Much yolk is present and a few vacuoles are to be found here and there, but many sharply defined striated fibrillae may be seen in all parts of the heart (fig. 7). These differences between the normal heart tissue and that of the operated embryos also correspond to those found by Harrison ('04), in the case of the voluntary muscle tissue.

PLATE I

EXPLANATION OF FIGURES

8, 9, 12 and 13, from a model of the heart of a normal embryo of *Rana palustris* 10 mm. in length. Magnified 50 diameters.

10, 11, 14 and 15 from a model of the heart of an embryo of *Rana palustris* from which the entire nervous system had been removed at the stage following the closure of the neural folds. Magnified 50 diameters.

Ao, Aortic arch.

S. V., Sinus venosus.

Au, Auricle.

T. A., Truncus arteriosus.

Ao^b, Aortic arch which ends blindly.

V, Ventricle.

V.O., Opening of sinus venosus into auricle.

8 View of the right side of the model of a normal heart.

9 View of the front of the same model. The liver (fig. 7, L) has been removed from the model.

10 View of the right side of the model of the heart of an operated embryo.

11 View of the front of the same model.

12 View of the interior of the model shown in fig. 7, looking anteriorly.

13 View of the interior of the model shown in fig. 7, looking posteriorly.

14 View of the interior of the model shown in fig. 9, looking anteriorly.

15 View of the interior of the model shown in fig. 9, looking posteriorly.

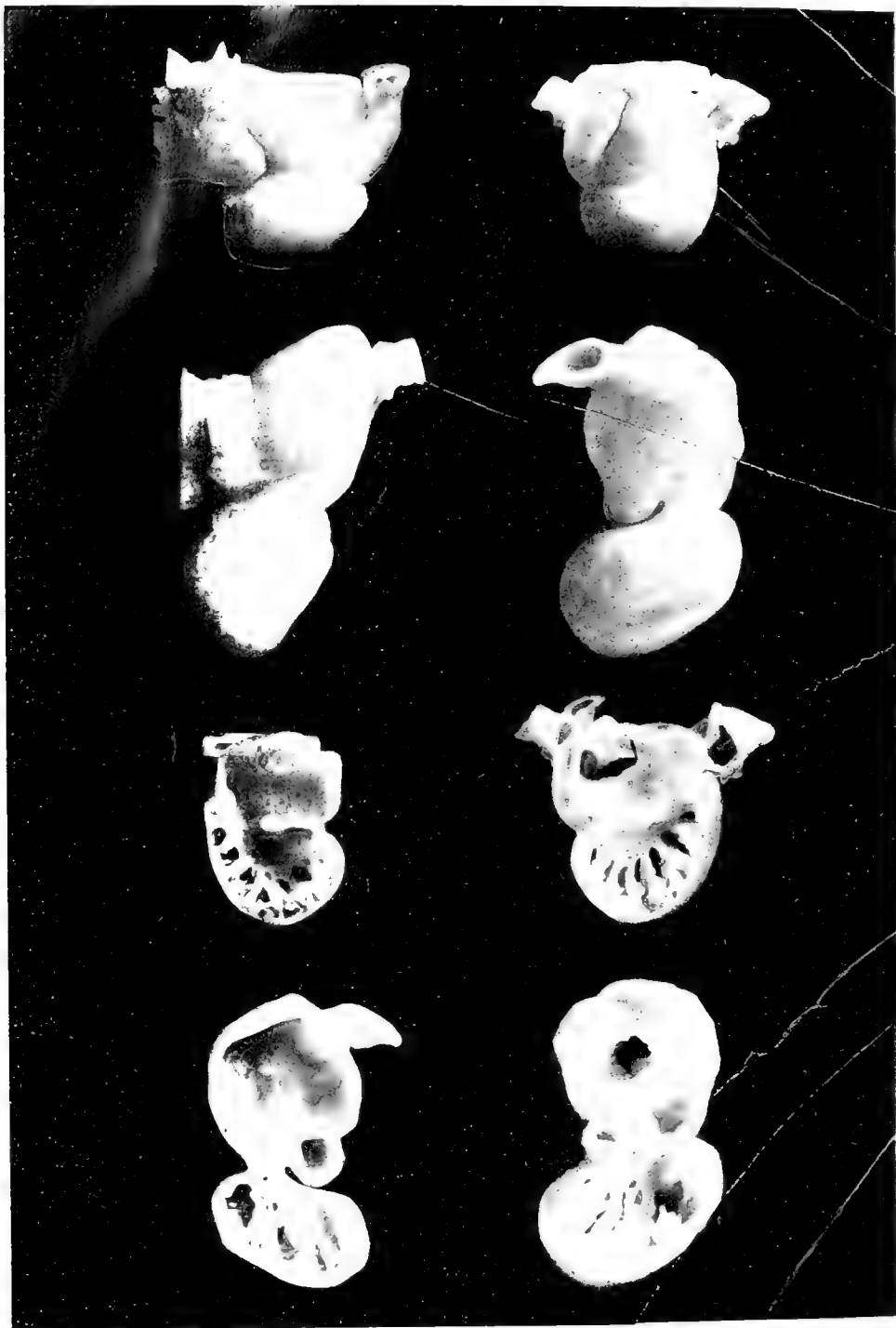

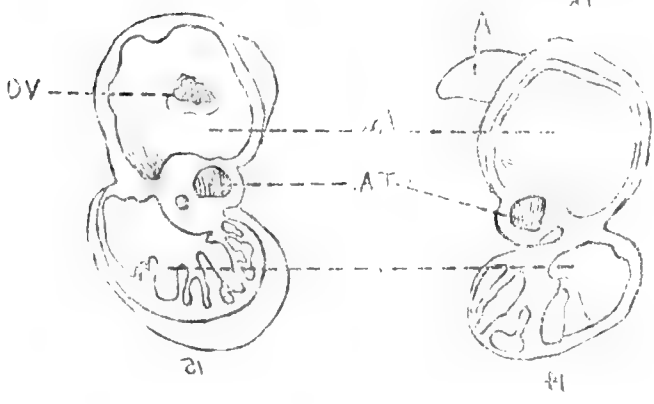
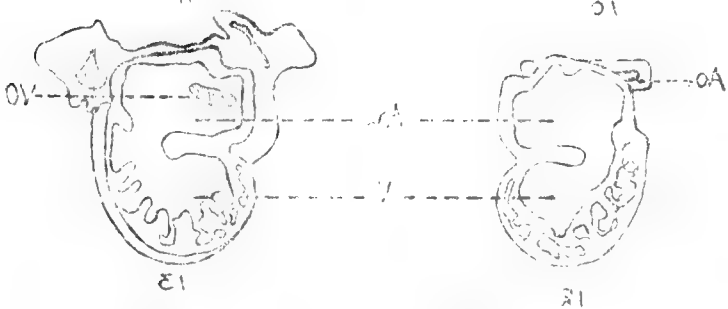
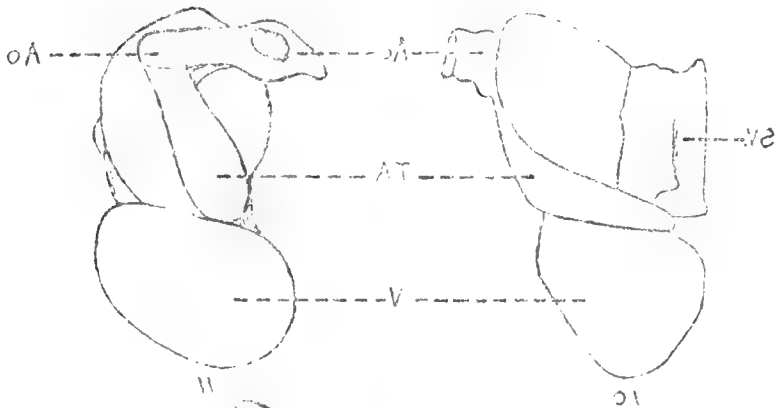
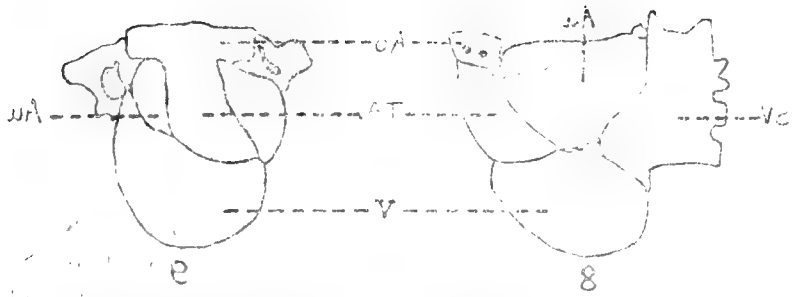

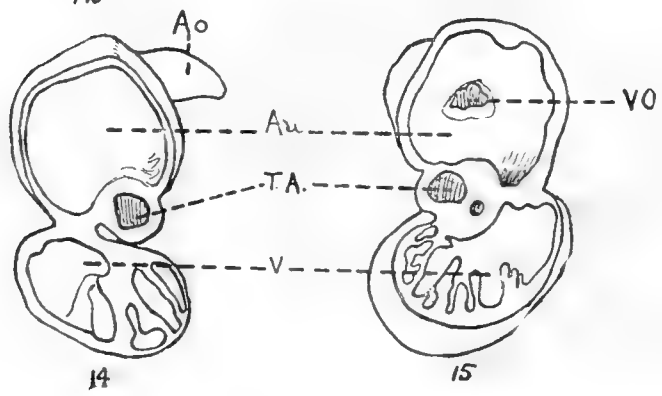
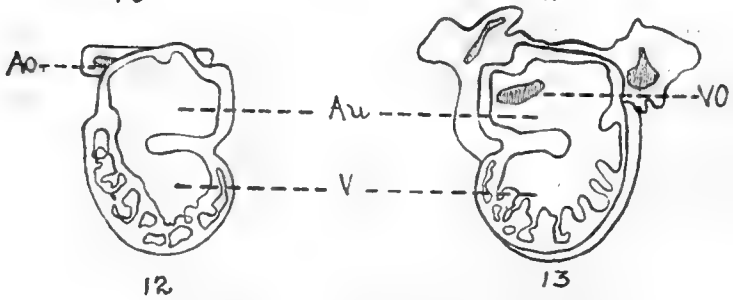
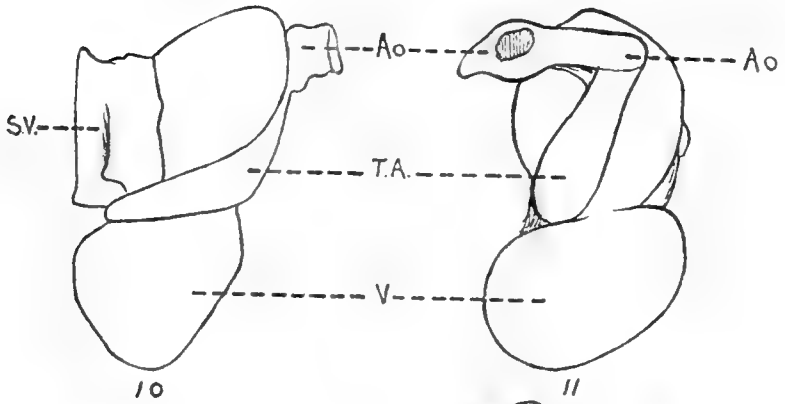
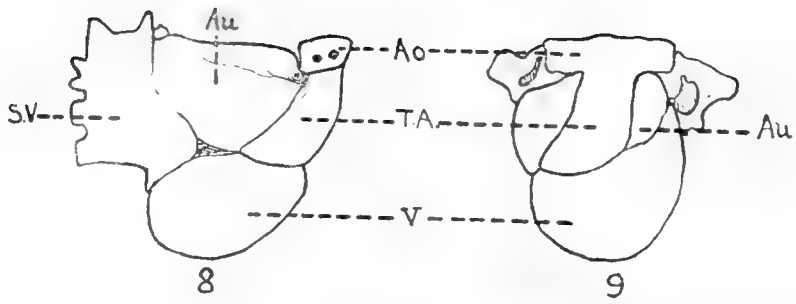

The gross form of the heart

Three methods were used in studying the gross form of the heart: examination of sections, wax-plate reconstructions and dissections. In all of these careful comparison was made between hearts of normal and of operated individuals, and the results obtained from the different sources were the same.

The models from which the figures were taken were made from a normal individual of *Rana palustris*, 10 mm. in length and from

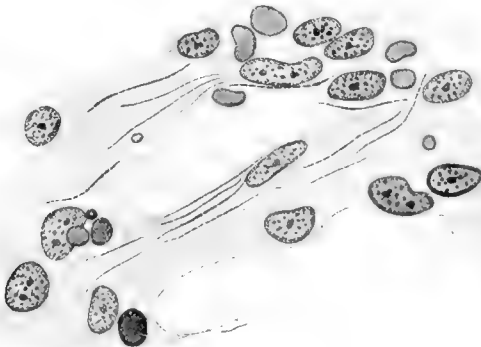

Fig. 7 Portion of the heart wall of the same embryo as Figure 3, showing the striated muscle fibrillae. Zeiss homo. immersion 2 mm., 2 oc.

an operated embryo of the same species, killed seven days after the removal of its nervous system. The two embryos were in very nearly the same stage of development. The model of the normal heart was made at a magnification of $133\frac{1}{3}$ diameters, that of the nerveless organ 100 diameters; both have been reduced to a magnification of 50 in the figures.

The heart of the normal frog larva shows clearly the relations of the various chambers in the embryonic organ (figs. 8, 9, 12 and 13). The venous sinuses are more wholly within the tissue of the liver than is the case in the adult organ, a fact due to the close relation of the liver to the heart in this stage. The

sinus venosus is a large cavity emptying into the right side of the auricle, which occupies a dorsal position on the heart. The auricle opens into the ventricle which occupies a ventral position.

The hearts of the operated individuals are much like the normal, except that in nearly every case some of the aortic arches end blindly. This is due to injury received in the operation. When one considers the very close relation of the heart in its pharyngeal position to the tissues of the brain and cranial ganglia, one can readily see the liability of the heart to injury during the removal of the nervous tissue. The necessity of removing the branchial epithelium with the consequent injury to the branchial arches, causes a disturbance of the normal formation of the aortic arches and leaves the systemic trunk alone functional. As a result of this, the truncus arteriosus does not usually divide, but remains single and runs directly into the dorsal aorta. The venous supply is normal.

The most striking thing about the gross form of the heart in the operated embryos is its relatively great size (figs. 10, 11, 14 and 15). Both the auricle and ventricle are dilated and hypertrophied. As is usual, the dilatation of the auricle is greater than that of the ventricle but the hypertrophy of its walls is less.

Dilatation of the heart is in general produced by two causes, working separately or together, viz: increased internal pressure and cardiac insufficiency. There seems to be ground for the belief that there is an hydraemia in these embryos, a condition which would create an increased internal pressure on the heart. As already noted, these embryos are oedematous. Fisher, ('10) says "every condition that makes for a state of lack of oxygen be this through disturbances in the affected parts themselves, or in some very distant organ, as the heart, makes for an increase in the severity of the oedema." The entire animal must suffer through lack of oxygen due to the disturbances in the arterial supply of the body and the non-development of gills in the operated embryos, which causes difficulty in properly oxygenating the blood. Krehl ('07) states that "it is possible that an hydraemia should be caused, not only by a primary reduction of the proteid constituents of the blood, but by a primary increase

in the amount of water. The hydraemias associated with . . . cardiac insufficiencies are probably partly of this nature."

In general, wherever dilatation is present, hypertrophy occurs, but the auricle is much behind the ventricle in the compensatory thickening of its walls. Another factor though probably not such an efficient one, in the hypertrophy of the heart is its rapid beat. Tachycardia, or any other condition which increases the work of the heart, tends to produce hypertrophy. As pointed out above, it is impossible to prove definitely whether the tachycardia here present is due to dyspnoea or to the lack of the controlling power which the vagi normally exercise, though the evidence at hand points toward the former.

DISCUSSION OF RESULTS

It is evident from the experiments that in normal frog embryos the differentiation of the fibrillae in axial muscles precedes the acquisition of contractility and that contractility in response to stimulation appears before spontaneous contractility. Further, just before the embryos become irritable to stimuli, the myotomes become connected with the central nervous system by motor roots. The fact that contractility begins almost synchronously with the establishment of nervous connections in the muscles of the body wall might suggest that there is a causal connection between the two and, as a matter of fact, this mode of reasoning has already been employed by a number of authors. The insecurity of such arguments is clearly demonstrated, however, by the experiments on cordless embryos whose muscles react to stimuli without ever being connected with the nervous system.

It seems quite clear that the contractions of voluntary muscle tissue seen after mechanical stimulation of cordless frog larvae are due to direct stimulation, since the central nervous system was removed before there were nerves of any kind growing from it, and since contraction takes place only when the muscle is actually punctured. This phenomenon is, however, explained by Wintrebert, Shaper and others on the basis of a mode of non-nervous transmission of impulses. It is, of course, impossible

to prove that a non-nervous conduction path does not exist but, on the other hand, its presence has never been actually demonstrated by any of the experiments which have been adduced in its favor by previous investigators and all the phenomena which have been supposed to demonstrate the existence of such conduction paths are quite as readily explained on the basis of more familiar factors. Mechanical tension of the skin and shaking or jarring of the embryo will account for Wintrebert's results. The burden of proof in this question rests entirely upon those who claim the presence of a conducting mechanism other than those whose existence is already clearly established.

There is such a close parallelism between the normal and cordless embryos that we are fully justified in attributing the first movements of normal individuals to the same cause as that which produces responses in the operated embryos, i.e., the direct irritability of the muscle tissue. When stimulated mechanically or electrically, the operated embryos respond by a single quick contraction toward the side stimulated, the point of stimulation being the center of contraction. The parts of the animal anterior and posterior to the parts stimulated do not enter into the response. In stimulating normal embryos at a very early age to separate those which responded from those which did not, it was quite noticeable that the former always contracted on the side stimulated. A sharp needle was used and the stimulation was given directly to the myotomes, as it was in the cordless embryos which were mechanically stimulated. In this stage normal embryos have in the Rohon-Beard nerves a fairly well developed sensory system, but it is doubtful whether the central connections with the motor apparatus are established. At a somewhat later stage a considerable number of fiber tracts are developed in the cord and then the embryos respond to the lightest touch in the manner described by Harrison and Coghill. Coghill used a human hair with which to stimulate, but this would have no effect unless the sensory system were developed, and there must be a complete sensory-motor arc to produce a contraction on the opposite side of the body from the one stimulated. A simple contraction toward the side stimulated, involving an

extremely small area, indicates that the stimulation was limited to one or two myotomes and was given directly. That the irritability of the operated embryos to direct mechanical stimulation should cease after a period of active response is extremely perplexing, because its irritability to electrical stimuli persists considerably longer and, as is well known, adult muscle responds to direct mechanical stimulation.

The results of the study of the heart action in embryos deprived of all nervous tissue give very clear cut evidence in favor of the myogenic theory of the heart beat. The two principal theories of the nature of the heart beat, from myogenic or neurogenic causes, have each many strong arguments in their favor. To prove conclusively that the myogenic theory is the correct one, three things are necessary. (1) It must be shown that undifferentiated cardiac muscle possesses the ability to pulsate rhythmically before the nervous system establishes connections with it. It must be proved (2) that cardiac muscle when differentiated will continue to contract rhythmically without ever having been connected with the nervous system and (3) that a heart which has so developed will act physiologically in the same manner as a normally developed heart of equal age.

The first requirement for a conclusive proof of the myogenic theory has been clearly demonstrated already. It has long been known that the embryonic heart will beat before it is connected with the nervous system. Fano ('85) found the beating heart in the chick on the second day of incubation. Chandler ('08)² found the heart beating in chick embryos of 11 somites and Lillie ('08) mentions the occurrence of the heart beat in chicks of 10 somites. Paton ('07) has described the heart beat in *Pristiurus* embryos of 4 mm. length. In all these instances, the occurrence of the heart beat has preceded connection of the heart with the central nervous system, though Paton believes that there is a pro-

²Perley B. Chandler, 1908, "A study of the neurofibrillae of the central nervous system." Thesis presented for the degree of M. D. in the Department of Medicine of Yale University. Dr. Chandler was killed in a railway accident shortly after graduation and his thesis was never prepared for publication. I am indebted to the Medical Department for the use of his paper.

toplasmic conducting path for impulses to it. Further, as Shaper ('98) says: "We know that the anlage of the heart has a period of rhythmic pulsation before there can be any specific differentiation of nervous substance." It seems evident, then, that undifferentiated cardiac muscle possesses the ability to pulsate rhythmically before the nervous system establishes connections with it.

The second requirement for a proof of the myogenic theory is, I think, adequately met by the experiments detailed in this paper. My results are fully in accord with those of many other investigators, but the method used here gives a much more rigorous proof than has heretofore been offered. The destruction of the nervous system by chemical or physical means or by trusting to the atrophy of the remainder after the removal of a part is not as sure of producing unquestionable results as careful total removal of the nervous system at an early stage by surgical means. Wintrebert ('05) notes the fact that he found the heart beating in embryos of *Rana viridis* after the total removal of the nervous system. Vernoni ('10) finds that the heart of the chick will continue to beat for several days after the nervous system has been destroyed by exposure to radium at a very early age. Finally, Burrows ('11) has succeeded in totally isolating the living heart from chick embryos into plasma clots and finds that they will beat rhythmically for three days. It is evident from the experiments that not only will the embryonic heart of the frog begin to beat without the influence of the nervous system, but will continue to beat till conditions entirely extraneous to the heart, such as difficulty in aërating the blood and inability to feed, kill the organism. During this period the tissue of the heart is normally differentiating, and the heart as a whole is passing through its normal development. It is, then, evident that cardiac muscle when differentiated will continue to beat rhythmically without ever having been connected with the nervous system.

The third point necessary for complete demonstration, viz.: That a heart which has so developed will act physiologically in exactly the same manner as a normally developed heart of equal age, has not as yet been proved. Indeed, it is so difficult of proof in the case of animals like the frog, owing to the extremely small

size of the embryonic heart, that it is a question whether it can ever be adequately demonstrated. Until such time as this point is proved, we must content ourselves with evidence derived from the adult heart under conditions such that nervous control is eliminated. The first two points may be considered proved, the third can only be said to be probably true.

The results of the experiments detailed in this paper, together with the work of Harrison, Braus and Paton, present certain differences in the various kinds of muscle tissues. All muscles, cardiac, axial and appendicular, differentiate independently of nervous control, but in their ability to function there is a graded difference. Cardiac muscle, which we have reason to believe is the most primitive, will function spontaneously and rhythmically without nervous control. The axial muscles of the frog, on the other hand, will not function spontaneously in the absence of the nervous system, though they will respond to direct stimulation. In appendicular muscle, however, the muscle fibers are still more dependent on the nervous system and do not respond to stimulation till late in their development. The work of Braus ('05) demonstrates conclusively that normal and transplanted limbs of *Bombinator* have a complete nervous supply to the muscles before they move spontaneously. He found that he could obtain no contraction on stimulation with a faradic current until spontaneous contraction had begun to appear, and unipolar stimulation of the limbs in very early stages gave no results. It is interesting to note that Paton has shown that the axial muscles of *Pristiurus* function spontaneously, before the development of nerves, in a rhythmic manner similar to that of heart muscle. It may very well be that the limb muscles of this form present a condition similar to that of the axial muscles of the frog. The discovery of this point and the determination of the period of the transition in both axial and appendicular muscles in the phylogenetic scale would greatly broaden our knowledge of muscular development and functioning power.

In conclusion, it is a pleasure to acknowledge my very great indebtedness to Dr. R. G. Harrison for suggesting this problem and for his invaluable aid as the work progressed.

SUMMARY

1. In normal frog embryos, the differentiation of muscle fibrillae and the establishment of nervous connection with the central nervous system precede, though but slightly, the acquisition of contractility in the myotomes.

2. Voluntary muscle, which has developed without nervous influence, will not contract spontaneously but will respond to mechanical stimuli directly applied and to electrical stimuli. Irritability to electrical stimuli persists considerably longer than irritability to mechanical.

3. There is no evidence that stimuli may be transmitted along non-nervous structures, such as the skin and yolk, though tension of the skin and shaking the embryo may produce responses by bringing about direct mechanical stimulation of the myotomes. The contraction of one myotome may, however, mechanically stimulate others near it within very close limits.

4. The heart will function normally in the total absence of the nervous system and its tissue will differentiate normally. The differentiation of cardiac muscle, like that of voluntary muscle, is slower than in normal individuals, corresponding to the retarded development of the body as a whole, but the fibrillation is absolutely normal. The differences between normal and operated individuals are those of degree, not of kind.

5. From the morphogenetic standpoint, the complete removal of the nervous system has little effect on the heart. The abnormalities which do appear after the operations described are directly traceable to functional disturbances of which the general oedematous condition of the body is an index. This condition is caused by the difficulty in properly oxygenating the tissues owing to a disturbed arterial supply and the absence of external gills, for which the operative technic is entirely responsible.

BIBLIOGRAPHY

- BORN, G. 1896 Über Verwachsungsversuche mit Amphibienlarven. Arch. f. Ent.-mech. Bd. 14.
- BRAUS, H. 1905 Experimentelle Beiträge zur Frage nach der Entwicklung peripherer Nerven. Anat. Anz. Bd. 26.
- BURROWS, M. T. 1911 The growth of tissues of the chick embryo outside the animal body, with special reference to the nervous system. Jour. Exp. Zool., vol. 10.
- COGHILL, C. E. 1909 The reaction to tactile stimuli and the development of the swimming movement in embryos of *Diemyctylus torsus*, Escholtz. Jour. Comp. Neur., vol. 19.
- FANO, GIULIO 1885 Sullo Sviluppo della funzione cardiaca nell'embrione. Lo sperimentale.
- FISCHER, MARTIN 1910 Oedema. Wiley and Sons, New York.
- GOLDSTEIN, KURT 1904 Kritische und experimentelle Beiträge zur Frage nach dem Einfluss des Centralnervensystems auf die embryonale Entwicklung und die Regeneration. Arch. f. Ent.-mech., Bd. 18.
- HARRISON, ROSS G. 1903 On the differentiation of muscular tissue when removed from the influence of the nervous system. Am. Jour. Anat., vol. 2.
1904 An experimental study of the relation of the nervous system to the developing musculature in the embryo of the frog. Am. Jour. Anat., vol. 3.
- HELD, HANS 1909 Die Entwicklung des Nervengewebes bei den Wirbeltieren. Leipzig.
- HOOKE, DAVENPORT 1910 The development and function of cardiac muscle in embryos without nerves. Proc. Soc. Exp. Biol. and Med., vol. 7.
- KREHL, LUDOLPH 1907 The principles of clinical pathology. Trans. by A. W. Hewlett.
- KUNTZ, ALBERT 1909 The rôle of the vagi in the development of the sympathetic system. Anat. Anz. Bd. 35.
- LILLIE, F. R. 1908 Development of the chick. New York.
- PATON, STEWART 1907 The reaction of the vertebrate embryo to stimulation and the associated changes in the nervous system. Naples Mitth., Bd. 18.
- SHAPER, A. 1898a Experimental studies on the influence of the central nervous system upon the development of the embryo. J. Bost. Soc. Med. Sciences.
1898b Experimentelle Studien an Amphibienlarven. Arch. f. Ent.-mech., Bd. 6.
- VERNONI, GUIDO 1910 Studi di Embryologia sperimentale. L'azione del radio sull'uovo di pollo. Arch. f. Entmech. Bd. 31.

- WINTREBERT, M. P. 1903 Influence du système nerveux sur l'ontogenèse des membres. C. R. Acad. Sci., Paris. Tome 137.
- 1904 Sur l'existence d'une irritabilité excitomotrice primitive, indépendante des voies nerveuses chez les embryons ciliés des Batraciens. Comptes Rendus de la Soc. de Biol., vol. 57.
- 1905a Sur le développement des larves d'Anoures après ablation nerveuse totale. Ibid., vol. 58.
- 1905b Sur le développement de la contractilité musculaire dans les myotomes encore dépourvus de liason nerveuse réflexe. Ibid., vol. 59.
- 1905c Nouvelles recherches sur la sensibilité primitive des Batraciens. Ibid., vol. 59.

STUDIES ON THE DYNAMICS OF MORPHOGENESIS
AND INHERITANCE IN EXPERIMENTAL
REPRODUCTION

II. PHYSIOLOGICAL DOMINANCE OF ANTERIOR OVER POSTERIOR
REGIONS IN THE REGULATION OF PLANARIA DOROTOCEPHALA

C. M. CHILD

From the Hull Zoölogical Laboratory, University of Chicago

TWENTY-ONE FIGURES

CONTENTS

Introduction.....	187
Experimental data.....	189
1. Regional differences in head formation along the axis.....	189
2. Regional differences in the position of the pharynx.....	192
3. The later course of regulation.....	192
4. The dominance of anterior regions in the regulatory development of pharynx and intestine.....	194
5. The position of the pharynx under experimental conditions.....	198
A. In pieces from the old postpharyngeal region.....	198
B. In pieces from the old prepharyngeal region.....	204
Conclusion and summary.....	210
Bibliography.....	220

INTRODUCTION

It has long been recognized by the botanists that the apical region is physiologically dominant over other regions to a greater or less extent in higher plants. In *Tubularia* (Child, '07) and various—perhaps all other—hydroids the hydranth region is dominant over more proximal regions so far as they are not beyond the limit of effectiveness for the given conditions. In the present and following papers data will be presented which establish, I think, beyond a doubt that in *Planaria dorotocephala* a relation

of the same sort exists between anterior and posterior regions. The head region dominates and controls all regions posterior to it, though the degree of this dominance differs at different levels and under different conditions.

It is primarily the processes in the anterior region of the body which determine the localization and differentiation of more posterior parts and the formation of a second zöoid and often of additional zöoids at the posterior end of the body is due to the fact that the correlative factors originating in the anterior region are effective only within a certain distance, the effective distance, i.e., they lose in energy or effectiveness with transmission from the point of origin, so that if increase in length beyond a certain point occurs certain regions become in greater or less degree physiologically isolated from the dominant region and begin to react in much the same way as when physically isolated.

In short, we shall find that if a head is formed in regulation, the development of other organs follows necessarily, so far as nutritive material is available. On the other hand, the regulatory formation of a head in *Planaria* is not due to any 'inherent tendency' of any sort whatever of the piece to form a new whole. So far is this from being the case that we find that new heads form more frequently in pieces from old than in pieces from young animals and under certain conditions we can even increase the capacity of a piece to produce a new head by decreasing the rate of dynamic processes in it by means of alcohol and various other anesthetics, by low temperature and by various other means. The data to be presented in this and following papers will show that the formation of a new head in an isolated piece of *Planaria* is to a certain extent opposed to rather than correlated with other activities of the piece.

When once the process of head formation is well under way then the remodelling and redifferentiation of the other parts into a new whole begins. In general no piece of *Planaria* is able to give rise to structures characteristic of regions of the body anterior to that which it originally occupied, *unless a new head region forms or begins to form first*. The new whole arises from the piece in such cases not by a process of 'restitution' of the missing parts,

but in a manner rather closely comparable to the formation of a new bud and a new axis from a region of differentiated tissue in a plant. We may say that in general the conditions which favor the regulatory development of a dominant part are opposed in character to those which favor the development of subordinate parts. Under certain conditions weakness or depression of the old system constitutes one of the most favorable factors for the development of a new dominant part, while vigor, i.e., a high rate or intensity of reaction favors the formation of subordinate parts. In other words, physiological isolation (Child, '11a) is the essential factor in the formation of a new dominant part, while the formation of subordinate parts is determined by correlation. That correlative factors are not entirely without influence in the formation of dominant parts is shown by the fact that the frequency of head formation in *Planaria* varies with the length of the piece (Child, '11b), but it is also a fact that short pieces of *Planaria* from any region will give rise to heads alone, provided only that the rate of reaction is sufficiently high. In the same way isolated short pieces of *Tubularia* and *Corymorpha* stems give rise to hydranths alone or even to only the distal portions of hydranths. Manifestly then the dominant part is capable of forming without any correlation with other parts, though correlative factors may increase or decrease the rate of its formation.

The data obtained in the course of my experiments which bear upon this problem are in part morphological in part physiological: the presentation of the morphological data precedes that of the physiological because the former concern visible features of the processes of regulation while the latter afford a physiological basis for their interpretation.

EXPERIMENTAL DATA

1. Regional differences in head formation along the axis

These regional differences were discussed at some length in the preceding paper and need be only briefly referred to here. If we compare pieces of the same length and within certain limits of length in sequence from the anterior end posteriorly, we find first

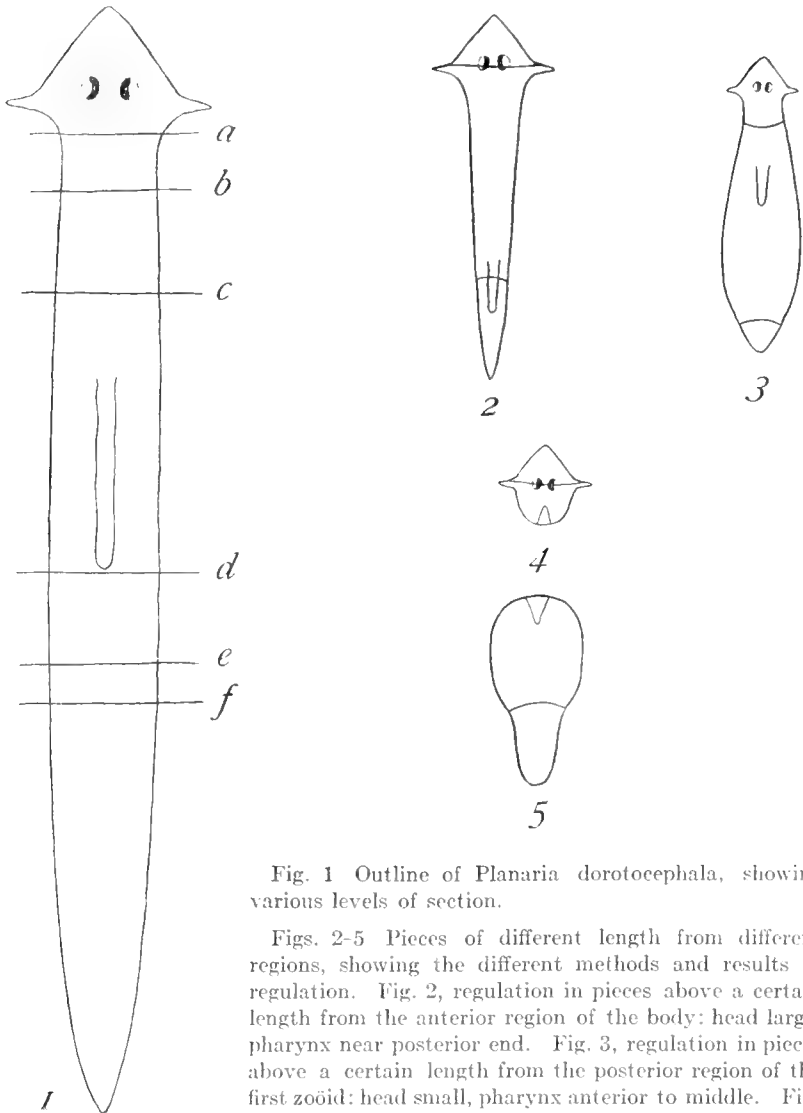

Fig. 1 Outline of *Planaria dorotocephala*, showing various levels of section.

Figs. 2-5 Pieces of different length from different regions, showing the different methods and results of regulation. Fig. 2, regulation in pieces above a certain length from the anterior region of the body: head large, pharynx near posterior end. Fig. 3, regulation in pieces above a certain length from the posterior region of the first zooid: head small, pharynx anterior to middle. Fig. 4, one type of regulation in very short pieces from the anterior region; a 'tailless head.' Fig. 5, usual type of regulation in short pieces from posterior region of first zooid; 'headless.'

that the rate of head formation and the size of the head formed decrease with increasing distance of the level concerned from the anterior end. Fig. 2, an anterior piece including the region *ac*, fig. 1, and fig. 3, a piece from the posterior region of the first zöid (*df*, fig. 1) illustrate the extreme terms of these differences. But these regional differences, which in longer pieces are merely quantitative become in the shorter pieces qualitative, i.e., in the morphological sense, and we often find very short pieces from the extreme anterior end giving rise to tailless heads (fig. 4), while short pieces from the extreme posterior end of the first zöid, developing under the same conditions as the others, may give rise to completely headless forms (fig. 5).

In addition to these differences which concern the head as a whole, we find that teratophthalmic¹ (Child, '11b) and teratomorphic heads (Child, '11d) show a similar relation to the main axis: not merely the capacity to form a head but the capacity to form a 'normal' head decreases posteriorly when pieces are compared under uniform conditions. These and other data cited in the pre-

¹In my earlier experiments I distinguished only three types of anterior regulation in the reconstituted pieces: 'normal,' with two equal eyes symmetrically placed; 'teratophthalmic,' with unequal, unsymmetrically placed, partially fused or single eyes; 'headless,' including all cases without eyes and auricles whether a distinct outgrowth was present or not. In the preceding paper (Child, '11b), which was almost wholly concerned with my earlier work, only these three types of anterior regulation were distinguished. As my work went on, however, it became evident that different kinds of teratophthalmic heads occurred and that many of the pieces which failed to form eyes and auricles were nevertheless not strictly speaking headless. I found it particularly desirable to distinguish those cases in which only the eyes were abnormal from those in which the form of the head was also abnormal. The term 'teratophthalmic' was therefore used for the former type and the term 'teratomorphic' for those cases in which the anterior median region of the head was reduced in size or failed to develop so that the auricles were brought close together or fused on the front of the head. Similarly the cases where eyes did not appear were grouped under two heads, the 'anophthalmic' pieces in which a distinct outgrowth of new tissue developed at the anterior end, and 'headless' in which the growth of new tissue was limited to closure of the wound. For most purposes this grouping of the results is sufficient, but in certain cases where a more extended analysis of the conditions determining the formation of eyes is the object in view the teratophthalmic type must be still further subdivided.

In a recent summary of certain parts of my work (Child, '11d) the five types mentioned above are described and figured.

ceding paper constitute the basis for the conclusion that a dynamic gradient of some sort exists along the chief axis of the planarian body.

2. Regional differences in the position of the pharynx

The pharynx serves as a visible landmark for a region of the body which possesses certain functional characteristics. In the contraction and extension of the planarian body the prepharyngeal and postpharyngeal regions behave differently. In the former contraction occurs in such a manner that the intestinal contents are in general forced posteriorly, while in the latter the intestinal contents move anteriorly as contraction occurs. In extension the contents move in the reverse directions in the two regions. In other words, the pharynx appears at the posterior end of a characteristic region, the prepharyngeal region. The longer this region, the farther from the head does the pharynx appear and vice versa.

When we compare pieces of the same length from different regions of the body, we find that the prepharyngeal region is longest and the new pharynx farthest from the head in the most anterior pieces (fig. 2) and that the length of the prepharyngeal region decreases and the pharynx becomes more anterior in successive pieces from the anterior regions of the body backward (fig. 3). In general then, there is a very definite relation between the rate of head formation, the length of the prepharyngeal region and the position of the pharynx; the greater the rate of head formation the longer the prepharyngeal region and the more posterior the pharynx and vice versa.

3. The later course of regulation

It has commonly been stated that pieces of *Planaria* gradually acquire in the course of regulation the proportions of the original animal. Such a statement can be accepted as true only in a very general sense. For example, the proportions of young small worms are different in various ways from those of old large animals. In general, the shorter the piece the more closely do its proportions after regulation approach those of the young animal and vice versa.

But the point of chief importance in the present connection is that the change in proportions which occurs during the later stages of regulation is a very different process in pieces from the old prepharyngeal region from that in pieces from the old postpharyngeal region. Under anything approaching natural conditions the change in proportions in the postpharyngeal piece is rapid (figs. 10 and 11). The head increases in size rapidly after its first appearance and the pharynx seems to migrate posteriorly because of the elongation of the new prepharyngeal region at the expense of the postpharyngeal region. Sooner or later the animal cannot be distinguished from a normal worm of medium size. Changes of this character occur in pieces from the postpharyngeal region whether food is given or not, but in the presence of agents which decrease the rate of metabolism and consequently the rate of formation of the head the changes in proportions are also retarded and in extreme cases are limited to the newly formed prepharyngeal region of the piece (figs. 13, 18).

In pieces from the old prepharyngeal region on the other hand, whether they retain the old head or develop a new one, we find that the short new postpharyngeal region (fig. 2) grows very slowly when no food is given. If such pieces are not fed, we usually find, that even after months the head is disproportionately large and the prepharyngeal region disproportionately long.

Briefly stated then the facts are these: a new prepharyngeal region formed in pieces arising from the old postpharyngeal region attains full size even in starving animals, but a new postpharyngeal region formed in pieces from the old prepharyngeal region remains indefinitely of relatively small size unless an excess of nutritive material is present.

These facts seem to me to indicate that in growth as well as in localization and differentiation the prepharyngeal region is dominant over the postpharyngeal. If we carry the experiments of this character farther and compare different parts of the prepharyngeal region with respect to the degree of their dominance over more posterior regions, we shall find that the more anterior prepharyngeal regions are more completely dominant than others over newly formed postpharyngeal regions. In other words, the

growth of the new postpharyngeal region at the expense of the old prepharyngeal region proceeds more slowly and ceases at an earlier stage in pieces from the most anterior region than in pieces farther from the old head.

My observations upon these points include hundreds of pieces and a large number of measurements. I have not attempted to give the data in full because I believe that all who are familiar with the course of regulation in *Planaria* and related forms will be able to confirm my statements. Morgan observed this relation between prepharyngeal and postpharyngeal regions in his earlier work on *Planaria* (Morgan, '00, pp. 62-3) but merely recorded the fact without attempting to interpret it or to connect it with other facts.

4. The dominance of anterior regions in the regulatory development of pharynx and intestine

The facts to be considered under this head are briefly these: pieces from the postpharyngeal region of the first zœoid of *Planaria* never develop a new pharynx or prepharyngeal region except in cases where some approach to the formation of a head occurs at the anterior end. On the other hand, pieces containing any part of the original pharyngeal or prepharyngeal region always develop a new pharynx—or retain the old—whether a head develops or not.

All who have worked with *Planaria* are familiar with the fact that under the usual conditions of experiment in all pieces where regeneration of a head occurs a pharynx also develops except in cases where the piece retains the old pharynx, or when it is so small that it produces a 'tailless head.' The differences in such pieces as regards rate of development of the head and the length of the prepharyngeal region have been noted above.

But the pieces which fail to produce a head differ widely in their ability to produce a pharynx. During 1905 I made an extensive study of short pieces in which large individuals were cut into from ten to twenty-four pieces, a record being kept of the approximate region of the body from which each piece came and

of the history of each individual piece. These experiments established the fact considered briefly in the preceding paper (Child, '11b), viz., that the capacity for forming a new head depends to some extent upon the length of the piece and that this factor in head formation becomes increasingly important with increasing distance of the pieces from the anterior end of the original worm back to the region of fission. In addition to this evidence for the existence of an axial gradient of some sort, the experiments established the important fact the pieces which fail to produce a head do not produce any regions of the body anterior to their original level. My records show that in every case where pieces from the prepharyngeal or pharyngeal region remain headless they nevertheless develop a new pharynx, or the old pharynx remains: even pieces which include at the anterior end only the old mouth and a very small part of the pharyngeal region such, for example, as *ac*, fig. 6, are capable of developing a new pharynx whether a head develops or not. But pieces from a region slightly farther posterior than this which includes no part of the pharyngeal region (*bd*, fig. 6) *never produce a new pharynx when they remain headless*. If, however, some slight approach to head formation occurs a new pharynx always appears in such pieces. Further experiments in later years confirmed these results. My earlier records concerning this point include some fifty pieces.

During the present year I prepared a series of pieces for a further test concerning this point. Well-fed worms 15 to 18 mm. in length were used and from these pieces like *bd*, fig. 6, were cut, 50 such pieces being prepared. The results are given in percentages in the following table:

	NORMAL	TERATOPHTHALMIC	TERATOMORPHIC	ANOPHTHALMIC	HEADLESS
With pharynx.....	4	8	10	26	0
Without pharynx.	0	0	0	6	46
	4	8	10	32	46

The table shows that all of the normal, teratophthalmic and teratomorphic pieces developed new pharynges. Of the 50 pieces

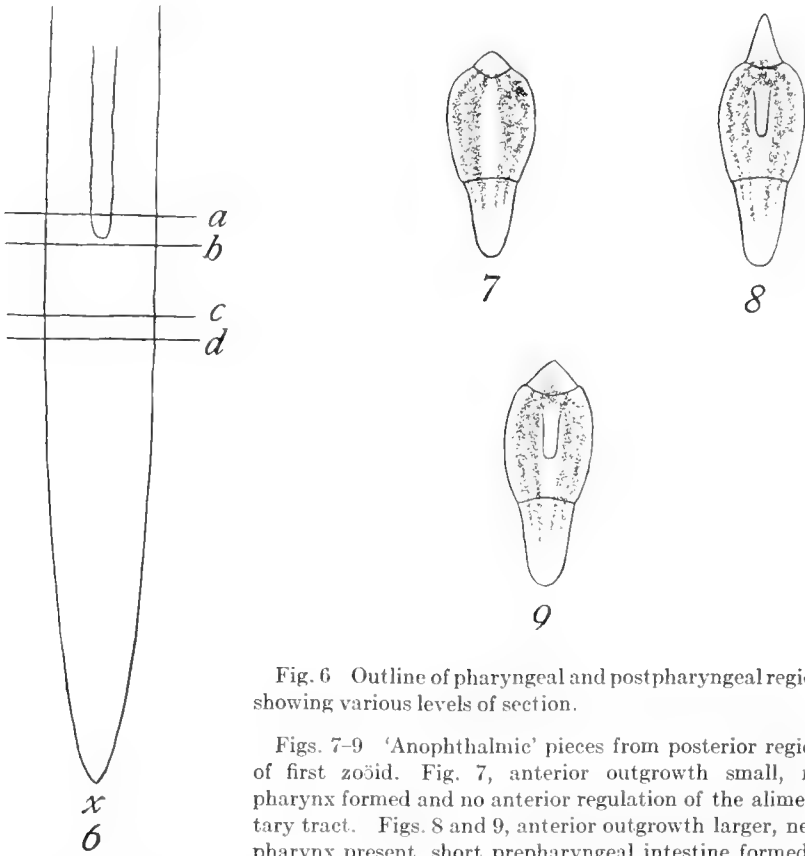

Fig. 6 Outline of pharyngeal and postpharyngeal region showing various levels of section.

Figs. 7-9 'Anophthalmic' pieces from posterior region of first zoïd. Fig. 7, anterior outgrowth small, no pharynx formed and no anterior regulation of the alimentary tract. Figs. 8 and 9, anterior outgrowth larger, new pharynx present, short prepharyngeal intestine formed.

16, 32 per cent, are anophthalmic, i.e., they show some outgrowth at the anterior end but do not develop eyes. The amount of the anterior outgrowth differs widely in different pieces. Of these anophthalmic pieces 13, 26 per cent of the whole series and more than three-fourths of this type, developed new pharynges, while only 3 pieces, 6 per cent, remained without pharynges. Moreover, my records show that in every case where a pharynx failed to develop in these anophthalmic pieces the anterior outgrowth was small like that in fig. 7 or even smaller, while in all but two cases where a pharynx was formed the outgrowth was visibly greater and of the types shown in figs. 8 and 9. In short it was

evident from examination of the pieces that in general those which developed pharynges were less completely headless than those which did not.

The regulatory changes in the intestine run parallel with the other changes: in those cases where a new pharynx is formed a short median prepharyngeal intestinal axis is formed, while in those pieces which do not give rise to a pharynx no appreciable regulatory changes in the intestinal tract occur. Figs. 8 and 9 show the intestinal structure in pieces which develop a pharynx and fig. 7 that in pieces without a pharynx. It is sufficiently clear that the development of a pharynx is associated with the presence or new formation of a prepharyngeal region.

The strictly headless pieces of the series, twenty-three in number, 46 per cent of the whole series, did not in a single case give rise to a new pharynx. The alimentary tract in these pieces is essentially similar to that in fig. 7. It should perhaps be added that in the examination to determine the presence or absence of a pharynx each piece, after it had been kept long enough for regulation to proceed as far as it would go—twenty days at 20° C.—was subjected to compression under the microscope. By this means it is possible to detect the pharynx even when it is very minute and otherwise quite invisible. My records also include hundreds of headless pieces from the pharyngeal and prepharyngeal regions and in no single case among them where the old pharynx was not retained has a pharynx failed to develop.

These facts seem to me to be of great importance in connection with the question of dominance of anterior over posterior regions. They show that where a part of the pharyngeal or prepharyngeal region is present a new pharynx develops whether a head forms or not, while in the postpharyngeal region of the first zoöid no new pharynx appears unless at least a start toward head formation occurs. Evidently the process of head formation determines at a very early stage the localization of a new prepharyngeal and so of a pharyngeal region. In short a new pharynx appears in an isolated piece only when some part of the original pharyngeal or prepharyngeal region is included in the piece or is formed anew in the course of regulation. And furthermore, the formation of a

new prepharyngeal and pharyngeal region is dependent on the formation of a head or something which approaches a head in physiological character. Discussion of the question as to the nature of this capacity of the head region to determine the development of other regions and of the capacity of regions at any level to determine regions posterior to them, in short, the question as to the nature of antero-posterior physiological dominance, requires the consideration of other data of different character from those presented here and must therefore be postponed.

5. *The position of the pharynx under experimental conditions*

A. *In pieces from the old postpharyngeal region.* The relation described above between the region of the body from which the piece is taken, the size and rate of development of the head and the position of the pharynx is by no means fixed in character, and can be altered very readily by a great variety of experimental conditions.

In describing a few experiments of this character we may consider first pieces from the original postpharyngeal region: in such pieces the process of regulation involves the formation of a prepharyngeal and pharyngeal region from the anterior part of the old postpharyngeal region. In such pieces we can alter the size and rate of development of the head, the length of the prepharyngeal region and the position of the pharynx almost at will.

For experimental purposes pieces including the whole postpharyngeal region (*bx*, fig. 6) afford the most striking results, though shorter pieces from the posterior region of the first zoöid may be used. As a basis for comparison I have used in my experiments the postpharyngeal regions isolated from worms 15 to 18 mm. in length which have been sufficiently well fed to keep them from either decreasing or increasing in size to any marked extent. Regulation of these control pieces occurred at a temperature of about 20° C. in water containing an excess of oxygen for the requirements of the animals. The results from such pieces are uniform in high degree. The pieces produce a large head with normal eyes and the pharynx appears at about

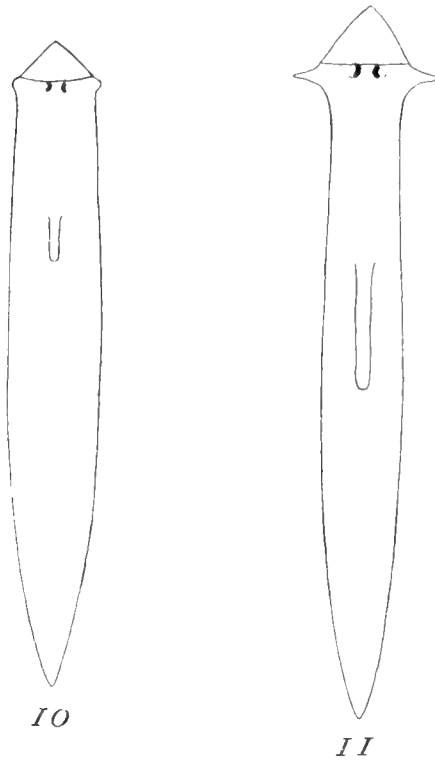

Figs. 10 and 11 Postpharyngeal pieces showing regulation in water at temperature of 20° C. Fig. 10, early, fig. 11, later stage.

one-third of the length of the piece from the anterior end. Fig. 10 shows an earlier, fig. 11 a later stage in the regulation of such a piece. The only appreciable variation from this result which I have observed, when material and conditions are as above stated, is the very rare occurrence of partly fused eye spots. In ten series of 50 pieces each, a total of 500, 497 pieces were essentially similar to fig. 11, while 3 pieces (0.6 per cent) differed only in possessing partly fused eye spots. It is evident from these data that these pieces under constant conditions give a very definite characteristic result.

Similar pieces from worms in similar condition which undergo regulation in alcohol or ether or other anesthetics at the same

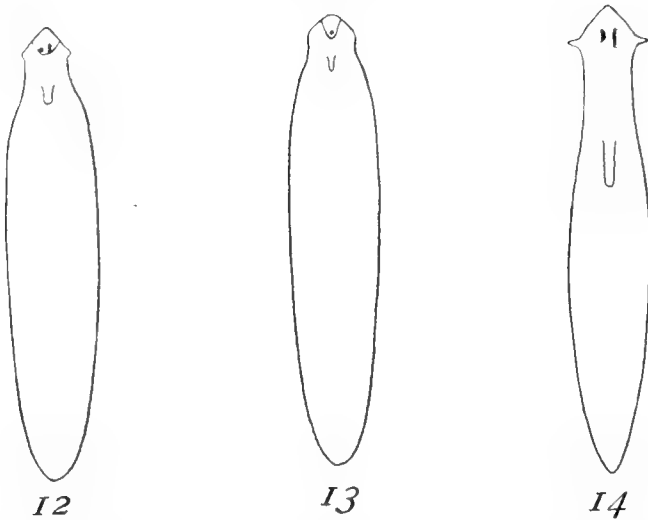

Figs. 12-14 Postpharyngeal pieces showing relation between regulation and external conditions. Figs. 12 and 13, regulation in alcohol 1.5 after twelve days. Fig. 14 shows the changes in these pieces after return to water.

temperature as the controls give strikingly different results. My records include more than a hundred such pieces and show uniformly that the head is always smaller, develops more slowly than in the controls, and is very commonly teratophthalmic and often teratomorphic: in most cases also redifferentiation plays a larger part in the formation of the head than in the controls. The pharynx is also small and *is always much nearer the anterior end* than in the controls. Figs. 12 and 13 show two characteristic pieces after twelve days in 1.5 per cent alcohol. In fig. 12 the head is more nearly normal and a small pharynx is present: in fig. 13 the head is almost entirely the result of redifferentiation and possesses only a single eye in the median line and the pharynx is even smaller and nearer the anterior end than in fig. 12. It should also be noted that the changes in proportion in these pieces extend posteriorly only a short distance from the head. If these pieces are kept in alcohol they remain in approximately the condition figured until death. If, however, they are returned to water the development of the head proceeds, it becomes larger, the

prepharyngeal region becomes longer and the elongation and decrease in width gradually extend posteriorly (fig. 14).

The intestinal regulation in these pieces occurs only in the region anterior to the pharynx, whether this region is long or short. In cases like figs. 12 and 13, for example, we find a prepharyngeal median axial intestine in the short prepharyngeal region and with the elongation of this region after the return to water (fig. 14) the prepharyngeal axial intestine also elongates. The pharynx is then an excellent morphological and physiological landmark.

Pieces which regulate in ether give very similar results. A series of postpharyngeal pieces after eighteen days in five-tenths per cent ether showed forms ranging from the type of fig. 12 to that of fig. 15. In the extreme type of fig. 15 anterior regeneration is limited to the extreme tip of the head region, other parts of the head being the result of redifferentiation. No auricles are visible, only a single eye is present, there is no elongation and change in proportions and no pharynx is present. In such pieces no intestinal regulation occurs and no prepharyngeal axial intestine is formed from the union of the lateral postpharyngeal branches in the anterior region of the piece. When a pharynx appears the prepharyngeal axial intestine is always present, though it may be short. In cases like fig. 15 it is evident that practically all regulation except the redifferentiation of the head region has been inhibited by the ether. The fact that this can go on under conditions which stop all other regulatory processes is itself suggestive. Its bearing will be discussed later.

If such pieces are returned to water extensive changes occur. During the first four or five days the head region enlarges and a pharynx appears near the anterior end of the piece (fig. 16), but the prepharyngeal region soon begins to elongate and becomes more slender as the activity of the head increases. After eight days in water the pieces resemble fig. 17. The postpharyngeal region is not yet under complete control and drags along behind the rest of the worm like a dead mass, except when the animal is very strongly stimulated. The prepharyngeal region, on the other hand, resembles that of the pieces in water. Incidentally it may be noted that when the piece develops only one median

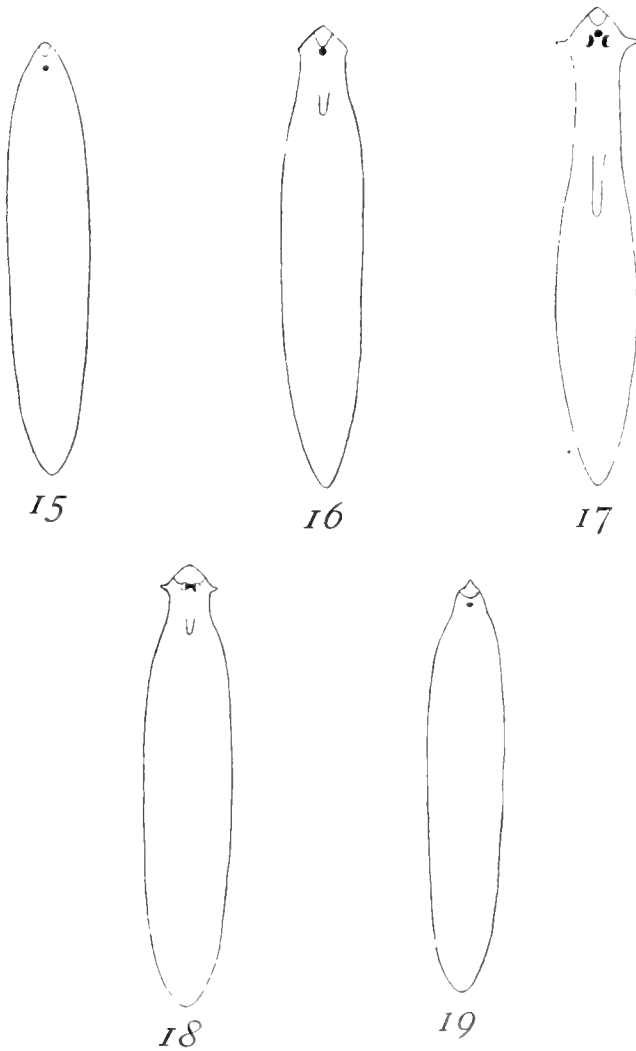

Figs. 15-19 Postpharyngeal pieces showing the effect of ether and metabolic products on regulation. Fig. 15 regulation in ether 0.4%. Fig 16, four days in water after ether. Fig. 17, eight days in water after ether. Figs 18 and 19, regulation in water from planarian cultures.

eye in alcohol or ether it usually develops two more in the normal position (fig. 17) after its return to water.

These cases of regulation in alcohol and ether show very clearly that when the formation of a head at the anterior end of a piece is retarded by external conditions the length of the prepharyngeal region is decreased and the pharynx arises nearer the head: in extreme cases regulation is confined to the head region alone and neither pharynx nor prepharyngeal region appear. On returning these pieces to water we can see that the regulatory changes proceed in the posterior direction.

It is possible to alter the rate of formation and the size of the head and the position of the pharynx by various other means. For example CO₂ and other products of metabolism in the water in which the pieces are kept are very efficient factors in altering the course of regulation. The following series will serve as an example: 50 postpharyngeal pieces (*bx*, fig. 6) were placed in old culture water in which a stock of several hundred worms had been kept for nine days. Since this experiment was merely preliminary, no attempt was made to determine whether the CO₂ or other substances were the more important factors in determining the results: more exact data will appear in a later paper. As a control 50 similar pieces were placed in fresh, well aerated water at the same temperature. The results in percentages, so far as they concern our present purpose, are as follows:

	HEADS	NORMAL EYES	PHARYNGES
In old culture water.....	54	6	48
In fresh water.....	100	100	100

The differences are evident at once. Certain features of the results however are not apparent from the table. In no case did a pharynx appear in a piece which did not form a head and some of the pieces which formed the smallest and most abnormal heads did not produce pharynges at all. In all cases where a head formed it was relatively small and was commonly teratophthalmic or teratomorphic and the pharynx when present was only a short distance posterior to it. Fig. 18 shows a characteristic piece from

this series and fig. 19 a more extreme case with single median eye, teratomorphic head and without a pharynx.

Differences which are similar in character though less extreme may be obtained with different temperatures. At high temperatures postpharyngeal pieces produce large heads with normal eyes and relatively long prepharyngeal regions. At lower temperatures the heads are smaller and more frequently teratophthalmic and the prepharyngeal regions shorter, i.e., the pharynges are further anterior.

As regards still other methods by which similar results may be obtained, further data will be presented at another time.

The important point for present purposes is that in a piece from the original postpharyngeal region *the rate of development and the size of the head, the length of the new prepharyngeal region and consequently the position of the new pharynx all vary with the rate of the dynamic processes concerned with the formation of the new head and can be controlled experimentally.*

B. In pieces from the old prepharyngeal region. Internal conditions are very different in the pieces from the original prepharyngeal region from those existing in the postpharyngeal pieces. In prepharyngeal pieces the greater portion remains prepharyngeal in structure and function and only a short posterior portion becomes postpharyngeal. At the posterior end of the newly determined prepharyngeal region the new pharynx appears (fig. 20). Here then a prepharyngeal region exists from the beginning and it is merely a question as to how much of it shall become postpharyngeal.

A superficial consideration of this case might perhaps lead us to expect from analogy with postpharyngeal pieces that a decrease in the rate or intensity of the dynamic processes in the head region would result here also in a decrease in length of the new prepharyngeal region or more strictly speaking in the determination of a shorter prepharyngeal region and the consequent localization of the pharynx more anteriorly. This result would occur if the head region alone were dominant over all other regions and these latter coördinate in character. But as a matter of fact each level of the body is dominant in some degree over the levels posterior to it so far as they are within the effective distance.

It was shown in the preceding section that in the pieces from the original prepharyngeal region the formation or presence of a head is not necessary as it is in postpharyngeal pieces for the development of a new pharynx. The presence of any part of the original prepharyngeal or pharyngeal region is sufficient to determine the formation of a new pharynx whether a head forms or not. In such pieces the localization of the new pharynx will depend on the length of the region which undergoes redifferentiation to form the missing posterior regions, for the new pharynx appears on the boundary between the region which retains its original prepharyngeal character and that which becomes postpharyngeal in character. Since the prepharyngeal region is dominant over regions posterior to it, pieces from the prepharyngeal region develop the new pharynx near their posterior ends (fig. 2) and the new postpharyngeal region is formed almost wholly by regeneration and remains short for a long time unless the animal is fed. But when we compare prepharyngeal pieces from different levels we find that as the level of the pieces approaches the level of the old pharynx, i.e., the posterior end of the prepharyngeal region, the degree of dominance of the anterior regions of the piece over its more posterior regions decreases, a fact that will appear more clearly later, and in the course of regulation the new postpharyngeal region becomes longer and the pharynx appears more anteriorly in the piece.

In *P. dorocephala* the degree of dominance of the prepharyngeal over the postpharyngeal region is such that the formation of a new postpharyngeal region in a prepharyngeal piece occurs slowly, is limited to the extreme posterior region of the piece and is almost wholly a process of regeneration in the stricter sense. Consequently in all pieces from the prepharyngeal region the new pharynx arises at or very near the posterior end of the old tissue. As a matter of fact its level does differ somewhat according to the level of the piece. In pieces from the extreme anterior region of the body (*ab*, fig. 1) the new pharynx may appear in the posterior new tissue (fig. 20), i.e., in such cases not only the postpharyngeal region but the pharyngeal region also is the product of regeneration. As the level of the piece becomes more posterior the new

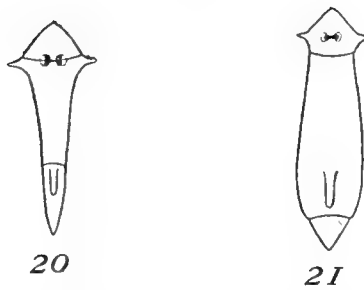

Figs. 20 and 21 pieces from different parts of the prepharyngeal region to show the position of the pharynx. Fig. 20, from the region immediately behind the old head. Fig. 21, from the region just anterior to the old pharynx.

pharynx appears more anteriorly until at a level just anterior to the old pharynx the new pharynx appears in the old tissue somewhat anterior to its posterior end (fig. 21). In *P. maculata* the corresponding differences in the level of the new pharynx are somewhat greater since the axial gradient in this species differs in certain respects, as will appear later, but in both cases the principle involved is the same.

In general these differences in the level at which the new pharynx appears in the prepharyngeal pieces are merely expressions of the different degrees of stability of different prepharyngeal levels. The most anterior levels of the prepharyngeal region are more fixedly prepharyngeal than other levels and a new postpharyngeal and pharyngeal region arise only from their most posterior parts. In fact, if we isolate very short pieces from just behind the old head they give rise in most cases under standard conditions, i.e., when taken from large well fed worms and allowed to regulate in well aerated water at a temperature of 20 C., to 'tailless heads' (fig. 4) in which neither pharyngeal nor postpharyngeal regions are formed, the new tissue at the posterior end of the piece being limited to closure of the wound, while anteriorly such pieces produce large heads. At more posterior levels the pharyngeal and postpharyngeal regions are formed and as the level of the piece in the original body becomes more and more posterior they become larger and the new head becomes smaller.

The question as to why a new postpharyngeal region should arise at all in such a piece was discussed in connection with the analysis of regulation in another form (Child, '05). In that form, *Cestoplana*, almost no regeneration occurs posteriorly and the new postpharyngeal region arises from the old prepharyngeal region by redifferentiation and its length differs at different levels in the same way as in *Planaria*. In my account of regulation in that form I called attention to the fact that the first visible change in the process of formation of a postpharyngeal region from a part of the original prepharyngeal region is not a change in structure but a change in function, in the motor reactions of the part. The visible structural changes follow this functional change and they occur, as I believe, in consequence of the altered dynamic conditions in this region of the piece.

In *Planaria*, however, where the new postpharyngeal region is formed largely or wholly by regeneration conditions are somewhat different and we must consider the question as to why a new postpharyngeal region should arise by regeneration at the posterior end of a prepharyngeal piece.

In the first place a cut surface, a new terminal region, has been formed by the operation and that means that certain characteristic metabolic conditions and functional conditions in the stricter sense must exist or arise in the posterior region of the piece. These result first of all in dedifferentiation, i.e., loss of the old structural characteristics and renewed or accelerated growth of the cells near the wound. In this way a small region of more or less 'embryonic' tissue is formed. The later fate of this tissue depends mainly upon its correlation with parts anterior to it, for if the law of the dominance of anterior over posterior levels holds good in this case, and I shall show later that it does, this region is subordinate to the regions anterior to it and the course of its development is determined chiefly by those more anterior regions. The correlative factors to which this region is subjected are essentially similar to those to which the old postpharyngeal region was subjected and it develops into a postpharyngeal region in consequence of the influence upon it of these factors. The rate of metabolism of the dedifferentiated cells which form the starting

point of regeneration is accelerated by the process of dedifferentiation which is essentially a process of rejuvenescence (Child, '11c) and in consequence of this acceleration of metabolism these cells are able to grow and divide for a time at the expense of the regions anterior to them. This growth continues until in the course of redifferentiation the cells again grow physiologically older and their rate of metabolism decreases to such an extent that they can no longer grow at the expense of more anterior regions and there regeneration ceases unless the piece contains an excess of nutritive material. In short the conditions which determine the regeneration of a postpharyngeal region in a prepharyngeal piece are: first, the dedifferentiation of the cells in reaction to the wound and the resulting increase in capacity for metabolism and growth; second the correlative factors to which they are subjected in consequence of their physiological continuity with more anterior regions and which determine that growth and redifferentiation shall actually occur. In consequence of all these conditions a new postpharyngeal region arises at the posterior end of the prepharyngeal piece, while other parts of the piece remain almost unchanged structurally and functionally. The growth of the postpharyngeal region after its determination as such is then essentially a process of 'functional' growth and the final cessation of growth is the result of an equilibration in the rate of metabolism between the new part and the old.

The occurrence of 'tailless heads' in very short pieces from extreme anterior regions, in other words, the failure of such pieces to form pharyngeal and postpharyngeal regions depends upon the fact which will be demonstrated later that a higher rate of metabolism is concerned in the formation of a head than in that of a posterior part: in these short pieces the posterior regions do not form because the process of head formation with its higher rate of reaction uses up the available material so rapidly and to such an extent that the formation of a posterior end is inhibited or rather prevented. With the aid of proper experimental conditions it is possible to produce tailless heads in longer pieces as well as in pieces from other regions of the body. In *Planaria* the dominant morphogenic reaction, i.e., the morphogenic process

with the highest rate of metabolism is that of head formation, just as in *Tubularia* the dominant morphogenic reaction is that of hydranth formation—moreover, in *Tubularia* the distal hydranth regions are dominant over the proximal—and whenever this dominant reaction begins in a piece the other reactions are controlled by it and if the amount of material available as a source of energy is insufficient the subordinate reactions are decreased or completely inhibited. In short pieces of the *Tubularia* stem, particularly in those from the more distal regions, the product of regulation is more and more exclusively distal in character, the shorter the piece. Similarly in the anterior regions of *Planaria* the product of regulation becomes more and more exclusively anterior as the length of the piece decreases. Certain apparent exceptions to this law, e.g., the formation of headless pieces and biaxial ‘heteromorphic’ tails in *Planaria* and other forms will be considered later and will be shown to be only apparent exceptions.

The origin of a new dominant part like the head from any subordinate part, i.e., any region posterior to the head is a problem of somewhat different nature and one which has not been considered in any of the attempts at analysis of the process of form regulation which have been made, because the dominance of this region has not heretofore been recognized. My experiments have led me to the conclusion that the formation of the head in *Planaria*, the hydranth in *Tubularia*, etc., are in no sense restorations of missing parts, restitutions or anything of that kind, but rather that the new head or the new distal region as the starting point of a new individual arises from the mass of old tissue in a manner closely comparable to the formation of a new bud from differentiated tissue in a plant. The new individual, which is at first merely a head, lives at the expense of the old parts and at the same time makes them over into parts of a new worm or uses the energy which it obtains through their destruction in the development of new parts. The new individual simply forms and grows head first out of the old mass. In *Planaria* the position of the new head commonly shows a definite relation to the old axis, though this is not always the case, but in various coelenterates, e.g., *Corymorpha* (Child, '11a, pp. 112-119) and *Harenaetis*

(Child, '09, '11a) the new axes may arise 'adventitiously.' In other words, if the original axial gradient is sufficiently obliterated or if external conditions are sufficiently powerful to overcome its influence new gradients, i.e., new axes may arise without definite relation to it.

CONCLUSION AND SUMMARY

Although the consideration of the question as to the nature of the dominance of anterior over posterior regions in Planaria must be deferred until further facts have been presented, we may at this time consider briefly the significance of such dominance.

The dominance of one region over another is of course relative rather than absolute. To say that a given region is dominant over others means merely that it influences and determines the processes and conditions in them to a greater extent than it is influenced by them. This, as will appear in later papers of this series, is the case in Planaria.

In the present paper certain of the facts of regulation in Planaria have been presented which indicate that the head region controls and determines the development of regions posterior to it to a very large extent and that each level of the body is to a certain extent dominant over more posterior levels. This, however, is only the first step in the presentation of evidence.

If the head region of Planaria and the distal region of Tubularia and various other forms are dominant over other regions as I have maintained, it follows that these regions develop more independently than any other part of the body. The formation of the head in Planaria, of the distal region in Tubularia, is the most fundamental, the most characteristic morphogenic reaction of the protoplasm of those species. Other reactions depend upon this to a much greater extent than it depends upon them. In general the first morphogenic regulatory change in an isolated mass of planarian or tubularian protoplasm is the formation of a head or a distal region or the initiation of this process. This fact will become more and more apparent as further experimental data are presented. As we know from numerous experiments,

many isolated pieces of the planarian body appear to be incapable of producing heads. In such pieces I have been able to induce head formation experimentally by simply subjecting them to conditions which increase the rate of metabolism (Child, '11d) and can demonstrate that in these pieces the absence of the head under the usual conditions is due, not to absence of the necessary 'organization' or to lack of certain 'formative substances' or anything of that character, but merely to an insufficiently high rate of metabolism in the region concerned. By increasing the rate sufficiently in any way heads appear on pieces which would not otherwise produce them. By altering the conditions in the opposite direction it is also possible to induce the formation of teratophthalmic in place of normal heads or to inhibit head formation completely.

But little attention has been paid to the matter of rate of reaction as a factor in ontogenetic and regulatory morphogenesis. When pieces fail to regenerate certain parts it has usually been taken for granted that the necessary 'organization' is lacking. This, however, is by no means always the case. The formation of a new whole from a piece or the failure to form such a whole, as well as the character of the whole formed, e.g., normal, teratophthalmic and teratomorphic wholes in *Planaria* may be the result of differences which are fundamentally purely quantitative rather than qualitative in nature. Undoubtedly differences in organization do exist and do play a part in many cases, but they are certainly not the only nor the chief factors in many other cases.

In the absence of the head region the most anterior regions present are dominant over more posterior regions within a certain distance and to a certain degree. In general we find that while any region is a very important factor in determining what shall go on in regions posterior to it, it has but little influence, though it can be shown to possess a certain amount, in determining what goes on in regions anterior to it. The morphological characteristics of *Planaria* are determined chiefly by the correlative influence of more anterior upon more posterior regions.

It is evident that this point of view gives a very different conception from that generally held of the process of formation of a

new whole from a piece of a planarian body. Instead of being a process which shows almost infinite possibilities of adjustment to the conditions existing in a particular case, it is essentially one and the same reaction in all cases. In pieces where the head is present the posterior parts arise in consequence of correlation with more anterior parts. Where the head is absent a new head arises from the region involved in reaction to the wound, provided merely that the rate of reaction in this region becomes sufficiently rapid. When the process of head formation attains a certain stage the new head region begins to dominate the rest of the piece and makes it over according to certain definite and unchanging laws. All that is necessary for the formation of a planarian is first a cell or a group of cells capable of initiating a characteristic series of reactions which result in what we call a head and second an excess of nutritive material as a source of energy for growth.

To put the matter in still another form, it is not too much to say that the capacity for head formation is all that exists in the planarian egg, all that is inherited. Given this, together with an excess of nutritive material, which in the case of *Planaria* exists in the yolk cells and the characteristic form of *Planaria* must result.

And this brings us to the question as to how far similar relations obtain in regulatory and the ontogenetic development of other forms. At present I desire only to call attention to certain points in this connection. *Tubularia* and *Corymorpha* are essentially similar to *Planaria* as regards the axial gradient. In the first place it has been shown by various investigators that if a tubularian stem is cut into a series of pieces of equal length the oral hydranth develops most rapidly and is largest in the most distal piece and its size and rate of development decrease with each successive piece from the distal end proximally. These differences are similar in character to the differences in head formation at different levels of the first zoöid in *Planaria*.

Secondly, as regards the dominance of distal over proximal regions *Tubularia* likewise resembles *Planaria*. In asexual reproduction in nature the factor of distance is apparent, i.e., the tip of the stolon gives rise to a new hydranth when it has reached a

certain distance, varying with conditions, from the original distal region and has become to some extent physiologically isolated from the latter (Child, '11a, pp. 95-96, 101-112). When pieces are cut from the stem only vigorous pieces give rise to stolons at their proximal ends (Child, '07) and as the piece becomes less and less vigorous the terminal region of the stolon, or the proximal end of the stem if a stolon was not formed, becomes physiologically isolated from the dominant distal region and gives rise to a hydranth. Axial heteromorphosis in long pieces of the stem is merely the result of physiological isolation of the proximal region of the piece in consequence of increasing weakness, i.e., decreasing rate of metabolism and therefore decrease in length of the stem over which the distal region is dominant (Child, '11a, pp. 101-112).

Furthermore, as the length of the piece cut from the stem of *Tubularia* decreases the parts to which the piece gives rise become more and more exclusively distal: the longer pieces produce hydranths and stems, somewhat shorter produce hydranths alone, still shorter only manubrium and distal tentacles and so on, until finally the shortest pieces give rise only to the distal region of the manubrium with the distal tentacles (Child, '07). These facts demonstrate that the distal region is able to form without correlation with other parts, but the more proximal regions have never been seen to arise except in connection with considerable regions distal to them.

Corymorpha is essentially similar to *Tubularia* in all these respects except that it does not reproduce asexually by transformation of the end of the stolon into a hydranth. This difference is probably due to the fact that the proximal region of the stem of *Corymorpha* is a much more highly specialized region than in *Tubularia*. So far as data are available, the relations seem to be similar in many if not in all other hydroids.

Rand ('11) has recently stated that in *Hydra* the peristome region controls morphogenesis and I have found in *Cerianthus* and *Harenaetis* an axial gradient of the same character as in *Tubularia* and *Planaria* and in these forms also the peristome region appears to be dominant in regulation. The distance factor is more difficult to demonstrate in these actinians since the rate of metabolism

at the proximal end is so low that reproduction does not occur under ordinary conditions even when these regions are physically isolated.

As regards plants, it is a well-known fact that in at least most forms the apical region of the axis is to a very large extent dominant over more proximal regions and I have endeavored to show (Child, '11a) that the factor of distance is in many cases a factor of great importance in reproduction in plants as well as in animals.

These facts as well as many others which might be cited show very clearly that an axial gradient exists in a large number of organisms and that in many cases at least the apical or anterior region is dominant in regulation.

Turning now to normal ontogeny, we find that in most if not in all animals the visible phenomena of development begin in the region of the so-called animal pole of the egg and that this region in most if not in all cases becomes the anterior, distal or apical region of the resulting organism. I believe that these facts in themselves are highly suggestive when taken in connection with the facts concerning the dominance of the distal and anterior regions in the regulation of various forms. In fact it seems probable that dominance of anterior or distal over posterior or proximal regions is a very general law of organic development, not only in animals but in plants as well. A more extended consideration of this question will be undertaken elsewhere.

Critics of such a conclusion will at once cite those cases in which different parts of the developing egg appear to be almost wholly independent of each other, e.g., the annelid and mollusk and the amphibian. It seems at least probable that in such cases the characteristics of the different parts once determined through correlation at a very early stage are stable to a high degree and do not change when the parts are isolated. Even in such cases the 'animal' region of the egg may be dominant over other regions at some stage in the history of the egg. The experiments of recent years on the nemertean egg afford strong evidence in favor of the view that independence of parts in later stages is preceded by a condition in which at least certain parts are determined correlatively. According to this view the eggs which show the extreme

mosaic type of development are merely cases of early differentiation or of absence of regulatory capacity due to one cause or another, rather than a type of constitution fundamentally different from the extreme correlative type.

In regulatory reproduction we find all stages between the two extremes. For example, in *Planaria simplicissima* the first formation of the tail region depends as in *P. dorotocephala* upon connection with more anterior regions, but when it is once formed this region is more definitely determined as a tail region than in *P. dorotocephala* and when isolated often gives rise, as Morgan first observed (Morgan, '04), to a tail at its anterior end. Somewhat similar conditions exist in the earthworm, except that there the 'tail region' includes the greater part of the body length.

In *Stenostomum*, on the other hand, posterior regions remain posterior in structure only so long as they are under the complete control of the dominant head region. When this control decreases below a certain limit, either in consequence of increase in length of the animal or other conditions (Child, '11a) a new head begins to develop in the posterior region of the body, even though organic continuity with the original head region is not interrupted.

It seems probable then that we shall find in ontogenetic as well as in regulatory development that anterior or distal regions are very generally dominant over posterior or proximal regions, at least at some stage, and that the egg as well as the piece capable of regulation represents primarily the anterior or distal region, together with an excess of nutritive material or some means of obtaining such an excess as a source of energy for growth.

The most important facts of the paper and the conclusions to which they point may be summarized as follows:

1. As was shown in the first paper of this series, the most important regional differences in the course of regulation in pieces of *Planaria* taken in sequence along the axis from the anterior end posteriorly consist first, of decrease in the size of the head, the rate of its formation and the frequency of normal eyes; second, of decrease in the length of the prepharyngeal region and therefore the formation of the pharynx at a more anterior level of the piece. These differences indicate the existence of an axial gradient of

some kind and their character suggests that this gradient concerns, at least in part, the rate or intensity of certain processes along the axis.

2. A head or prepharyngeal region is capable of growing or of maintaining itself at the expense of more posterior regions in the absence of other food to a much greater extent than posterior regions can grow or maintain themselves at the expense of more anterior regions. These facts also suggest differences in the rate or intensity of certain processes at different levels.

3. In pieces of *Planaria dorotocephala* which contain a part of the original prepharyngeal or pharyngeal region and in which the old pharynx is not present or does not persist, a new pharynx develops whether a new or old head is present or not. In pieces from the postpharyngeal region, on the other hand, a new pharynx or a new prepharyngeal region never forms unless a head region begins to form first.

In general no piece of the planarian body is capable of giving rise to structures belonging to levels anterior to that which the piece originally occupied in the body, unless the formation of a head or the first stages of this process occur first. But a piece can give rise to parts characteristic of levels posterior to that which it originally occupied, whether a head region is present or not.

4. The formation of a head at the anterior end of a piece may be retarded or inhibited by various agents and conditions, e.g., alcohol, ether and other anesthetics, CO_2 and other products of metabolism, KCN and even by low temperature and insufficient nutrition. In all pieces from the postpharyngeal region of the body in which the formation of a head is thus retarded the length of the new prepharyngeal region is less than in pieces under the usual conditions and the pharynx appears nearer the head. When the depressing agents or conditions are used in higher concentration or intensity so as to produce the more extreme effects, or when the animals are in such physiological condition as to be more sensitive to their effects, the regulatory changes may be limited to the early stages of head formation, all regulatory changes being completely inhibited in regions posterior to the head. The fact that the regulatory processes concerned in head formation are

able to go under conditions which completely inhibit all other morphogenic regulatory processes is of great importance. It constitutes very strong evidence in support of the conclusion that regulation at the anterior end of a piece is initiated by the process of head formation or by the beginning of this process.

In general we find that *in pieces from the original postpharyngeal region the size of the head the length of the new prepharyngeal region and in extreme cases its presence or absence, and consequently the position or presence or absence of the pharynx are all very closely correlated with the rate of the dynamic processes or certain of them which are concerned in head formation.*

5. In pieces from the original prepharyngeal region a new postpharyngeal region develops much more slowly, is much shorter and is to a much larger extent a product of regeneration in the stricter sense than is a new prepharyngeal region developing in a postpharyngeal piece. The new pharynx in pieces from the prepharyngeal region appears near the posterior end of the old tissue. Only when excess of nutrition is present does the new postpharyngeal region grow to the proportions characteristic of animals in nature.

6. The facts point to the conclusion that the regulatory formation and development of the head in *Planaria*, as well as the hydranth in *Tubularia* and the anterior or distal regions of various other forms are not in any sense a restoration of missing parts, a 'restitution' a return to a condition of wholeness or anything of that sort. Such a process consists rather in the formation of a new individual, beginning with the head or distal region: this new individual simply grows out of the mass of old tissue head first and as it grows either uses the old tissue as a source of energy or brings about its redifferentiation until the dynamic equilibrium characteristic of the specific system and the existing conditions is attained. The regulatory changes at the anterior end in such cases begin in the region of the developing head and proceed posteriorly. By means of external factors we can determine the distance from the new head to which they shall proceed and where they shall produce certain results.

7. Attention is called to the fact that this dominance of anterior or distal over posterior or proximal parts is similar in character to the relations between parts which exist in most if not in all plants. The regulatory formation of a new head in *Planaria* or of a new hydranth in *Tubularia* or *Corymorpha*, together with the effects of such a process on other parts is not essentially different in character from the formation of a new apical cell or vegetative tip in a plant and the resulting development of the new axis. In the plant, however, the new dominant region is in most cases unable to bring about to so great an extent as occurs in many animals the redifferentiation of masses of old tissue adjoining it, consequently the new plant axis remains short and small except when excess of nutrition is present. A considerable degree of redifferentiation of the old tissue under the influence of the new vegetative tip does occur, however, in many cases.

If my conclusions are correct the processes of form regulation in the animal and in the plant follow the same law and this law finds a general expression in the statement that any given region along the axis in which dynamic processes are occurring dominates more or less completely regions proximal or posterior to it and is dominated by regions anterior to it.

8. The very general if not universal formation of the distal or anterior region of the organism from the animal pole of the egg or from some region near it and the fact that many larvae consist essentially of only the most anterior regions of the body, together with the fact that it is the animal pole which initiates ontogenetic development in those cases where a difference in time along the axis can be observed in the earliest stages, and finally the very general progression of morphogenesis in the posterior direction, all these facts as well as many others suggest that the dominance of anterior or distal over posterior or proximal regions is a very general law of organic life. When we review the facts now at hand it appears probable that all organisms, except perhaps the simplest, are fundamentally systems of this character. Moreover, such a conception affords a most satisfactory and logical basis for a physico-chemical theory of development. Undoubtedly in many cases secondary isolations of parts occur, new correl-

ative factors arise and many other conditions combine to alter the original condition. But even in the adult organism the fundamental fact appears in the dominance of the apical region of the plant and in the functional dominance of the head region in animals.

9. It follows further, if the above conclusions are correct that in all cases where development is of this type the process of inheritance concerns primarily the anterior or distal regions. An isolated mass of protoplasm of a given species which is capable of continued existence and synthesis, no matter whether it is a mass of cells from the soma or an egg, represents primarily the dominant distal or anterior region, i.e., its specific type of reaction results always in the formation of this region and then if excess of nutritive material is present or obtainable so that growth may occur other parts arise in consequence of growth and of the correlative influence of the dominant region. In such cases the reproductive element, whether germ cell, somatic cell or mass of cells may represent merely a single specific reaction complex from which others arise as continued metabolism brings about the establishment of certain characteristic internal and external conditions.

So far as the formation of new distal or anterior regions is concerned, the process of form regulation in such cases consists essentially first in the return or approach of somatic cells or cell masses to the specific type of reaction in consequence of isolation from a dominant part which had previously determined some modification of this type of reaction in these cells, second of the formation of a new dominant region in consequence of this change, and finally of the development of subordinate parts under the control of the new dominant region so far as material or energy is available for such development.

In cases where only the formation of proximal or posterior parts is concerned form regulation consists first in the local reaction of cells to the absence of other parts, i.e., to altered correlative conditions, and second in the renewed growth and differentiation of such cells under the influence of more distal or anterior regions which dominate them.

Experimental data which throw light upon the problem of the nature of the dominance of certain regions over others will be presented in a later paper.

BIBLIOGRAPHY

- CHILD, C. M. 1905 Studies on regulation. ix. The positions and proportions of parts during regulation in *Cestoplane* in the presence of the cephalic ganglia. *Arch. f. Entwicklungsmech.* Bd. 20.
- 1907 An analysis of form regulation in *Tubularia*. i. Stolon formation and polarity. *Arch. f. Entwicklungsmech.* Bd. 23. iv. Regional and polar differences in the time of hydranth formation as a special case of regulation in a complex system. *Ibid.* Bd. 24. v. Regulation in short pieces. *Ibid.* vi. The significance of certain modifications of regulation: polarity and form regulation in general. *Ibid.*
- 1909 Factors of form regulation in *Harenaetis attenuata*. iii. Regulation in 'rings.' *Jour. Exp. Zool.*, vol. 7.
- 1910 Physiological isolation of parts and fission in *Planaria*. *Arch. f. Entwicklungsmech.* Bd. 30 (Festband für Roux) Teil 2.
- 1911a Die physiologische Isolation von Teilen des Organismus. *Vortr. u. Aufs. u. Entwicklungsmech.* H. 11.
- 1911b Studies on the dynamics of morphogenesis and inheritance in experimental reproduction. i. The axial gradient in *Planaria dorotocephala* as a limiting factor in regulation. *Jour. Exp. Zool.*, vol. 10.
- 1911c A study of senescence and rejuvenescence based on experiments with *Planaria dorotocephala*. *Arch. f. Entwicklungsmech.* Bd. 31.
- 1911d Experimental control of morphogenesis in the regulation of *planaria*. *Biol. Bull.*, vol. 20.
- MORGAN, T. H. 1900 Regeneration in planarians. *Arch. f. Entwicklungsmech.* Bd. 16.
- 1904 Régénération of heteromorphic tails in posterior pieces of *planaria simplicissima*. *Jour. Exp. Zool.*, vol. 1.
- RAND, H. W. 1911. The problem of form in *Hydra*. *Science*, vol. 33, no. 845. In report of meeting of December, 1910, of Am. Soc. Zool., Eastern Branch.

STUDIES ON THE DYNAMICS OF MORPHOGENESIS
AND INHERITANCE IN EXPERIMENTAL
REPRODUCTION

III THE FORMATION OF NEW ZOÖIDS IN PLANARIA AND OTHER
FORMS

C. M. CHILD

From the Hull Zoölogical Laboratory, University of Chicago

THIRTY-SIX FIGURES

CONTENTS

1	The origin of new zoöids in nature.....	222
2	The formation of a second zoöid under experimental conditions.....	223
3	The results of feeding and growth in teratomorphic anophthalmic and headless pieces	231
4	The fate of posterior zoöids in starvation	235
5	The formation of chains of zoöids.....	242
6	The factor of distance in the formation of new zoöids and its relation to the stage of development of the dominant region.....	256
7	The disappearance of zoöids in consequence of decreased distance from a head region	271
8	Conclusion and summary.....	274
	Bibliography.....	280

In an earlier paper (Child, '10) the relation between the act of fission and physiological isolation in *Planaria* was considered and it was shown that the process of fission may be controlled experimentally in various ways. The present paper is devoted to the question of the origin of new zoöids, their fate under various conditions and the rôle which the factor of distance from the dominant region plays in determining their formation. A brief account of the formation of new zoöids in *Stenostomum* is added to show that the process in this form follows the same general laws as in *Planaria*.

The purpose of the present paper is to show that the formation of new zoöids at the posterior end of the body in *Planaria* and related forms is essentially a process of regulation, resulting from the physiological isolation of the region concerned from the dominant region in much the same manner as development of a new whole results from the physical isolation of a piece of the planarian body.

1. THE ORIGIN OF NEW ZOÖIDS IN NATURE

The facts which indicate the presence of one or more zoöids in the posterior region of *Planaria dorotocephala* have been discussed in the first paper of this series (Child, '11b) and elsewhere (Child, '10). Up to the present time I have not had opportunity to examine newly hatched individuals of *P. dorotocephala*, but in *P. maculata* immediately after hatching, or in animals removed from the egg capsule by artificial means just before hatching I have been unable to discover any evidence that the second zoöid is present. The usual method employed to determine the presence of one or more zoöids in the posterior region is the separation of this region into a series of short pieces: the pieces which represent the anterior region of a zoöid or levels just anterior to it show a greater capacity to form heads than those pieces which



Figs. 1 and 2 Fig. 1, newly hatched *Planaria maculata*. Fig. 2, Posterior half of newly hatched worm, which remains headless when isolated.

represent other regions. In the newly hatched worms the post-pharyngeal region is much shorter than the prepharyngeal (fig. 1) and even the whole posterior half of the body, including the pharyngeal region usually remains headless when isolated (fig. 2), i.e., it resembles the posterior region of the first zoöid in larger animals.

At the stage just after hatching the animals are about 2 mm. in length but growth is rapid at ordinary temperatures and they attain a length of 4 or 5 mm. in two or three days. By the time they have reached this stage the second zoöid is clearly present as is shown by the fact that the capacity of pieces to form heads increases suddenly a short distance posterior to the pharynx. Moreover, it is possible to induce fission experimentally in animals not much over 5 mm. in length (Child, '10).

It is evident from these facts that the second zoöid arises in the posterior region of the body during the course of development. After its formation it continues to grow more rapidly than the first zoöid and its own posterior region may give rise to other zoöids. The second zoöid consists essentially in a more or less definitely localized region of increased capacity of head formation and posterior to this a gradient resembling the axial gradient in the first zoöid (Child, '11b). In other words, it represents the first stage in the formation of a new dominant region like the head of the whole.

If my conclusions concerning the rôle of physiological isolation in reproduction (Child, '11a) are correct, the origin of the second zoöid in *Planaria* may readily be conceived as the result of physiological isolation of the region concerned from the dominant head region. In consequence of such isolation the piece begins to develop into a new individual with its own dominant anterior region. Development is not complete so long as organic continuity with more anterior parts persists because the isolation is not complete. If the formation of the second zoöid actually occurs in this manner then it should be possible to induce or inhibit the formation of a second zoöid experimentally by altering the degree of physiological isolation of the posterior region of pieces. That this may be accomplished is shown in the following section.

2. THE FORMATION OF A SECOND ZOÖID UNDER EXPERIMENTAL CONDITIONS

If we isolate the anterior end of a worm including the old head, e.g., the region anterior to the level a in fig. 3, regulation occurs

in the manner indicated in figs. 4 and 6. A short postpharyngeal region is formed but its growth is slow unless the animal is fed. If we now isolate the posterior half or two-thirds of this new postpharyngeal region we find it incapable of producing a new head. When the whole postpharyngeal region of such pieces is isolated

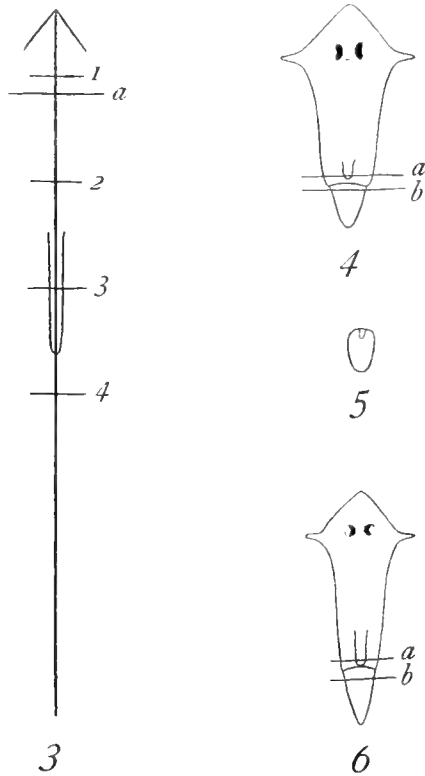

Figs. 3-6 Fig. 3, diagram showing levels of section. Figs. 4 and 6, different stages of anterior pieces with large heads. When their posterior regions are isolated they remain headless as in fig. 5.

it usually gives rise to a head, but the region where we should expect to find the anterior end of the second zoïd if it is present shows no indication of increased capacity for head formation. By way of illustration the records of a series of this sort are given.

The anterior regions including the old heads of sixty well fed worms 16 to 18 mm. in length were cut off at the level *a* in fig. 3 and allowed to regulate for ten days at a temperature of 20°. At the end of this time they had reached the stage of fig. 4 and at this stage a second operation was performed to obtain the new posterior ends. The attempt was made to cut the posterior ends from twenty of the pieces at the level indicated by the line *b* in fig. 4. This operation is not easy since these pieces move with considerable rapidity and the new posterior end is still short. Examination of each of the twenty pieces after cutting showed that fifteen of them had been cut approximately at the level *a* in fig. 4 or even further anteriorly. This could be determined without difficulty because such pieces showed a region of the old pigmented tissue at their anterior ends. The remaining five pieces contained nothing but the new unpigmented tissue. The results are as follows:

	HEADS	HEADLESS	DEAD
Twenty pieces	14 (longer)	5 (shorter)	1

The five headless pieces (fig. 5) are really the only part of the series which represents successful operations for they are the pieces which correspond to the region where the second zoöid would be if it were present.

The remaining forty of the original pieces were left for seven days more, seventeen days in all after the operation. At the end of that period they had reached the stage of fig. 6. From these also the posterior ends were removed for comparison with the first, in order to determine whether a second zoöid had arisen during the later stages of regulation. The results of this second operation were as follows:

	HEADS	HEADLESS	DEAD
Nineteen pieces	6 (longer)	7 (shorter)	6

The nineteen pieces include all in which the cut was made anywhere the desired level. Among these thirteen were cut at or near the level *b* in fig. 6 while the others were cut at the level *a* or anterior to it. Of the thirteen pieces cut at *b* six died and six remained headless. The pieces that died lived for several days after the operation and showed no signs before death of head formation. These pieces then behave like pieces that are physiologically as well as morphologically posterior: they resemble pieces from the posterior region of the first zoöid in larger worms; such pieces always remain headless unless they are of considerable length.

Pieces of the same length as those in this series, or even those of half that length from the posterior ends of worms in which the formation of new zoöids has occurred will give 100 per cent or nearly of normal heads.

This series seems then to indicate that in short pieces from the anterior end and possessing the old head the second zoöid does not form, even though such pieces are longer, in the present case 7 to 8 mm., than the shortest normal worms in which the second zoöid can be distinguished (5 mm.). In these anterior pieces the posterior region is physiologically as well as morphologically a posterior end and not a second zoöid.

But if we feed such pieces so that growth occurs the second zoöid appears sooner or later, as might be expected.

In these anterior pieces the regulatory development of the new postpharyngeal region occurs under conditions different from those which exist in normal development, i.e., it develops at only a short distance from a head which represents a much more advanced stage of development. The obvious inference from the facts is that the new postpharyngeal region does not give rise to a new zoöid under these conditions, simply because it is too completely subordinated to the head region with which it is connected: physiological isolation of this region does not attain the stage where formation of a new zoöid is possible until or unless the pieces attain a considerably greater length.

Taken by themselves, these and similar experiments are open to various objections. The possibility that the posterior pieces

are 'too small' or that they are not sufficiently advanced in development to be able to undergo regulation when isolated cannot be ignored. It is necessary therefore to compare the posterior ends of such anterior pieces possessing large and active heads with the posterior ends of headless pieces.

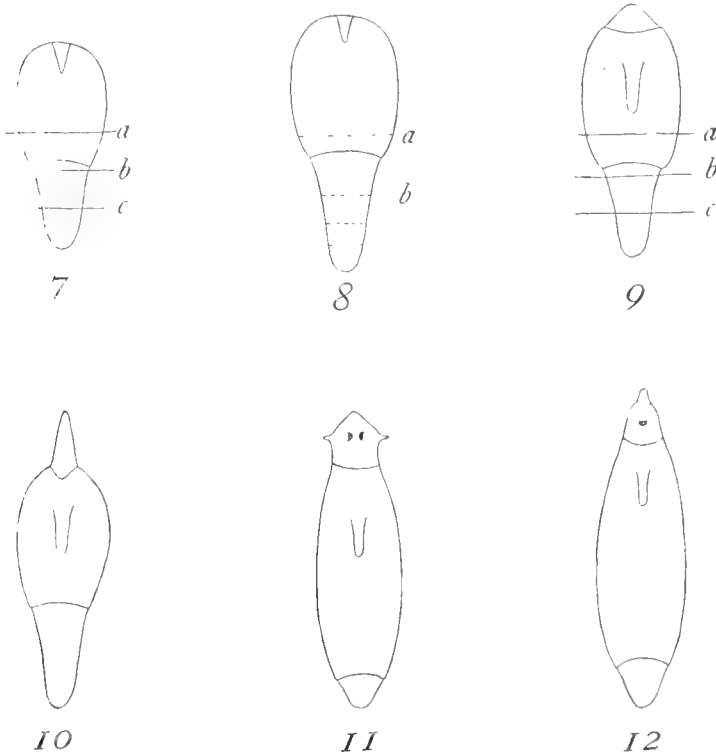

Figs. 7-12 Fig. 7, a headless piece. Its posterior end when isolated at *a*, *b*, or *c* produces a normal animal. Fig. 8, headless piece with posterior zooids indicated. Figs. 9 and 10, anophthalmic pieces: their posterior ends when isolated at *a*, *b*, or *c*, fig. 9, produce normal wholes. Fig. 11 shows the small size of posterior outgrowth in pieces which form a head. Fig. 12, teratomorphic piece: posterior outgrowth intermediate in size between that of headless pieces and pieces with heads.

One noticeable characteristic of headless pieces in general under natural conditions is the large amount of new tissue which develops at the posterior end (fig. 7). Frequently this posterior new tissue

becomes equal in length to the old tissue of the piece (fig. 8) and in consequence of the inactivity of these pieces the posterior end is always broad and blunt instead of slender and tapering as in pieces with heads.

If such pieces are kept at a temperature of 20° C. or lower they show comparatively little 'spontaneous' motor activity and it is often rather difficult to stimulate them to locomotion. But even under such conditions headless pieces undergo fission more or less frequently. At a temperature of 25°, however, they are much more active and very often divide. Division occurs approximately at one of the two levels indicated by the dotted lines *a* and *b* in fig. 8. In case fission occurs at *b* a second fission often occurs a few days later, indicating that the posterior region of these pieces consists of at least two zoöids. In case the fission occurs at *a* a second fission does not occur unless the pieces are fed and grow (see Section III below).

Fission of these pieces can also be induced in many cases by mechanical stimulation. In consequence of such stimulation locomotion takes place and an independent motor reaction of the posterior region is very likely to occur.

In all cases of fission of headless pieces the posterior product of fission develops rapidly into a normal whole.

It is evident from these facts that the posterior regions of headless pieces are not physiologically posterior ends but rather new zoöids. Since, as I showed in an earlier paper (Child, '10), the act of fission is the result of an independent motor reaction of the two zoöids concerned, the second attaching itself to the substratum while the first advances, fission can occur in these headless pieces only when their motor activity is sufficient to accomplish the rupture of the tissues.

The anophthalmic pieces (Child, '11d) resemble the headless pieces as regards their posterior ends (figs. 9 and 10). Fission often occurs in them as well as in the headless pieces.

All of these facts show very clearly that in the anophthalmic and headless pieces the slight development or the complete absence of the head region permits the very early physiological isolation of the posterior end and one or more new zoöids develop early in the course of regulation.

On the other hand, pieces of the same length and from the same region of the body as the headless and anophthalmic pieces, but which develop normal or teratophthalmic heads, show much less new tissue at the posterior end (fig. 11) and very rarely undergo fission unless they are fed and increase in length occurs. In these pieces a very short second zoöid may sometimes arise at the posterior end without feeding, but the degree of physiological isolation is insufficient to permit the occurrence of fission except, as above stated, when such pieces are fed and grow.

In most of the series of experiments which bear upon this point the pieces were taken from the middle region of the body. A large number of my experimental series consist of fifty pieces each of the regions 1, 2; 2, 3; 3, 4 in fig. 3. These three sets of pieces are designated A, B and C. When well fed worms are used and when regulation occurs at a temperature of 20° or above in sufficiently aerated water all of the A pieces produce heads and show no fission, but in the B and C pieces the anophthalmic types are of frequent occurrence and it is among these that the fissions occur. The data for a few series will serve for purposes of illustration.

In these series the pieces were taken from worms 15 to 18 mm. in length which had received all the food they would take for at least a week before section. Each set of B or C pieces was fifty in number. The table shows the results of regulation and the frequency of fissions for these pieces in percentages.

		NORMAL	TERATO- PH- THALMIC	TERATO- MORPHIC	ANOPH- THALMIC	HEADLESS	DEAD	FIS- SIONS
Series 321	{ B	20	36	10	24	5	2	2
	{ C	4	14	2	16	62	2	16
Series 387, I, 1	{ B	2	36	8	34	18	2	2
	{ C	0	4	2	8	78	8	16
Series 387, II, 2	{ B	2	48	8	30	12	0	6
	{ C	0	12	4	10	74	0	26

In all of these series every case of fission occurred in either the anophthalmic or the headless pieces. In the three series together there were sixty-three anophthalmic and headless pieces among the B pieces and of these five underwent fission, i.e., about 8 per cent. The anophthalmic and headless pieces among the C pieces were one hundred and fourteen in number and of these twenty-nine, about 25 per cent, underwent fission. This is a fair sample of my results at temperatures of about 20°. My records include more than two thousand of these B and C pieces and among these more than 95 per cent of the fissions which occurred took place in anophthalmic and headless pieces.

It is of some interest to note that fissions occur more frequently in the C than in the B pieces. The C pieces represent a more posterior region of the original body than the B pieces and in general show a much lower frequency of head formation. If the formation and separation of the posterior zoöid is the result of physiological isolation we may expect to find it occurring more frequently in the C than in the B pieces because the latter possess in general less capacity to form heads at their anterior ends.

But instead of waiting for fission to occur in the normal manner we may examine the capacity of the posterior ends of headless and anophthalmic pieces for head formation by observing the regulation of pieces cut from them at various levels. This experiment, which I have repeated many times, shows that such pieces produce normal wholes in practically every case. The result is the same whether the cuts are made at the levels *a*, *b*, or *c* as indicated in figs. 7 and 9. In fact it is difficult to cut from the posterior end of such pieces a piece so small that it will not produce a normal whole. Moreover, if the region posterior to the level *a* in fig. 7 and 9, i.e., about the anterior end of the second zoöid is cut into a series of very short pieces a sudden increase in the capacity to form heads appears in its posterior region, indicating that, as in most cases the posterior region of the second zoöid has undergone further physiological isolation and represents one or more additional zoöids.

When we contrast the behavior of the posterior regions of these headless and anophthalmic pieces with that of the posterior regions

of the anterior pieces with large heads described above, the difference is sufficiently evident to require no comment. I believe that these experiments justify the conclusion that *the more advanced or the more rapid the development of the head in any piece of given length the less frequent is the formation of a new zoöid at its posterior end and vice versa.*

Moreover, this difference is not closely connected with the amount of nutritive material available. The posterior zoöid arises in starved headless pieces almost as readily as it does in those in which excess of food is present. On the other hand, when the head is present and well developed, excess of nutritive material does not determine the formation of a second zoöid, except in so far as it induces growth.

In the teratomorphic pieces (fig. 12) the head is of small size, but it is much more highly developed than in the anophthalmic and headless pieces. Histological examination shows a ganglionic mass which is often almost as large as that of the normal head. In accordance with this condition of the head region we find that teratomorphic B and C pieces undergo fission but rarely. The posterior outgrowth in these pieces is often somewhat larger than in pieces of the same length with normal heads (compare figs. 11 and 12) but it is always less than in anophthalmic (figs. 9 and 10) and headless pieces (figs. 7 and 8) of the same length. In some cases, however, the posterior regions of teratomorphic pieces give rise to new zoöids but the development of the head is in almost all cases sufficient to prevent such zoöids from attaining the stage of development at which separation is possible.

3. THE RESULTS OF FEEDING AND GROWTH IN TERATOMORPHIC, ANOPHTHALMIC AND HEADLESS PIECES

It is a well known fact that fission can be induced in normal animals by feeding: the worms increase in size, the region of the posterior zoöid or zoöids growing more rapidly than others, until sooner or later fission occurs (Child, '10).

The teratomorphic, anophthalmic and headless pieces are unable to make their way to food which is placed near them. As the extractives diffuse from the meat these forms often extrude their

pharynges and these make searching movements in the water and over the substratum, but the pieces do not move toward the meat. If, however, they happen to come into contact with it by chance they almost invariably feed.

In the teratomorphic pieces this inability to direct the movements toward the food is of particular interest. These pieces are very evidently excited by the diffusing extractives from the meat: they lift their heads and move them about in much the same manner as normal animals, but this reaction is not followed by movement toward the food. The movement which occurs may be in any direction and discovery of the meat seems to be purely a matter of chance. In all the teratomorphic pieces which I have used thus far in such experiments the auricles were partly or wholly fused in the median line at the anterior end of the head and it seems probable that the inability of these pieces to direct their movements toward the food is due to the fact that they possess only one median instead of two lateral organs of chemical sense.

These sense organs are usually absent in the anophthalmic and always absent in the headless forms. In these latter the only marked reaction to food which I have observed is that of the pharynx.

Since even the headless, as well as the anophthalmic and teratomorphic pieces will feed when brought into direct contact with the food, it is possible to keep them indefinitely and to bring about growth. In feeding such forms pieces of meat are placed in the dish containing them and the pieces are then picked up with a pipette or a needle, to which they usually adhere, and deposited on the meat. There they feed and sometimes creep away after they have finished. After two or three hours they are removed from the meat if still on it, the meat is taken out and the water changed. By these means such pieces can be kept with little more difficulty than normal worms. The possibility of keeping and 'breeding' such pieces, either through natural fission or by section opens up an interesting field of experiment. At present, however, we are concerned only with the occurrence of fission in connection with growth: other results will be considered at another time.

In some cases teratomorphic heads redifferentiate in later stages into heads of normal form and two eyes symmetrically placed develop in addition to the single median eye. In some cases also pieces which are at first anophthalmic later become teratomorphic or teratophthalmic. Occasionally these changes occur even when the pieces are not fed, particularly if they are kept at a temperature of 25° C. or higher; below this temperature I have not observed them. When the pieces are fed such changes occur more frequently.

In general, however, these redifferentiations of the head occur only within the first two or three weeks after section. If the piece remains teratomorphic or anophthalmic during that time it remains so indefinitely, no matter how much food it receives. I have kept some of these pieces for more than three months without the occurrence of any trace of change.

In pieces which were strictly headless ten or twelve days after section further development of the anterior end has never occurred within the limits of my observations. The important fact in all of this for present purposes is that many of the teratomorphic, anophthalmic and headless pieces do not develop further when fed but remain what they were. Evidently such pieces have attained a new dynamic equilibrium different from that of the normal animal.

Since it is only during the last few months that I have attempted to feed pieces of this sort my experiments have not as yet proceeded very far, but one result of interest in the present connection has already been obtained. When fed abundantly so that growth occurs, the headless pieces usually attain a length of 5 to 6 mm. before fission occurs. The anophthalmic pieces attain on the average a somewhat greater length, 6 to 7 mm. before fission and the teratomorphic pieces often attain a length of 9 to 10 mm. before dividing.

After the first period of growth and fission no further increase in size of the anterior regions of these pieces has been observed. All further growth is in the posterior region where after the first fission another new zoöid forms and grows until it attains about the same size as before, when another fission occurs. Up to the

present I have seen pieces of this kind produce new zoöids and divide four times and there is every reason to believe that they will continue to do the same thing indefinitely, or at least for a much longer time.

There is of course considerable variation in different individual pieces, but in general there is no doubt that the length which the piece attains before fission varies with the degree of development of the head region: the higher the development of the head region the greater the length which the animal attains before fission. Evidently the more highly developed head region is capable of dominating a longer body than the less highly developed. If the pieces were left entirely undisturbed the posterior zoöids in the anophthalmic and headless pieces might attain a considerably greater length before fission took place, but of course pieces which are fed cannot be left undisturbed. When the pieces are fed every alternate day or at regular intervals their removal from the meat and the change of water stimulate them to movement and so aid in bringing about the act of fission. The teratomorphic pieces, however, show a much greater degree of 'spontaneous' activity than the others, therefore the fact that they attain a greater length before fission is certainly not due to less motor activity.

Such pieces do not attain anything like the length of animals with normal heads before fission. The greatest length observed thus far in the teratomorphic pieces is 9 to 10 mm., somewhat more than half the length attained by normal animals under similar conditions before fission.

These various facts seem to me to indicate very clearly the importance of the factor of distance in the dominance of the head region and the rôle of physiological isolation in the formation of new zoöids.

One further fact may be mentioned incidentally. After fission the posterior piece, whether it arose from a teratomorphic, an anophthalmic or a headless piece, develops rapidly into an animal with normal head and eyes. In short it does not inherit the peculiarities of its parent. In later papers I shall show from other experimental data that the various types of the head are due primarily to quantitative rather than qualitative differences in

the dynamic processes concerned. Teratomorphic, anophthalmic and headless pieces appear where the rate of reaction in the developing region falls below a certain minimum necessary for the development of a normal head. In the posterior zoöid after separation conditions are quantitatively different and the rate of reaction is sufficient for the formation of normal heads.

4. THE FATE OF POSTERIOR ZOÖIDS IN STARVATION

It has long been known that *Planaria* and various other species of turbellaria may be reduced by starvation to a small fraction of their original size before death occurs. In general the postpharyngeal region decreases in length more rapidly than the prepharyngeal during starvation. In the very large animals the postpharyngeal region is much longer than the prepharyngeal: Fig. 13 shows the proportions of a worm 22 to 24 mm. in length. As reduction through starvation occurs in such worms the proportions remain at first about the same, but when the animal is reduced to about half its length (10 to 12 mm., fig. 14) it is usually found that the pharynx is nearer the middle of the body than in longer worms, although the postpharyngeal region is usually still the longer. When the worm is reduced to 4 to 5 mm. in length the pharynx is usually approximately in the middle (fig. 15) and as further reduction occurs the postpharyngeal region may become slightly shorter than the prepharyngeal (fig. 16). These changes in proportions are the reverse in direction of those which occur during the normal increase in size of the animals, but in general *the reduced animal of a certain length possesses a longer postpharyngeal region than the well fed growing animal of the same length*. This difference is particularly noticeable in the smaller worms. In a young growing worm of 5 mm. in length the pharynx is usually posterior to the middle of the body (fig. 17), while in the starved worm of the same length it is in the middle or anterior to the middle (fig. 15). In very young worms 2 mm. in length, i.e., shortly after hatching, the pharynx is near the posterior end (fig. 18) while in starved worms of the same length the pharynx is only slightly, if at all posterior to the middle (fig. 16).

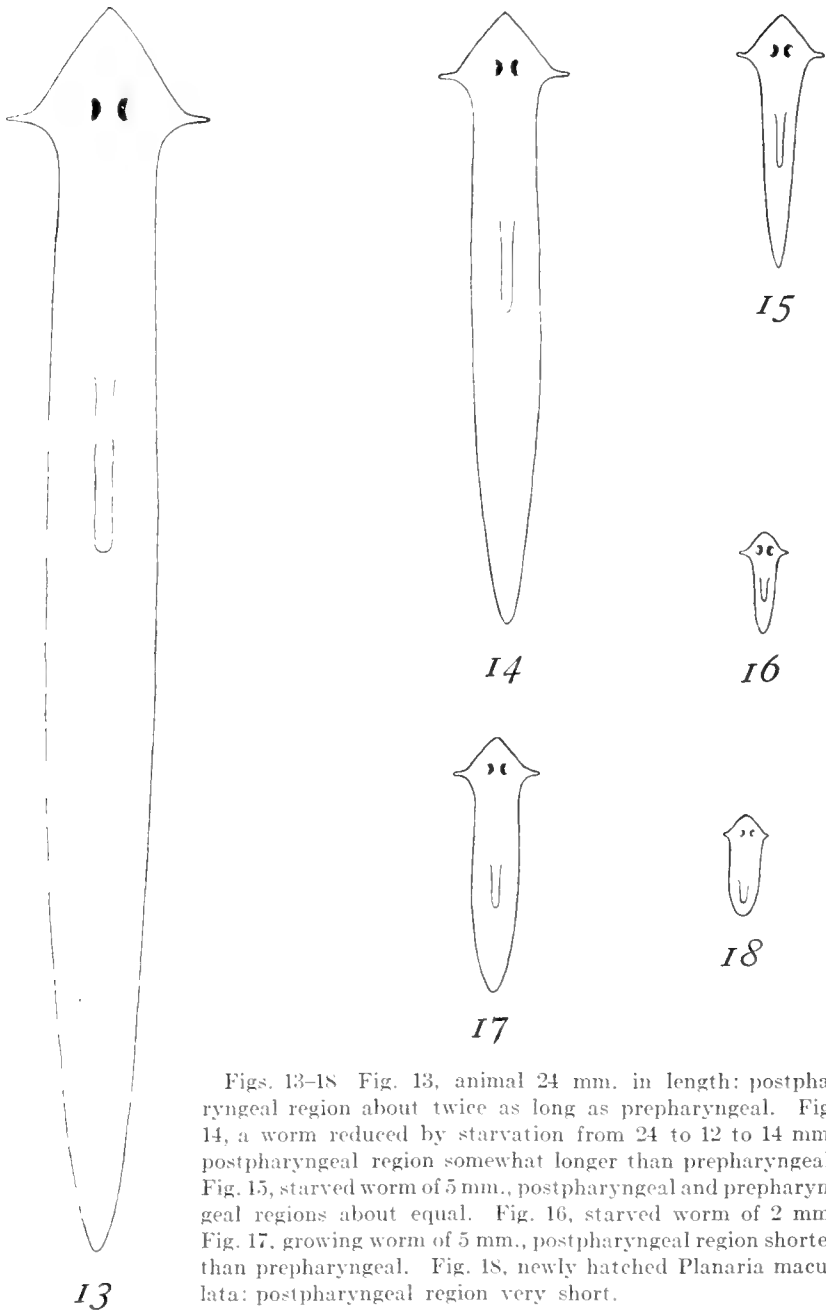

Figs. 13-18 Fig. 13, animal 24 mm. in length: postpharyngeal region about twice as long as prepharyngeal. Fig. 14, a worm reduced by starvation from 24 to 12 to 14 mm: postpharyngeal region somewhat longer than prepharyngeal. Fig. 15, starved worm of 5 mm., postpharyngeal and prepharyngeal regions about equal. Fig. 16, starved worm of 2 mm. Fig. 17, growing worm of 5 mm., postpharyngeal region shorter than prepharyngeal. Fig. 18, newly hatched *Planaria maculata*: postpharyngeal region very short.

Comparison of the different stages of starvation shows that in most cases the anterior zoöid decreases slightly more rapidly than the posterior or at about the same rate during the earlier stages, but that later the decrease in length is more rapid in the posterior zoöid or zoöids. Apparently in the earlier stages neither part is capable of maintaining itself at the expense of the other to any great extent, or if there is any difference in this respect it is the posterior younger part which has the advantage. Later, however, as the worm becomes shorter the degree of dominance of the head region over the posterior region increases as the distance between the two regions decreases and the independent development of the posterior zoöid is retarded or ceases. From this time on the anterior zoöid has the upper hand, so to speak, and lives to some extent at the expense of the other, therefore in the later stages of starvation the posterior zoöid decreases more rapidly than the anterior.

A comparison of the different regions of the first zoöid shows what has been noted by other authors, viz., that the head region decreases in size somewhat less rapidly than other parts. Consequently the head appears disproportionately large in the small reduced worms. On the other hand, repeated comparison of starved and young worms of the same size leaves no doubt that the head of the young worm is slightly larger than that of the starved animal. I have not attempted measurements in connection with this point, but have observed the difference many times.

The facts indicate then that in the course of reduction through starvation the posterior zoöid or zoöids become less and less completely physiologically isolated from the dominant head region as the distance between them decreases. The zoöids which arose during growth become less and less true zoöids as they come more completely under the control of the dominant region: they gradually return to or approach the condition of physiologically posterior regions and as this change occurs the more anterior regions become more and more able to maintain themselves on the material of the posterior parts.

But if the longer postpharyngeal region and the smaller size of the head in the extreme stages of starvation as compared with

young animals of the same length means anything it means that after the second zoöid has once arisen it possesses a certain capacity to maintain itself even in conflict with other parts. In other words, after a new zoöid has once arisen, whatever the conditions of its origin may have been, the control of the dominant head region of the whole over such a zoöid is not as complete as its control over a region situated at the same distance from it but in which no new zoöid has arisen. The relation between the anterior and posterior zoöids in starvation is somewhat similar to that between a weaker and a more powerful or a less and a more active individual in a struggle for food when the supply is insufficient for both. At first the weaker individual succeeds in obtaining a certain amount but in the end it is eliminated before the other.

At any given stage of starvation then the dominance of the anterior region of the animal over the body as a whole is somewhat less complete than in growing animals of the same length.

There seems to be no reason for a teleological interpretation of these relations such as Schultz ('04, '06, '07, '08a, '08b) and certain other authors have suggested. If the relation between morphological structure and metabolism is of the character which our present knowledge seems to indicate (Child, '11c, pp. 571-578; '11e, pp. 173-178) it is evident that in starvation those parts of the body whose rate of reaction decreases least will maintain their structure and size most completely, for they will obtain their energy in part from other organs whose rate of reaction has decreased to a greater extent. In the part with the higher rate of reaction the loss of structural substance, which takes place more or less at all times is more completely compensated by the new structural substance which is formed in the course of further metabolic reactions than in the part with the lower rate. In the organ with the lower rate, on the other hand, the chemical conditions must favor an increased breaking down of structural material which thus becomes available as a source of energy and incidentally for the formation of new structure wherever the demand is greatest, i.e., wherever the rate of reaction has undergone least decrease.

In *Planaria* the head region, where the chief sense organs which are affected by external stimuli are situated, and the central nervous system, the chief organ of conduction and correlation, must maintain more nearly their characteristic rate of reaction during starvation, not because they are more essential than other parts, but simply because they are more often or more intensely stimulated than other parts. So long as the animal remains alive in a changing external environment these organs, primarily because of their relation to the external world and to other parts must maintain more nearly their characteristic rate of reaction than other parts. Both their importance for the life of the organism and their persistence in starvation are due to this relation. In general it is the most essential organs which are most constantly or most frequently the seat of dynamic processes, but the occurrence of dynamic processes in any part depends not simply upon the part itself but upon its correlation with other parts and its relations to the external world, in short upon its environment. The most 'essential' part in any organism is then merely that part in which under the conditions of existence of the organism characteristic dynamic processes are most constantly or most frequently induced by the internal or external environment. In the simpler organisms like *Planaria*, which in the absence of food, are able to use their own structural colloids as a source of energy to a very large extent the most essential parts according to this definition are the head region and the central nervous system. When the dynamic processes in these fall below a certain level the organism ceases to exist as such. To maintain that the organism is able to control and guide the destruction or maintenance of parts in starvation in a manner involving the idea of finality is to ignore the facts which are already at hand.

In the absence of the head region the relation between parts in starvation is very different from that which exists when the head region is present. We are able to compare the course of starvation in normal animals and in headless pieces of *Planaria* and we find that in headless pieces it is the posterior instead of the anterior zoöid which maintains itself at the expense of other parts. Fig. 19 represents a headless piece corresponding to the

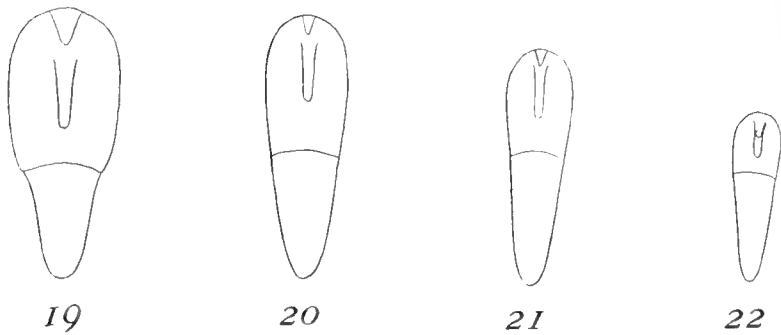

Figs. 19-22 The changes in a headless piece during starvation. Fig. 19, twelve days. Fig. 20, twenty-six days. Fig. 21, forty-eight days. Fig. 22, one hundred and twelve days.

region 2, 3 in fig. 3 as it appeared twelve days after section. The boundaries between the new and the old tissue are indicated at the two ends of the piece. Fig. 20 shows the same piece twenty-six days after section: the posterior new tissue, i.e., the region of the posterior zoöid has increased in size relatively to the anterior region. Fig. 21 shows the same piece after forty-eight days: here still farther increase in size of the posterior region at the expense of other parts has occurred. And finally fig. 22 shows the piece after one hundred and twelve days of starvation. Throughout the course of starvation the posterior zoöid has continued to increase in size as compared with the anterior region. At the stage of fig. 22 the pharynx, which decreases in size less rapidly than the parts about it, has been forced posteriorly through the tissues until its posterior end lies a considerable distance posterior to the mouth as indicated in the figure. Shortly after the stage shown in fig. 22 the piece died. In general headless pieces die of starvation at a much larger size than wholes. This difference is undoubtedly connected with a difference in the rate or intensity of the dynamic processes and will be more fully considered elsewhere. At present we are concerned with the fact that during starvation the posterior zoöid decreases in size less rapidly than that part of the anterior zoöid which is present: in the absence of a more highly developed head region anterior to it the anterior region of the posterior zoöid has become to some extent the dominant region of the whole piece.

A similar relation exists under certain conditions in *Stenostomum*, as I showed in an earlier paper (Child, '03). There the cephalic region of any zoöid, even if the more posterior parts of the zoöid are not present, will bring about the resorption and destruction of portions of zoöids deprived of the cephalic ganglia which are attached to its anterior end. Moreover, when pieces are cut so that they consist of one or more younger zoöids with an older zoöid posterior to them, the older, most posterior zoöid is dominant and the younger zoöids anterior to it, instead of continuing to develop, undergo resorption and the posterior zoöid grows at their expense until finally its cephalic region becomes the anterior end of the whole piece. Only occasionally and when the younger anterior zoöids are themselves well advanced in development do they succeed in maintaining their individuality and continuing their development to the stage of separation and even under these conditions they usually undergo considerable reduction in size. In *Stenostomum* this process of destruction is not a matter of long continued starvation, but is completed in two or three days and is much more striking than in *Planaria*. The enteric cavity and pseudocoel of the posterior zoöid in *Stenostomum* often become greatly distended with the cellular débris from the disintegrated anterior zoöids or parts of zoöids. In both cases, however, the posterior zoöid becomes dominant and if the pieces of *Planaria* did not die before the process was completed we should undoubtedly find the head region of the posterior zoöid becoming the anterior end of the piece in *Planaria* as well as in *Stenostomum*.

Both of these cases demonstrate that the head region of a posterior zoöid exercises some sort of correlative influence upon parts anterior to it, at least in the absence of more highly developed dominant parts in those regions, as well as upon parts posterior to it. In the case of *Stenostomum*, however, starvation is not necessary to bring about the decrease in size and resorption of the anterior zoöids; this occurs so rapidly that the posterior, dominant zoöid is often packed almost to bursting with the products of disintegration which it only gradually makes use of as nutrition. It is perhaps scarcely worth while at present to speculate concerning the exact nature of the influence of the pos-

terior zoöid upon the parts anterior to it in *Stenostomum*, but it seems not improbable that the rapid resorption and disintegration of the anterior parts is due to a condition of more or less complete functional paralysis. They are reduced by the operation to the condition of mere excrecences upon the anterior end of an organism. If they receive impulses from the dominant region posterior to them these must conflict with and contribute to the destruction of their own coördinations since the region from which they come is posterior instead of anterior. Moreover, the existing conditions do not result in the incorporation of these parts into a new functional whole as in many cases where parts are grafted together and both are undergoing regulation, for the functional whole is already present in the posterior zoöid and merely interferes with the function of these parts anterior to it. My suggestion is then that in this conflict of conditions correlation in these parts is destroyed or interfered with to such an extent that they cease to exist as individuals and their cells, which do not necessarily die at once pass into the cavities of the body of the dominant individual as so much foreign matter.

5. THE FORMATION OF CHAINS OF ZOÖIDS

In my paper on physiological isolation and fission in *Planaria* (Child, '10) I mentioned the probability that long worms often consisted of more than two zoöids. Since that time it has been possible to obtain more definite evidence upon this point and it is now certain that animals of more than sixteen millimeters in length usually consist of at least three and probably in most cases of more than three zoöids, for the extreme posterior end apparently represents a sort of 'growing tip' and probably consists of a number of very short zoöids. This region is perhaps comparable to the 'growing region' at the posterior ends of various annelids where a considerable number of minute segments are often visible.

It is possible to demonstrate the existence of several zoöids at the posterior end of long worms by inducing fission at different levels and this can readily be done, as I shall show, by cutting pieces of different lengths so that the new head will arise at a

certain distance from the region where it is desired to induce fission. It is also possible to induce the disappearance of zooids already formed by cutting the piece so that a head will form a short distance anterior to the head region of the zooid.

But it is possible to determine approximately the positions of the anterior ends of zooids in the body without waiting for fission to occur. If we cut the postpharyngeal regions of long worms into series of short pieces of as nearly as possible equal length we find that the pieces which represent the level of the head region of a zooid show a greater capacity for head formation than the others. In general the results obtained by this method correspond so closely with those of the experiments on fission that I believe we are justified in concluding that such regions of increased capacity for head formation, wherever they occur in the postpharyngeal region represent the anterior ends of existing zooids. In *Planaria* these zooids do not develop far enough to become visible morphologically, but I think there can be no doubt that they do exist as more or less definite regions of coordinated dynamic activity which represent the earliest stages of the redifferentiation of this part of the body into new individuals. Under natural conditions an independent motor reaction sooner or later brings about the complete isolation of these regions and then the redifferentiation proceeds rapidly as in regulation.

My experiments include a large number of series of pieces of this kind, but most of them show the existence of two or at most three zooids. Below are given the records of three series, the first of which shows the worms used to consist of at least three zooids, while the other two series indicate the presence of four or more. The method is of course not an accurate one since it is impossible to cut pieces of exactly equal length and length is a factor in the capacity for head formation (Child, '11b): moreover, as the length of the piece decreases its capacity for regulation decreases and the differences between different levels often become less marked. However, I have used the method merely as a means of showing that the planarian body may consist like *Stenostomum* and various other forms of a chain of zooids.

For the sake of convenience the notation which was used in my earlier work on *Stenostomum* is adopted here. In a chain

consisting of two zoöids resulting from the division of a single individual the two zoöids are 1. and 2., 1. being the anterior. When zoöid 1. divides it gives rise to zoöids 1.1. and 1.2. and zoöid 2. divides into 2.1. and 2.2. A third cycle of divisions gives zoöids 1.1.1., 1.1.2., 1.2.1., 1.2.2., 2.1.1., etc.

Series 333. During two weeks before the experiment the stock received maximum feeding: food was placed in the jar every day and after a few days of such feeding the stock as a whole showed but little hunger, i.e., on any one day only a few animals would feed. The postpharyngeal region in all worms used for the experiment was much longer than the prepharyngeal, an indication that the posterior zoöid or zoöids had reached a considerable size.

On February 8, 1911, ten worms as nearly alike as possible and all 18 to 20 mm. in length were selected from the stock and the postpharyngeal region of each of these, beginning at the mouth, was cut into six pieces as nearly as possible equal in length. Each ten pieces representing approximately the same region of the body from each of the ten worms were placed together. The results of the regulation of these pieces appear in the following table in which the pieces are numbered 1 to 6 from the anterior end of the postpharyngeal region backward. The results are given in actual numbers, but since each set consists of ten pieces multiplication of these numbers by ten will give percentages.

PIECES	NORMAL	TERATOPHTHALMIC	TERATOMORPHIC	ANOPHTHALMIC	HEADLESS
1	1	0	0	0	9
2	0	1	2	2	5
3	3	1	0	1	5
4	0	4	1	1	4
5	8	2	0	0	0
6	7	3	0	0	0

These results are presented graphically in fig. 23. In this figure the larger spaces of the cross section paper along the ordinate represent number of pieces, ten being the total. The abscissa represents the axis of the postpharyngeal region of the worms and

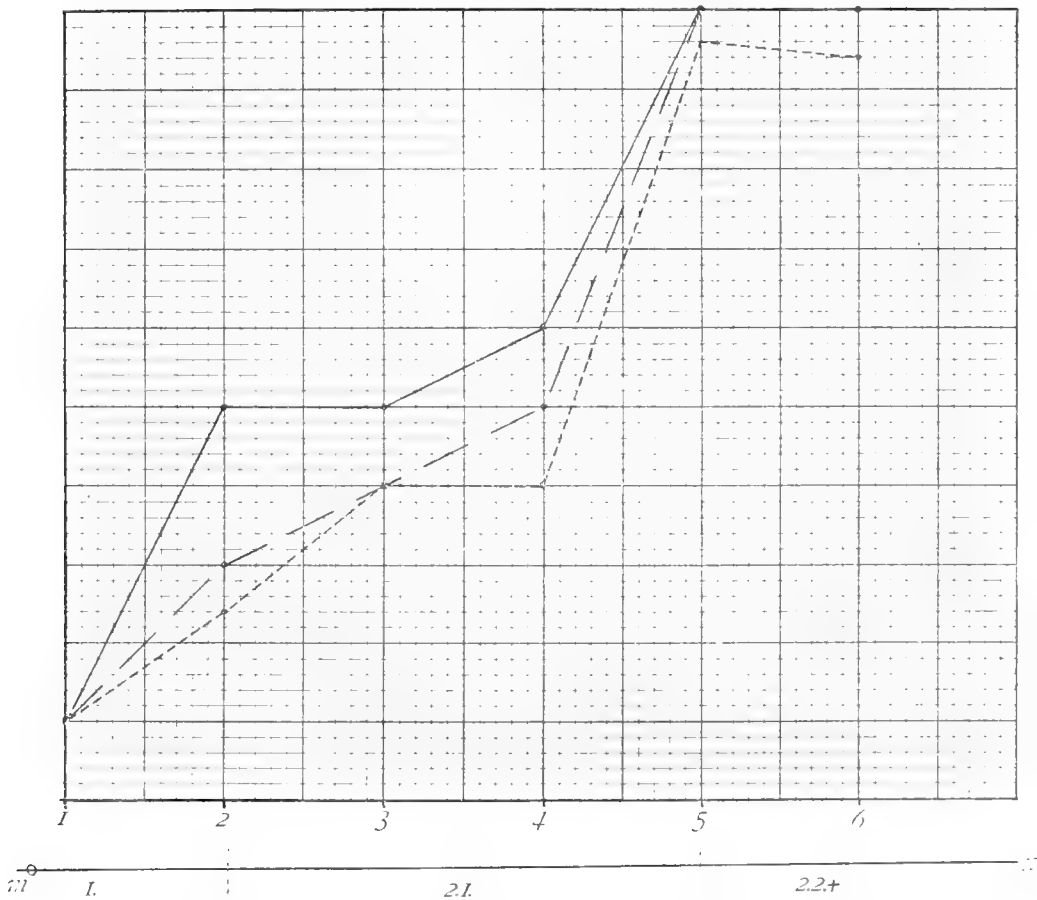

Fig. 23 Curves of regulation in postpharyngeal regions of worms of 18 to 20 mm. to show the existence of postpharyngeal zooids. Postpharyngeal region cut into six pieces. Ordinate represents number of pieces, abscissa the different levels of the postpharyngeal region at which cuts were made. The curve in unbroken line is the curve of reconstitution and includes all cases in which any approach to head formation occurred. The curve in long dashes is the curve of eye formation. The curve in short dashes is a 'summation' curve to show the different degrees of reconstitution at different levels. The line *mz* below the curves represents the axis of the postpharyngeal region; on it the approximate boundaries of the zooids are indicated and the lineage of the zooids given.

the numbers 1 to 6 indicate the position of the anterior ends of each of the six sets of pieces. The starting point of the curves at the left corresponds to the anterior end of the prepharyngeal region and their end at the right to the anterior end of the most posterior set of pieces. These curves then, like figs. 40 and 41 of the first paper of this series (Child, '11b) show the differences in certain results of regulation at different levels along the axis.

Of the three curves in the figure the one drawn in continuous line is what we may designate as the curve of reconstitution: its ordinates represent the number of pieces at each level or the body where a cut was made, that show any approach to head formation. It includes all except the headless pieces in the above table and serves merely as a general expression of the capacity of the pieces to initiate the process of reconstitution, or more specifically the process of head formation, which is, as I showed in the preceding paper (Child, '11f) the first step in reconstitution in such pieces.

The curve drawn in long dashes is the curve of eye formation: its ordinates represent the number of pieces at each level which form eyes, whether normal or abnormal.

The third curve drawn in short dashes is somewhat different in character and may for convenience be called the summation curve. As a basis for this curve each of the regulatory types in the table is assigned an arbitrary numerical value which is selected first with reference to the different degrees of approach to the formation of a normal head and second with reference to convenience in plotting the curve on the same scale as the others. The numerical values assigned to the different types are as follows:

Normal heads	5	Teramorphic.....	3
Teratophthalmic.....	4	Anophthalmic.....	1

In determining the length of the ordinate of the curve at each level each of these values is multiplied by the number of pieces at that level which show that type of regulation and the sum of all these products for the different types of pieces at any one level gives the length of the ordinate. In order to draw this curve on the same scale as the others each unit of the arbitrary values is

made to correspond to one of the small spaces of the cross section paper. Thus if all ten pieces at any level develop normal heads the ordinate of the curve at that level will equal fifty of the small spaces and will coincide with the ordinate of the curve of reconstitution and that of eye formation at the same level, both of which will equal ten of the large spaces. Referring to the table we see that the first ordinate of the summation curve is 5, the second 12, the third 20, etc.

This curve is merely an attempt to show to some extent the relative capacity of different regions to form heads. At one level, for instance, three pieces may form normal heads and the others remain headless while at another level perhaps three pieces produce anophthalmic forms and the others remain headless. If we count each of the three cases of normal head formation and each of the three anophthalmic forms merely as one, as in the curve of reconstitution in fig. 23 we take no account of the difference in degree of reconstitution. Three anophthalmic pieces do not represent the same capacity for reconstitution or for head formation as three normal heads. The summation curve then attempts to take account of the different degrees of reconstitution. It is of course purely arbitrary in character.

Examination of the curves in fig. 23 shows that the course of all three is in general similar. Each shows first a rise and then a decrease in steepness, then a second rise. In other words this series shows two levels in the postpharyngeal region where a marked increase in the capacity of pieces of a given length to form heads appears. I believe that these two levels indicate approximately the levels of the anterior ends of zooids. They correspond closely with the levels at which fission occurs in animals from the same stock and of the same length.

The absence of a fall after the second rise suggests that the extreme posterior region of these worms is in reality not a single zooid but rather a series of zooids too short to be distinguishable from each other in pieces of the length used in this series. If the posterior end consisted of but a single zooid we should expect the axial gradient (Child, '11b) in this zooid to appear in the most posterior set of pieces. The failure of this gradient to appear

suggests that there is at least one other head region posterior to the level of the second rise in the curves.

The line mx below the curves in fig. 23 represents the axis of the postpharyngeal region of the worms of this series drawn to the same scale as the curves, the mouth being at m . The two dotted lines drawn across this axis indicate the levels at which the steepness in the rise of at least two of the curves begins to decrease, i.e., they indicate approximately the two levels of greatest capacity of head formation in the postpharyngeal region. As regards the more posterior level the position indicated on the line mx is more or less arbitrary for at ordinate 5 all the curves rise almost to 100 per cent and none of them shows any appreciable fall posterior to that level.

The more anterior of these two levels coincides approximately with the level at which fission usually occurs in these worms and the more posterior level with that at which fission occasionally occurs in whole worms and very frequently in the posterior products of a preceding fission (Child, '10). All the facts taken together seem to me to indicate very clearly that these levels represent more or less exactly the anterior regions of two zoöids and that consequently the worms used in this series consist of at least three zoöids, the anterior, bearing the fully developed head, and two others posterior to it. The extreme posterior region may represent still another zoöid or more than one.

The impossibility of observing the origin of the zoöids directly prevents us from determining the lineage of the different zoöids with certainty, but the facts already at hand concerning the dominance of the head region and the distance factor and their relation to the degree of development of the head region make it appear at least probable that the two posterior zoöids have arisen by the physiological isolation of the posterior region of a single posterior zoöid rather than through the division of the anterior zoöid. If this inference is correct then the three zoöids present in these worms are 1., 2.1. and 2.2., as indicated in fig. 23. The probability that zoöid 2.2. has undergone still further division is indicated by the plus sign following the designation 2.2. in fig. 23.

Series 298. This series of ten worms was taken from a stock collected on November 21, 1910. At this season the temperature

of the water in which the worms live is so low that they are rather sluggish and their reactions are in general slow. In consequence of this and of the slow growth at such temperatures fission does not occur frequently, but the animals are still sufficiently active to feed. Because of these and other internal conditions to be discussed below the animals attain a much greater length under these conditions than at higher temperatures. From this stock as collected a hundred or more of the longest worms, 20 to 22 mm. in length were selected and placed in a dish, the bottom and sides of which were covered with a layer of vaseline. The vaseline serves to some extent to prevent fission for the animals cannot adhere to it as to a glass or metal surface and consequently the rupture of the tissues is impossible. The worms live perfectly well under these conditions and stocks have been kept for several months in such dishes.

These worms on vaseline were provided with an excess of food during twenty-six days and by that time some of them had attained a length of 25 to 30 mm. without fission. The postpharyngeal region was twice as long, or in a few cases more than twice as long as the prepharyngeal region.

If the increase in length is a factor in determining the formation of new zooids then the conditions in these worms are favorable for the formation of a larger number of zooids than in shorter animals.

On January 5, 1911, ten worms about 25 mm. in length were selected from this stock and the postpharyngeal region of each of these was cut into eight pieces as nearly as possible equal in length. The ten pieces corresponding to each level were placed together and the results of regulation recorded. These results are given in the following table, the sets of pieces being numbered 1 to 8 from the anterior end of the postpharyngeal region posteriorly.

PIECES	NORMAL	TERATOPHTHALMIC	TERATOMORPHIC	ANOPHTHALMIC	HEADLESS
1	0	0	0	0	10
2	0	1	0	5	4
3	0	1	1	2	6
4	8	2	0	0	0
5	0	0	0	3	7
6	0	0	0	3	7
7	2	2	1	2	3
8	10	0	0	0	0

The data given in this table are presented graphically in fig. 24. Here, as in fig. 23, three curves are plotted; the curve of reconstitution, drawn in continuous line and including all cases which show any approach to head formation; the curve of eye formation, drawn in long dashes and including all cases in which eyes of any sort appear; and the summation curve drawn in short dashes and plotted in the same manner as in the preceding series.

All three of these curves show certain resemblances. The curve of reconstitution shows three very strongly marked rises, of which the first is not as high as the other two. The summit of the first rise in this curve corresponds to a decrease in steepness at ordinate 2 in the summation curve, but the curve of eye formation does not show any summit at this level of the body. In all other respects the three curves correspond closely.

Fig. 23 shows then the presence in the postpharyngeal regions of these worms three distinct regions of increase in head formation: the first of these is less distinct than the others, the second is very strongly marked and is followed by an equally well marked fall, while the third is even more strongly marked than the second but is not followed by a fall. If these regions of increase in head formation represent the anterior regions of zoöids then these worms consist of at least four zoöids. As in fig. 23, there is no fall in that region of the curves which corresponds to the extreme posterior region of the body and this again suggests that this region consists of more than one zoöid.

The approximate levels of the different zoöids are indicated on the line *mx* below the curves in fig. 24 and their probable lineage is given. The designation 2.2.+ for the most posterior region and the arbitrary division of this region by the dotted lines merely serves to indicate the probable further division of this part.

The anterior region of the zoöid 2.1. corresponds to the most clearly marked maximum in the curves and it also coincides closely with the level at which fission usually occurs in these worms. It probably represents therefore the anterior region of the zoöid which is most advanced in development and that must be a descendant of zoöid 2., in this case 2.1. Posterior to zoöid 2.1. is at least one more zoöid which probably arose from the earlier physio-

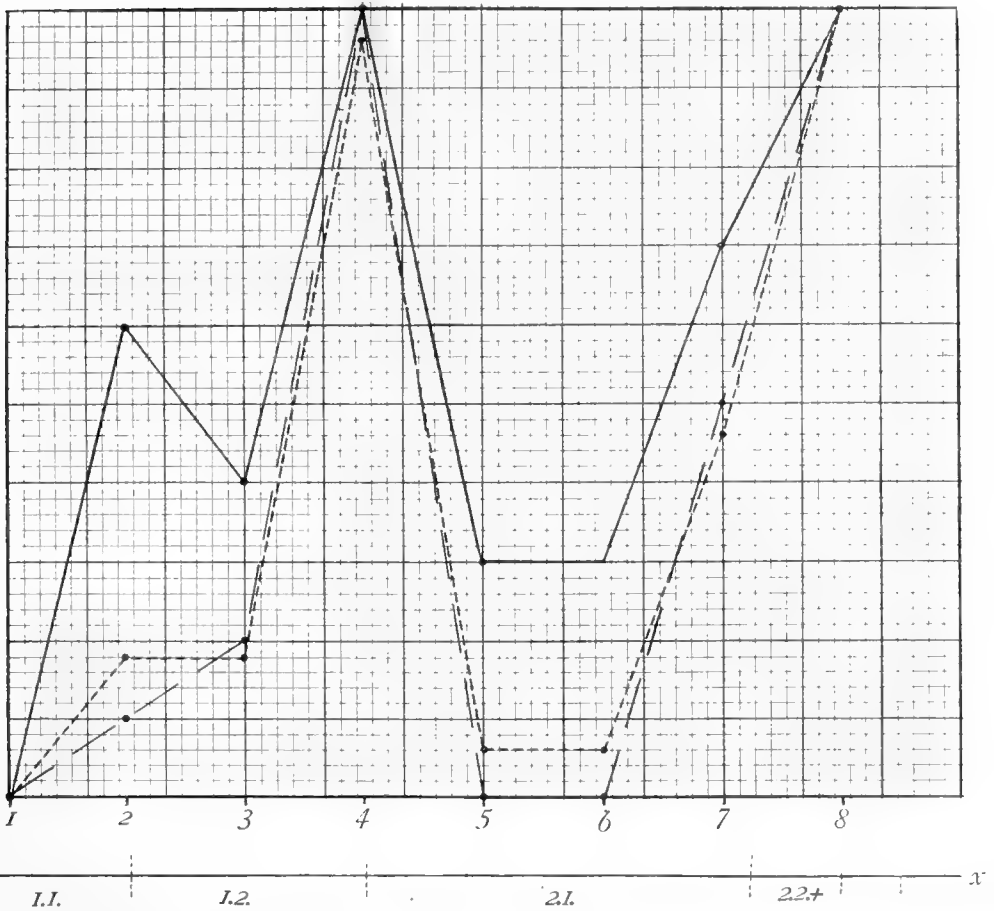

Fig. 24 Curves of regulation for postpharyngeal regions of worms of 25 mm.: eight pieces: all details as in fig. 23.

logical isolation of the posterior region of zoöid 2. And in this case we find still another zoöid indicated anterior to zoöid 2.1. This I regard as resulting from a new division of zoöid 1, and it is therefore designated 1.2. in fig. 24. The reasons for so regarding it are these: it is short and the increase in head formation which corresponds to its anterior region is less strongly marked than that corresponding to other zoöids. Both of these facts indicate that it is less advanced in development than the others and there-

fore has probably arisen later. Moreover, if the process of fission in Planaria follows the same general laws as in Stenostomum, and the probability is that it does, as I shall show below, then this lineage of the zoöids is what might be expected. The animal divides first into two zoöids: then, since in Planaria the posterior of these two does not undergo rapid development and differentiation as it does in Stenostomum, its posterior region soon becomes physiologically isolated as a third zoöid and this process continues as elongation goes on. Meanwhile the anterior of the first two zoöids has also elongated to some extent and since it possesses the fully developed head which is able to dominate a much greater length of body than the head regions of the posterior zoöids it attains a much greater length than these zoöids before its posterior region becomes physiologically isolated. Finally, however, it does become isolated and the development of zoöid 1.2. begins. This is the condition which I believe is represented in this series.

Series 297. The worms of this series were taken from the same stock as those of the preceding and at the same time. They were the ten longest worms among those which had been kept on vaseline. Their length was somewhat greater than that of the worms of Series 298, being 27 to 28 mm. In the present series the postpharyngeal region was cut into twelve pieces of equal length. The following table gives the results:

PIECES	NORMAL	THERATOPH- THALMIC	THERATO- MORPHIC	ANOPHTHALMIC	HEADLESS	DEAD
1	0	0	0	0	10	0
2	0	0	0	0	10	0
3	0	1	0	1	8	0
4	0	0	0	0	10	0
5	0	0	0	3	6	1
6	0	0	0	1	8	1
7	1	0	0	1	8	0
8	0	4	0	1	5	0
9	2	1	0	2	5	0
10	3	5	0	2	0	0
11	6	3	0	1	0	0
12	8	2	0	0	0	0

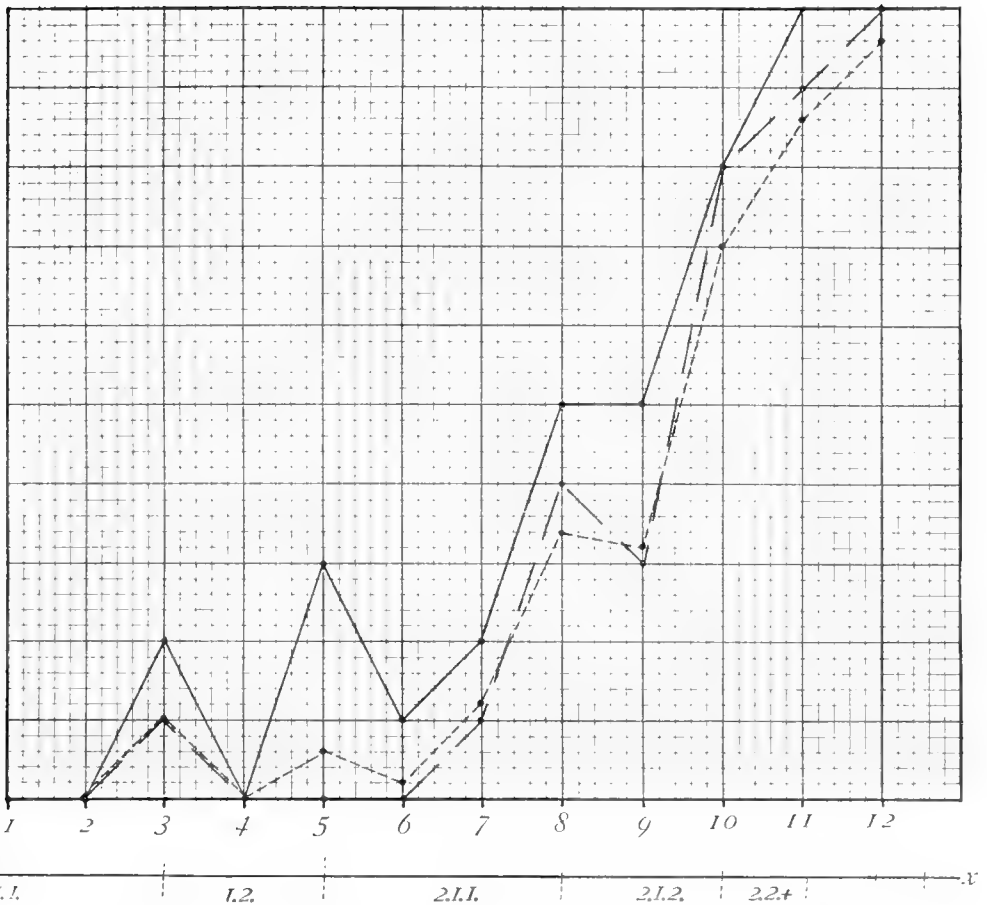

Fig. 25 Curves of regulation for postpharyngeal regions of worms of 28 mm.: twelve pieces: all details as in fig. 23.

In fig. 25 the three curves are plotted from these data in the same manner as in figs. 23 and 24. All of these curves show four distinct regions of increase in head formation. The first two increases correspond rather closely in position with the first two in fig. 24 and may doubtless be regarded as representing the anterior ends of the same zooids. The most posterior rise also corresponds closely in position to the last rise in fig. 24 and represents the region of the posterior zooid or zooids. But between these a:

ordinate 8 in fig. 25 the summit of another rise in the curves appears which is not present at all in fig. 24. This summit is only slightly marked and, if my conclusions are correct must represent the anterior end of a rather young zoöid, i.e., one recently formed. When we examine the line *mx* below fig. 25, on which these different summits are indicated, and compare it with *mx* in fig. 25 it becomes evident at once that the region corresponding to zoöid 2.1. in fig. 24 has divided in fig. 25 into two zoöids which must be 2.1.1. and 2.1.2. This is what we might expect since the worms of the present series are somewhat longer than those of the preceding, from which fig. 24 was plotted. Moreover, in fig. 24 zoöid 2.1. is longer than the other postpharyngeal zoöids and since its head region remains in an early stage of development its further division might be expected if it increased further in length.

We see then that the curves in fig. 25 indicate the presence of at least five zoöids in these very long worms. The extreme posterior region shows the same characteristics as before and suggests a division into a number of short zoöids.

Series 298 and 297 seem to me to confirm each other in a striking manner. The only difference between the worms of the two series is that those of Series 297 are slightly longer than the others and this series shows one more zoöid than the other. The levels of the anterior ends of the other zoöids correspond very closely in the two series and afford additional proof if such is needed that we are not dealing with mere chance differences in regulatory capacity or with differences due to unequal length of the pieces. Moreover the data from which the curves are plotted are not from single worms but from ten individuals in each case and the uniformity in the results constitutes a practical demonstration that we are concerned here with real physiological differences at different levels of the body. And finally, when we compare these data with those on the occurrence of fission at the different levels under natural and experimental conditions, there can I think be no doubt that these regions of increased capacity for head formation really represent the anterior ends of zoöids which have arisen in this region but which have not developed far enough to become visible.

In any comparison of fig. 23 with figs. 24 and 25 it must be remembered that fig. 23 is plotted from much shorter worms than the other two figures and the line *mx* in fig. 23 represents therefore a much larger scale of magnification than in figs. 24 and 25. The difference in scale between figs. 24 and 25 is slight.

If we accept the results of these series of experiments we must conclude that divisions occur in general more rapidly in the postpharyngeal zooids than in the anterior zooid with fully developed head. This difference is probably connected with the fact that the postpharyngeal zooids in *Planaria* remain at an early stage of development as long as their continuity with more anterior parts persists. Doubtless individual differences in the sequence of physiological isolations exist as they do in other forms which undergo fission in a similar way. Such differences are doubtless connected with differences in the dynamic activity of the various head regions, in the length of body over which these regions are dominant and in the rate of growth. Indications of these differences appear in the sequence of fissions in different cases. When very long worms like those of Series 298 and 297 undergo fission the first separation may occur at the anterior end of zooid 2.2. + and a second fission a day or two later at the anterior end of zooid 2.1. In case this zooid has already divided, as in fig. 25, into 2.1.1. and 2.1.2. these two zooids may separate later. On the other hand the first fission of the worm may occur at the anterior end of zooid 2.1. (2.1.1. in fig. 25) and the posterior product of this fission may divide later at the anterior end of 2.2. + or at the anterior end of 2.1.2. Separation between zooids 1.1. and 1.2. rarely or never occurs at the first fission of these worms, but after the other posterior zooids have separated zooid 1.2. sometimes separates without further feeding and growth, though in most cases this fission does not occur except after growth.

Incidentally the three series give us further data on the relation between length of piece and regulatory capacity (Child, '11b). This relation is particularly well shown in the difference in height of the summits of the curves in figs. 24 and 25. In the two series worms of almost the same total length were used and in the one (fig. 24) the postpharyngeal regions were cut into eight pieces, in

the other (fig. 25) into twelve pieces. Both the tables and the curves show that in the latter case the frequency of head formation is much less than in the former.

6. THE FACTOR OF DISTANCE IN THE FORMATION OF NEW ZOÖIDS AND ITS RELATION TO THE STAGE OF DEVELOPMENT OF THE DOMINANT REGION

In *Planaria* the new posterior zoöid remains at an early stage of development until separation occurs, consequently the boundaries of the different zoöids do not become visible as they do in the *Microstomidae* and in various annelids which undergo fission. It is therefore impossible to determine the exact position of the anterior ends of different zoöids or the exact sequence of their formation.

But if we combine the facts obtained by inducing fission in various ways (Child, '10) with the results of experiments like those described in the preceding section it becomes evident that the formation of new zoöids in *Planaria* takes place according to a definite law.

If the formation of a new zoöid at the posterior end of an individual or another zoöid in *Planaria* is the result of the physiological isolation of the region concerned from the dominant head region then two factors must determine when and where new zoöids shall form. These two factors are, first: the length of body which the head region is capable of dominating and second the rate of growth.

As regards the first of these factors, we find that the length of body which the head region is capable of dominating is by no means a constant quantity, but differs at different stages of development and under different physiological conditions. In general this length increases as development proceeds, at least up to a certain point. Figs. 26, 27 and 28 in which the boundaries of the posterior zoöids are indicated in animals of 5, 12 to 14 and 28 mm. show this very clearly. In fig. 26 the young animal of 5 mm. has already divided: as a matter of fact, it is possible to induce fission in animals not much larger than this (Child, '10) and below the limit where fission occurs the behavior of pieces

from the postpharyngeal region in regulation shows very clearly that a second zoöid is already present there. In the animal of 12 to 14 mm. (fig. 27) the anterior zoöid has about doubled its length but has not divided again, while the posterior zoöid, although much shorter than the anterior, has already divided. In some cases, and especially if growth is slow, this division of the posterior zoöid does not occur until the worms are somewhat longer than this, but in all cases, so far as my observations go it occurs before the division of the anterior zoöid. In worms of 28 mm. (fig. 28) the anterior zoöid has divided again, but the anterior product of this division, zoöid 1.1. is three times as long as the whole worm in fig. 26. Evidently the length of body over which the head region is dominant increases greatly during development. In the posterior zoöids, on the other hand, where the head region remains at an early stage of development the zoöids divide at lengths which correspond much more closely to the length of the young animal at the time of its first division.

The facts indicate clearly then that an extension of the dominance of the head region over parts posterior to it occurs during development in *Planaria*. Physiological isolation of the posterior end is therefore possible in much shorter animals in early stages of development than in later stages.

Turning to the second factor in the formation of new zoöids, the rate of growth, it is evident that the rate at which growth in length occurs will determine the rate at which divisions occur. But the question at once arises as to whether the rate of extension of dominance always coincides with the rate of growth in length. The facts indicate that it does not. My own observations on normal worms show very clearly that the slowly growing animal attains a much greater length without division than the one which is growing rapidly. By inducing very rapid growth fission can be made to occur in the natural way and without special stimulation in animals of 12 to 14 mm. or even shorter, while animals kept under conditions where growth is slow often attain a length of 25 mm. without fission. In general, the higher the rate of growth the shorter the animal when it divides. At the time my paper on physiological isolation and fission in *Planaria* (Child, '40)

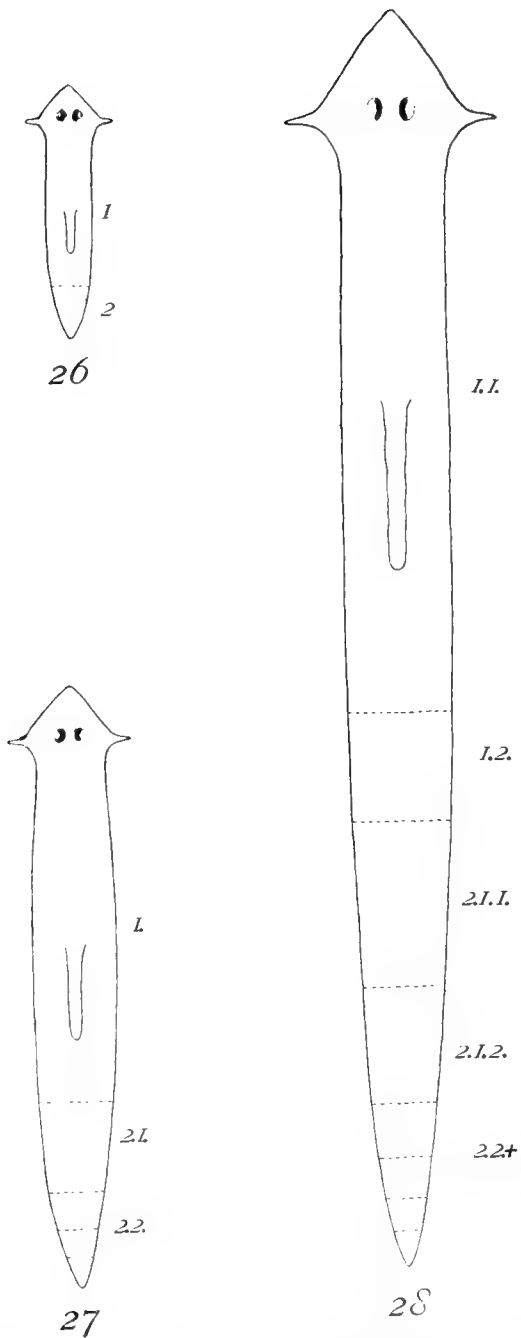

Figs. 26-28 Worms of different length, showing approximate position and number of zooids. Fig. 26, 5 mm., two zooids. Fig. 27, 14 mm., at least three zooids. Fig. 28, 28 mm., at least five zooids.

was written I had not recognized this fact clearly, although some of the data at hand at that time point to such a conclusion.

This fact is of great importance for the understanding of the process of formation of new zooids, not only in *Planaria* but in other forms as well. It means that an individual or a zooid does not necessarily attain either a certain constant length or a certain stage of development before it divides. It may divide at any length above a certain minimum or at any stage of development and the lengths and stage of development at which it does divide depend upon the relation between the rate of extension of dominance and the rate of growth in length and this is determined by the conditions under which the individual or zooid is living. With a high rate of growth in length division occurs in shorter animals and at an earlier stage of development; with a lower rate of growth the animals attain a greater length and a more advanced stage of development before dividing, and when the rate of growth is very low they may attain a maximum size without dividing at all, for under such conditions the rate of extension of dominance may keep pace with the rate of growth in length until the limit of growth is attained.

To sum up: the facts as regards division in *Planaria* are these: first the length which the individual or zooid attains before it divides varies with the stage of development of its anterior dominant region and second, the higher the rate of growth in length the less the length attained before division and vice versa. These facts are readily accounted for by the hypothesis that the rate of growth in length and the rate of extension of dominance are not necessarily identical. According to this hypothesis division may occur at any length above a certain minimum and at any stage of development, according to the relation between the rate of growth and the rate of extension of dominance. In *Planaria* division does occur in individuals and zooids of very different length and in very different stage of development but this hypothesis accounts for all the facts and I believe we cannot account for them in any other way. The question as to how and why the extension of dominance occurs during development is one of considerable interest and we shall return to it below after a brief review of the process of fission in *Stenostomum*.

In *Stenostomum* and *Microstomum* and in various annelids chains of zooids arise in much the same manner as in *Planaria* and in those forms the morphological differentiation of the zooid as a new individual takes place while it is still in organic continuity with more anterior regions and each zooid becomes visible at a very early stage of its development. Some years ago, in connection with experiments on regulation I devoted considerable time to a study of the process of division in *Stenostomum* most of the results of which have not as yet been published. Since the

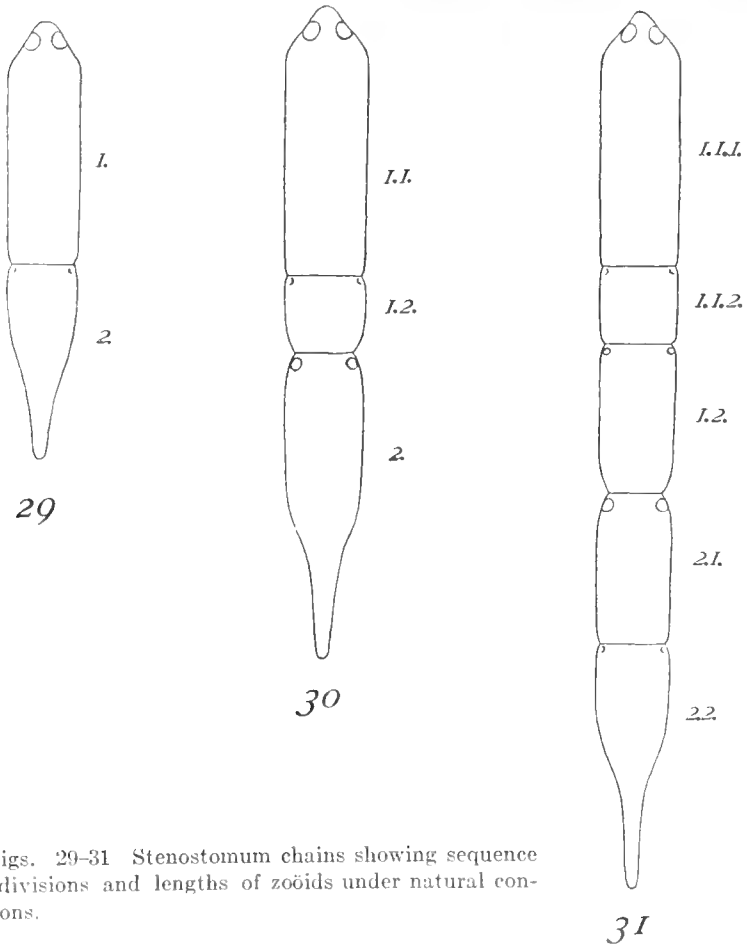

Figs. 29-31 *Stenostomum* chains showing sequence of divisions and lengths of zooids under natural conditions.

process of division in this form is in many respects similar to that in *Planaria* and since the visibility of the zoöids makes its analysis less difficult a brief comparison of the two forms will serve to bring out some points of interest. In general the same law holds for both forms, although certain differences exist.

In *Stenostomum* the first division of a single individual occurs in the posterior region of the body as indicated in fig. 29. There is more or less variation in the level of the fission plane in different individuals at the time of its first appearance, but in well fed animals at a temperature of about 20° C. and with sufficient oxygen the first fission plane appears posterior to the middle. After its formation both zoöids increase in length and in the second division the anterior zoöid, zoöid 1., with fully developed head divides into a long anterior zoöid, 1.1. and a short posterior zoöid, 1.2. (fig. 30). Somewhat later zoöid 2. divides into two zoöids nearly equal in length (2.1. and 2.2., fig. 31). Comparison of figs. 30 and 31 shows that the anterior products of these two divisions are unequal in length, the zoöid 1.1. (fig. 30) with fully developed head being much longer than zoöid 2.1. (fig. 31) in which the head region is not fully developed, while zoöid 2.2. (fig. 31), even without including the slender tail, is longer than zoöid 1.2. (fig. 30). In the third series of divisions the anterior zoöid with developed head again attains a greater length than others before division although its division precedes the division of other zoöids in time and in this third division it once more divides into a long anterior and a short posterior zoöid (fig. 31, 1.1.1. and 1.1.2.). Zoöid 1.2. (figs. 30 and 31) divides next into nearly equal parts (fig. 32, 1.2.1. and 1.2.2.). Moreover, this zoöid in which the head region is still at a rather early stage of development divides when its total length is much less than that of the anterior zoöid with fully developed head. The figures show this point clearly: the combined length of zoöids 1.2.1. and 1.2.2. in fig. 32 is much less than that of the anterior zoöid of the chain at any stage, and the difference between the anterior product of this division (1.2.1., fig. 32) and the zoöid 1.1.1. in the same figure or zoöid 1.1. in fig. 30 or even zoöid 1. in fig. 29 is striking.

The next zoöid to divide in the third series of divisions is zoöid 2.1. (fig. 31). Its total length when it divides is greater than that of the zoöid anterior to it (zoöid 1.2.) but less than that of the most anterior zoöid of the chain. Moreover, zoöid 2.1. divides into a longer anterior and a shorter posterior part (fig. 32, 2.1.1. and 2.1.2). The development of the most posterior zoöid of a chain is always slow and the third cycle of divisions does not usually occur in this zoöid until after separation at the fission plane between zoöids 1.2.2. and 2.1.1. (fig. 32) has occurred. Occasionally, however, and under certain conditions its division occurs somewhat earlier. In fig. 33 a case of this kind is shown. This zoöid, zoöid 2.2. of figs. 31 and 32, has divided in fig. 33 into zoöids 2.2.1. and 2.2.2. and of these the anterior is shorter than the posterior, or if we exclude the tail they are of about the same length.

After the separation of the chain into two parts further divisions continue to occur in the same way. The figures of *Stenostomum* chains are all drawn from measurements made with a micrometer. The length of the *Stenostomum* chain when extended is fairly constant and with a little practice measurements can be made with a considerable degree of accuracy. In any case there is no room for doubt that the differences in length of the zoöids in the figures are not in any way connected with errors of measurement. These differences can be seen without the slightest difficulty in any chain undergoing division under normal conditions. My measurements were made merely for the purpose of avoiding possible exaggerations and other errors which might result from the freehand drawing of figures. In the zoöids of *Stenostomum* the ciliated pits, which are shown in the figures serve very well as an index of the stage of development of the head region, for their development is closely associated with that of the cephalic ganglia, which are the most essential part of the head. In figs. 29 to 33, instead of drawing in the cell masses of the ganglia and the developing pharynx which are clearly visible in the living animals and which were shown in the drawings made in my notes, I have used the ciliated pits alone as an index of the stage of development of the head.

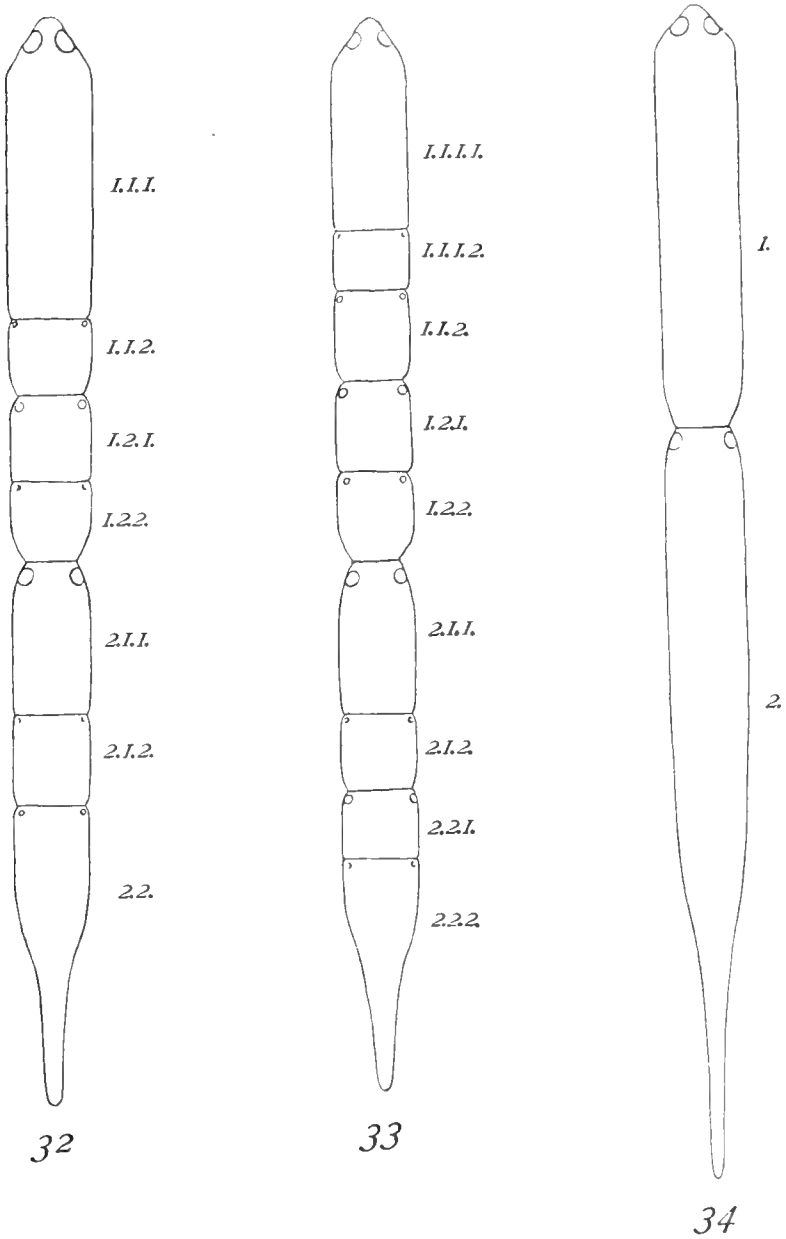

Figs. 32-34 Stenostomum chains showing sequence of divisions and lengths of zooids. Fig. 32, natural conditions. Fig. 33, heavy feeding. Fig. 34, low temperature.

This brief review of the sequence and the positions of the different divisions brings out certain facts of importance. In the first place we see that the more advanced the development of the head region of any zoöid the greater the distance between this head region and the new head which arises by the division of the zoöid. An examination of the figures will show that this is true for all zoöids and for all divisions. Stating this fact in other words, we may say that in any pair of zoöids resulting from division of a single zoöid, the length of the anterior member of the pair is proportional to the degree of development of its head region.

Furthermore, a comparison of the posterior zoöids of the different pairs shows that the posterior products of division differ in length at the time of their appearance very much less than the anterior products (fig. 29, 2.; fig. 30, 1.2.; fig. 31, 1.1.2., 2.2.; fig. 32, 1.1.2., 1.2.2., 2.1.2.; fig. 33, 1.1.1.2., 1.1.2., 2.1.2., 2.2.2.). As a matter of fact we do find that the posterior member of the most posterior pair in a chain (fig. 29, 2.; fig. 31, 2.2.; fig. 33, 2.2.2.) is always somewhat longer at its first appearance than the posterior member of the most anterior pair (fig. 30, 1.2.; fig. 31, 1.1.2.; fig. 33, 1.1.1.2.). This difference is due in part to the fact that the posterior zoöid tapers to a long slender tail at its posterior end, but even if the tail is left out of consideration the most posterior zoöid is longer than the posterior member of the most anterior pair in the earliest stages. Examination of a very larger number of chains has convinced me that the differences in length between these two zoöids are merely the extreme terms of a graded series along the axis of the chain. In other words, the length of the posterior member of a pair of zoöids at its earliest visible stage increases as its distance from the anterior end of the chain increases. It is somewhat difficult to attain certainty concerning this point, for the zoöids begin to increase in length as soon as they are formed and it is necessary to exercise great care in selecting only the very earliest stages or like stages of development for comparison. My notes include a large number of measurements of chains which were made before my attention was called to this point and in these the difference in length of newly formed posterior members of pairs at different levels appears so frequently

that I cannot doubt that it really exists. Fig. 33, in which the posterior members 1.1.1.2., 2.1.2. and 2.2.2. appeared almost simultaneously shows this difference clearly: of these three zooids 1.1.1.2. is the shortest, 2.1.2. is next in length and 2.2.2. is the longest.

If this fact means anything it means that the minimal length of a region which is capable of forming a new individual when physiologically isolated from the dominant region increases with increasing distance from the anterior end of a chain. In the course of my experiments on the regulation of pieces of *Stenostomum* I found that the minimal length of pieces capable of giving rise to new individuals when physically isolated by section was almost exactly the same as the length of these posterior members of pairs at their first appearance. Moreover, the comparison of pieces from different regions of chains indicated that under constant external conditions the minimal length of such pieces was somewhat greater in posterior than in anterior regions of the chain, that is, at more posterior levels a somewhat longer piece is necessary for the formation of a whole than at more anterior levels. This statement I make with some reserve for the difference is not sufficiently great to make the conclusion certain. If it is correct then the results obtained from the study of natural division are in complete agreement with the results of experiment with isolated pieces and both indicate the existence of an axial gradient similar to that in *Planaria*, though much less strongly marked.

Another fact of interest in this connection is that in *Stenostomum* growth in length occurs more rapidly in anterior than in posterior zooids. In general the rate of increase in length in the zooids of a chain decreases from the anterior end of the chain posteriorly. This is shown by the fact that any particular cycle of divisions begins in the most anterior zooid and the division of the other zooids follows in order. This sequence of divisions is shown in figs. 29 to 32. Occasional deviations from this order occur in nature or may be produced experimentally. In fig. 33, for example, which represents a chain that was heavily fed, the sequence is less strongly marked than usual. In this chain

the anterior zoöid is in advance of all others as is usual and the anterior half of the chain is in advance of the posterior half, though less so than usual, but in the posterior half the last two divisions have occurred almost at the same time, as indicated by the stage of development of the posterior members of the two pairs. Usually the more anterior of these two divisions occurs considerably in advance of the other. The usual sequence of divisions, which is connected with the rate of increase in length also indicates the existence of an axial gradient of some sort, apparently quantitative.

These facts concerning division in *Stenostomum* show that in this form as, in *Planaria*, division of an individual or a zoöid may occur at very different stages of development and at very different lengths above a certain minimum. The *Stenostomum* zoöid does not necessarily attain either a certain stage of development or a certain length before dividing. Moreover *Stenostomum* affords an ocular demonstration of the extension of dominance with advancing development. In every pair of zoöids resulting from division of a single zoöid, the length of the anterior member of the pair is proportional to the stage of development of its anterior end. This can only mean that the more advanced the development of the anterior region of a zoöid the greater the length of body which it is capable of dominating. In *Stenostomum*, however, the head region of the original individual completes its development and growth before fission begins, consequently the length of the most anterior zoöid of a chain remains approximately constant and no extension of dominance occurs. Figs. 29 to 32 illustrate this fact. Fig. 33 is not strictly comparable with the others because the chain in this case developed under conditions which produced a somewhat different zoöid-length. In *Planaria*, the head continues to increase in size long after division begins and in correspondence with this fact we find that the length of the anterior zoöid in *Planaria* increases greatly during growth. We are certainly justified in concluding that in *Stenostomum* as in *Planaria* the occurrence of division depends upon the relation between the rate of increase in length and the rate of extension of dominance.

But the processes of division differ in certain respects in the two forms: in *Planaria* the posterior zooids do not develop morphologically to the point of becoming visible so long as they remain in continuity with more anterior parts, while in *Stenostomum* morphological development is very rapid and is practically complete when separation occurs. And secondly, we have seen that in *Planaria* the posterior zooids apparently precede the anterior, at least in most cases, in division, while in *Stenostomum* the sequence is the reverse. I believe that both of these points of difference between the two forms are connected with a difference in the relation between the rate of increase in length and the rate of extension of dominance.

In the first place, it was pointed out above (p. 257) that the occurrence of actual fission in *Planaria* is favored by rapid growth. Rapidly growing animals undergo fission when much shorter than the length at which fission occurs in those that are growing slowly and successive fissions follow with greater rapidity in the former than in the latter. When growth is very slow in *Planaria* the animals may attain more than twice the usual length and may be maintained at that length indefinitely without the occurrence of fission, although the isolation of pieces in series according to the method described in the preceding section shows that a number of zooids may be present in such animals. These facts indicate that when the rate of growth is slow the rate of extension of dominance may more nearly keep pace with it and so prevent the physiological isolation of posterior regions from reaching the stage at which the independent motor reaction and consequent separation of the posterior zooid. Very frequently one sees in these very long worms of slow growth what appear to be abortive attempts at fission. The region of the posterior zooid attaches itself to the substratum, i.e., a motor reaction of a certain degree of independence does occur, and the anterior zooid pulls against the resistance to advance which is thus produced. But as the attempts of the anterior zooid to pull itself away become more violent the posterior zooid usually relaxes its hold before separation occurs and begins to behave as if under the control of the anterior zooid, i.e., its further movements are coördinated with those of the

latter. My interpretation of such cases is that the region of the posterior zoöid is physiologically isolated from the anterior under ordinary conditions of activity, but that the impulses connected with the violent attempts of the anterior zoöid to pull itself away increase in intensity and effective distance until they finally bring the posterior zoöid into coördination once more. Actual fission occurs only when even these impulses fail to overcome the independence of the posterior zoöid. Apparently then, not only the formation of zoöids in *Planaria* but their development to the stage where separation is possible depends upon the relation between the rate of growth and that of extension of dominance.

In *Stenostomum* posterior zoöids often show independent motor reactions at comparatively early stages but the consistency of the tissues is apparently such that rupture does not occur until morphogenesis at the fission plane is well advanced. Moreover, in *Stenostomum* the rate of growth is very rapid as compared with that of *Planaria* under the most favorable conditions and I believe that the chief differences between the two forms are connected with this fact. In *Stenostomum* physiological isolation of the posterior region of a zoöid or individual and the redifferentiation of this region into a new zoöid occur so rapidly that the process is completed before less rapid extension of dominance brings the region to a greater or less degree under the control of the old head region. In *Planaria*, on the other hand, the degree of physiological isolation is sufficient to initiate the process of zoöid formation but before this has advanced very far it is at least retarded and perhaps inhibited by the extension of dominance. The posterior zoöids in *Planaria* then are not as completely physiologically isolated as they are in *Stenostomum*, consequently their development does not proceed beyond a very early stage until actual separation occurs and if growth is slow they may even be prevented from reaching the stage where separation is possible.

If these suggestions are correct it should be possible to inhibit or accelerate division in *Stenostomum* as it is in *Planaria* by altering the rate of growth. I have found that it is possible to do this in various ways. I hope to describe my experiments along this line more fully at another time: for the present a few facts will

suffice. The simplest method of inhibiting the formation of new zoöids in *Stenostomum* is by keeping the animals at low temperature. Fig. 34 shows a chain of two zoöids which developed from a stage like fig. 29 at a temperature of 10 to 15° C. The length of the zoöids is very much greater than the usual length, as a comparison with figs. 29 to 32 shows. When this animal was removed to a higher temperature the new zoöids produced were of the usual length, and fission planes appeared in the zoöids that had developed at the low temperature. Similar differences can be produced by regulating the food supply, though this method is less satisfactory than the temperature method, for the animals are voracious feeders and it is difficult to adjust the food supply to the proper amount so that growth shall be retarded but not entirely inhibited. On the other hand, animals which are very heavily fed show accelerated division, i. e., division is not only more frequent but the zoöids do not attain so great a length before dividing. Fig. 33 shows a case of this sort. The total length of the chain in fig. 33 is not greater than that in fig. 32, but more divisions have occurred in fig. 33. The anterior zoöid has begun the fourth cycle of divisions and the third cycle has occurred in the posterior zoöid and all the zoöids between are more advanced in development than in fig. 32. Moreover the difference is strikingly shown in the difference in length of the anterior zoöid of the chain. This is much shorter in fig. 33 than in fig. 32. Under like conditions the length of this zoöid remains fairly constant as is shown by figs 29 to 32. These cases are sufficient to show that it is possible to inhibit or accelerate division in *Stenostomum* as in *Planaria* by altering the rate of growth. Theoretically it should be possible, if my conclusions are correct to induce the morphological development of zoöids in *Planaria* by accelerating the rate of growth, provided it is possible to accelerate it sufficiently. I have shown above that we can control the degree of development of the posterior zoöids in *Planaria* to some extent by altering the rate of growth, but as yet I have not attempted to push the acceleration of growth to its limit.

The second point of difference in the process of division between *Stenostomum* and *Planaria*, viz., the different sequence of divi-

sion, is, I think connected with the first. Since the posterior zoöids in *Planaria* remain at an early stage of development after their formation, in consequence of the extension of dominance from the anterior zoöid, the length of body which their own head regions can dominate is not great and does not increase to any great extent. Therefore, as growth occurs these zoöids will divide while still short and even if the rate of growth in them is the same as in the anterior zoöid they will precede it in division. Thus the sequence of division in *Planaria* is due primarily to the retardation or inhibition of the development of the posterior zoöids after their formation.

In many of the annelids the process of formation of new zoöids is very similar to that in the flatworms and, so far as my observations go, follows the same laws. In these forms also the relation between the rate of growth in length and the extension of dominance determines the occurrence of division. In some cases the extension of dominance reaches a limit early in others late and these differences determine differences in the localization or sequence in different forms. Doubtless various other conditions, such as advancing senescence which may lead sooner or later to a decrease in the length of body over which the head region is dominant (Child, '11a, '11c) also play a part in some cases. In all cases, however, the new zoöid forms in consequence of the physiological isolation of some part, however that may be brought about.

In the present section the extension of dominance has served to account for various facts. In conclusion some suggestions as to how and why it occurs are perhaps not out of place. As regards the fact that the length which a zoöid attains before division is under constant conditions proportional to the degree of development there can, I think, be no doubt. It is the question as to why this should be so that we have now to consider. According to my conception the extension of dominance is similar to the phenomenon of "Bahnung" in the nervous system of higher forms. As the zoöid develops the paths of correlation undergo a 'functional adaptation' to the passage of impulses. This means simply that the passage of impulses over them alters them in some

way so that later impulses pass more readily or to a greater distance. If the impulse consists of a transmitted chemical change the functional adaptation of the path may mean simply an increasing uniformity of constitution which determines that less of the energy of the chemical change is lost in other reactions which have nothing to do with transmission. Moreover, the dominance of the head region in the turbellaria is undoubtedly largely dependent in postembryonic stages upon the nervous system. The extension of dominance is probably therefore largely a matter of the development or "wearing" of paths along the nerve cords. In the higher forms the rate of such processes falls far behind that of growth and there is every reason to believe that it does so here.

7. THE DISAPPEARANCE OF ZOÖIDS IN CONSEQUENCE OF DECREASED DISTANCE FROM A HEAD REGION

In *Planaria* it is possible to bring about the disappearance of a zoöid already formed by inducing the development of a head near its anterior end. If for example, the postpharyngeal regions of long worms like fig. 28 are isolated by section at the level indicated by *a* in fig. 35 the pieces become new wholes like fig. 36 with normal heads and eyes and with pharynges lying at first anterior to the middle. In this process of regulation the first two zoöids posterior to the cut disappear for they come under the control of the new head region and undergo redifferentiation into the prepharyngeal and pharyngeal regions of the new individual. If the body is cut into a series of pieces after regulation is completed we find that these regions are similar to the prepharyngeal and pharyngeal regions of other individuals and that no trace of the previously existing regions of increased head formation which marked the anterior ends of the zoöids remains.

But the more posterior zoöids, those posterior to *o* and *p* in fig. 35 may continue to exist since they are farther away from the new head and fission may even occur before the new head develops far enough to control them. In pieces of this kind fission at the levels indicated by *o* and *p* in fig. 36 is of frequent occurrence while the new head is still young, but if fission does not occur at

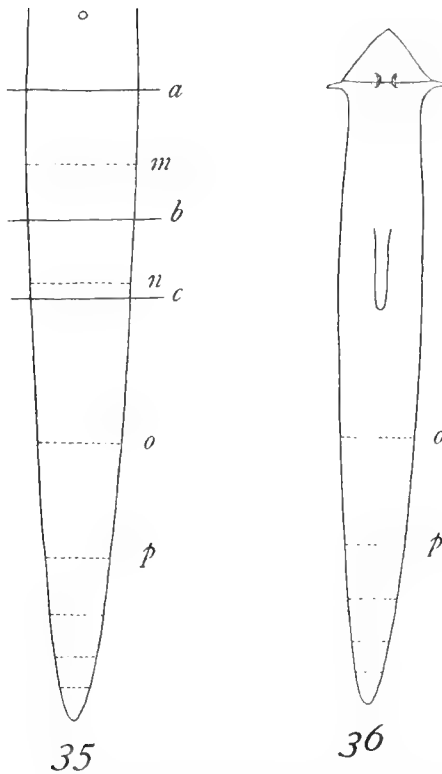

Figs. 35 and 36 Fig. 35, diagram of postpharyngeal region of long worm showing zoöids and different levels of section. Fig. 36, regulation of region posterior to level *a* in fig. 35: the more anterior zoöids are obliterated but the more posterior remain.

that time it never occurs unless the animals are fed and growth occurs. In the same way any other zoöid can be made to disappear or its separation prevented.

In *Stenostomum* the results of such an experiment are different. A new head does not develop near the anterior end of a zoöid which is already visible, but the posterior zoöid brings about the resorption of the headless region anterior to it (Child, '03). This difference is due to the fact that the development of the zoöid is more advanced in *Stenostomum* than in *Planaria* and it becomes dominant over the whole piece before a new head can develop

at the anterior end. If we should use pieces of *Stenostomum* containing only zoöids at a stage where they were not yet visible we could probably bring about their elimination as in *Planaria*.

The results of a series of experiments on inhibition of fission in *Planaria* also serve to show the influence of the new head.

Series 380. I. Fifty pieces including the region posterior to the level *b* in fig. 35; these were cut from well fed worms about 20 mm. in length possessing two or three well marked zoöids in the postpharyngeal region.

II. Fifty pieces from similar worms but including the region posterior to the level *c* in fig. 35.

Sets I and II differ only in that the new head forms in Set II at a slightly less distance than in Set I from any zoöids which may be present in the posterior region of the pieces. Fissions occurred in the two sets as follows:

	NUMBER OF PIECES	ONE FISSION	SECOND FISSION	UNDIVIDED
I.....	50	46	2	4
II.....	50	25	0	25

Most of these fissions were at the level *o* in fig. 35, but in at least two cases in Set I fission occurred first at the more posterior level *p* and then again at *o*. The smaller number of fissions in Set II can be due only to the fact that the new head developed at a shorter distance from the zoöid concerned and so prevented its separation. These experiments demonstrate clearly enough the importance of the factor of distance in the dominance of a head region over more posterior parts. By altering the distance between the anterior end of a zoöid and a head region we can determine either the continued existence of the zoöid and its final separation or its redifferentiation as a part of the new animal.

8. CONCLUSION AND SUMMARY

In the present paper I have attempted to show that the formation of new zoöids in *Planaria* is the result of physiological isolation of posterior regions of the body from the dominant head

region. If my conception of the process is correct the formation of new zoöids is not essentially different from the process of regulation of pieces into wholes after physical isolation. In *Planaria* the development of the zoöid beyond a certain stage is prevented so long as continuity with more anterior parts persists, but this is merely a matter of the degree of physiological isolation. In many other forms, e.g., *Stenostomum*, the development of new zoöids proceeds almost as if they were physically isolated.

I believe the idea of physiological isolation will prove very useful in accounting for the phenomena of reproduction in both animals and plants. It must be remembered, however, that the distance limit of dominance and the degree of physiological isolation are dependent upon dynamic processes and undoubtedly vary from moment to moment. There is no fixed limit of dominance: the limit is undoubtedly greater for powerful than for weak impulses. In other words the very long planarian, consisting of several zoöids is undoubtedly more nearly a single individual when it reacts very strongly to some stimulus than when it reacts only slightly. We must regard the limit of dominance as continually changing in the living organism, nevertheless it changes within certain limits. As the length of the individual or zoöid approaches the limit a critical period must occur during which the posterior region is sometimes physiologically isolated to a certain degree and at others more completely a part of the original whole. During the times of greater isolation the processes which would lead to reproduction if continued may begin, only to be inhibited and their effects removed by a change in the limit of dominance. As the periods of greater isolation become longer or more frequent with increasing length or with any change in conditions which leads to a more permanent decrease in the limit of dominance, the processes which lead to the formation of a new zoöid continue during longer periods or occur more frequently and the new zoöid begins to acquire a more permanent character. Sooner or later it becomes a continuously existing system and there is no doubt that after a certain stage it opposes a certain degree of resistance to the impulses which reach it from the dominant region, i.e., its receptivity is changed (Child, '11a). It might almost be said

to have acquired a certain momentum. What has probably occurred is that new correlations have been established and the minuter structure has by this time been so far altered by the changed processes that it cannot return at once to its original condition. In this way the new system gradually emerges from a part of the old. The process is undoubtedly not a continuous one in its early stages but a series of oscillations to and fro between greater isolation and more complete subordination. Even after the new system has become what may be called continuously existing it is not necessarily completely isolated. Extreme conditions may bring it more or less completely under the control of the old dominant region either temporarily and only occasionally or perhaps permanently. But under ordinary conditions its independence gradually increases, still with many oscillations to and fro until finally the changes in the structure become great enough to be visible. Here the visible morphological development begins, but even this may be retarded or inhibited, or under extreme conditions the whole process may be reversed by the influence of the old dominant region. Reproduction in consequence of physiological isolation is not then a simple continuous process but rather a series of oscillations. The new zoöid may be clearly defined dynamically before any evidence of morphological development can be discovered: as I have shown, this is the case in *Planaria*.

The continued oscillation between subordination and physiological isolation may be a very important factor in determining the development of a zone of structural weakness between the new zoöid and other parts. The frequent changes in the correlative factors to which this region is subjected may lead to degeneration of its structure so that rupture occurs more readily there than elsewhere.

The relation between the rate of growth and the rate of extension of dominance which was discussed in Section VII seems to me to be a factor of great importance in determining the sequence of the formation of zoöids and the stage of development attained before division occurs. The formation of new zoöids is most likely to occur in animals where the rate of growth is high as

compared with that of extension of dominance. In a given species under normal conditions it is more likely to occur in young animals where growth is rapid than in old animals with a slower rate of growth, although, as I have shown elsewhere (Child, '10, '11a) it may be induced experimentally by decreasing the dominance of the anterior region.

The formation of new zooids in *Planaria*, as well as in *Stenostomum* affords further evidence in support of the conclusion reached in the preceding paper (Child, '11f), viz., that in each of these relatively simple organisms there is one characteristic or fundamental morphogenic reaction which occurs in every isolated mass of the specific protoplasm that is capable of continued existence and synthesis, provided its rate of reaction is sufficiently high. The morphological result of this reaction is the formation of an anterior or distal end.

Experimental data to be described later will show that the rate of reaction is a very important factor in morphogenesis. In order actually to form a distal or anterior region the isolated mass must not only remain alive but the dynamic processes going on within it must maintain or exceed a certain minimal rate. Moreover, it is possible to determine great differences in morphological structure, e.g., the teratophthalmic, teratomorphic and anophthalmic heads, by changes in conditions which have primarily a purely quantitative effect.

If we accept the conclusions reached in this and earlier papers of the series; it follows that the formation of new zooids in *Planaria* is essentially a process of regulation resulting from physiological isolation as the regulation of pieces results from physical isolation. I believe that most if not all forms of asexual reproduction are fundamentally similar in character (Child, '11a).

Moreover, it seems entirely unnecessary to assume the continuous existence of any sort of 'germ plasm' in connection with such processes. The germ plasm of *Planaria* is the specific reaction complex which leads to the formation of a head region and in *Tubularia* the germ plasm is the reaction complex which leads to hydranth formation, or more strictly to the formation of the distal region of a hydranth. There is not the slightest reason to

suppose that this reaction complex is continuously existent, for the assumption that a mass of protoplasm may react in one way at one time and in another at another time certainly presents no greater difficulties than the assumption that a specific chemical substance may go through one series of reactions under certain conditions and through a different series under other conditions, and this we know to be a fact. In such a case we do not regard it as necessary to assume that the specific substance is continuously present in all these reactions. In the case of the organism it seems much more logical and certainly more in accord with the facts to believe that germ plasm arises *de novo* from somatic plasm every time dedifferentiation occurs in consequence of altered correlation or other conditions. It is not necessary that the dedifferentiation should be complete in every case, the new development need not start at the very beginning. A dedifferentiation of any degree is merely a more or less close approach to the fundamental dynamic system of the species. In fact, when we think of life in dynamic instead of in static terms the conception of germ plasm as a continuously existing entity becomes really impossible. And finally, that conception does not help us in any way to understand or interpret the phenomena or the processes of development, it rather makes them more difficult to understand and all so-called interpretations based on this conception are simply paraphrases of the facts observed.

The group of cells which gives rise to a head in a piece of *Planaria* seems to me to constitute as truly a germ as does the egg cell. In fact the chief difference between the egg and these cells is that the egg is so highly differentiated and physiologically so old (Child, '11c) that a special stimulus from without is necessary before it can dedifferentiate into germ plasm, while in the pieces of *Planaria* the dedifferentiation follows automatically upon physiological or physical isolation. In short the piece of *Planaria* is in reality much nearer the condition of a germ plasm than is the egg before fertilization.

According to my conception, the process of reproduction involved in the regulatory formation of a head and so of a new whole in *Planaria*, a new hydranth in *Tubularia* or a new bud in a plant

is a much simpler and more primitive form of reproduction than the sexual form. In such simple forms of reproduction the problem of heredity appears in its simplest terms and the process of inheritance itself becomes accessible to investigation.

The chief points of the paper are summarized as follows:

1. In pieces of *Planaria* possessing a large, fully developed head and below a certain length a second zoöid does not appear at the posterior end except after feeding and growth, but in headless pieces of the same length and under the same conditions the second zoöid appears at once and often another zoöid forms and fission may occur.

2. If teratophthalmic, anophthalmic or headless pieces are fed so that growth occurs they attain a certain length far below that of the normal animal under the same conditions and then undergo fission and this process is repeated indefinitely. In general the teratomorphic pieces attain a greater length before fission than the anophthalmic and these a greater length than the headless pieces. The second zoöids arising from such pieces produce normal animals and do not inherit the characteristics of their parents.

3. In starvation in normal animals the second zoöid or the posterior zoöids gradually come again under the control of the dominant head region as the length of the animal decreases and in the later stages of starvation they may almost entirely disappear. In starving headless pieces, on the other hand, the posterior zoöid or zoöids maintain themselves at the expense of the more anterior headless region.

4. *Planaria dorotocephala* often consists of four or five or more zoöids which arise in definite relations to each other.

5. In *Planaria* and *Stenostomum*, as well as in various other forms the distance from the head region in any zoöid to the head region of the new zoöid arising at the posterior end of the old increases as the development of the anterior head region advances, at least up to a certain stage.

6. The formation of new zoöids and fission are favored by rapid increase in length. In slowly growing animals division not only occurs less frequently than in rapidly growing, but the zoöids attain a greater length before dividing.

7. It is probable that the paths of correlation in the dominant region and between this region and other parts undergo a 'functional adaptation' during development. In Planaria and related forms nerve paths are undoubtedly largely concerned in this process, which is similar to the 'Bahnung' observed in the nervous systems of higher forms. In consequence of this change in the paths of correlation an extension of the dominance of the anterior region occurs during development and the length of body over which the anterior region is dominant increases with advancing development up to a certain stage.

8. The relation between the rate of growth and the rate of extension of dominance determines whether and where new zooids shall be formed and whether they shall undergo morphological development after their formation. According to this law a zooid or an individual may divide at any stage of development or at any length within certain limits.

9. Zooids already formed can be made to disappear in Planaria or their further development and separation can be prevented by decreasing the distance between them and a dominant head region.

10. The formation of new zooids in Planaria, Stenostomum and various other forms is essentially a process of regulation resulting from physiological isolation of parts, just as the formation of new wholes from pieces results from physical isolation.

11. The 'germ plasm' of Planaria is essentially the specific dynamic system that gives rise to a head region, whether this is contained in a single cell or in a mass of cells. Such a system may arise *de novo* wherever sufficient dedifferentiation occurs and there is absolutely no reason for assuming that this system is continuously existent in all parts of the planarian body which are capable of forming a head.

12. The form of reproduction in which a new whole, beginning with the dominant region is formed from a part in consequence of physiological or physical isolation is a relatively simple and primitive mode of reproduction as compared with the sexual type, in which the egg is so highly differentiated and so old, except in cases of parthenogenesis, that a special stimulus from without is necessary to initiate the process of dedifferentiation. In such

simple forms of reproduction the process of inheritance itself is accessible to investigation.

BIBLIOGRAPHY

- CHILD, C. M. 1903 Studies on regulation. III. Regulative destruction of zoöids and parts of zoöids in *Stenostomum*. Arch. f. Entwicklungsmech., Bd. 17.
- 1910 Physiological isolation of parts and fission in *Planaria*. Arch. f. Entwicklungsmech., Bd. 30 (Festband für Roux), Teil II.
- 1911a Die physiologische Isolation von Teilen des Organismus. Vortr. u. Aufs. ü. Entwicklungsmech., H. 11.
- 1911b Studies on the dynamics of morphogenesis and inheritance in experimental reproduction. I. The axial gradient in *Planaria dorotocephala* as a limiting factor in regulation. Journ. Exp. Zoöl., vol. 10.
- 1911c A study of senescence and rejuvenescence based on experiments with *Planaria dorotocephala*. Arch. f. Entwicklungsmech., Bd. 31.
- 1911d Experimental control of morphogenesis in the regulation of *Planaria*. Biol. Bull., vol. 20.
- 1911e The regulatory processes in organisms. Journ. Morphol., vol. 22.
- 1911f Studies on the dynamics of morphogenesis and inheritance in experimental reproduction. II. Physiological dominance of anterior over posterior regions in the regulation of *Planaria dorotocephala*. Journ. Exp. Zoöl., vol. 11, No. 3.
- SCHULTZ, E. 1904 Über Reduktionen. I. Über Hungererscheinungen bei *Planaria lactea*. Arch. f. Entwicklungsmech. Bd. 18.
- 1906 Über Reduktionen. II. Über Hungererscheinungen bei *Hydra fusca* L. Arch. f. Entwicklungsmech., Bd. 21.
- 1907 Über Reduktionen. III. Die Reduktion und Regeneration des abgeschnittenen Kiemenkorbes von *Clavellina lepadiformis*. Arch. f. Entwicklungsmech., Bd. 24.
- 1908a Über Reduktionen. IV. Über Hunger bei *Asterias rubens* und *Mytilus* bald nach der Metamorphose. Arch. f. Entwicklungsmech., Bd. 25.
- 1908b Über umkehrbare Entwicklungsprozesse und ihre Bedeutung für eine Theorie der Vererbung. Vortr. u. Aufs. ü. Entwicklungsmech., H. 4.

ON THE BEHAVIOR OF THE DISSOCIATED CELLS IN HYDROIDS, ALCYONARIA, AND ASTERIAS¹

H. V. WILSON

From the Zoological Laboratory of the University of North Carolina and the Beaufort Laboratory of the U. S. Bureau of Fisheries

THIRTY FIGURES

INTRODUCTION

1

It is known that monaxonid sponges may be broken into their constituent cells and these will recombine to form restitution masses which have the power to transform into perfect sponges (Wilson, '07b, '11b; Müller, '11). Several kinds of cells enter into the composition of these masses, not only the indifferent or totipotent amoebocytes, but also differentiated elements. What is the fate of the latter elements? Do they undergo a process of de-specialization, passing into an indifferent or totipotent state, in which they persist as part of the restitution mass when it begins to transform? Or are they incorporated and digested by the amoebocytes? In general terms, in the development of such masses does regressive differentiation of cells into an indifferent condition play an important part? The large number of amoebocytes, at any rate in the monaxonida, makes it difficult to decide this question in the case of sponges.

It seemed that a study of the coelenterates might throw light on the matter. In the hydroids we have two tissue layers, ectoderm and entoderm, and a comparatively small amount of material corresponding to the totipotent amoebocytes of sponges. The question was formulated: if all the anatomical connections

¹Published with the permission of Hon. Geo. M. Bowers, U. S. Commissioner of Fisheries. The experimental work was carried on at the Beaufort Laboratory of the U. S. Bureau of Fisheries during the summer of 1910. Brief mention of the results has already been made (Wilson, '11a; '11b).

and physiological interrelationships, due to position, between the cells composing the hydroid layers, were broken up, would the cells recombine and form masses of totipotent regenerative tissue?

Experiments were conducted on two hydroids, *Pennaria tiarella* and *Eudendrium carneum*. The phenomena were essentially the same in the two forms. The hydroid or, in one experiment, the coenosarc only was cut into small fragments and these were pressed through gauze (fine meshed silk bolting cloth). The flesh is thus broken up into cells and small cell aggregates. Fusion between these begins quickly and large masses are produced which exhibit a slow amoeboid change of shape. Continued fusion goes on with the formation of massive lumps of tissue or in other cases of sheets. The size and shape of such masses are under control. These bodies acquire a smooth surface and secrete a perisarc within about one day. They are solid and of a syncytial structure, although cell bodies are here and there marked out. During the two or three days following their formation, the bodies are subject to great mortality. Many isolated masses or nodules of larger masses, however, remain alive and differentiate ectoderm and endoderm layers, together with a central yolk mass, much as in the case of a coelenterate planula. These now send out cylindrical coenosarcular outgrowths which under favorable conditions continue to grow and produce well formed hydranths. Such hydranths appear to be normal. In the case of *Pennaria* they developed both the characteristic sets of tentacles and were equal in size to the smaller subapical hydranths of the adult, and were of about the same size as hydranths obtained from metamorphosing planulas. In *Eudendrium* also hydranths of adult size with the characteristic hypostome and number of tentacles were obtained in this way.

We apparently have here in the hydroids a plain case of the despecialization of tissue elements and their union to form masses of totipotent regenerative tissue. The indifferent elements which give rise to the sex cells or in some forms to buds (Braem, '08) are practically absent in the coenosarc, and yet as experiment shows the coenosarcular tissue will give rise to the restitution masses. After their sudden and violent separation the coenosarcular cells are

spheroidal and without vacuoles, whereas in the hydroid itself they are in some measure vacuolated and provided with outgrowths which probably all interconnect. This change in appearance is perhaps correlated with a change in physiological state whereby they pass as a result of the shock and isolation into an indifferent condition, in which condition they unite to build up the restitution mass. The mass differentiates like a planula, the outer stratum becoming the ectoderm, while the inner mass gives rise to an entoderm and material that is used up as food. After the several kinds of cells unite to form the restitution mass, they undergo changes and it becomes impossible to trace them. It is conceivable that some degree of specification persists and that elements derived originally from the ectoderm migrate in the mass until they reach the region of the surface, while the elements derived from the entoderm shift towards the interior of the mass. However, I find no facts in support of this idea, and it seems to me extremely improbable.

I conceive then that in the formation of the hydroid restitution masses the phenomenon is essentially one of regressive differentiation. The cells of the hydroid layers perhaps as a result of isolation, perhaps in part as a result of the shock, pass quickly into a simplified indifferent state. The restitution masses of sponges are so like those of hydroids that in them too regressive differentiation of tissue elements probably plays a great part.

2

It may be anticipated that there are other animals besides sponges and hydroids in which the somatic cells when forcibly disjoined, will fuse and give rise to totipotent regenerative material. Perhaps where the body cells in general have not this power, it may still be possessed by comparatively undifferentiated amoebocytes in such forms as ascidians. And it is possible that the sex cells in some animals before they have progressed too far in their special differentiation, may possess this power. From these standpoints a few observations were made on the common alcyonarian *Leptogorgia*, and on the immature gonads of the starfish, *Asterias*.

For *Leptogorgia* it was shown that when short pieces of the colony are pressed through cloth as before, or simply squeezed under water with forceps, small lumps of tissue and isolated cells are pressed out. An active fusion goes on between all these, with display of amoeboid phenomena. Masses are thus formed which become more or less spheroidal and acquire a smooth surface. By bringing together the smaller ones, bodies of considerable size up to and over 1 mm. in diameter may be produced. These bodies remained alive in laboratory dishes for many days, but exhibited no metamorphosis.

In the case of *Asterias*, immature gonads about an inch long were cut up and pressed through gauze. Abundant cells and cell masses were thus obtained, which fused actively forming reticulated plates and massive lumps. These soon acquired a smooth surface. They remained alive in laboratory dishes for a couple of days, but underwent no further change.

Experience in the handling of regenerative sponge masses suggests that possibly in the case of the aleyonarian the fusion masses might metamorphose if transferred to the harbor water. It seems incredible that anything in the shape of an individual could come from the fused germ cells of *Asterias*, however probable this might be in the case of a coelenterate. On the other hand, where the mass of cells is unable to give activity to the regenerative power when removed from the body fluids to water, it might conceivably display regenerative power, in some degree, if replaced in a proper body. Perhaps in some animals it might give rise to a bud individual, or under other conditions become merged into the tissues of the locality, or die gradually in some process of absorption, or be extruded as something foreign, or finally pass into one of the categories of tumors. From this point of view, an experiment was started to determine what the *Leptogorgia* balls, above described, would do if replaced in the *Leptogorgia* body. The experiment which must be regarded as no more than a tentative one is described farther on in the paper.

3

Some facts concerning the regressive differentiation of cells have long been familiar. The choanocytes of fresh water sponges for instance, it is known since the time of Lieberkühn's investigations ('56), give up during the winter their distinctive features and assume the character of mesenchyme elements. Metschnikoff observed the same phenomenon in marine sponges that were kept in foul water ('79). The flagellated chambers in both these cases again developed with the return of proper conditions, but there is no reason to suppose that the same cells that once were choanocytes again became transformed into such elements. It is possible, of course, that this is so, in which case the de-specialization of the choanocytes is partial and temporary, and a complete return to the indifferent (totipotent) state of the typical amoebocyte is not made. On the other hand it is certainly possible that the choanocytes do retrogress into this state, from which they ontogenetically arise in the gemmule development of the spongillidae and at any rate in a percentage of individuals in some cases of larval metamorphosis (Wilson, '94; Evans, '99). A third possibility, that they are used up as food material, must also be considered, until more intensive investigation settles the question.

The idea of a thorough going de-specialization of cells into indifferent elements underlay the older account of the origin of gemmules in the spongillidae, according to which the gemmule is made up of the transformed cells, of all kinds, located in a region of the sponge body. More precise investigations have shown that the spongillid gemmule and some other asexual reproductive bodies in sponges (*Tethya* buds, e. g., Maas, '01) arise as a congeries of similar mesenchyme cells. The origin of these cells especially in cases where the sponge body degenerates, is a matter of physiological interest, and deserves to be better known. It is not impossible, as I have said ('07b, p. 252) that they are "groups of amoebocytes which are in part recruited from transformed collar cells and other tissue cells, such as pinacocytes (flat cells of canal walls), that have undergone regressive differentiation into an unspecialized amoeboid condition." Maas ('10, p. 124) more recently advances the same idea.

In recent times the question of the de-specialization of cells has become a prominent one. Some pathologists as is well known believe this occurrence to be at the bottom of tumor formation. And in regenerative phenomena of many kinds it has been shown that cells lose their specific features, become less specialized, and re-acquire a capacity for new differentiation. Schultz reviews numerous cases in his essay on reduction ('08). In none of the instances, however, which he records as occurring in animals is there an obvious assumption of the totipotent character. Possibly this occurs in certain tumors and in the case of *Moniezia* reported by Child ('06). In *Moniezia* muscle cells lose their fibrillae and become spermatogonia, and it may be that this behavior is to be interpreted as a return to the totipotent character followed by a subsequent differentiation into sex cells. In the well known case first described by Driesch ('02) and again studied by Schultz ('07) where the excised branchial sac of ascidians is remodelled into the condition of a stolon bud, which then transforms into a small ascidian, the cellular metamorphosis stops short in its backward path before the condition of totipotent regenerative tissue is reached. In the reduction of starving hydras studied by Schultz ('06), the hydra body is greatly simplified, becoming a mouthless spheroidal sac. But in this sac the two layers, ectoderm and entoderm, persist, and although some of the cells assume an embryonic appearance, there is no obvious metamorphosis of cells into totipotent regenerative tissue. Still one striking feature of this case of reduction, is the great development of sex cells (male) which increase in number and ripen while the body in general dwindles, and it is conceivable that here, as in *Moniezia*, we have the transformation of cells into indifferent elements which then differentiate into male germ cells. In the reduction of hydra, the spheroids eventually degenerate and die. They do not undergo a regenerative awakening as in the case of the ascidian branchial sac. And this in turn may be due to the differentiation of the indifferent elements, as fast as they are formed, into germ cells.

In a case of reduction in the coelenterates which is not recorded by Schultz, there would appear to be extensive de-specialization of cells. I refer to the observations of Perkins on the larva

of the medusa, *Gonionema* ('02). Perkins observed that the hydra-like larvae of *Gonionema* after they had been for some time in an aquarium retracted their tentacles and became transformed into shapeless masses which had the power to throw out pseudopodia and creep about. In such plasmodial bodies the original differentiation into layers and even cells appeared to be lost, while the nuclei remained visible scattered unevenly through the substance. These bodies continued alive for two months and underwent repeated fission until owing to their diminution in size it became impossible to follow their history. It is possible that under favorable conditions these masses would have behaved like the restitution bodies of *Pennaria* and *Eudendrium*, and once more have developed the normal structure of the species.

Regressive differentiation of cells undoubtedly occurs in sponges when owing to confinement or abnormal chemical environment the body gradually breaks down into masses of regenerative material. I have recently ('11b) touched upon the question as to whether in these instances the de-specialized cells persist as part of the regenerative tissue. The latest accounts (Maas, '10; Müller, '11b) indicate that while the choanocytes are absorbed, other de-specialized cells persist.

4

Eugen Schultz in a series of papers ('04, '06, '07, '08) discusses a variety of phenomena which he groups under the head of 'reduction.' Under this head he classifies such simplifications of structure as the normal cyclical loss of gonads and associated organs in *Planaria* (Curtis, '02), the loss of organs and cellular changes in starving planarians, the changes occurring in starving hydras that have been referred to, and the remodelling of the ascidian branchial sac into the condition of a stolon bud. While it is not clear, as Schultz admits, that all of these simplification processes should be regarded as belonging in one category, a consideration of them and of other cases leads Schultz to conceive of a phase in the life history of organisms which may or may not

occur according to circumstances. To this phase he applies the term, reduction, and he conceives of it as an inverse process to ontogeny. Under unfavorable circumstances a simplification process may set in, in the course of which differentiations that were acquired during ontogeny are given up in inverse order. Such an orderly retrogressive course of events may, like ontogeny, be disturbed by coenogenetic adaptations. In this process, the organism acts as a whole, that is the course of reduction is determined not by a struggle for existence between the different kinds of cells, but rather the needs of the entire organism dictate what structures shall be sacrificed. The behavior of the organism in reduction is thus looked on as an adaptive response. What there is of new and old in these ideas, is sufficiently stated in Schultz's essay ('08).

Schultz's theory of a reduction process may be applied to the behavior of sponges which give up their organization under the influence of confinement (Wilson, '07a; Müller, '11b) or abnormal chemical environment (Maas, '06). In the monaxonid *Stylorella*, for instance, I have found ('07a) that the oscula and the bulk of the pores close, much of the canal system is suppressed, the skeletal arrangement is simplified, and the flagellated chambers for the most part broken up into their constituent cells which become scattered in the mesenchyme. At any time the sponge may be made to reassume its normal differentiation on transfer to better conditions. The passage of the body into this simplified condition, which is essentially like the winter state of some spongillidae (Weltner, '93), is obviously an adaptive response on the part of the whole sponge, which thus protects itself against the bad water of the aquarium, as the spongillid does against extreme cold. Moreover this simplified state is very similar to a stage in the metamorphosis of such a mass of totipotent regenerative tissue as a sponge gemmule. In them both we have a simple flat epithelial covering layer and an internal mass, which in the case of the gemmule is composed of indifferent amoebocytes and in the case of the 'reduced' sponge is largely so composed. Or again it is much like the 'pupal' stage (just after fixation) of those larvae of silicious sponges in which amoeboid cells split up to

form the choanocytes.² The stage then may fairly be looked on as repeating an embryonic stage that actually occurs, whether or no it be a coenogenetic modification of the more typical (palingenetic) course of development.

In the later history of this behavior of sponges in confinement, etc., the sponge ceases to act as an individual. It breaks up either with (*Stylotella*) or without (*Calcarea*, *Spongillidae*) considerable death into numerous masses of totipotent tissue. If we are to apply the reduction theory here we must assume that owing to coenogenetic adaptation, the sponge body does not continue to dwindle and simplify itself until it reaches the condition of an egg, or an individual heap of blastomeres, or a single gemmule-like mass of totipotent cells. This would entail a tremendous loss of substance and altogether is a process which it is foolish to contemplate as a possibility. In the backward development of the sponge, coenogenesis prevents a too strict adherence to the

²Maas in his recent study ('10) of the cellular changes involved in the breaking down of a sponge body into masses of regenerative tissue, views the phenomena from a standpoint not strictly that of the reduction-theory. This is not the place for a discussion of Maas' standpoint, but I may mention that he debates the question as to whether a fundamental similarity exists between late stages in the reduction of sponges and the 'pupal' stage in ontogeny and decides there is none, because in the former the interior is chiefly made up of amoebocytes and in the latter of immigrated ectodermal cells destined to become directly transformed into choanocytes. There are still a good many unsolved problems concerning the behavior of the layers in sponge ontogeny, and among these, if we accept the current view that the choanocytes typically arise from the ciliated covering cells of the larva, is the relation between the typical pupae and those in which the interior is chiefly filled with amoebocytes, or as I have called them 'formative cells' ('94), which divide up and form the choanocytes. My account ('94), it seems to me, established the fact that such pupae are exceedingly common in certain species of monaxonida, so common that I regarded them as typical. There is no doubt that in my work of that time the bulk of the sponges reared came from pupae of this sort. Evans in studying spongillas several years later found ('99) that the choanocytes not infrequently arose in this way, as I and writers before me had described in detail. The occurrence of such pupae cannot be passed over as pathological, and if we keep them in view instead of the type which is densely filled with small cells, the similarity between the pupal stage and the reduced sponge is obvious. Maas has some comments on larvae of this type in *Sycons* ('10, p. 105), and is inclined to believe that they are to be looked on as individuals in which the amoebocytes have actually incorporated and digested the immigrated ectodermal elements.

path over which the organism has come, by setting into activity a process of division. The sponge body in the simplified condition above described may conceivably divide up again and again until very small masses result which then go over the last steps of reduction, transforming themselves each into a single embryo-like heap of totipotent cells. Or the division may stop when the masses resulting therefrom are still of considerable size. Or a division of far-reaching extent may take place which consists in the breaking of all ties, anatomical and physiological, between the component cells. Such a process would result in the virtual dissolution of the sponge body into an enormous number of independent cells, and these, or such as could, might then go through the last phases of reduction becoming totipotent. In the actual behavior of the sponges all these varieties of the division process are associated together in a complex and over-lapping fashion.

When the division process leads to the production of independent cells, these wander about on or through the old skeleton and are attracted to one another or to masses of reduced tissue, and so unite to build up or aid in building up such masses. This is a useful habit to such cells. In the body of an animal, since by hypothesis they are totipotent, they might conceivably through growth and division give rise to a group large enough to transform into an organism of that species. But out of the body or cut off from the possibility of growth, their only hope for life would lie in fusion. Only so could they give rise to organisms. The habit of fusion displayed by these elements being useful may have been acquired. More probably it has been preserved as an inheritance from early ancestors.

In the retrograde differentiation of organisms it is conceivable that there might be a difference in the path followed according as to whether the individual had its origin in an asexual mass or in an egg. Schultz in passing suggests ('07) that possibly some difference might be found between the reduction process of ascidians derived from eggs and buds. Following out the logic of the theory we should expect in the one case to find stages resembling the free larva and egg, in the other case no such stages. But

such a difference seems one too good to be hoped for—coenogenesis would surely not allow the oozoid to go back through the complications of tadpole larva and egg development. Even with lower forms, sponges and coelenterates, it is incredible that the path of reduction would ever lead through the stage of the ciliated larva to an egg, which by virtue of its egg nature, in contrast with that of a simple totipotent cell, would again in its upward differentiation develop into a ciliated larva! It is indeed highly probable that coenogenesis would usually take care, in animals capable of asexual development that reduction should lead to the formation of bud-like or in other cases gemmule-like anlagen rather than to the production of eggs and sperm. The idea is that the bud with its quick development or the gemmule-like anlage made up of totipotent regenerative cells, unhampered by a tendency to retrace the path of phylogenesis and free to develop at once into an organism, would present a great advantage over an egg to an animal seeking, so to speak, to restore itself.

It may be seen then that with some use of the coenogenesis idea it is possible to view the whole set of retrogressive changes undergone by sponges in confinement or under abnormal chemical conditions as reduction phenomena. Schultz's theory it seems to me enables us to get a better picture of the facts as a whole than is possible without it. Müller evidently entertains the same opinion, since he classifies ('11b) the changes in the spongillidae under the caption of reduction.

5

In the preceding section, it has been shown that the gradual breaking down of a sponge body into small masses and eventually, in part, into independent and indifferent cells may be thought of as a case of reduction, as a return to an embryonic condition. When we compare with such phenomena the forcible breaking down of a sponge or hydroid into elements which can live independently for a time and which unite to build up new organisms, it would seem that we have in these elements the same end result that is reached in the comparatively slow process of reduction.

The mechanical division of the flesh and the attendant stimuli (shock) apparently, in the case of the pressed out tissue, bring on the final stage at once.

The same facts may be viewed from a somewhat different standpoint if we confine ourselves within the narrower limits of physiology. Child has just published an interesting essay ('11), the kernel of which is the idea that when a part of an organism becomes physically or physiologically isolated, there is a tendency for it to develop into a new whole, provided it has the power of complete regulation or in other words, is made up of totipotent material. (By physiological isolation, Child means the condition in which the part is cut off, through one cause or another, from the exchange of stimuli which maintain that mass of material as an individual organism.) Such a statement well covers the facts of the pressing experiments and the reduction of sponges, provided, (1) we remember that the cells as they exist in the stem of the hydroid, for instance, are not at the time totipotent, but only become so by retracing their development; and provided, (2) we employ the category of tropisms for the union of the dissociated cells to form masses.

Finally it may be of interest to consider the question, does any phylogenetic significance attach to the power of an organism to break up into small bits of indifferent protoplasm which then recombine? Did the early ancestors of existing animals practise such habits, which in modified form have proved useful and so have been retained? It is at least possible that the early organisms were amorphous masses of protoplasm. Assuming this, it is plain how useful the power of easy, quick division might be, from how many dangerous situations an organism might escape which had the power to break up into parts, these retreating from the situation independently, leaving perhaps dead or dying tissue—a "*sauve qui peut*" proceeding in short. But when we consider the difficulties besetting the life of very small plasmodial masses of this kind,³ it is also plain how useful would be the power to fuse with one another. We may then conceive of these early

³ I have found that the very small plasmodial masses of sponges are at a disadvantage ('07, p. 257).

ancestors as creatures amorphous in shape and inconstant in size. According to local conditions and needs of the moment, the body divided or fused with a corresponding mass. The behavior of the totipotent cells which we have been considering may, for speculative purposes, be considered as a survival of such primitive habits.

EUDENDRIUM. RESTITUTION FROM DISSOCIATED CELLS

Species used. The common Eudendrium of Beaufort harbor is *E. carneum* Clarke (Mem. Bost. Soc. Nat. Hist., III, no. 4, p. 137; Nutting, '01, p. 333). The most striking characteristic of the species concerns the arrangement of the male gonophores, which are "four or five chambered, borne in a verticil around the body of aborted hydranths which are themselves joined to pedicels bearing ordinary hydranths, the two being thus borne in pairs symmetrically disposed on the branches" (Nutting).

Experiment July 9. A clean male colony was chopped up with scissors into pieces about 3 mm. long and a mass of such pieces pressed through gauze in the usual way: the mass was laid on a square of gauze, and the latter folded to make a sac, which was immersed in a watch glass of sea water and squeezed repeatedly with fine forceps. The hydroid flesh streams through the pores of the gauze and falls on the bottom as a fine sediment. A little is sucked up with a pipette and examined on a slide. It consists of isolated cells and minute cell masses with some larger fragments. The latter are picked out. Fusion is observed to go on under the microscope. The tissue is now transferred to watch glasses of fresh sea water in which it is shaken towards the center with the purpose of facilitating the fusion process, and the watch glasses are immersed in large bowls of water. Within a few hours time fusion in the watch glasses leads to the formation of irregularly lobed flattened masses, varying from a fraction of a millimeter to about 5 mm. in diameter with a thickness of 1 mm. or less. Such masses exhibit slow changes of shape. All the masses of any considerable size are later in the day carefully picked out with a large pipette and transferred to fresh sea water. On sub-

sequent days they are transferred in this fashion three times a day. An effort is made to keep them clean and free of the bottom. On the day after their formation the surface of all these masses is smooth and a thin perisarc is to be seen round many of them.

On July 13, some of the masses have begun to transform. In fig. 1 is shown one of the smaller from which an outgrowth has sprouted. The perisarc round the outgrowth, *c s.*, is thinner than round the original mass, and in the outgrowth the ectoderm and entoderm are clearly distinguishable in the living object. The base of the body representing the original mass appears in life uniformly opaque. A number of the flattened larger masses are in the condition shown in fig. 2, which represents a part of a mass 6 mm. long by 3 mm. wide, of an irregular shape, more or less lobed, and partially subdivided into spheroidal nodules, *a, b, c*, each with its own perisarc. A good deal of the mass is dead. One of the spheroidal nodules, *c*, has sprouted, and in the outgrowth, *c s.*, the ectoderm and entoderm are distinct. In such a mass the living parts are easily distinguished by their bright color and sharp contour. The perisarc is distinguishable round some parts of the mass that are dead, but in other such places it cannot be made out. In the case of such large masses possibly the perisarc does not form round the whole mass. The nodule or lobe from which an outgrowth has sprouted is often not cut off from the general mass by perisarc. This is true of the masses shown in figs. 2 and 4. In other cases, however, the nodule that has sprouted is completely surrounded by perisarc and is merely imbedded in the general mass (fig. 3).

Some of the more promising masses alive on July 13 were isolated. Among these was the mass shown in fig. 4. The condition of this mass on the next day is shown in fig. 5. During the twenty-four hours that have elapsed since fig. 4 was made, outgrowth *c s 1* has died, and the general mass from which the outgrowths project is dead. Outgrowth *c s 2* has however grown and bifurcated. One subdivision, *a*, adheres to the glass like an ordinary hydrorhiza, the other subdivision, *b*, projecting up in the water and now ending in a hydranth. The latter



Fig. 1 Eudendrium. Restituted mass four days old. *cs*, coenosarcal outgrowth; *cc*, ectoderm; *en*, entoderm; *op*, perisarc of original mass; *p*, perisarc of outgrowth; *s*, space between original mass and its perisarc. $\times 150$.

Fig. 2 Eudendrium. Part of large restituted mass four days old. *a*, *b*, spheroidal nodules of living tissue with perisarc; *c*, similar nodule with coenosarcal outgrowth, *cs*; *d*, *t*, dead tissue; other lettering as before. $\times 90$.

Fig. 3 Eudendrium. Nodule of living tissue *n*, with coenosarcal outgrowth, *cs*. Nodule was part of a large restituted mass. Other lettering as before. $\times 150$.

Fig. 4 Eudendrium. Part of large restituted mass, *cs*, with two coenosarcal outgrowths, *cs.1*, *cs.2*. Other lettering as before. $\times 90$.

has not yet acquired the characteristics of the species, although considerable differentiation has gone on. Nettle cells in the enlarged tentacular ends can be made out. The ectoderm of *cs 2* has contracted away from the perisarc, thus assuming the condition common in the adult. In the entodermic cavity of the coenosarc a movement of small spheroidal particles goes on constantly. Such particles are perhaps remains of the interior of the original mass, serving now as food material. The specimen is preserved in the condition drawn (fig. 5).

Two of the masses that were isolated on July 13, at that time in the condition of fig. 4, have developed completely formed hydranths on July 15. One of them is shown in fig. 6. The general mass, *rs*, from which the outgrowth has sprouted, is for the most part dead, although it still includes some spheroidal nodules, *n*, of bright orange color that are obviously alive. The original outgrowth, *cs.*, is a hydrorhiza, and its apex has apparently died, for here there is a regeneration point, *rp*. A branch, *a*, ascends in the water and bears the hydranth. This has the characteristic shape and size, the long slender tentacles, large hypostome, and bright orange color of the normal adult polyp. The other mass is also largely made up of dead tissue, but an outgrowth has survived and become a hydrorhiza bearing two fully developed hydranths like that of fig. 6. Both masses now preserved.

Summing up, it may be said that the larger masses of this experiment, of the general character shown in fig. 2, gave rise to a number of coenosarc outgrowths like those of figs. 2 and 4. In all, about three dozen such were obtained from July 13 to July 20. A good many were preserved as soon as this state was reached. From the others that were kept for further development, three masses gave four hydranths as already recorded. My experience with sponges suggests that exposure to the natural water of the harbor would give a higher rate of survival and transformation.

Along with the larger plasmodial masses of this experiment, very many small lumps were formed, 200 to 300 μ in diameter, which became spheroidal and in about one day after their forma-

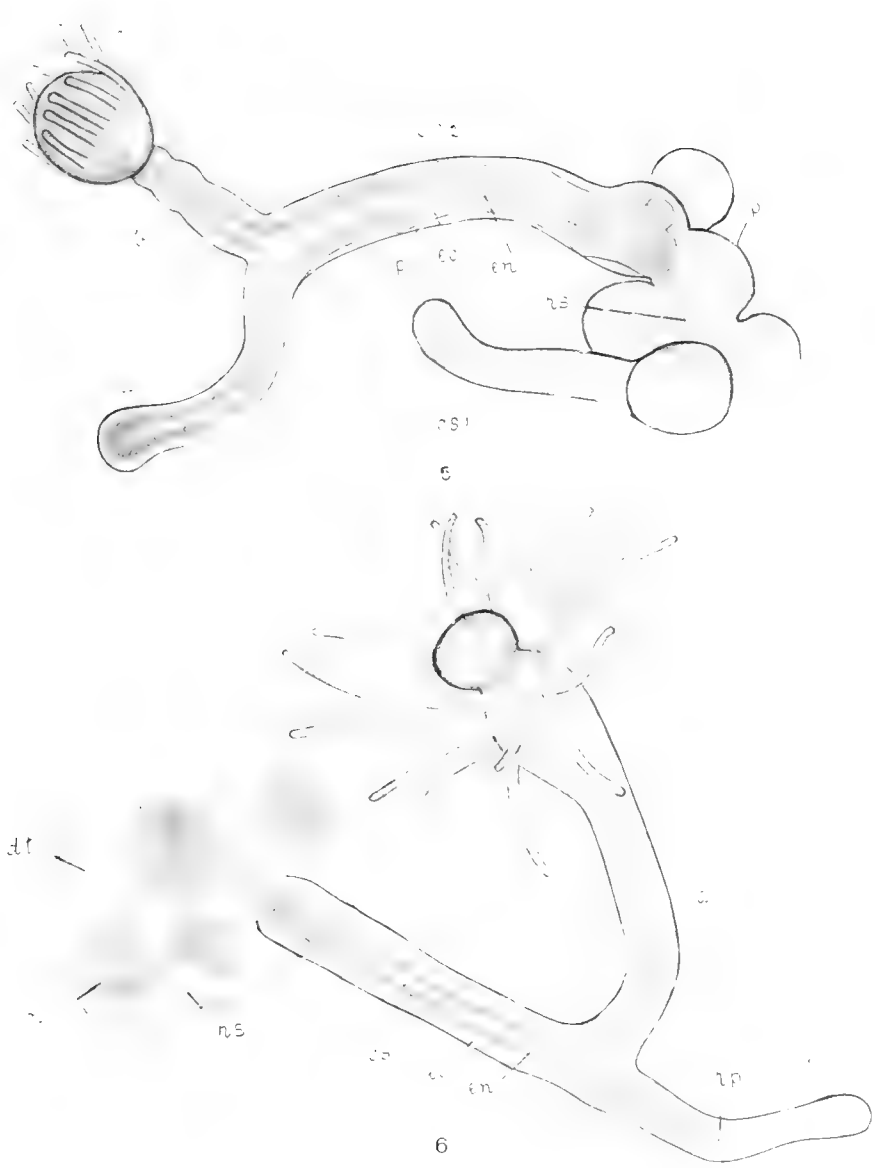

Fig. 5 Eudendrium. Restitution mass of fig. 4, twenty-four hours later. General mass, *cs*, and outgrowth, *cs.1*, now dead. Outgrowth, *cs.2*, has bifurcated, and one branch, *b*, has developed a hydranth. $\times 90$.

Fig. 6 Eudendrium. Restitution mass, *ns*, with coenosarcial outgrowth, *cs*, the latter bearing a vertical branch, *a*, which ends in a hydranth. *dt*, dead tissue; *n*, nodule of living tissue; *rp*, regeneration point. Other lettering as before. $\times 90$.

tion secreted a perisarc. These small masses adhered so firmly to the glass that the water could be drained off when the glass was changed to a fresh bowl. I had expected that many of them would transform. As a matter of fact only half a dozen developed outgrowths, and these were short and in no case gave rise to a hydranth. These masses remained alive for days. Perhaps their failure to produce hydranths was due to the small amount of material making up the mass.

*Experiment July 14.*⁴ Colonies chopped up and pressed through gauze 4 p.m. The tissue was distributed with the pipette in watch glasses, on slides and covers, and all were immersed in large bowls of water. The tissue from the start had a bad color, not orange but a dirty brown. The colonies I used were probably not clean enough, and perhaps too much *Perophora* and other organisms infesting the hydroid got in the cultures. All of these preparations died before the tissue even reached the state of smooth compact masses.

Experiment July 15. Colonies, some with male, some with female gonophores, others without gonophores, were pressed out at 4 p.m. The tissue is handled in essentially the way described for Exp. July 9, and at 7 p.m. fusion has led to the formation of flattened plasmodial masses and lumps of all sizes. The color of the masses at this time is good, reddish-orange, and the surfaces are not far from smooth. But on the following day much of the tissue is dead. Many of the nodules and lobes composing the larger masses show, however, a thin perisarc. The masses including nodules of live tissue are transferred to fresh sea water. The masses gradually died or when nodules remained alive they exhibited no change, continuing in a dormant condition. In this and most of the subsequent experiments I feel satisfied that the cause of failure lay partly in the fact that too much tissue was pressed out. This made the first steps in the handling slow and the aggregations of tissue too large.

Experiment July 18. A clean colony was pressed out in the usual way in watch glasses, the cells settling on the bottom.

⁴The records of several very unsuccessful experiments are given in the expectation that they may serve to point out features in the method of treatment which are to be avoided

These are allowed to stand about fifteen minutes, during which time they are shaken to the center a couple of times. The glasses are then transferred to bowls of water. Finer sediment floats off, but the coarser clings to the bottom. After ten minutes the glasses are removed to fresh bowls. Again some sediment is lost, but not much. The peripheral sediment is now gently dislodged with the pipette, and heaped up towards the center of the glass. After an hour the tissue is sucked up with a large pipette, an effort being made not to break it up more than is necessary, and deposited on bottom of fresh bowls in heaps $\frac{1}{2}$ to 2 mm. thick and about 5 mm. in diameter. The tissue was later on again transferred in the same way. The technique of this experiment proved wrong, for on the next day most of the tissue was dead. Probably there was too much handling, and the heaps made were too massive.

Experiment July 19. Colony pressed out 11:30 a.m. Tissue collected in watch glasses and shaken to center after ten minutes. Glasses transferred to bowls 12 m., and again to fresh bowls 1 p.m. Glasses now removed from bowl and with pipette the tissue is transferred to fresh watch glasses of water and there deposited in heaps about 5 mm. in diameter and $\frac{1}{2}$ mm. thick. The material is now coarsely lumpy, showing that fusion has gone on, and the heaps are therefore porous, not dense and compact. Glasses transferred to fresh bowls at 1:20 p.m. gently so that the tissue aggregations are not disturbed. Again so transferred at 3 p.m.

The coherence and slow contraction of the heaps of tissue is shown by the fact that at 5 p.m. they have curled up slightly at the edge and are now free or nearly free from the bottom. In this condition the heap or cake can be pushed with the pipette over the bottom. Only the thinner heaps have this amount of coherence—to behave in this way they should not be over $\frac{1}{2}$ mm. thick. Glasses transferred to fresh sea water at 5 p.m. and at 7 p.m.

On the next day the result was disappointing. Most of the material was dead. Some of the smaller cakes were however alive or alive in places, and had developed a perisarc. One of

these is shown in fig. 7. Several such were preserved for sections. Again I attribute the failure, comparatively speaking, of this experiment to too much handling and to the fact that heaps of too large a size were made. It must be borne in mind that when any considerable part of the tissue dies during the first day, the surviving masses having been infected have a poor chance for further growth.

Experiment July 22. Colonies pressed out 3:10 p.m. Only tops of clean colonies were used and female gonophores were mostly excluded. Tissue collected in watch glasses and transferred to bowls, about as before. At 7 p.m. tissue was coarsely lumpy, showing that fusion had gone on. It was transferred to bowls of fresh sea water and deposited in areas 7 mm. in diameter and $\frac{1}{2}$ mm. thick. Tissue nearly all dead the next day.

Experiment July 23. Tops of clean male colonies were pressed out at 3:30 p.m. At 7 p.m. tissue was sucked up with pipette and distributed in fresh bowls to form thin areas about 10 mm. in diameter. These areas soon become transformed into reticular sheets having considerable coherency. They become free or nearly free from the bottom, and some curl up slightly at the edge indications of contraction. Another set of preparations were made at the same time and treated in same way, from the tops of female colonies. This tissue too went so far as to form reticular sheets of considerable coherency. But on the following day the tissue was practically all dead.

Experiment July 25. Male and female colonies were pressed out at about 2 p.m. The tissue collected from each colony was kept by itself. One-half hour after preparation, the tissue which had been squeezed out in watch glasses, was shaken to the center of the glass, and the glasses were transferred to bowls. The glasses were transferred to fresh sea water at intervals of two hours until 9 a. m. on the next day. Five hours after preparation the tissue had united to form thin sheets, which soon began to crack evidently owing to a process of contraction. These sheets of tissue however went no further in development and on the next day were dead.

In the peripheral region of each watch glass numerous small masses of tissue, a fraction of a millimeter, formed. These are alive on July 26 and show a smooth contour. They are still alive on July 27 and now have an obvious perisarc. Many of them cling to the bottom, but many are free and are held together in loose, thin, flat aggregations by debris and the perisarc of dead tissue. On July 28 and 29 most of these masses are still alive and a dozen have sent out coenosarcial outgrowths. Several are shown in fig. 8. A little group of masses all interconnected is also shown in fig. 9.

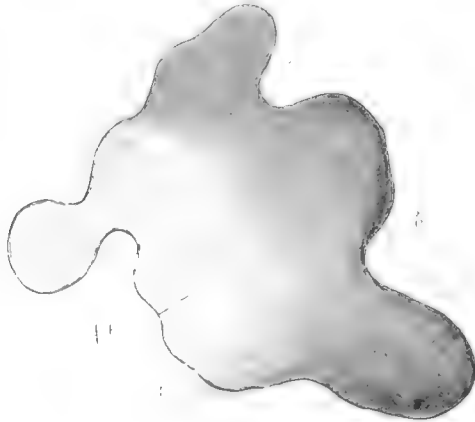

Fig. 7 Eudendrium. Restitution mass twenty-four hours old. *a, b, c*, lobes of living tissue; *d, t.*, dead tissue; *p*, perisarc. $\times 150$.

Experiment July 27. A clean male colony pressed out at 1:45 p.m. in a watch glass. Tissue was shaken to center after a few minutes, and the water in watch glass was renewed after the tissue had once more settled on the bottom. The tissue was then distributed with a large pipette over the bottom of two watch glasses and shaken to center. In each watch glass a central collection of tissue is thus formed in the shape of a thin area 10 to 15 mm. in diameter. Outside of this are scattered many small lumps, 1 mm. and less in diameter. The glasses are transferred to bowls 3:30 p.m. Four such cultures were made.

At 5 p.m. coherent cakes of open, reticulated texture have been formed. These are free or nearly free from the bottom. They are transferred with a large pipette to fresh bowls of water. At 7 p. m. they are again transferred, and several are cut in pieces. They have a good color and are obviously alive. On the next day many of the cakes are still alive and have formed a perisarc over much of their surface. Where the perisarc has formed, the included tissue is uniformly opaque and by reflected light appears distinctly orange. The formation of the perisarc cuts out, I think, such masses as pieces of gonophores, tentacles, and hydranths, from the undifferentiated mass, round which it forms. Gonophore and tentacle fragments are to be sure sometimes partially surrounded by the growing (fusing) masses of tissue, from which they may be seen projecting. But probably a considerable part of each such mass dies, and with it the fragments of gonophores, etc.

On July 29 most of the tissue is dead or dying. Bacteria and infusoria are abundant. Nodules of live tissue surrounded by perisarc occur imbedded in the general mass. In some of the disintegrating cakes the arrangement of the perisarc is much plainer than it was when the whole cake was alive. It may now be seen that the perisarc was secreted round compact nodules, lobes, and anastomosing cords. All such are intricately combined with débris and tissue that never secreted perisarc to form the general mass.

All the larger masses soon died. But a good many of the small lumps that lay in the outer part of the watch glass, away from the central cake, were still alive on August 1. Several of them by this time had sprouted coenosarc outgrowths, and were essentially like fig. 1, although in some instances the mass had given rise to two opposite outgrowths.

The practical problem in handling this tissue seems to be to get masses large enough to provide the necessary amount of material for hydranth development, and yet thin and reticular enough to expose all parts of the mass to the water. Small masses, a fraction of a millimeter in diameter, are much easier to keep alive than large masses.

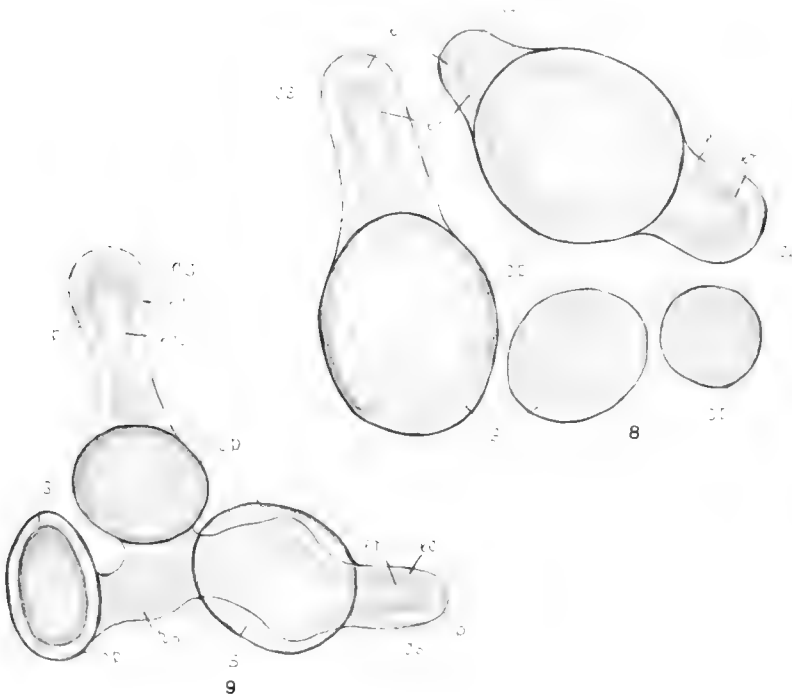

Fig. 8. Eudendrium. Group of restitution masses three days old; two still spheroidal; one with a coenosarcial outgrowth, *cs.*; one with two such outgrowths. *op.*, perisarc of original mass; *s.*, space between original mass and its perisarc. Other lettering as before. $\times 150$.

Fig. 9. Eudendrium. Three restitution masses interconnected, four days old; two masses with coenosarcial outgrowths, *cs.*; *rs.*, central part of original restitution mass. Other lettering as before. $\times 90$.

Experiment August 1. Colony pressed out at 3:30 p.m. Tissue in comparatively small amount is collected in watch glasses and allowed to settle. Water is gently drawn off and fresh added without disturbing the layer of 'sediment' that clings to the bottom. Glasses transferred to bowls after thirty minutes; transferred again 6 p.m. On the following day all the larger masses dead or dying. Many of the very small masses are also dead. Still there are very many small masses, a fraction of a millimeter in diameter, that are alive. These are more or less spheroidal and covered with thin perisarc, some attached to bottom of glass,

some to cover glasses that had been put in the watch glasses. On August 3 many of these masses are still alive, surrounded by perisarc, but they have not thrown out coenosarc processes.

In this experiment a small amount of tissue was pressed out, and until the details in the method of treatment are more precisely marked out, this is certainly a safe step. It will be noticed that the tissue was left *in situ* where it was first deposited on the bottom of the glass. The results indicate that this is not a good method for the larger masses. And yet it seems desirable for the tissue to establish some connection with the bottom, and this it will not do if disturbed and dislodged too much. The experiment records show clearly what a great influence apparently slight differences in the treatment had on the vitality of the fusion masses, and how much in the dark I remained as to what details were good, and what bad.

Experiment August 2, a. Colony pressed out at 4:15 p.m. Tissue collected in a watch glass, shaken gently to the center, and water changed several times, each time the tissue being stirred up considerably by the pipette current. Glass transferred to bowl 5 p.m.; transferred again 6 p.m. Tissue does not cling to the bottom, as it does when left undisturbed where it first settled. At 7 p.m. the tissue coheres sufficiently for pieces 2 to 3 mm. wide to be sucked up with large pipette. Other smaller pieces about 1 mm. wide are sucked up. All pieces are thin, about $\frac{1}{2}$ mm. thick. These pieces, forty-five in number, are scattered over the bottom of three bowls.

On August 3 at 9 a.m. the masses are alive and of good color. Some are free, some slightly attached to the glass. The latter are freed and all are gently transferred with large pipette to fresh bowls of water. They resemble the *Pennaria* mass shown in fig. 14. Examination shows that the perisarc has formed over parts of many plates, but in other places while the surface of the plate is smooth, no perisarc can be seen. In still other places the contour is rough, the periphery here consisting of rounded cells. Bacteria are present, here and there in swarms, but not much of the tissue is dead.

On August 7 a good deal of the tissue is now dead. But a large number of the pieces include lobes and nodules of living tissue surrounded by perisarc. Two of the plate-like masses show each a coenosarcial outgrowth of considerable length, about like those of fig. 4. On August 8 two other masses show each a similar outgrowth. On August 9 another mass has developed an outgrowth, which soon becomes sickly, losing its well marked layers and developing in the interior numerous dark masses. On August 11 two other pieces show each a coenosarcial outgrowth. These outgrowths are horizontal and creeping and each bears a vertical branch. Both are sickly as is shown by the fact that the layers are not everywhere uniformly differentiated, but in places appear to be breaking up, while in other places the tissue is densely concentrated.

The method practised in this experiment is evidently good and yet too much of the tissue dies leaving the surviving masses slow to transform. In the hope of stimulating these masses they were given a liberal supply of pure oxygen on August 6, but with no discoverable results.

While an effort was made in this and the other experiments to pick out pieces large enough to be distinguished with the eye, some pieces of gonophores and tentacle fragments remain in the cultures. Some of these are incorporated by the plasmodial masses. Many others undoubtedly die without being incorporated. Another structure too deserves mention as being occasionally present in the cultures. In cutting up the hydroid, many hydranths are snipped off at the very base. Some of these get in the cultures and escape notice. I have found that when such hydranths are isolated a process of reduction takes place analogous to that described by Schultz for hydra ('06), the hydranth gradually becoming in the course of a few days a mouthless spheroidal body. Apparently such a process goes on in the pressed out cultures more rapidly, for occasionally spheroidal bodies are seen quite like the reduced hydranths just referred to. I have moreover several times found such a body embraced by a plasmodial mass. Where bodies like gonophores, tentacle fragments, and reduced hydranths (or the bodies that look like

such) become surrounded by the plasmodial tissue, it is a question what becomes of them. As already said, the formation of the perisarc, I am inclined to think, cuts out such bodies from the comparatively homogeneous material round which it forms. Pictures are sometimes had which indicate that possibly such bodies are attacked by the plasmodial tissue, the latter invading and absorbing them. Again a stray fragment of stem perisarc from the colony used may get into the cultures, and if some of the coenosarc has been left inside, it may form a regeneration knob at one end of the piece. I have seen a piece or two of this kind. Such a fragment might very well regenerate a hydranth in the midst of the plasmodial masses. But fragments of this sort are easily distinguished from the plasmodial masses or nodules of the latter.

Experiment August 2, b. A colony was pressed out and the tissue allowed to settle on a cover glass immersed in a watch glass. In transferring, the cover glass was always kept in the watch glass, and thus the tissue was not directly exposed to the air. The material settling on the cover soon transformed itself into a multitude of small, more or less spheroidal masses, a fraction of a millimeter in diameter. They went so far as to form a perisarc. A large number of them died about one day after preparation, but many remained alive for days; were still alive on August 9. They had not sent out coenosarc outgrowths, but as was learned later from sections the originally solid mass in several cases, perhaps in all, had developed into a sac, the wall of which was made up of ectoderm and entoderm layers.

In the same way on August 2 tissue was allowed to settle over the bottom of a watch glass, forming a very thin deposit. Great numbers of small lumps formed which had the same history as the above. It is quite possible of course that a few of these lumps sent out coenosarc outgrowths, but that such escaped notice.

Summary. Eleven experiments with Eudendrium were made. In all experiments fusion led to the formation of plasmodial masses. In eight experiments an extensive formation of perisarc took place. In five experiments numerous small masses with perisarc, which remained alive for days, were formed; in three of

these experiments several of the spheroidal masses sent out coenosarcial outgrowths. In two experiments a considerable number of coenosarcial outgrowths were obtained from nodules of tissue which had remained alive in comparatively large flattened plasmodial masses, and in one experiment these outgrowths gave rise to hydranths, four in number.

The first experiment, July 9, was much the most successful. In those that followed a common error undoubtedly lay in endeavoring to handle too much tissue. But over and above that the water grew warmer with the advancing season and the Eudendrium colonies perhaps became more abundantly infested with protozoan ectoparasites.

The technique in general of these experiments is especially faulty in that, (1) it allows parts which must die, tentacle and gonophore fragments, to get into the cultures; and, (2) it subjects masses of tissue that evidently need the best environment to the harmful influences of quiet water in a laboratory dish. Small gauze floats kept at the top of a running aquarium were used, but with no success. Very probably if the cultures were placed outside in the harbor water, they would do better. As to methods, the following may be added to what has already been said:

Only clean colonies or parts of colonies should be used. If the whole hydroid is used I believe that colonies without gonophores are the best, and those with female gonophores the worst. Stem tissue would perhaps be better than that of the whole colony. Care should be taken to allow the cells and small lumps to cohere, and not to break up the cohering tissue at first more than is necessary. It is well to get the tissue in comparatively small pieces a few hours after preparation, and in fresh dishes away from the original surface of attachment. If the masses of tissue a few hours after preparation appear soft and pasty, they will probably not live. They should show a good color, absence of the characteristic color indicating presence of dirt or infesting animals. The gauze (silk bolting cloth), usually used runs 50 meshes to 25 mm. A cloth running about 75 meshes to 25 mm. was also used. The sea water was well aerated and filtered. An effort was made to pick out from the cultures all coarser particles, such as pieces of

hydranths and gonophores, that could be seen with the eye. The tissue was usually pressed out and kept in solid watch glasses with a cavity 50 mm. in diameter and 10 mm. deep. These were immersed in crystallization dishes 200 to 250 mm. in diameter or in finger bowls of about 120 mm. diameter. Dishes, instruments, and gauze were thoroughly cleaned, but were not sterilized. Possibly sterilization in hot water would be advantageous. I lay emphasis on the technique of the experiments in the hope that it may be improved by others. With a more certain technique this method of growing hydroids ought to lend itself to the production of hydrids, as I have suggested ('07b, '11b) for sponges.

Histological study of the restitution masses of Eudendrium

Observation record, July 27. At 4:30 p.m. a drop of the Eudendrium tissue was squeezed directly from the gauze sac on to a slide. A supported cover was put on and slide examined at once. The fluid contained quantities of separate cells. In addition there were present a few small masses each consisting of several cells. All the cells were about spheroidal, but they varied a great deal in size. Some contained abundant pigment granules, others a few, and others were quite transparent. Four types could be distinguished, all of which were abundantly represented, but plenty of transitional cells connecting these types were also present. The types are shown in fig. 10, *a, b, c, d*. Cell *a* is well filled with pigment granules which appear brownish red by transmitted light. Cell *b* contains similar granules, but they are few in number. Cells or particles *c* and *d* are transparent and either without pigment or show only a faint granule or two. The slide was kept in a moist chamber and examined at intervals for four hours. The formation of numerous minute masses each consisting of a few cells was observed. These grew large through fusion with one another from hour to hour. At 8 p.m. a few plasmodial masses of considerable size were present, the largest of which measured about $300\mu \times 50\mu$. This was a thin flattened, sheet-like mass having an irregular outline. Its general body was opaque, but the peripheral part was thinner and here it could be seen that all of the four types of cells entered into the composition of the

mass. At this time, 8 p.m., numerous small plasmodial masses grading down to aggregates of a few cells were also present. In many of these too the four types of cells could be distinguished. Finally in the preparation at this time there still remained quantities of free cells. In this preparation there were no bits of tentacles, gonophores, or foreign particles.

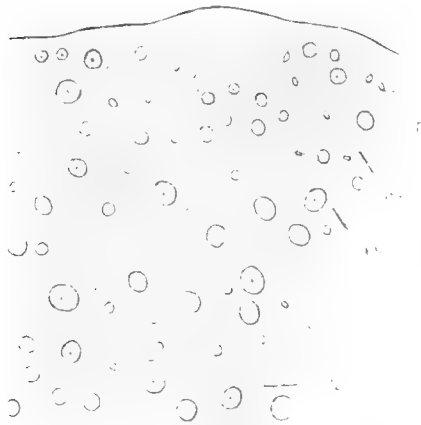

Fig. 10 Eudendrium. Elements of the pressed out tissue. $\times 700$.

Fig. 11 Eudendrium. From a section through a lobe of the mass shown in fig. 7. *en*, cnidoblast; *f. c.*, free cell; *p.*, perisarc. $\times 1200$.

Results from study of sections. The plasmodial mass shown in fig. 7 was about twenty-four hours old when preserved. A part of it had already died, but there were three large lobes of living tissue surrounded by an obvious perisarc. These lobes were found to agree in structure. Part of a section through one of them is shown in fig. 11. In the interior of the lobe there are numerous cells which seem to be free, that is the body is well defined all round. These cells vary in size; the nuclei are relatively large with

abundant nucleoplasm and usually with a conspicuous nucleolus: the cytoplasm as a rule shows vacuoles and solid inclusions in vacuolar spaces. Similar cells are met with which are not sharply delimited all round, but only on one side (cell *a* in fig. 11); on the other side, the cell shading off into the syncytial reticulum. In such a case, I take it, we have a mass which has broken away from the general syncytium on one side, the protoplasm on this side condensing to form a film of exoplasm. Cnidoblast cells, *c n.*, with included nematocysts are also common in the interior of the lobe. Between the cells or groups of cells the protoplasm exists as a vague reticulum, the vacuolar spaces in which are of all sizes. Scattered in the reticulum are nuclei. The external stratum of the lobe in some places is not markedly different from the interior. In other places it shows smaller cells and more nematocysts than the interior. No doubt some of the nematocysts have been carried over from the parent hydroid; possibly others are new formations. The external structure of the lobe is in most places continuous with the interior, but here and there it is separated as in the next mass to be described. The dead part of the mass (fig. 7) consists of a loose granular stuff including some nuclei and nematocysts. The live and dead tissue are not sharply separated, but grade into each other.

Two other plasmodial masses about twenty-four hours old were sectioned. These masses were irregular bodies of the same general character as the one shown in fig. 7. They were however entirely alive, and surrounded everywhere by a distinct perisarc. They proved to be essentially alike in internal structure. Part of a section through one is shown in fig. 12. The body is solid and an outer stratum is almost everywhere separated from an inner mass by a vaguely delimited cleft-like space, *s*. The outer stratum is chiefly composed of comparatively smooth cells, forming four or five layers, and of enidoblasts. The cells have large nuclei and are in general well defined. There are places however where one can only find nuclei lying in a vaguely reticular protoplasmic matrix. The inner mass is a complex syncytium containing abundant large nuclei and vacuoles with inclusions. Numerous enidoblasts are scattered through it, and well defined ordinary

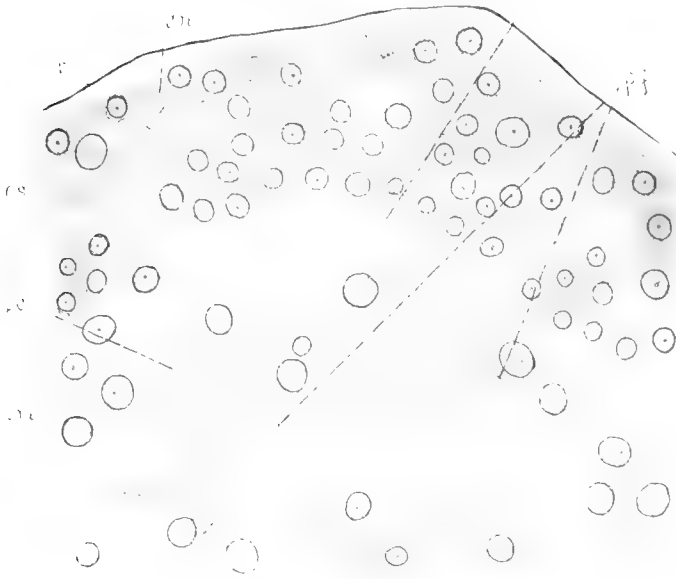

12



13

Fig. 12 Eudendrium. From a section through a restitution mass about twenty-four hours old. *cn*, endoblast; *f. c.*, free cell; *p.*, perisarc; *p. l.*, protoplasmic film; *s.*, space separating an outer stratum, *a. s.*, from the inner mass, *i. m.*, $\times 1200$.

Fig. 13 Eudendrium. Section of the restitution mass, with one coenosarc outgrowth, shown in fig. 8. Section strikes the original mass and does not include the outgrowth. *y*, yolk mass. Other lettering as before. $\times 350$.

cells are found in it here and there. Protoplasmic films, *p f*, are common which mark off cells or areas on one side while on the other side the protoplasmic area has no distinct boundary.

The masses shown in fig. 8, two spheroidal and two with outgrowths, were sectioned. These bodies when preserved were three days old. In fig. 13 is shown a section through the dilated body of one of the masses which had a coenosarcal outgrowth. All the bodies proved to be in essentially the same condition as far as the differentiation of layers is concerned. In them all an ectoderm and entoderm are distinctly differentiated. The two layers are separated by a cleft-like space, there being no distinct supporting lamella. In the small spheroidal masses and in the dilated portions (representing the original shape) of those with outgrowths, there is a central yolk that is still continuous with the entoderm in spots. The yolk mass does not extend into the outgrowths. The perisarc is laminated and in the sections almost everywhere widely separated from the ectoderm. The ectoderm is composed of small cells, probably all interconnected, forming in places one layer, in other places two or three layers. Small nematocysts and stages in development of these are common, and other inclusions also are present in the ectoderm. The entoderm consists of a single layer of large closely packed cells varying from a more or less cubical to a somewhat flattened shape. These cells are uninucleate, the cytoplasm more or less vacuolated and sometimes containing small (developing) nematocysts and other inclusions. The central yolk, *y*, is a granular mass in places composed of small spheres of varying size. In it small spheroidal vesicles containing one or two deeply staining granules are common, doubtless representing swollen and degenerating nuclei. A few small nematocysts are also found in the yolk. The yolk mass although in general separate from the entoderm is perfectly continuous with this layer in spots.

While my observations on the histological structure of the restitution masses, both in *Eudendrium* and *Pennaria*, are fragmentary, they are nevertheless definite. From them it would seem that in *Eudendrium* the solid aggregate formed by the fusion of the isolated cells passes into the condition of a synectium which

includes partially or perhaps completely free cells (fig. 11). An outer stratum in which cell bodies are well differentiated, and which is several layers deep, now becomes marked off from an inner mass (fig. 12). The outer layer probably represents the ectoderm, while the inner mass represents a yolk-entoderm, which subsequently splits into the definitive entoderm and the yolk. Finally ectoderm, entoderm and a central yolk mass appear (fig. 13), as in the development of a coelenterate planula, *Manicina* for instance (Wilson, '88), or *Eudendrium* itself (Hargitt, '04).

PENNARIA. RESTITUTION FROM DISSOCIATED CELLS

Species used. The species used was *Pennaria tiarella* McCrady (Proc. Elliott Soc., vol. 1, no. 1, p. 153; Nutting, '01, p. 337). Pale specimens with light colored ova and deeply colored specimens with orange ova were abundant together on the floats round the laboratory wharf at Beaufort during August. Both pale and colored forms liberated medusae at dusk, about 7 p.m. The forms appear to represent merely the extremes in a range of color variation (for the varieties at Woods Hole *vide* Hargitt, '00).

Experiment July 26. A vigorous and clean colony was pressed out in the usual way at 4:25 p.m. Quantities of cells of various kinds, especially spheroidal granular cells with more or less pigment, came through; also small cell groups, and bits of tentacles. Fusion of the cells and cell aggregates begins at once and proceeds rapidly. In ten minutes time a mass $500\mu \times 100\mu$ has been formed, in a watch glass kept under the microscope, practically from isolated cells. Such masses change their shape slowly and fuse with one another. The tissue which was pressed out in a watch glass was shaken to the center at 4:35 p.m. At 4:53 it has formed a thin coherent cake. This is now sucked up in pieces with the pipette, and so broken into pieces about 5 mm. in diameter which are transferred to a bowl of water.

At 6 p.m. the tissue lies on the bottom of the bowl in the shape of thin, somewhat reticular sheets. These are freed from the bottom (they had already begun to curl up round the edge) with small pipette and are transferred with a large pipette to a

fresh bowl. In so doing the sheets are of course broken where-upon the peripheral parts turn white and disintegrate quickly. But the body of the piece remains alive, keeps its color (a reddish tinge), contracts and soon has a comparatively smooth surface once more. Fragments accidentally broken from the sheets are

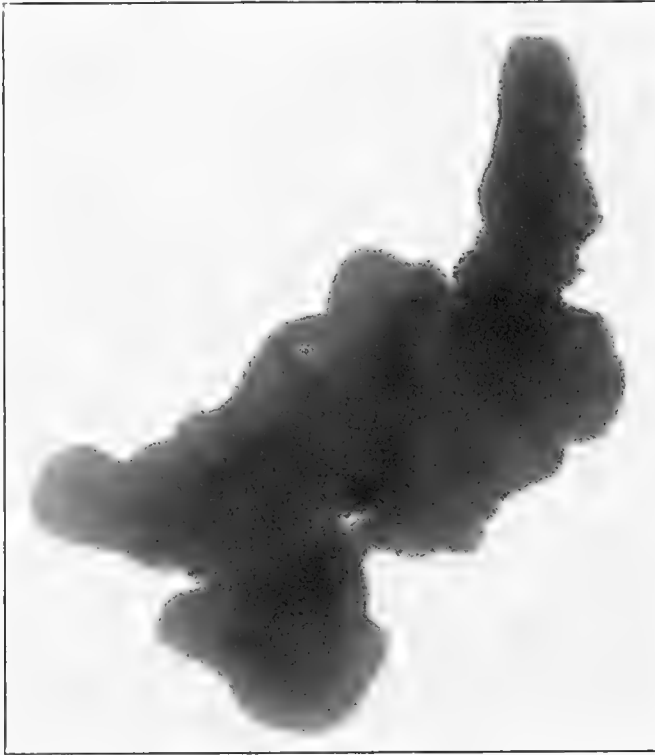
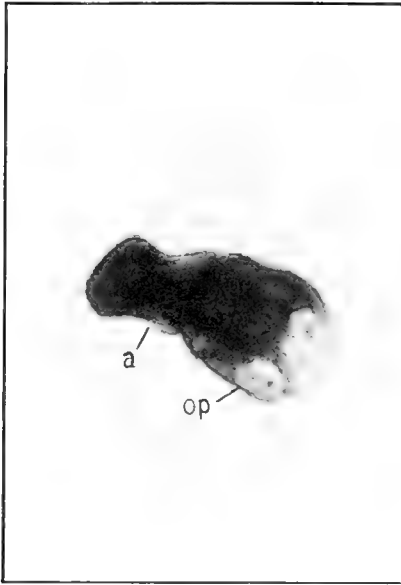

Fig. 14 Pennaria. Restitution mass, four days old. Photograph. $\times 50$

also transferred, and these also quickly 'heal.' All the masses continue to contract, and by 8 p.m. many of them have a massive shape, although some at this time are still sheet-like. They all have a smooth surface, and the majority of them are in the neighborhood of 1 mm. in diameter. One of the largest is shown in fig. 14.

On July 27 at 9 a.m. the masses are surrounded by a distinct perisarc and with some exceptions are still alive or include considerable live tissue. The color of the live tissue is pink. The smaller masses are of compact shape, spheroidal or ovoidal, and are alive throughout. The larger masses are of a somewhat lobular shape, and while the projecting lobules are alive, a considerable part of the body of the mass is dead or dying. Several are now preserved. Sections confirmed what I have just said as to the distribution of the live tissue. In fig. 20 a section through one of the smaller masses is figured, and it may be seen that the whole mass was alive, and while in general still solid had begun to differentiate the ectoderm and entoderm layers. The masses at this stage are soft and burst easily on rough handling. The water was henceforth renewed with a siphon.

On July 29 two of the masses have developed outgrowths. A photograph of one of them is shown in fig. 15, and the other is represented by a photograph (fig. 16) and a camera sketch (fig. 21), the latter made from the living object. The original mass in both cases was spheroidal, and the thick perisarc, *o. p.*, which surrounded it, still persists. The mass, as sections of similar bodies show, has differentiated into ectoderm and entoderm layers which surround a central cavity containing the remains of yolk material. The body shown in fig. 21 has developed one long outgrowth *c* and two short ones, *a* and *b*, just protruding at the opposite end from the original perisarc. In the long outgrowth the ectoderm and entoderm are thicker than elsewhere. The perisarc over this outgrowth is noticeably thinner than that over the original mass, and the ectoderm in a part of the outgrowth has contracted away from the perisarc, remaining connected with it by strands, *ect. s.* after the fashion characteristic of the adult hydroid. The original mass, too, it may be seen has contracted away from the perisarc and has materially changed its once globular shape. The other mass, fig. 15, which has developed only a single outgrowth, represents a slightly earlier stage than figs. 16 and 21. In it the original mass has contracted away from the perisarc, *o. p.*, but remains connected with it by strands of ectoderm. In the outgrowth however the ectoderm has not yet



15

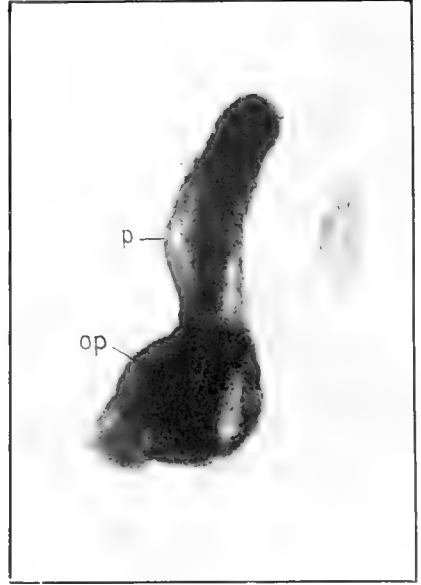

16

Fig. 15 Pennaria. Restitution mass three days old. *a*, coenosarcial outgrowth; *op*, perisarc of original mass. Photograph. $\times 50$

Fig. 16 Pennaria. Restitution mass three days old. *op*, perisarc of original mass; *p*, perisarc of long coenosarcial outgrowth. Photograph. $\times 50$

begun to separate from the perisarcial covering. Both these masses including the outgrowths are firmly adherent to the bottom of the vessel.

On July 29 a large number of the masses are dead. Only the smaller ones together with two or three of the larger survive, and the latter have been injured and evidently are in bad condition. Injury often comes in changing the water, the siphon setting up a current which strains the bodies of the larger masses especially since these are attached to the bottom only throughout a part of their extent. The small masses are more perfectly attached to the glass. It is clear that if one wishes to grow hydroids in this way it is better to produce comparatively small masses instead of large ones such as that shown in fig. 14.

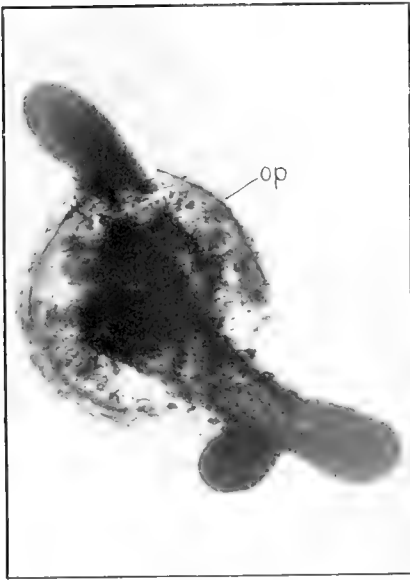

17



18

Fig. 17 *Pennaria*. Restitution mass, five days old, with two outgrowths, one branched. *op*, perisarc of original mass. Photograph. $\times 50$

Fig. 18 *Pennaria*. Restitution mass, two days old, metamorphosed, with hydranth. *op*, perisarc of original mass. Photograph. $\times 50$

On July 30 one of the masses has developed three outgrowths, each about like the long outgrowth in fig. 16. The mass itself and two of the outgrowths adhere to the bottom, while the third rises obliquely in the water. On July 31 only one of these outgrowths remains adherent to the bottom; the other two rise obliquely in the water. The extremities of the latter have now the character of knobs, reddish brown in color and resting upon lighter colored stalks. This mass continues to develop and on August 1 has reached the condition shown in fig. 19. The ascending outgrowths now bear hydranths, each with the lower filamentous tentacles and the upper short capitate tentacles characteristic of this hydroid. The thick perisarc, *o. p.*, marks out the size of the original mass from which the outgrowths sprouted. The outgrowth *x* is the one that remained adherent to the glass. In the

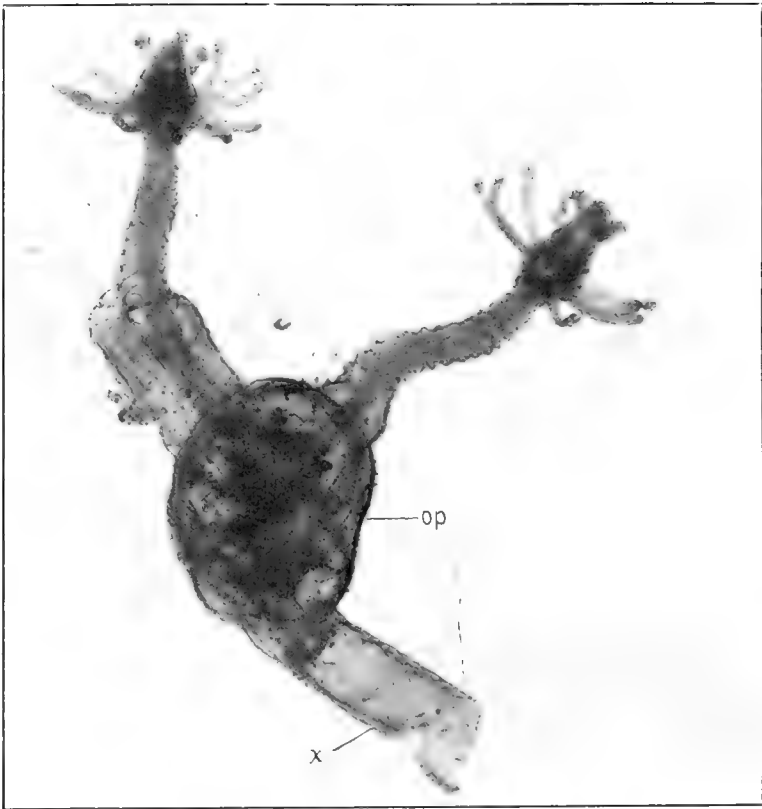
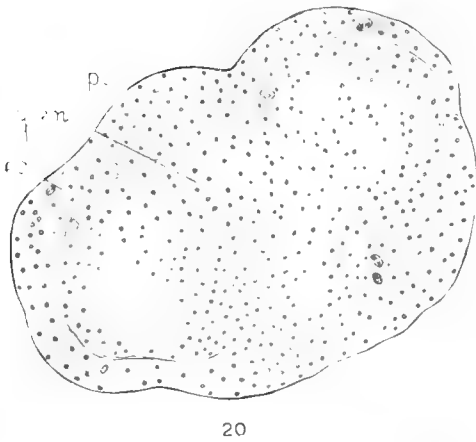

Fig. 19 Pennaria. Restitution mass six days old, completely metamorphosed, with developed hydranths. *op*, perisarc of original mass; *x*, perisarc of outgrowth adherent to glass. Photograph. $\times 50$.

living body the perisarc ended in a closed rounded extremity and contained a coenosarcial prolongation extending throughout its length. When the body was pried from the glass, the coenosarcial prolongation retracted and in the photograph it appears very short.

Experiment August 3. A clean vigorous colony about 5 inches high is selected and only stem material (coenosarc) is used. All lateral branches are cut off, also the base and tip of the main stems. The latter are then cut into pieces about 3 mm. long and



20



c



22



21

Fig. 20 Pennaria. Section of restitution mass, seventeen hours old *cc*, ectoderm; *p*, perisarc; *y. cn.*, yolk entoderm. $\times 150$.
 Fig. 21 Pennaria. Same mass as in fig. 16. *a, b, c*, coenosarc outgrowths; *cc*, ectoderm; *cn*, entoderm; *op*, perisarc of original mass; *p*, perisarc of long coenosarc outgrowth. $\times 90$.
 Fig. 22 Pennaria. Median section of restitution mass two days old. *a, b, c*, short coenosarc outgrowths; *cc*, ectoderm; *cn*, entoderm; *op*, perisarc of original mass; *y*, yolk material. $\times 150$.

these are pressed through gauze in the usual way. The tissue thus obtained is pure coenosarc tissue broken up into separate cells and minute aggregations of cells. The tissue is pressed out at 3:10 p.m. Fusion goes on rapidly, and in twenty minutes round the edge of the collection of tissue small bars and plates, 1 to 3 mm. long, have been formed. At 4:50 p.m. the material exists as a thin cake about $\frac{1}{2}$ mm. thick, of considerable coherency, yet of loose reticular texture. This lies on the bottom scarcely adherent to the glass. It is cut with scalpel and needle into pieces about 4 mm. in diameter. Nine such pieces are prepared and together with some much smaller fragments are transferred with a pipette to a fresh bowl of water.

At 7 p.m. all the pieces have contracted considerably. The plate-like pieces have begun to curl up at the edge and the smallest fragments have already assumed a compact, massive shape. The color is a light pink. On the next morning (August 4) all the masses are still alive and have secreted a distinct perisarc. The smaller are spheroidal or ovoidal in shape, the larger of an irregularly massive shape, measuring up to a length of 3 mm. They are all adherent to the glass. The water is now changed by siphoning, and some of the larger masses rupture. They rupture very easily and it is clear they are too large to thrive. After rupturing, a mass quickly acquires once more a smooth surface within the perisarc.

On August 5, two of the masses have partially transformed. One is shown in section in fig. 22. This mass was originally spheroidal and in the living state, including the perisarc, measured about $\frac{1}{2}$ mm. in diameter. It was firmly attached to the glass, and at 9 a.m. August 5 was still spheroidal. At 2 p.m. it was observed to be triangular. The triangular character became more marked during the afternoon, and it was plain that the mass was sending out three outgrowths, *a*, *b*, *c*. The body was preserved at 7 p.m. Sections showed that the originally solid plasmodial body had differentiated the ectodermal and endodermal layers.

The other mass on August 5 had developed farther. A photograph of this mass is shown in fig. 18, and a camera sketch made

from the living object in fig. 23. The original mass was spheroidal; its outline is indicated by the thick perisarc, *o. p.* Two short outgrowths, *a* and *b*; had developed, and these together with the original mass adhered to the glass. A third outgrowth *c* ascended in the water and had transformed into a hydranth bearing whorls of short stubby tentacles. The ectoderm and entoderm had developed throughout the mass, and the ectoderm of the tentacles and of the short outgrowths included abundant nettle cells. The hydranth while under the microscope, in a watch glass, was frequently active, bending from side to side. The size of the gastric cavity varied with the contraction state but during most of the time was large. Shortly after transferring the mass from the breeding dish to the watch glass and just after fig. 23 was made a quantity of granular material was twice ejected from the mouth, after which the polyp contracted considerably. The water was then changed, and the polyp returned to about the condition shown in the figure. It was then preserved (4 p.m.). The tentacles of the hydranth arranged in three whorls, all look alike, and are of a more or less globular shape. The upper whorls doubtless represent the capitate tentacles of the adult. Possibly the tentacles of the lower whorl elongate and develop into the filamentous tentacles. In the development of the egg polyp, Hargitt ('00, p. 400) finds that the filamentous tentacles appear first, the capitate somewhat later. In the restitution polyp shown in fig. 23 there may have been a slight difference in the time of appearance of the several whorls.

On August 6 another small mass has developed an outgrowth and resembles fig. 15. On the next day it is dead. By this time, August 7, many of the masses including all the larger ones are dead, but some survive and of these three have developed each an outgrowth. One of them is shown in fig. 24, the others are substantially like it. In all three the coelenterate layers have reappeared; the original mass has contracted away from the perisarc with which it remains connected by ectodermic strands. While the mass shown in fig. 24 was under the microscope, these strands retracted into the body. The three partially transformed masses are now preserved.

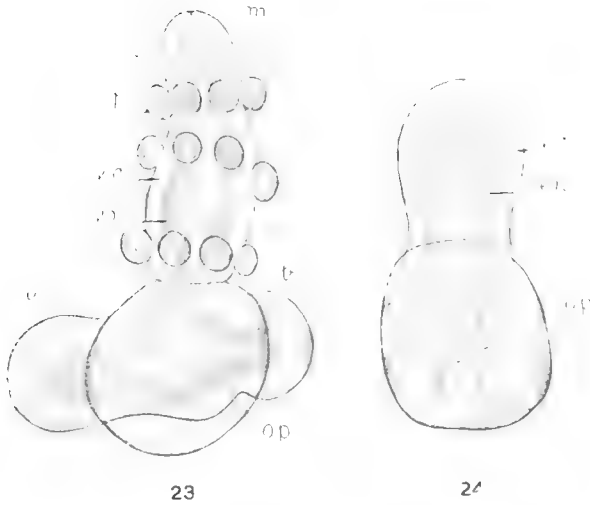

Fig. 23. *Pennaria*. Same mass as in fig. 18. *a, b*, short coenosarc outgrowths; *c*, outgrowth that has become a hydranth; *ec*, ectoderm; *en*, entoderm; *m*, mouth; *op*, perisarc of original mass; *l*, tentacle. $\times 90$.

Fig. 24. *Pennaria*. Restitution mass three days old, with outgrowth. Lettering as before. $\times 90$.

On August 8 only four of the masses of this experiment are alive. Two are still spheroidal. One has developed an outgrowth and is substantially like fig. 24. The other is shown in fig. 17; it has given rise to two outgrowths at opposite poles, one of which has developed a lateral branch. The original mass has contracted away from the perisarc, remaining connected with it by ectodermic strands in the usual way. On the perisarc algae have settled and these appear in the photograph as rounded spots. In all of these bodies, even in the spheroidal masses, sections showed that the ectoderm and entoderm had developed, and a gastral cavity containing the remnants of a yolk mass was present. The bodies were preserved August 8.

Summary. Two experiments were made. In the first both stems and hydranths were used. In the second only stem tissue was used. A large number of solid plasmodial masses were obtained, and these within a day uniformly secreted a distinct perisarc. In the first experiment all the larger masses gradually died. Three masses $\frac{1}{2}$ to $\frac{3}{4}$ mm. in diameter, differentiated the

coelenterate layers and developed coenosarcal outgrowths. One of these masses went further and developed perfect hydranths. In the second experiment also the larger masses died. Ten smaller masses for the most part about $\frac{1}{2}$ mm. in diameter, the largest reaching a diameter of $\frac{1}{10}$ mm., differentiated the ectoderm and entoderm layers. Of these, eight developed coenosarcal outgrowths, and of the eight one mass produced an actively motile hydranth with whorls of tentacles.

Comparison with egg development. For the purpose of comparison with the restitution hydroids my assistant, Mr. O. W. Hyman, reared *Pennaria* from the egg. As Hargitt ('00) states, the eggs vary considerably in size, the planulas in size and shape both. Several planulas were measured and it was found that they ranged in length from about $\frac{1}{10}$ mm. to 1 mm., while the cross diameter was about $\frac{2}{10}$ mm. It will be seen that these planulas were not so far removed in bulk from the restitution masses that transformed, although neither in the case of the planulas nor in that of the restitution masses was there any uniformity of size. On the other hand the hydranths produced by metamorphosing planulas are fairly constant in size, and they agree in this respect with those produced by the restitution mass shown in fig. 19.

Histological study of the restitution masses of Pennaria

Sections of the *Pennaria* stem show that the entoderm is made up of a single layer of large columnar cells tapering towards the base and measuring about 30μ by 15μ . The cells contain very many large spheroidal granules that stain pale blue with haematoxylin. The ectoderm contains an abundance of nettle cells, large and small. In each layer the elements are freely interconnected to such a degree that in many regions at least the structure is that of a reticular syncytium.

In order to study the composition of the pressed out tissue I squeezed pieces of stem in a watch glass of water so that the squeezed out tissue fell on an immersed cover glass. After five minutes strong formalin was added. Much of the tissue thus fixed adheres to the cover, and this when mounted on a slide in water gives clear pictures. In such a preparation, fig. 25, there

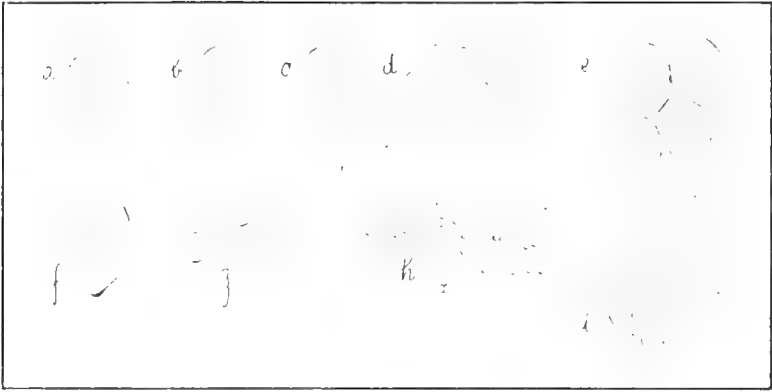

Fig 25 Pennaria. Elements of coenosarc tissue. From a preparation fixed five minutes after tissue was pressed out. $\times 600$.

are quantities of large granular cells, many of which are spheroidal as *a*, other with pseudopodia as *c*, some with a larger vacuole as *b*. The granules are generally scattered all through the cell, but as in *d* there may be some clear protoplasm. These cells exist separately but also in small aggregations as *d* and *e*. The cells and contained granules are of about the same size as those seen in sections of the stem entoderm and the cells evidently represent the entodermic elements. In the preparation again are numbers of endoblasts of various sizes with included nettle cells, *f*. Other elements, doubtless also ectodermic, are finely granular pale cells varying a good deal in size, *g*, together with small groups of such cells. When the stem piece is pressed, numbers of cells must be ruptured, and the preparation contains quantities of free granules, *b*, doubtless derived in large part from the entoderm cells. These are transparent, and for the most part spheroidal, although often irregular in shape. They seem to stick together and even to fuse. Droplets of translucent substance smaller than the entodermic granules and varying in size down to the vanishing point are common. It seems probable that some of this material spoken of as droplets and granules represents minute fragments of protoplasm that have rounded off. And the question is worth formulating, although I can not answer it: are such minute granular or drop-like bodies, representing por-

tions of broken down cells, incorporated in the restitution mass as it grows? Again in such a preparation one finds some masses, *i*, composed of finely granular material, with cell boundaries here and there vaguely showing, and sometimes with included nettle cells. These are probably lumps of ectoderm.

If such a preparation be made and examined alive in sea water, the same elements are observed. Formalin removes the color from the granules in the entoderm cells, but in the living preparation it may be seen that they have in general an orange tint, ranging from yellow to reddish, although some are colorless. The entoderm cells execute slow amoeboid changes of shape.

When the stem pieces are pressed through gauze and the tissue is at once examined alive in a drop of sea water, it is found to consist of the same elements described above. With this treatment more entoderm cells seem to be ruptured and there are fewer groups of cells. The coenosarc is almost entirely broken up into the elements *a*, *f*, *g*, *h*, of fig. 25. When the entire hydroid is cut up and pressed through gauze, again the same elements are found if the tissue is examined at once, although possibly more aggregates of cells occur than when stem tissue alone is used.

If the drop of live tissue pressed out through gauze, or squeezed out without using gauze, be kept under observation, it may be seen that small masses are soon formed which include entoderm cells, endoblasts, and the pale cells that probably are of ectodermic origin. As these masses grow in size it becomes impossible, owing to their opacity, to study their composition while alive.

As stated already, fusion between the cells of the pressed out stem tissue goes on so rapidly that in twenty minutes times small bars and plates, 1 to 3 mm. long, can be drawn off with a pipette. Some of these were preserved and sectioned and it could be seen that such masses were solid bodies of fairly uniform structure showing no stratification into incipient layers. The superficial part does not differ from the interior. The structure throughout is that of a cellular syncytium, that is in certain regions no cell boundaries can be seen, the protoplasm here appearing as a syncytial mass containing scattered nuclei, while in other places cell boundaries are visible. Even where cells are marked

out it is probable that they are interconnected with one another and the rest of the mass by protoplasmic strands. The cells that are marked out vary in size and shape. Here and there cells, usually in groups, may be recognized by the contained granules as the original entoderm cells. Only a small fraction of the mass however is now made up of such cells, and yet the entodermic elements composed a very large part of the tissue when the fusion masses began to form. It is plain then that the entoderm cells after fusion to form, or rather help form, the plasmodial masses, undergo a transformation which effectually precludes us from recognizing them later. The large endoblasts formed a conspicuous set of elements in the tissue when fusion began, and these are to be seen in very considerable numbers scattered throughout the plasmodial mass at the stage under examination (twenty minutes old). A comparison between the sections of this and later stages indicates that the bulk of the nematocysts carried over from the parent gradually disappear during the development of the plasmodial mass. If this is so, it is a question of some interest what becomes of the endoblast cell itself? Does it share in the formation of the regenerative tissue? The point is worthy of special study, including as it does the idea of the de-specialization of a highly differentiated element.

The protoplasm of the cell and syncytial areas in this stage is for the most part finely vacuolated so as to present a reticular appearance to a high power. The nuclei are in general large and contain abundant nucleoplasm. The mass at this time seems to have no surface film apart and distinct from the superficial syncytial and cell areas. Finally in connection with this stage it may be said that owing to the transformation which the entoderm cells undergo after fusion, it does not seem hopeful to attack from purely histological evidence the question as to whether ectodermic and entodermic elements become segregated, the ones on the outside, the others in the interior of the mass. There is of course always a possibility that this occurs, but it seems remote.

Somewhat older plasmodial masses formed by the fusion of stem tissue pressed through gauze were studied. These were preserved 1 hour after fusion had begun, and were considerably

larger than the mass just described. Sections show however that they have essentially the same structure. Cells or protoplasmic areas with the entoderm granules are still recognizable here and there. Perhaps most of such cells lie in the interior but some are found at the surface. This is not a point of importance for the question as to the possible segregation of ectodermic and entodermic elements, since as I have already explained a very large part of the entodermic material can no longer be recognized as such. It is clear that many of the areas or elements of the plasmodial mass now without granules, and with a vacuolated protoplasm, must have been formed from entoderm cells.

The solid plasmodial mass does not long remain unstratified. As already said the masses uniformly secrete a perisarc within about one day after fusion begins, and this in itself is probably evidence that the superficial layer has assumed something of an epithelial character. Masses preserved July 27, about seventeen hours old, were sectioned. Some of them were healthy and alive all through, and fig. 20 represents a section through such an one. In this body an outer layer, *ec.*, the ectoderm, has separated from an inner mass, *y. en.*, the yolk entoderm. The latter as later stages show gives rise to the definitive layer of entoderm and a central yolk mass, as in the planula development of *Pennaria* (Hargitt, '00, '04). Both ectoderm and yolk entoderm are cellular syncytia in which free elements or apparently free elements are included. In both the ectoderm and yolk entoderm, some of the large nematocysts carried over from the parent, are present. On one side of the body it will be seen the differentiation into layers has not yet been carried out, the ectodermal region here shading off into the inner mass. The isolated and irregular cavities in the yolk entoderm doubtless represent the beginnings of the gastric cavity. In other masses of the same lot preserved at the same time the shape was lobular, and only the projecting lobules were alive, while the more central part of the body was dead or dying. Sections showed that in the lobules the layers were present, in about the same stage of differentiation as in fig. 20.

Restitution masses from Experiment August 3 that were preserved nineteen hours after fusion began were sectioned. These proved to be in about the condition shown in fig. 20.

A mass two days old, from Experiment August 3, was sectioned, and a median section is represented in fig. 22. The mass was originally spheroidal, but gave rise to three short outgrowths *a*, *b*, *c*. In this body the ectoderm and entoderm are well differentiated. The yolk entoderm of the earlier stage has obviously given rise to the entoderm, *en.*, and to more centrally located yolk material, *y*, and the latter has been nearly absorbed. In places the entoderm is still continuous with yolk elements. The best sections show that the entoderm is still a reticular syncytium, but the cell bodies are distinctly outlined in places. In the most distinct regions they have a columnar shape as in the adult. The entoderm is now well stored with the spheroidal granules found in the adult cells. The ectoderm also appears to be in reality a reticular syncytium, but cell bodies are clearly differentiated and regularly arranged in the regions of the outgrowths. They have here an elongated, columnar shape. Some large nematocysts, apparently such as were carried over from the parent, are present in the ectoderm. A very few such nematocysts are found in the entoderm, and these seem to be in a phase of dissolution.

Other masses from the same experiment (August 3) that were four and five days old were sectioned, and the results may be briefly given. While the mass is still spheroidal and before it has developed outgrowths, it may differentiate an ectoderm, entoderm and central yolk. By the time a well defined layer of entoderm is present, the yolk mass is small in amount and consists of scattered spheres or small groups of spheres. In such spheroidal masses the ectoderm and entoderm have the character of reticular syncytia. As outgrowths develop, both ectoderm and entoderm assume the character of columnar epithelia, especially in the outgrowths themselves.

LEPTOGORGIA. FUSION OF DISSOCIATED CELLS

The species used was *Leptogorgia virgulata*, the 'sea feather' that is common, especially under piers, in Beaufort harbor. Some introductory experiments were made under my direction by my assistant, Mr. O. W. Hyman. He established the fact that when *Leptogorgia* is cut into small pieces, and these pressed in gauze sacs

in the usual way, the tissue is broken up into small masses and separate cells. By the subsequent union of such masses and cells, smooth balls up to and over 1 mm. in diameter are formed. These remain alive for days in laboratory dishes, but do not transform.

A record of two subsequent experiments is here given.

Experiment August 9. Pieces 4 to 5 mm. long are cut from the upper end of a yellow colony. The horny axis occupies about one-fourth the total diameter. These pieces are simply squeezed with forceps in a watch glass of water. The tissue exudes freely from the cut ends. Much of it is stringy. With pipette it is dispersed and so broken up. It is then shaken to the center of the watch glass and the glass transferred to a bowl of water, 11:15 a.m.

Some of the tissue is now examined under a supported cover. It is made up as follows: (1) Ciliated cords and masses, varying in size from large to minute are abundantly present. These are doubtless pieces of mesenterial filaments with mesenterial tissue. (2) Motionless masses of loosely packed cells, also varying considerably in size are abundant. (3) Isolated cells and groups of a few cells are abundant (fig. 26). In fig. 26, *a* represents a characteristic small cell group made up of a few spheroidal cells with sharp outlines, some full of highly refractive granules, some merely containing a good many such. Similar granules form a compact mass at one end of the cell group, but this mass lacks a bounding pellicle. Separate spheroidal granular cells, *b*, resembling the constituents of *a* are common, and they may have pseudopodia. There is an abundance of small spheroidal masses of glassy protoplasm, *c*, the larger with one or two granules. Finally there are plenty of isolated granules, *d*, such as are found in the granular cells. In the category *c* the smallest elements must surely be fragments of cells or bits of intercellular connectives that have rounded off.

The preparation under the microscope was watched for about an hour, and it was observed that fusion took place involving all the classes of constituents above enumerated. At 12 m. several of the larger ciliated masses were motionless, the surface bearing instead of cilia numerous small pseudopodia and transitional stages from cilium to pseudopod.

The tissue left in the bowl was examined at intervals. The masses grew evidently through fusion with one another and through incorporation of the granular cells and other elements. A typical mass at 2 p.m. is shown in fig. 27. The mass is full of granules like those of fig. 26, and in it the outlines of some spheroidal cells, like fig. 26 *b*, are distinguishable. Round it are similar granular cells and very many small masses of glassy protoplasm some with a few granules, some without any, ranging in size from mere points up nearly to the diameter of the granular cells.

By 9 p.m. the process of fusion had gone so far that spheroidal masses with smooth surface, from about $\frac{1}{2}$ mm. in diameter downwards, were present. A number of these were now picked out and transferred to fresh sea water. In the formation of these masses about ten hours transpired. It is evident that during this time some regressive differentiation of the fusing lumps of tissue to a simpler condition took place. What the character of these changes were and how uniform they were, it would be interesting to know.

The further history of the masses is briefly as follows. On August 10 they were alive. At this time they are perfectly opaque, and the smooth surface shows abundant fine flagellum-like pseudopods. Many of them are surrounded by a deposit of whitish material. This on examination proves to be made up of spheroidal cells of various sizes and degrees of granulation, which evidently have been slowly given off from the mass. This giving off of cells continues during the next day. It is probably evidence of a bad condition of the mass, and it is noteworthy that some of the masses do not exhibit it.

All of these bodies were preserved on August 11, and several were later sectioned. While still alive something could be learned of their histological structure by gently crushing them under a cover glass. On doing so some of the contents streams out in the shape of small spheroidal masses. The larger of these are like the granular cells (*b*) of fig. 26. From such they range down to minute particles of glass-like protoplasm just large enough to be seen at a magnification of 600. Of the intermediate sizes some are full of granules, others contain one or a few, while still others are

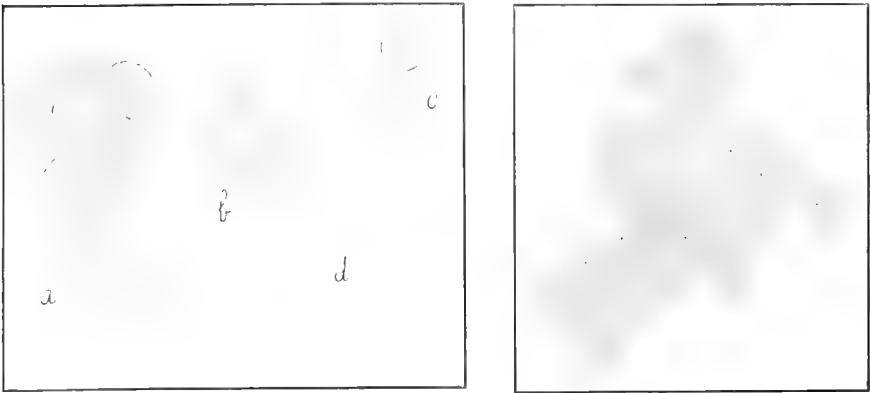

Fig. 26 *Leptogorgia*. Cell aggregate and free elements of pressed out tissue. $\times 1200$.

Fig. 27 *Leptogorgia*. Fusion mass two hours fifteen minutes old. $\times 150$.

without granules and glass-like. The granules in all these bodies are mostly of one size and yellowish. Such an examination by no means necessarily implies that in the natural condition the mass is composed of spheroidal cells. Rather, I assume that, on crushing, the cell bodies are separated and, where such exist, the intercellular strands are broken. A quick contraction would then make all the protoplasmic masses spheroidal. A body that has been slightly crushed under a cover glass in this way may heal. One such was kept for two hours in a moist chamber, and at the end of this time the body healed perfectly and was once more surrounded, as it originally was, by a smooth surface pellicle.

Sections showed that these bodies did not have a uniform composition. In one (ball 1) the structure was as follows: There is a surface film but sections give nothing definite as to its composition. The interior is solid and shows no stratification into layers (ectoderm and entoderm). In many regions one finds protoplasm studded with nuclei but no cell boundaries can be made out. In other places there are small cells, rounded or angular that are very closely packed. In still other places while the tissue is compact the cells are slightly separated by unstained substance, probably fluid. In such places the cell bodies are distinctly outlined and intercellular strands of protoplasm are freely present.

In a few small areas there is a scanty accumulation of mesogloal jelly imbedded in which are some strands and small masses of nucleated protoplasm which are freely interconnected. The jelly stains blue with haemalum (or haematoxylin) and with a 2 mm. objective appears homogeneous. These several observations show that the mass is a syncytium in different parts of which cell bodies are differentiated in various degrees.

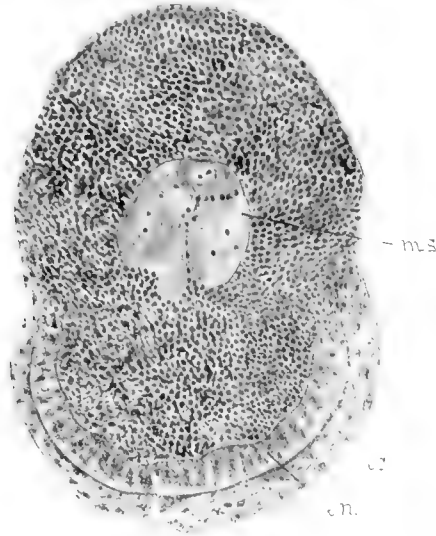

Fig. 28. *Leptogorgia*. Median section of a fusion mass two days old. Layers interpreted as ectoderm, *cc*, and entoderm, *cn*, have developed. *ms*, mesogloal jelly. $\times 350$.

Another mass (ball 2) has the structure shown in fig. 28. There is a surface film which appears as a mere line. The general mass consists of the syncytial cellular tissue described for ball 1, but round half of the body two layers, apparently the ectoderm and entoderm, are differentiated. These layers are distinctly differentiated, although there is no mesogloal jelly between them. At about the middle of the body they fade away into the general mass. The entoderm consists of more or less columnar elements,

the ectoderm of irregular cell bodies separated by a good deal of fluid and freely interconnected. Near the center of this ball is a considerable collection of mesogloal jelly, of the same character as that described for ball 1.

In still another case (ball 3) while a part of the body resembles ball 1, at one end of the body the structure is that shown in fig. 29. We find here an accumulation of finely granular, lightly stained material, *cg*, which is quite different from mesogloal jelly and is probably a fluid that has coagulated in the fixation process.

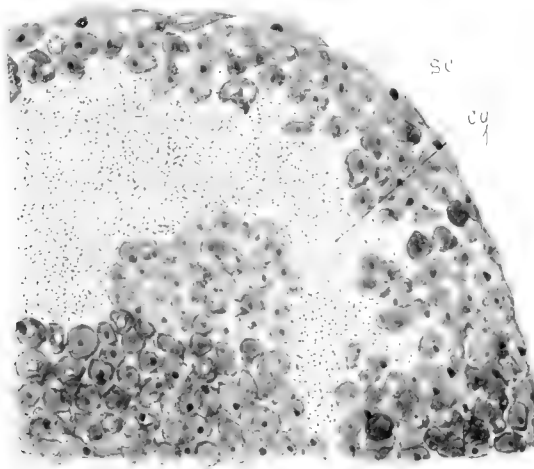

Fig. 29 Leptogorgia. Part of section through a fusion mass two days old. *cg*, coagulum; *s.c.*, superficial cells. $\times 1200$.

The same ball contains some mesogloal jelly near the center. In the region round the coagulated fluid the cells are loosely packed. They are more or less rounded and intercellular connections are practically absent. Vacuoles are common in these cells and a conspicuous nucleolus is frequently to be seen. In this region the surface layer is formed of flattened cells, *s. c.* In this ball there is no differentiation of ectoderm and entoderm layers.

Interpreting the results of this study of sections, it seems probable that ball 1 represents an earlier stage, and ball 2 a later one in which the coelenterate layers have begun to differentiate.

In ball 3 the condition shown in fig. 29 is perhaps to be correlated with the gradual extrusion of rounded granular cells which goes on in the case of some of the masses during life, as already recorded. Such a condition is one, perhaps, into which the dense syncytial cellular structure passes when the struggle for life is going against the body. It may of course only be a mortuary change, viz., a step in a process of gradual dying.

The results of this experiment, while very inconclusive, suggest that the bodies formed by the fusion of cell masses and cells would regenerate into new individuals if placed under good conditions, possibly hung out in gauze bags in a part of the harbor where the current is good.

Experiment August 10. Small pieces of a *Leptogorgia* colony were pressed out through gauze at 4.30 p.m. The tissue that streams through the gauze is finer than that obtained in the experiment just recorded. It is made up of the elements shown in fig. 26 and of small opaque lumps of tissue, mostly spheroidal and many of them ciliated, which are commonly three or four times the diameter of one of the granular cells (fig. 26 *b*). The living tissue and the spicules are separated as far as possible.

Fusion goes on and by 7 p.m. masses of irregular shape are present. These are transferred to fresh sea water. The next morning a number of smooth balls have been formed, some of which have incorporated spicules. These are kept for a couple of days during which they show no external signs of differentiation. Sections showed that these balls had essentially the same structure as those of the preceding experiment.

Experiment to test the regenerative powers of a fusion mass when inserted in the body of the parent species. August 10. Six of the *Leptogorgia* fusion masses produced in the experiment of August 9 were inserted in the parent species in the following way. A piece of an orange colored *Leptogorgia*, about five inches long, was slit lengthwise down to the horny axis. The slit so made was pushed open and the fusion masses dropped in with a pipette in a row. Ties were then made round the piece of *Leptogorgia* closing up the covering layer of polyps over or partly over the fusion masses.

On August 11, 10 a.m., the ties are removed. The slit has not healed but the edges have curled in. The whitish fusion masses

may be seen in the slit. They have fused with one another in some degree, the number of masses now being four. The piece of *Leptogorgia* looks healthy; the polyps are well expanded. At 7 p.m. the whole preparation is preserved. The questions are: Have the fusion masses undergone any histological differentiation? Have they established union with the *Leptogorgia*?

Sections through one of the masses showed that the body had grown deeper into the slit and had established connection with the *Leptogorgia* on one side of the slit. This connection included perfect continuity with the entodermic lining of a coelenteric cavity which had been laid open, and also with the entoderm of several small coenenchymal canals in the neighborhood. The whole fusion mass is solid and somewhat club-shaped at its outer end where it shows a stratification into an outer stratum and an inner core. The thickness of the outer stratum is considerable including several layers of cells. The other masses did not penetrate so deep into the slit. They were found to be in continuity with the superficial layer of the *Leptogorgia*, but had not established connection with the interior of the latter.

The indication from this experiment, which was merely meant as a tentative one, is that the fusion masses if allowed to grow would have become part of the *Leptogorgia* colony.

ASTERIAS. FUSION OF THE DISSOCIATED CELLS OF THE IMMATURE GONAD

Experiment August 5. Gonads 25 mm. long of the common starfish, *Asterias arenicola*, were cut into pieces about 5 mm. long and these were pressed through gauze at 12 m. Abundant separate cells and small cell aggregates stream through the gauze together with some larger pieces of gonad. The latter are picked out, and the remaining material is shaken to the center of watch glass. A drop of the material is now examined under the microscope. Many of the cells whether free or combined in small aggregates are coarsely granular. Both cells and aggregates show fine pseudopodia. The cells and the aggregates quickly combine and in a few minutes the field of the microscope presents the appearance shown in fig. 30. There are numerous small masses, such as *a*, which have been formed by the fusion of cell aggregates

and separate cells; and there is an abundance of free elements. Among the latter coarsely granular cells like *b*, with and without pseudopodia, are conspicuous. There are also many clear glass-like cells (*c*) ranging down to bits just visible. Free granules resembling those of the granular cells are abundant. The masses (*a*) make the impression of being aggregations of the granular cells (*b*), but doubtless other elements enter into their composition. Abundant fine pseudopodia, occasionally branched, cover the surface of such masses.

By 1 p.m. the tissue in the watch glass has combined to form a thin and extensive reticular plate, produced by the gradual

a

b

c

Fig. 30 Asterias. Small fusion mass and free elements of pressed out gonad tissue. *a* \times 600. *b* and *c* \times 1200.

fusion of masses of many shapes. The reticulum in general is attached, though feebly, to the glass, but pieces 1 to 2 mm. wide have been broken off and are free. At 7 p.m. the whole reticulum is broken up into pieces of about this size, and all transferred to fresh sea water. On the following day a number of such pieces had contracted into smooth, massive bodies. But all pieces died in a day or two.

Experiment August 16. Gonads 20 mm. long were used. The gonads were cut into pieces and these simply teased up with needles in a watch glass of sea water. The pieces are thus broken into small masses, cells, and fragments, essentially like those shown in fig. 30. Fusion commences at once as in the former experiment, the isolated cells and the masses both throwing out pseudopodia. The granular cells in particular are observed to become interconnected by delicate and complex pseudopodial networks. The formation of pseudopodia by the granular cells may go on to such an extent that the granular substance of the cell body almost disappears in the network of pseudopodial strands. This experiment was not carried farther.

Sections showed that the gonads used in these experiments were in the indifferent stage. The germinal epithelium lining the follicle is more than one layer deep, and many of the nuclei are large and rich in chromatin. The epithelium has proliferated to such an extent that the lumen is nearly filled with cells. In sections these are compressed, with rather vaguely granular cytoplasm and nuclei which are smaller than in the lining cells. When the living gonad is slightly pressed, these cells exude and appear as the spheroidal granular elements described above.

LITERATURE CITED

- BRAEM, F. 1908 Die Knospung der Margeliden, ein Bindeglied zwischen geschlechtlicher und ungeschlechtlicher Fortpflanzung. Biol. Centralblatt, Bd. 28.
- CHILD, C. M. 1906 The development of germ cells from differentiated somatic cells in Moniezia. Anat. Anzeiger, Bd. 29.
1911 Die Physiologische Isolation von Teilen des Organismus als auslösende Faktor der Bildung neuer Lebewesen und der Restitution. Vorträge u. Aufsätze ü. Entw.-Mech. d. Organismen, Heft 11.
- CURTIS, W. The life history, the normal fission and the reproductive organs of Planaria maculata. Proc. Boston Soc. Nat. Hist., vol. 30.
- DRIESCH, H. 1902 Studien ü. das Regulationsvermögen der Organismen: 6. Die Restitutionen von Clavellina lepadiformis. Arch. f. Entw.-Mech. Bd. 24.
- EVANS, R. 1899 The structure and metamorphosis of the larva of Spongilla lacustris. Quart. Journ. Micr. Sci., vol. 42.

- HARGITT, C. W. 1900 A contribution to the natural history and development of *Pennaria tiarella* McCr. *Amer. Naturalist*, vol. 34.
1904 The early development of *Pennaria tiarella* McCr. *Arch. f. Entw.-Mech.*, Bd. 18.
- LIEBERKUHNS, N. 1856 Beiträge zur Entwicklungsgeschichte der Spongillen. *Archiv für Anat. u. Physiologie*, J. Muller.
- MAAS, O. 1901 Die Knospungentwicklung der *Tethya* und ihr Vergleich mit der geschlechtlicher Fortpflanzung der Schwämme. *Zeitschr. f. wiss. Zool.*, Bd. 70.
1906 Ueber die Einwirkung Karbonatfr. Salzlösungen auf erwachsene Kalkschwämme u. auf Entwicklungsstadien derselben. *Arch. f. Entw.-Mech. d. Organismen*, Bd. 22.
1910 Ueber Involutionerscheinungen bei Schwämmen u. ihre Bedeutung für die Auffassung des Spongienkörpers. *Festschr. z. sechzigsten Geburtstage Richard Hertwigs*, Bd. 3.
- METSCHNIKOFF, E. 1879 Spongiologische Studien. *Zeitschr. f. wiss. Zool.*, Bd. 32.
- MÜLLER, KARL 1911a Versuche ü. die Regenerationsfähigkeit der Süßwasserschwämme. *Zool. Anzeiger*, Bd. 37, Nr. 3-4.
1911b Beobachtungen über Reduktionsvorgänge bei Spongilliden, nebst Bemerkungen zu deren äusserer Morphologie u. Biologie. *Ibid.*, Nr. 5.
- NUTTING, C. C. 1901 The hydroids of the Woods Hole Region. *Bulletin of the U. S. Fish Commission for 1899*.
- PERKINS, H. F. 1902 Degeneration phenomena in the larvae of *Gonionema*. *Biol. Bulletin*, vol. 3.
- SCHULTZ, E. 1904 Ueber Reduktionen: 1. Ueber Hungererscheinungen bei *Planaria laeta*. *Arch. f. Entw.-Mech.*, Bd. 18.
1906 Ueber Reduktionen: 2. Ueber Hungererscheinungen bei *Hydra fusca* L. *Ibid.*, Bd. 21.
1907 Ueber Reduktionen: 3. Die Reduktion u. Regeneration des abgeschnittenen Kiemenkorbes von *Clavellina lepadiformis*. *Ibid.*, Bd. 24.
1908 Ueber umkehrbare Entwicklungsprozesse u. ihre Bedeutung für eine Theorie der Vererbung. *Vorträge u. Aufsätze über Entwicklungsmechanik d. Organismen*, Heft 4.
- WELTNER, W. 1893 Spongillidenstudien II. *Archiv f. Naturgeschichte*, Jahrg. 1893, Bd. 1.
- WILSON, H. V. 1888 On the development of *Manicina arcolata*. *Journ. of Morphology*, vol. 2.
1894 Observations on the gemmule and egg development of marine sponges. *Ibid.*, vol. 9.
1907a A new method by which sponges may be artificially reared. *Science*, vol. 25, June 7, 1907.
1907b On some phenomena of coalescence and regeneration in sponges. *Journ. Exper. Zool.*, vol. 5.
1911a On the regenerative power of the dissociated cells in hydroids. *Proc. Amer. Soc. Zoologists, Science*, Mar. 10.
1911b Development of sponges from dissociated tissue cells. *Bulletin of the Bureau of Fisheries*, vol. 30.

RHYTHMS IN THE REPRODUCTIVE ACTIVITY OF INFUSORIA

LORANDE LOSS WOODRUFF AND GEORGE ALFRED BAITSELL

Sheffield Biological Laboratory, Yale University

THIRTEEN FIGURES

In a study of the life history of *Paramecium caudatum* by pedigree cultures, Calkins clearly illustrated the cycle, while the rhythms in the division rate were later emphasized by Woodruff in a study of the life history of several species of hypotrichous Infusoria. The fluctuations in their rate of reproduction were classified as follows:¹

“A rhythm is a minor periodic rise and fall of the fission rate, due to some unknown factor in cell metabolism, from which recovery is autonomous.”

A cycle is a periodic rise and fall of the fission rate, extending over a varying number of rhythms, and ending in the extinction of the race unless it is ‘rejuvenated’ by conjugation or changed environment” (cf. fig. 1).

Gregory, in a study of the life history of *Tillina magna*, stated that “The curve which represents the general vitality of the protoplasm shows the normal rhythmic fluctuations observed by Woodruff.” Gregory also made an analysis of the data secured by Popoff in his study of the life history of *Stylonychia mytilus*, and she stated that “If the curve of *Stylonychia* is plotted from average records of five and ten day periods, it will be found to correspond to the curves of *Paramecium*, *Oxytricha* and *Tillina*, each showing the rhythmic periods of high and low vitality.” More recent work has shown that *Paramecium aurelia* may be bred indefinitely on a culture medium which is varied from day to day,² i.e., the cycle does not occur under these conditions though

¹ Woodruff ('05).

² Cf. Woodruff ('11a), Taf. 26, 27.

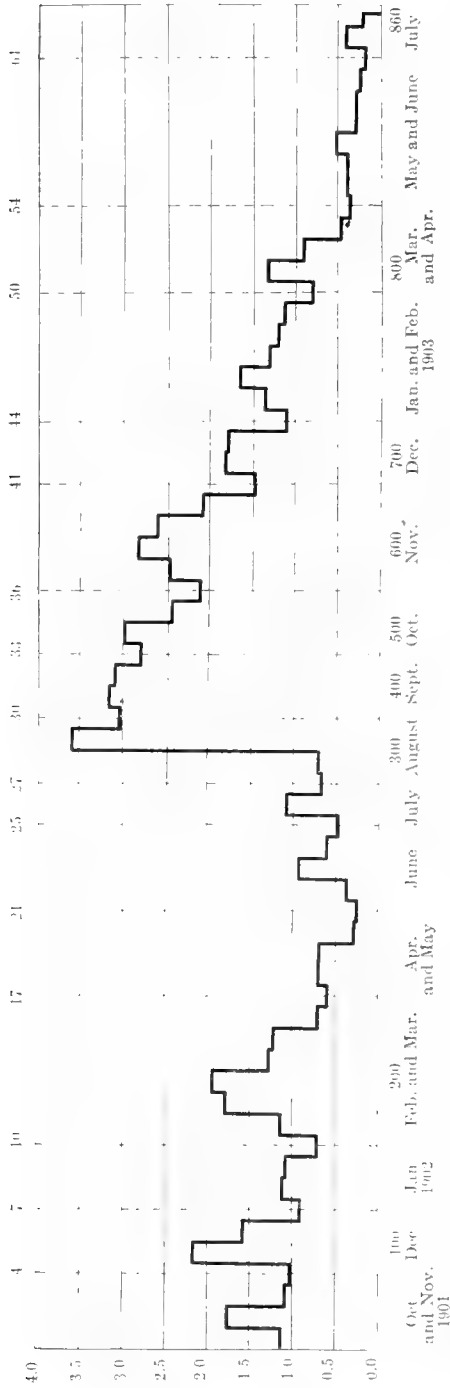

Fig. 1 Graph of the life history of *Oxytricha fallax*, culture A, showing the average daily rate of division of the four lines of animals, again averaged for *ten day* periods. 'Rejuvenated' at end of first cycle by artificial stimulation. To illustrate 'cycles' and 'rhythms' in the fission rate of infusoria under pedigree culture methods. The limits of the various rhythms are designated by vertical broken lines. (Woodruff, '05)

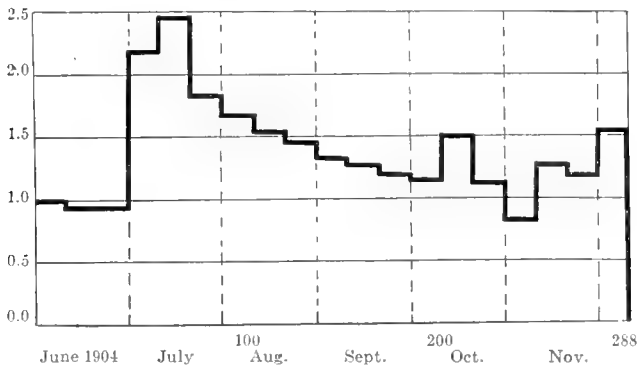

Fig. 2 Graph of the life history of *Gastrostyla steinii* showing the average daily rate of division of the four lines of animals which compose the culture, again averaged for *ten day* periods. Hay infusion culture medium. To illustrate a case where the rhythms are apparently absent for a considerable period. Compare with fig. 3. (Woodruff, '05)

the rhythms persist undiminished; and also that the same result may be attained by a constant culture medium of beef extract³ (cf. fig. 4).

It is obvious from these investigations that the life history of Infusoria in pedigree cultures comprises many minor rhythmic fluctuations in the fission rate from which recovery is autonomous. The results with beef extract as a constant medium for *Paramecium aurelia* naturally led to an intensive study of the rhythms, in order to determine if these also can be eliminated by a still more constant environment, i.e., whether they are due to minor variations in the environment or to unknown intracellular phenomena, as originally stated. Possible sources of variation in the environment which might give rise to variations in the metabolism of the cell which would become apparent as rhythms in the rate of reproduction are: 1) Chemical composition of the culture medium, 2) Quantity and quality of the bacterial flora of the culture medium, 3) Excretion products of the paramaccia, 4) Mechanical stimulation during isolation, 5) Light, 6) Barometric pressure, and 7) Temperature. The data secured which bear on this question are given in the present paper.

³ Woodruff and Baitsell ('11).

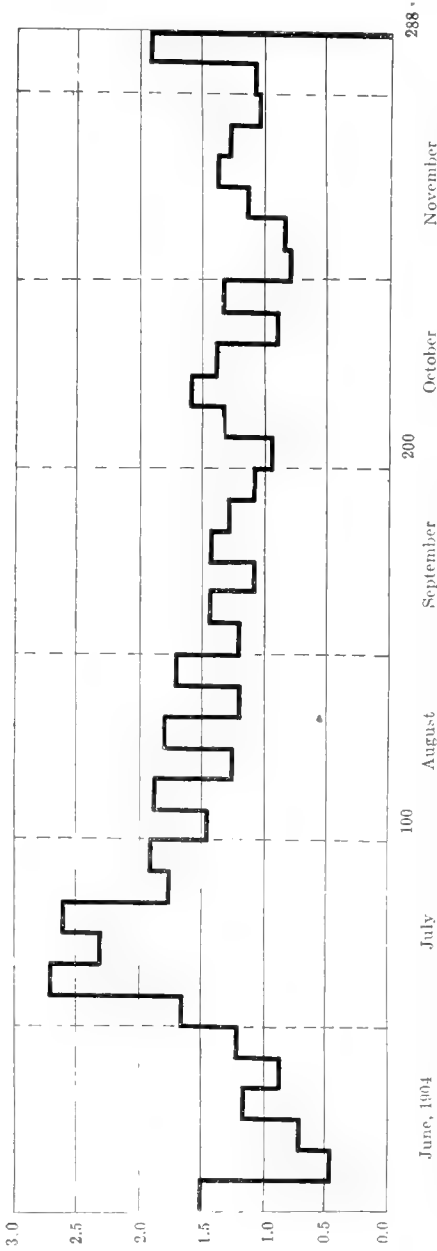

Fig. 3 (Graph of the life history of the same culture of *Gastrostyla steinii* shown in fig. 2. Data plotted here for five day periods. To illustrate the fact that although rhythms may not appear for a certain length of time when the rate is averaged for ten day periods, nevertheless they are present and can be brought to view by an average for a shorter period. (Woodruff, '05)

METHODS

The animals employed in this study were taken from the pedigree culture of *Paramecium aurelia* (I) which one of us⁴ has had under daily observation for fifty-one months and which has attained 2500 generations, up to the present time (August 1, 1911), under the conditions of a varied environment, without conjugation or artificial stimulation. From this culture a subculture was isolated line by line on October 1, 1910, at the 2012th generation, and carried for ten months on a constant culture medium of beef extract. It was then discontinued.⁵ The average daily rate of division of the four lines of this subculture (IB), again averaged for five day periods, was computed and the result is graphically shown in fig. 4.

The experiments in regard to the rhythms were begun on June 8, 1911, by isolating two subcultures line by line from IB at the 2335th generation, and placing the animals in a similar manner on depression slides in five drops of the beef extract medium. This medium consisted of a 0.025 per cent solution of Liebig's extract of beef. The slides were kept in small moist chambers to prevent evaporation. The cultures were continued by isolating each day an organism from each of the four lines of the respective cultures, and placing it in fresh medium on a sterile depression slide. The number of divisions during the previous twenty-four hours was recorded at the time of isolation and from this data the graphs were drawn. One of these two subcultures was placed in a thermostat chamber at a temperature of practically 82° F. (culture IB82a) and the other in a chamber at a temperature of practically 76° F. (culture IB76a), and maintained at this temperature for forty days.

A second series of two subcultures was similarly started from IB on June 18th, at the 2346th generation, and treated exactly the same as the above cultures. The cultures of this series were designated IB82b and IB76b, respectively. A third series of two subcultures was isolated in the same manner from IB on June 28th, at the 2355th generation, and these cultures were

⁴ Woodruff ('11a).

⁵ For further details of this subculture (IB) cf. Woodruff and Baitzell ('11).

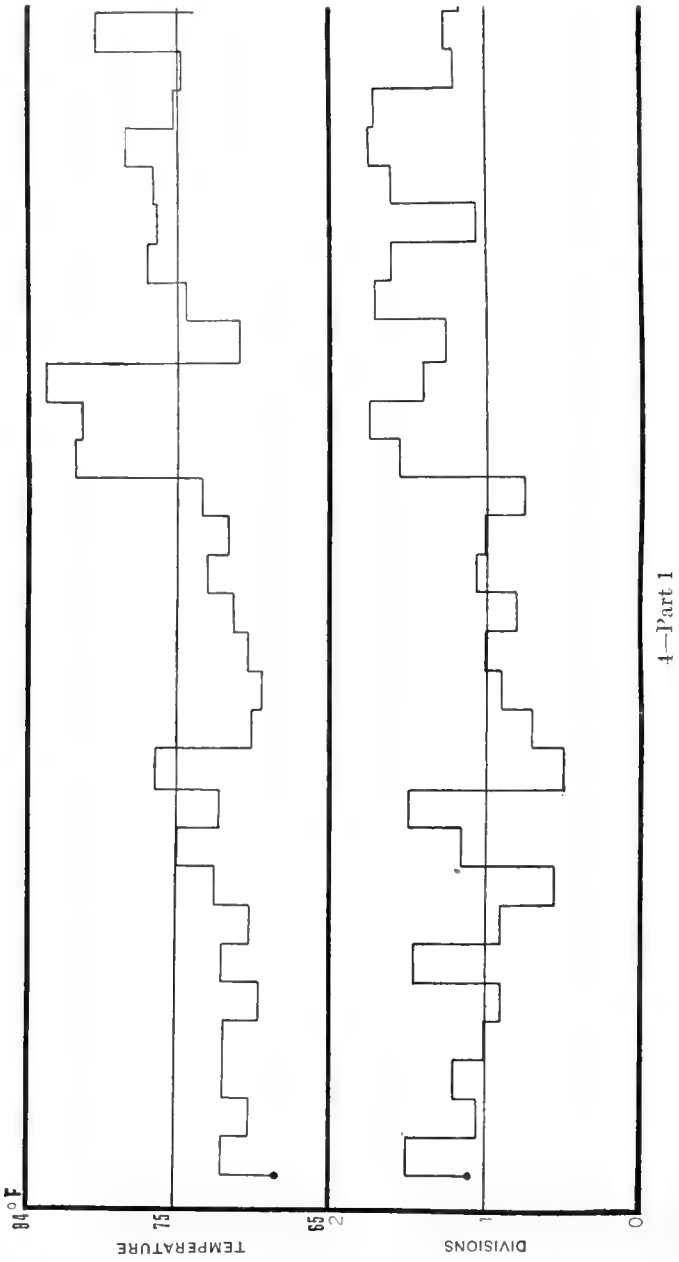

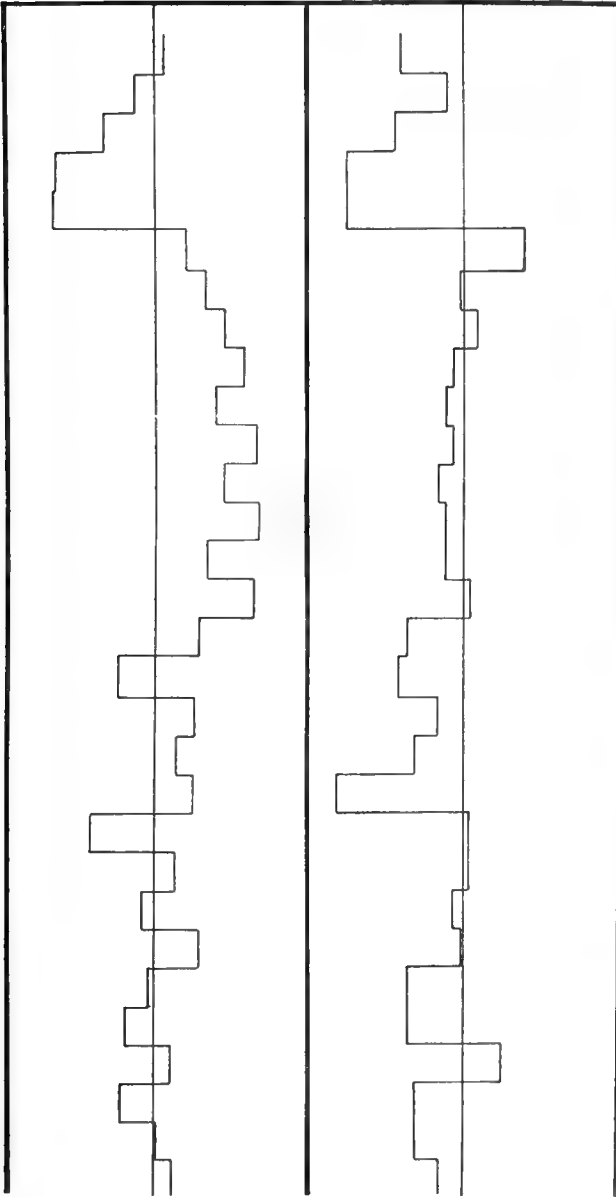

4-Part 2

Fig. 4 (parts 1 and 2) The lower graph gives the complete history of *Paramaecium aurelia*, subculture IB, from the time of its isolation from culture I on October 1, 1910, until it was discontinued on July 29, 1911. Beef extract culture medium. The ordinates represent the average daily rate of division of the four lines of 'sister' cells which comprise this culture, again averaged for *five day* periods. The upper graph gives the average room temperature ($^{\circ}\text{F.}$) for the corresponding periods. To illustrate the fact that although the cycle does not occur when a suitable constant culture medium of beef extract is employed, nevertheless the rhythms persist.

designated IB82c and IB76c. There were then the following cultures, all of which were kept in the dark, involved in this experiment:

IB—at room temperature.

IB82a—isolated from IB and continued for forty days at 82° F.

IB76a—isolated from IB and continued for forty days at 76° F.

IB82b—isolated from IB and continued for forty days at 82° F.

IB76b—isolated from IB and continued for forty days at 76° F.

IB82c—isolated from IB and continued for thirty days at 82° F.

IB76c—isolated from IB and continued for thirty days at 76° F.

Since the entire point involved in this study depends upon the constancy of the environment to which the animals are subjected, this will be considered in detail.

1. *Chemical composition of the culture medium.* The culture medium was made up by weighing out the proper amount of Liebig's extract of beef and diluting it with distilled water. The solution was then put into about one hundred test tubes, plugged with cotton and sterilized. The medium remained sterile until used. Since all the culture medium which was used throughout the experiment was made up at one time there was no variation in the medium itself during the work.

2. *Quantity and quality of the bacterial flora of the culture medium.* Paramaecium is an animal which depends on bacteria for its food, and consequently these must be supplied. Sufficient bacteria were 'automatically' transferred with the animals at the first isolation to provide ample food until the next isolation at the end of twenty-four hours. Again at this time sufficient bacteria were 'automatically' carried over with the animals to infect the fresh medium in which they live for the following twenty-four hours, and so on. The quality of the bacterial flora was initially the same on all the slides because all the paramaecia used to start the various lines were taken from the same environment when the experiments were begun, and it is believed that this condition was maintained by the cross infection of all the slides almost daily. This also served to eliminate variations due to infections from the air of the moist chambers. Obviously the number of bacteria on a slide varied during the twenty-four hours between isolations.

But a study of the preparations showed that the paramaecia keep down the results of the rapid multiplication of the bacteria by feeding on them, so that, although there is ample food for the animals at all times, the variation in the bacterial content of the medium is not so great as would at first glance appear to be the case. However, the point to be emphasized is that these variations, small as they were, were only of twenty-four hour duration since fresh culture medium was supplied daily. Consequently any effect of the slight and unavoidable variation in the quantity of the bacteria could result only in an intradiurnal rhythm in the division rate, and since the count of the generations was taken at twenty-four hour intervals, this variation would not appear in our records. Elaborateness of method is not necessarily coincident with exactness of technique, and therefore it was considered unnecessary to attempt to 'sterilize' the paramaecia and feed them on pure cultures of bacteria. Any effort in this direction has met only with partial success and has introduced complicating factors which, it is believed, would more than counterbalance any advantages to be gained for the problem in hand.

3. *Light.* Throughout the experiments all the cultures were in absolute darkness except for the short time daily when the count was being made. This was unavoidable, but each animal was not exposed to the light for more than three minutes. A control culture carried in the light showed that light does not influence the rate of reproduction of paramaecium. This is in accord with the previous results⁶ on the effect of light on the division rate of free-living Infusoria.

4 and 5. *Excretion products of paramaecia and mechanical stimulation during isolation.* These factors may be eliminated because they could only give rise to an intradiurnal rhythm which would not appear in the data.

6. *Barometric pressure.* A careful study was made of the variations in the barometric pressure which occurred during the experiments. There was absolutely no correlation between the small fluctuations in pressure and the rhythms in the division rate, and

⁶ Maupas ('88) and Woodruff ('05).

consequently it can be positively stated that this factor plays no part in our results.

7. *Temperature.* This is the chief possible variable in the environment which we have to consider. In the original discussion of rhythms it was stated that "the results serve to emphasize the fact that while temperature does influence the rate of multiplication, it is not the most important element among the factors which cause fluctuations." A study of figs. 4 and 5 shows that there is a certain amount of correlation between the fluctuations of fission rate and of temperature, when the cultures are subjected to the ordinary changes in temperature of the laboratory.

Our experiments were carried on in a Panum thermostat,⁷ heated at one end with a gas flame (with an automatic regulator) and cooled at the other by a large ice chest. The thermostat was divided into nine chambers, grading down in temperature from one end to the other of the apparatus. The temperature was recorded in each chamber by a maximum and minimum registering thermometer, by a tube thermometer, and in one chamber also by a thermograph. Experiments were conducted in six of the nine compartments, but an account is given here of the results of the cultures at the two temperatures within the optimum zone for the strain of *Paramecium* being used. The detailed data in regard to the effect of different temperatures on the division rate of this animal and its relation to the temperature coefficient of chemical reactions in general will be published later. We should state, however, that our results at other temperatures are entirely concordant with those here described.

The temperature selected for the study of the influence of temperature on the rhythms were approximately 82° F. and 76° F. as it was found that the optimum zone for the culture included these points. During the fifty days that the experiments covered the variations in temperature did not exceed 3° F.; for the greater part of the time the variation was less than 1° F., and for several periods it was less than 0.5° F. The greatest variation noted

⁷ This apparatus was constructed for this and similar studies from an improved model designed by Professor L. F. Rettger of the Sheffield Bacteriological Laboratory of Yale University. Our thanks are due Dr. Rettger for his kind cooperation.

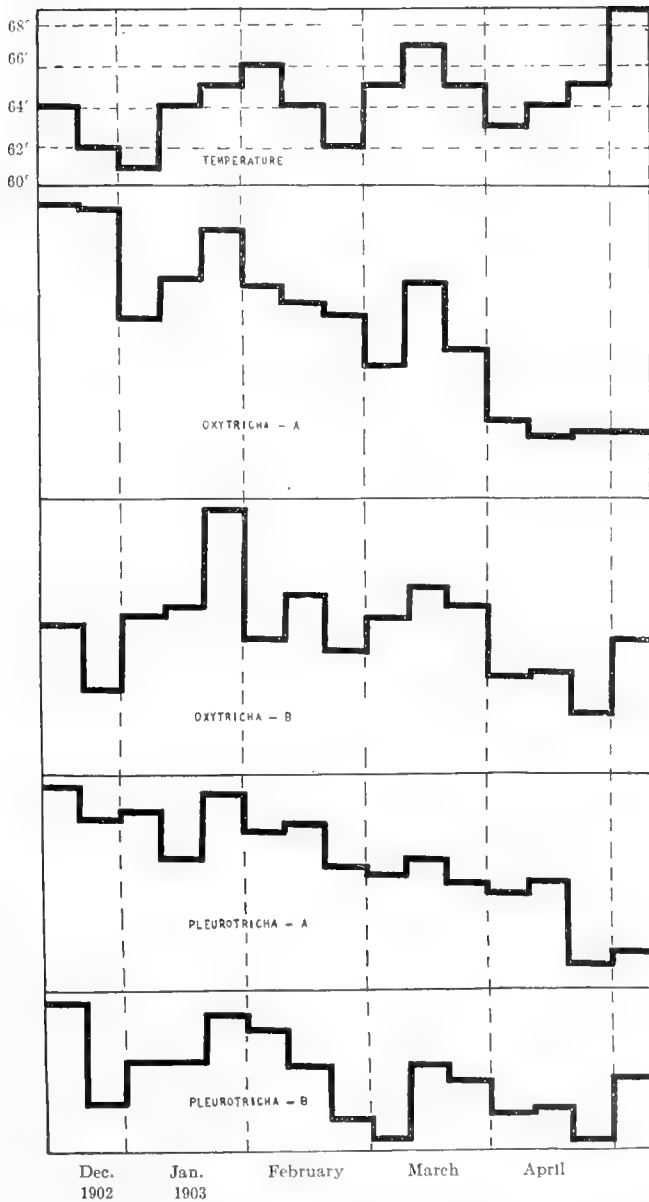

Fig. 5 Sections of the culture graphs of two cultures of *Oxytricha fallax* and two cultures of *Pleurotricha lanceolata*, together with the graph of the average room temperature for the same period. Averages for *ten day* periods. To illustrate a striking instance of the apparent relation of rhythms to the fluctuations in temperature. (Woodruff, '05)

above occurred during a week of unusually hot weather when the sudden change was too great to be immediately compensated for by the automatic regulator. Great care was taken in removing the preparations from the chambers for the daily count and isolation. The culture medium to be used on one day had been put the day before in the proper chamber of the thermostat, and consequently the animals were transferred to fresh culture medium of the same temperature. Of course any effect of variations arising from the daily transfers could only be intradiurnal and consequently would not appear in our results. It should also be emphasized that the recorded temperature was that of the air in the thermostat, whereas the animals were in culture fluid on slides within the moist chambers in the thermostat. The temperature of the moist chambers obviously was still more constant than that of the thermostat chamber, as likewise was the liquid in which the organisms were living. Consequently the variations in temperature which the animals experienced certainly never exceeded 3° F. throughout the experiments, and this maximum variation occurred only at one period. For a period of ten consecutive days there was no visible variation greater than 0.4° F. It is believed that the temperature conditions were maintained as nearly constant as modern apparatus and the necessities of the experiment allowed.

RESULTS

The results can be stated briefly because graphs of the rate of reproduction bring out the points involved far better than a description by words. Fig. 6, *A*, gives the average daily rate of division of the four lines of 'sister' cells of *Paramecium aurelia*, series IB82a, again averaged for ten day periods, at 82° F. *B* and *C* show the same for series IB82b and IB82c. Fig. 7, *A*, *B*, and *C*, shows similarly the results derived from IB76a, and IB76b, and IB76c. Figs. 8 and 9 give the same data averaged for five day periods. Fig. 10 shows the average daily rate of division, for five day periods, of line 1 (of the four lines) of series IB82a and line 1 of IB76a. Fig. 11 gives the same data for series IB82b and IB76b. Fig. 12 presents the average daily rate of division

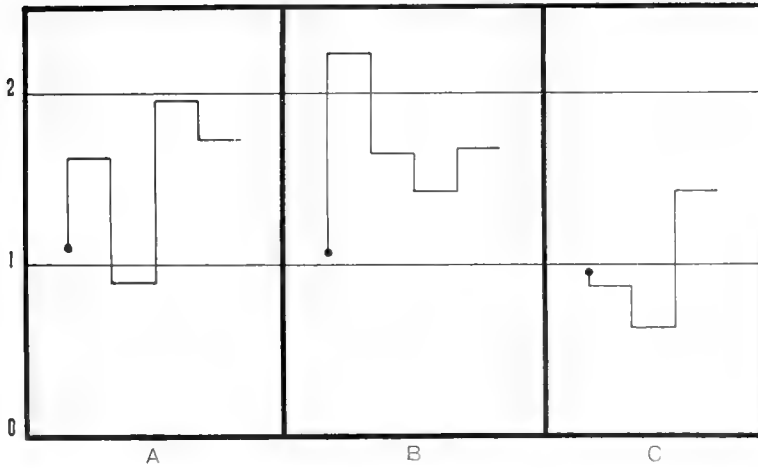

Fig. 6 *A*, Graph of the average daily rate of division at 82°F. of the four lines of 'sister' cells of *Paramaecium aurelia*, series IBS2a, again average for *ten day* periods. *B* and *C*, Similar graphs for series IBS2b and IBS2c respectively. To illustrate rhythms in the fission rate when the cultures are subjected to practically constant conditions, including temperature.

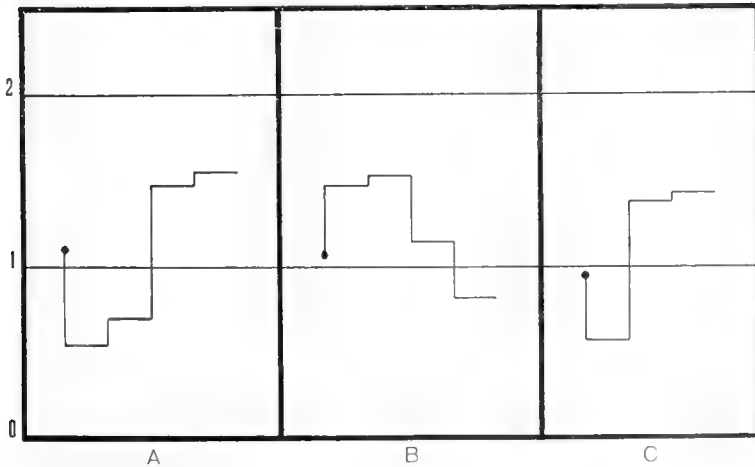

Fig. 7 *A*, Graph of the average daily rate of division at 76°F. of the four lines of 'sister' cells of *Paramaecium aurelia*, series IB76a, again averaged for *ten day* periods. *B* and *C*, Similar graphs for series IB76b and IB76c respectively. To illustrate rhythms in the fission rate when the cultures are subjected to practically constant culture conditions, including temperature. Compare with fig. 6.

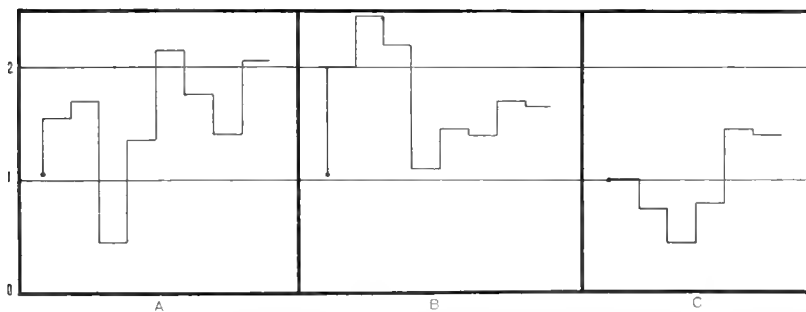

Fig. 8 A, Graph of the average daily rate of division at 82°F. of the four lines of 'sister' cells of *Paramaecium aurelia*, series IBS2a, again averaged for *five day* periods. B and C., Similar graphs for series IBS2b and IBS2c respectively. To illustrate the fact that rhythms in the rate of division appear more pronounced under practically constant environmental conditions. Compare with the last ten periods of the culture subjected to room temperature changes (fig. 4).

of the four lines of IBS2a and IB76a, respectively. The vertical dotted lines include the ten day period during which temperature variations were entirely absent, or not greater than 0.4° F. Fig. 13 gives the same results for series IBS2b and IB76b during the ten days of most constant temperature.

A study of these graphs of the rate of reproduction of *Paramaecium* shows that the exceptionally and practically constant conditions of the environment failed to diminish or eliminate the rhythms—but on the contrary tended to bring them out more clearly. The fact that the rhythms appear more pronounced

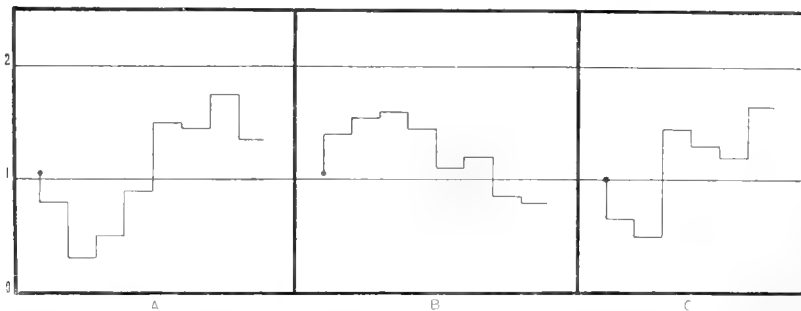

Fig. 9 A, Graph of the average daily rate of division at 76°F. of the four lines of 'sister' cells of *Paramaecium aurelia*, series IB76a, again averaged for *five day* periods. B and C., Similar graphs for series IB76b and IB76c respectively. To illustrate the same point as fig. 8.

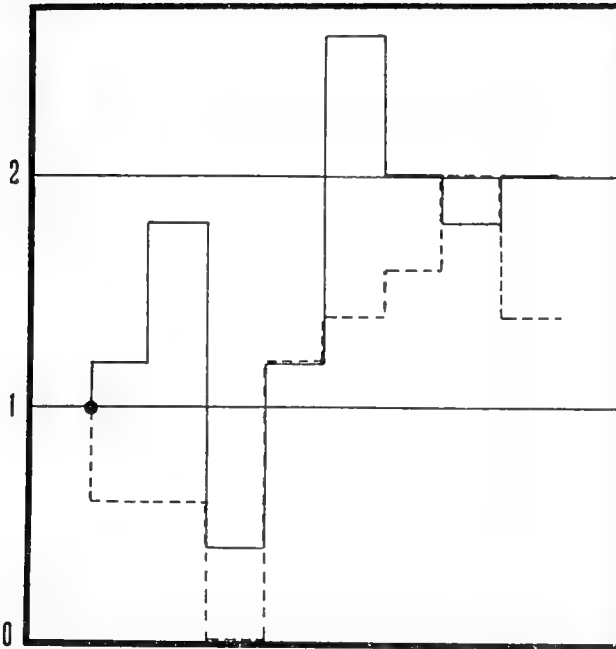

Fig. 10 Graph of the average daily rate of division for *five day* periods of line 1 (of the four lines of 'sister' cells) of series IB82a (= continuous line) and of line 1 (of the four lines of 'sister' cells) of series IB76a (= - - - - line). To illustrate the fact that rhythms of practically the same amplitude and character appear in a graph of a *single line of cells* as appear when four such lines are averaged together. Compare with fig. 8, section A, and fig. 9, section A.

under the practically constant conditions existing during these experiments than they do under ordinary laboratory conditions, clearly suggests that they are due to a fundamental factor in cell phenomena and not to extraneous causes. For if they are due to inherent intracellular conditions, one would *a priori* expect to find them more clearly brought out when the cell is free from extraneous influences.

A study of the curves of the division rate at the two temperatures shows that temperature, as is well known, markedly influences the rate, but it also shows that the rhythms persist—the reproductive activity being, as it were, pitched at a higher scale, but its character in no wise altered. In other words, it is not sug-

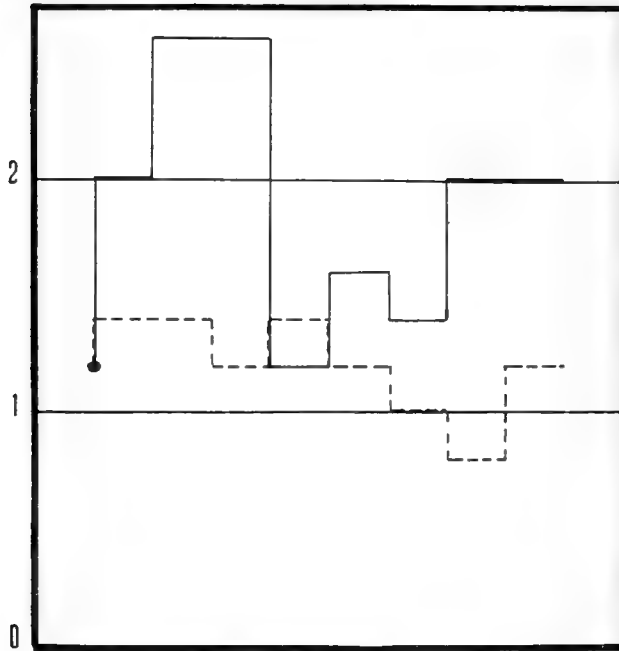

Fig. 11 Graph of the average daily rate of division for *five day* periods of line 1 (of the four lines of 'sister' cells) of series IBS2b (= continuous line) and of line 1 (of the four lines of 'sister' cells) of series IB76b (= - - - - line). To illustrate the same points as fig. 10. Compare with fig. 8, section B, and fig. 9, section B.

gested that the division rate is not largely a function of temperature—all other conditions being equal. It is probable that the temperature coefficient of the mean rate of division for a period including several rhythms will coincide closely with that of chemical reactions in general, but it is also probable for example that the rate of division at the crest of a rhythm at a high temperature and at the bottom of a rhythm at a low temperature will give a coefficient higher than the theory demands. Experiments to determine this point are in progress.

It should also be pointed out that the total number of divisions attained during a prolonged period of time is comparatively constant. For example, the number of generations attained by culture I during 1909 was 613 and during 1910 was 612. Of

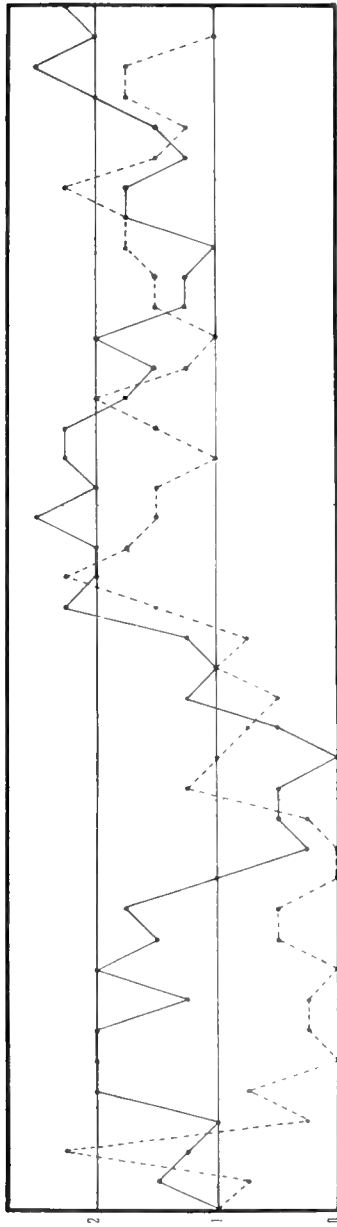

Fig. 12 Graph of the average *daily* rate of division of the four lines of 'sister' cells of series IB82a (= continuous line) and of IB76a (= - - - line). The vertical dotted lines include the ten days during which the temperature variations recorded were less than 0.5°F. To illustrate a typical record of the daily rate of division, and to show the marked variations in the rate during a period of practically constant temperature conditions.

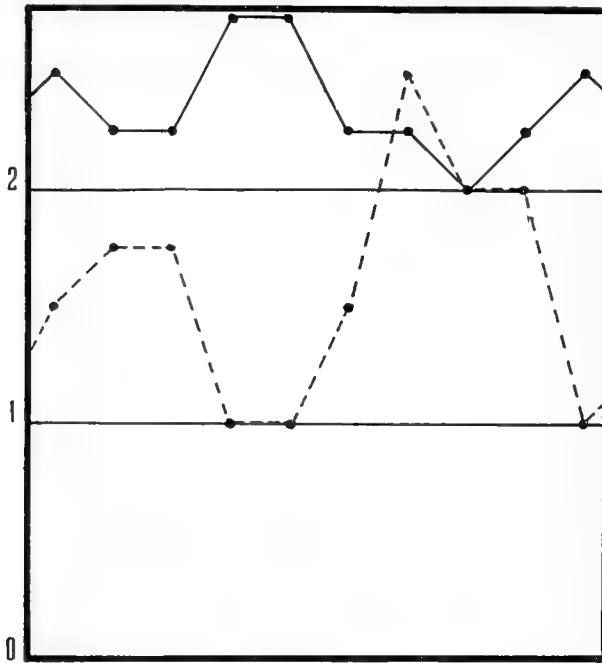

Fig. 13 Graph of the average *daily* rate of division of the four lines of 'sister cells of series IB82b (= continuous line) and of IB76b (= - - - line) for the ten days during which temperature variations were practically absent. To illustrate the same points as fig. 12. Compare with the section of fig. 12 included within the vertical dotted lines.

course this very exact coincidence is an 'accident' but, taken with a considerable amount of data along the same line, it quite definitely points to the fact that the organism has the potential for about a certain number of bipartitions during a long period of time and this number is approximately attained irrespective of the minor fluctuations in the rate, due to external or internal causes.

In a recent paper, Jennings states that

"Within the same line the rate is sometimes very different for a certain period, as a week or ten days, from the rate during the rest of the time. This is much more evident when one inspects a table in which the fissions are recorded day by day. The rate in a given line is there seen at times to drop, remain low for perhaps ten days, then return to the

original rate. In most of all these cases there are evidences of pathological conditions during these periods of lowered rate of fission. Monstrosities appear, and many of the specimens die. Therefore these periods of slower rate are not to be considered as giving the characteristic rate for the race when healthy. In comparing different races, the periods when the rate of fission is high and uniform should be compared."

These observations of Jennings are difficult to understand in view of our results with *Paramecium*. His statement in regard to weekly variations we would, at first glance, interpret as further evidence of rhythms; but throughout the more than four years of the life of this pedigree culture, a monster has never been seen in any of the direct lines, and only two or three times has a single deformed individual been seen in the heavy stock cultures which have been seeded from this strain. Further, it is an unusual occurrence for a line in any of our experiments to die out without assignable cause. Therefore it is necessary to emphasize that whereas the statement quoted seems, at first thought, to be in regard to periodic fluctuations in the rate of bipartition identical with those we call rhythms, nevertheless these fluctuations have absolutely nothing in common since, according to Jennings' statement, those occurring in his lines are pathological.

CONCLUSIONS

The results of studies on the life history of free living Infusoria by exact pedigree culture methods show that, when these organisms are bred on comparatively constant culture media of hay or other infusions, the reproductive activity shows cycles and rhythms. Further results show that when *Paramecium aurelia* is bred on a varied culture medium, or on a constant medium of beef extract, cycles do not occur, but rhythms persist. The results given in the present paper show that it is not possible by constant environmental conditions to eliminate the rhythms and to resolve the graph of the multiplication rate into an approximately straight line. It therefore seems justifiable to conclude that there are inherent rhythmical changes in the phenomena of the cell which are brought to view still more clearly when not

influenced by external factors. Variations in the rhythm of division is well-known in the development of the metazoon egg and it has yet to be satisfactorily explained. Towle in a paper on the effects of stimuli on *Paramecium* makes the following statement: "There may even prove to be rythmical changes in sensitiveness like those described by Lyon for cleaving eggs, and Scott for unfertilized eggs. Something of this nature is indicated by the fact that *paramecia* from the same culture vary in sensitiveness from day to day." Woodruff ('05) wrote: "In my work on the effect of chemicals on Infusoria I have found that individuals react differently at various times to a given stimulus and I believe we have the clue to these changes in sensitiveness manifested in the rhythms of the fission rate."

Finally, the data justify the conclusion that the cells of this pedigree culture of *Paramecium aurelia* have the potentiality to perpetuate themselves indefinitely by division (under proper environmental conditions)—the only necessary variations in the rate of reproduction being normal minor periodic rises and falls of the fission rate, due to some unknown factor in cell phenomena, from which recovery is autonomous.

LITERATURE CITED

- G. N. CALKINS 1904 Studies on the life history of Protozoa. IV. Death of the A series. Conclusions. *Journ. Exper. Zool.*, vol. 1, no. 3.
- L. H. GREGORY 1909 Observations on the life history of *Tillina magna*. *Journ. Exper. Zool.*, vol. 6, no. 3.
- H. S. JENNINGS AND G. T. HARGITT 1910 Characteristics of the diverse races of *Paramecium*. *Journ. Morph.*, vol. 21, no. 4.
- E. P. LYON 1902 Effects of potassium cyanide and of lack of oxygen upon the fertilized eggs and embryos of the sea urchin. *Amer. Journ. Physiol.*, vol. 8, no. 1.
- 1904 Rhythms of susceptibility and of carbon dioxide production in cleavage. *Amer. Journ. Physiol.*, vol. 11, no. 1.
- E. MAUPAS 1888 Recherches expérimentales sur la multiplication des infusoires ciliés. *Arch. d. zool. exper. et gén.*, 2me ser., T. 7.

- M. POPOFF 1907 Depression der Protozoenzelle und der Geschlechtszellen der Metazoen. Archiv f. Protistenkunde, R. Hertwig Festband.
- J. W. SCOTT, 1903 Periods of susceptibility in the differentiation of the egg of Amphitrite. Biol. Bull., vol. 5, no. 1.
- E. W. TOWLE 1904 A study of the effects of certain stimuli, single and combined, upon *Paramecium*. Amer. Journ. Physiol., vol. 12, no. 2.
- L. L. WOODRUFF 1905 An experimental study on the life history of hypotrichous Infusoria. Journ. Exper. Zool., vol. 2, no. 4.
- 1909 Further studies on the life history of *Paramecium*. Biol. Bull., vol. 17, no. 4.
- 1911a Two thousand generations of *Paramecium*. Archiv f. Protistenkunde, Bd. 21, 3.
- 1911b The effect of excretion products of *Paramecium* on its rate of reproduction. Journ. Exper. Zool., vol. 10, no. 4.
- L. L. WOODRUFF AND G. A. BAITSELL 1911 The reproduction of *Paramecium aurelia* in a 'constant' culture medium of beef extract. Journ. Exper. Zool., vol. 11, no. 1.

THE REACTIONS OF EARTHWORMS TO DRY AND TO MOIST SURFACES

G. H. PARKER AND H. M. PARSHLEY

The certainty with which an earthworm that is creeping over a partly moistened surface will avoid dry areas is well known to students of animal activities. It is the object of this paper to discuss briefly the character of this response, the location of the receptors concerned in it, and the nature of the stimulus. The work was carried out on the common dungworm, *Allolobophora foetida* (Sav.), but there is reason to believe that the results obtained apply equally well to most species of earth-worms.

If a normal worm is allowed to creep over a horizontal sheet of filter paper that is wet with tapwater excepting for a few spots and if it is directed by some such stimulus as light toward one of these dry spots, on reaching the spot, it will usually continue to creep over the dry surface for a distance varying from a few segments to half its length, stop, swing its head from side to side, then draw the anterior part of its body back to the moist region, and finally proceed to crawl in a new direction over the moist part of the paper. Of seventy worms put to this test only four failed to show the series of reactions just described. These four crept completely across an extensive dry area without showing the characteristic reaction, but a few days later three of these worms responded in a normal way, showing that their previous atypical condition was probably due to some unusual and temporary state. It is, therefore, fair to conclude that *Allolobophora* as a rule avoids dry areas.

To ascertain the part of the worm that is stimulated by a dry surface, several kinds of experiments were tried. To test the sensibility of the posterior end of the worm, individuals were made to creep backward by touching their anterior ends slightly

and, when thus creeping, were directed toward a dry surface. Thirteen worms tested in this way made considerable backward excursions over such surfaces showing, as was to have been expected, that the posterior end of the worm is not especially sensitive to dryness. Next, forty-five worms, all of which had been found to respond normally to a dry surface, were deprived of their prostomiums and in some instances of an adjacent segment or two, and were shortly afterwards tested on filter paper. All crept freely over a dry surface without showing the lateral movements and the retraction of the head characteristic of normal worms. The regeneration of the prostomium takes place in from one to two weeks according to the extent of the injury. This regeneration was found to restore to the worm its original sensitiveness to dry surfaces and enabled it to react again in a typical fashion. There is, therefore, every reason to believe that the region of the prostomium is the portion of the worm that is stimulated by dryness.

The terminal surface left after the removal of the prostomium offers more or less of an obstacle to the ordinary locomotor movements of the worm and to avoid this feature in the experiments, supplementary tests were made in which the prostomium, instead of being removed, was anaesthetized. After some preliminary trials, three anaesthetics satisfactory for this purpose were found; they were a weak solution of chlorotone, a 35 per cent solution of magnesium sulphate, and a 1 per cent solution of ether, all aqueous. If the anterior tip of a worm is bathed with one of these solutions for from one to five minutes, the prostomium is found to remain insensitive to a dry surface for one or more days. Such anaesthetized worms will creep persistently over a surface of dry filter paper on which, before anaesthetization, they could not be induced to advance more than a very short distance. Full recovery from the effects of the anaesthetic occurs in a day or two. It is, therefore, clear from this evidence also that the prostomium and possibly some of the adjacent parts of the worm are the receptive surfaces for this response.

It might be supposed that the greater harshness of dry filter paper as contrasted with moist filter paper, instead of the simple

absence of water, was the significant factor in these reactions, but such is not the case, for, if worms are allowed to creep on surfaces that remain equally rough whether they are wet or dry, the same reactions are observed as in the tests in which filter paper was used. Such surfaces as those of bricks, tiles, etc., present these conditions. In trials with the moist and dry surfaces of bricks results similar to those got on filter paper were obtained. Moreover worms drew back from a *dry smooth* brick to creep on a *wet rough* one, and from a *dry rough* brick to creep on a *wet smooth* one, showing that the presence or absence of moisture, and not roughness or smoothness were the significant elements in these reactions.

From these observations, it is quite evident that the prostomial region of an earthworm can be stimulated by dryness to such an extent as to call forth vigorous locomotor responses of a characteristic kind. A moist surface seems to be unstimulating and to afford merely a condition favorable for the locomotion of the animal. In this respect the earthworm is the reciprocal of the human being, for our skin is more receptive to the condition of wetness than to that of dryness. With us, however, the sensation of wetness is produced in all probability by a complex of pressure and temperature stimuli, whereas in the earthworm the response to dryness is dependent very likely upon a simpler stimulus. This is apparently the selective extraction of water from the peripheral protoplasm of the worm, a process which is favored by the capillarity of the dry surface over which the worm begins to creep and is probably dependent chiefly upon evaporation from the surface of the worm itself. Under such circumstances the materials in the peripheral protoplasm of the prostomium must become concentrated and probably initiate stimulation by undergoing some such change as partial coagulation. Processes of this kind are not well exemplified in the outer skin of man, but are more nearly comparable with what occur in our mouths when by excessive evaporation the oral surfaces become somewhat dry.

AN ATTEMPT TO ANALYZE THE CONSTITUTION OF THE CHROMOSOMES ON THE BASIS OF SEX- LIMITED INHERITANCE IN DROSOPHILA

T. H. MORGAN

From the Zoological Laboratory, Columbia University

FOUR FIGURES—COLOR PLATE

In several preliminary notes I have given a brief account of the origin of four mutations in the eye-color of the fly, *Drosophila ampelophila*. The heredity of these eye-colors may now be given in full, and the bearing of the results, on sex-limited inheritance in general, discussed. In addition to the eye-color data I shall also describe a few cases in which two other sex-limited characters have been studied in connection with eye-color, namely: short proportionate wings and yellow body-color. A full account of the heredity of these latter two characters will be reserved, however, for later publication. Here they are used only in so far as they give an opportunity to study the mode of inheritance of three sex-limited characters present in one individual.¹

The experiments on *Drosophila* have led me to two principal conclusions:

FIRST, that *sex-limited inheritance is explicable on the assumption that one of the material factors of a sex-limited character is carried by the same chromosomes that carry the material factor for femaleness.*

SECOND, that the 'association' of certain characters in inheritance is due to the proximity in the chromosomes of the chemical substances (factors) that are essential for the production of those characters.

¹ The facts here recorded were first announced in a public lecture given in the Marine Biological Laboratory at Woods Hole, Mass., July 7, 1911.

PART I

THE HEREDITY OF RED, VERMILION (OR BRIGHT-RED), PINK,
AND ORANGE EYES

The eyes of the wild fly are dull red, and may be designated by the letter R. The bright-red eye is vermilion in color and is indicated by V in the tables.

The pink eye is more translucent than the red eye, but of about the same general tone. It lacks the dark fleck seen in the red and vermilion eye when the eye is examined with a lens. This black fleck changes its position as the lens travels over the eye. The pink eye, P, is with a little experience easily distinguished from the other colors, especially in newly hatched flies. When the fly gets old the eye turns to a brown color very characteristic of this type of eye.

The orange is the faintest eye color in the series. If the fly is very small it may be only tinged with orange. If the fly is large (coming from a well-fed maggot) the orange eye, O, is deep orange in shade; and without some experience it may be confused with the pink eye, especially if a mixed culture containing flies of different ages and sizes is examined. A little experience will soon make one familiar with the difference between these two colors.

I do not hesitate to state that there are no intergrades between these eye-colors. Each color is distinct and breeds true to its kind. Moreover, the heterozygous flies show the dominant color. One 'dose' is indistinguishable from two doses of the color determiner.

In making the matings and recording the numbers I have been assisted in the experiments with eye-color by Miss Eleth Cattell; and in the experiments in sex-limited inheritance for three factors by Miss E. M. Wallace and by Miss M. B. Abbott. I wish to express here my appreciation of the assistance that they have given. I have discussed the theoretical results of the eye-color inheritance with Mr. A. H. Sturtevant, as the work went on.

and this discussion has been helpful to me in finding suitable formulae for the data.

Rather than defer the discussion of the interpretation of the results to the end of the account I will take up each case in turn. A few words will suffice to make clear the symbolism used. The red eye of the wild fly seems to contain three pigments: red, pink, and orange. The mutants have arisen by the loss in turn of one of the factors that make possible the development of the red color. If these three colors (or the factors that stand for them) are represented by the symbols R, P, and O, then the red eye is RPO, the pink eye is rPO, the orange eye is rpO. Obviously there is another combination possible, viz: the loss of the pink factor and the retention of R and O, giving RpO, which is the formula for the bright red or vermilion eye. The matter may be better expressed in another way. Should from any cause whatsoever the factor for pink (P) drop out, vermilion (RpO) would appear. If, on the other hand, the red factor (R) should be lost from the red-eyed fly, pink would result (rPO). By crossing a vermilion fly with a pink one, some orange-eyed flies (rpO) would appear in the second (inbred) generation by recombination.

In the formulae that follow it is always assumed that one dose of red or pink gives the same result as do two doses, which accords with the facts.

It is necessary to say a word in advance about sex determination in these flies. I assume that every egg after eliminating its polar bodies, contains the sex chromosome, called X. Prior to their extrusion the egg, like all the other cells of the female, contains two X's or XX. The male cells contain one X. Half the spermatozoa contain one X, the other half lack X. Miss N. M. Stevens has shown that these relations are actually present in *Drosophila*. The peculiar 'coupling' of X with the factor for pink, that runs through the formulae and gives the significant results connected with sex-limited inheritance, will be discussed later.

Red eye by vermilion eye

When red-eyed females were crossed with vermilion-eyed males all the offspring (93 in number) were red. These inbred produced in the second generation red females, red males, and vermilion males. The result shows that vermilion is sex-limited. The following table gives the results and numerical data:

$$\text{Red } \varphi \text{ by Vermilion } \sigma^{\circ} = \left\{ \begin{array}{l} \text{R } \varphi \\ \text{R } \sigma^{\circ} \end{array} \right\} \left\{ \begin{array}{l} \text{Red } \varphi \dots\dots\dots 302 \\ \text{Red } \sigma^{\circ} \dots\dots\dots 179 \\ \text{Vermilion } \sigma^{\circ} \dots\dots\dots 110 \end{array} \right.$$

The two classes of males taken together number 289, which is a close approximation to the 302 red females. The results may be accounted for in the following way:

$$\begin{aligned} \text{Red } \varphi &= \text{RPOX} - \text{RPOX} \\ \text{Vermilion } \sigma^{\circ} &= \text{RpOX} - \text{RpO} \end{aligned}$$

F ₁	Red ♀	RPOXRpOX
	Red ♂	RPOXRpO

Gametes of F ₁	Red ♀	RPOX - RpOX
	Red ♂	RPOX - RpO

F ₂ Generation		RPOXRPOX	Red ♀
		RPOXRpOX	Red ♀
		RPOXRpO	Red ♂
		RpOXRpO	Vermilion ♂

It will be noted that the red females belong to two classes, one pure, the other heterozygous: the red male is also heterozygous, while the vermilion male is pure.

The reciprocal cross, namely, red male by vermilion female gives red females and vermilion males. In other words the daughters are like the father and the sons like the mother. This gives what I call criss-cross inheritance. When these F₁'s are inbred they give red males and females and vermilion males and females as shown in the next table.

Red ♂ by Vermilion ♀	$\left\{ \begin{array}{l} R \text{ ♀} \\ V \text{ ♂} \end{array} \right\} \left\{ \begin{array}{l} \text{Red ♀} \\ \text{Red ♂} \\ \text{Vermilion ♀} \\ \text{Vermilion ♂} \end{array} \right\}$	Red ♀	193
		Red ♂	184
		Vermilion ♀	207
		Vermilion ♂	186

The two preceding crosses are typical for all cases of sex-limited inheritance in *Drosophila*, and for some, perhaps for all, other cases. They may be summed up in the statement that where in one combination a character in the grandfather is transmitted to his grandsons alone, the reciprocal combination gives criss-cross inheritance.

The number of males and of females in each class is approximately equal in the F₂ generation. The results are accounted for as follows:

	Vermilion ♀ RpOX - RpOX Red ♂ RPOX - RpO								
F ₁	Red ♀ RpOXRPOX Vermilion ♂ RpOXRpO								
Gametes of F ₁	Red ♀ RpOX - RPOX Vermilion ♂ RpOX - RpO								
F ₂ Generation	<table style="margin-left: auto; margin-right: auto;"> <tr> <td style="padding-right: 20px;">RpOXRpOX</td> <td>Vermilion ♀</td> </tr> <tr> <td style="padding-right: 20px;">RPOXRpOX</td> <td>Red ♀</td> </tr> <tr> <td style="padding-right: 20px;">RpOXRpO</td> <td>Vermilion ♂</td> </tr> <tr> <td style="padding-right: 20px;">RPOXRpO</td> <td>Red ♂</td> </tr> </table>	RpOXRpOX	Vermilion ♀	RPOXRpOX	Red ♀	RpOXRpO	Vermilion ♂	RPOXRpO	Red ♂
RpOXRpOX	Vermilion ♀								
RPOXRpOX	Red ♀								
RpOXRpO	Vermilion ♂								
RPOXRpO	Red ♂								

Red eye by pink eye

The results of this cross have been already published (Science, 1911), but the hypothetical explanation not given. For the sake of completeness the facts must be restated here. Red female by pink male gave red male and red female offspring. These inbred gave in the F₂ generation 3063 red males and females and 169 pink males and females.

$$\text{Red } \varphi \text{ by Pink } \sigma^{\circ} = \left\{ \begin{array}{l} \text{Red } \varphi \\ \text{Red } \sigma^{\circ} \end{array} \right\} \left\{ \begin{array}{l} \text{Red } \varphi \\ \text{Red } \sigma^{\circ} \\ \text{Pink } \varphi \\ \text{Pink } \sigma^{\circ} \end{array} \right\} \dots 3063$$

$$\dots 169$$

In this case there is no sex-limited inheritance. An analysis of the result, based on the same formulae, gives the following:

	Red φ RPOX - RPOX Pink σ° rPOX - rpO	
F ₁	Red φ RPOXRPOX Red σ° RPOXrpO	
Gametes of F ₁	Red φ RPOX - rPOX Red σ° RPOX - rPOX - RpO - rpO	
	$\left. \begin{array}{l} \text{RPOXRPOX} \\ \text{RPOXrPOX} \\ \text{rPOXRPOX} \end{array} \right\} 3 \text{ red } \varphi$	
	rPOXrPOX 1 pink φ	
F ₂	$\left. \begin{array}{l} \text{RPOXRpO} \\ \text{RPOXrpO} \\ \text{rPOXRpO} \end{array} \right\} 3 \text{ red } \sigma^{\circ}$	
	rPOXrpO 1 pink σ°	

The expectation is three times as many red females as pink females, and three times as many red males as pink males. The actual ratio is about 20 to 1, taking the two sexes together. Thus while all the classes are represented, and the reds in excess of the pinks, they are much more numerous than expectation. The cause of this deficit in the pinks will be discussed later when other similar results can be brought forward.

The reciprocal cross, red males and pink females, gave in the first generation red males and females. These produced in the F₂ generation red males and females, and pink males and females in the proportions shown in the next table.

$$\text{Red } \sigma^7 \text{ by Pink } \varphi = \left\{ \begin{array}{l} \text{Red } \varphi \\ \text{Red } \sigma^7 \end{array} \right\} \begin{array}{l} \text{Red } \varphi \\ \text{Red } \sigma^7 \\ \text{Pink } \varphi \\ \text{Pink } \sigma^7 \end{array} \quad \begin{array}{l} 1133 \\ 237 \end{array}$$

The analysis of the result, based on the same formulae, is as follows:

$$\begin{array}{l} \text{Pink } \varphi \text{ rPOX} - \text{rPOX} \\ \text{Red } \sigma^7 \text{ RPOX} - \text{RpO} \end{array}$$

$$\begin{array}{l} \text{F}_1 \\ \text{Red } \varphi \text{ rPOXRPOX} \\ \text{Red } \sigma^7 \text{ rPOXRpO} \end{array}$$

$$\begin{array}{l} \text{Gametes of F}_1 \\ \text{Red } \varphi \text{ rPOX} - \text{RPOX} \\ \text{Red } \sigma^7 \text{ rPOX} - \text{RPOX} - \text{rpO} - \text{RpO} \end{array}$$

$$\begin{array}{l} \text{F}_2 \\ \text{rPOXrPOX} \quad \text{Pink } \varphi \\ \text{rPOXRPOX} \quad \text{Red } \varphi \\ \text{RPOXrPOX} \quad \text{Red } \varphi \\ \text{RPOXRPOX} \quad \text{Red } \varphi \\ \text{rPOXrpO} \quad \text{Pink } \sigma^7 \\ \text{rPOXRpO} \quad \text{Red } \sigma^7 \\ \text{RPOXrpO} \quad \text{Red } \sigma^7 \\ \text{RPOXRpO} \quad \text{Red } \sigma^7 \end{array}$$

In this combination also the expectation is three red females to one pink female and three red males to one pink male, while the realization is about 5 to 1 for all reds *versus* all pinks.

Red eye by orange eye

When red-eyed females are crossed with orange-eyed males all of the offspring have red eyes. These inbred produce red-eyed males and females, pink-eyed males and females, and vermilion-eyed males and orange-eyed males. No females with vermilion or with orange eyes appear in the second generation. Here two characters are, in a sense, sex-limited, although the parents showed only one of them, viz., the orange.

Red ♀ by Orange ♂ =	}	Red ♀	Red ♂	}	Red ♀	138
					Red ♂	102
					Vermilion ♂	58
					Pink ♀	5
					Pink ♂	3
					Orange ♂	3

The number of pinks and oranges is very small, although the other classes contain a fair number of offspring. The analysis follows:

Red ♀ RPOX - RPOX
 Orange ♂ rpOX - rpO

F₁ Red ♀ RPOXrpOX
 Red ♂ RPOXrpC

Gametes of F₁ Red ♀ RPOX - rPOX - RpOX - rpOX
 Red ♂ RPOX - rPOX - RpO - rpO

RPOXRPOX	}	3	red ♀
RPOXrPOX			
rPOXRpOX			
rPOXrPOX	}	1	pink ♀
RpOXRPOX	}	3	red ♀
RpOXrPOX			
rPOXRPOX			
rPOXrPOX	}	1	pink ♀
RPOXRpO	}	3	red ♂
RPOXrpO			
rPOXRpO			
rPOXrpO	}	1	pink ♂
RpOXRpO	}	3	vermilion ♂
RpOXrpO			
rpOXRpO			
rpOXrpO	}	1	orange ♂

In this case the expectation was far ahead of the realization; for, while the red females to the pink females are estimated as 3 to 1 they are as 37 to 1 in the actual count. Again the vermilion-eyed males should be as numerous as the red males, but they are not half as numerous. Thus while the formulae give the classes actually realized in the experiment with the sexes properly distributed—a matter of no small complexity—yet the numerical results are by no means the expected ones.

The reciprocal cross, red males by orange females, gives red females and vermilion males. These inbred produce eight classes in the second, or F_2 , generation. These eight classes represent, in fact, the whole gamut of eye-colors.

Red ♂ by Orange ♀ =	{	Red ♀	}	Red ♀	193
		Vermilion ♂		Red ♂	153
				Vermilion ♀	151
				Vermilion ♂	135
				Pink ♀	49
				Pink ♂	22
				Orange ♀	13
				Orange ♂	31

In this combination the number of pinks and oranges is by no means so small as in the preceding case, although the other colors are not much more numerous than before. The analysis is as follows:

Orange ♀ rpOX - rpOX
 Red ♂ RPOX - RpO

F₁ Red ♀ rpOXRPOX
 Vermilion ♂ rpOXRpO

Gametes of F₁ Red ♀ rpOX - RPOX - RpOX - rPOX
 Vermilion ♂ rpOX - RpOX - RpO - rp.O

	rpOXrpOX	Orange ♀
	rpOXRpOX	Vermilion ♀
	RPOXrpOX	Red ♀
	RPOXRpOX	Red ♀
	RpOXrpOX	Vermilion ♀
	RpOXRpOX	Vermilion ♀
	rPOXrpOX	Pink ♀
	rPOXRpOX	Red ♀
F ₂	rpOXRpO	Vermilion ♂
	rpOXrpO	Orange ♂
	RPOXRpO	Red ♂
	RPOXrpO	Red ♂
	RpOXRpO	Vermilion ♂
	RpOXrpO	Vermilion ♂
	rPOXRpO	Red ♂
	rPOXrpO	Pink ♂

The expectation in the F₂ generation is 3 reds, 3 vermilion, 1 pink, 1 orange. The numbers realized are somewhat in this same ratio, except that the pinks and the oranges again run behind their schedules. A curious, and I think significant, relation will be observed between the sexes in the last two classes; for, the pink females are twice as numerous as the pink males, while the reverse holds for the orange-eyed flies. The same relation comes up again in the pink-male by orange-female cross to be described later.

This completes the crosses between red and the other colors. We may now take up the remaining combinations. It will be noted that from now on the results are about an exact duplication of the series just described. The results may be said to be mirror figures of each other which suggests the fanciful idea that the combinations of colors, that the tables represent, have some such stereometric relation.

Vermilion eye by pink eye

When a vermillion-eyed female is crossed with a pink-eyed male, all the female offspring are red, and all the male offspring are vermillion. These inbred produce in the second generation all four classes of both sexes:

Vermilion ♀ by Pink ♂ =	{	Red ♀	>	Red ♀ 110
				Red ♂ 62
				Vermilion ♀ 104
				Vermilion ♂ 84
				Pink ♀ 36
				Pink ♂ 16
				Orange ♀ 36
				Orange ♂ 17

A deficiency in the males of every class is noticeable in this cross. The total of all the females is 286 and of all the males 179, nearly 2 to 1. The analysis, as shown in the next table, calls of course for equal numbers.

Vermilion ♀ RpOX - RpOX
 Pink ♂ rPOX - rpO

F₁ Red ♀ RpOXrPOX
 Vermilion ♂ RpOXrpO

Gametes of F₁ Red ♀ RpOX - rPOX - RPOX - rpOX
 Vermilion ♂ RpOX - rpOX - RpO - rpO

RpOXRpOX = Vermilion ♀
 RpOXrpOX = Vermilion ♀
 rPOXRpOX = Red ♀
 rPOXrpOX = Pink ♀
 RPOXRpOX = Red ♀
 RPOXrpOX = Red ♀
 rpOXRpOX = Vermilion ♀
 rpOXrpOX = Orange ♀

F₂ RpOXRpO = Vermilion ♂
 RpOXrpO = Vermilion ♂
 rPOXRpO = Red ♂
 rPOXrpO = Pink ♂
 RPOXRpO = Red ♂
 RPOXrpO = Red ♂
 rpOXRpO = Vermilion ♂
 rpOXrpO = Orange ♂

The expectation both for males and females is 3 red, 3 vermilion, 1 pink, 1 orange. The females give approximately this result, while the males fall below the expectation, especially the pink and orange males.

The reciprocal cross, vermilion male by pink female, gives all red offspring. These inbred give for the F₂ generation red males and females, vermilion males, pink males and females, orange males. Here again a case of double sex-limited inheritance occurs, and of course in the same colors, vermilion and orange, as before.

Vermilion ♂ by pink ♀	{	Red ♀	}	Vermilion ♂	756
		Red ♂		Vermilion ♀	334
				Pink ♀	397
				Pink ♂	214
				Orange ♀	99
				Orange ♂	84

The numbers are relatively high in this experiment, and significant. The red and the vermilion males taken together give approximately the same number as the red females. Similarly the pink and the orange males, taken together, are nearly as numerous as the pink females. The following table shows what the expectation is in regard to these numbers:

	Pink ♀ rPOX — rPOX Vermilion ♂ RpOX — RpO
F ₁	Red ♀ rPOXRpOX Red ♂ rPOXRpO
Gametes of F ₁	Red ♀ rPOX — RPOX — rpOX — RpOX Red ♂ rPOX — RPOX — rpO — RpO
	rPOXrPOX = Pink ♀ rPOXRPOX = Red ♀ RPOXrPOX = Red ♀ RPOXRPOX = Red ♀ rpOXrPOX = Pink ♀ rpOXRPOX = Red ♀ RpOXrPOX = Red ♀ RpOXRPOX = Red ♀
F ₂	rPOXrpO = Pink ♂ rPOXRpO = Red ♂ RPOXrpO = Red ♂ RPOXRpO = Red ♂ rpOXrpO = Orange ♂ rpOXRpO = Vermilion ♂ RpOXrpO = Vermilion ♂ RpOXRpO = Vermilion ♂

The preceding analysis shows that there should be three times as many red females as pink females. There are, in fact, somewhat more than three times as many. The pink males should be to the red males (or to the vermilion) as 1 to 3. They do not come up to this ratio but nearly approximate to it. Similarly for the orange males. In this instance, where the numbers are large, it is quite apparent that the expected and the realized results fairly agree. The failure is here again obviously due to a reduction in the number of the pink and orange classes.

Vermilion eye by orange eye

When a female with vermillion eyes is bred to a male with orange eyes, all of the offspring are vermillion eyed. These inbred produce the two grand-parental colors in males and in females.

Vermilion ♀ by Orange ♂ =	{	Vermilion ♀	}	Vermilion ♀	909
		Vermilion ♂		Vermilion ♂	911
		Vermilion ♂		Orange ♀	131
				Orange ♂	177

The one point to notice here is the excess of orange males over orange females that has occurred in all of the preceding cases where both classes occur. The absence of red and of pink from the combination is due of course to the absence of pink in both parents.

Vermilion ♀ RpOX - RpOX
 Orange ♂ rpOX - rpOX

F₁ Vermilion ♀ RpOXrpOX
 Vermilion ♂ RpOXrpOX

Gametes of F₁ Vermilion ♀ RpOX - rpOX
 Vermilion ♂ RpOX - rpOX - RpO - rpO

RpOXRpOX }
 RpOXrpOX } 3 vermillion ♀
 rpOXRpOX }

F₂ rpOXrpOX 1 orange ♀

RpOXRpO }
 RpOXrpO } 3 vermillion ♂
 rpOXRpO }

rpOXrpO 1 orange ♂

The analysis calls for 3 vermillion females to 1 orange female. In fact, 5½ times as many vermillion as orange females are found and the same disproportion, due to deficiency in orange, is found also in the male classes.

The reciprocal cross, vermilion male by orange female, gives also all vermilion offspring. These inbred give both original classes in both sexes.

$$\text{Vermilion } \sigma^{\text{r}} \text{ by Orange } \varphi = \begin{cases} \text{Vermilion } \varphi \\ \text{Vermilion } \sigma^{\text{r}} \end{cases} \left\{ \begin{array}{l} \text{Vermilion } \varphi \dots\dots 411 \\ \text{Vermilion } \sigma^{\text{r}} \dots\dots 330 \\ \text{Orange } \varphi \dots\dots 50 \\ \text{Orange } \sigma^{\text{r}} \dots\dots 62 \end{array} \right.$$

Here a slight excess of orange males over orange females occurs. The relation of vermilion to orange is seen in the following analysis.

$$\begin{array}{l} \text{Orange } \varphi \quad \text{rpOX} - \text{rpOX} \\ \text{Vermilion } \sigma^{\text{r}} \quad \text{RpOX} - \text{RpO} \end{array}$$

$$\text{F}_1 \quad \begin{array}{l} \text{Vermilion } \varphi \quad \text{rpOXRpOX} \\ \text{Vermilion } \sigma^{\text{r}} \quad \text{rpOXRpO} \end{array}$$

$$\text{Gametes of F}_1 \quad \begin{array}{l} \text{Vermilion } \varphi \quad \text{rpOX} - \text{RpOX} \\ \text{Vermilion } \sigma^{\text{r}} \quad \text{rpOX} - \text{RpOX} - \text{rpO} - \text{RpO} \end{array}$$

$$\text{rpOXrpOX} = 1 \quad \text{orange } \varphi$$

$$\left. \begin{array}{l} \text{rpOXRpOX} \\ \text{RpOXrpOX} \\ \text{RpOXRpOX} \end{array} \right\} = 3 \quad \text{vermilion } \varphi$$

$$\text{F}_2 \quad \text{rpOXrpO} = 1 \quad \text{orange } \sigma^{\text{r}}$$

$$\left. \begin{array}{l} \text{rpOXRpO} \\ \text{RpOXrpO} \\ \text{RpOXRpO} \end{array} \right\} = 3 \quad \text{vermilion } \sigma^{\text{r}}$$

The expectation is, for three vermilion females to one orange female: the actual numbers are 8 to 1. The same expectation holds for the male while the actual numbers give 5½ to 1.

Pink eye by orange eye

When a pink-eyed female is paired with an orange-eyed male, all of the offspring are pink. These inbred produce pink males and females and orange males.

$$\text{Pink } \text{♀} \text{ by Orange } \text{♂} = \left\{ \begin{array}{l} \text{Pink } \text{♀} \\ \text{Pink } \text{♂} \end{array} \right\} \left\{ \begin{array}{l} \text{Pink } \text{♀} \dots\dots\dots 1035 \\ \text{Pink } \text{♂} \dots\dots\dots 512 \\ \text{Orange } \text{♂} \dots\dots\dots 518 \end{array} \right.$$

The two classes of males taken together give almost exactly the same number as the females. Both pink and orange males occur in equal numbers. In this experiment there appeared 15 orange females (not given in the table). This is possibly due to further mutation in the hybrid or to some error. The formulae are as follows:

$$\begin{array}{l} \text{Pink } \text{♀} \quad \text{rPOX} - \text{rPOX} \\ \text{Orange } \text{♂} \quad \text{rpOX} - \text{rpO} \end{array}$$

$$\text{F}_1 \qquad \begin{array}{l} \text{Pink } \text{♀} \quad \text{rPOXrpOX} \\ \text{Pink } \text{♂} \quad \text{rPOXrpO} \end{array}$$

$$\text{Gametes of F}_1 \qquad \begin{array}{l} \text{Pink } \text{♀} \quad \text{rPOX} - \text{rpOX} \\ \text{Pink } \text{♂} \quad \text{rPOX} - \text{rpO} \end{array}$$

$$\text{F}_2 \qquad \begin{array}{ll} \text{rPOXrPOX} & \text{Pink } \text{♀} \\ \text{rpOXrPOX} & \text{Pink } \text{♀} \\ \text{rPOXrpO} & \text{Pink } \text{♂} \\ \text{rpOXrpO} & \text{Orange } \text{♂} \end{array}$$

The reciprocal cross, pink males by orange females, gives the criss-cross inheritance, viz., pink females and orange males. It is of interest to note in passing that there were 233 pink females and 215 orange males recorded in this F₁ generation, showing that in the direct cross the sexes of opposite colors appear in nearly equal numbers. In the second generation both colors in males and females occur.

$$\text{Pink } \sigma^{\text{r}} \text{ by Orange } \varphi = \left\{ \begin{array}{l} \text{Pink } \varphi \\ \text{Orange } \sigma^{\text{r}} \end{array} \right\} \left\{ \begin{array}{ll} \text{Pink } \varphi \dots\dots\dots 572 \\ \text{Pink } \sigma^{\text{r}} \dots\dots\dots 292 \\ \text{Orange } \varphi \dots\dots\dots 312 \\ \text{Orange } \sigma^{\text{r}} \dots\dots\dots 522 \end{array} \right.$$

In the F₂ generation a peculiar relation becomes apparent: there are one half as many pink males as pink females, while in the orange class the females are only a little more than half as numerous as the males. Thus while the total number of females of both classes (884) is nearly the same as the total number of the males when both classes are added together (814), yet this approximate equality is due to the reverse ratio of the sexes in the two color classes. It is worth noting, too, that this relation exists in the same group, in which as stated above, the pink females and orange males existed in equal numbers in the F₁ generation. In fact, it is just these two classes that still exist in equal numbers in the F₂ generation that give the significance to these results.

The analysis of this case is as follows:

	Orange ♀	rpOX	—	rpOX
	Pink ♂	rPOX	—	rpO
F ₁	Pink ♀	rpOXrPOX		
	Orange ♂	rpOXrpO		
Gametes of F ₁	Pink ♀	rpOX	—	rPOX
	Orange ♂	rpOX	—	rpO
F ₂	rpOXrpOX	Orange ♀		
	rPOXrpOX	Pink ♀		
	rpOXrpO	Orange ♂		
	rPOXrpO	Pink ♂		

At present I can offer no reasonable explanation of this peculiar relation between color and sex as shown in this experiment. It appears to be related to facts to be described later in connection with associative inheritance, and it is probably also related to a change in the sex-ratio that I have recorded in another cross (see Proc. Soc. Exp. Biol. and Med., 1911). As I have these problems still under investigation I shall not discuss them further here.

Discussion of results on eye-color

An examination of the formulae used to interpret the preceding results will show three points of importance. First, that the red factor R may be present in the male-producing sperm. It is present there, in fact, if the fly has either red or vermilion eyes.

Second, the factor for pink is only present when X or the sex factor is present. It is absent, therefore, from all male-producing sperm. It is true that X may exist without the pink factor, as in the vermilion and orange flies that owe their peculiarity to the absence of P. If the P is contained in X, as its connection with sex establishes, then its absence must be due to its loss from X. Consequently while X may exist without P, the latter, P, can occur only when X is present.

Third, the factor for orange, O, is present in every case. It might, therefore, be omitted from all of the formulae without affecting the results, provided the absence of R and of P be assumed to give O. But since orange is a definite color the absence of red and pink can not be assumed to leave orange. For this reason I have always inserted it. Its location can not be identified because it seems never to be lost. I shall give my reasons later for not identifying it with the color-producer C.

The facts here recorded for the factor P amount in my opinion to a demonstration that this factor is intimately associated with the factor for sex. All of the 58 classes found in the second filial generation can be accounted for on the assumption that X contains P, when P is present; and, as I pointed out in connection with the heredity of white eyes *versus* red eyes, sex-limited inheritance can be explained by assuming that X carries red if red is present. In the case of vermilion and of orange eyes pink is lost from X and the formulae give the classes realized. The asymmetrical distribution of pink follows the same law as the asymmetrical distribution of the sex chromosomes.

A study of the formulae also reveals the fact that in the male of these classes (red and pink) when pink is present in the simplex condition (it can not occur otherwise in the male) no interchange takes place between the pink element contained in the X-chromo-

some and any other chromosome, because, as I have previously pointed out, the sex chromosome in the male has no mate. Consequently no such interchange of chromatic particles, as we must assume possible for the other chromosomes, is here possible. The entire scheme of sex-limited inheritance rests, as I have tried to show, on this simple basis. To prevent a possible misunderstanding I may point out that the behaviour of the R-factor illustrates how an interchange of R and no R is possible in the male. If the R is contained in some other chromosome in the heterozygote it may interchange position with its absent condition in a corresponding position or particle in the mate of this chromosome.

The facts here recorded for the inheritance of pink make out a strong case in favor of the view that sex-limited inheritance can be explained if we locate the factor for pink in one of the sex chromosomes. I have pointed out that a similar assumption explains the heredity of white eyes, also sex-limited. I can state that the same assumption will account for the inheritance of yellow color and for the two wing mutations that are sex-limited. More important still is the fact that the extremely complicated results that follow when two or more of these sex-limited characters are combined must also be explained on the same principle. It is this evidence that has convinced me that segregation, the key note to all Mendelian phenomena, is to be found in the separation, during the maturation of the egg and sperm, of material bodies (chemical substances) contained in the chromosomes.

This conclusion need not mean that the material bodies present in the chromosomes are the substances out of which the unit-characters are built up. On the contrary all that this evidence goes to show is that the bodies represent some material necessary for the development of the particular character in question, and it is certain that other parts of the cell also contribute to the elaboration of the unit-character. This is the view I should adopt, provisionally, as the more probable. We see, in fact, that the red color of the eye of the wild fly is due to the collaboration of at least four different factors in the cell, namely, a red, a pink, and an orange determiner, and a color producer. The pink determiner and the color producer are carried by the

X-chromosome, but are not otherwise related. The red factor is contained in some other chromosome; the orange factor we can not yet locate.

Concerning the chemical nature of the three colors I have no facts to offer. That they may be related chemically is made probable by the evidence, to be given later, that they are all three activated by the same color-producer C. If this is admitted we see that similar substances may be contained in different chromosomes, and the further conclusion is then near at hand that in some cases the same substance may be carried by more than one chromosome. In connection with a mode of inheritance that is not as yet clearly Mendelian, viz., beaded and truncated wings I shall examine this assumption further, but it is not needed for the cases here described that follow Mendel's law for one pair of factors.

In the application of the Mendelian formulae to the F_2 generation it has been only too often apparent that while the formulae give in all cases the expected classes, yet the numerical results depart widely from expectation. A consideration of the facts will bring conviction to anyone, I think, that the numerical departures from expectation are due to special, disturbing factors. At another time, when I am able to present other data for wing inheritance, and for disturbances in the sex ratios, I shall take up the question of these irregularities more fully. Here I can only point out one or two possibilities. In some cases the disturbance can be traced directly to the principle of 'association.' By this I mean that during segregation certain factors are more likely to remain together than to separate, not because of any attraction between them, but because they lie near together in the chromosomes, as will be explained more fully later. For example, when red ♀ RPOX is crossed with pink ♂ rPO the offspring are red ♀ RPOXrPOX and red ♂ RPoXrpO. As shown by the analysis on page 370 there are four classes of spermatozoa possible, but if R and P tend to hold together² rather than interchange with r there will be more female-producing sperm RPOX than rPOX,

² In reality C and P.

and hence proportionately more reds in relation to pink than random or Mendelian segregation demands. The same principle applied to other cases will often account for the disturbances in the Mendelian ratios.

It is evident, however, that other conditions also may be responsible for the irregular ratios. The fact that the low types of mutants—those that have lost two factors, for example—fall short of expectation as compared with the normal type, and the disturbances in the sex ratios call perhaps for a different explanation. In regard to the former it is probable either that gametes containing certain combinations are less likely to fertilize or be fertilized or that the product of such fertilization is less viable. Until certain work is completed that I have on hand there is no need to attempt to decide which of the suppositions is the correct one.

PART II

THE RELATION OF THE COLOR PRODUCER C TO THE COLOR DETERMINERS OF EYE COLOR

In a preceding paper (Science, July 1910) dealing with sex-limited inheritance of white eyes I have shown how the results are explicable on the assumption that the factor for red color is absent from the X-chromosome in the white-eyed individuals. It may appear that this assumption flatly contradicts the assumption made in the preceding cases for eye-color in which it is shown that the factor (a factor!) for red R is present in the male-producing sperm (when red is present at all). There is no contradiction, however, for it is not the color determiner R that is present in the X-chromosome, but the color-producer C. It is the absence of C from X that gives the white-eyed fly whose formula is cRPO. For the sake of simplicity I have not introduced this relation in the preceding examples. The change, if introduced, gives precisely the same results, but adds another letter.

I purpose now to consider the relation of this C factor to the eye colors. It may make the case simpler if first an example for white and red is given.

When a white-eyed male is crossed to a red female the offspring are red. These inbred give red females (50 per cent), red males (25 per cent), and white males (25 per cent). The formulae are as follows:

$$\begin{array}{l} \text{Red } \varnothing \text{ CRX} \quad - \text{ CRX} \\ \text{White } \sigma^7 \text{ cRX} \quad - \text{ cR} \end{array}$$

$$F_1 \quad \begin{array}{l} \text{Red } \varnothing \text{ CRX} \quad - \text{ cRX} \\ \text{Red } \sigma^7 \text{ CRX} \quad - \text{ cR} \end{array}$$

$$F_2 \quad \begin{array}{l} \text{CRXCRX} \quad = \quad \text{Red } \varnothing \\ \text{CRXcRX} \quad = \quad \text{Red } \varnothing \\ \text{CRXcR} \quad = \quad \text{Red } \sigma^7 \\ \text{cRXcR} \quad = \quad \text{White } \sigma^7 \end{array}$$

The converse cross, white female by red male, gives red females and white males. These inbred give red males and females and

white males and females. The formulae for this case are as follows:

$$\begin{array}{l} \text{White } \text{♀} \quad cRX - cRX \\ \text{Red } \text{♂} \quad CRX - cR \end{array}$$

$$F_1 \quad \begin{array}{l} \text{Red } \text{♀} \quad cRX - CRX \\ \text{White } \text{♂} \quad cRX - cR \end{array}$$

$$F_2 \quad \begin{array}{l} cRXcRX = \text{White } \text{♀} \\ CRXcRX = \text{Red } \text{♀} \\ cRXcR = \text{White } \text{♂} \\ CRXcR = \text{Red } \text{♂} \end{array}$$

These two examples will serve to show the method by which all the white-red combinations can be treated. The results are those that I have already published (Science, 1910, vol. 32).

Pink eye by white eye

The results of this combination have been already given (Science, 1911). Since the numerical relations were peculiar I repeated the experiment and obtained large numbers of individuals that furnish a better basis for interpretation. When a pink-eyed female is bred to a white-eyed male all the offspring have red eyes. These inbred produce red-, white-, and pink-eyed offspring in the following proportions:

Red-eyed females.....	1183
Red-eyed males.....	579
White-eyed males.....	669
Pink-eyed females.....	357
Pink-eyed males.....	141

If we interpret these results in the same terms as those used for white and red we get the following formulae. Since the orange factor is present throughout and the orange eye is not involved O is omitted. The white-eyed male came from red stock through the loss of C and his formulae is cRP + cR.

Pink ♀ CrPX - CrPX
 White ♂ cRPX - cR

F₁ Red ♀ CrPXcRPX
 Red ♂ CrPXcR

Gametes of F₁ Red ♀ CrPX - crPX - eRPX - CRPX
 Red ♂ CrPX - CRPX - cR - cr

CrPXCrPX = Pink ♀
 CrPXcrPX = Pink ♀
 CrPXcRPX = Red ♀
 CrPXCcrPX = Red ♀
 CRPXCrPX = Red ♀
 CRPXcrPX = Red ♀
 CRPXcRPX = Red ♀
 CRPXCcrPX = Red ♀

F₂ eRCrPX = Red ♂
 eRcrPX = White ♂
 eRcRPX = White ♂
 eRCRPX = Red ♂
 erCrPX = Pink ♂
 ercrPX = White ♂
 ercRPX = White ♂
 erCRPX = Red ♂

The expectation is six red females to two pink females or 3 to 1. The realization is close to expectation, there being a small deficit in pink females. For the males the expectation is three reds to one pink. The realization is 4 to 1 due to deficit in pink males. The expectation for white males is the sum of the pink and red males: the realization is not far from this number. The white males should be to the red males as 4:3 which is approximately realized.

The reciprocal cross, white-eyed females to pink-eyed males, gives in the first generation red-eyed females and white-eyed males. These inbred gave the following colors and ratios:

Red-eyed	♀	706
Red-eyed	♂	747
White-eyed	♀	804
White-eyed	♂	832
Pink-eyed	♀	204
Pink-eyed	♂	210

The application of the same formulae to this case gives the following results:

White. ♀ $eRPX - cRPX$
 Pink ♂ $CrPX - cr$

F_1 Red ♀ $eRPXCrPX$
 White ♂ $cRPXcr$

Gametes of F_1 Red ♀ $eRPX - CrPX - CRPX - crPX$
 White ♂ $cRPX - crPX - cr - cR$

- -

$cRPXcRPX$ = White ♀
 $eRPXcrPX$ = White ♀
 $CrPXcRPX$ = Red ♀
 $CrPXcrPX$ = Pink ♀
 $CRPXcRPX$ = Red ♀
 $CRPXcrPX$ = Red ♀
 $crPXcRPX$ = White ♀
 $crPXcrPX$ = White ♀

F_2

$eRPXcr$ White ♂
 $eRPXeR$ White ♂
 $CrPXcr$ Pink ♂
 $CrPXcR$ Red ♂
 $CRPXcr$ Red ♂
 $CRPXcR$ Red ♂
 $crPXcr$ White ♂
 $crPXcR$ White ♂

In both males and females the color ratio is 4 white, 3 red, 1 pink. The actual numbers are a fair approximation to this expectation.

PART III

HEREDITY OF TWO SEX-LIMITED CHARACTERS COMBINED
WITH FOUR EYE COLOR CHARACTERS.³

In this experiment a male with short proportionate wings and white eyes—both sex-limited characters—was mated to an orange-eyed female with long wings. The white-eyed male was a white from red stock, cRPO.

In the first generation all of the offspring had long wings like the mother's; the females had red eyes and the males had vermilion eyes. These were inbred and produced the second or F₂ generation that contained flies having red, vermilion, pink, orange, and white eyes. In each of these classes, however, the short-winged individuals were males, as shown in the next table:

Red ♀ long wings.....	392
Red ♂ long wings.....	14
Red ♂ short wings.....	66
—	
Vermilion ♀ long wings.....	413
Vermilion ♂ long wings.....	254
Vermilion ♂ short wings.....	10
—	
Pink ♀ long wings.....	88
Pink ♂ long wings.....	7
Pink ♂ short wings.....	15
—	
Orange ♀ long wings.....	119
Orange ♂ long wings.....	79
Orange ♂ short wings.....	1
—	
White ♂ long wings.....	95
White ♂ short wings.....	202

It will be observed at once that the inheritance of short wings and of white eyes is strictly sex limited. It will also be observed that each eye color has been combined with short wings, but only of course in the male sex. The total number of short winged males having red, vermilion, pink, and orange eyes is 92, while

³ See also "The Method of Inheritance of Two Sex-Limited Characters in the Same Animal." Proc. Soc. Exp. Biol. and Med. vol. 8, Oct. 1910.

the number of short winged males with white eyes is twice this number. In this connection I wish to point out that the grandfather had white eyes. The possible significance of this may be discussed later. It is obvious, however, on any *theory of chance elimination* of unit characters *in the egg* that the total number of males of all eye colors having short wings must be equal to the number of short winged white eyed males.

The analysis of the results following the same methods as heretofore is as follows:

Long-winged, orange-eyed ♀	LCrpOX — LCrpOX	
Short-winged, white-eyed ♂	lcRPOXlcRpO	
Long-winged, red-eyed ♀	LCrpOXlcRPOX	F ₁
Long-winged, vermilion-eyed ♂	LCrpOXlcRpO	

Gametes of F ₁	Egg gametes <table style="display: inline-table; vertical-align: middle;"> <tr><td style="border-left: 1px solid black; padding-left: 5px;">LCrpOX</td></tr> <tr><td style="border-left: 1px solid black; padding-left: 5px;">LCRpOX</td></tr> <tr><td style="border-left: 1px solid black; padding-left: 5px;">LCrPOX</td></tr> <tr><td style="border-left: 1px solid black; padding-left: 5px;">LCRPOX</td></tr> <tr><td style="border-left: 1px solid black; padding-left: 5px;">lCrpOX</td></tr> <tr><td style="border-left: 1px solid black; padding-left: 5px;">lCRpOX</td></tr> <tr><td style="border-left: 1px solid black; padding-left: 5px;">lCrPOX</td></tr> <tr><td style="border-left: 1px solid black; padding-left: 5px;">lCRPOX</td></tr> </table>	LCrpOX	LCRpOX	LCrPOX	LCRPOX	lCrpOX	lCRpOX	lCrPOX	lCRPOX	Egg gametes <table style="display: inline-table; vertical-align: middle;"> <tr><td style="border-left: 1px solid black; padding-left: 5px;">LerpOX</td></tr> <tr><td style="border-left: 1px solid black; padding-left: 5px;">LcRpOX</td></tr> <tr><td style="border-left: 1px solid black; padding-left: 5px;">LcrPOX</td></tr> <tr><td style="border-left: 1px solid black; padding-left: 5px;">LcRPOX</td></tr> <tr><td style="border-left: 1px solid black; padding-left: 5px;">lerpOX</td></tr> <tr><td style="border-left: 1px solid black; padding-left: 5px;">leRpOX</td></tr> <tr><td style="border-left: 1px solid black; padding-left: 5px;">lcrPOX</td></tr> <tr><td style="border-left: 1px solid black; padding-left: 5px;">leRPOX</td></tr> </table>	LerpOX	LcRpOX	LcrPOX	LcRPOX	lerpOX	leRpOX	lcrPOX	leRPOX	
LCrpOX																			
LCRpOX																			
LCrPOX																			
LCRPOX																			
lCrpOX																			
lCRpOX																			
lCrPOX																			
lCRPOX																			
LerpOX																			
LcRpOX																			
LcrPOX																			
LcRPOX																			
lerpOX																			
leRpOX																			
lcrPOX																			
leRPOX																			
	Sperm gametes <table style="display: inline-table; vertical-align: middle;"> <tr><td style="border-left: 1px solid black; padding-left: 5px;">LCrpOX</td></tr> <tr><td style="border-left: 1px solid black; padding-left: 5px;">lcRpO</td></tr> </table>	LCrpOX	lcRpO	Sperm gametes <table style="display: inline-table; vertical-align: middle;"> <tr><td style="border-left: 1px solid black; padding-left: 5px;">LCRpOX</td></tr> <tr><td style="border-left: 1px solid black; padding-left: 5px;">lerpO</td></tr> </table>	LCRpOX	lerpO													
LCrpOX																			
lcRpO																			
LCRpOX																			
lerpO																			

The random fertilization of these sixteen kinds of eggs by the two kinds of female-producing spermatozoa LCrpOX and LCRpOX and their fertilization by the two kinds of male producing spermatozoa lcRpO and lerpO is represented in the following table:

Egg	Sperm X		Sperm X	
LCrpOXLCrpOX	= long orange	♀	LCRpOX	= long vermilion ♀
LCRpOXLCrpOX	= long vermilion	♀	LCRpOX	= long vermilion ♀
LCrPOXLCrpOX	= long pink	♀	LCRpOX	= long red ♀
LCRPOXLCrpOX	= long red	♀	LCRpOX	= long red ♀
				and
lCrpOXlCrpOX	= long orange	♀	LCRpOX	= long vermilion ♀
lCRpOXlCrpOX	= long vermilion	♀	LCRpOX	= long vermilion ♀
lCrPOXlCrpOX	= long pink	♀	LCRpOX	= long red ♀
lCRPOXlCrpOX	= long red	♀	LCRpOX	= long red ♀
				and
LerpOXLCrpOX	= long orange	♀	LCRpOX	= long vermilion ♀
LerpOXLCrpOX	= long vermilion	♀	LCRpOX	= long vermilion ♀
LerpOXLCrpOX	= long pink	♀	LCRpOX	= long red ♀
LeRPOXLCrpOX	= long red	♀	LCRpOX	= long red ♀
				and
lerpOXlCrpOX	= long orange	♀	LCRpOX	= long vermilion ♀
leRpOXlCrpOX	= long vermilion	♀	LCRpOX	= long vermilion ♀
lerPOXlCrpOX	= long pink	♀	LCRpOX	= long red ♀
leRPOXlCrpOX	= long red	♀	LCRpOX	= long red ♀
				and
Egg	Sperm no X		Sperm no X	
LCrpOXlCrpO	= long orange	♂	leRpO	= long vermilion ♂
LCRpOXlCrpO	= long vermilion	♂	leRpO	= long vermilion ♂
LCrPOXlCrpO	= long pink	♂	leRpO	= long red ♂
LCRPOXlCrpO	= long red	♂	leRpO	= long red ♂
				and
lCrpOXlcrpO	= short orange	♂	leRpO	= short vermilion ♂
lCRpOXlcrpO	= short vermilion	♂	leRpO	= short vermilion ♂
lCrPOXlcrpO	= short pink	♂	leRpO	= short red ♂
lCRPOXlcrpO	= short red	♂	leRpO	= short red ♂
				and
LerpOXlCrpO	= long orange	♂	leRpO	= long white ♂
LeRpOXlCrpO	= long vermilion	♂	leRpO	= long white ♂
LerpOXlCrpO	= long pink	♂	leRpO	= long white ♂
LeRPOXlCrpO	= long red	♂	leRpO	= long white ♂
				and
lCrpOXlcrpO	= short orange	♂	leRpO	= short white ♂
lCRpOXlcrpO	= short vermilion	♂	leRpO	= short white ♂
lCrPOXlcrpO	= short pink	♂	leRpO	= short white ♂
lCRPOXlcrpO	= short red	♂	leRpO	= short white ♂

Summarizing this last table we get:

Long winged red ♀ ... 12	and	Long winged red ♂ ... 4
Long winged vermilion ♀ ... 12		Long winged vermilion ♂ ... 4
Long winged pink ♀ ... 4		Long winged pink ♂ ... 2
Long winged orange ♀ ... 4		Long winged orange ♂ ... 2
		Long winged white ♂ ... 4
		Short winged red ♂ ... 4
		Short winged vermilion ♂ ... 4
		Short winged pink ♂ ... 2
		Short winged orange ♂ ... 2
		Short winged white ♂ ... 4

There should be, obviously, as many females as males. The results show 1012 females and 743 males. There is a distinct falling off of males. The two sexes give about 10 to 8 or 5 to 3.

In each class with eye color the males should be the same in number in the red and the vermilion; and in the pink and the orange. A great variability is however realized as shown below:

	RED	VERMILION	PINK	ORANGE	WHITE
Long winged ♂	14	254	7	79	95
Short winged ♂	66	10	15	1	<u>202</u>

The enormous discrepancy between theory and fact shown by the table may well make one reject the theory as totally inadequate to explain the facts. Nor can one appeal to the relative viability of the males to help him out of the dilemma; for, the long winged normal males run far behind the number for the vermilion, orange, and white; yet the long winged red eyed males are normal for the species, and do not run behind under the same conditions used in this experiment. A closer scrutiny of the table will, however, indicate a relation that may be very significant. The great excess of males is found in two classes, the long winged vermilion and the short winged white male, and these are respectively the father (the same as the grandmother's combination) and the grandfather of this F₂ generation!

PART IV

THE INHERITANCE OF THREE SEX-LIMITED CHARACTERS

In the following four crosses three sex-limited characters are involved: white eyes, short wings; and yellow color. In the first two crosses all these characters are contained in one of the parents; in the other two crosses two of the characters are in one parent and one in the other.

In earlier papers (Science, 1910 and 1911) I have described the main facts for inheritance of red *versus* white eyes, and long *versus* short (short proportionate) wings. In order to understand the relation of yellow to normal color, the following experiment may be cited. A long, red, normal (body color) female was crossed with a long, red, yellow male. The offspring, both male (654) and female (705), were long, red, normal. These inbred gave:

Normal ♀	525
Normal ♂	340
Yellow ♂	194

The reciprocal cross, viz., long, red, yellow female by long, red, normal male, gave females (397) with long wings, red eyes, normal color and males (282) with long wings, red eyes, and yellow color. These inbred gave:

Normal ♀	346
Normal ♂	259
Yellow ♀	226
Yellow ♂	230

We are now in position to take up the experiments in which three sex-limited characters, white eyes, short wings, and yellow color are involved; see Plate I.

When a yellow, short winged, white eyed male is bred to a normal wild fly with normal color, long wings, and red eyes, all the offspring are like the mother, i.e., normal color, long wings, red eyes.

YWS ♂ by NRL ♀ = $\begin{cases} \text{NRL ♀} = \text{Normal red long ♀} \\ \text{NRL ♂} = \text{Normal red long ♂} \end{cases}$

These inbred have produced four main classes of males, and three small classes, represented by a few male flies only; the females are represented by but a single class, as shown below:

Normal Color

RED EYES				WHITE EYES			
Long wings		Short wings		Long wings		Short wings	
♀	♂	♀	♂	♀	♂	♀	♂
1879	606		167		1		3

Yellow Color

RED EYES				WHITE EYES			
Long wings		Short wings		Long wings		Short wings	
♀	♂	♀	♂	♀	♂	♀	♂
	7				143		96

In addition to the flies recorded in the table there were two females belonging to two classes, viz., one, normal, long, white female; and one, yellow, long, white female. I shall not hesitate to ignore these two cases as exceptional, due either to accidental contamination through the food, or to sporting within the stock. Omitting these two females it will be seen that all of the females fall into one class having normal color, long wings, and red eyes. In all there were 1879 of these females, as against 1022 males. The females are, therefore, almost twice as numerous as the males. The three sex-limited characters appear only in the grandsons; one class containing all three sex-limited characters, yellow, short, white (96); one class containing two sex-limited characters, yellow, white (143); and one class containing one sex-limited character, short wings (167). For the moment the other three classes of males may be left out of account. It will be noticed also that the grandfather's combination is well represented by 96

individuals, while the father's combination which is the grandmother's also is represented by the great majority of all the males (606). The remaining large class contains two of the grandfather's characters, viz., yellow and short. Of the three small classes of males, one contains two of the grandfather's characters, viz., white and short, and one contains one of his characters, viz., yellow color.

In my first attempt to analyze this case I ignored the three small classes of males because I found empirically that the remaining classes and the females could be very simply accounted for, as the following formulæ will show.

	Normal, red long	♀	NRLX	-	NRLX	
	Yellow, white short	♂	YWSX	-	---	
F ₁	Normal red long	♀	NRLXYWSX			
	Normal red long	♂	NRLX	---		
Gametes of F ₁	NRLX - NRSX - YWLX - YWSX					
	NRLX - ---					
F ₂ Generation						
NRLXNRLX	= Normal red long	♀	- NRLX	= Normal red. long	♂	
NRLXNRSX	= Normal red long	♀	- NRSX	= Normal red short	♂	
NRLXYWLX	= Normal red long	♀	- YWLX	= Yellow white long	♂	
NRLXYWSX	= Normal red long	♀	- YWSX	= Yellow white short	♂	

This scheme meets with two serious difficulties. It calls for equal numbers of each kind of male while in reality one class is at least three times as numerous as any one of the others. If we tried to explain this anomaly (as in fact I think we must) on the basis of some sort of "association" taking place, we still have to meet a more serious theoretical difficulty. It will be seen that only four classes of eggs are represented in the F₁ generation. There are two classes of eggs containing N and R, and two containing Y and W, but no class containing N and W, and none containing Y and R. No theoretical explanation can admit this arbitrary treatment, for the theory on which we are working demands the full interchange of all of these characters—unless some special reason can be given for failing in this regard.

Now it will be seen that the combinations of N and R, and Y and W are the combinations that existed in the parents of this cross. To admit the foregoing scheme requires the recognition of this union as permanent in subsequent generations. Yet this is opposed to the Mendelian treatment of the case, unless association is admitted as valid.

If now we take up the case of the three small classes of males we find no place for them in this scheme. I see no reason for ignoring them, small though the classes be. This consideration leads me to the conclusion that instead of four classes of eggs in the F₂ generation, the possibility of eight classes must be admitted, but owing to the initial association of N and R, and Y and W, their separation only occasionally occurs. When it does, the small classes of males appear, and the number of individuals in these classes is a measure of the infrequency with which the separation occurs. The scheme when fully worked out is as follows:

Normal female NRLX - NRLX
 yellow white short ♂ YWSX - —

F₁ Normal ♀ NRLXYWSX
 Normal ♂ NRLX - —

Gametes of F₁
 NRLX - NRSX - NLWX - NWSX - YWSX - YWLX - YRSX - YRLX
 NRLX - —

NRLXNRLX	= Normal red long ♀	-	NRLX	= Normal red long	♂
NRLXNRSX	= Normal red long ♀	-	NRSX	= Normal red short	♂
NRLXNLWX	= Normal red long ♀	-	NLWX	= Normal white long	♂
NRLXNWSX	= Normal red long ♀	-	NWSX	= Normal white short	♂
NRLXYWSX	= Normal red long ♀	-	YWSX	= Yellow white short	♂
NRLXYWLX	= Normal red long ♀	-	YWLX	= Yellow white long	♂
NRLXYRSX	= Normal red long ♀	-	YRSX	= Yellow red short	♂
NRLXYRLX	= Normal red long ♀	-	YRLX	= Yellow red long	♂

It is seen that the two factors N and W (or Re) tend to hold together. Both are contained in the sex chromosome, i.e., N and c are there. Both are present in the grandmother, and through

her carried into her son—the father of the F_2 generation. The grandmother transmits only one X to her grandson—the one in question. It is also seen that the two factors Y and R tend to hold together in the same way. On the other hand the factor for long and short wings seems freer to leave one X and pass to its partner without showing any very great tendency to associate with the color factors in X.

The reciprocal cross, viz., a female with yellow color, white eyes, and short wings, bred to a normal male with normal color, red eyes, and long wings, gave females with normal color, red eyes, and long wings, and males with yellow color, white eyes, and short wings.

$$\text{YWS } \text{♀} \text{ by NRL } \text{♂} = \begin{cases} \text{NRL } \text{♀} = \text{normal red long } \text{♀} \\ \text{YWS } \text{♂} = \text{yellow white short } \text{♂} \end{cases}$$

These inbred gave the classes in the next tables:

Normal Color

RED EYES				WHITE EYES			
Long wings		Short wings		Long wings		Short wings	
♀	♂	♀	♂	♀	♂	♀	♂
439	319	208	193	1	5	5	11

Yellow Color

RED EYES				WHITE EYES			
Long wings		Short wings		Long wings		Short wings	
♀	♂	♀	♂	♀	♂	♀	♂
7	5	178	139	365	335	365	335

Here again the two pairs of grandparental characters, viz., normal color with red eyes; and yellow with white eyes, are represented by the eight large classes in the F_2 generation; while short and long wings are nearly equally distributed. But even here there are more grandchildren with normal color, red eyes, and

long wings, than with short wings. These two colors went together with long wings in the grandfather. Conversely, the grandmother combined short wings with yellow color and white eyes, and there is an excess of short winged grandchildren (σ and φ) over long winged (σ and φ). The shorter analysis is as follows:

Yellow, white, short φ YWSX — YWSX
 Normal, red, long σ NRLX — —

F₁ Normal φ YWSXNRLX
 Yellow, white, short σ YWSX —

Gametes of F₁ YWSX — YWLX — NRLX — NRSX
 YWSX —

YWSXYWSX = Yellow white short φ — YWSX Yellow white short σ
 YWSXYWLX = Yellow white long φ — YWLX Yellow white long σ
 YWSXNRLX = Normal red long φ — NRLX Normal red long σ
 YWSXNRSX = Normal red short φ — NRSX Normal red short σ

If the more extended analysis for the gametes of the female were used there would be four more classes of eggs, namely, YRSX, YRLX, NWLX, NWSX, which would give four new classes of females, namely, yellow, red, short; yellow, red, long; normal, white, long; and normal, white, short; of which the second, third, and fourth are represented in the table by seven, one and four females respectively. The extended analysis would also give four other classes of males, whose formulae correspond to those of the four new types of eggs given above in the text, of which two are realized and two are not.

In the third cross, a female with normal color, white eyes, and short wings was bred to a male with yellow color, red eyes, and long wings. The female offspring had normal color, red eyes, and long wings, and the male offspring had normal color, white eyes, and short wings.

NWS φ by YRL σ = $\begin{cases} \text{NRL } \varphi = \text{Normal red long } \varphi \\ \text{NWS } \sigma = \text{Normal white short } \sigma \end{cases}$

The F₁'s inbred gave the classes shown in the next table:

Normal Color

RED EYES				WHITE EYES			
Long wings		Short wings		Long wings		Short wings	
♀	♂	♀	♂	♀	♂	♀	♂
439	7	235		218	237	359	387

Yellow Color

RED EYES				WHITE EYES			
Long wings		Short wings		Long wings		Short wings	
♀	♂	♀	♂	♀	♂	♀	♂
	345		210				4

In the second generation there are four kinds of females and six kinds of males. If we recognize the union of N and W and Y and R in the gametes of F₁ (the union that was present in the grandparents) the expectation on the shorter analysis is as follows:

$$\begin{aligned} &NWSX - NWSX \\ &YRL - \text{---} \end{aligned}$$

F₁ Normal, red long ♀ NWSXYRLX
 Normal, white short ♂ NWSX —

Gametes of F₁ NWLX - NWSX YRLX - YRSX
 NWSX - —

NWSXNWLX = Normal, white long ♀ — NWLX = Normal white long ♂
 NWSXNWSX = Normal, white short ♀ — NWSX = Normal white short ♂
 NWSXYRLX = Normal red long ♀ — YRLX = Yellow, red, long ♂
 NWSXYRSX = Normal, red short ♀ — YRSX = Yellow, red short ♂

If we admit the more extended segregation, the same disproportions appear, but the two smaller classes of males are now represented and two classes of males do not appear at all (as in the

realization). In regard to the couplings in these cases it is of great importance to notice that once more the long and short factors segregate without regard to the color factors, yet even here a remarkable fact comes to light. The two classes of males that exceed the others are those in which the long, red, yellow combination and the short, white, normal combination exist. These are the two combinations that were in the grandparents. If we assume that they more often remain in the same chromosome the numerical results become apparent.

In the fourth cross, a male with normal color, white eyes, and short wings was bred to a female with yellow color, red eyes, and long wings. The female offspring had normal color, red eyes, and long wings, and the males had yellow color, red eyes, and long wings.

$$NWS \sigma^{\text{♂}} \text{ by } YRL \text{ } \varphi = \begin{cases} NRL \ \varphi = \text{Normal red long} \\ YRL \ \sigma^{\text{♂}} = \text{Yellow red long} \end{cases}$$

The second or F₂ generation is represented in the next table:

Normal Color

RED EYES				WHITE EYES			
Long wings		Short wings		Long wings		Short wings	
♀	♂	♀	♂	♀	♂	♀	♂
608	2			137			237

Yellow Color

RED EYES				WHITE EYES			
Long wings		Short wings		Long wings		Short wings	
♀	♂	♀	♂	♀	♂	♀	♂
389	248		101	1			1

Only four large classes of males are represented and it is significant that these are the yellow-red and the normal-white—the two combinations that correspond to the two grandparental com-

binations. These two classes occur both in the long and short wings, but here again occurs the significant fact that the yellow, red, long are twice as frequent as the yellow, red, short. The former is the grandmaternal combination. Again the normal, white, short are nearly twice as numerous as the normal, white, long and it is the former combination that is characteristic of the grandfather. The shorter analysis follows:

YRLX - YRLX
NWSX - —

F₁ Normal red long ♀ YRLXNWSX
 Yellow red long ♂ YRLX -

Gametes of F₁ YRLX - YRSX - NWLX - NWSX
 YRLX - —

YRLXYRLX = Yellow, red, long ♀ - YRLX = Yellow, red, long ♂
YRLXYRSX = Yellow, red, long ♀ - YRSX = Yellow, red, short ♂
YRLXNWLX = Normal red, long ♀ - NWLX = Normal, red, long ♂
YRLXNWSX = Normal red, long ♀ - NWSX = Normal, red, short ♂

The same objections may be urged against this scheme that have been given for the first short scheme. It is unnecessary to write out the longer scheme again in this case as the same principle employed in the first instance is applicable here. Of the four additional classes of males called for by the longer analysis, three appear in the results represented by any 2, 1, and 1 males respectively.

PART V

CONCLUSIONS

A THEORY TO ACCOUNT FOR "ASSOCIATIVE" INHERITANCE

In the preceding pages I have tried to show how the mechanism that exists in the chromosomes can be applied to the mechanism of heredity, provided we deal with particles or chemical substances in the chromosomes rather than with the chromosomes as units. The evidence makes out, I believe, a very strong case in favor of the idea that sex-limited inheritance is connected with the same physical body that determines sex, and I have not hesitated to identify that body with the sex chromosome. The second point of significance in the results is that while in the female there may be an interchange between homologous chromosomes, no interchange takes place in the male of those factors connected with sex-limited inheritance. We can explain this result if these characters are contained in the single X chromosome in the male which alone has no mate. The third point of interest in these results is the necessity of assuming some combination or rather localization amongst some of the substances resident in the same chromosome. The peculiar ratios found in the second generation find their explanation only by means of such an assumption. Couplings and linkages have been described before to account for observed ratios, notably by Bateson and his collaborators, but I think we see here clearly for the first time that these unions are not due to inherent relations, or fusions, or attractions, or correlations, or repulsions, but to juxtaposition of particles in the chromosomes. It has been shown in a considerable number of cases that at one stage in the process of union of homologous chromosomes the members of each pair twist around each other like the components of a rope. Subsequently these twisted chromosomes fuse together and shorten. Later a longitudinal split appears in the shortened, double chromosome. This split now lies in one plane, i.e., it does not follow the turns of the united chromosomes. In consequence of the position of the new plane

of splitting or division each half, or new chromosome, must be made up of parts of one and parts of the other of the two original chromosomes that united in pairs as Janssens has shown. As a result of the subsequent "reduction" division the cells that are produced will contain new combinations of the materials composing the original chromosomes. If the chromosomal materials that represent the factors of heredity are placed lineally along the chromosome and in corresponding linear series in each pair of homologous chromosomes, random separation of these materials will be brought about by means of the cell mechanism, explained above, except in those cases where the materials lie near together. In the former case, the usual Mendelian random segregation will take place; in the latter case, groups of factors will tend to remain together or be associated in heredity. These latter cases correspond to those in which we find "association" to occur. It will be observed that while such associations will be more or less common according to the nearness of the associating factors in the chromosome, the associations are not absolute for occasionally the twisting of the chromosomes will be such that even regions lying lineally near together will come to lie on opposite sides of the united chromosomes. These cases represent the small classes observed in the tables. In the case of the X-chromosomes we should expect interchanges of the postulated kind to occur when two X's are present, as in the female of *Drosophila*; but no interchanges when only one X is present as in the male. The experimental results accord completely with this anticipation and afford strong evidence in favor of the view expressed above. This assumption seems to be far simpler than the assumption of attractions, repulsions and complicated ratios that Bateson has suggested as an interpretation of similar phenomena.

It is obviously not essential to this hypothesis of factorial interchange to limit it to the particular stage of the chiasma type here suggested, for if a similar phenomenon occurs at any other stage in division the same results will follow.

DISINTEGRATION OF A SPECIES AND ITS RECONSTITUTION BY RECOMBINATION

The series of mutations that have appeared in *Drosophila* can all be accounted for on the assumption of losses from the original germ-plasm. There is possibly one exception to this rule, namely, the melanitic or black mutant that may appear to add something to the original color. When crossed to the normal it gives an intermediate type in the first generation, and this fact also might be urged in favor of the change being in a positive direction. But since in the second generation the black fly appears as the recessive type it is not improbable that even this mutant may be due to loss. The most convincing proof that the eye and wing mutations are due to loss is found in the reconstitution of the original or wild type when certain recombinations are made. So many examples of this have been given in the preceding pages that I need not go over the evidence again. Two points, however, may be recalled as instructive. In several combinations the female alone is reconstituted. In the older terminology the female is the atavist, the male is the neomorph; and it is always the female and never the male that shows this relation if either one is atavistic. The reason for this is also clear from the evidence—the male-producing sperm has all the recessive factors in question, while the female-producing sperm has one or more dominant factors. No better example than this one of unisexual atavism, or reconstitution, could be cited to show the advantage that the modern explanation of heredity has over the older view, where a fact of this kind would have seemed totally inexplicable.

The second point of interest in this evidence is found in the different behavior in heredity of the original and of the reconstituted (atavistic) type, for while the wild type continues to breed true the reconstituted type splits later into its components. The reconstituted type may be said to be physiologically complete, but morphologically dismembered. For example, when a vermilion male is bred to a pink female, all of the offspring are red. The four substances, R P O C, necessary to produce red have

been brought together, so that all the elements of the wild fly are present that collectively give red eye-color; but now instead of the chromosomes that carry these substances being represented in duplicate, some of the chromosomes lack one or the other substance. It is due to this that the splitting takes place in the formation of the germ-cell of these reconstituted types. Nevertheless it is possible even to reconstruct the original wild forms by suitable combinations, such, for example, as will give in duplex the four factors essential to the development of red eyes, and the structurally reconstituted types will breed as true to type as the wild flies, in contrast to the atavists that are only physiologically reconstituted.

THE PRESENCE AND ABSENCE THEORY IN RELATION TO THE THEORY OF ASSOCIATION

The appearance of so many mutants, due to losses, raises the question as to whether all new types that follow Mendel's law may come under the same category. There are types, it is true, among domesticated forms that appear to have added something to the original type from which the mutants arose, but some of these are due to hybridization, and some may be due to losses of inhibiting factors, whose absence permits the further elaboration of characters already present. As yet the evidence is insufficient, I think, to allow any certain generalization in this regard, yet the evidence suffices at least to show that many or even most cases that follow Mendel's law fall under this head. In so far as the mutants are due to losses they are explicable on the presence and absence theory, which may seem to give some grounds for the universal application of this principle. There is, however, one possibility that we can not afford at present to ignore, namely, the evidence of "association" which is clearly furnished by some of the crosses described in the preceding pages. I should like to dwell a little further on this point. If I am right in explaining the results of those cases where two or three sex-limited characters are involved on the grounds of the juxtaposition of substances (factors) in the chromosomes, it is only a step further to cases,

like those of the gray mouse when the color factors for gray, namely, black, yellow, chocolate, and ticking, remain permanently associated when crossed with a mutant which contains only one of these same factors. Thus when a yellow bearing germ cell meets one bearing gray, all of the offspring are yellow. These yellows inbred produce only grays and yellows and not blacks and chocolates also, as should happen, did each of the elements in the original gray have for its mate the absence of its particular factor.⁴ In *Drosophila* the eye color is made up of three or four color factors. When a wild female is crossed to one of the mutants an orange eyed male for example, all of the offspring are red. In the F_2 generation not only red and orange, but pink and bright red also appear, although even here there is a stronger tendency for the original red to reappear more often than its products. It seems to me probable at least that the difference between the mice and the fly in this respect may be due to the closer association of the factors in the mice than in the fly. If so, the difference is one of degree only and not of kind.

THE FERTILITY OF DEFICIENT MUTATIONS

A striking fact in regard to most if not all of these mutations in *Drosophila* is their infertility compared with the original stock kept under identical conditions. As I have this matter under investigation I wish here to touch on it very briefly, and only in so far as it bears on the numerical proportions of the different types. The pure stock of several of the new types is less productive than the original stock, and the failure in several cases of the deficient types to appear in the expected ratios suggests that this failure is due in part to the failure in fertility or in vitality of the new types. Whether this is due to failure in the development of the egg, or of the sperm, or to failure to fertilize, or to lack of development of the embryo, are points requiring special study, but the facts are sufficiently numerous to raise the question as to whether a type that lacks some material present in the original

⁴ See Morgan, T. H. The influence of the environment and of heredity on the inheritance of coat color in mice. New York Academy of Science. 1911

stock may not in many cases lose also its full power of productivity. It may seem improbable that the presence of some substance necessary for the development of a particular color in the eye could have any influence on the rest of the germ, but the same substance that is essential for eye color may be essential for the production of other things in the body that are not so apparent. In fact, I have already obtained evidence in the case of the eye color-producer, C, that the absence of C not only affects the eye-color, but other parts in the body as well. It is not impossible, therefore, that in certain cases the absence of a factor may have an important influence in one or another way on the productivity of the animal. I do not wish to discuss further this question until I can bring forward certain evidence that bears directly on it, but I have raised the question here, first in order to point out its possible bearing on the disturbance of Mendelian ratios, and second, in order to make clear that while I regard the evidence in favor of the mosaic inheritance of certain characters as established, I am not unappreciative of the fact that a simple factor may have a wider influence in development than appears when only a single character is under consideration.

ORIGIN OF MUTATIONS THROUGH CHROMATIN LOSSES

The mutations that have occurred in *Drosophila* may throw some light on the origin of mutations in general. If my analysis is correct it follows that mutations arise not through losses of whole chromosomes as some cytologists have hinted (for the individual chromosomes must be supposed to carry not one but a host of factors) nor through the doubling of one or of all of the chromosomes (which would only add to what is already present in duplex) but mutations arise through the regrouping of particular substances carried by the chromosomes. These substances may be so small in amount that their absence may entirely escape a cytological examination. It would seem that ample opportunity must be present for losses of this kind, since any irregularity in the division of the chromatin in the germ tract would lead to the appearance in time of a mutant if such were viable and if the

right combinations were brought about. If, for instance, in the division of the spermatogonial cells the material particles at any level should fail to divide when the rest of the chromosome divides, one of the resulting cells will be deficient in the substance in question, and its offspring will be correspondingly deficient. Or if after synapsis similar particles in homologous chromosomes should pass into one chromosome, instead of segregating, one of the resulting cells will be deficient. The wonder is that such losses are so infrequent.

THE BEARING OF THE RESULTS ON THE CONSTITUTION OF THE SEX CHROMOSOMES

The experiments on *Drosophila* have shown that a most complicated series of facts relating to sex-limited inheritance can be accounted for, as I pointed out in my paper of 1910, on the assumption that one of the factors for such characters is combined with the sex factors, X, or more specifically (Morgan,⁵ Wilson 1911) if it is contained in the accessory or sex chromosome. The absence of this chromosome in half of the spermatozoa, and the impossibility of an interchange between this simple X-chromosome in the male (since X has no pair in synapsis) is the significant feature of the explanation. *What is most important, is the discovery that the X-chromosome contains not only one of the essential factors in sex determination, but also all other characters that are sex-limited in inheritance.*

The discovery of this relation leads us a step farther, I think, in the analysis of the problem of sex determination, for it shows that the determination of sex is only one of several (perhaps of a large number of) properties contained in the sex chromosomes. Only by the loss of a factor from one of the other X's (in the female) is it possible to discover just how many factors are contained in X. Already four or five such losses have appeared in my mutations. *This leads at once to the inference that it is not the X-chromosomes, as such, that is a factor in sex determination, but only a very small part of its material.*

⁵ In a paper read before the American Society of Naturalists, December 29, 1910. Published in *American Naturalist*, 1911.

I suggested in 1905 that the female sex is determined by the presence of more chromatin in the fertilized egg. Wilson suggested in 1906 that it is a particular chromosome that gives the quantitative results (or at least a more or less 'active' chromosome). The results of the experiments dealing with sex-limited inheritance in *Drosophila* demand that we go one step further, for they show that it is only a small part of this chromosome that is involved in sex determination.

If this is admitted we can understand how sex may be regulated in the same way, even when X and its mate Y appear to our relatively gross methods of measurement to be equal. The difference in size between X and Y that gives a completely graded series in different species has little to do, therefore, with conditions relating to sex determination, except in so far as the initial loss of the sex substance contained in Y led to a decrease in size. I am inclined to think that the difference in size relation between X and Y represents largely the loss from Y of those materials that play a rôle in sex-limited inheritance. *If X is the sex chromosome, then Y is the sex-limited chromosome in a double sense.* Its final disappearance in certain forms represents the total loss of all characters that can become sex-limited in inheritance.

If it is legitimate to draw any inference from the analogy between sex determining factors, and factors that determine other characters of the organism, it follows with a fair degree of plausibility that Y lost a sex factor (contained in the three X's of the species, 2 in the female, 1 in the male) in the same way that it has lost other factors also. If these factors are, as I have suggested, on a *par*, it follows that the material in question is the female determining factor, F. Where then is the male determining factor? I have given my reason recently for dissenting from the position taken by several writers that the male condition is simply less X chromatin. It seems to me that if we treat the problem of sex determination by the same methods used for Mendelian characters in general, we can not justify such a position but are led inevitably to the conclusion that if the X-chromosome *contains* (not *is*) the factor for producing a female, the factors

for producing the male must be located in some other chromosome.⁶ This interpretation I have developed briefly in a recent article⁷ in which the female factor supposed to be contained in the X-chromosome is represented by F and the male factor, supposed to be contained in some other chromosome (not in Y however which is ranked with the three X's except in so far as certain factors have been lost), is represented by M. The following scheme shows how the relation of the sexes on this basis and how sex is determined:

	Gametes of female FM-FM	or	XM-XM
	Gametes of male FM-M		XM-M
F ₁	female FMFM	or	XMXM
	male FMM		XMM

⁶Not in X because in males having only one X (no Y) the scheme will not work out.

⁷The application of the conception of pure lines to sex limited inheritance and to sexual dimorphism. *The American Naturalist*, Feb., 1911.

PLATE 1

EXPLANATION OF FIGURES

- 1 Normal red-eyed fly.
- 2 Yellow fly with white eyes and "short proportionate" (or miniature) wings.
- 3 Short winged fly (as in fig. 2) with normal color and white eyes.
- 4 Brown fly with red eyes and long wings. This fly is yellowish, but differs from fig. 2 in the absence of a black factor (absent also in fig. 2) as well as a second factor probably a yellow factor. Its formula is $B r b y$. In the reproduction the bands and tip of the abdomen are too black. They should be more like fig. 2 and the yellow should be more saffron. This fly was not used in these experiments.



1



2



3



4

ON THE STRUCTURE, PHYSIOLOGY AND USE OF PHOTOGENIC ORGANS, WITH SPECIAL REF- ERENCE TO THE LAMPYRIDAE

E. J. LUND

Bruce Fellow, Johns Hopkins University

NINE FIGURES

Introduction.....	415
Material.....	416
Methods.....	417
Structure of the photogenic organs of the Lampyridae.....	418
Physiology.....	431
A. Effects of chemicals.....	437
B. Observations on the localization of the photogenic process in the organs.....	439
C. Effects of rapid changes in air pressure, upon the organs.....	442
D. Control.....	445
E. Effects of temperature.....	448
a. Upon the photogenic process.....	448
b. Upon the photogenic secretion of <i>Cypridina squamosa</i> (?) and <i>Cyclopina gracilis</i>	449
c. Upon the osmic acid reaction.....	451
Use of the organs.....	455
Summary.....	457

INTRODUCTION

The subject matter of this investigation is presented in some detail, partly because the forms of Lampyridae here studied have not been studied before and partly because variety of material has been available. I have attempted to bring together the main results of other workers on the subject with my own in order that some of the points in the anatomy, physiology and use of these organs of light production may become more intelligible.

The literature on the subject of animal and plant photogeny that has accumulated is vast. Yet the advance in our knowledge of the processes, structure and use of the photogenic tissues lies mostly within the last forty years. Often the observations by different authors vary and are contradictory upon points that

would seem simple, and as a result a great number of notes and references are found in running over the literature that are little more than confusing and have added nothing to our knowledge of the subject. A list of the most important papers bearing directly upon the subject matter and others to which reference will be made has been appended at the end of this article.

I am indebted to Professor E. A. Andrews for his kindly interest in the work and for reading the manuscript, to Professor H. F. Nachtrieb of the University of Minnesota, and to Professor C. M. Child of the University of Chicago for generously placing laboratory facilities at my disposal during the summer seasons of 1909 and 1911.

I shall use the term photogeny which has come into more general use of late, to designate the processes concerned in the production of light by living organisms, without rejecting nor accepting the term phosphorescence as a proper one; first, because the latter has come to stand for apparently different phenomena occurring under varying conditions, and second, in view of the fact that our former conception of the processes of oxidation has undergone change in recent times and is continuing to do so. Le Bon has employed the general term phosphorescence in making a perhaps serviceable division of the phenomena: (1) Phosphorescence generated by light; (2) Phosphorescence independent of light and determined by different physical excitants, such as heat, friction, electricity and the X-rays; (3) Phosphorescence by chemical reaction; (4) Invisible phosphorescence. According to this division our problem can with certainty be placed under the third head, for there is abundant proof that the production of light in animal and plant tissues is a result of some kind of change in the chemical constitution of the substances concerned in the process.

MATERIAL

The material was obtained during the summers of 1908-11. The early part of the work was done upon material collected in the vicinity of St. Paul, Minnesota. Other material was collected at various points in Jamaica throughout the season, 1910,

during the summer session of the Johns Hopkins University Marine Zoological Laboratory located at Montego Bay, while material used in 1911 was obtained in the vicinity of Chicago. The time for the occurrence of the different species of Lampyridae that were studied is about the same wherever they were observed, lasting from about the last part of June to about the first part of August in Minnesota. The period of their occurrence in Jamaica is considerably longer though varying with the altitude and various climatic conditions. The following identified species of luminous Lampyridae have been studied especially as regards the anatomy of the photogenic organs.

Minnesota species

Pyropyga indicta Lec.
Lecontia (Pyractomena) lucifera Melsh.
Photuris pennsylvanicus DeGeer.
Photinus ardens Lec.—two varieties.

Jamaica species

Photinus maritimus.
Photinus commis-us E, Oliv.
Photinus pallens Fabr.
Photinus pantoni E, Oliv.
Photinus ebriosus E, Oliv.
Photinus suavis E, Oliv.
Photuris jamaicensis E, Oliv.
 Several other forms of *Photinus* sp. (?)

Studies on the physiology have been mostly upon *Photuris pennsylvanicus*, *Photinus ardens*, *P. maritimus*, *P. ebriosus*, *P. pallens*.

METHODS

The varying methods of preparation used by different authors, no doubt in part account for some of the minor differences in their descriptions of the structure of the organs. Most of the papers deal with the European species *Luciola italica*, *Lampyris splendidula* and *L. noctiluca*. I have not had the opportunity to get material of these species. However, the descriptions show that no essential histological differences exist between the European, American and Jamaican forms so far studied, though there may be lesser differences, consisting mainly in the size and position of the organs on the abdominal segments and the grosser relations of the tracheal system to the layers of the photogenic

organ. In killing and fixing, the abdomen was cut off before immersing in the fixing fluid. All of the more common killing and fixing agents were tried. Among these formalin 4 to 10 per cent, alcohol 80 per cent, Flemming's fluid, osmic acid 0.5 per cent aqueous solution, and water at the boiling point, were the most useful, depending upon what part or structure the preparation was intended to bring out. Other methods employed will be described later on. All sections were stained on the slide or cover glass. A large number of stains were tried and as a result the following were found most useful: Thionin aqueous solution, Borax carmine and Lyons blue, and Ranviers picro carmine as general stains. The best of all was found to be a solution made up as follows: anilin blue 0.5 gram, orange G. 2.0 grams, oxalic acid 2.5 grams, water 100 cc. Instead of anilin blue Lyon's blue may be used, though the preparations obtained with the latter were much inferior. Photogenic tissue fixed in boiling water for one minute afforded beautiful preparations. The photogenic cells of *Odonotosyllis pachydonta* could be differentiated from among the other epidermal cells. Granules of the photogenic cells; fat globules in the fat cells, and chitin stain orange-yellow (and yellow) respectively; cytoplasm light blue, cell membranes where present dark blue, granules of the dorsal layer (urate granules of some authors) stain blue. To show relations of the tracheal capillaries and tracheal end cells a 0.5 per cent aqueous solution of osmic acid was used, sections cut 1 to 15 microns thick and mounted to advantage without staining. By means of dissection of the active organs and examination under the binocular or compound microscope in a dark room facts fundamental to an understanding of the photogenic process could be made out.

STRUCTURE

The following description of the structure of the photogenic organs applies to all the species of Lampyridae examined except when otherwise stated. The location of the organs is limited to the sternal plate of the fifth and sixth or part of either the fifth or sixth abdominal segment. In all the forms studied the chitin

of the sternae opposite the photogenic organs is transparent and covered with hairs as are other parts of the abdominal ring. Lining the inside of the chitinous integument is the thin hypodermis, represented by a single layer of flattened cells with flattened nuclei (figs. 7 and 8 *H*). No evidence of proliferation of the hypodermal cells and their subsequent differentiation into cells of the photogenic layer has been obtained from any of the preparations of the adult forms studied. DuBois has studied the development of the photogenic organs in *Lampyris noctiluca* and *Pyrophorus noctilucus* and states that the tissues are derived from proliferating cells of the hypodermis. If this observation be correct it would preclude the photogenic cells from having a common origin with the cells of the fat-body as some authors have supposed. The fact that the granules of the cells of the photogenic layer stain in several respects like those of the globules in the cells of the fat body, affords by itself no evidence of an ontogenetic relationship of the fat-body and the photogenic cells. In all the species the organ consists of the two usual layers, the dorsal or "urate cell layer" of some authors and the lower or photogenic layer. The photogenic layer is completely enclosed by the dorsal layer, except where the former is applied to the hypodermis over the whole or part of the sternite depending upon the size of the organ. I have found no trace of any membrane covering the inner side of the organ as Wielowiejski ('82) states that he found in *Lampyris splendidula*. Townshend ('04) finds no membrane present in the American form, *Photinus marginellus*, and no such structure has been found in the other European species.

In consideration of the theories advanced by Heineman ('86) and DuBois ('95) to account for the control of the organs by means of the segmental muscles in producing increased air pressure or causing a flow of blood through the organ we should perhaps expect to find a greater development of the muscles related to them. This however is not the case. The muscular development in the segments bearing the photogenic organs is not more extended than in any of the segments anterior to them. The muscular apparatus of each of the fifth and sixth segments con-

sists of three main sets of muscles, one dorsi-ventral, and two antero-posterior sets one dorsal and one ventral (fig. 1, *a*, *b*, *c*). The dorsi-ventral set is composed of two bundles one on each side in each segment. These are inserted dorsally in the tergum and penetrating the tissue of the photogenic organ are inserted on the ventral side in the chitin of the sternite, appearing on the exterior as a visible spot or indentation which is not luminous. These muscle fascicles are not in contact with the photogenic layer

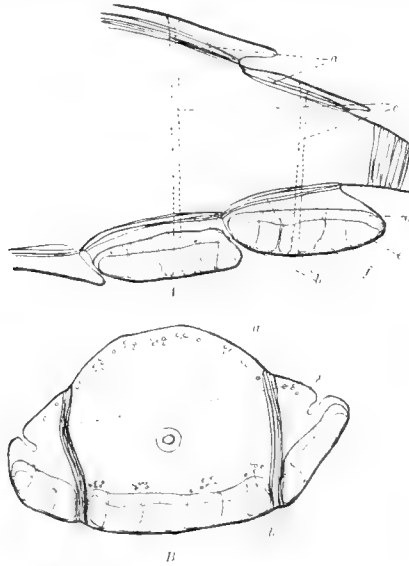

Fig. 1 Camera lucida outline of abdomen to show relations of muscles and photogenic organ. *A*, longitudinal section; *B*, cross section; *a*, longitudinal tergal muscles; *b*, longitudinal sternal muscles; *c*, vertical muscles or 'vertical exspirators'; *d*, dorsal layer; *e*, photogenic layer; *f*, vertical tracheae.

but separated from it by more or less of a continuation of the dorsal layer. The antero-posterior muscles are shown in fig. 1. Their insertions are on the tergal and sternal membranes. They serve to shorten the abdomen by telescoping the abdominal rings. Their position and arrangement has no definite relation to any single trachea or group of tracheal trunks. The tissue of the photogenic organ does not adhere tightly to the chitinous integ-

ument, e. g., *P. pennsylvanica* and *P. pallens*. It is of a pasty consistency yet firm enough so that it may readily be separated from the integument intact by proper manipulation with a small, soft brush. In this way it may be studied with readiness under a low or high power, treated with reagents, etc. A more direct effect of the reagent can be observed in this way, than by simply immersing the whole animal or abdomen. The two layers of the organs vary in thickness within certain limits in different species, but no marked seasonal variation of either layer has been found. However, relative changes in the contents of the cells of the dorsal and photogenic layers are plainly evident (p. 422). Wielowiejski ('89) came to the conclusion that cells of the layers in *L. splendidula* were distinct. Bongardt ('03) found no photogenic cells in the process of transformation into cells of the dorsal layer in the same form. Du Bois ('95) states that the cells of the photogenic layer in *L. noctiluca* are transformed directly into the crystalline deposit which he states makes up the dorsal layer. He figures no cellular structure in the dorsal layer. Bongardt ('03) also found cells in *L. noctiluca* which combined some of the characters of both the photogenic and the dorsal layer cells, and says that they may in so far be considered 'Übergangzellen.' The figures of both these authors are too inadequate to enable me to make out what all the facts are. In all the species the active adults of which I have examined, the dorsal and photogenic cells (figs. 7 and 8) are different as regards nuclei, cytoplasm and cytoplasmic granules, and no intermediate or transformation stages of the cells *as such* of one layer into the other has been found. This was most clearly shown in sections of *Photinus ardens*, *P. ebriosus*, *P. pallens*, *Photuris jamaicensis* and *P. pennsylvanica* fixed in osmic acid and stained in iron-haematoxylin followed by van Gieson's-picric-acid-fuchsin, also with phospho-molybdic acid haematoxylin (fig. 7), thionin-eosin, and best of all by the anilin blue-orange G. stain. In these preparations the groups of photogenic cells show a definite peripheral boundary (fig. 7, Z.), the cytoplasm of which is nearly uniform. Inside of this boundary are the granular contents. In some species tracheal-end-cells of the tracheal system are

found between the two layers and may readily be mistaken for cells which seem to be transforming from cells of one, into cells of the other layer, if they are not brought out by the use of osmic acid. Cells which seem to be in the process of transformation may also appear in sections which have been improperly and weakly stained in, e. g., picro-carmin. In some such preparations it is almost impossible to distinguish any sharp line of separation but other sections of the same specimen when stained with, e. g., the anilin-orange G. stain show a sharp line of demarcation between the layers. The dorsal layer consists of closely packed polygonal cells sharply outlined by cell walls and with a nucleus centrally located. The cytoplasm may contain different amounts of granule deposit, depending upon the physiological state of the photogenic organ. The cells however nearly always retain their original outline and size, showing that the visible difference in the state of the cells is only that of the amount of the product of metabolism. The filling up of the cells of the dorsal layer may proceed to such an extent that apparently all the cytoplasm becomes displaced, the original cell boundary and position of the nucleus barely remaining visible. How this comes about we shall see very shortly. In all the species the organs are penetrated by tracheal trunks which arise from more or less irregular branching tracheal trunks in the body cavity or from tracheae which lie upon the dorsal side of the organ. These tracheae which pass into the organ penetrate the dorsal and photogenic layers in different ways. Thus in males and females of *P. pennsylvanica* *P. pallens*, *P. jamaicensis* and males of *P. suavis* and *P. commissus* the vertical tracheation is most pronounced. Taking all the species as a whole we find a great variation in the direction of penetration of the tracheae through the organs. In the forms which have a thick photogenic organ the tracheae as a rule are vertical while in species which have a thinner organ or the photogenic layer only one cell deep very few tracheae penetrate the photogenic layer. In the latter forms the tracheae branch and spread out upon the ventral side and between the dorsal and photogenic layers of the organ (figs. 3 and 8). The illustrations are from such organs as have their tracheae verti-

cally placed except fig. 8. Sections of organs with vertical or horizontal tracheation show the general relation of parts most distinctly.

The photogenic layer consists of three different kinds of cells (figs. 4, 7 and 8) (a) The cells of the tracheal epithelium, (b) The tracheal end cells,¹ and (c) Densely granular photogenic cells, which make up the greater part of the photogenic layer though this may vary in different species and different specimens of the same species. When a horizontal section (fig. 4) is made through an organ with vertical tracheation thereby obtaining cross sections of the vertical tracheae, we find the lumens of the vertical tracheae appearing as round openings (fig. 4, *L*). Immediately outside of the vertical tracheal tube, crescent shaped nuclei may be found applied close to it. (Fig. 4 *N*.) These designate the position of the cells of the tracheal epithelium and are the only cells to be considered as making up the tracheal epithelium. The cytoplasm of the tracheal epithelial cells is clear and small in amount. Outside of this structure are found somewhat irregularly placed nuclei of cells which are arranged in a concentric ring or mass around the vertical trachea and its epithelium. These are the tracheal end cells. They form a vertical hollow cylinder (figs. 3, 4, *E* and 7, *E*) around the vertical trachea and the length of this cylinder of cells shown in section in figs. 3 and 7 is equal to the length of the part of the vertical trachea which passes through the photogenic layer. If the trachea assumes an oblique direction the extent of the cylinder or tube of tracheal end cells is longer and follows the trachea throughout the whole distance which it passes in the photogenic layer. The distinction between the cells of the tracheal epithelium and the tracheal end cells has not been made heretofore. The tracheal end cells have often been considered as constituting the tracheal epithelium. Townshend ('04) states that they are distinct in *P. marginellus*.

¹ The term transition cell has been used by Townshend ('01) and Holmgren ('95). The term tracheal-end-cell however indicates their position, they being terminal to the part of the tracheae which have taenidia (Fig. 2), and since no nuclei indicating the presence of a distinct tracheal epithelium is present I have preferred to use the older term.

Emery, and Wielowiejski consider the tracheal cells to be derived from the tracheal epithelium but do not state in what way they are to be considered as being derived. To me it seems most reasonable to consider the tracheal end cell to be a greatly enlarged terminal tracheal epithelial cell which has come to surround the tracheal furcation by virtue of its original position on the tracheal branch. The number of cells making up the tracheal epithelium is very small compared to the number of tracheal end cells of such a dorsi-ventral branch. In many instances it is difficult to be sure whether all the cells, the nuclei of which appear as in (fig. 4, *E*) are actually tracheal end cells, i.e., whether every one of these cells enclose within their cytoplasm the origin of the tracheoles from a tracheal branch (figs. 2 and 8), or whether some of these nuclei represent cells which do not surround any such furcation but are simply placed in between the tracheal end cells. In some species it is more difficult to tell than in others, for the reason that the number of cells making up the cylinder around the trachea is very much greater, e.g., *P. pennsylvanica* and *P. ebriosus*, than where the cylinder is made up of a single layer of cells. In order to make certain that all the cells of the cylinder are tracheal end cells the number of points at which reduction of osmic acid had taken place (90 to 100 more or less) in preparations which showed all the furcations to contain reduced osmic acid were counted and compared with the number of nuclei present. The results (*P. pennsylvanica*) showed a very close agreement in number. In cylinders where a single row of cells in section are present, e.g., *P. sp. near maritimus* and *Photinus sp. (?)* (fig. 7) it is very evident that every cell of the tracheal cylinder is a true tracheal end cell. The tracheae which pass to the ventral side end here in two or more branches and each one of these terminate ultimately in a tracheal end cell and tracheoles. The latter penetrate upward into the lower side of the photogenic cells. In many forms branches from the part of the vertical trachea opposite the line of separation of the two layers pass out between the two layers. These terminate on the dorsal side of the photogenic layer as in (fig. 3, *X*), their tracheoles passing ventrally. Consequently we may have a

single photogenic cell or group of cells which are in section completely surrounded by tracheal end cells. Branching of the large tracheae rarely occurs in the dorsal layer, the formation of branches being almost entirely confined to the part passing through the photogenic layer. I have never found tracheal end cells with the exception of one or two doubtful cases in the dorsal layer nor have I found tracheoles penetrating the dorsal layer in any of the species. This points directly to the fact that the supply of air or oxygen to the dorsal layer has no peculiar significance for the functioning of its cells as is the case with the photogenic layer.

The walls of the tracheae and branches are strengthened by taenidia as in other forms. Erect hairs situated on the inside of the larger tracheal trunks are often seen. I have not found them present in the tracheae of the photogenic layer. Shortly before or at the point where a tracheal branch enters the tracheal end cell its diameter is diminished to about 2μ (fig. 2). In some species this diminution does not take place until the point of origin of the tracheoles is reached. The taenidia disappear at this point leaving a small tube which passes into the cytoplasm of the tracheal end cell. This smooth tube soon divides into two or more branches, the tracheoles, tracheal capillaries of some authors. The point of furcation is always located near the side of the tracheal end cell which is adjacent to the photogenic cell, some times only a very thin layer of cytoplasm remaining between it and the photogenic cell. The nucleus of the tracheal end cell is more proximal than the furcation (figs 2, 7 and 8). The diameter of the tracheole appears to be very nearly the same in all the species, about 1.1μ . Since the tracheoles can only be made to appear by means of the reduction of osmic acid and since the amount of reduction varies (fig. 2) and depends upon several conditions the tracheoles appear to have a greater diameter in some preparations than in others. The diameter varies as nearly as could be determined from 1.1 to 2μ . They are tubular. This could be seen in very thin sections 1μ thick; when light passed through, the cross section of the tracheole appeared as a thick black ring, with a small opening. Their

diameter is not constant throughout but diminishes slightly as they pass into the photogenic cell so that we have a slightly tapering tube.

The tracheoles are easily shown to consist of a firm substance different from the cytoplasm as others have found in the Euro-

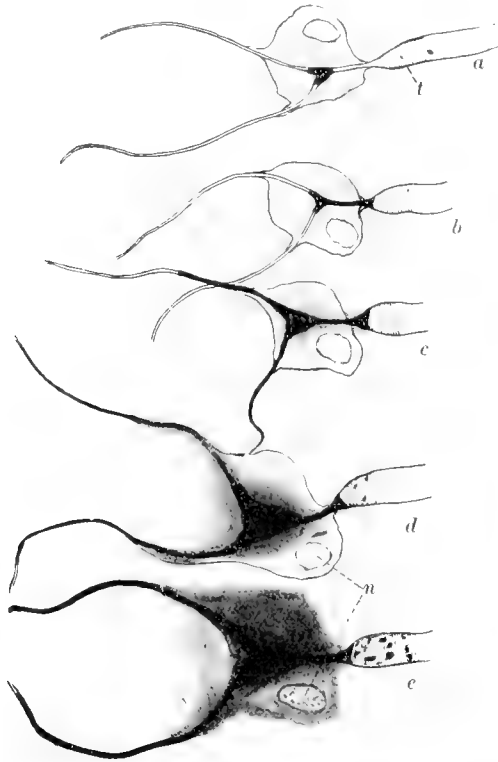

Fig. 2 *a, b, c, d, e*, free hand drawings of tracheal end cell apparatus selected from different preparations showing successive degrees of osmic acid reduction upon the tracheoles, in the cytoplasm and distal end of trachea; *n*, nucleus; *t*, taenidia.

pean forms and Townshend '04 in the American form *P. marginellus*. Tissue treated with a n/s. of NaOH show the tracheoles to remain intact while the cytoplasm of the cells is dissolved away. The structure which remains after treatment with the hydroxide

cannot so far as staining reactions are concerned be distinguished from the substance of the trachea and may in so far be considered of a chitinous nature. That the substance of the tracheole is different from that of the trachea by reason of the fact that osmic acid is reduced upon it is of no significance, for reduction is not always limited to the tracheole.

Weilowiejski and Bongardt ('03) found the number of tracheoles in *L. splendidula* arising from each tracheal end cell to vary, there being sometimes as many as six or seven. Emery found uniformly two present in *Luciola italica*. Townshend found them to vary in number in *Photinus marginellus* though usually two were present. I have found two in the following forms, male *Photuris pennsylvanicus*, *Photinus* sp. near *maritimus*, *P. ebriosus*, *P. ardens* var (?). In females of *Photuris pennsylvanicus* I found three present. In some cases four seemed to be present in females (?) of *P. pennsylvanicus*, but this could not be definitely determined because of the character of the osmic acid reduction in these preparations. In males of *Photuris pennsylvanicus*, *Photinus* sp. near *maritimus*, *P. ebriosus*, and *P. ardens* var (?) the number is constant.

Emery considered the tracheoles to pass between the photogenic cells in *Luciola italica*. Wielowiejski was of the same opinion for *Lampyris splendidula*, though later ('89) he found that sometimes the tracheoles did penetrate into the cells. Bongardt ('03) states that he has not found the tracheoles to enter the photogenic cells in any of the species which he studied. Townshend ('04) states that it is "probable that the tracheoles in their course outside the cylinders" are intercellular, and Watase ('95) also states that they are intercellular. Before we attempt to answer the question as to whether the tracheoles pass into or between the photogenic cells in the species studied we may consider the structure of the photogenic cell.

These are shown in (figs. 3, 4, 7 and 8, *P*). In nearly all the species a cell wall is absent and in some species cell boundaries are missing. Thus the photogenic cells may be considered to be masses of protoplasm in which nuclei are placed, and lying between the cylinders the latter formed by the tracheal end cells,

The only means of distinguishing the structural individuality of the photogenic cell where it does appear is the fact that densely granular deposits in the cytoplasm tend to group themselves about the region of a nucleus (fig. 4), thus leaving narrow radiating areas or strands of cytoplasm which may in some species and apparently under some physiological conditions of the photogenic cells appear as cell boundaries or more rarely as cell walls, consequently they may be spoken of as cells. The nuclei are placed in the central parts of the cells and vary in size and shape. They are larger than the tracheal end cell nuclei. In *Photinus commissus* the nuclei are narrow and appear in rows as Townshend figures for *P. marginellus* (fig. 3). In *P. sp. near maritimus*, for example, they appear rounded and lie end to end forming a chain-like row (fig. 5). The cytoplasm of the photogenic cells are in all cases filled with granules. In *Photinus sp. (?)* (Jamaican) (fig. 7, Z) a peripheral zone of very finely granular cytoplasm appears. The characteristic granules of the interior are missing from this zone. I have found the same but narrower zone present in sections of *Photinus ebrius* and also in some specimens of *P. sp. near maritimus*. Whether it appears as a result of partial exhaustion of the contents in the metabolism of the cell or whether it is a permanent condition I have as yet been unable to determine. The anilin orange G. stain most clearly differentiates the parts of the photogenic cell. Coarse granules appear yellowish orange while the peripheral zone takes a dense blue stain. That these differences in the appearances and relations of the photogenic cells in the different forms is not due to preparation is shown by the fact that they appear the same in sections with different methods of fixation and staining.

To return to the capillaries; in spite of the fact that the above writers with the exception of Wielowiejski ('89) agree that the tracheoles are intercellular in the European forms and the American form studied by Townshend, I have become convinced after examining a great many preparations that the tracheoles are in no case limited to the cell boundaries where such are present. The fact that they do penetrate into the cytoplasm is clearly shown by the fact that cross sections of the tracheoles appear

close to the nuclei of the large photogenic cells in the same focal plane. Furthermore in tissue where no cell boundaries are evident we find them penetrating in all conceivable directions. Thus several osmic acid preparations of the photogenic organ of *P. ebriosus* show the cytoplasm of the photogenic cells penetrated in all directions by an almost innumerable number of tracheoles. Such preparations can not but convince one of the importance of this greatly developed tracheolar net work for the functioning of the photogenic layer.

Observations differ also as to whether or not the tracheoles anastomose. Emery states that they do not anastomose in *Luciola italica*, Wielowiejski found the tracheoles to anastomose in some cases. Bongardt ('03) found no anastomoses. Townshend has figured the anastomoses in *P. marginellus* (figs. 5 and 6). In horizontal sections of *Photinus* sp. (?) (Jamaican) I have found structures like that figured by Townshend in fig. 6. The radiating structures arising from the tracheal end cells are undoubtedly tracheoles. I was however unable to convince myself that anastomoses did occur in this case. In the photogenic organs of *P. ebriosus* the tracheolar network is especially dense and in sections showing strong reduction of osmic acid a great many anastomoses could be plainly seen. I have found no branching of the tracheoles of the photogenic organ in any of the species examined. Anastomoses of tracheoles have been found by Wistinghausen, and Holmgren in certain caterpillars. Wistinghausen and others have found the tracheoles to be made up of a chitinous tube with a 'peritracheal membrane' which is continuous with the cytoplasm of the transition cells (corresponding to the tracheal end cells of photogenic organ). It is readily seen that anastomoses of the tracheoles renders the mechanism of respiration much more efficient due to the possibility of flow of the air through the tracheoles caused by unequal pressure on different parts. Since it is found that the tracheoles do anastomose in those instances where they have been made a special study we should perhaps expect to find them filled with air. But such however appears not to be the case so far as direct observation shows. I separated the organ of *P. pennsylvanica* from

the sternite by means of a very small brush and immediately examined them under the microscope in the dark. The ventral ends of the vertical tracheae appeared as glistening, white, branching structures and were filled with air. No trace of tracheoles could be seen though they occur upon or very near the ventral surface of the photogenic layer, neither could they be seen by means of ordinary light. Thus it would appear that they were filled with liquid. From the fact that the tracheoles are found to anastomose it becomes easier to explain this condition as being a temporary rather than a permanent one for the tracheoles could be more readily freed from the liquid by the unequal pressure caused by the respiratory muscles than they could if the tracheoles ended blindly. Bongardt ('03) found the tracheoles to be surrounded by a continuation of the cytoplasm of the tracheal end cell. Wistinghausen and Holmgren found a peritracheal 'membrane' around the tracheoles continuous with the 'transition cells' of certain caterpillars. I have not found any distinct cytoplasmic membrane surrounding the tracheoles. However when osmic acid becomes reduced the greater the reduction the greater is the outside diameter of the tracheole. Furthermore in teased preparations the cytoplasm appears spread out between the tracheoles in a membrane like fashion and passes out upon them a short distance (fig. 2) and as others have figured. The reduction of the acid occurs around the fork in the cytoplasm of the tracheal end cell and spreads outward until the whole of the tracheal end cell becomes blackened (fig. 2). Now since in such preparations there is always a definite limit to the amount of reduction around the tracheole it would appear that we have a limited region around the chitin tubule which reacts to osmic acid the same as the cytoplasm of the tracheal end cell, and hence is specifically different from the adjacent cytoplasm of the photogenic cell. Thus we may conclude that whatever the function or property of the tracheal end cell may be the thin layer corresponding to the peritracheal membrane of Wistinghausen and others possesses the *same properties as the cytoplasm of the tracheal end cell so far as the osmic acid reaction indicates*. The acid is not reduced in the chitin of the tracheae, neither does the cytoplasm of the

tracheal epithelium of the photogenic organ show this specificity. So that whether we consider the substance of the tracheole to be different from the chitin of the tracheae and endowed with the specific property of reducing osmic acid or whether we consider the reduction due to the specific property of the cytoplasm of the tracheal end cell the fact remains, that the nucleus and clear cytoplasm of the tracheal end cell and also the outer parts of the tracheole have the same property, viz., the power to reduce osmic acid and that *this property is primarily peculiar to the tracheal end cell.*

When the cells of the organ are treated with osmic acid they of course are killed after a short time though the process of photogenesis may go on for some time after immersing the organs. This is undoubtedly due to the characteristic slow penetration of osmic acid, for I found that the light from a solution of the luminous secretion of the ostracods *Cypridinia squamosa*(?), and *Cyclopina gracilis* was instantly extinguished when a small quantity of osmic acid solution was added. It is evident that the osmic acid, reaction is not necessarily due to, and it is believed will be shown not to be dependent upon, the temporary nor continued vitality of the cytoplasm but that it is due to some specific formed substance present in the cytoplasm of the tracheal end cell and the peritracheolar membrane.² To this question we shall return later.

PHYSIOLOGY

As stated above the crystalline deposit in the cytoplasm of the dorsal layer cells may vary in amount. I have found that where the crystals appear in abundance the photogenic cells are shrunken and the region of the tracheal cylinders are large and vacuolated, while in cases where the crystalline deposit is small or not present the photogenic cell groups are plump and the cytoplasm very densely crowded with granules. That this is not due to methods of fixation, staining, etc., is clearly shown by the fact

² It seems to me that the proper term for this membrane should be peritracheolar membrane rather than the misnomer 'peritracheal membrane' since it is peculiar to the tracheole rather than the trachea.

that the same differences appear in material carried through different processes of preparation. In extreme cases the filling of the dorsal layer cells has gone on to such an extent that the cell boundaries have almost disappeared. When the tissue is treated with gold chloride and formic acid the granules appear in the form of large crystals in the dorsal layer. These are either monoaxial or biaxial crystals. The granular deposit in the dorsal layer under normal conditions where only alcohol and xylol have been used in preparation of the sections appears uniformly granular like it appears in fresh tissue. The same is true when osmic acid has been used on such organs. The granules are minute crystals less than 0.5μ in diameter. Their crystalline nature is shown by their high birefringency. They are totally different from the granules of the photogenic cells which are non-crystalline and yield totally different reactions. Bongardt ('03) and Kölliker ('64) found them to be ammonium urate and after adding NaOH ammonia was given off. Others have found them to be 'some salt' of uric acid. When the xanthin test is applied to the isolated tissue, the residue after treatment with concentrated HNO_3 and ammonia vapor shows a reddish purple color. Upon subsequent addition of NaOH however, the color turns deep reddish-brown instead of bluish-violet. The tissue gives the test for guanin under some conditions, with an alkaline solution of diazobenzolsulphonic acid. It would appear from these results that we have here a nitrogenous compound related to if not identical with some of the derivatives from nucleic acid. The interesting point is that we would accordingly have *nitrogen* present, and perhaps phosphorus. This immediately suggests that we should *expect the granules of the photogenic cells to be a nitrogenous compound* since a direct relation exists between the amounts of the granular contents in the layers. Furthermore this direct relation and the actual tracing of the products of decomposition resulting from the process of photogenesis from their place of origin in the photogenic cell into the dorsal layer cells, is shown strikingly and conclusively in sections of the organs of different species (e.g., *P. pennsylvanica*, *P. ebriosus*) prepared by a variety of methods. The photograph (fig. 5) shows a view

of a longitudinal section of the photogenic organ of *P. sp. near maritimus*. The dense white mass is the crystalline deposit in the dorsal layer cells, in this case the cells are completely filled with the minute crystals. Above this mass is shown small amounts of the same product among the viscera of the body cavity. On the ventral side shown under high power in fig. 6 are the same products definitely located on the most peripheral parts of the cytoplasm of the photogenic cells, between the tracheal end cells making up the cylinder and the photogenic cell. It is important to note the exact limits in the location of this crystalline deposit none being found within the cytoplasm of the tracheal end cell nor in any part of the tracheal cylinder. The outlines of the nuclei are shown in (fig 5) appearing in chains, and separate in (fig. 6). They are surrounded by a layer of the same substance. The photographs are from specimens which showed the greatest amount of accumulated products of photogenesis in the organ found in any of the material examined. I have found different amounts of the accumulated products of katabolism in different species and different specimens of the same species, so that we may find organs with only a small amount of deposit on the periphery of the photogenic cell masses with no such deposit upon the surface of the nucleus and in many cases if not in most cases very little if any exists in the photogenic layer. The degree of filling of the dorsal layer cells also corresponds to the amounts of the deposit upon and in the photogenic cells. It is important to note that the region of the nuclei is the last to show the presence of the waste products. This would seem to indicate that the chemical processes that have to do with the formation of this crystalline decomposition product can be traced back to the region of the nucleus. This point becomes more interesting when we compare the results obtained from the investigations by R. S. Lillie ('02) and others on the properties and functions of the cell nucleus in metabolism, with special reference to its oxidative properties. From what follows it will be seen that the foregoing may or may not have to do with the immediate processes of photogenesis, i.e., determine the localization of the origin of the light emissions from the parts of the photogenic

cell. It is to be considered as a condition where the waste product has not been removed from the photogenic cells, but has begun to accumulate. In this condition the organ is still functional and the intensity so far as can be seen with the naked eye is apparently the same. From the facts concerning the relation, in amount, of granular deposit in the dorsal and ventral layers it is evident that we are to consider the granules of the photogenic cells as at least one if not the main source from which the crystalline deposit is derived. Furthermore DuBois states that he observed in the luminous secretion of the centipede, *Orya barbarica*, a direct transformation of the granules of the photogenic secretion into crystals. From this it would appear that Weitlaner ('09) is in error when he concludes (p. 103) that "3. Die harnsauren Ammoniakschöllchen Köllikers [crystalline deposit] haben den Hauptteil am Leuchten, sie sind die Elemente des Leuchtens und man spricht richtiger von Leuchstoff als von Leucht-organen," and in view of the fact that observations by other workers upon the forms which he studied (*Lampyrus splendidula* and *L. noctiluca*) and also as far as observation on other forms go, the dorsal layer is non-photogenic. I have found no traces of light from any parts of the body cavity, and the fact that small amounts of the crystalline substance do occur in the body cavity is of course no evidence for the localization of a process of photogenesis in the body cavity or fat body since the substance is soluble and in part undoubtedly dissolves in the fluids of the body cavity. We are not even justified in concluding that the origin or localization of the light in the photogenic tissue is exactly the parts of the photogenic cells which as shown in (fig 6) contain the crystalline deposit, for observation shows that light is not limited in its origin to the regions where the crystalline deposit appears in the photogenic cell. All we can say is that the places in the photogenic cell where the crystalline deposit appears in preparations, are the points at which *crystallization* takes place or where the cytoplasm becomes most saturated with the decomposition product. It is of vital importance to one's understanding of the processes of cell metabolism that we do not simply

assume simplicity and let this assumption cause us to overlook evident complexity in the processes which go on in the cell.

The granules of the photogenic cell are uniform in size approximately 0.4μ in diameter. In fresh tissue they do not appear to be spherical. The fat globules in the cells of the fat body are from 5 to 15 times larger and perfectly spherical. Thus we see at once a difference between them in some of their physical properties. In some of the literature on the subject when an explanation of the process of photogenesis is attempted it is usually stated that the process is "probably one of oxidation of a substance of fatty nature." This led me to try various microchemical tests for fats and related substances. Osmic acid has usually been regarded as a specific 'stain' for fat. Lately Sudan III and Scharlach R. have been used and considered to be more accurate tests. Osmic acid blackens the globules in the fat body under all conditions, so that it becomes of importance to determine if possible the conditions under which this substance is and is not reduced in the tracheal end cell where no such fat deposit is present but instead a clear cytoplasm. To this we shall return later.

In order to see what the effect would be to feed the insects with Sudan III as has been done by Riddle ('10) in studying the deposition of the yolk layers in the hens egg I fed specimens of the various species and also *Pyrophorus plagiophthalmus* on sugar cane impregnated with Sudan III for five or six days. The animals remained perfectly healthy and active. Such animals became pinkish in color showing that the Sudan III was distributed through the body tissues. Sections showed that the stain had been strongly deposited in the fat globules of the fat cells, the former being stained a deep orange red. A faint pinkish coloration took place in the other tissues, which was very probably due to the presence of the stain in solution in the body fluids. The photogenic layer showed a slightly stronger stain than the other tissues of the body with the exception of the fat globules in the fat cells. But with such a slight coloration it is impossible to tell whether this slightly stronger staining in the photogenic cells than in the body may not have been due to the smaller size and

greater number of granules of the photogenic cells, and hence it is difficult to say whether slightly weaker color was due to smaller degree of specific affinity for the stain than in the case of the fat globules or as simply due to the physical conditions. This at once indicates a difference in the chemical nature of the fat deposit in the fat cells and the granules of the photogenic cells. Since as has been pointed out above and has also been found to be true by others that the waste product from the photogenic cells is a nitrogenous compound, we should expect nitrogen present in the substances used up by the photogenic cell in the processes of photogenesis and since many of the ordinary stains show similar reactions of the globules of the fat cells and the granules of the photogenic cells, they must be considered as having some properties in common. This led me to compare as far as possible the reactions of the nitrogenized fats with the reactions of the granules of the photogenic cells.

Loisel ('03) has studied and compared the staining reactions of neutral fats with those of lecithin by a method which he recommends (q.v.) and has found marked differences in their affinities for many stains. By mordanting with iron-alum, staining for a short time and then dehydrating with acetone, the following results are obtained.

STAIN	PHOTGENIC GRANULES	FAT GLOBULES
Aqueous sol. orange G.	yellowish-orange	not stained
Methyl green.....	bluish-green	pale green
Acid fuchsin.....	deep purple	very pale purple or not stained
Gentian violet.....	deep violet	very faintly violet or not stained
Erythrosin.....	deep crimson	not stained

Also

Phosphomolybdic-haematoxylin (a myelin stain)	dark blue-black	not stained, clear
Sudan III (fed).....	slight or none. ³	deep orange red

³ This agrees with results of Daddi on lecithin and fat. *Archiv, ital. de Biologie*, '96. t. 26, p. 145.

These staining reactions agree with those for lecithin and fat respectively found by Loisel and Daddi. Their differences are so marked in all cases that if the staining reaction is to be regarded as an index to the chemical nature of a tissue substance at all it seems that it must be regarded so in this case. Of course we are not justified in stating that the photogenic cell granules are a lecithin until further conclusive tests can be applied. Yet it is suggestive that a substance, the derivatives from which contain nitrogen so closely resemble the well known lecithins in all the reactions that it has so far been possible to obtain.

Effects of certain chemicals

The dorsal layer of the photogenic organ shows a strongly acid reaction while the photogenic layer has a slightly weaker acid reaction. This was tried several times by removing the two layers from the transparent chitin and then turning the respective layers down upon the litmus paper and comparing the resulting colors. Heineman also found the tissues of the organ of *Pyrophorus* to have an acid reaction. This of course would not necessitate that the photogenic process take place in an acid medium, for it is well known that different parts of the same cell and the same parts of a cell at different times may give different reactions as regards acidity and alkalinity. Watase ('95, p. 115) reasoning from analogy to certain other photogenic processes which do occur in alkaline media, states that here the process also takes place in an alkaline medium. However, so far, all the evidence we have, rests only upon analogy. Kastle and McDermott ('10) have repeated and added a large number of experiments on the effects of chemicals on the light production of the organs of *P. pyralis*. The results of these authors and many others show conclusively that oxygen is a necessary element for the process of photogenesis. *This statement may not be the same as saying that the process is one of simple oxidation.* I have found a strong solution of hydrogen peroxide to have a most striking effect of increasing the light intensity. The following are notes from one experiment :

(A) 1. The organ of a ♂ *P. pennsylvanica* was isolated intact and inverted on a slide. One to two drops of strong H_2O_2 was added.

Result: A strong constant light appeared and oxygen was evolved.

2. The viscera of the body cavity were then treated with H_2O_2

Result: No light but evolution of oxygen.

(B) 2. A second organ was isolated in the same way and placed on the slide dorsal layer up then H_2O_2 added.

Result: Bright, strong, constant light appeared. The dorsal layer was opaque to light. When one of these brightly glowing organs were placed in the tube and bulb apparatus (see p. 443) and pressure increased a slight increase in intensity of the light could be noted although the organs were apparently at their upper limit of normal intensity. When left moistened with H_2O_2 in the air they remained brightly luminous for two hours. The results of this experiment and from the results found by Kastle and McDermott ('10), Bongardt ('03) and others that in pure oxygen the light is more intense than under conditions where oxygen is diluted as in air, show at once that a direct relation exists between the intensity of the light and the oxygen content or pressure. Kastle and McDermott and other previous writers have shown that water is a necessary condition for the existence of the light and that by drying the tissue of the organs after long periods (thirteen months in one case, Kastle and McDermott) light may be emitted from the substance upon admittance of water and oxygen. These and other writers have further found that by repeated drying and moistening with the admission of oxygen the process of photogenesis ceases after a time indicating that the photogenic process is a result of a direct utilization of material. This is of course in perfect agreement with the results reported above on the origin of the nitrogenous waste product in the dorsal layer, and the diminution in the cell contents of the photogenic cells. From a study of the dried photogenic material we at once see as others have long ago pointed out that the immediate process of light production is not dependent upon the protoplasm of the cell but upon interactions between formed substances.

Observations on the localization of the photogenic process in the organs

While collecting at night I found that certain Jamaican species normally emit the light in a regular way, e.g., *Photinus* sp. (?) (a small yellow form),⁴ emits what appears to be a long sharp flash lasting from 2 to 2½ seconds when seen at a distance of a few rods. This flash when examined more closely is seen to consist of a number of smaller flashes caused by regular, rapid and numerous changes in intensity. In some other species, e.g., *P. sp. near maritimus* the flash is similarly made up of a series of rapid changes in intensity but not as uniform and definite as in the above mentioned form. *Photinus ebriosus* shows a strong uniform flash. These species may readily be recognized by the character of their flash. A further study would undoubtedly enable one to distinguish other forms by this means. Similar observations have been made upon some of the American Lampyridae by McDermott ('10).⁵

Max Schultze ('64-'65) from his study of the reduction of osmic acid in the tracheal end cell suggested that the process of light production took place in these cells. Emery ('84) was the first to make a study of the localization of the light in the photogenic layer. He found that the light in *Luciola italica* was localized in *rings* which were constant in position but sometimes were broken up into luminous points and since he found the reduced osmic acid in the forks to be located here and in the tracheoles he was of the opinion that the region where the photogenic process took place was where the osmic acid was reduced.

I have studied *Photuris pennsylvanicus*, *Photinus ebriosus*, *P. pallens*, *P. sp. near maritimus*, and others. When the organs are at the height of their intensity and when the light is not intense enough it is impossible to see anything with the compound microscope in the dark. But when the organs show a medium intensity the surface of the organ and the removed tissue can easily be studied. A view (fig. 9) under the high power, of the organs

⁴ Unfortunately this form could not be identified for me.

⁵ Can. Ento., vol. 42, pp. 357-363.

of, e g., *P. sp.* near *maritimus* shows the surface of the photogenic layer to be made up of a number of shaded, oval or round spots distributed uniformly in a brightly luminous field. This generally occurs when the animal is under constant mechanical stimulation such as very slight pressure or when the organ is removed and then stimulated. To identify these shaded areas camera lucida drawings were made of the active organ and then horizontal sections cut and compared. These showed that the shaded areas (fig 9, *S*) corresponded exactly to the cross sections of the vertical cylinders and the bright areas between them to the photogenic cells as in (fig. 4). Thus from direct observation we are readily able to locate the origin of the light in the cytoplasmic region of the photogenic cells. In certain favorably lighted regions on the organs, the yellowish green light is most intense in the region which would correspond approximately to the inner region of the zone bounding the photogenic cells (figs. 7, *Z* and 9, *P*). This zone is narrow in most forms and almost absent in some so that as far as could be determined the periphery of the photogenic cell shows under these conditions the greatest intensity. It must be noted here however, that in many cases sections show that the tracheal end cells lie in depressions in the cytoplasm of the photogenic cells as is shown in an extreme case in (fig. 8) so that we should expect to have a more or less indefinite bright zone about the vertical cylinder if the light is located in some definite part of this region. The nuclei of the photogenic cells appeared in bead-like rows in some places. The intensity of the light was no greater in the region around the nucleus where the crystalline deposit appears than in the other regions of the cytoplasm, thus the place where the waste products originate can not be considered to be limited to the places where they crystallize out for we must assume that the nitrogenous waste product is at least partially formed at the points of origin of the light. Under some conditions, often when the tissue of the organ is injured, the light proceeds from certain angular small spots in the form of an intense bright flash. This may occur a great many times at regular or irregular intervals. The angular spots are always constant in position and shape but the intensity of the flash may vary.

I attempted to see if there was any regular distribution of them but none such could be made out definitely. During the emission of the flashes from these points clouds of diffused light originating from the deeper parts of the photogenic layer often passed over the organ. These generally proceeded from areas similar if not identical in outline and constant in position. The organs in this condition of activity appear very much like the view one may obtain in the spinthariscopes. When the same organ was stimulated the total light content increased greatly the characteristic shaded areas with the light regions between them reappeared, changing the general view of the field. Thus there appears to be two modes of photogenic activity of the organ which show that the mutual relation of the factors which make the photogenic process possible *is not a constant and fixed one in all respects but that through some variation in these relations we may have the location where the photogenic reaction takes place limited to certain special regions under some conditions while under other conditions the localization may be extended in area.* This is a 'spreading' of the process and a result of increased stimulus.

Structurally it is impossible to refer these angular points which are constant in position to anything except the region of the forks of the tracheoles in the very distal part of the tracheal end cell, as Emery did. The fact that those points which were visible, were placed irregularly is very likely due to the distribution of those forks which are at the ends of the branches of the vertical tracheae on the ventral surface for here the forks are scattered irregularly over the ventral surface of the photogenic layer (fig. 3). The fact that the greatest intensity of the light when such that the organ can be examined is located on the periphery of the photogenic cell would indicate as Emery also found that the primary liberation of light energy is from the region where the forks surrounded by their thin layer of tracheal end cell cytoplasm are imbedded in (fig. 8) or applied to (figs 4 and 7) the cytoplasm of the photogenic cell. When we consider this to be the case the fact that upon increased stimulation, the cytoplasm of the photogenic cell appears to be the origin of the light, becomes easily explainable for through this we have innu-

merable tracheoles passing, and if the photogenic process took place around them the cytoplasm would be uniformly illumined as is found to be the case. On the other hand if we assume the photogenic process to actually take place uniformly throughout the cytoplasm of the photogenic cell we would have to find an explanation for the bright angular points in the less stimulated state of the organ. The tracheal end cells are not luminous and the fact that the cylinders are not totally dark is due to diffusion of light into them from the photogenic cell regions. For if we are to attribute any degree of luminosity to them (i.e., the small amount which they show) we should expect them to be brightly luminous, which is not the case. Now since these cells are not luminous and the peritracheal membrane around the tracheoles is blackened in the same way as the tracheal end cell we have no reason to believe that light production is localized in this membrane and not in the cytoplasm. On the contrary we should expect that the process of light production really takes place in the cytoplasm of the photogenic cell and very close to the contact surfaces between the tracheal end, and photogenic cells of the organ. *This leads us farther to localize the angular spots in the cytoplasm of the photogenic cell immediately adjacent to the forks and tracheoles, for here we evidently have the greatest amount of reaction* because of the presence of the fork and body of the tracheal end cell at this point. This agrees with all the facts from observation. The same explanation was arrived at from a detailed study of the osmic acid reaction before the above study of the active organs had been made. Finally when we come to consider the control of the organ the above conclusion would seem to be more in accord with the facts.

Effects of rapid changes in pressure upon the organ

DuBois ('86) found that under diminished air pressure the light became weaker in *Pyrophorus* and at six hundred atmospheres the organs were intensely active. Evidently changes in air pressure in the tracheae normally vary only between narrow limits and if these changes have anything to do with the control of the organ we should expect to be able to affect the action of

the organ by rapidly changing the air pressure in the tracheae of the body and photogenic organ. In order to approach this condition as nearly as possible a strong rubber bulb of 50 cc. capacity was fitted to one end of a heavy rubber tube at the other end of which was fitted a 2 dram vial. The specimen was then placed in this vial and a plug of slightly moistened cotton wool was inserted so as to keep the animal in the tube. The following are the notes taken in one experiment from among many on different forms.

Photurus pennsylvanica ♂. (a). The actively flashing animal placed in the vial and pressure applied with the hand.

Result: Flashes normally bright and strong when under atmospheric pressure. Increase of pressure increased intensity of flash temporarily.

(b). I then cut off the abdomen from the same individual. Light became totally extinguished. On placing it in the vial, no light was produced at atmospheric pressure. I pressed the bulb and as the pressure was increased light appeared more intense in proportion to increase in pressure. An intense flash could be produced in this way though not quite as intense as that of the normal animal. Flashes were produced at will, at intervals, for twenty-five minutes. Only a very slight diminution in the intensity of the light at the end of twenty-five minutes was noted.

(c). I then isolated the organ from the same individual completely from all other tissue and placed it in the vial. A faint constant light was evident. I increased pressure and increase in light intensity in the whole organ took place. This could be repeated again and again, an intense flash being produced at will.

(d). I then cut the same isolated organs into halves longitudinally. Effects of increase in pressure on halves was the same as in (c).

(e). I removed photogenic layer from one-half of the organ in (d) and placed the tissue in the tube. A *weak* constant light was given off due very likely to stimulation of tissue. Increase of pressure gave same results as in (c) and (d). After a short time the tissue lost its power of response and light soon became extinguished.

It will be noted that in this experiment the increase of pressure on the exterior was presumably the same as in the interior of the tracheal tubes so that the only apparent effect was to produce increased partial pressures of the oxygen and other constituents of the air. Continued constant pressure produced corresponding constant intensity. The conditions are not the same as when contraction of the abdominal muscles takes place while the spiracles are closed, yet increase in concentration of oxygen is brought about in the tracheal tubes assuming that a free flow of air into the tubes takes place. Of this there can be no doubt, for the tracheae are kept distended by the taenidia. Thus it seems that the only explanation of these experimental facts, providing increase of pressure does not mechanically or otherwise stimulate the photogenic tissue, is that this increase in intensity is directly due to the increase in oxygen content in the photogenic tissues for as has been shown by Kastle and McDermott, and others, the intensity of the light is greater where the oxygen content is higher. It will be noted that these results are obtained where the total pressure is constant. Now when the pressures are lowered by means of suction on the rubber tube the opposite, when any, are produced, viz., the intensity of the light is decreased with decrease of pressure and often may be temporarily extinguished. The same results from experiments with low pressures have been obtained by DuBois for *Pyrophorus*. In order to eliminate the possibility that the increase in pressure is a stimulus upon the cells in a mechanical sense I need only cite the experiments of Bongardt ('03, p. 31). He took fresh and dried photogenic tissue of *L. noctiluca* (the former responded to stimuli but the dried tissue could not be made to respond under any conditions) placed them in a glass tube and slightly moistened the dried tissue which became luminous. Then the pressure in the tube was decreased to 10 mm. of mercury. After $2\frac{1}{2}$ minutes the light totally disappeared in both the moistened and fresh tissues. When air was again admitted (equivalent to increase in pressure or oxygen content) both the moistened and fresh tissue became intensely luminous. This leads us to the question of the

Control of the organ

There have been three main theories concerning the control of the photogenic process. First, the theory of DuBois, which holds that the respiratory processes are only related to the control of the organ in so far as they serve to supply the necessary amount of oxygen in the same capacity as to the other tissues of the body. In other words that the respiratory muscular mechanism does not determine when a flash shall or shall not take place. DuBois ('96) considered the control to be nervous in so far as the nervous system controlled the action of the muscles which are related to the photogenic organs; and that by contraction and relaxation of these muscles *blood* is made to flow 'through passages'⁶ in the organ. By this means of the control of the blood flow he explains "why sensorial or psychic stimuli may affect the production of light" (p. 420). He notes however that the 'photogenic cells' are 'directly excitable.'

The second theory is that of Heineman ('86) and Watase ('95) who hold that the control is by the respiratory muscular mechanism causing the inflow of air to the photogenic tissue. Heineman's theory rests upon the fact that he found muscles passing over the surface of the abdominal organ of *Pyrophorus* under which passed large tracheal tubes penetrating into the photogenic tissue. When he blew through a tube which was inserted into the large 'prothoracic spiracle' (?) the light from the organs increased in intensity. This he considers an 'experimentum crucis' supporting his theory of control. The third one is that the organs are under direct nerve control. Max Schultze ('64) considered it probable that nerves connect with the tracheal end cells. Bongardt ('03) figures and states that he found nerve fibers passing along the vertical tracheae and finally ending in the tracheal end cells of *L. splendidula*. If such nerves do exist in the organ, it becomes of vital importance in view of the results from the experiments with pressure, to see if their presence can be demon-

⁶ These 'passages' which DuBois erroneously figured and considered blood spaces in *L. noctiluca* are of course nothing but the regions of the vertical cylinders and tracheae which sometimes do not stain readily and thus appear as if spaces are present when actually no such spaces exist, as Bongardt and others have shown.

strated by a physiological method and if so what part they play in the process of photogeny in the Lampyridae. If we do find such a control we will have found nothing new so far as photogenic organs in many other forms are concerned, for instance in the photogenic Pennatulidae, Panceri noted the passage of the wave of light over the colony of polyps, serving as an index of the fact that the passage of a nervous impulse precedes the production of light. As to whether the result of this impulse partakes of the nature of a contraction in the photogenic cell we shall speak presently. Here we are particularly concerned with the question as to whether the *nerve impulse* ends directly in the photogenic tissue, and if so where it ends, or whether it ends in the parts of a mechanism which is external to the photogenic tissue, such as the muscles of the body.

First of all it must be noted that the respiratory movements of the abdomen do not at all follow or correspond to the flashes emitted from the organ. Hence the simple respiratory movements do not account for the periodic emission of the light. In trying to carry out the idea of the compressibility of the volume of air and its translation in the tracheae of the photogenic organ I made repeated efforts to see if any minute movements of the tergae or other parts could be seen in the animal emitting flashes of light under a binocular. No trace of such movement could be found. Hence if such a thing as control of the light flashes consists in a muscular mechanism its action has no visible external effects of contraction. So far as DuBois' theory of control by means of blood flow is concerned, we would have to place the same limitations upon the mechanism, i.e., action without any visible external movements of parts, as in the theory of control by respiration, for DuBois suggests the dorso-ventral muscles as being at least part of the mechanism. It might however, very easily be the case that by the contraction of the heart, etc., we would be able to get some sort of a rhythmical flow of blood through the organ if the spaces did exist as he supposed. The results of the following experiment show I believe, that both of these theories do not account for the essential observed fact that the flashes are at irregular intervals, are *sharply defined* and that we must inevitably admit the existence of a specific and direct control of the nervous

system over the photogenic organ from a physiological standpoint. The notes taken from only two out of several similar experiments are reported here.

Experiment I. (a). I made a ventral incision in a fresh active specimen on the segment anterior to the organ in order to cut the nerve cord.

Effect: The organ remained dark. No spontaneous flashes emitted though the animal was active being able to run and fly, brush its antennae, etc. Mechanical stimulation caused a weak light to appear at the point stimulated.

(b). A second specimen gave the same results except that a very faint constant light appeared and remained. Shaking the animal and otherwise stimulating it without stimulating the organ directly gave no flash.

Experiment II. (a). I laid open an active male *Photuris pennsylvanicus* by cutting along the sides of the posterior three segments, leaving the terga attached anterior and posterior.

Effect: The flashes were strong and normally controlled as in fresh specimen.

(b). Then I raised and removed the connected tergae from behind, also removed the viscera overlying the organ with a small brush thereby exposing the whole dorsal surface of the organ without injuring the nearby dorsal layer or anything laying applied close to it.

Effect: Flashes normal, under complete control and not noticeably different from fresh specimen.

(c). Then I made an incision anterior to the organ and close to it

Effect: Light became extinguished except at points where it apparently had been injured by manipulation and then only showed weak and constant light at these points. Control absolutely lost. Mechanical stimulation of the isolated organ caused light to appear at point stimulated. This isolated organ when placed in the tube and bulb apparatus responded to increases and decreases in pressure by a marked increase in the intensity of the light over nearly the whole organ.

In (c) of Experiment 2 the blood flow if any was present must have been interfered with. The dorso-ventral muscles were torn.

The terga carrying the spiracles and valves were removed, and yet the flashes were normal and spontaneous and under perfect control. It must be noted that the last nerve ganglion, nerves and nerve chain were not dislocated in this experiment. Another fact of almost equal importance is that the photogenic tissue, apart from the nerve chain and other tissue, is highly irritable and responds locally to stimuli. Where is the muscular mechanism for such a response in this case?

Effects of temperature

Mangold ('10) has summarized the results of experiments by others on the effects of different temperatures upon photogeny (p. 345). No uniform results have been obtained among different observers. But from those which have been obtained it is clearly seen that there are optimum and maximum temperatures for the process. I have found from a number of experiments that with live animals or removed abdomens placed in a vial into which a thermometer was fitted and the whole immersed in water at 90° to 98° C. the temperature at which the light was extinguished varied in the case of *Photuris pennsylvanica* between 45° and 54° C. There was greatest intensity at about 40° C. *Photinus* sp. near *maritimus* gave results varying from 47° to 55° C. The specimens of this species were immersed with forceps directly into water the temperature of which was registered by a thermometer. With this species the temperature could be raised considerably above the point at which light became extinguished and the light revived. This was noted again and again. The *maximum temperature* from which the light was revived was found to be about 84° C. The light reappearing at temperatures around 50° C. In all cases where the whole animal was used it died at about 40° to 45° C. and all control of the light was lost, so that in *P. sp.* near *maritimus* the light was always continuous after the specimen had been heated above a temperature of 40° to 45° C. In raising the temperature the light in *P. sp.* near *maritimus* was always found to pass from the characteristic greenish yellow to a yellowish, thence to yellowish orange and finally to orange and sometimes into a reddish orange color before

it became extinguished, the rapidity of these changes depending upon the temperature of the water. The higher the temperature the more rapid the changes and hence at high temperatures the color would seem to change directly into orange before the light became extinguished. At lower temperatures of the water (50° to 60° C.) the transition in colors was gradual. Traces of this same change in color was noted in *Photuris pennsylvanica* and *Photinus ebrius*. When the organs were cooled and the light reappeared (*P. sp. near maritimus*) the transition in color of the light was in the reverse order, i.e., orange to yellowish and thence to greenish yellow. This sequence in color changes becomes more interesting when we compare them with color changes reported to occur in certain marine photogenic organisms.

These experiments upon the live animal and the severed abdomen are obviously ill adapted to tell us definitely at what temperature the particular chemical process between the formed substances which results in light takes place, for we have to take into account the control and subsequent loss of control of the organ, also the removal of the necessary supply of air or oxygen to the organs and the formed substances concerned, upon the death of the animal. There may also be other effects of temperature which have nothing to do with the essential process of photogeny itself but which indirectly determine whether it shall or shall not take place. Yet certain facts stand out: (1), *that the process of photogeny is prevented from taking place at some temperature*; (2), *that it may be continued if the material is not heated above a critical temperature which prevents the possibility of further action when the temperature is afterward lowered.*

With the purpose of finding if possible whether the essential chemical process concerned in photogeny is affected by certain definite temperatures I performed a series of experiments upon the luminous secretion of *Cypridina squamosa* (sp.?) and *Cyclopina gracilis*⁷, two luminous salt water ostracods found upon the bottom in shallow water at Montego Bay. The solutions were made with pure filtered rain water, no distilled water being available at the time. Solutions with sea water were also tried in

⁷ Miss Mary J. Rathbun has had these and some other forms identified for me and I wish here to express my thanks.

other experiments. No noticeable differences in the results was found.⁸ Three or four of the ostracods were squeezed with a pair of forceps in the test-tube containing the rain water, thus causing in many cases a copious, intensely luminous greenish yellow secretion to be freed in the water. When this was shaken a homogeneous luminous solution was obtained. The thermometer was hung in the luminous solution in the test-tube and the latter was immersed in a beaker of water kept at from 90° to 98° C. The alcohol lamp was enclosed in a hood so that no light from this source disturbed the observations. The following are the tabulated notes on the results of one series of experiments upon the luminous secretion in a solution of rain water after the temperature effects had been noted in a general way by a preceding series of trials.

IMMERSION	SOLUTION IN FILTERED RAIN WATER	RAISED TO	RESULT
		<i>degrees</i>	
Same solution	first	A	60 C. Recovered to a bright luminescence upon cooling
	second	B	65 Recovered to a bright luminescence upon cooling
		B'	65 Showed only a very slight recovery of luminescence upon cooling
Same solution	first	C	67 Recovered to a less degree than solution B' at 65° C.
	second	C'	67 Did not recover
Same solution	first	D	70 Recovered <i>very</i> faintly
	second	D'	70 Did not recover
		E	71 Did not recover
		F	70 Did not recover until after one minute and then very faintly
		G	71 Did not recover
			Solutions raised to temperatures above 70° to 71° C. never recovered their photogenic power.

⁸ Thus there would seem to be no inherent reason so far as the essentials of the chemical process are concerned why photogenic organisms should not be found in fresh water, as is the case. Perhaps the photogenic function is to be considered a primitive one so far as phylogeny is concerned.

In all these experiments light disappeared at 50° C. and light reappeared again at 50° C. The latter was determined with solutions raised to 51°, 52° and 53° C., and then allowed to cool, for when the solutions were raised to 60° or 65° C. and higher, the temperature at which visible reappearance of the light took place was not so well defined and sharp, because of the low intensity and hence it was difficult to determine the exact temperature at which the process began again. The time rate of return of the light depends upon the time it takes for a solution to be lowered to the temperature where light reappears, for quick cooling caused a quick return of the light.⁹ Thus we see that here we have a luminous secretion which when isolated yields definite results while with the photogenic organs of the Lampyridae it is more difficult to determine the exact temperatures, very probably for the reasons given above. The important thing is that they show exactly similar behavior toward temperatures.

Since the specific effect of temperature is one of the chief criteria for showing the existence of enzymes these results have led me to study further the osmic acid reaction in the tracheal end cells of the Lampyridae. If the reduction of osmic acid on the tracheoles and in the tracheal end cells depends upon the existence of a specific enzyme then when the tissues of the organ are heated above the temperature at which the enzyme is destroyed and then treated with osmic acid we should presumably obtain no reduction of the acid in the structures where the enzyme is located. *If this is the case we shall have found an explanation for the reduction of osmic acid in these cells.*

The following are the summaries of results from six experiments to test the effect of temperature upon the photogenic tissue with regard to subsequent reduction of osmic acid in the tracheoles and the tracheal end cells. All the experiments except Experiment 5 had controls; the latter passed through the same

⁹ In these experiments where intensity of light was noted the results depend upon the visual sense of the observer. No apparatus for measuring the intensity and point of disappearance of the light was at hand. But precautions were taken to make all the observations in a perfectly dark night and against a black background.

processes except that of being heated. Sections were cut and mounted, some stained and others unstained.

Experiment 1. Sixteen specimens of *Photinus* sp. near *maritimus* were taken.

(a). Control. From eight specimens I removed the abdomen and placed them directly into 0.5 per cent osmic acid.

(b). Eight whole specimens were immersed in water at 98° C. for one minute. The abdomens then cut off and placed in a 0.5 per cent solution of (OsO_4) osmic acid thirteen hours (same length of time as in (a).)

Result: (a). Reduction took place either in whole or greater part of organ in all the eight specimens.

(b). No reduction of OsO_4 took place in any of the tracheoles of the boiled specimens.

Experiment 2. Twelve specimens of *P. ardens* var.? were taken.

(a). Control. Abdomens of six placed in 0.5 per cent OsO_4 ; three of these were cut and mounted.

(b). Six were placed in water at 99° C. *in a dry vial* for about one minute. Then abdomens cut off and placed in the OsO_4 solution.

Result: (a). In the three that were cut the tracheoles showed strong reduction.

(b). No trace of reduction of OsO_4 in any of the tracheoles of the six specimens.

Experiment 3. Four specimens of *Photuris pennsylvanica* were taken.

(a). Control. Abdomens of two immersed in OsO_4 .

(b). Two immersed in boiling water one minute; abdomen cut off and placed in 0.5 per cent OsO_4 thirty-six hours (same as (a)).

Result: (a). Strong reduction in tracheoles and tracheal end cells.

(b). No reduction in tracheoles and tracheal end cells.

Experiment 4. Twelve specimens of *P. sp.* near *maritimus* were taken.

(a). Control. Six were placed in OsO_4 directly and left in same time as (b).

(b). Six were placed in water at 80°C . for three to four minutes then into OsO_4 .

Result: (a). Showed strong reduction in most of the specimens, and slightly less in one or two. All showed reduction.

(b). Three showed no reduction in tracheoles, while three showed traces of reduction.

Experiment 5. Two specimens of *P. pennsylvanica* were immersed in water at $71\frac{1}{2}^\circ \text{C}$. until light became yellow, then orange and was finally extinguished. The light did not return upon cooling. The abdomens were removed and placed in the OsO_4 solution. No control.

Result: Strong reduction took place in the tracheoles and tracheal end cells.

Experiment 6. Twelve specimens of *P. sp.* near *maritimus* were taken.

(a). Control. Abdomens of six placed in OsO_4 .

(b). Six placed in water at 60°C . (several minutes). Some regenerated light slightly after immersing in the OsO_4 . All passed through yellow then orange when immersed in the water at 60° .

Result: Reduction took place more or less in tracheoles of all specimens in both (a) and (b).¹⁰

From a study of the results of these experiments with temperature upon the intact organ, the luminous secretion and the effect of temperature upon the osmic acid reaction, it may at once be asked; is the reduction of osmic acid in the tracheal end cells

¹⁰ Bongardt ('03, p. 11) states that he succeeded in staining the tracheoles black by "fixing the tissue in alcohol or sublimate-acetic, staining in borax carmine, decolorizing in acid alcohol washing in water twenty-four hours, placing in solution of 1:400 OsO_4 over night then into strong acetic eight to ten hours, washed in distilled water, hardened in alcohol embedded and cut." Another method is also mentioned using gold chloride, which is more complex. From such treatment of the tissue it is obviously difficult to learn anything about the nature and wherefore of the reduction, which in such a method may be due to entirely different causes.

and tracheoles dependent upon the vitality of the protoplasm of the tracheal end cell or is it only dependent upon the existence of the formed substances which by themselves, as has been shown by drying the organs, are able to produce the phenomenon of photogenesis? With this comes the question, did the temperatures below that at which osmic acid reduction is prevented from taking place kill the protoplasm of the photogenic cells? An answer to the latter will furnish an answer to the former question. The animals are very sensitive to higher temperatures and dryness. In all the temperature experiments upon the whole animal the specimen always died at about 45° to 50° C. if left in for as long a time as one minute. Control of organ was lost though very often a residual glow, sometimes quite strong, remained after cooling if it had not been heated to temperatures which permanently prevented the continuance of the light. It will be noted that strong reduction took place even as high as $71\frac{1}{2}^{\circ}$ C. and that traces of reduction were evident in Experiment 4, where the organs had been heated to 80° C. for three to four minutes. Further it is important to note that the reduction of the acid does not depend upon the *continuance* of the process of photogenesis while the acid is penetrating into the photogenic layer as is plainly shown in the reported experiments (4 and 5). Therefore *all* the conditions which are necessary for the process of photogenesis are not necessary for the osmic acid reduction in the tracheal end cell, it is only necessary that the organs be not heated above a certain temperature.

It is of course impossible to prove that the protoplasm of the cells of the photogenic organ was killed at $71\frac{1}{2}^{\circ}$ or 80° C. as in Experiment 4. Another important fact to be remembered however is that osmic acid is itself a strong killing and fixing agent. The longer the time that the organs are left in the solution the more extensive (within certain limits) is the osmic acid reduction in the tracheal end cell (fig. 2) now if a small amount of reduction has taken place around the furcation then evidently we must have had the penetration of the acid to the tracheal end cell and this it seems would be efficient in destroying its vitality. If then the first traces of the acid are sufficient and the time long enough

for the killing of the cytoplasm then the further reduction of the osmic acid can not have been due to the vitality of the cytoplasm but to some substance in the cytoplasm which by itself is able to reduce osmic acid. The temperatures at which the possibility of return to the conditions necessary for photogenesis becomes permanently destroyed in the Lampyridae, viz., 70° to 84° C., corresponds in general to the temperature which destroys the possibility of the osmic acid reduction in the tracheal end cell to take place. When tincture of guaiacum is applied to the tissue of the photogenic layer it does not turn blue, neither does it turn blue when hydrogen peroxide is added though the hydrogen peroxide is decomposed. The power of decomposition of hydrogen peroxide is not limited to the photogenic organs but *any* of the body parts when placed in this reagent decompose it showing the presence of a 'catalase.' I immersed specimens for one minute in boiling water and tested parts of the body with hydrogen peroxide. No decomposition took place showing that the 'catalase' was destroyed. In view of these reactions of osmic acid we may consider it certain that the normal reduction in fresh photogenic tissue is due to the presence of some substance *probably* of the nature of a reductase which is formed in the cytoplasm of the tracheal end cell and peritracheolar membrane.

USE OF THE ORGANS

Apart from the problems concerning the chemical-physiological mechanism of the luminous organs of the Lampyridae, Elateridae and numerous other forms, is the significance and ultimate use of these organs to their possessors.

Osten-Sacken ('61) states that he found males of *Photinus pyralis* while themselves emitting flashes of light, to respond positively to the light from the females, and that a short time thereafter he found them copulating. Emery ('86) also found the males to respond to the females in the same manner though he did not observe a subsequent copulation.¹¹ It is a matter of

¹¹ Recently McDermott writes me that he "has very definitely confirmed" Osten-Sacken's observations for *Photinus pyralis*, and extended them to *P. consanguineus* and *P. scintillans*.

common knowledge to people of regions of the tropics where *Pyrophorus* abounds, that it responds under certain conditions to ordinary artificial light stimuli. I have collected *P. plagiophthalmus* by means of a small partly enclosed incandescent light and by means of it have found them to react strongly at distances of fifty yards or more. During this reaction all their photogenic organs are in full activity.

Comparison of the eyes and the photogenic organs in those species of Lampyridae where both males and females were obtained, showed. (a) That in all males, and to a smaller extent in those species, the females of which are most active and abundant, the eyes are greatly developed. (b) That in all cases the eyes and at the same time the photogenic organs of the males are larger than the corresponding organs of the female, i.e., the extent of development of the eyes is in direct relation to the extent of development of the photogenic organs and activity. In one large female (unidentified) which I found on the ground among some grass the organ was exceedingly small, the eyes were very much reduced in size and added to the above shortcomings the wings were rudimentary. The photogenic organ, however was very active and well controlled giving off a strong greenish yellow light. This becomes of further interest when we note that there exists a direct relation between the head ganglia and the control of the photogenic organs. When the head is removed from specimens control of the light is interfered with or lost and the spontaneity of the flashes is also lost. Removed abdomens which contain the last abdominal ganglion show no spontaneous control, usually the organs give off a continuous or irregular glow or else light disappears though they respond to mechanical and some other kinds of stimuli.

A syllid, probably *Odontosyllis pachydonta* Verril, during certain periods, reacted to each other and to an artificial light stimulus in a most striking manner. The eyes of this syllid are unusually developed. In one case a female—one of the syllidae—filled with eggs was taken while brilliantly luminous, and some of the eggs, which were shed readily, were fertilized with sperm taken from individuals caught in the tow net in the same place

and at the same time. The next morning these had developed into late cleavage stages. Galloway and Welch ('11) have found by direct observation that the positive response of the male and female of *Odontosyllis oenopla* to each other results in the bringing together of the eggs and sperm in the water so that here we have one of the first well established instances of the sexual adjunct significance of photogenicity in organisms.

SUMMARY

1. No fundamental structural difference exists in the photogenic organs of the species of Lampyridae studied. The elementary photogenic mechanisms of which the organs are made up, viz., the trachea, tracheoles, tracheal end and photogenic cell with their relation to the nervous system, taken collectively, are the same in all the forms.

2. The tracheoles are tubular and have been shown to anastomose in *Photinus ebrius*. They are made up of a chitinous substance, which is more resistant than the protoplasm to reagents. Their number, where it could be definitely determined has been found to be constant for each tracheal end cell. The tracheoles are in no case limited in their course to the outside of the photogenic cells but penetrate into the cytoplasm of the latter. They are apparently filled with a liquid under such conditions as make observation of them possible.

3. No distinct cytoplasmic membrane around the tracheoles could be demonstrated yet the reactions to osmic acid shows that a limited region about the tracheoles has the same specific property of reducing the acid as the cytoplasm of the tracheal end cell.

4. The reduction of osmic acid upon the tracheoles and in the cytoplasm of the tracheal end cell is dependent upon the presence of a substance probably of the nature of a reductase which shows the same properties as regards the effects of temperatures upon it as enzymes in general. The process of photogenesis is dependent upon the presence of this substance as is shown by the parallel effect of temperature upon the production of light.

5. The process of photogenesis is independent of the vitality of the cytoplasm and is a resultant of the interactions of formed substances in the presence of water and oxygen. It is highly probable that it partakes of the nature of an oxidation but this has yet not been demonstrated for the photogenic process in the Lampyridae if in any animal.

6. It has been shown that photogenesis is incident upon the utilization of a nitrogenous compound—the photogenic granules—giving staining reactions like those of lecithin and different from those of the true fats, and that this nitrogenous compound appears at least in part at the end of the process in the form of a nitrogenous waste product. This crystalline substance appears from its reactions to be allied to or identical with some of the split products of nucleic acid.

7. The dorsal layer cells become the repositories for the waste product. No direct transformation of the photogenic cells, as such, into cells of the dorsal layer takes place.

8. The photogenic process is localized in and adjacent to the cytoplasm of the photogenic cells and especially (as far as could be determined) where the cytoplasm of the tracheal end cell, and tracheole is applied to the photogenic cell.

9. The increase in intensity of the light resulting from increase in pressure is due to the increased oxygen content in the regions where photogenesis takes place. Changes in the oxygen content is not the primary means of control of the organs.

10. The primary control of the organ is by nerves in direct connection with the photogenic tissue and not by an external respiratory muscular mechanism. The termination of nerve fibers in the tracheal end cells as Bongardt states he found in *Lampyris splendidula* is supported by the fact that photogenesis may be limited to points which can structurally only be referred to the tracheal end cells and that upon increased stimulation a phenomenon similar to a 'spread' of the stimulus takes place. Furthermore the photogenic tissue is irritable and responds locally to mechanical stimuli.

11. A direct control relation exists between the photogenic organs and the nerve centres of the head. This is apparently

correlated to the relation which exists between the degree of development of the eyes and the photogenic organs, i.e., the extent of development of the eyes is in direct proportion to the extent of development of the photogenic organs.

12. The positive response to light by some photogenic organisms results in bringing the eggs and sperm in nearer proximity to each other in cases where these are set free in the water before fertilization. This has been shown for *Odontosyllis enopla* by Galloway and Welch. This is also very probably true for *Odontosyllis pachydonta* (?) Verrill. In other cases the response may lead to copulation as has been found for *Photinus pyralis* by Osten-Sacken, and for *Photinus consanguineus* and *P. scintillans* by McDermott.

Zoological Laboratory
Johns Hopkins University,
September 20, 1911.

LITERATURE CITED

- BONGARDT, J. 1903 Beiträge zur Kenntniss der Leuchtorgane einheimischer Lampyriden. *Zeits. f. wiss. Zool.*, Bd. 75, pp. 1-45.
- CLARK, E. D. 1910 The plant oxidases. Dissertation, Columbia University.
- DUBOIS, R. 1886 Contribution a l'étude de la production de la lumière par les êtres, Les Élatérides luminaux. *Bull. Soc. Zool. France*, Année II, pp. 1-275.
- 1892 Sur le mécanisme de la production de la lumière chez l'*Oryza barbarica* de Algerie. *Comptes Rend. Acad. Sci. France*, 1892, cxvii, pp. 184-6.
- 1895 *Physiological Light*. Smiths. Inst., Wash., D. C. Report for 1895, pp. 413-431.
- EIMER, T. 1872 Bemerkungen über die Leuchtorgane der *Lampyris splendidula*. *Archiv f. mikr. Anat.*, Bd. 8 p. 653.
- EMERY, C. 1884 Untersuchungen über *Luciola italica*. *Zeits. f. wiss. Zool.*, Bd. 40, pp. 338-355.
- 1885 La luce della *Luciola italica*, osservata col Microscopio. *Bull. Soc. Entomol. Ital.* Ann. 17, Trim 3, 4, p. 351-5. Also *Jour. Roy. Micr. Soc.*, 1886 p. 234.
- 1886 La luce negli amori delle Luciole. *Bull. Soc. Entomol. Ital.*, Ann. 18, p. 406.

- EMERY, C. 1886 Sur le lumière des Lucioles (*Luciola italica*). Arch. Sc. Phys. et Nat. (Genève) (3), T. 14, no. 9, p. 272-5.
- GALLOWAY, T. W., and WELCH, P. S. 1911 Studies on a phosphorescent Bermudan annelid, *Odontosyllis enopla* Verrill. Trans. Am. Micr. Soc., January 1911, vol. 30, pp. 13.
- HEINEMAN 1872 Über die Leuchtorgane der in Vera Cruz vorkommenden Leuchtkäfer. Archiv. f. mikr. Anat., Bd. 8, pp. 461-471.
- 1886 Zur Anatomie und Physiologie der Leuchtorgane Mexikanischer Cucujos (Pyrophorus). Archiv. f. mikr. Anat., Bd. 27, pp. 296-383.
- HOLMGREN 1895 Die trachealen Endverzweigungen bei den Spinnrüden der Lepidopterenlarven. Anat. Anz., Bd. 11, pp. 340-346.
- IVES, E. H., and COBLENTZ, W. W. 1910 Luminous efficiency of the firefly. Bulletin of the Bureau of Standards, Wash., D. C. vol. 6, pp. 321-336.
- KASTLE, J. H. 1910 The oxidases and other oxygen catalysts concerned in biological oxidations. Hygienic Laboratory, Pub. Health and Mar. Hosp. Serv. U. S., Bull. No. 59.
- KÖLLIKER, A. 1857 Über das Leuchten der *Lampyris*. Verhandl. d. Würzb. phys. med. Gesell., 1857. Bd. 8, pp. 217-224.
- 1854 Über den Bau der Leuchtorgane der Männchen der *Lampyris splendidula*. Sitzungsber. d. Niederrh. Gesells. f. Nat. und Heilkunde.
- LE BON, G. 1908 The evolution of forces.
- LILLIE, R. S. 1902 Oxidative properties of the cell nucleus. Am. Jour. Physiol., vol. 7, p. 412.
- LOISEL, M. G. 1903 Essai sur la technique microchimique comparative de la lecithine et des graisses neutres. C. R. de la Société de Biologie, vol. 55, p. 703.
- LUND, E. J. 1911 Notes on light reactions in certain luminous organisms. Johns Hopkins University Circular, Feb.
- MACARTNEY 1810 Observations upon luminous animals. Phil. Trans. vol. 100, pp. 277-279.
- MANGOLD, E. 1910 Die Production von Licht. Handbuch der vergleich. Physiol. (Winterstein), pp. 225-392.
- MANN, G. 1901 Physiological Histology, Oxford.
- MOLLISH, H. 1905 Luminosity in plants. Smiths. Rep. 1905, pp. 351-362.
- NUTTING, C. C. 1899 The utility of phosphorescence in deep sea animals. Am. Nat., vol. 33, pp. 792-799.
- 1910 The theory of abyssal light. Proc. 7, Cong. Zool.
- OSTEN SACKEN, BARON. 1861 Die amerikanischen Leuchtkäfer. Stettiner Entom. Zeitung, vol. 22, pp. 54-55.
- PETERS, A. 1905 Luminescence in ctenophores. Jour. Exp. Zool., vol. 2.

- RIDDLE, O. 1910 Studies with Sudan III in metabolism and inheritance. *Jour. Exp. Zool.*, vol. 8, p. 163.
- SCHREINER, O. and SULLIVAN, M. X. 1911 Concurrent oxidation and reduction by roots. *Bot. Gaz.*, vol. 51, p. 273; also the same journal, vol. 51, p. 121.
- SCHULTZE, M. 1865 Zur Kenntniss der Leuchtorgane von *Lampyris splendida*. *Archiv. f. mikr. Anat.*, Bd. I, p. 124.
- STARKE, J. 1895 Über Fettgranula und eine neue Eigenschaft des Osmiumtetroxydes. Du Bois Raymond, *Archiv. f. Phys.*, p. 70.
- TOWNSHEND, A. B. 1904 The histology of the light organs of *Photinus marginellus*. *Am. Nat.*, vol. 38, pp. 127-148.
- WATASE, S. 1895 Physical basis of animal phosphorescence. *Biol. Lects.*, Woods Hole.
- 1898 Animal luminosity. *Biol. Lectures.* Woods Hole.
- WEITLANER, F. 1909 Etwas vom Johanneskäferchen. *Verh. Zool. Bot. Ges. Wein.*, Bd. 59, pp. 94-103.
- WIELOWIEJSKI, H. R. VON 1882 Zur Kenntniss der Leuchtorgane von *Lampyriden*. *Zeits. f. wiss. Zool.*, Bd. 37, pp. 354-428.
- 1889 Beiträge zur Kenntniss der Leuchtorgane der Insekten. *Zool. Anzeig.*, Jahrg. 12, pp. 594-600.
- WISTINGHAUSEN 1890 Über Tracheenendigungen in den Serikterien der Raupen. *Zeits. f. wiss. Zool.*, Bd. 49, p. 565

PLATE 1

EXPLANATION OF FIGURES

3 Photomicrograph of part of a longitudinal vertical section of photogenic organ of ♂ *Photuris pennsylvanica*, killed in 0.5 per cent OsO_4 , thirty-six hours. Weakly stained in Ranvier's picro carmine; high power; *D*, dorsal layer showing cell walls and content of granular waste product; *P*, photogenic layer showing nuclei *N*, and photogenic granules *G*; *V*, vertical tracheae; *F*, furcations where osmic acid reduction first takes place; two tracheoles arise from each; *S*, sternite; *X*, tracheal end cells between dorsal and photogenic layers from which tracheoles pass ventrally; similar ones may be found scattered over the ventral surface.

4 Horizontal section through photogenic layer of ♂ *Photuris pennsylvanicus*; Lyons blue and borax carmine; *L*, lumen of vertical tracheae; *N*, nuclei of tracheal epithelium; *E*, nuclei of tracheal end cells forming a cylinder around vertical trachea; *P*, nuclei of photogenic cells. This photograph shows the so-called 'cell boundaries' and grouping of the photogenic granules about the nuclei.



3

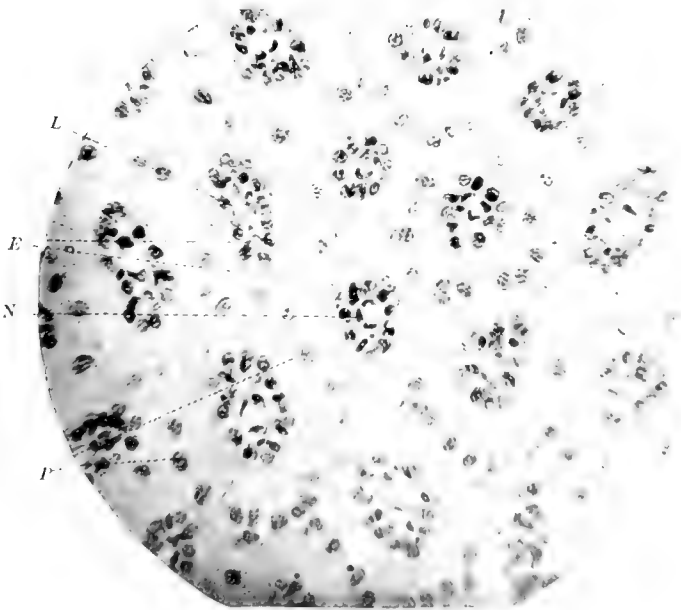

4

PLATE 2

EXPLANATION OF FIGURES

5 Photomicrograph of a vertical longitudinal section of photogenic organs of *Photinus* sp. near *maritimus*, taken with the aid of a 'bull's-eye' condenser by reflected light; the posterior and part of anterior photogenic organ is shown, with the relative distribution of the crystalline nitrogenous waste product. *A*, among the abdominal viscera; *D*, dorsal layer cells completely filled; *P*, periphery of photogenic cell; *N*, deposit around the rows of nuclei of photogenic cells. Note relative thickness of dorsal and photogenic layers in this condition of the organ.

6 Photomicrograph of high power of photogenic and part of dorsal layer showing distribution of crystalline deposit. *D*, dorsal layer, cell outlines and position of nuclei barely indicated; *P*, photogenic cells greatly diminished in size and containing the waste products in the peripheral region of the photogenic cell and around the nuclei (cf. figs. 1, 2 and 5).

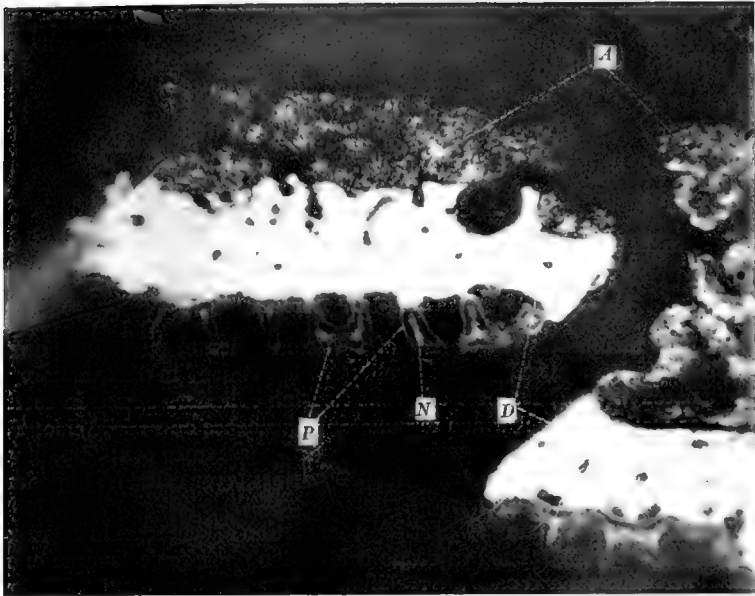

5

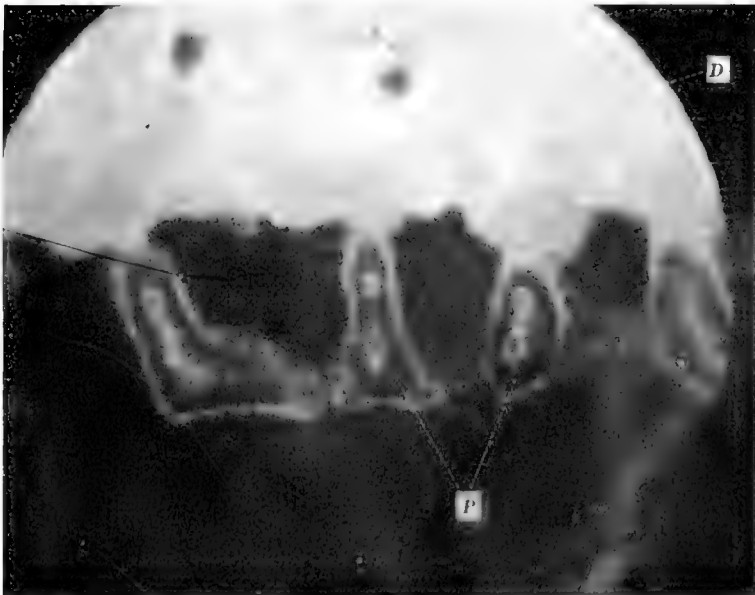

6

PLATE 3

EXPLANATION OF FIGURES

7 Camera lucida drawing of part of vertical section of photogenic organ of *Photinus* sp. (?) (Jamaican); fixed in boiling water, stained in phospho-molybdic acid haematoxylin. *E*, tracheal end cells forming cylinder—shown in section—around vertical trachea, *V* which terminates in branches on ventral side; *T*, tracheal trunk showing hairs; *Z*, peripheral zone of photogenic cell; *P*, photogenic granules *N*, nuclei of tracheal epithelium; *D*, dorsal layer cells; *H*, hypodermis; *C*, chitin of sternite bearing hairs.

8 Camera lucida drawing of part of cross section of photogenic organ of ♀ *Photuris pennsylvanica*; fixed in osmic acid. The photogenic layer is one cell deep and the tracheal end cells are distributed over the dorsal and ventral sides instead of forming cylinders around the tracheae. *T*, trachea from which branches *B*, arise passing into the two partly embedded tracheal end cells *C*; *n*, nuclei of tracheal *c.c.*, *F*, furcation from which arise three tracheoles. Reduction of the acid has not been sufficient to show the tracheoles throughout their entire course. A thick deposit of the reduced OsO_4 is shown about the furcation with traces of it in the cytoplasm, nucleus and region between the photogenic and tracheal end cell; *H*, nuclei of hypodermis. *I*, chitin; *D*, dorsal layer cells, note relative thickness of dorsal and photogenic layers; *P*, photogenic cells with granules.

9 View of portion of ventral surface of photogenic organ of *Photinus* sp. near *maritimus*, drawn by means of cam. luc. outline of active organ. *S*, shaded area, corresponding to cylinder and showing only a faint light due to diffusion of light from photogenic areas *L*. The latter correspond to region of photogenic cells. *P*, peripheral region of photogenic cells showing under some conditions a slightly greater intensity of light; *N*, nuclei of photogenic cells faintly visible as small shaded spots.

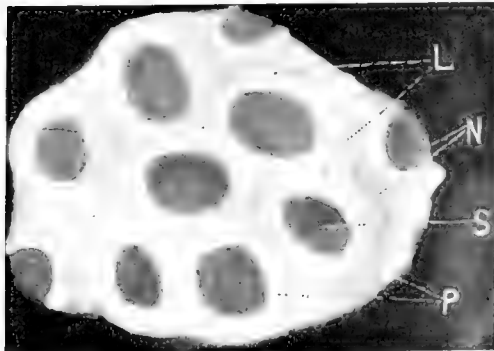

EXPERIMENTS ON DEVELOPING CHICKENS'S EGGS

STEWART PATON

Biological Laboratory, Princeton University

The results of observations made upon the developing eggs of several species of selachians suggested the possibility of repeating these experiments, with certain modifications, upon the embryos of other vertebrates.

The egg of scyllium canicula is admirably adapted for studying the primitive movements of the heart and myotom without in any way disturbing the normal relationship of the growing organism, but on account of the difficulty of securing these eggs in large quantities a search was made for material which could be more easily obtained. Observations made upon several species of lizards, frogs and fresh water fish were for many reasons unsatisfactory and attention was then directed to the chicken's egg.

Experimenters have at various times removed the fertilized egg from the shell, and after detaching the embryo, have succeeded in keeping the latter alive for some time not, however, exceeding a period of twelve hours. After many futile attempts, an operative technique has been devised making it possible in the majority of instances to remove the fertilized chicken's egg from the shell, place it in a glass dish containing fluid and return the receptacle to the incubator, when development under the conditions to be mentioned proceeds uninterruptedly. The egg freed from the shell becomes an object for observation and experiment, and not only the incidence of the primitive movements of the heart, but also many other interesting phenomena connected with the growth of the embryo may be observed and recorded. The technique employed in the operations is as follows:

All solutions are sterilized in the autoclave. Such a small quantity of fluid is lost during the process that in the majority of cases it is not often necessary to replace it but, if in certain cases it is essential, this may easily be accomplished if the fluids have been sterilized in graduated flasks. In order to shorten the operation as much as possible, and to minimize the risk of exposing the sterilized fluids to the air, the solutions are poured into dishes in which the eggs are to be placed, covered and put in the thermostat. The lids, which should be 5 mm. to 10 mm. larger than the dishes, rest upon collars of cotton held in place by string, and by this means free access is given to the air. Care should be taken that the cotton does not come into contact with the fluid in the dishes, and on the other hand, these collars must be sufficiently thick to raise the lids and give plenty of opportunity for the passage of air. Many embryos are killed by a deficient supply of oxygen. The cotton acts as a filter and prevents all bacteria except those within the shell from contaminating the fluids in the dishes.

After the egg has been for the requisite amount of time in the incubator, it is removed, the shell is wiped off with 95 per cent or preferably 100 per cent alcohol, and with the aid of a pair of forceps that have been sterilized, an opening with smooth edges is made in it and the contents allowed to slide gently into the dish containing the fluid which should be of the same temperature as the egg.

If the dish contains sufficient fluid the egg will quickly right itself so that the embryo is on top. Even slight differences of temperature seem to be fatal to the success of the experiment, and on this account, it is better to conduct the whole process of transferring the egg from its shell to the dish in some kind of warm chamber, such an one as can readily be constructed in the laboratory. When the egg is in the dish and covered, the process of development may be observed through the glass top without exposing the contents to the air.

The earlier in development that the transfer is made, the greater is the chance of failure, but when the embryo has attained the size seen under normal conditions at about the 26th-27th hour

of incubation, the operation is nearly always accomplished without serious injury to the growing organism.

The action of a variety of fluids upon the embryo were observed and a brief account of some of the effects that were noted will now be given:

The constituents of Ringer's solution were tried singly and in combination. NaCl in varying strength from 0.5 per cent to 2 per cent if uncombined, with other salts at once killed the embryo, but development although apparently taking place at a slower rate than normal, followed when the egg was placed in 0.7 per cent solution of NaCl to which 2.7 cc. of a molecular CaCl_2 solution was added. The record of all my experiments show that the rate of development is retarded in the sodium-calcium solutions, and the vitality of the embryo is also weakened.

The extremely interesting fact in connection with this experiment is that the presence of such minute quantities of calcium is sufficient not only to protect the life of the embryo, but also to insure at the proper time the incidence of the cardiac movements. The same observation with practically similar results was made upon the eggs of trout. In the presence of these minute quantities of calcium, when combined with sodium, the regular and rhythmical pulsations of the heart begin, and are continued for several hours with increasing force and rate, but later the embryo dies.

The calcium alone is not sufficient to insure the continuation of the developmental processes. In solutions to which KCl (6.3 cc. of a molecular solution) has been added, in addition to NaCl and CaCl_2 growth seems to take place at a normal rate. The effect of MgCl_2 alone upon the growth of the embryo chick and its relations to the primitive movements of the heart has not been experimentally determined, but my impression is that the solutions containing MgCl_2 when not combined with CaCl_2 and NaCl are highly toxic.

The effect of urea in strengths varying from 0.5 to 2 per cent either alone or combined with NaCl does not act as a stimulus to growth and the embryo soon dies when placed in solutions containing this substance.

Embryos detached from the egg and floated in any of the solutions named, live but a short time and the incidence of the primitive movements of the heart in these detached specimens is never observed.

Caution should be observed in basing any deductions in regard to the immediate action of the various salts upon the incidence of the cardiac pulsations. It does not seem probable that the failure of the detached embryos to develop is purely the result of shock, but is due chiefly to the absence of nourishment supplied by the egg.

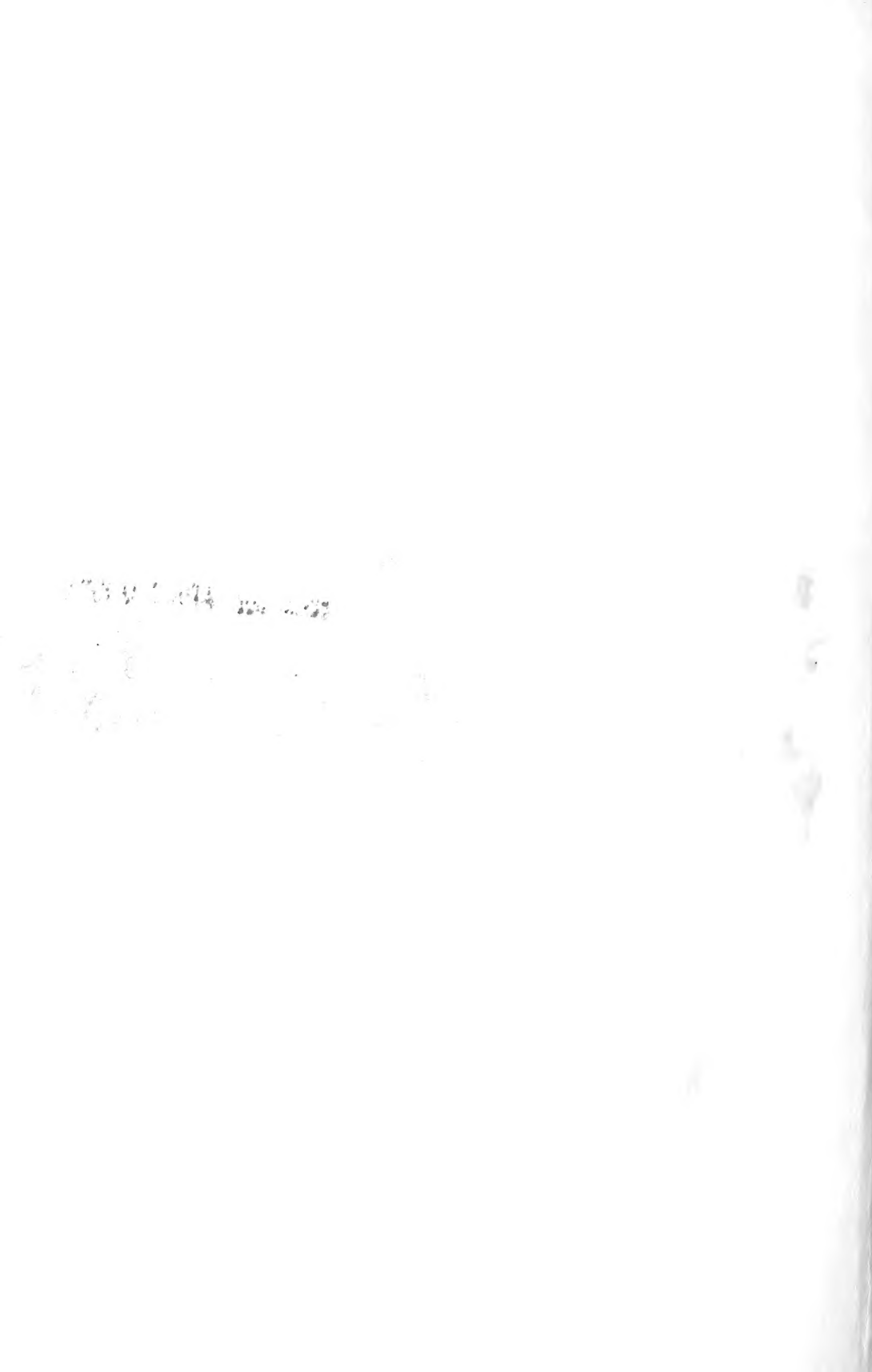

BINDING DEPT. JUN 22 1968

QL The Journal of experimental
1 zoology
J68
v.11
cop.2 1911

Biological
& Medical
Serials

PLEASE DO NOT REMOVE
CARDS OR SLIPS FROM THIS POCKET

UNIVERSITY OF TORONTO LIBRARY

