





✓

[Handwritten scribble]

Digitized by the Internet Archive
in 2009 with funding from
University of Toronto

<http://www.archive.org/details/journalofexperim27broo>

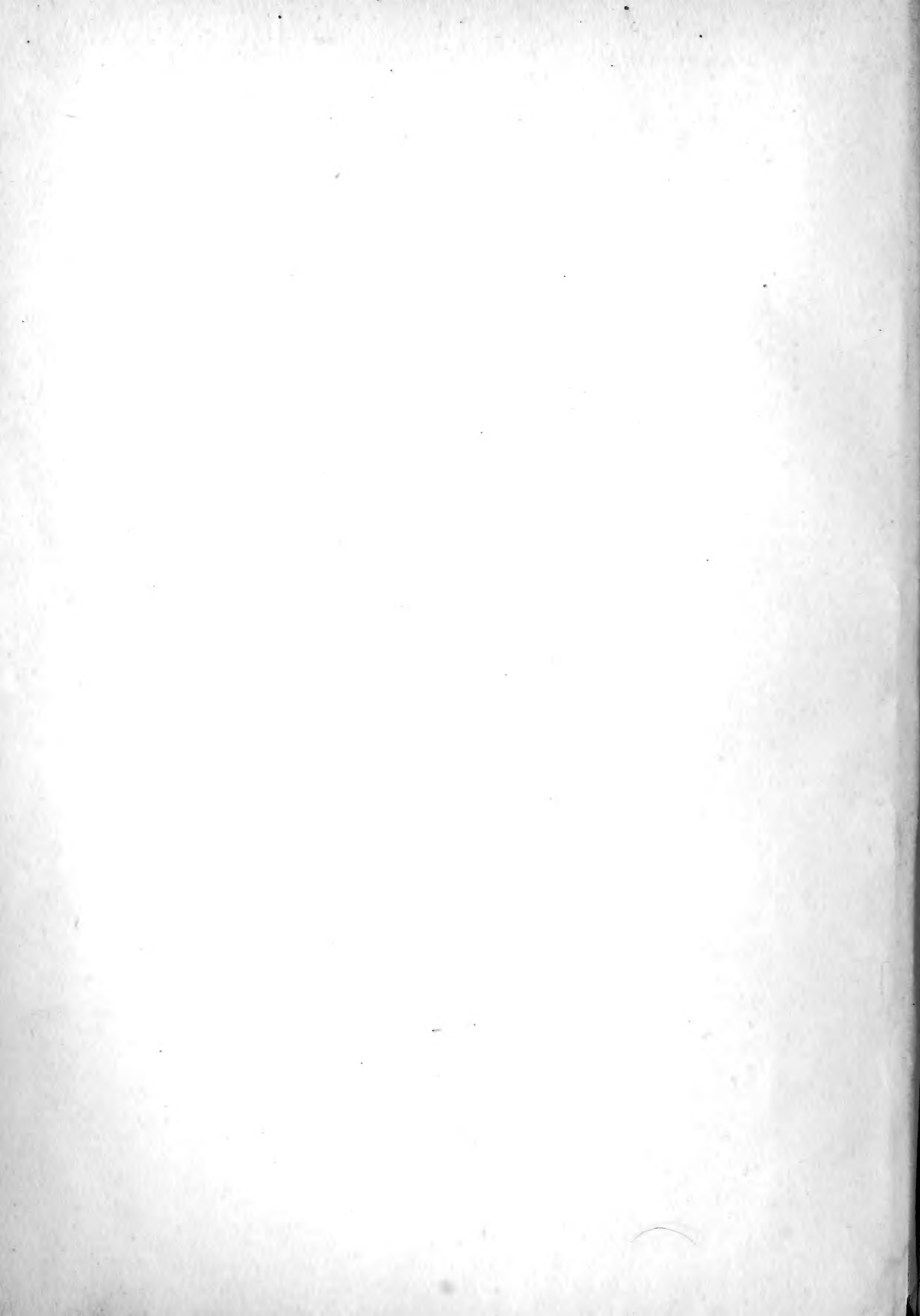

~~Biol
J.~~

THE JOURNAL
OF
EXPERIMENTAL ZOOLOGY

EDITED BY

WILLIAM E. CASTLE
Harvard University

EDWIN G. CONKLIN
Princeton University

CHARLES B. DAVENPORT
Carnegie Institution

HERBERT S. JENNINGS
Johns Hopkins University

FRANK R. LILLIE
University of Chicago

JACQUES LOEB
The Rockefeller Institute

EDMUND B. WILSON
Columbia University

THOMAS H. MORGAN
Columbia University

GEORGE H. PARKER
Harvard University

RAYMOND PEARL
Maine Agricultural
Experiment Station

and

ROSS G. HARRISON, Yale University
Managing Editor

VOLUME 27
1918-1919

154809
20/4/20

THE WISTAR INSTITUTE OF ANATOMY AND BIOLOGY
PHILADELPHIA, PA.

GL
1
J68
v. 27
cop. 2

CONTENTS

No. 1. OCTOBER, 1918

HELEN DEAN KING. Studies on inbreeding. III. The effects of inbreeding, with selection, on the sex ratio of the albino rat. One figure.....	1
SHINICHI MATSUMOTO. Demonstration of epithelial movement by the use of vital staining, with observations on phagocytosis in the corneal epithelium. Four figures.....	37
WILLIAM B. KIRKHAM. Observations on the relation between suckling and the rate of embryonic development in mice.....	49
PETER SCHMIDT. Anabiosis of the earthworms.....	57
H. H. COLLINS. Studies of normal moult and of artificially induced regeneration of pelage in <i>Peromyscus</i> . Fifteen figures.....	73

No. 2. NOVEMBER, 1918

E. R. HOSKINS AND M. M. HOSKINS. The reaction of <i>Selachii</i> to injections of various non-toxic solutions and suspensions (including vital dyes), and to excretory toxins. Twenty-seven figures (six plates).....	101
ELMER ROBERTS. Fluctuations in a recessive Mendelian character and selection. Two plates and three text-figures.....	157
CHARLES HARLAN ABBOTT. Reactions of land isopods to light. Fourteen figures.....	193
W. J. CROZIER. Assortive mating in a nudibranch <i>Chromodoris zebra</i> Heilprin. Twenty-three figures and charts.....	247

No. 3. JANUARY, 1919

GARY N. CALKINS. <i>Uroleptus mobilis</i> , Engelm. I. History of the nuclei during division and conjugation. Ninety-five text figures.....	293
W. J. CROZIER. On the use of the foot in some mollusks. One figure.....	359
S. O. MAST. Reversion in the sense of orientation to light in the colonial forms, <i>Volvox globator</i> and <i>Pandorina morum</i> . Two figures.....	367
ANDREW JOHNSON BIGNEY. The effect of adrenin on the pigment migration in the melanophores of the skin and in the pigment cells of the retina of the frog.....	391
W. W. SWINGLE. Studies on the relation of iodine to the thyroid. I. The effects of feeding iodine to normal and thyroidectomized tadpoles.....	397
W. W. SWINGLE. Studies on the relation of iodine to the thyroid. II. Comparison of the thyroid glands of iodine-fed and normal frog larvae.....	417
M. H. JACOBS. Acclimatization as a factor affecting the upper thermal death points of organisms.....	427

No. 4. FEBRUARY, 1919

GERTRUDE MAREAN WHITE. Association and color discrimination in mud-minnows and sticklebacks. Ten figures.....	443
G. H. PARKER. The organization of Renilla. One figure.....	499
MARY B. STARK. An hereditary tumor. Twelve figures (three plates)....	507

STUDIES ON INBREEDING

III. THE EFFECTS OF INBREEDING, WITH SELECTION, ON THE SEX RATIO OF THE ALBINO RAT

HELEN DEAN KING

The Wistar Institute of Anatomy and Biology

ONE FIGURE

During the latter part of the nineteenth century it was generally believed that sex in man and in various animals is determined mainly by the amount of nourishment that the embryos receive; well nourished embryos were supposed to become females; those that were poorly nourished were assumed to develop into males. A considerable amount of evidence in favor of this view was collected by Düsing ('83, '84, '86), who maintained, furthermore, that close inbreeding interferes with embryonic nutrition, by lessening the vitality of the mother, and so produces a great excess of male young.

In the literature of the succeeding twenty years that deals with the subject of sex determination, Düsing's statement regarding the effect of inbreeding on the sex ratio was widely quoted and generally credited. Those who challenged the truth of the assertion were, in the main, advocates of the ancient theory, generally ascribed to Hippocrates (460-377 B.C.), that sex is determined in the ovary; eggs from the right ovary producing males and those from the left ovary developing into females. During this period three series of experiments were made that give data regarding the sex-proportions in a closely inbred stock. Huth ('87) inbred rabbits, brother and sister, for six generations and found a relatively low sex ratio (78.8 ♂: 100 ♀) among the ninety young in which the sex was ascertained; Copeman and Parsons ('04) obtained a similar result in their inbreeding experiments with mice. Schultze ('03) concluded that inbreeding

has no pronounced tendency to produce an excess of male young, although he found a high sex ratio (110.9♂: 100 ♀) among 135 mice that were the offspring of brother and sister matings. The question as to whether inbreeding does or does not alter the sex ratio was not satisfactorily answered by any of these experiments, for in each case the number of animals used was small, and there was, apparently, no selection of the best stock for breeding or any way of checking the results. Moreover, none of these investigations were continued long enough to give evidence that could be considered as conclusive.

The effects of inbreeding on the sex ratio seemed to me to be a problem of sufficient importance to warrant a careful and prolonged investigation. For if it were possible to swing the sex ratio of any animal in a definite direction by factors that could be controlled, one might hope to gain valuable information regarding the nature of sex—a problem that has been a favorite subject of speculation for many centuries and one that modern methods of research have not, as yet, satisfactorily solved.

1. MATERIAL, METHOD, AND SCOPE OF THE INVESTIGATION

The albino rat (*Mus norvegicus albinus*) was the animal used in this investigation, which was begun in 1909. Details regarding the manner in which the experiments were conducted were given in the first paper of this series (King, '18), but it has seemed advisable to repeat them here in order to give a clear understanding of the way in which the problem has been approached.

The basis of the inbred strain was a litter of four albino rats, two males and two females, taken from the general colony of these animals maintained at The Wistar Institute of Anatomy and Biology in Philadelphia. The litter was selected for the purpose in view solely because of its size, not because of the ancestry or the vigor of the animals. One of the two females in the litter was called 'A', and her descendants form the A series of inbreds; the other female was called 'B', and her descendants are the B series of inbreds.

Since the mating of brother and sister from the same litter is the closest form of inbreeding possible in mammals, such matings

would be expected to be more potent than any other kind in producing an alteration in the sex ratio. In these experiments, therefore, brother and sister matings only were used to obtain strictly inbred litters from which all females used for breeding were taken. The plan of breeding that was followed through the first twenty-five generations of these animals was this: Females A and B, as well as all of the females in their respective lines that were subsequently used for breeding, were paired twice with a litter brother and then twice with an unrelated male taken from the stock colony. Sex records for the first two litters produced by any group of females might be expected to show whether inbreeding had any effect on the sex ratio; sex data for the third and for the fourth litters cast by these same females would, it was hoped, indicate whether the male or the female was responsible for the alteration, if any, in the sex ratio. For convenience the litters obtained from the mating of inbred females with stock males are here designated as 'half-inbred' litters; no animals from such litters have ever been reared.

Emphasis should be placed on the fact that, with few exceptions, the sex data given in this paper were obtained by examining the litters very soon after their birth. The sexes can readily be distinguished at this time, as Jackson ('12) has shown, and if accurate sex data are wanted it is imperative that they be taken as soon as possible, since the young that are stillborn, or those that die soon after birth, are usually eaten by the mother within a few hours.

In order to keep track of a large series of animals it was necessary to find some way in which the pedigree of any particular individual could be told by a glance at the record card. The scheme of marking devised, which is outlined below, has proved to be very convenient and also most satisfactory for the filing of permanent records. The letter A or B is used to show from which of the two females, A or B, the animal was descended, and thus places the individual in its proper series. The serial letter is preceded in all cases by a number which signifies the generation to which the animal belonged. An index number, 2, 3, or 4, following the serial letter shows in which of the mother's litters

the animal was born; if no index number is used the rat was a member of its mother's first litter. The subscript following the serial letter is the number which serves to distinguish each particular rat from the other rats belonging to the same generation and litter group. When it is desired to indicate the sex of the individual its number is inclosed by the sex symbol. An illustration will, perhaps, render the scheme clearer.

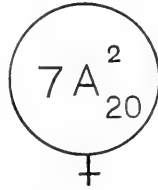

This symbol denotes a female rat belonging in the seventh generation of the A series of inbreds. She was a member of the second litter cast by her mother, and her individual number in the series of rats belonging to the second litters of the seventh generation was twenty.

In the early generations of both inbred series the animals suffered severely from malnutrition which produced a marked effect on their growth, fertility, and longevity, as previous papers in this series have shown (King, '18, '18 a). During this period a considerable proportion of the individuals were sterile, and it was not possible to select animals for breeding; any rats that would breed at all were used to continue the strain. Nutritive conditions were improved at the time that the rats of the fourth inbred generation were approaching maturity, and a decided improvement in the condition of the animals was noted in a very short time: they gained rapidly in weight, the litters cast became larger and sterility almost disappeared. At this stage of the investigation it became possible to attempt to alter the sex ratio by selection within the inbred strain. From the seventh generation on, every female in the A series of inbreds that was used for breeding was taken from a litter that contained an excess of males; breeding females in the B series of inbreds were all taken from litters containing an excess of females. The plan

of pairing a female twice with a litter brother and then twice with an unrelated stock male was continued through the first twenty-five generations of both inbred series.

In each series litters having the desired sex ratio were reared as possible breeding stock only when the young were of large size and lusty at birth; all other litters were discarded regardless of their sex ratio. At the time that the animals became sexually mature the largest and most vigorous pairs were the ones taken to continue the strain. Selection of breeding stock, it will be noted, was based primarily on the sex ratio in the litters, not on the size or on the vigor of the young. This means that the animals in one generation that became the progenitors of the succeeding generation were selected because of their parents' tendency to produce young of a certain sex. A pair of rats that produced two litters, each of which had the desired sex ratio, was considered as having an unusually strong tendency to produce unisexual young; individuals from each of these litters were used for breeding when possible. The basis of the selection, therefore, was along the line in which Pearl ('12, '12 a, '17) has obtained such marked success in increasing egg production in poultry, i.e., according to the ability of the parents to transmit to the offspring the quality desired.

In the early part of this investigation the number of breeding females was, of necessity, small, but in the later generations about twenty females in each series were used for breeding, so that at least 1000 rats were obtained in each generation of the inbred strain. Sex records for the first twenty-five generations are given in the present paper; the data comprise 3408 litters containing 25,452 individuals.

2. THE NORMAL SEX RATIO IN THE ALBINO RAT

The normal sex ratio in any species can properly be determined only by obtaining the sex data for the total number of offspring produced by many females during the entire period of their reproductive activity. Unfortunately, no such series of data for the albino rat have been recorded, and only two sets of observations regarding the normal sex ratio in this animal have,

as yet, appeared. Cuénot ('99) examined thirty litters of albino rats, containing 255 young, and found a sex ratio of 105.6♂:100 ♀; data for 1089 litters of stock Albinos, collected by King and Stotsenburg ('15), gave a sex ratio of 107.5♂:100 ♀. Neither of these determinations seemed to furnish a proper standard for comparison with the sex ratios obtained in the inbred strain, even though they differed by less than two points. The number of individuals examined by Cuénot was too small to give results of much statistical value. The sex ratio given by King and Stotsenburg was based on the findings for a relatively large number of animals, but the litters recorded were, for the most part, cast by females that had not reached the height of their reproductive activity. The sex ratio among the offspring of young females could not justly be taken as a norm for the Albino strain in general, since it has been shown that in the albino rat the sex of the young seemingly depends, to a certain extent, on the age of the mother (King, '16 a).

In order to ascertain the normal proportion of the sexes in the strain of Albinos from which the inbred animals were taken, I obtained the complete breeding history of a considerable number of stock females during the past four years. As all of these individuals were reared under the same environmental conditions as the inbred rats, the sex ratio among their young would seem to be a suitable standard by which to judge the sex ratios found in various generations of the inbred animals. To make the ratios more strictly comparable, the data for only the first four litters of the stock series were used in computing the sex ratio which was to serve as the norm. These data, arranged by litter groups, are shown in table 1.

TABLE 1
Showing the sex ratios in the first four litters of a series of stock albino rats

LITTER SERIES	NUMBER LITTERS	NUMBER INDIVIDUALS	MALES	FEMALES	NUMBER MALES TO 100 FEMALES
1	116	717	385	332	115.9
2	116	843	426	417	102.2
3	103	671	328	343	95.6
4	89	587	302	285	105.9
	424	2818	1441	1377	104.6

Table 1 shows that there was a relatively large excess of males in the first litters cast by this series of stock females (115.9♂:100 ♀), and that in succeeding litters the sex ratio tended to fall considerably. A similar change in the sex ratio of successive litters of mice was noted by Copeman and Parsons ('04), and was found also by King and Stotsenburg ('15; table 7) in a series of stock albino rats. Large groups of statistics for human births, as summarized by Ahlfeld ('76), by Düsing ('83, '84), by Punnet ('03), and by Newcomb ('04), all show that the sex ratio is very high among the first children of young mothers and then tends to fall with succeeding births until the mother is about thirty years old. Whether a similar change in the sex ratio is characteristic of other mammals has not been determined as yet.

Among the 2818 individuals comprised in this series of stock litters there were 104.6 males to each 100 females. A sex ratio of 105♂:100 ♀ was, therefore, taken as the norm by which to judge the sex ratios obtained in the various groups of inbred rats. This sex ratio, it will be noted, is very close to that given by Cuénot, and is lower, by over two points, than the sex ratio found in the large group of stock Albinos born in The Wistar Institute colony during the years 1911-1914 (King and Stotsenburg, '15).

3. THE SEX RATIO IN INBRED LITTERS OF ALBINO RATS

The A series of inbred rats may be designated as the 'male line,' since after the sixth generation all of the breeding females in this series were taken from litters that contained an excess of males. Table 2 gives, by litter groups, the sex data for the 13,116 individuals obtained in the first twenty-five generations of this series.

Table 2 is inserted chiefly for reference, and a detailed analysis of the data, as given, will not be attempted. The summary of the data for the various litter groups shows that the sex ratio for the first litters produced was much higher than that for the second, third, and fourth litters. A similar change in the sex ratio was noted in the litter series of stock animals given in table 1.

The B series of inbreds is called the 'female line,' since, after the sixth generation, all breeding females in this series came from:

TABLE 2
*Showing the number of individuals and the sex ratios in each of the first twenty-five generations of the A series of inbred
 (data arranged in litter groups)*

GENERA- TION	FIRST LITTER (INBRED)				SECOND LITTER (INBRED)				THIRD LITTER (HALF-INBRED)				FOURTH LITTER (HALF-INBRED)																		
	Number of litters	Number of in- dividuals	Males	Females	Number of litters	Number of in- dividuals	Males	Females	Number of litters	Number of in- dividuals	Males	Females	Number of litters	Number of in- dividuals	Males	Females	Number of litters	Number of in- dividuals	Males	Females	Number of litters	Number of in- dividuals	Males	Females	Number of litters	Number of in- dividuals	Males	Females	Number of litters	Number of in- dividuals	Males
1	1	7	3	4	75.0	1	7	3	4	75.0	1	6	6	6	6	6	1	9	7	2	350.0										
2	3	20	11	9	122.2	4	27	11	16	68.8	3	19	12	12	12	7	3	14	7	7	100.0										
3	7	35	12	23	52.5	5	26	15	11	136.4	5	27	15	12	15	12	5	21	9	12	75.0										
4	13	58	36	22	163.6	12	77	37	40	92.5	8	52	29	23	29	23	6	46	28	18	155.6										
5	18	117	63	54	116.7	18	130	60	70	85.8	15	111	52	59	52	59	10	58	25	33	75.8										
6	15	94	44	50	88.0	15	102	55	47	117.0	14	86	49	37	49	37	11	63	32	31	103.2										
7	16	101	64	37	173.0	16	129	74	55	134.5	15	109	64	45	64	45	9	61	33	28	117.9										
8	17	122	64	58	110.3	17	142	79	63	125.4	15	100	57	43	57	43	8	56	29	27	107.4										
9	17	105	51	54	94.4	17	123	71	52	136.5	16	121	61	60	61	60	12	76	37	39	94.9										
10	20	131	71	60	118.3	20	156	76	80	95.0	20	161	76	85	76	85	17	137	76	61	124.6										
11	21	144	82	62	132.3	21	170	104	66	157.6	20	164	87	77	87	77	18	135	68	67	101.5										
12	20	145	90	55	163.6	20	154	85	69	123.2	19	152	75	77	75	77	17	140	78	62	125.8										
13	22	160	86	74	116.2	22	180	93	87	106.9	21	156	91	65	91	65	20	157	92	65	141.5										
14	21	139	81	58	139.7	21	188	93	95	97.9	21	182	105	77	105	77	18	136	73	63	115.9										
15	23	171	109	62	175.8	23	193	103	90	114.4	21	173	90	83	90	83	17	136	68	68	100.0										
16	21	143	78	65	120.0	21	165	94	71	132.4	18	121	69	52	69	52	10	62	36	26	138.5										
17	27	210	116	94	124.0	27	244	125	119	105.0	25	213	109	79	109	79	23	178	101	77	131.2										
18	23	168	97	71	136.6	23	197	104	93	111.8	19	164	85	70	85	70	15	110	63	47	134.0										
19	23	147	89	58	153.4	23	178	97	81	119.8	22	172	90	82	90	82	15	118	68	50	136.0										
20	27	193	113	80	141.3	27	224	118	106	111.3	23	149	84	65	84	65	17	130	73	57	128.1										
21	27	199	107	92	116.3	27	217	119	98	121.5	26	223	114	109	114	109	22	187	95	92	103.3										
22	27	203	118	85	135.8	27	234	123	111	110.9	24	218	116	102	116	102	17	113	52	61	85.2										
23	25	186	112	74	151.4	25	183	103	80	128.8	22	161	87	74	87	74	19	142	80	62	135.5										
24	25	184	100	84	119.0	25	200	108	92	117.4	22	177	84	93	84	93	21	140	77	63	122.2										
25	26	173	93	80	116.3	26	203	108	95	113.8	23	166	95	71	95	71	15	104	59	45	121.1										
	485	3355	1890	1465	129.0	483	3849	2058	1791	114.9	438	3383	1802	1581	1802	1581	346	2529	1366	1163	117.4										

litters containing an excess of females. Reference data showing the proportion of males and females produced in the various generations of this series are given, by litter groups, in table 3. The data comprise a total of 1656 litters containing 12,336 individuals.

The summary for each of the four litter groups of the B series (table 3) shows that the sex ratio was at its lowest point in the first litter group, and then tended to rise in each of the subsequent groups. This is a reversed relation of the sex ratios to that shown in the litters of the stock controls (table 1) and in the litter groups of the A series (table 2), and would seem to indicate that some agency, other than environment or the age of the mother, had influenced the relative proportion of the sexes in this series of animals.

In order to compare the sex ratios in the litters sired by inbred males with the sex ratios in the litters sired by stock males, the sex records for the first and second litters produced in each generation of the two series were combined, as were also the records for the third and fourth litters. Table 4 shows the combined data for the litter groups of the A series; table 5 shows similar data for the litter groups of the B series.

Reference to the data given in table 4 and in table 5 will be made later.

To facilitate an analysis of the results obtained in the A series of inbreds, the data, as shown in table 4, were combined in generation groups (table 6). This grouping of the data was purely arbitrary. It seemed useless to compare such large series of records generation by generation, or even to combine the records for two succeeding generations. Since after the sixth generation the selection of breeding animals was made according to a definite plan, it would seem that, logically, the data for the first seven generations should form one group. Such a group, however, was too large for the purpose of ascertaining whether selection produced a varying effect in different generations. It was finally decided to make a total of eight groups, each of which, except the first, should contain the data for three generations. Because of the small number of individuals, records for the first four generations were combined in one group.

HELEN DEAN KING

TABLE 3
*Showing the number of individuals and the sex ratios in each of the first twenty-five generations of the B series of inbred
 (data arranged in litter groups)*

GENERA- TIONS	FIRST LITTER (INBRED)				SECOND LITTER (INBRED)				THIRD LITTER (HALF-INBRED)				FOURTH LITTER (HALF-INBRED)							
	Number of lit- ters	Number of in- dividuals	Males	Females	Number of lit- ters	Number of in- dividuals	Males	Females	Number of lit- ters	Number of in- dividuals	Males	Females	Number of lit- ters	Number of in- dividuals	Males	Females	Number of males to 100 females			
1	1	5	2	3	66.7	2	19	6	13	68.4	2	17	9	8	112.5	1	9	6	50.0	
2	2	12	6	6	100.0	5	26	15	11	136.4	2	9	5	4	125.0					
3	7	36	19	17	111.8	8	69	41	28	146.4	7	56	27	29	93.1	3	18	9	100.0	
4	11	66	33	33	100.0	20	158	82	76	107.9	18	150	71	79	89.9	13	95	51	44	115.9
5	20	133	66	67	98.6	15	118	61	57	107.0	14	102	51	51	100.0	8	74	41	33	124.2
6	15	106	59	47	125.5	15	105	54	51	105.9	15	104	49	55	89.1	10	78	37	41	90.2
7	15	79	42	37	113.5	15	129	69	60	115.0	13	94	48	46	104.4	3	21	10	11	90.9
8	15	108	46	62	74.2	15	129	69	60	115.0	13	94	48	46	104.4	3	21	10	11	90.9
9	20	126	62	64	96.8	20	183	90	93	96.8	17	127	68	59	115.3	10	49	26	23	113.0
10	17	104	48	56	85.7	17	145	67	78	85.9	16	107	53	54	98.1	14	93	47	46	102.2
11	19	112	49	63	77.8	19	128	66	62	106.5	18	138	60	78	76.9	18	149	78	71	109.9
12	20	139	66	73	90.4	20	175	92	83	110.8	19	154	71	83	85.5	12	68	29	39	74.1
13	21	154	54	100	54.0	21	168	73	95	76.8	19	150	70	80	87.5	13	104	50	54	92.6
14	21	142	57	85	67.1	21	135	68	67	101.5	20	161	84	77	109.1	18	132	58	74	78.4
15	20	131	61	70	87.1	20	138	58	80	72.5	20	173	88	85	103.5	17	140	72	68	103.9
16	24	158	57	101	56.4	24	184	85	99	85.9	22	190	76	114	66.7	19	132	72	60	120.0
17	22	158	68	90	75.6	22	170	74	96	77.1	21	173	83	90	92.2	17	113	52	61	85.2
18	23	168	76	92	82.6	23	180	83	97	85.6	20	171	82	89	92.1	20	149	70	79	88.6
19	24	186	73	113	64.6	24	221	98	123	79.7	22	195	93	102	91.2	13	96	34	62	54.8
20	26	174	76	98	77.6	26	179	83	96	86.5	21	157	80	77	103.9	11	88	44	44	100.0
21	24	176	77	99	77.8	24	189	91	98	92.9	18	138	64	74	86.5	16	112	50	62	80.6
22	26	174	87	87	100.0	26	210	91	119	76.5	24	211	96	115	92.2	19	139	67	92	93.1
23	22	181	82	99	82.8	22	195	83	112	74.3	20	145	65	85	82.7	15	126	53	73	72.6
24	27	207	96	111	86.5	27	189	76	113	67.3	26	175	90	85	105.9	17	114	58	56	103.6
25	26	184	83	101	82.2	26	193	86	107	80.4	25	179	88	91	96.7	20	136	62	74	83.8
	468	3219	1445	1774	81.5	462	3606	1692	1914	88.3	41	3276	1569	1707	91.3	307	2235	1073	1162	92.3

TABLE 4

Showing the sex ratios in the inbred and in the half-inbred litters produced in each of the first twenty-five generations of the A series of inbreds

GENERATIONS	INBRED (FIRST AND SECOND LITTERS)					HALF-INBRED (THIRD AND FOURTH LITTERS)					SUMMARY OF ALL LITTERS				
	Number of litters	Number of individuals	Males	Females	Number of males to 100 females	Number of litters	Number of individuals	Males	Females	Number of males to 100 females	Number of litters	Number of individuals	Males	Females	Number of males to 100 females
1	2	14	6	8	75.0	2	15	13	2	650.0	4	29	19	10	190.0
2	7	47	22	25	88.0	6	33	19	14	135.0	13	80	41	39	105.1
3	12	61	27	34	79.1	10	48	24	24	100.0	22	109	51	58	87.9
4	25	135	73	62	117.4	14	98	57	41	139.0	39	233	130	103	126.2
5	36	247	123	124	99.2	25	169	77	92	83.7	61	416	200	216	92.6
6	30	196	99	97	102.1	25	149	81	68	119.2	55	345	180	165	110.0
7	32	230	138	92	150.0	24	170	97	73	132.9	56	400	235	165	142.4
8	34	264	143	121	118.2	23	156	86	70	122.9	57	420	229	191	119.9
9	34	228	122	106	115.0	28	197	98	99	99.0	62	425	220	205	107.3
10	40	287	147	140	105.0	37	298	152	146	104.1	77	585	299	286	104.5
11	42	314	186	128	145.3	38	299	155	144	107.6	80	613	341	272	121.9
12	40	299	175	124	141.1	36	292	153	139	110.2	76	591	328	263	124.7
13	44	340	179	161	111.2	41	313	183	130	140.8	85	653	362	291	124.4
14	42	327	174	153	113.7	39	318	178	140	127.1	81	645	352	293	120.1
15	46	364	212	152	139.5	38	309	158	151	104.6	84	673	370	303	122.1
16	42	308	172	136	126.5	28	183	105	78	134.6	70	491	277	214	129.7
17	54	454	241	213	113.1	48	391	210	181	116.0	102	845	451	394	114.5
18	46	365	201	164	122.6	34	274	148	126	117.5	80	639	349	290	120.0
19	46	325	186	139	133.8	37	290	158	132	119.7	83	615	344	271	126.9
20	54	417	231	186	123.1	40	279	157	122	128.7	94	696	388	308	126.0
21	54	416	226	190	118.9	48	410	209	201	104.0	102	826	435	391	111.3
22	54	437	241	196	123.0	41	331	168	163	103.1	95	768	409	359	113.9
23	50	369	215	154	139.6	41	303	167	136	122.8	91	672	382	290	131.7
24	50	384	208	176	118.2	43	317	161	156	103.2	93	701	369	332	111.1
25	52	376	201	175	114.9	38	270	154	116	132.8	90	646	355	291	122.0
	968	7204	3948	3256	121.3	784	5912	3168	2744	115.5	1752	13116	7116	6000	117.4

As the number of individuals in each of the first seven generations of the A series was comparatively small, it is not surprising that the sex ratios in the inbred and in the half-bred groups of litters should show a wide range of variation (table 4). When the records for these generations were combined, as shown in table 6, it was found that the 144 inbred litters had a sex ratio of 110.4 ♂ :

TABLE 5

Showing the sex ratios in the inbred and in the half-inbred litters produced in each of the first twenty-five generations of the B series of inbred

GENERATIONS	INBRED (FIRST AND SECOND LITTERS)					HALF-INBRED (SECOND AND THIRD LITTERS)					SUMMARY OF ALL LITTERS				
	Number of litters	Number of individuals	Males	Females	Number of males to 100 females	Number of litters	Number of individuals	Males	Females	Number of males to 100 females	Number of litters	Number of individuals	Males	Females	Number of males to 100 females
1	1	5	2	3	66.7						1	5	2	3	66.7
2	4	31	12	19	63.2	3	26	12	14	85.7	7	57	24	33	72.8
3	12	62	34	28	121.4	2	9	5	4	125.0	14	71	39	32	121.9
4	19	135	74	61	121.3	10	74	36	38	94.7	29	209	110	99	111.1
5	40	291	148	143	103.5	31	245	122	123	99.2	71	536	270	266	101.5
6	30	224	120	104	115.4	22	176	92	84	109.5	52	400	212	188	112.9
7	30	184	96	88	109.1	25	182	86	96	89.6	55	366	182	184	98.9
8	30	237	115	122	94.3	16	115	58	57	101.8	46	352	173	179	96.6
9	40	309	152	157	96.8	27	176	94	82	114.6	67	485	246	239	102.9
10	34	249	115	134	85.8	30	200	100	100	100.0	64	449	215	234	91.9
11	38	240	115	125	92.0	36	287	138	149	92.6	74	527	253	274	92.3
12	40	314	158	156	101.3	31	222	100	122	82.0	71	536	258	278	92.8
13	42	322	127	195	65.1	32	254	120	134	89.6	74	576	247	329	75.1
14	42	277	125	152	82.2	38	293	142	151	94.0	80	570	267	303	88.1
15	40	269	119	150	79.3	37	313	160	153	104.5	77	582	279	303	92.1
16	48	342	142	200	71.0	41	322	148	174	85.1	89	664	290	374	77.5
17	44	328	142	186	76.3	38	286	135	151	89.4	82	614	277	337	82.2
18	46	348	159	189	84.1	40	320	152	168	90.5	86	668	311	357	87.1
19	48	407	171	236	72.5	35	291	127	164	77.4	83	698	298	400	74.5
20	52	353	159	194	82.0	32	245	124	121	102.5	84	598	283	315	89.8
21	48	365	168	197	85.3	34	250	114	136	83.8	82	615	282	333	84.7
22	52	384	178	206	86.4	43	350	163	187	87.2	95	734	341	393	86.8
23	44	376	165	211	78.2	45	271	116	155	74.8	79	647	281	366	76.8
24	54	396	172	224	76.8	43	289	148	141	105.0	97	685	320	365	87.7
25	52	377	169	208	81.3	45	315	150	165	90.9	97	692	319	373	85.5
	930	6825	3137	3688	85.1	726	5511	2642	2869	92.1	1656	12336	5779	6557	88.1

100 ♀, and that the 106 half-inbred litters had an even higher proportion of males (114.0♂:100 ♀). For the total of 250 litters the sex ratio was 113.2♂:100 ♀.

Until the seventh generation, as already stated, there was no selection of breeding animals in either series. As the sex ratio among the animals in the early generations of the A series was

TABLE 6

Showing, by generation groups, the sex ratios in the inbred and in the half-inbred litters of the A series (male line)

GENERATION GROUPS	INBRED (FIRST AND SECOND LITTERS)					HALF-INBRED (THIRD AND FOURTH LITTERS)					SUMMARY OF ALL LITTERS				
	Number of litters	Number of individuals	Males	Females	Number of males to 100 females	Number of litters	Number of individuals	Males	Females	Number of males to 100 females	Number of litters	Number of individuals	Males	Females	Number of males to 100 females
1-4	46	257	128	129	99.2	32	194	113	81	139.5	78	451	241	210	114.8
5-7	98	673	360	313	115.0	74	488	255	233	109.0	172	1161	615	546	112.6
1-7	144	930	488	442	110.4	106	682	368	314	114.0	250	1612	856	756	113.2
8-10	108	779	412	367	112.5	88	651	336	315	106.6	196	1430	748	682	109.7
11-13	126	953	540	413	130.7	115	904	491	413	118.8	241	1857	1031	826	124.8
14-16	130	999	558	441	126.5	105	810	441	369	121.9	235	1809	999	810	123.3
17-19	146	1144	628	516	121.7	119	955	516	439	117.5	265	2099	1144	955	119.7
20-22	162	1270	698	572	122.0	129	1020	534	486	109.8	291	2290	1232	1058	116.4
23-25	152	1129	624	505	123.5	122	890	482	408	118.1	274	2019	1106	913	121.1
8-25	824	6274	3460	2814	122.3 ±1.55	678	5230	2800	2430	115.6 ±1.47	1502	11504	6260	5244	119.3 ±1.36

some eight points above the norm, it might appear that inbreeding had tended to increase the relative number of males. Such an interpretation of the results is not warranted, however, since the sex ratio in the litters produced by the mating of unrelated parents was higher than that in the litters obtained by the mating of brother and sister, and since a similar increase in the sex ratio was not found in corresponding litters of the B series (table 7).

As the females of the seventh generations that were used for breeding were all taken from litters that contained an excess of males, it is among their offspring that we may look for a possible alteration of the sex ratio as a result of selection. The sex ratio in the inbred litters of the eighth generation of the A series was 118.2♂:100♀. This sex ratio is very much lower than that found in the inbred litters of the seventh generation (150♂:100♀), but it is still 13 points above the norm (105♂:100♀). As examination of the records given in table 4 shows that *in*

only one generation (the tenth) after the eighth did the sex ratio for the inbred litters fall to norm, in all other generations it was considerably above the norm, the highest ratio (145.3 ♂ : 100 ♀) being found in the litters of the eleventh generation.

While the sex ratios for the inbred litters of the eighth to the twenty-fifth generations varied considerably, the variation was much less after the twelfth generation than before (table 4). A part of this variation was doubtless phenotypic, since seasonal changes in temperature seem to alter the sex ratio in the rat (King and Stotsenburg, '15), and probably also other agencies, such as the age of the mother (King, '16 a), have a similar effect. As all of the sex ratios were relatively high, however, the deviations from the norm cannot be ascribed either to environment or to chance, so they must have been due, in part at least, to the manner in which the breeding animals were selected.

A most striking uniformity in the sex ratios of the inbred litters belonging in the eighth to the twenty-fifth generations of this series is shown by the grouping of the data as made in table 6. The lowest sex ratio (112.5 ♂ : 100 ♀) was found in the first group (eighth to tenth generations); the highest sex ratio (130.7 ♂ : 100 ♀) appeared in the second group (eleventh to thirteenth generations). Between these extremes there was a difference of only 18 points, while in the four following groups of litters the range of variation in the sex ratios was less than 5 points. For the total of 824 inbred litters the sex ratio was 122.3 ♂ : 100 ♀. This latter ratio was not due to an abnormal preponderance of males in a few sets of records, but was based on a series of data that in seventeen out of eighteen cases showed an excess of males greater than that considered as normal for the species. The results obtained, therefore, seem to indicate that by selecting breeding animals from litters that contain an excess of males, the sex ratio can be swung in the direction of the selection, although the line is continually inbred, brother and sister. There was in this case, however, no cumulative effect of the selection. The sex ratios were more uniform in the later generations than in the earlier ones, but they were no higher. It is rather an odd coincidence that the sex ratios in the inbred litters of the eighth and of the twenty-fourth generations were exactly the same (118.2 ♂ : 100 ♀).

Data given in table 4 show that in the half-inbred litters produced in the eighth to the twenty-fifth generations of the A series the range of variation in the sex ratios was from 99 to 140.8 males for each 100 females, six of these ratios being slightly below the norm. When the data were combined in generation groups (table 6), *it was found that not a single group gave a sex ratio as low as the norm.* The sex ratios for the litters in the later generation groups were somewhat more uniform than those for the litters in the earlier generation groups, but the uniformity was not as striking as that in the corresponding groups of inbred litters. For the total of 678 half-inbred litters the sex ratio was 115.6 ♂: 100 ♀. This ratio was some 11 points above the norm and less than 7 points lower than the sex ratio in the inbred litters belonging to the same group of generations (122.3♂: 100♀). While the litters produced by the mating of inbred females with outbred stock males thus tended to have a lower sex ratio than did the strictly inbred litters, they did not give the sex ratio that was to be expected according to the current view that chance alone determines whether a male-producing or a female-producing spermatozoon shall fertilize the egg. Such an hypothesis requires that the sexes shall appear in approximately equal numbers when large series of sex data are examined. In the present case the proportion of the sexes among the 5230 individuals obtained was very far from equal. In only one group (ninth generation) out of eighteen was there a nearly equal proportion of the sexes, in all other groups there was a pronounced excess of males.

The first twenty-five generations of the A series of inbreds comprised 1752 litters containing 13,116 individuals, 7116 males and 6000 females. The sex ratio for this series of animals was 117.4 ♂: 100 ♀. This ratio was over 12 points above the norm, and since it was based on data for such a large group of animals, it would seem to indicate that in the rat the sex ratio can be altered by selection within a closely inbred line. In this instance the relative number of males was apparently increased by selecting breeding females from litters that contained an excess of males.

The sex data for the inbred and for the half-inbred litters of the B series, combined in generation groups, are shown in table 7.

TABLE 7

Showing, by generation groups, the sex ratios in the inbred and in the half-inbred litters of the B series (female line)

GENERATION GROUPS	INBRED (FIRST AND SECOND LITTERS)					HALF-INBRED (THIRD AND FOURTH LITTERS)					SUMMARY OF ALL LITTERS				
	Number of litters	Number of individuals	Males	Females	Number of males to 100 females	Number of litters	Number of individuals	Males	Females	Number of males to 100 females	Number of litters	Number of individuals	Males	Females	Number of males to 100 females
1-4	36	233	122	111	109.9	15	109	53	56	94.6	51	342	175	167	104.8
5-7	100	699	364	335	108.7	78	603	300	303	99.0	178	1302	664	638	104.1
1-7	136	932	486	446	109.0	93	712	353	359	98.3	229	1644	839	805	104.2
8-10	104	795	382	413	92.5	73	491	252	239	105.4	177	1286	634	652	97.2
11-13	120	876	400	476	84.0	99	763	358	405	88.4	219	1639	758	881	86.0
14-16	130	888	386	502	76.9	116	928	450	478	94.1	246	1816	836	980	85.3
17-19	138	1083	472	611	77.3	113	897	414	483	85.7	251	1980	886	1094	80.9
20-22	152	1102	505	597	84.6	109	845	401	444	90.3	261	1947	906	1041	87.0
23-25	150	1149	506	643	78.7	123	875	414	461	89.8	273	2024	920	1104	83.3
S-25	794	5893	2651	3242	81.8 ±1.56	633	4799	2289	2510	91.1 ±1.74	1427	10692	4940	5752	85.9 ±1.39

In the B series, as in the A series, there was a wide range of variation in the sex ratios of the litters produced in the first seven generations (table 5). When the data were combined in generation groups (table 7), the sex ratio in the 136 inbred litters (109 ♂: 100 ♀) was found to be above the norm, while that in the half-inbred litters (98.3 ♂: 100 ♀) was below the norm. These two ratios so nearly balance each other that for the total of 229 litters the sex ratio was 104.2 ♂: 100 ♀, or less than 1 point below the norm: in the corresponding litters of the A series the sex ratio was 8 points above the norm (113.2 ♂: 100 ♀). On combining the records for the first seven generations of the two inbred series (A, B), it was found that the total of 479 litters gave a sex ratio of 108.6 ♂: 100 ♀. While this ratio is over 3 points above the norm, it is not sufficiently high to warrant the conclusion that the normal sex ratio was changed through inbreeding, particularly as the ratio was due in great part to an unusual excess of males in the half-inbred litters of the A series (table 4).

As far as can be judged from the results of this part of the investigation, close inbreeding, even when the animals are poorly nourished, does not increase the proportion of male offspring to any extent.

The breeding females in the seventh generation of the B series of inbred were all taken from litters that contained an excess of females; among their offspring the sex ratio was 94.3 ♂ : 100 ♀. *In not one of the subsequent generations was the sex ratio in the inbred litters as high as the norm*, the nearest approach to the norm was in the twelfth generation, where the sex ratio was 101.3 ♂ : 100 ♀ (table 5). In these inbred litters, as in the corresponding ones of the A series, the sex ratios were more uniform in the later than in the earlier generations, but there was no cumulative effect of selection in either case. In the B series, after the thirteenth generation, there was very little change in the relative proportion of the sexes from one generation to the next, and some of the variation found, as stated for the A series, can doubtless be ascribed to environmental action.

When the data for the inbred litters of the eighth to the twenty-fifth generations of the B series were combined in generation groups (table 7), *it was found that the sex ratios for the various groups showed even greater deviations from the norm than did those for corresponding litter groups in the A series, but that this deviation was in the reverse direction, i.e., the number of females born greatly exceeded the number of males.* The highest sex ratio for any group in the B series was 92.5 ♂ : 100 ♀ : for the entire group of 794 litters the sex ratio was 81.8 ♂ : 100 ♀, or 23 points below the norm. This latter ratio is far too low to be considered as a chance variation, and it certainly cannot be attributed to the action of environment. For both series of inbreds were reared simultaneously under the same environmental conditions, and if one ventured to suggest that environment swung the sex ratio in the B series towards the female side it would be necessary to assume that the same environment acted on the animals of the A series in a reverse direction and so swung the sex ratio towards the male side.

As the sex ratio for the inbred litters of the B series was 23 points below the norm, while that for corresponding litters of the A series was 18 points above the norm, it would appear that the sex ratio in the rat can be swung by selection farther towards the female side than towards the male side. Moenkhaus ('11) obtained a similar result in his inbreeding experiments with *Drosophila*.

The half-inbred litters in the eighth generation of the B series gave a sex ratio nearly 10 points higher than the norm, so here selection was not effective at once in changing the sex ratio. *In none of the subsequent generations, however, was the sex ratio in these litters above the norm, most of them were considerably below it (table 5)*. When the data were combined in generation groups (table 7), it was found that the sex ratios for all groups except one (eighth to tenth generations) were very low. For the total of 633 litters the sex ratio was 91.1 ♂ : 100 ♀, thus being 14 points below the norm and 9 points higher than the sex ratio for the inbred litters of this series.

In each of the inbred series the sex ratios in the half-inbred litters belonging in the eighth to the twenty-fifth generations showed less deviation from the norm than did the sex ratios in the corresponding inbred litters, yet in each case the difference between the sex ratio for the inbred group of litters and that for the half-inbred group was less than the difference between the sex ratio for the half-inbred litters and the norm. The possible significance of these results will be discussed later.

In order to obtain the sex ratios for the various generations of the inbred strain as a whole, the data for the two series (A, B) were combined as shown in table 8.

The range of variation in the sex ratios of the litters in the first four generations of the inbred strain was greater than that among all of the other generation groups (table 8). This result was to be expected, considering the relatively small number of individuals in these generations and the adverse conditions under which the animals lived. When the data were combined, however, the sex ratio obtained (110.3 ♂ : 100 ♀) was only 5 points above the

TABLE 8

Showing the sex data for each of the first twenty-five generations of the inbred strain (series A, B), also the sex ratios when the data were combined in generation groups

GENERATIONS	NUMBER OF LITTERS	NUMBER OF INDIVIDUALS	MALES	FEMALES	NUMBER OF MALES TO 100 FEMALES	NUMBER OF MALES TO 100 FEMALES IN GENERATION GROUPS
1	5	34	21	13	161.5	
2	20	137	65	72	90.3	
3	36	180	90	90	100.0	
4	68	442	240	202	118.8	110.3
5	132	952	470	482	97.5	
6	107	745	392	353	111.0	
7	111	766	417	349	119.5	108.0
8	103	772	402	370	108.6	
9	129	910	466	444	104.9	
10	141	1034	514	520	98.8	103.6
11	154	1140	594	546	108.8	
12	147	1127	586	541	108.3	
13	159	1229	609	620	98.2	104.8
14	161	1215	619	596	103.9	
15	161	1255	649	606	107.1	
16	159	1155	567	588	96.4	102.5
17	184	1459	728	731	99.6	
18	166	1307	660	647	102.0	
19	166	1313	642	671	95.7	99.1
20	178	1294	671	623	107.7	
21	184	1441	717	724	99.0	
22	190	1502	750	752	99.7	101.8
23	170	1319	663	656	101.1	
24	190	1386	689	697	98.9	
25	187	1338	674	664	101.5	100.4
	3408	25452	12895	12557	102.7 ±1.28	

norm. The sex ratios in the litters of the fifth to the twenty-fifth generations varied from 95.7 to 119.5 males to each 100 females. Variation, it will be noted, was around the norm, eight of the twenty-one ratios being at or above the norm, the rest below it. When combined in generation groups the sex data gave a very uniform series of ratios, as the last column of table 8 shows—not one of these ratios varied more than 6 points from the norm. A variation as great as this would doubtless be found in the sex ratios of any other large series of albino rats, regardless of the manner in which the animals were bred. For the 3256 individuals comprised in the first seven generations of the inbred strain the sex ratio was 108.6 ♂ : 100 ♀. This ratio is sufficiently close to the norm, I think, to indicate that, in the rat, inbreeding per se does not produce a marked increase in the number of male offspring. The sex ratio in the 22,196 individuals in the remaining eighteen generations was 101 ♂ : 100 ♀ : for the entire series of 25,452 animals in the inbred strain the sex ratio was 102.7 ♂ : 100 ♀. While these last two ratios are slightly below the norm, it is evident that in the inbred strain as a whole the sex ratio was not greatly influenced either by inbreeding or by selection. The very different sex ratios obtained in the two series of the inbred strain seem to show, however, that through selection the one inbred strain was separated into two distinct lines, one line (A) having a tendency to produce an excess of males, the other line (B) tending to produce a preponderance of females.

Unfortunately, one cannot predict with certainty what the sex ratio will be in the litters cast by any given inbred female, neither does the sex ratio in the litters cast by one female give a clear indication regarding the proportion of the sexes that will be found among the offspring of a sister rat. It is only by taking the averages for a large number of litters in a given series that the change in the sex ratio is made manifest. As an illustration of the individual differences in females regarding their tendencies to cast young of a certain sex, four sets of data for litters cast by sister females are shown in table 9. In each case given, sister rats were first paired with the same litter brother and later with the same stock male.

TABLE 9

Showing the difference between inbred sisters regarding their tendency to produce an excess of male or of female young when mated with the same male

LITTER SERIES	NUMBER OF YOUNG	MALES	FEMALES	SIRE	LITTER SERIES	NUMBER OF YOUNG	MALES	FEMALES	SIRE
1									
11B ₇₃					11B ₇₄				
1	11	3	8	11B ₇₃	1	10	6	4	11B ₇₃
2	11	5	6	11B ₇₃	2	11	8	3	11B ₇₃
3	10	2	8	Stock	3	11	7	4	Stock
					4	9	5	4	Stock
	32	10	22			41	26	16	
2									
17B ₁₄					17B ₁₅				
1	8	3	5	17B ₁₆	1	10	4	6	17B ₁₆
2	9	4	5	17B ₁₆	2	10	3	7	17B ₁₆
3	8	3	5	Stock	3	7	3	4	Stock
4	3	1	2	Stock	4	11	5	6	Stock
	28	11	17			38	15	23	
3									
12A ₁₃₄					12A ₁₃₅				
1	8	6	2	12A ₁₃₆	1	8	3	5	12A ₁₃₆
2	8	4	4	12A ₁₃₆	2	9	4	5	12A ₁₃₆
3	7		7	Stock	3	5	4	1	Stock
4	9	3	6	Stock	4	9	5	4	Stock
	32	13	19			31	16	15	
4									
13A ₄₆ ²					13A ₄₆ ³				
1	9	5	4	13A ₄₈ ²	1	7	5	2	13A ₄₈ ³
2	10	5	5	13A ₄₈ ²	2	9		9	13A ₄₈ ³
3	10	5	5	Stock	3	12	7	5	Stock
4	10	5	5	Stock	4	8	5	3	Stock
	39	20	19			36	17	19	

The first set of records given in table 9 shows the very great difference in the sex tendencies of two sister rats belonging in the B series. Female 11B₇₃ had cast three litters when she developed pneumonia and had to be killed. Each of these litters contained such a large excess of females that among her thirty-two offspring the sex ratio was only 45.4 ♂ : 100 ♀. Female 11B₇₄, on the other hand, showed a very strong tendency to produce male young, whether she was paired with a brother or with a stock male; among her forty-one offspring the sex ratio was 162.5 ♂ : 100 ♀. As yet no other sister rats have shown such a pronounced difference in their sex tendencies.

A very great similarity in the sex tendencies of sister rats is shown by the second set of records in table 9. Each litter cast by 17B₁₄ and by 17B₁₅ contained an excess of female young, whether the sire of the litter was an inbred or a stock male. In each group of litters the sex ratio was about 65 ♂ : 100 ♀.

Female 12A₁₃₄ produced an excess of male young in each of the two litters sired by her brother, but the two litters sired by a stock male showed a very great excess of female young. Conversely, while female 12A₁₃₅ cast more female than male young when paired with a brother, she showed a strong tendency to produce an excess of male young when mated with a stock male.

The last set of records in table 9 shows a case where the total number of offspring produced by each of two sister rats contained a nearly equal proportion of the sexes, but this proportion was attained in very different ways. Female 13A₄₅² showed a most pronounced tendency to produce an equal number of male and female young in each of her four litters. In the litters of female 13A₄₆² the sexes were very unequally distributed; one litter of nine young consisted entirely of females—a most unusual phenomenon in a litter of such size.

Numerous other cases, similar to the ones given, could be furnished from the records for these inbred rats. The cases cited are sufficient, I think, to show the individual differences in the females regarding their tendencies to cast male or female offspring. Incidentally, these records show, also, that the female plays a more important rôle in determining the sex ratio than is generally believed.

An examination of the sex data for successive litters cast by many hundreds of female rats does not indicate that there is "a change of sex tendency from litter to litter" in the female, as Papanicolau ('15) states is the case in guinea-pigs. Such a tendency is not shown in any of the cases given in table 8, and while the sex-proportions in the litters do change in many cases, the change is not general or striking enough to warrant the conclusion that there is a definite sex-determining factor involved.

4. THE SEX RATIOS IN THE LITTERS OBTAINED BY THE MATING OF STOCK FEMALES WITH INBRED MALES

As a check for the results obtained by the mating of inbred females with stock males, series of stock females were bred to males from various generations of the inbred strain. The number of such experiments was small, considering the scale on which the main series of experiments was conducted, but the results obtained were uniform enough to be significant.

The stock females used in these experiments were reared under the same environmental conditions as the inbred rats. When they were about three months old they were paired with males from the A or from the B series that had sired inbred litters. In order to make this series of records more strictly comparable to that obtained in the inbred strain, only four litters from any one female were recorded.

The data for the litters obtained by the mating of stock females with inbred males are given in table 10.

Stock females paired with males from the fifth generation of the inbred strain produced litters in which the sex ratio was below the norm, whether the sire of the litter belonged to the A or to the B series of inbreds. The litters sired by males from A series, however, had a much higher sex ratio than did those sired by males from the B series, although at the fifth generation there was no selection of breeding animals in the inbred strain according to a definite plan. The eighteen litters in this series gave a sex ratio of 94.7 ♂ : 100 ♀, or 10 points below the norm. This ratio might seem to indicate that inbred males tended to produce an excess of female offspring, but the number of litters

TABLE 10

Showing the sex ratios in litters produced by the mating of outbred stock females with inbred males

INBRED SERIES TO WHICH SIRES BELONGED	GENERATION TO WHICH SIRES BELONGED	NUMBER OF LITTERS	NUMBER OF INDIVIDUALS	MALES	FEMALES	NUMBER OF MALES TO 100 FEMALES
A	5	10	59	30	29	103.5
B	5	8	52	24	28	85.7
		18	111	54	57	94.7±4.30
A	9	7	51	28	23	121.7
A	12	12	60	30	30	100.0
A	13	5	33	20	13	153.9
A	15	19	177	79	98	80.6
A	16	11	126	67	59	113.6
A	17	14	117	60	57	105.2
A	18	39	347	177	170	104.1
		107	911	461	450	102.3±5.88
B	10	12	97	51	46	110.9
B	12	11	75	38	37	102.7
B	13	8	42	18	24	75.0
B	15	19	172	87	85	102.3
B	16	29	243	116	127	91.3
B	18	38	313	152	161	94.4
		117	942	462	480	96.2±30.14
Total...	242	1964	977	987	99.1

examined was too small to warrant any general conclusion from the results obtained.

The second section of table 10 shows the sex ratios in the various groups of litters obtained from the matings of stock females with males from the ninth to the eighteenth generations of the A series of inbreds. There was considerable variation in these sex ratios, as was to be expected considering the number of animals involved. The total of 107 litters in this group gave a sex ratio of 102.3 ♂ : 100 ♀. This ratio, it will be noted, was below the norm, although the sires of the litters were males that, paired with their sister, had fathered litters in which there was, as a rule, a preponderance of male young.

The sex ratios in the various groups of litters obtained by the mating of stock females with males from the tenth to the eighteenth generations of the B series of inbreds showed a much narrower range of variation than that found in the litters sired by males of the A series of inbreds, although the number of litters produced in the two series was about the same. The 117 litters in this group gave a sex ratio of 96.2 ♂ : 100 ♀, which was 9 points below the norm. Any significance that this ratio might seem to have, when taken alone, is apparently annulled by the fact that the sex ratios for the other litters groups were also below the norm, whether the sires of the litters came from the A or from the B series of inbreds. Moreover, the probable error of the mean, calculated from the averages for the various sets of litters, was so large in every case that the differences between the sex ratios of the various groups were rendered valueless.

The 242 litters in this series gave a sex ratio of 99.1 ♂ : 100 ♀. While this ratio was some 6 points below the norm, it differed by only 4.4 points from the sex ratio found in the 1510 litters obtained by the mating of inbred females with stock males (103.5 ♂ : 100 ♀). The results as a whole, therefore, do not indicate that the sex ratio was influenced to any extent by the fact that the sires of the litters were inbred rather than outbred males.

The final experiment to be made, the pairing of females from the one inbred series with males from the other inbred series, was not begun until the animals reached the twenty-sixth generation. The number of litters as yet obtained is too small to afford a basis for any general conclusion, but thus far females of the A series (male line) when paired with males from the B series (female line) have produced more male than female young, and, conversely, females of the B series, when paired with males of the A series, have shown a tendency to cast more female than male young.

The results of these various series of experiments are summarized and discussed in the following section.

5. DISCUSSION

As a basis for discussion the results obtained in this investigation are briefly summarized as follows:

1. The inbreeding of litter brother and sister for six consecutive generations, during which there was no selection of animals for breeding, did not increase the number of male offspring to any extent. The sex ratio in the 3256 young obtained was 108.6 ♂ : 100 ♀, or less than 4 points above the sex ratio taken as the norm (105 ♂ : 100 ♀).

2. Beginning with the seventh generation all breeding females in the A series were taken from litters that contained an excess of males. After this time the females in this series tended to produce an excess of male young, whether they were paired with a litter brother or with an unrelated stock male (table 6). The litters sired by inbred males gave a sex ratio of 122.3 ♂ : 100 ♀, or over 17 points above the norm; while the litters sired by stock males showed a sex ratio of 115.6 ♂ : 100 ♀, or nearly 11 points above the norm.

3. From the time that the breeding females in the B series were selected from litters containing an excess of females (seventh generation), the litters produced showed a reverse proportion of the sexes to that shown by corresponding litters in the A series (table 7). Litters sired by inbred males had a very low sex ratio (81.8 ♂ : 100 ♀); in the litters sired by stock males the sex ratio was 9 points higher than that in the inbred litters (91.1 ♂ : 100 ♀), but it was still significantly lower than the norm.

4. On combining the data for the two inbred series it was found that among the 25,452 individuals comprised in the inbred strain the sex ratio was 102.7 ♂ : 100 ♀, or less than 3 points below the norm (105.0 ♂ : 100 ♀). It thus appears that through selection the inbred strain was separated into two distinct lines: one (A) showing a high sex ratio, the other (B) a low sex ratio. Selection had the greater influence on the female line, since the sex ratio for the litters of the B series showed greater deviation from the norm than did that for the litters of the A series.

5. Stock females mated with inbred males tended to produce litters in which the sex ratio was below the norm, regardless of

whether the male belonged to the A or to the B series of in-breds. The litters sired by males from the A series showed a higher sex ratio (102.3 ♂ : 100 ♀), however, than did the litters sired by males from the B series (96.2 ♂ : 100 ♀), but these ratios are not significant, since they differ from each other and from the norm by less than three times the probable error (table 10).

Düsing's contention that close inbreeding increases the relative number of male offspring was based mainly on statistics of human births collected from several isolated communities in which there were many consanguineous marriages, and on the supposedly great preponderance of male births among the Jews, who are a clannish race and intermarry more frequently than do other civilized races. The latter evidence is undoubtedly invalid, as Pearl and Salaman ('13) have shown that the normal sex ratio among the Jews is the same as that in other races of man (105 ♂ : 100 ♀), and that the anomalous sex ratio among them is due to faulty registration, male births being recorded where those of females are not. The high sex ratio in the other cases cited by Düsing can doubtless be attributed to a similar cause. The great excess of males found in various strains of thoroughbred dogs Heape ('08) ascribed in part to inbreeding, but in these cases also it is probable that the statistics are not reliable, since female pups are commonly discarded from large litters and males are registered more often, as a rule, than females.

The inbreeding experiments of Huth ('87) on the rabbit, of Schultze ('03) and of Copeman and Parsons ('04) on mice were made with relatively small numbers of animals, and the sex ratios obtained showed no greater deviations from the norm than might have been expected under the conditions of the experiments. Shull ('13) found no change in the sex ratio of *Hydatina senta* as a result of repeated inbreeding, the proportion of male-producers and of female-producers remaining practically constant. In the present series of inbreeding experiments with the albino rat, all of the animals belonging to the earlier generations suffered severely from malnutrition, which Düsing ('84) considered as a very potent factor in increasing the number of male offspring, yet among the individuals in the first seven generations the sex ratio was only

slightly higher than the norm. The results of these various series of experiments would seem to indicate that inbreeding per se has little, if any, effect on the sex ratio.

Moenkhaus' ('11) extensive series of inbreeding experiments on *Drosophila* so closely parallel my own experiments on the rat, both in the manner in which the experiments were conducted and in the results obtained, that a brief résumé of his work must be given here.

In order to obtain the normal sex ratio in *Drosophila*, Moenkhaus ascertained the sex of 26,933 imagos that developed from eggs laid by wild flies, and found among them a sex ratio of 88.8 ♂ : 100 ♀. In this species, therefore, there is normally an excess of females, as other investigators (Rawls, '13; Hyde, '14; Warren, '18) have noted. The experiments were conducted in the following way: "Two pairs were selected from nature, the one showing a high, the other a low female ratio. These were selected as the parents of the two strains to be developed. From among the offspring of each of these two pairs a number of single matings were made. From among these the pair that showed the most favorable ratio in the desired direction was selected to continue the strain. The same process was repeated as often as desired."

In this way Moenkhaus developed two inbred strains in one of which the individuals showed a high sex ratio, in the other a low sex ratio. The results of this part of the investigation showed that "it is possible to develop a strain with a high female ratio much more easily and pronouncedly than a male strain." Moenkhaus then made reciprocal crosses between the two strains in order to determine, "first, whether the maternal or the paternal elements had an equal share in the control of this ratio, and second, whether this ratio was determined in the process of fertilization." The experiments showed, in a most decided way, that "the male has little or no influence in determining the sex ratio in this species. In most of the cases the ratio of the offspring falls pretty closely around that of the strain from which the females were taken. . . . It is not certain, however, that the sex ratio is established before fertilization, since the experiments do not with certainty

entirely exclude the male influence." In his summary Moenkhaus states: "The sex ratio is one of the qualities that is, like color, an inherent character of this creature, strongly transmissible and amenable to the process of selection. . . . Sex is probably very little, if at all, influenced at fertilization in this species, but it is probably determined much earlier and by the female."¹ Moenkhaus' conclusions regarding the character of the sex ratio and its amenability to selection are as applicable to the rat as they are to *Drosophila*, judging from the results of my inbreeding experiments on the former species. Neither of these investigations, however, give any information regarding the causes that condition sex, although each seems to indicate that the female takes quite as important a part in this process as does the male.

In the inbred strain, after the animals for breeding were selected in each generation according to a definite plan, the two series (A and B) became two separate lines as regards the sex-proportions among the young. In the one line (A) the litters contained, as a rule, an excess of males; in the other line (B) there was a corresponding excess of females. Between these two lines there was no very marked difference as regards the size of the individuals at a given age, their fertility or longevity, as the data given in previous papers have shown (King, '18, '18 a). Generation after generation, as far as the experiments have been carried, the sex ratios in the inbred lines have remained distinct, and the variations from the norm have been in the same direction in each generation of each series. These results are definite enough, and they are based on data from a sufficiently large number of animals. I think, to warrant the conclusion that in the rat the sex ratio is to a certain extent at least, a character that is amenable to selection.

¹ Warren ('18) has recently repeated Moenkhaus' selection experiments on *Drosophila*, and concludes that the sex ratio in this form is "not readily, if at all, modifiable by selection." Warren believes that the modified sex ratios found in two of his three series of experiments were due to 'chance variation,' and he attributes the anomalous sex ratios obtained by Moenkhaus to the action of a sex-linked lethal factor—the explanation offered by Morgan ('14 a) to account for the unusually low sex ratios found in several strains of *Drosophila*.

As the rats had been inbred brother and sister only, they were, according to Fish's ('14) calculations, 79.687 per cent homozygous at the time that the selection of breeding animals began (seventh generation). Selection, if effective at all in changing the sex ratio, should act in one or two generations, unless a considerable number of factors were involved. In the latter case selection might produce a gradual change in the sex ratio which would reach its culmination only after a number of generations. In each series, as table 4 and table 5 show, the sex ratio in the inbred litters of the eighth generation was close to the sex ratio that was the average for all of the litters produced in the eighth to the twenty-fifth generations, and the sex ratios in the later generations showed no greater deviation from the norm than did those in the earlier generations, although they were somewhat more uniform. Selection thus produced its maximum effect at once, and could not shift the centre of gravity of the variation in the direction of the selection, as it did in the experiments which Castle and Phillips ('14) made with piebald rats. It would appear from these results that very few heritable factors concerned in the production of the sex ratio, possibly not more than a single pair, were acted upon by selection, and that, as Pearl ('17) has stated: "selection acts only as a mechanical sorter of existing diversities in the germ plasm and not as a cause of alteration in it."

As sister rats show such marked individual difference regarding their sex tendencies, and as both nutritive (Slonaker and Card, '18) and environmental conditions (King and Stotsenberg, '15) seem to influence the sex ratio in the rat, it would seem that the sex ratio may be modified by so many agencies that it would be useless to attempt to determine the number or the nature of the particular factors that were acted upon by selection in the present case. The factors involved are evidently not of very great potency, and their action is clearly shown only when a relatively large number of animals are closely inbred under environmental and nutritive conditions that are as uniform as it is possible to make them. Whatever their nature, or in whatever manner they may be inherited, I believe that these factors act on the metabo-

lism of the ova in such a way as to render the ova more easily fertilized by one kind of spermatozoa than by the other. In the A series of inbreds, under the conditions given, the ova tended to attract spermatozoa that were 'male-producing;' in the B series, the ova tended to attract spermatozoa that were 'female-producing.'

In advocating the possibility that fertilization may be selective I am aware that I run counter to the general belief that any egg is capable of fertilization by any spermatozoön that happens to come in contact with it, and that those whose views have much weight in molding biological opinion believe that this hypothesis is "so improbable as almost to invalidate any interpretation into which it enters" (Wilson, '10). Just why this hypothesis is considered so untenable is not clear. It is true that it has not been definitely proved in any case, but neither has it been disproved, nor has any convincing proof been offered, as yet, for the very elaborate hypotheses that have been advanced to account for heredity in general and in specific cases. The burden of proof rests equally upon those who object to this hypothesis as on those who maintain it.

We owe to McClung ('02) the suggestion that the accessory chromosome may be a sex-determinant. In discussing the possible action of the accessory chromosome in determining sex, McClung ('02 a) states: 'even up to the time of fertilization the female elements are so placed as to react readily to stimuli from the mother. Here they are approached by the wandering male elements from which they may choose—if we may use such a term for what is probably chemical attraction—either the spermatozoa containing the accessory chromosome or those from which it is absent. In the female element, therefore, as in the female organism, resides the power to select that which is for the best interest of the species.'

In advocating selective fertilization as the probable cause of anomalous sex ratios, Heape ('09) says: "it must be remembered that there are an enormous number of spermatozoa available for the fertilization of each ovum, and, moreover, it will be recollected there are undoubtedly chemotactic properties associated

with ova which insure that ova of different species floating in the sea shall each be fertilized by spermatozoa of the same species, so that to grant there is still more delicate chemotaxis at work is not an illegitimate but is indeed a reasonable supposition." Castle ('03) also postulated selective fertilization in the elaboration of his Mendelian theory of sex-determination.

The one attempt that has been made to test the hypothesis of selective fertilization (Morgan, Payne and Browne, '10) seemed to indicate that the egg is fertilized by the first spermatozoon that strikes it 'head-on,' but the conditions under which the observations were made were so abnormal that no definite conclusions from them were possible, and even Morgan ('11) states that the evidence is 'admittedly insufficient.'

An earlier experiment that has a bearing in this connection seems to have been overlooked and therefore needs to be noted here. Marshall ('10) injected into the vagina of a pure-bred Dandie Dinmont bitch a mixture of seminal fluid taken from a pure-bred dog of the same species and from a mongrel terrier of unknown ancestry. Fifty-nine days later the bitch littered, producing four pups which were much alike. One of the pups died early, but as the other three developed into mongrels which resembled the terrier sire there was little doubt but that all four puppies were mongrels. Marshall cites another case in which a Dandie Dinmont bitch copulated with a dog of the same breed and two days later with a Scotch terrier. The bitch littered three pups; one was pure Dandie Dinmont, the other two half-bred Scotch terriers. These cases, according to Marshall, were indicative of a 'selective' on the part of the ova of the pure-bred bitch to "conjugate with dissimilar rather than with related spermatozoa."

I have recently been making a series of experiments somewhat on the order of those cited by Marshall, and the results obtained indicate a very strong tendency on the part of the ova of the albino rat to conjugate with spermatozoa from the wild gray rat rather than with the spermatozoa of the albino rat, although under the conditions of the experiment, details of which will be published later, the advantage in every case was with the spermatozoa from the albino male. If fertilization can be selective in such

cases I can see no valid objection to the assumption that the chemotactic reaction between ova and spermatozoa may be even more delicate and thus, under given conditions, make possible the fertilization of an egg by a spermatozoön that has one sex potency rather than the other.

There is another possible interpretation of the anomalous sex ratios found in the inbred litters of the two series. We might assume that inbreeding had acted on the males in some way so as to render one kind of spermatozoön more potent than the other in fertilizing the ova, and that this difference in potency came to have an heritable basis in the germ plasm and so could be acted upon by selection. In the A series of inbreds, according to this assumption, the 'male-producing' spermatozoa became the more potent; in the B series the 'female-producing' spermatozoa came to have the greater potency. Were this assumption correct it should receive confirmation both from the results of the experiments in which inbred females were paired with stock males and from the experiments in which stock females were paired with males from different generations of the two inbred series. The litters obtained in the former case should show a nearly equal proportion of the sexes (provided it was merely a matter of chance which kind of spermatozoa fertilized the ova), since the males were outbred and therefore, theoretically, the two kinds of spermatozoa had equal power to fertilize the ova. In the latter case the litters obtained should show a high sex ratio when the sire came from the A series of inbreds and a low sex ratio when the sire belonged to the B series.

As shown in table 4 and in table 5, the half-inbred litters produced by the mating of inbred females with stock males gave sex ratios that were very far from equality. In only one generation of each series was there an approximately equal proportion of the sexes, in all other cases the variation was in a definite direction: in the A series there was an excess of males; in the B series the females predominated. In both series, moreover, the sex ratios in the half-inbred litters were much closer to those in the corresponding inbred litters than they were to the norm. The uniformity in the various series of records and the small size of the

probable error of the mean exclude the possibility that the sex ratios could have been produced by chance or by environmental action. The results, therefore, do not support the contention that the male is the chief factor in determining the sex ratio in the rat.

The sex ratio in each of the three groups of litters obtained by the mating of stock females with males from various generations of the two inbred series was below the norm, whether the sire of the litters belonged in the A or the B series. The sex ratio in the group of litters sired by males from the A series (102.3 ♂ : 100 ♀) was only 6 points higher than that in the litters sired by males from the B series (96.2 ♂ : 100 ♀). The results in this case, therefore, do not indicate that inbreeding, with selection, influenced the potency of the spermatozoa in any way; they seem rather to signify that the particular stock females used for breeding tended to attract spermatozoa that were 'female-producing' rather than those that were 'male-producing.'

The results of the various experiments in which inbred and outbred animals were paired, taken in connection with those from the experiments in which matings were made between litter brother and sister, seem to show that in the rat, as in *Drosophila* (Moenkhaus), the female has a greater influence than the male in determining the sex ratio, and that chance alone cannot be the factor that determines whether an egg shall be fertilized by a 'male-producing' or by a 'female-producing' spermatozoön.

The size of the probable error of the mean (tables 6 and 7) indicates that in each series the difference between the sex ratio for the group of inbred litters and that for the group of half-inbred litters is a significant one. Apparently, therefore, the chemotactic reaction between the ovum and the spermatozoön is not quite the same where these sexual elements come from unrelated individuals as when they are produced by individuals that are closely inbred. A somewhat analogous case is found in the hermaphroditic ascidian, *Ciona*, where normally, as Castle ('96) and Morgan ('04, '05) have shown, the eggs are not fertilized by spermatozoa from the same individual, although they are readily fertilized by spermatozoa from any other individual, while the

spermatozoa from the first animal are functional when used with ova of another animal. Morgan ('14) has suggested that the infertility of the eggs of *Ciona* to spermatozoa from the same individual may be due to the similarity in the hereditary complex of the germ cells which in some way decreases the chances of their uniting. The selective fertilization experiments made by Marshall ('10) with different varieties of dogs and also my own experiments with different varieties of rats show that the ova of these animals have a strong tendency to unite with spermatozoa from individuals belonging to unrelated stock rather than with spermatozoa from individuals of the same 'blood.' When my own experiments are completed the results will show, I hope, whether there is a still more delicate chematactic reaction between the ova and the spermatozoa which will lead to the production of more males than females among the hybrid offspring. The anomalous sex ratios that appear in F₁ hybrids almost invariably show an excess of males. This suggests that the greater the difference between individuals as regards their blood relationship the stronger is the attraction between the ova and the 'male-producing' spermatozoa. If this suggestion proves true, its converse ought also to be true, and in a closely inbred line we would expect that the chemotactic reaction between the ova and the spermatozoa would be such that an excess of females would be produced. Such a possibility is not incompatible with the results of the present investigation, since in the inbred strain, as a whole, the sex ratio was below the norm, while the sex ratios in the litters of the female line (B) showed a greater deviation from the norm than did the sex ratios in the litters of the male line (A).

The results of this series of experiments, as a whole, seem to indicate that in the rat, as in the pigeon (Riddle, '14, '16, '17), in *Drosophila* (Moenkhaus, '11) and in the guinea-pig (Papanicolaou, '15), the female has more influence in determining the sex ratio than has the male. Yet it is not in the differentiation of the ova, nor in the development of the spermatozoa, that the key to the riddle of sex-determination will be found. A knowledge of the interaction of the germ cells, and of the conditions that influence it, must be gained before the final solution of this problem can be attained.

DEMONSTRATION OF EPITHELIAL MOVEMENT BY
THE USE OF VITAL STAINING, WITH OBSER-
VATIONS ON PHAGOCYTOSIS IN THE
CORNEAL EPITHELIUM

SHINICHI MATSUMOTO

Osborn Zoological Laboratory, Yale University

FOUR FIGURES

Though the cornea of the adult frog is thin and transparent enough for the observance of epithelial movement, it is not an easy matter to note in detail every part of the process. For this reason certain vital stains were used in the present experiments.

In the amphibians, vital staining can be produced either by introducing the dyes into water in which the animals swim, or by injection, though the latter procedure is not practicable in the case of corneal epithelium, owing to its lack of blood-vessels. The stained tissue may then be explanted. Another method is to add the dyestuffs to the culture medium containing the unstained tissue.

Several papers have appeared dealing with the different phases of this subject (Lewis and Lewis, '15; Russel, '14).

For the purpose of the present work it is necessary that the dyes should not have any deleterious effect upon the epithelial cells in order that they may remain capable of maintaining their normal activity. The staining must be produced easily and last for a considerable time.

That the epithelium of amphibians (especially larvae) is tingeable by various dyestuffs without affecting the organism or tissue elements to any marked degree has been shown by various observers (Fischel, '01). Whether vital staining may be employed in order to demonstrate moving epithelium in the culture is, however, another question.

A. METHODS OF VITAL STAINING

1. Methods of staining by immersing the whole animal in water containing dyes

a. Neutral red. Neutral red, which was first used by Ehrlich for vital staining, was considered as probably being the most suitable for the present purpose, and this proved to be the case.

In the majority of the experiments "neutral red for vital staining (Ehrlich)" was used, and the frogs were subjected to various concentrations of the dye for various lengths of time.

The experiments may be divided into two groups. In the first the animals were subjected to a relatively concentrated (1:20,000) neutral red solution for a short time (one to five hours), and in the second they were kept in a more dilute solution (1:100,000 to 1,000,000) for a much longer period (one-half to four days). The frog was then carefully washed in running water, the tissue removed and prepared in a manner similar to that used in previous experiments (Matsumoto, '18). Both modes of staining are adapted to the study of the movement of epithelium.

Though the frog could be stained an intense red without doing it any apparent harm, still the dye proved to be more or less harmful to the cells. In fact, an earlier degeneration of the explanted tissue due to the injury of cells in such preparations was frequently seen. As it was desirable to stain the tissue in such a manner that the granules would be just evident enough for observation, weak solutions (such as 1:100,000 to 1:200,000; ten to twenty-four hours) were preferable. The use of the more rapid staining, at times, brought on the disadvantage of having the granules appear unevenly distributed.

The arrangement of the neutral red granules shows a more or less marked difference in the several cell layers of the corneal epithelium. Observing from the upper (outer) surface of the corneal tissue in the culture, we see the following:

1. The outermost layer (fig. 1, *d*) consists of flat polygonal cells with large nucleus and unstained fine refractive granules in the cytoplasm. These cells, which may be present all over the

original epithelial surface or may be absent here and there, do not usually exhibit neutral red granules and show no activity.

2. The next layer (fig. 1, *c*), which is the uppermost layer in some preparations, consists of cells which contain in the cytoplasm the most minute red granules, almost uniform in size. These appear in abundance after prolonged intense staining. The contour of the individual cells is hardly visible at first. In some instances, especially when the rapid method of staining was employed, larger granules appeared in the cells so abundantly that they almost filled the cell body, leaving only a clear round or oval space in the center, occupied by the nucleus.

3. The basal cells (fig. 1, *a*), which are evidently smaller than those of the upper layers, exhibit, as a rule, distinct and much larger granules, not very uniform in size, and often more numerous on one side of the nucleus than on the other.

4. Between the two latter layers frequently another layer of cells (fig. 1, *b*) is visible. These are intermediate in size between the cells of the basal layer and those of the layer above, and as regards the arrangement of the colored granules show a resemblance to the cells of the second layer.

Furthermore, between the second and third layers there were found a number of deeply red stained bodies, round or irregular in shape, some of which showed a more deeply stained red spot (one of these is shown in fig. 1, *a*, and another in fig. 2, *a*). The origin of these bodies is unknown.

When the culture is observed several hours or more after the preparation, the cells of the upper and basal layers are easily distinguishable according to the distribution of granules in their cytoplasm, and this becomes more marked as the tissue becomes more translucent. The individual granules were sometimes observed to coalesce gradually, changing in shape.

When the tissue is intensely stained, the cells of the connective tissue and of the posterior endothelium also show distinct granules which are usually not so abundant and are more or less distinguishable from those of the epithelium. The nucleus remains unstained throughout.

Cultivated *in vitro*, the corneal epithelium, when stained with neutral red, showed a condition entirely similar to that seen in unstained preparations. The cells exhibited practically the same degree of activity, though at times they degenerated a little earlier than in the control preparation.

By this method, the cell movement along the tissue, which took place, as a rule in the fluid or semifluid culture medium, could be easily detected. That the spreading epithelium was, as a rule, two and sometimes three layers thick, was clearly demonstrated (fig. 2, *a*), while in an unstained preparation it was rather hard to determine whether they were one or two cells in thickness.

As the epithelium spread out and the individual cells became very flat and thin, a change in the arrangement of the granules took place. Then the granules of the basal cells, which were rather irregularly distributed at first, frequently assumed a crescent-shaped arrangement (fig. 2, *a*). If the staining was light, the tiniest red granules in the cells of the surface layer became faint relatively earlier. As a rule, the hyalin processes of the cells on the border did not exhibit any red granules. In general, after all activity of cells ceased, the red granules faded out and fatty granules increased, whereas the nucleus remained unstained. The same was true of the isolated epithelial cell.

So far as our observations go, there was in general a direct relation between the cell activity and presence of neutral red granules, although of course the intensity or richness of the granules was not always parallel with the cell activity.

b. Some other dyes. In the corneal epithelium subjected to 'Nile blue sulphate,' the granules were beautifully stained. This dye was found, however, to be injurious to the cells, and even the solution 1:200,000 in most instances caused more or less injury to the epithelium, though not enough to interfere immediately with the cell activity, since in many cases the cells continued to move. Disintegration of cells took place earlier, and a preparation which showed intense granulation never lived so long as the control culture (unstained or stained with neutral red). In addition to this, in the preparation subjected to the dye, fine violet crystals appeared in the cells or in the medium. Nile blue,

therefore, does not seem to be a very favorable dye for the corneal epithelium.

Neither is 'methylene blue (rectif.)' suitable for the purpose, as it fades too easily.

So far as our observations go, 'gentian violet' did not give a satisfactory result. Even the weakest solution, which stained the cells, caused their death.

'Brilliant cresyl blue 2 b' and 'methyl green' did not stain the granules clearly, nor did 'indigo carmin,' 'toluidine blue,' or 'litmus' give positive results.

2. Staining of the cornea by administration of dyes in the conjunctival sac

Arnold ('00) demonstrated neutral red and methylene blue granules in the frog cornea by conjunctival administration of the dyes in the form of fine powder. In this way typical granules appeared in the cells, often causing injury. No experiments of this kind are recorded in the present paper.

3. Staining of excised cornea

In some experiments the cornea was first excised from the animal and then stained. The tissue, after removal, was immersed in physiological saline solution containing neutral red, freshly prepared, so that the epithelium became intensely red, and could later be cultivated after thorough washing. The technique is simple and is useful in some particular instances. Usually, however, crystals appeared in the culture, when this method was employed.

4. Staining by addition of dyes to the culture medium

Both neutral red and Nile blue, freshly dissolved in salt solution, were experimented with. They are easily soluble in pure water, but not so easily if the water contains any salt (NaCl). The appearance of crystals and the unevenness of the staining proved this method to be an unsatisfactory one. Staining of nucleus and granules by the use of gentian violet failed. Methylene blue stained granules, but it could not be employed for the purpose on hand.

B. PHAGOCYTTIC PHENOMENON OF THE CORNEAL EPITHELIUM

Though the experiments on this line have not yet been completed, some interesting phenomena will be described here.

It was noted in the course of this work, that not infrequently in the preparations of cornea, where the pigment of the iris or chorioidea was accidentally mixed with the epithelium, the cells of the latter, originally not pigmented, took up the pigment, becoming gorged with it. This was easily demonstrable, but more markedly when the pigment of the eye was finely teased and put into the culture medium with the corneal epithelium. The cells of the moving border, especially, took up the dark pigment abundantly.

That the melanin granules are really taken up in the cytoplasm of cells, was clearly demonstrated in the preparations which were first vitally stained with neutral red (fig. 3). That those pigmented cells were not the originally pigmented epithelium of eye, accidentally mixed in the preparation, is beyond doubt. The epithelial cells were able to take also melanin which was previously heated or boiled.

The arrangement of the pigment granules in the cytoplasm was characteristic, resembling that of the neutral red granulations. The cells of the basal layer were often abundantly packed with the pigment, and those of upper layers were able to ingest it, too.

If in the epithelial cells which are originally not pigmented, abundant melanin is taken up, it is extremely difficult to distinguish them from the original pigment cells.

The possibility of epithelial phagocytosis has been considered by Riehl ('84); somewhat later, Rabl ('96) also took up the question and found that the epithelium of adult salamanders (*S. maculosa*) is able to take up carmin injected subcutaneously. In cultures of carcinoma and sarcoma, Lambert and Hanes ('11) demonstrated that carmin granules are taken up by the cells. Carrel and Burrows ('11) observed a similar phenomenon in cultures of sarcoma.

The melanin problem represents one of the most interesting questions in dermatohistology and experimental dermatology and is a much discussed subject. I should not go, of course, so

far as to say that the so-called 'Einschleppungstheorie' of melanin is generally accepted, though the fact stated above shows the possibility of its correctness.

Though the observations here recorded have been made only upon cells in culture, still it may not be impossible that the same occurrence takes place *in vivo* under certain conditions. At any rate, the phagocytic action toward melanin of epithelium of the adult frog in culture is here definitely shown.

Therefore, it is not quite safe, in the culture of pigmented epithelium, such as iris, to consider the pigment granules as the peculiar possession of that epithelium, because the original non-pigmented epithelium can ingest pigment granules. The study of a complex and peculiar cell, such as the pigment cell, requires great care in the methods used and in conclusions drawn.

Carmin, which was ground into fine powder, was also taken up into the cell bodies, which then showed beautiful carmin granulation. For this purpose the use of tissue, vitally stained with Nile blue, offered great advantage.

The arrangement and distribution of the granules was entirely similar to that of the melanin; the particles were arranged with considerable uniformity around the periphery of the cytoplasm.

As figure 4 shows, corneal epithelium, cultivated in plasma (or serum), containing both melanin and carmin, exhibits beautiful melanin and carmin granulations which can be preserved safely. Examination of such preparations in serial sections demonstrated the intracellular and perinuclear position of the granules. That they are in the cell bodies may be placed beyond doubt even by the careful observance of fresh preparation. Furthermore, such preparations have the advantage of enabling the observer to watch how cells with ingested granules may become detached from the main mass and move off in the culture medium.

Fine granules of Chinese ink or minute foreign bodies accidentally mixed in the culture were also taken up by the epithelium.

In regard to this most interesting phenomenon of epithelial phagocytosis, our present knowledge is very deficient. A strict differentiation of the epithelial movement from that of leucocyte

may not be possible in the case of the tissues of the frog living in vitro. Not only in their movements, but also in the phagocytic phenomena (with respect to foreign bodies) do they show a certain degree of resemblance.

The question of the said phenomena in the warm-blooded animals, as well as their bearing upon bacteriology and serology, will be considered later.

I wish to thank Prof. R. G. Harrison for the direction and support which he has given to this work.

C. SUMMARY

The epithelium of the cornea of the frog which was vitally stained with neutral red and Nile blue exhibits characteristic granules in the cytoplasm.

If properly stained, the granules exist through the entire period of cell activity, without practically affecting the cells, and facilitate the observance of cell movements.

Phagocytic phenomena of the corneal epithelium with reference to melanin, carmin, etc., are definitely demonstrated.

The distribution and arrangement of melanin and carmin granules, if finely powdered, show a certain degree of resemblance to that of neutral red and Nile blue.

LITERATURE CITED

- ARNOLD 1900 Granulabilder an der lebenden Hornhaut und Nickhaut. *Anat. Anz.*, 18, 45.
- CARREL AND BURROWS: 1911 Cultivation in vitro of malignant tumors. *Jour. Exp. Med.*, 13, 571.
- FISCHEL 1901 Untersuchung über vitale Färbung. *Anat. Hefte*, 16, 417.
- LAMBERT AND HANES 1911 Characteristics of growth of sarcoma and carcinoma cultivated in vitro. *Jour. Exp. Med.*, 13, 495.
- LEWIS AND LEWIS 1915 Mitochondria and other cytoplasmic structures in tissue cultures. *Am. Jour. Anat.*, 17, 339.
- LOEB 1912 Growth of tissue in culture media and its significance for the analysis of growth phenomena. *Anat. Rec.*, 6, 109.
- MATSUMOTO 1918 Contribution to the study of epithelial movement. The corneal epithelium of the frog in tissue culture. *Jour. Exp. Zool.*, vol. 26.
- OPPEL 1912 Causalmorphologische Zellenstudien. V. Mitteilung. *Arch. Entw.-Mech.*, 35, 371.
- RABL 1896 Untersuchungen über die menschliche Oberhaut und ihre Anhangsgebilde mit besonderer Rücksicht auf die Verhornung. *Arch. Mikr. Anat.*, 430.
- RIEHL 1884 Zur Kenntnis des Pigmentes im menschlichen Haar. *Viertelj. Derm. u. Syph.*
- RUSSEL 1914 The effect of gentian violet on protozoa and on tissues growing in vitro, with special reference to the nucleus. *Jour. Exp. Med.*, 20, 545.
- ZIELONKO 1874 Über die Entwicklung und Proliferation von Epithelien und Endothelien. *Arch. Mikr. Anat.*, 10, 351.

PLATE 1

EXPLANATION OF FIGURES

1 Experiment 202. C. 11. Neutral red granules in different layers of the corneal epithelium (adult frog) cultivated in plasma, 12 hours old. *a*, Granules in the basal cells; *b*, cells of a layer often recognizable between *a* and *c*; *c*, granules in the cells of upper layer; *d*, cells of the uppermost layer, which show no activity. $\times 450$.

2 Experiment 206. A. 3, showing neutral red granules in the moving epithelium, *a*, endothelium, *b*, and below, those of connective-tissue cells; *c*, 24 hours old. Culture in plasma. Movement (from left to right) of the ameboid border of the epithelium, *a*, on the endothelial surface *b*, is demonstrated. That the moving epithelial membrane consists at least of two layers of cells is readily confirmed by the types of granulation. Note the crescent-shaped arrangement of granules in the basal cells. On the right, *b*, those of the endothelium are represented; the contours of the cells are not visible. Connective-tissue cells (*c*), the contours of which are visible, show granules in their fine processes, too. As a rule, the hyaline processes of the epithelium do not show any granules (see also figs. 3 and 4). The tissue was intensely stained (four days in the dye 1: 200,000). $\times 250$.

3 Experiment 226. A. 2, showing phagocytic phenomenon of the corneal epithelium, which are previously stained with neutral red; 24 hours old. Resemblance of arrangement of melanin granules to that of neutral red is noticeable. *a*, Drawn from a part of epithelium, moving on the endothelial surface of cornea; *b*, epithelial cells of actively moving border. $\times 450$.

4 Experiment 236. 12. Phagocytosis of the epithelium to melanin and carmin; 18 hours old. Culture in autoplasm, in which fine powdered carmin and fresh melanin of iris were added. Drawn from a part of moving epithelial rim. $\times 450$.

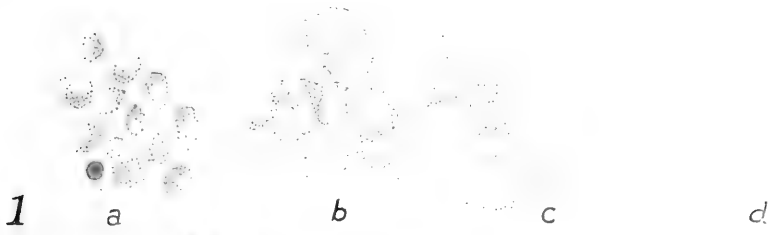

OBSERVATIONS ON THE RELATION BETWEEN SUCK- LING AND THE RATE OF EMBRYONIC DEVELOPMENT IN MICE

WILLIAM B. KIRKHAM

Osborn Zoological Laboratory, Yale University

INTRODUCTION

The present paper embodies the results of two separate but simultaneously conducted experiments, both designed to elucidate further the problems presented by the lengthened gestation period in mice which are pregnant and at the same time suckling a previous litter. Daniel ('10), working with such animals, obtained results which showed an almost constant relation of one day added to the gestation period for each animal suckled; the present writer ('16), however, in a somewhat similar series of experiments, obtained results which showed no correlation between the length of the gestation period and either the number of young suckled or the number of embryos carried (cf. also table 3). This work did, however, reveal the fact that when more than two young are being suckled the implantation of embryos instead of occurring on the fifth day after fertilization usually is delayed until the fourteenth day, during which period the blastulae lie free in the lumen of the uterus. The cause of this delayed implantation was tentatively stated in that paper to be due to an inhibition of some sort exerted by the fully activated mammary glands upon the uterine mucosa. The testing out of this hypothesis was the purpose of the following experiment.

INTERRUPTED SUCKLING AND THE RATE OF EMBRYONIC DEVELOPMENT

The program for this experiment was to take healthy female mice which had just given birth to litters, pair them for twenty-four hours with healthy males, and then remove all but one of the

suckling young at intervals varying, with different females, from one to thirteen days. One young animal was left in each case to avoid too violent a reaction upon the lactating organs, and the presence of a solitary suckling animal has been found to have no influence upon the length of the gestation period. The females were all killed on the thirteenth day after the birth of the suckling young, and any embryos then present were sectioned and their age determined by reference to a check series of known age from non-suckling females (Kirkham, '16). The results of this experiment are set forth in table 1 and should be studied in two groups. The first group, cases when the full litter was suckled one to six days, embraces a period before the next set of embryos were ready to implant, while the second group, the remainder of the table, covers an interval when the blastulae were being in-

TABLE 1

Data of all mice used in an experiment to determine the effect on developing embryos of removing all but one of the suckling young. Unless otherwise stated, the full number of young born were suckled until removed for the purpose of the experiment. Stage of development of embryos is in terms of actual age of similar embryos from non-suckling females where thirteenth day post-partum equals twelfth day of embryonic development. All the females were killed on the thirteenth day after the birth of the suckled young

SERIAL NUMBER	DAYS SUCKLED	NUMBER OF YOUNG	NUMBER OF EMBRYOS	STAGE EMBRYONIC DEVELOPMENT	REMARKS
				<i>days</i>	
J 22	1	6	6	7	
J 21	2	7	6	11	
J 26	3	6	1	12	1 young died
J 27	3	6	8	7	
J 24	4	7	3	8	
J 25	4	6	6	10	
J 18	5	10	7	11	
J 17	6	7	11	8	
J 28	6	5	5	10	
J 29	6	4	6	10	
J 16	7	8	12	6	1 young died
J 12	8	12	10	7	
J 13	9	5	6	6	
J 10	10	7	9	6	
J 11	11	7	4+	4	1 horn uterus lost
T 14	13	5	9	4	

hibited from implanting. The importance of this grouping is apparent when one considers that in the first group of cases in every instance an interval of from a few hours to several days intervened between the end of suckling by the full litter and any readiness of the embryos to implant. Embryos in the second group, on the contrary, were presumably all prepared, before the removal of the suckling young, to implant themselves, and did so as soon as the inhibition acting upon the uterine mucosa fell below a certain minimum.

Analysis of the data, with these facts in mind, reveals the interesting fact that while some sets of embryos (J 18, 21, and 26) are as fully developed as control series when no young were being simultaneously suckled, others show a lag in development of from one to four days. No such diversity of results has been found by the writer in series of embryos from non-suckling females, and furthermore, it is evidently not directly correlated with the number of young suckled (cf. J 26 and J 27), the number of embryos (cf. J 21 and J 22), or with the combination of these two numbers (cf. J 18 and J 27). There remains the explanation that the irregularity is due to an individual variation either in the strength of an inhibitory influence exerted by the mammary glands upon the uterus or in the susceptibility of the uterus to such influence. Evidently some individuals are so constituted metabolically that the inhibition is rapidly and entirely neutralized, so that if even a short interval elapses between cessation of full mammary activity and the arrival of the eggs in the uterus, implantation and further embryonic development proceed as though no young had been suckled, while in other individuals an even longer interval still leads to delay in embryonic growth. The possible existence of such an inhibitory influence of the activated mammary glands upon the uterine mucosa has previously been shown by the experiments of Adler ('12), who found that repeated injection of extracts of mammary gland into pregnant guinea-pigs and rabbits arrested the development of embryos and often produced abortion.

CONSTANT NUMBER SUCKLING AND THE DEVELOPMENT OF EMBRYOS

The second method of attacking the problem of prolonged gestation in suckling female mice was to determine whether or not, if the number of young suckled was constant, the stage of embryonic development could at any given time after fertilization be theoretically determined. Four was chosen as the constant number, since it was neither the smallest size of litter known to prolong gestation nor, on the other hand, was it such a large number as to prevent the use of nearly all of the available material.

Females who had just given birth to litters of four or more young had the male already present removed, together with any excess number of young. This was done the morning following the birth of the litter, and at varying intervals thereafter the females were killed, the eggs or embryos obtained from these females were sectioned, and their stage of development determined, the assembled data being shown in table 2.

The first notable feature in table 2 is the delay in implantation, no implanted embryos being found before the twelfth day after ovulation, a confirmation of work published by the writer in a previous paper ('16). After the twelfth day of gestation there appears the same lack of correlation, as noted above in connection with table 1, between their stage of development and the time of ovulation, and since if degeneration is going to occur it always takes place at the stage of four or five days' development, this possible factor can be ruled out. In other words, we have here proof of the fact that the irregularities in the rate of development of embryos in females which are simultaneously pregnant and suckling is due, only in small measure, if at all, to the number of young suckled, for if the number suckled and the rate of embryonic development were correlated the data in table 2 should indicate a regular correlation between stage of development and age of embryos, and such is not the case.

The explanation of this failure to correlate the ratio of embryonic development in suckling females with either the size of the

TABLE 2

Data of all mice used in an experiment to determine the effect on developing embryos of the suckling of a fixed number of young. In this experiment all litters within twelve hours of their birth were reduced to four young. Stage of embryonic development in terms of actual age of similar embryos from non-suckling females

SERIAL NUMBER	SIZE OF LITTER	AGE OF SUCKLED YOUNG	STAGE EMBRYONIC DEVELOPMENT	DELAY
		<i>days</i>	<i>days</i>	<i>days</i>
T 75	4	3	2	0
T 11	4	4	3	0
T 70	4	5	4	0
T 24	4	6	4	1
T 63	8	9	4	4
T 67	8	10	4	5
T 43	4	11	4	6
T 42	4	12	4	7
T 66	5	13	4	8
T 62	8	14	4	9
T 15	4	15	10	4
T 54	5	16	7	8
T 65	6	17	9	7
T 60	5	18	5	12
T 56	4	19	6	12
T 68	8	20	14	5
T 73	4	21	18	2
T 61	5	22	9	12
T 57	6	23	13	9
T 59	8	24	11	12
T 71	7	26	17	8
T 72	9	26	19	6

litter or with any other factor is to be sought in the first part of this paper, where the irregular influence of the termination of suckling by a full litter is conclusively shown. Add to this the fact that under normal circumstances the suckling young begin to eat solid food at about the time implantation occurs in females which are simultaneously pregnant, and the evidence here presented all indicates that after full suckling ceases, whether by removal of the litter or weaning matters not, the inhibition to implantation is withdrawn or overcome at a widely different rate in different females. Therefore, even when the number suckled is the same, the sets of embryos show no constant rate of develop-

TABLE 3

Data regarding the length of the gestation period in mice simultaneously pregnant and suckling young. The gestation period in non-suckling females averages twenty days

NUMBER SUCKLED	GESTATION PERIOD OF EMBRYOS	DELAY	REMARKS
	<i>days</i>	<i>days</i>	
1	20	0	A male was present with each female when the young were born, and in each case the male was removed 24 hours later
1	20	0	
2	19	0	
2	20	0	
3	20	0	
3	29	9	
3	30	10	
4	31	11	
4	30	10	

ment, nor, as a consequence, is the period of gestation a matter that can be figured out in advance, except with broad limitations (table 3).

SUMMARY

1. In mice simultaneously suckling and pregnant the removal of all but one of the suckling young at any time during the first six days after the birth of the suckling litter leads in some instances to implantation of the embryos as soon as they reach the uterus; in other instances the implantation is more or less delayed. These varying results can be correlated neither with the time of removal nor with the number of young taken away.

2. In mice simultaneously suckling and pregnant the removal of all but one of the suckling young at any time from seven to fourteen days after the birth of the suckling litter regularly results in implantation being delayed, but the exact extent of this delay can be correlated neither with the exact time of removal nor with the number of young removed, although removal during the earlier part of the period in question does hasten implantation as compared with the time required if the young had continued to suckle.

3. The facts in the above paragraphs justify the statement that full activity of the mammary glands is the chief cause of

delayed implantation in the case of mice which are suckling young, and also that this influence of the mammary glands is subject to marked individual variation.

4. The suckling by pregnant female mice of the same number (four in this experiment) of young will not necessarily lead to either synchronous development of embryos or the same length of gestation periods. The only explanation that can be offered at the present time for this lack of uniformity is the individual variation, noted in the preceding paragraph, of the inhibition from the mammary glands or in the strength of the counteracting forces, probably due to metabolic idiosyncrasies.

LITERATURE CITED

- ADLER, L. 1912 Versuche mit 'Mammimum Poehl' betreffend die Function der Brustdrüse als innerlich sezernierende Organ. Münchner Med. Wochenschrift, 59.
- DANIEL, J. F. 1910 Observations on the period of gestation in white mice. Jour. Exp. Zool., vol. 9, no. 4.
- KIRKHAM, W. B. 1916 The prolonged gestation period in nursing mice. (Abstract.) Anat. Rec., vol. 10, no. 3.
- 1916 The prolonged gestation period in suckling mice. Anat. Rec., vol. 11, no. 2.



ANABIOSIS OF THE EARTHWORM

PETER SCHMIDT

Agricultural College in Petrograd

The remarkable biological phenomenon, now known under the name of 'anabiosis,' given it by Preyer ('91), was already observed in 1701 by the first Dutch microscopist, Anton Leeuwenhoek. Studying microscopical animals, he found that some of them, namely, the representatives of the present groups of Tardigrada and Rotatoria, living in the moss of the roofs and in the sand of the roof-gutters, can be completely dried up and retain for a long time their vitality in such desiccated state. If after some weeks or months of preservation one places in water the dried bodies of these animals, they quickly become swollen and in a short time the animals revive.

The same observation was made afterwards by Needham (1745) and Baker (1764) on some Nematodes belonging to Anguillulidae; Baker revived these microscopical worms after twenty-seven years of preservation in the desiccated state.

The famous Italian biologist of the eighteenth century, Abbott Spallanzani (1777), repeated all the experiments on the Tardigrada and Rotatoria of the previous authors; he came to the same conclusions and cleared up many interesting details of the phenomenon.

For a long time these experiments on resuscitation of microscopic animals had interested the scientific world rather more as a curiosity. But in the second half of the last century the attention of the biologist was called to the fact of the resuscitation in connection with the question of the origin of life and spontaneous generation.

The property of resuscitation of Rotatoria and Tardigrada was once more carefully studied by Doyère ('42) and the resuscitation of Anguillulidae by Davaine ('56). Afterwards this

question was studied in a more detailed way by Gavarret ('59). In 1860 the 'Société de Biologie' in Paris was in such a degree interested in clearing up this question that it elected a special commission, with Broca as president and Balbiani, Brown-Sequard, Darest, Guiliemint, and Robin as members, for controlling the experiments on revivification of Rotatoria and Tardigrada. This commission (Broca, '60) not only confirmed the fact of the reviving of these microscopic animals, but also stated their excessive endurance to high temperature. In the dried state they endure a temperature of 100°C. and can remain for very long time in a vacuum without loss of vitality.

However, this question has not been reviewed and reëxplored in full measure by modern methods. Some zoologists who have studied the resuscitation of one or another representative of Rotatoria and Tardigrada for instance, Fromantel ('77), Plate ('86), Zacharias ('86) came to negative results, but the others, such as Schulz ('15), have not only confirmed the results of previous authors, but have also given new proofs of the resistance of exsiccated animals to the absence of oxygen. According to experiments of Schulz, the Tardigrada, Rotatoria, and Nematodes can remain exsiccated during one year in an atmosphere of pure hydrogen and not lose their vitality.

Summarizing all that is known upon this subject, one may say that most experimenters have succeeded in the revivification of exsiccated Tardigrada, Rotatoria, and Nematodes, which, living in moss and sand, are adapted to such loss of water. The body of these microscopic animals wrinkles up completely by the exsiccation and loses its form, but if placed afterwards in water it swells and regains its natural size and contour. It can be regarded as proved, also, that such exsiccated animalcules endure easily and without injury high temperatures (100°C. and more; in experiments of Doyère, 140°C.), as well as absence of oxygen.

But many points of this remarkable phenomenon remain unelucidated and require further investigation. Firstly, it would be necessary to ascertain how far the exsiccation can go without loss of vitality. It is, a priori, improbable that the animalcules can lose all the water contained in their living tissues,

and it may be that the uncertainty of the results stated by some experimenters depends mostly upon the fact that not all animalcules lose the same quantity of water by the exsiccation. But it is altogether impossible to determine the percentage of water lost by the exsiccation of anabiotic Tardigrada, Rotatoria, and Nematodes in consequence of the microscopic dimensions of the creatures.

A casual observation has directed my attention to another object more appropriate for experiments of this kind and showing features completely analogous to the anabiotic Tardigrada, Rotatoria, and Nematodes—that is the earthworm. The Lumbricidae are animals also adapted by the nature of their habitat to exsiccation; they live in the uppermost layers of the soil, which are often more or less dry, and the worms must lose water. Evidently they do not lose it in such degree as the moss inhabitants, but, on the other hand, they have a higher organization, and the loss of the same percentage of water must be for them of more serious consequence. The comparatively large size of earthworms permits a more detailed study of the process of exsiccation and also the determination, with full precision, of the degree of loss of water.

In the first study concerning the earthworms, made by me in collaboration with my pupil, Miss T. V. Stechepkina (Schmidt and Stechepkina, '16), in the Zoological Laboratory of the Agricultural College in Petrograd, we have tried to determine the influence of lower temperatures on earthworms, and we have shown by experiments that the loss of water has no influence on the endurance of earthworms as to low temperature. The normal worms, as well as the partly exsiccated ones, die between -1.6° and -2°C . But in studying this question, we discovered that the earthworms show a very great tolerance of loss of water contained in their bodies.

I give here a table of results obtained in 1916 in these experiments (table 1).

TABLE I

NUMBER	WEIGHT OF THE WORM	LOSS AFTER EX-SICCATION	LOSS	TIME OF EXSICCATION
	<i>grams</i>	<i>grams</i>	<i>per cent</i>	
1	1.2720	0.2430	19.1	6 hours 45 minutes
2	0.8815	0.2995	33.4	6 hours 45 minutes
3	0.9055	0.2670	28.3	6 hours 45 minutes
4	0.9255	0.2650	28.5	6 hours 45 minutes
5	1.1520	0.3255	28.1	6 hours 45 minutes
6	1.2589	0.2583	25.1	6 hours 45 minutes

The exsiccated earthworms, having lost even 33.4 per cent of the weight, are wrinkled and completely motionless, but placed on moistened filter-paper they quickly revive and regain their normal size. This observation excited my interest, but absence of material in wintertime prevented the continuation of the experiments.

In the summer of 1917 I spent one month in the Experimental Agricultural Station Nikolaievskaya, belonging to the Petrograd Agricultural College. The chemical laboratory of the station is provided with all that was necessary for my study, and I profited by this occasion to continue my experiments.

The question that I proposed to solve was to find out the most convenient methods of exsiccation and of revivification of the worms and to determine the percentage of the loss of water which still leaves the possibility to revive.

The earthworms, belonging to the species *Allolobophora foetida*, were dug out in the garden and then kept on moistened filter-paper in a glass dish for two or three days, so that their gut was cleaned from the earth it contained, which otherwise would have disturbed the experiments. Before weighing, the worm was always dried with the filter-paper and then placed in a small glass dish, previously weighed on a chemical balance, and tied up with a bit of muslin. After weighing, the glass dish with the worm was placed in a desiccator with calcium chloride. Twice or three times a day all the glass dishes were weighed and the percentage of loss calculated. The exsiccation was occasionally delayed by the withdrawal of the glass dish from the desiccator. If I considered the exsiccation to be sufficient, I took out the earth-

worm and placed it directly on moistened filter-paper for the revivification or preserved it temporarily in a corked test-tube.

Before proceeding to the experiments on exsiccation I made a series of weighings in order to determine the percentage of water in the earthworms. The glass tubes with the worms were weighed and placed in a steam-bath where they were dried at 100°C. until the weight became constant. Then the worms were dried during a certain time in the desiccator over calcium chloride and weighed once more.

The results of thirteen determinations is given in table 2.

TABLE 2

NUMBER	WEIGHT OF THE LIVING WORM	WEIGHT OF THE DESICCATED REST	WATER
	<i>grams</i>	<i>grams</i>	<i>per cent</i>
1	0.7122	0.1225	82.8
2	0.8017	0.1340	83.6
3	0.9301	0.1434	84.5
4	0.8101	0.1500	81.5
5	0.8983	0.1379	84.6
6	0.5782	0.0845	85.3
7	0.5105	0.0901	82.3
8	0.6432	0.1395	78.3
9	0.6570	0.1115	83.0
10	0.5165	0.0647	87.4
11	0.5842	0.0739	87.3
12	0.5798	0.0669	88.4
13	0.7328	0.1099	85.0
Mean.....			84.1

The results of these weighings are very near to those of similar weighings undertaken by Miss Stechepkina and myself in 1916, when we found the earthworms to contain on the average 82.7 per cent of water.

EXPERIMENTS, SERIES I

The first series of my experiments consisted in the exsiccation of earthworms and their immediate revivification.

The results of the exsiccation are given in the following table 3.

TABLE 3

NUMBER	DATE OF THE FIRST WEIGHING	WEIGHT OF THE LIVING WORM	DATE OF FINAL WEIGHING	HOURS OF EXSICCATION	WEIGHT OF THE EXSICCATED WORM	LOSS OF WATER IN PER CENT OF WEIGHT
		<i>grams</i>		<i>hours</i>	<i>grams</i>	
1	25 VII 17h ¹	1.0133	29 VII 20h	99	0.4081	47.5
2	25 VII 17h ¹	0.9194	27 VII 11h	42	0.3114	66.8
3	25 VII 17h ¹	0.8605	27 VII 11h	42	0.2134	75.2
4	25 VII 17h ¹	1.2222	27 VII 11h	42	0.5304	56.2

¹For brevity I use the astronomical mode of designation of time.

Earthworm no. 1 was exposed to a very gradual drying, it being confined in a narrow glass cylinder. Towards the end of the exsiccation (29 VII 20h) the worm had lost 47.5 per cent of its weight, was strongly contracted, became dark brown, had completely lost its mobility, but retained the elasticity of the body. After drying it was kept for thirty-nine hours (until 31 VII 11h) in a small hermetically corked glass tube and then placed on moistened filter-paper. It showed no signs of mobility, but its body was elastic and not frangible. After one hour I already observed some movements of the body. In the evening 31 VII it had completely revived. After reviving its weight was 0.9026 gram, i.e. 0.1117 gram lower than before the exsiccation.

Earthworms nos. 2 and 3 were dried more quickly and lost 66.8 and 75.2 per cent of the weight of the body. After exsiccation they assumed a dark brown color and were covered with a dry, crust-like skin. Four hours after the end of the exsiccation (27 VII 14h 50') they were placed on moistened filter-paper, but did not revive and showed no signs of life.

Earthworm no. 4 lost 56.2 per cent of the weight of the body. Its upper end was overdried and covered with crust-like skin. Placed 27 VII 14h 50' on moistened filter-paper, it showed at 15h 50' some weak contractions and movement on the caudal end of the body, but the proximal end was much swollen. The next day this individual died.

This first series of experiments showed that the worms *can revive after the loss of nearly half the weight of their body; that is, a loss of more than 50 per cent of the water contained in the body.*

EXPERIMENTS, SERIES II

The second series was not so successful as the first, perhaps because I used earthworms of a smaller size: they dried too quickly and lost their elasticity. The conditions of these experiments were the same as in the first series; the only difference was that the worms were not exposed to exsiccation in flat glass dishes, but in small cylindrical test-tubes. This seemed to be less advantageous.

The results of the exsiccation were as follows (table 4):

TABLE 4

NUMBER	DATE OF THE FIRST WEIGHING	WEIGHT OF THE LIVING WORM	DATE OF FINAL WEIGHING	HOURS OF EXSICCATION	WEIGHT OF THE EXSICCATED WORM	LOSS OF WATER IN PER CENT OF WEIGHT OF WORM
		<i>grams</i>		<i>hours</i>	<i>grams</i>	
1	29 VII 14h	0.3486	31 VII 20h	54	0.1113	69.1
2	29 VII 14h	0.2806	31 VII 11h	45	0.1419	49.5
3	29 VII 14h	0.2425	31 VII 11h	45	0.1074	55.8
4	29 VII 14h	0.2216	31 VII 11h	45	0.0983	56.6

Worm no. 1 was completely overdried, and when placed on moistened filter-paper showed no signs of life. Worms nos. 2 and 3 also did not revive. Worm no. 4, placed on moistened filter-paper 31 VII 11h, displayed after 1 hour some weak movements in the caudal end of the body, but its proximal end was dead. I tried to save the caudal end by cutting it off from the proximal half of the body, but notwithstanding it died next day.

EXPERIMENTS, SERIES III

This series was undertaken with the purpose of finding out whether it were possible to preserve the exsiccated worms and how long at normal temperature. To this end I placed them, after drying in sterilized test-tubes corked with cotton, with a cork and covered with melted paraffin.

The results of the exsiccation are given below (table 5):

TABLE 5

NUMBER	DATE OF THE FIRST WEIGHING	WEIGHT OF THE LIVING WORM	DATE OF FINAL WEIGHING	HOURS OF EXSICCATION	WEIGHT OF THE EXSICCATED WORM	LOSS OF WATER IN PER CENT OF WEIGHT
		grams		hours	grams	
1	2 VIII 12h	1.2478	4 VIII 11h	47	0.6783	45.6
2	2 VIII 12h	1.0244	4 VIII 11h	47	0.5289	48.3
3	2 VIII 12h	0.8028	3 VIII 19h	31	0.3946	50.8
4	2 VIII 12h	0.9067	3 VIII 19h	31	0.5007	44.8
5	2 VIII 12h	0.6986	3 VIII 19h	31	0.3552	49.1
6	2 VIII 12h	0.9241	4 VIII 18h 30'	54½	0.4946	46.4

After preservation in test-tubes for twenty-four hours, worms nos. 1 and 3 were placed 5 VIII 11h on moistened filter-paper. Both had died and did not revive. On the four other worms I detected in the morning 6 VIII many white spots—colonies of bacteria. The earthworms placed on filter-paper had all died undoubtedly by infection with bacteria.

This series shows that *it is impossible to preserve for a long time the exsiccated earthworms at normal temperature*, as it is certainly impossible to sterilize them—their gut and body being full of microorganisms.

EXPERIMENTS, SERIES IV

The purpose of the fourth series was to establish more precisely the limit to which the earthworm can be exsiccated without loss of vitality. The experiments were arranged in the same manner as in series I and II. The worms were dried in glass dishes covered with muslin.

The results are given in table 6.

TABLE 6

NUMBER	DATE OF THE FIRST WEIGHING	WEIGHT OF THE LIVING WORM	DATE OF FINAL WEIGHING	HOURS OF EXSICCATION	WEIGHT OF THE EXSICCATED WORM	LOSS OF WATER IN PER CENT OF WEIGHT
		grams		hours	grams	
1	7 VIII 13h	1.5272	9 VIII 19h 36'	54½	0.5775	61.6
2	7 VIII 13h	0.5798	8 VIII 13h	24	0.1539	73.4
3	7 VIII 13h	0.7328	8 VIII 16h	27	0.2825	61.4
4	7 VIII 13h	0.5165	8 VIII 13h	24	0.1965	61.9
5	7 VIII 13h	0.5842	8 VIII 16h	27	0.1725	70.4
6	7 VIII 13h	0.5782	8 VIII 13h	24	0.2334	59.6

After the exsiccation was finished the worms were placed at once on moistened filter-paper. The revivification went on in different ways.

Worm no. 1 was dried slowly and with an interruption (from 8 VIII 20h to 9 VIII 11h I kept it outside of the desiccator placing the glass dish directly under a glass bell); it was completely motionless after the drying, but its body was smooth, elastic, and without crust-like skin. Placed on moistened filter-paper on 9 VIII 19h 40', it had revived completely by the next morning, had a normal appearance, and displayed very energetic movements. Its weight was 1.3067 grams—nearly the same as before the exsiccation. Placed on earth, it dug itself in at once. On 11 VIII 11h it was placed once more on filter-paper, and after some hours I noticed that several of its posterior segments (15 to 20) were twisting themselves away from the body and were lost; certainly, they had suffered from the drying. Nevertheless, the worm was alive, and 12 VIII I used it for the second time for the experiments of exsiccation (cf. series VII).

Nos. 2 and 5 were overdried, and placed on moistened filter-paper became only swollen. No. 5 showed some signs of life in the caudal end of the body, but died also.

Worm no. 3 retained the cylindrical form of its body and was smooth. Its body was elastic, dark brown, and covered with a hard skin. Placed on moistened filter-paper 8 VIII 16h it became after 40' swollen, and exhibited slow contractions when touched with the forceps. At 18h 30' its body displayed spontaneous contractions, but at 19h 30^s I noticed that the middle part of the body had become necrotic—the blood was flowing and staining the filter-paper red. Next morning (9 VIII 11h) the upper part of the body moved energetically, but the caudal end died and showed blood effusion.

Worm no. 4 after drying was in its proximal part dark, and was covered with a crust-like skin; its caudal end was not so dark and more elastic. Placed on moistened filter-paper on 8 VIII 14h it exhibited at 15h 30' some slow contractions in the caudal end. At 16h the contractions were noted also in the proximal end. At 18h 30' the caudal end contracted energetically, the proximal

one slowly. Next morning (9 VIII 11h) the proximal end was dead, the caudal end showed signs of life and contractions. At 13h the worm died completely. This case demonstrates very clearly, that its death was caused by the overdrying of the proximal end of the body, which became necrotic and, infected by microorganisms, infected also the revived caudal end.

Worm no. 6 had left the glass dish during the exsiccation and was overdried in some parts of the body. Being revived it displayed some movements, but swellings had formed here and there on its body. Its head revived and moved energetically, but in a short time the worm had succumbed.

The experiments of this series have shown, that earthworms *can revive after the loss of even 61.6 per cent of the weight of the body; i.e. of 73 per cent of the full quantity of water in the organism!* But the revivification takes place only under favorable conditions of exsiccation, probably when it proceeds equally and gradually. When the exsiccation was too rapid, some parts of the body were overdried and the skin became crust-like. In this case evidently the blood-vessels of the skin burst during the swelling and the blood flowed out. This blood effusion caused, as it seems, an infection with microorganisms and the overdried part of the body perished, causing the death of the worm. This explains the death of worms nos. 3 and 4, when some parts of the body were revived and showed energetic movements.

If the loss is more than 70 per cent of the weight of the body—i.e., more than 83 per cent of the whole quantity of water—the worm does not revive, but sometimes, nevertheless, it showed weak movements, as, for instance, no. 5. If the exsiccation was not equal and uniform in the whole body, the death of the worm was possible even at the loss of less than 60 per cent of the weight of the body (for instance, no. 6).

EXPERIMENTS, SERIES V

The fifth series was a continuation of the third series. As the worms kept in the test-tubes died evidently through infection with microorganisms, I determined to try whether the dried worms could not be preserved at a low temperature. To this

end the worms were placed after the exsiccation in test-tubes upon the ice of an ice-house, where the temperature was about $+1^{\circ}\text{C}$.

The results of the drying are given in table 7.

TABLE 7

NUMBER	DATE OF THE FIRST WEIGHING	WEIGHT OF THE LIVING WORM	DATE OF FINAL WEIGHING	HOURS OF EXSICCATION	WEIGHT OF THE EXSICCATED WORM	LOSS OF WATER IN PER CENT OF WEIGHT
		<i>grams</i>		<i>hours</i>	<i>grams</i>	
1	10 VIII 17h	0.5066	11 VIII 14h	21	0.1967	61.1
2	10 VIII 17h	0.7472	11 VIII 18h 30'	25½	0.3206	57.0
3	10 VIII 17h	0.5003	11 VIII 17h	24	0.1677	66.4
4	10 VIII 17h	0.5605	11 VIII 14h	21	0.2150	61.6
5	10 VIII 17h	0.5084	11 VIII 14h	21	0.2167	57.3
6	10 VIII 17h	0.6656	12 VIII 20h	51	0.2527	62.0

Worms nos. 1, 4 and 5 were placed after drying in test-tubes and carried to the ice-house. Worms nos. 3 and 6 were placed immediately on moistened filter-paper. No. 2 was left in the laboratory at the normal temperature of about 20°C . (in daytime).

The worms placed upon the ice (nos. 1, 4, and 5) were kept there for fifty-one hours (till 13 VIII 16h 20') and seemed then to be completely normal without signs of infection. Nevertheless, the revivification was unsuccessful. Placed on moistened filter-paper 13 VIII 16h 30' they displayed at 17h weak movements in the proximal end and in the tail.

Worm no. 1 at 18h 45' exhibited energetic contractions of the proximal end, but its tail moved weakly and the middle part of its body was motionless. Worm no. 4 was dead. No. 5 displayed energetic contractions in the tail and in the head, but the middle part of the body with clitellum had died.

Next day (14 VIII 10h 30') the proximal end of worm no. 1 and its tail contracted very energetically, but the middle part of the body died. Clitellum showed blood effusion and the filter-paper beneath was red. The proximal end and the middle part of the body of worm no. 5 died, but its tail contracted. In the evening 14 VIII both worms were definitely dead.

The ill success of these experiments was caused, I believe, by the fact that I had occasionally used earthworms with clitellums. The skin of the clitellum is very delicate and full of blood-vessels, which suffer from the exsiccation and cause the blood effusion and infection.

The revivification of the control worms nos. 2, 3, and 6 also yielded nearly negative results. Worm no. 2, preserved in a test-tube at normal temperature during twenty-four hours, was placed on 12 VIII 18h 50' on moistened filter-paper. It seemed to be in a good state of preservation and showed no signs of infection. But as it was swollen, only some weak contractions of the caudal end were seen, and at the proximal end white swellings appeared, as a sign of infection. On the morning 13 VIII the worm was dead.

The worm no. 3 was exsiccated too quickly and overdried. It showed no signs of life and at the proximal end a blood effusion was observed.

Worm no. 6 proved to be overdried at the proximal end, evidently also because there was a clitellum. The caudal two-thirds of the body was revived and moved energetically, but the proximal third perished. After twenty-four hours the whole worm was dead.

This fifth series of experiments has nevertheless shown, that *the worms which have lost not more than 61 per cent of the weight of their body, if preserved at low temperature, retain their vitality during forty-eight hours.* Their revivification was only partly obtained, but this depended upon secondary causes, which could be avoided. Unfortunately, lack of time prevented me from repeating this series of experiments with all necessary precautions, needed after the foregoing ill success. Earthworms without clitellum should be taken and exsiccated more slowly and gradually.

EXPERIMENTS, SERIES VI

The sixth series was undertaken with the view of studying the influence of exsiccation effected at low temperature. The worms were put into small glass-tubes and placed into a desiccator that stood on the ice in the ice-house. The small size of the glass tubes caused a very slow exsiccation of the worms.

The results of the exsiccation were as follows (table 8).

TABLE 8

NUMBER	DATE OF THE FIRST WEIGHING	WEIGHT OF THE LIVING WORM	DATE OF FINAL WEIGHING	HOURS OF EXSICCATION	WEIGHT OF THE EXSICCATED WORM	LOSS OF WATER IN PER CENT OF WEIGHT
		<i>grams</i>		<i>hours</i>	<i>grams</i>	
1	13 VIII 13h	0.6351	16 VIII 15h 30'	75½	0.2965	53.3
2	13 VIII 15h	0.4306	17 VIII 18h	99	0.1740	59.5
3	13 VIII 15h	0.4180	17 VIII 18h	99	0.1717	59.0
4	13 VIII 13h	0.3294	14 VIII 19h	30	0.1196	63.6

Worm no. 1, placed 16 VIII 15h 30' on moist filter-paper, showed at 16h 40' energetic contractions of the body, and in the evening (19h) had completely revived.

Worms nos. 2 and 3 placed 17 VIII 18h 15' on moist filter-paper showed at 18h 35' the first contractions of the proximal part of the body. At 18 VIII 10h both worms were completely revived and moved with great energy.

Worm no. 4 placed on moist filter-paper at 14 VIII 19h 30' showed contractions at 22h, but died next morning (15 VIII 11h).

This sixth series shows, that the combination of exsiccation and low temperature gives the most satisfactory results. Owing to the slowness of the exsiccation and the retardation of the activity of microorganisms the treatment affects the vitality of the worms in a very small degree and the loss of water is easily endured.

Lack of time has not allowed me to repeat this series of experiments and to try the preservation of earthworms exsiccated in this manner at a low temperature. It is possible that the results might be more successful than in the foregoing series.

EXPERIMENTS, SERIES VII

In this last series I intended to try the exsiccation of worms that had already undergone this operation and had been revived. But I could use for this purpose only worm no. 1 of series IV.

This earthworm was weighed on 12 VIII 19h and its weight was 1.2610 gr.—the diminution of its weight as compared with

its weight on 7 VIII 13h (cf. IV series) was caused by the loss of its posterior segments after the first exsiccation (p. 10). Placed in the desiccator on 12 VIII 19h, it was kept there until 14 VIII 19h (i.e., forty-eight hours) and its weight diminished on 0.4679 grams or 62.6 per cent of the weight of its body. At 19h 30' it was placed on moistened filter-paper and at 22h some contractions and movements of the proximal end and of the tail were observed. But on the next morning (15 VIII 11h) it was found dead. On the proximal end hemorrhage and swellings could be seen. It is possible that the exsiccation had surpassed the limit or had gone on too rapidly.

This experiment is of course not sufficient for denying the possibility of repeated revivification of earthworms.

CONCLUSION

All the mentioned experiments, which for lack of time I had no possibility of finishing, prove, as I believe, that the phenomena manifested in the exsiccation of earthworms are completely analogous to the results of exsiccation of Tardigrada, Rotatoria, and Nematodes, and with full right may be called 'anabiosis' ('over-life').

Actually by the exsiccation the earthworms lose completely their mobility, their size diminishes to one-half or one-third of their length and volume and they show no manifestations of life. In the dorsal vessel, sometimes well seen through the skin, no contractions can be detected with a microscope. The segments of the body are also completely motionless. The exsiccated worm is dark brown, but must retain the elasticity of its body and its skin must be soft if it is to revive. It has the appearance of a corpse or a mummy. In this state the worm can retain the capacity for revivification for thirty-nine hours at normal summer temperature (cf. worm no. 1 of the experiments in series 1) and according to series V and VI, for 48 hours, and perhaps more, at low temperature. It is possible, that at suitable low temperatures one can preserve the vitality of the exsiccated worms during a very long time. I shall undertake experiments in this direction at the first opportunity.

Thus, only one difference can be stated in the earthworms as compared with the other groups of anabiotic animals—it is that they are not so amenable to continued preservation in the exsiccated state at normal temperature. This is evidently accounted for by the more complicated organization of worms and the presence of a more highly organized blood system, as well of a large quantity of microorganisms in the gut. The exsiccation of the skin carried on too far destroys its capillary vessels and causes the blood effusion. The microorganisms of the gut and of the surface of the body, multiplying under favorable conditions, bring about the death of the worm.

While showing a full analogy to the anabiosis of Rotatoria, Tardigrada, and Nematodes, the phenomenon of exsiccation of the worms has the practical advantage of affording the possibility of determining the amount of the loss of water contained in the body of the worm. And in this direction I have discovered a fact, which seems to be of great interest: a very large percentage of water can be lost without the complete loss of vitality.

As my experiments (cf. series IV, worm no. 1) have evidenced, *earthworms can revive and regain the normal state of life after a loss of 61.6 per cent of the weight of the body, or nearly 73 per cent of the weight of the water contained in the body.*

If we take into consideration that the organization of the earthworm is comparatively infinitely more complicated and therefore more delicate than the organization of Rotatoria, Tardigrada and Nematodes, we can readily admit, that these microscopical animalcules may have the capacity to revive after having lost 80 to 85 per cent of the amount of water in their bodies, or perhaps even more.

This consideration throws some light on the seeming mysteriousness of the phenomenon of anabiosis that was discovered more than 200 years ago, but till now no known analogy in the higher groups of the animal kingdom.

LITERATURE CITED

- BAKER 1764 *Employments for the microscope.*
- BROCA, P. 1860 a *Études sur les animaux resuscitants.* Presse Scientifique, T. 1, pp. 211-222.
1860 b *Rapport sur la question soumise à la Société de Biologie au sujet de la reviviscence des animaux desséchés.* Paris. *Mémoires de la Société de la Biologie*, T. 2, pp. 1-140.
- DAVAINE, C. 1856 *Recherches expérimentales sur la vitalité des Anguillulides du blé niéllé.* Paris. *Comp. Rend. Ac. Sc.*, 43, pp. 148-152; *Ann. Nat. Hist.*, 18, pp. 268-269.
- DOYÈRE 1842 *Mémoire sur les Tardigrades.* *Annales des Sc. Naturelles*, Paris, II ser. T. 18 (Zool.), pp. 5-35.
- FROMANTEL, E. DE 1877 *Recherches sur la revivification des Rotifères, des Anguillulides et des Tardigrades.* *Associat. Franç. p. l' avanc. d. sciences.* C. R. de la VI sess. Le Havre, pp. 641-657.
- GAVARRET, M. 1859 *Quelques expériences sur les Rotifères, les Tardigrades et les Anguillulides des mousses des toits.* *Ann. d. Sc. Natur.* Paris, IV ser. T 11 (Zool.), pp. 315-330.
- LEEUWENHOEK, A. 1701 *Epistolae ad Societatem Regiam Londinensem*, vol. 2, p. 381 ss. *Lugd. Bat.*
- NEEDHAM 1745 *New microscopical discoveries.* London 8°.
- PLATE, L. 1885 *Beiträge zur Naturgeschichte der Rotatorien.* *Jenaische Zeit. f. Nat.*, Bd. 19, p. 113.
- PREYER 1891 *Über die Anabiose.* *Biolog. Centralbl.*, Bd. 11, no. 1, 2.
- SPALLANZANI 1777 *Opuscules de Physique animale et végétale.* Trad. par J. Sennebier, T. 2, p. 224 ss.
- SCHMIDT, P., ET STCHEPKINA, T. 1917 *Sur l'anabiose des vers de terre.* *Comp. Rend. Soc. Biol.*, Paris, 1917, pp. 366-368.
- SCHULZ, E. 1915 *On some investigations upon anabiosis (in russ.).* *Isvest. Petrogr. Biol. Labor.* (Bulletin du Laborat. Biologique de Petrograd), vol. 15, pp. 81-86.
- ZACHARIAS, O. 1887 *Können die Rotatorien und Tardigraden nach vollständiger Austrocknung wieder aufleben oder nicht?* *Biolog. Centralbl.*, Bd. 6, pp. 230-235.

STUDIES OF NORMAL MOULT AND OF ARTIFICIALLY INDUCED REGENERATION OF PELAGE IN PEROMYSCUS

H. H. COLLINS

Scripps Institution, La Jolla, California

FIFTEEN FIGURES

CONTENTS

1. Introduction.....	73
2. The postjuvinal moult.....	76
3. Later moults.....	81
4. Regeneration of pelage in juvinal mice.....	81
5. Regeneration of adult pelages.....	86
6. Discussion.....	88
7. Summary.....	94

1. INTRODUCTION

It is a matter of common knowledge among naturalists that many birds and mammals undergo more or less marked changes in appearance as the result of moult. These moults may mark different stages in the life cycle of the individual or they may be seasonal in character.

In general the greatest changes in appearance are incidental to the transition from the juvinal to the adult. Especially among birds, there are many species in which the differences are quite striking.

To quote Allen ('94a) in regard to Passerine birds:

This 'first' or 'nestling' plumage can usually be recognized by its loose, fluffy texture, as compared with that of adult birds of the same species, even though the coloration may be similar; but generally it differs notably also in color, and often in pattern of markings, from that which immediately succeeds it, or from any plumage which may be afterward acquired. Familiar illustrations are furnished by the robin and the bluebird, where the first plumage is so strikingly unlike, both in color and markings, that of the adult bird of either sex (p. 92).

In a later paragraph, he says, "Although this first plumage is particularly interesting and instructive, affording frequently clues to ancestral relationships, it has not until recently attracted the attention it deserves, even among 'professional' ornithologists."

Whitman ('04) in his work with pigeons, appears to have regarded the comparative study of juvenal plumages as highly important in tracing phylogenetic relationships. On the other hand, it is said that closely allied subspecies sometimes differ more at this early stage than at any later period. Apparently there is still much to be learned concerning the real significance of first plumages.

Though the general features of the change of pelage have been described in many of the mammals, the ornithologists seem to have proceeded somewhat farther in the study of the details of the process.

Dwight ('00), in a study of the Passerine birds of New York, writes as follows:

The plan on which a moult proceeds is a perfectly definite one, although often much modified and obscured. Old feathers or rows of feathers tend to remain until the newcomers adjacent have matured sufficiently to assume their function, when the old fall out and their places are taken by the new which develop from the same papillae.

The systematic replacement of areas of feathers shows most obviously in the wings where not only do the remiges fall out one after another in definite sequence and almost synchronously from each wing, but the greater coverts are regularly replaced before the fall of the secondaries beneath them, the lesser coverts before the median and even in the rows of the lesser coverts alternation seems to be attempted. . . . On the body the protective sequence is less obvious, but the moult regularly begins at fairly definite points in the feather tracts radiating from them in such manner that the outer rows of feathers where the tracts are widest and the feathers of their extremities are normally the last to be replaced (pp. 83, 84).

Furthermore, Dwight found a regular sequence in the development of the various feather tracts, although in young birds an outbreak of moult in any of the tracts earlier or later was less unusual.

Although, as a rule, the moult proceeds so gradually and so simultaneously on opposite sides of the body that the power of

flight is not impaired, there are cases in which the process is not so plainly adaptive.

The Duck family (Anatidae), among others, according to Coues, drop their wing quills so nearly simultaneously as to be for some time deprived of the power of flight.

The details of the process of moult are not so well known in the case of mammals. However, it appears that in general the process is more irregular than in birds. According to Allen ('94): "As a rule, particularly among the Rodentia, the change becomes first apparent on the feet and about the nose extending gradually up the limbs and over the head and from the base of the tail anteriorly, and from the sides of the body toward the median line." This appears to be the usual method especially in the spring moult, but the process is said to be "subject to much irregularity, even among individuals of the same species, and it seems to vary somewhat in different groups" (p. 107).

In describing the condition in rabbits Nelson ('09) says that "the moults usually begin about the head and feet and proceed more or less irregularly over the body, but there is no absolute rule, and patches of new pelage may appear on any part of the body, especially if the old coat has been thinned by abrasion or other local cause" (p. 30). However, it appears that certain other students of the genus do not find the process of moult as irregular as described by Nelson.

According to Barrett-Hamilton ('12), the order of change in the European hares, though not invariable, generally follows a fairly regular sequence. In the autumnal moult, the feet and legs, the gray parts of the ears and parts of the head are first to undergo the change. Then follows the rump, and the white area of the ventral surface gradually creeps upward on the sides until the brown of the summer coat is extinguished or remains as a "small island or islands." In the spring the sequence and directions of growth are completely reversed, the new pelage appearing first on the head and median dorsal region, growing downwards. This same reversal is described by Allen in his paper on the changes of pelage of the varying hare (*Lepus americanus*).

Passing to the Muridae, it may be said that although certain species of this group have long been reared in captivity and used extensively in experimental work, very little is known concerning their changes of pelage. Probably the most complete account is that of Osgood ('09) in his monograph of the genus *Peromyscus*.

As stated by Osgood, the mice of this genus pass through three fairly distinct phases due to age—the juvenal (young in first coat), the adolescent, and the adult. According to his description of the assumption of the postjuvenal or adolescent pelage, "This [i.e., juvenal] stage is succeeded by the adolescent pelage, which first appears on the middle of the sides. Its growth proceeds rapidly upward on each side until union is effected in the middle of the back, and then incloses the rest of the body, the rump and nape, usually being the last parts to be covered" (p. 20).

With reference to seasonal changes, he says:

The new pelage may be acquired in regular and obvious manner with the fresh coat well distinguished from the old worn one, the growth proceeding from before backward and the middle of the rump being the last part to be invested, or the change may be quite insidious and apparent only upon careful examination. The regular method is followed in the adults of most species, while the other is more often evident in immature individuals (p. 19).

My own observations in this field have been, in the main, confined to a few species of this same genus. During the past year and a half I have devoted considerable attention to a study of the seasonal and life-cycle changes in the pelage of several races of California deer-mice, reared in the murarium of the Scripps Institution. It is the purpose of the present paper to discuss, somewhat in detail, the normal process of moult, especially with reference to the assumption of the postjuvenal pelage, and, furthermore, to describe certain modifications of this process experimentally induced.

I take this occasion to express my sincere thanks to Dr. F. B. Sumner for many valuable suggestions and criticisms.

2. THE POSTJUVENAL MOULT

The description of this moult is based upon an examination at weekly intervals of a series of twenty specimens of the first cage-born generation of *Peromyscus maniculatus gambeli* (Baird).

Frequent examinations, somewhat more at random, were also made upon the general stock, including the subspecies *sonoriensis* (Le Conte) and *rubidus* Osgood, as well as a few specimens of *P. eremicus fraterculus* (Miller) and *P. californicus insignis* Rhoads. By etherizing the animals and parting the fur, it was possible to follow the moult from the time of the first appearance of the new hairs through the skin.

At birth the body is devoid of hair and pigment except for the vibrissae and supraorbital cilia. On the second day the upper parts begin to assume a bluish-black color and the hair may be seen coming through the skin of the pigmented area. A day or two later, the ventral white hair may be observed.

At the age of four to five weeks, the young are, as a rule, in full juvenal pelage. There are no further traces of pigment in the skin, which is now flesh color. This pelage, like the later ones, is made up of a fine soft underfur and a thinner coat of much longer and coarser overhair. As is the case in the adult pelages of many other rodents, the hairs of the underfur are banded or ticked (agouti), being of a blackish plumbeous or slate color basally, with a narrow subterminal zone of pallid mouse gray, while the tips are black.¹ The overhairs are not of the agouti type, lacking the subterminal band. The general effect on the dorsal surface may be described as between neutral and deep neutral gray.

The juvenal pelage of the ventral surface, like that of the dorsum, is made up of underfur and overhairs. Basally, the color is the same as in that of the dorsal surface, but the distal region is white. The lateral line of demarcation between the dorsal and ventral surfaces is very sharply defined (fig. 5).

The microscopic structure of the hairs in the juvenal pelage is essentially the same as described by Sumner ('18) for the adult. There is, however, a very evident difference in the proportionate number of the different kinds of hairs. The slender hairs with but a single axial row of pigment bodies, alternating with the air spaces, are much more numerous, while the yellow pigment is much reduced in the subterminal bands. The overhairs are

¹ Color descriptions are based on Ridgway's key.

attenuated at the base, being no larger at this level than the hairs of the underfur. Both kinds of hairs are very much flattened, but the larger ones show no local attenuations such as are described by Barrett-Hamilton ('16) for *Mus musculus*, though this appearance may be simulated by torsion.

In microscopic structure, the vibrissae are markedly different from the hairs just mentioned. Though these are the largest hairs on the body, there is but one axial row of lacunae containing a relatively small amount of pigment. Most of the pigment occurs in the cortex as small granules arranged in longitudinal striae. This cortical pigment extends to the base, but gradually disappears toward the tip. This is the reverse of the arrangement in the body hairs, in which the greater part of the pigment is found in the axial region arranged in from two to four rows of lacunae in all except the smallest hairs. Furthermore, in the body hairs, the cortical pigment, which is restricted mainly to the superficial region of the cortex, is most dense in the terminal zone, gradually disappearing toward the middle region. The lower vibrissae are devoid of pigment almost or quite to the base, but this terminal white region becomes much reduced dorsally. The structure of the two supraorbital cilia and of the hairs of the tail is similar to that of the vibrissae. In certain pelage removal experiments to be described later, it will be noted that vibrissae and body hairs are not regenerated in the same manner. This fact suggests the possibility of some sort of correlation between the morphological and physiological differences.

The transition from the juvenal to the postjuvenal pelage usually begins at the age of six weeks and is completed about eight weeks later. The new pelage first appears on the throat near the angle of the jaw, or rarely on the anterior surface of the forelimb along the lateral line.² Growth proceeds toward the median ventral line of the head and, at the same time, anteriorly under the eye and ear and posteriorly over the forelimb and shoulder. From these regions, it passes posteriorly above the ventral white to the hind limbs, at the same time creeping up toward the dorsal median line (figs. 1 to 3).

² The line of demarcation between the white hair of the ventral surface and the dark hair of the dorsum.

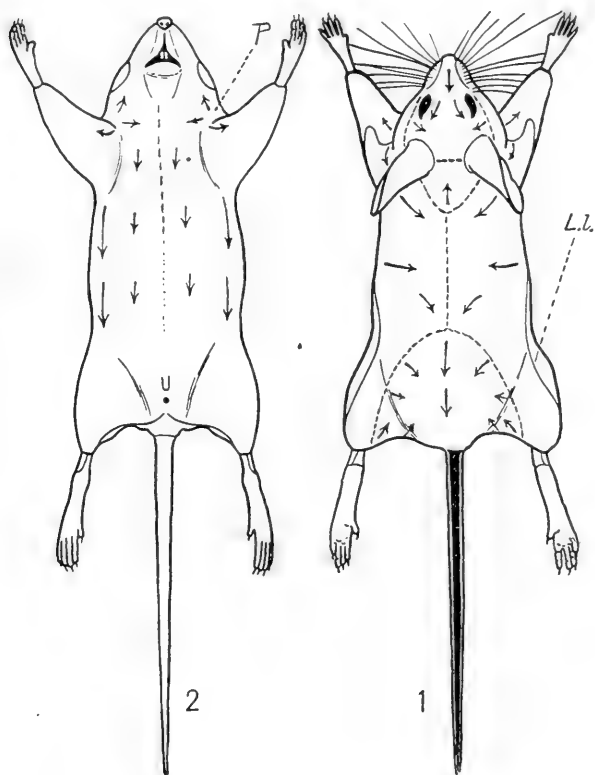

Figs. 1 and 2 Diagrams of the dorsal and ventral surfaces, showing directions of growth in the postjuvinal moult of *P. maniculatus gambeli*. The regions on which moult proceeds more or less independently are shown by the dotted lines. The longer arrows indicate more rapid growth. *L.l.*, lateral line; *p.*, point of origin.

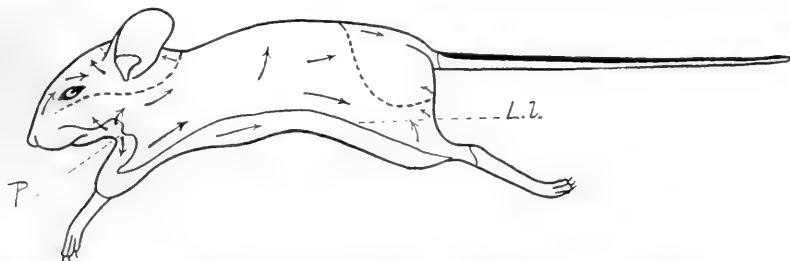

Fig. 3 Diagram of lateral surface, showing directions of growth in the postjuvinal moult of *P. maniculatus gambeli*. Symbols as in figures 1 and 2.

The moult may be well under way before there are any evidences of it on the surface. The details of the process can be learned only by parting the overlying juvenal pelage and observing the new hair as it comes through the skin. The new postjuvenal pelage is first seen on the surface, usually on the forelimbs, and somewhat later as triangular areas on the sides. These lateral areas gradually become confluent, first, as a rule, just posterior to the shoulders (figs. 5 and 6).

After this 'saddle phase' (fig. 6) has been reached, further growth for days or weeks may be limited to the region posterior to the saddle. The direction of growth is posterior and, at the same time, upward on the hind limbs from the lateral line, the region above the base of the tail being the last to undergo the change (figs. 3, 7, 8).

On the ventral surface, the moult is regularly completed before that of the dorsum. As shown in figure 2, growth proceeds from the throat posteriorly. In many cases, there may be no superficial indications of the change, though in some instances a definite moult line³ may be observed.

The moult is now completed over the whole body surface, except the region extending on the dorsal surface from the tip of the snout to the shoulders. The investment of this area may occur soon after that of the rump, but usually only after an inactive period which in extreme cases may be as long as two months.

In this region the postjuvenal pelage first appears, anteriorly, on the tip of the snout, passing posteriorly to the eyes, thence as two diverging strips to the anterior insertions of the ears, the intervening space being filled in by lateral and posterior growth (fig. 1). Posteriorly, the moult line moves from the shoulders forward toward the ears, where the two areas coalesce. Growth in the two directions may occur simultaneously or that of one region may be slightly in advance of the other.

The postjuvenal pelage is somewhat longer and coarser, though still shorter than that of the adult, which it closely resembles in color and texture. The general color effect is quite different from that of the juvenal. It may be described as varying from

³ The line separating the old and new pelages.

Saccardo's umber to sepia, with the dorsal median stripe more or less strongly marked with black. This difference in the general color of the two pelages appears to be due mainly to the increased amount of yellow pigment in the subterminal bands of the postjuvénal hairs.

The postjuvénal moult of two other races of California deer-mice (*P.m. sonorienses* and *rubidus*) as well as in a 'yellow' mutant of *gambeli*, which appeared about two years ago in the murarium stock is essentially the same as above described.

In two other species of *Peromyscus* (*californicus insignis*, and *eremicus fraterculus*) which occur in the vicinity of La Jolla, the process is quite similar, but upon a closer examination there appear to be certain characteristic differences in the points of origin and directions of growth.

3. LATER MOULTS

In general, in the assumption of the adult pelage and in the seasonal moults, the process is the same as above described. However, these later moults appear to be somewhat more irregular, and frequent partial moults further complicate the situation. These moults will be treated more at length in a later paper.

4. REGENERATION OF PELAGE IN JUVENAL MICE

After having observed the rather marked regularity in points of origin, sequence, and directions of growth, in the assumption of the postjuvénal pelage, it seemed worth while to determine to what extent, if at all, the process might be modified by the artificial induction of regenerative processes.

In the series of experiments here described, a total of about forty *gambeli* were used, varying in age from two and one-half to seven weeks. The mice were etherized and the pelage was removed by plucking out with the fingers. The hair is quite loose, especially just previous to a moult, and may be very readily removed in this manner without injury to the skin.

Except in those cases where the moult was too far advanced, the following regions were operated on in every individual:

1. The dorsal median region of the head from the tip of the snout to the base of the skull.
2. The hips and thighs.
3. About 1 sq. cm. between and anterior to the forelimbs.
4. About 1 sq. cm. in the midventral region, just anterior to the hind limbs.

Although individual differences were in some cases quite noticeable, in general the mode of replacement on the depilated areas was much the same.

The history of one brood (offspring of ♀ 106) may be regarded as fairly typical. The three members of this brood were operated upon, as outlined above, at the age of eighteen days. At that time they were in full juvenal pelage. Without exception, the skin of the posterior half of the dorsum was still dark—an indication that the growth of the juvenal hair was still in progress.⁴ The denuded areas on the head and ventral surface, however, were devoid of pigment.

Two days later, the pigment in the skin of the dorsum had almost entirely disappeared, except on the exposed area on the hips. Here a rather striking effect was observed. The skin was as dark as when the pelage was first removed, the line of demarcation between the two areas being very clearly defined.

On the seventh day, the exposed skin on the head was beginning to darken. That of the hips was somewhat lighter than when last observed, though it was still much darker than the surrounding skin. On the ventral surface, there was a slight darkening of the skin of the posterior area.

Ten days after the operation, the pigment in the skin of the depilated region on the hips had not wholly disappeared. In the meantime the exposed skin on the head had become much more intensely pigmented. The throat patch remained flesh color, while the posterior ventral area was slightly darkened.

When the brood was examined on the seventeenth day, some rather marked individual differences were noted. In one case the depilated area on the head was entirely covered with post-

⁴ Normally, the pigment disappears and the skin becomes flesh color after the hair attains its full length.

juvenile pelage, about half grown out, almost uniform in length, though slightly longer posteriorly. Those of the ventral surface were also wholly covered with pelage of about uniform length. In the meantime the normal postjuvenile moult had appeared on the throat near the point of the jaw, extending under the ear and down on the anterior face of the forelimb entirely outside the depilated region and in typical fashion. At the same time postjuvenile pelage, barely through the skin, was found extending as a narrow band on the lateral line from the base of the tail to the forelimb on one side of the body, and from the hind limb to the forelimb on the other. Both strips were continuous with the new pelage coming in on the posterior ventral area. Never having observed this condition in a normal moult, I am inclined to regard the premature appearance of postjuvenile pelage in this region as an abnormality resulting from the operation. At this time the depilated area on the hips was still bare.

In the other two members of the litter the normal moult had not appeared by the seventeenth day. The depilated regions of the head were covered with a uniform growth of postjuvenile pelage, but the hip regions showed no indications of regeneration.

Within a few days postjuvenile pelage appeared on the hips where the juvenile pelage had been removed, and a month after the operation the new pelage on all the depilated areas was fully grown out. At this time both surviving members of the brood were approaching the 'saddle phase' of the normal moult (fig. 12).

A comparison of the foregoing description with that of the normal moult will show the marked extent to which the normal process has been modified by artificially induced regeneration.

If replacement on the depilated areas were to follow the normal sequence, the order would be as follows: 1) throat; 2) posterior ventral area; 3) dorsal lumbar region; 4) dorsal head region. Moreover, as already noted, the dorsal head region is normally invested some weeks after the appearance of the new pelage on the throat and forelimbs.

It will be observed that growth on the depilated regions is much more nearly simultaneous than is normally the case. Furthermore, the sequence is not the same. Regeneration on the

head precedes replacement on the hips and hind limbs—an inversion of the natural order. Growth is almost simultaneous on the two denuded areas of the ventral surface, while the pelage of the hips was last to be replaced.

It will be noted also that the mode of replacement on the head was radically different from the normal process. Typically, growth proceeds, *a*) dorsally, from the tip of the snout to the anterior insertions of the ears, or, in some cases, posteriorly to a point midway between the ears; *b*) from the shoulders, anteriorly over the back of the neck to the ears. In contrast to this condition, in regeneration the new hair appears almost simultaneously over the whole of the depilated area.

It is but natural to suppose that the normal process of growth would be less profoundly modified were regeneration to occur immediately before or during the normal moult. But this does not seem to be the case. In mice operated upon at the age of six weeks, with the normal moult well under way, regeneration occurred in essentially the same manner, as regards sequences and directions of growth. Even in an extreme case, in which the entire body except the head and rump were covered with postjuvénal pelage, replacement on the head was somewhat in advance of that on the rump. Replacement on the head was fairly uniform, though the snout below the eyes was last to be invested—an inversion of the normal condition.

In exceptional cases the normal order is not so completely disguised, as shown by the history of another brood (that of ♀ 105), the four members of which were operated upon in the same manner and at the same age as the former brood.

The first suggestion of the normal process, such as would occur without operation, appeared on the depilated area of the throat about a week after the hair was removed. Here there was a perceptible darkening at the point of the jaw and along the anterior face of the forelimb, thus outlining the region where the postjuvénal pelage normally first appears. At the same time the rest of the exposed area showed no signs of pigment formation. Within a few days incoming pelage appeared on this pigmented area, the rest of the region being covered some days later. Typi-

cally, as has been already indicated,⁵ replacement after depilation occurs simultaneously over the whole region.

A further reminder of the normal process was noted in the mode of regeneration on the head. Instead of the fairly uniform replacement usually observed after depilation, there were two independent centers of growth. Pigment (followed in a few days by the incoming hair) first appeared on the snout just below the level of the eyes, spreading anteriorly to the tip and posteriorly to a definite transverse line connecting the anterior insertions of the ears, the skin posterior to the line remaining unpigmented for several days. In another member of the brood pigment developed at the same time on the snout and back of the ears, leaving a small patch of pigmentless skin between them.

The incoming postjuvinal pelage does not ordinarily transgress the limits of the depilated region and, as a rule, the mode of change on the rest of the body surface remains unmodified. Occasionally, however, there is apparently some 'action at a distance.' One such case has already been cited.⁶ In another instance, where the juvinal pelage had been removed from the hips, the incoming postjuvinal, passing beyond the denuded region, extended anteriorly to the middle of the dorsum, meeting at this point the normal moult which was proceeding in the opposite direction. In other words, the normal direction of growth had been reversed on a part of the dorsum which had not been operated upon.

In all cases where the juvinal pelage was removed it was replaced by the postjuvinal. However, I have noted what at first appeared to be an abortive attempt to regenerate juvinal hairs.

During the week following the removal of the juvinal pelage (in those cases only in which the skin was dark at the time) a growth of fine short blackish hairs appeared on the denuded areas. This was succeeded in a few days by the incoming postjuvinal hair.

⁵ See page 83 above.

⁶ See page 83 above.

When subjected to microscopical examination, it was found that these hairs represented the basal portions of juvenal hairs, broken off in the skin at the time of the operation. In most cases, the tips plainly show evidences of fracture. It is interesting to note that in many of these hairs the localization of pigment has been modified to a marked extent.

Evidences of the segmental arrangement may be partially or wholly obliterated. The amount of pigment appears to be somewhat greater than in the normal hair at this level. This increase, however, may be more apparent than real, as a result of the more diffuse arrangement of the granules.

5. REGENERATION OF ADULT PELAGES

In addition to the foregoing studies of regeneration of hair in juvenal mice, a number of rather incidental observations were made on adults.

In order to facilitate the study of the details of normal moult, the old pelage was removed by clipping close to the skin. In all, seventeen adult gambeli were included in this series. Ten of these mice were clipped over the whole body, including head and limbs, while in the remaining cases the hair was removed from one side only. The mode of replacement was so irregular that the primary object of the experiment was not attained. However, the results from the point of view of regeneration may perhaps be of some interest.

Although obscured by various irregularities, there were some vestiges of the normal process. The first evidence of growth was seen, as a rule, on the throat and forelimbs. Replacement on the ventral surface preceded that on the dorsum, while, in general, the moult⁷ proceeded from before backward.

One of the most striking and characteristic departures from the normal process was the appearance of more or less numerous small isolated patches of hair over the posterior half or two-thirds of the body. These 'hair islands,' which were usually

⁷ Since the process includes the shedding of the clipped hair, the term 'moult' may properly be used in this connection.

more in evidence on the dorsal surface, appeared simultaneously with the new pelage on the throat and forelimbs.

Following this partial restoration after the new hair had attained its full length there were no further signs of regeneration for a period varying in different individuals from one to four months. Then new hair appeared at the same time on all the bare spots between the 'islands,' except on the rump, where, in most cases, replacement was still incomplete when the animals were last examined, five months after the operation.

Although there appears to be no subsequent growth of the body hairs, which were fully grown out at the time of the operation, it is worthy of note that the restoration of the vibrissae is accomplished by the elongation of the identical hairs which were cut. Although, as previously pointed out, there are certain structural differences between these two types of hairs, the cause of the difference in the mode of regeneration is not at all evident.

In those individuals in which the pelage was removed from one side only, the mode of replacement was essentially the same. Apparently, at least within these limits, there is no correlation between the rate and mode of regeneration and the size of the area operated upon.

While engaged in a study of seasonal changes in color due to fading, abrasion, and other causes, it seemed highly desirable to be able to compare old and new pelages on opposite sides of the body of the same individual. With this object in view, a series of twenty adult gambeli were trapped in worn and faded pelage, a few weeks prior to the autumnal moulting season. The animals were etherized and the old hair was plucked out on one side only, from the dorsal median line to the lateral line and from the tip of the snout posteriorly to the base of the tail. Although this series of experiments will be described more fully in a later paper dealing with color variations, they may be briefly mentioned here in connection with the topic of regeneration.

Replacement occurred much more rapidly than in the preceding series. With but one exception, complete restoration was accomplished one month from the date of the operation (fig. 15).

Replacement occurred at about the same time over the whole area, though that on the forelimbs and throat was slightly in advance and the hip and hind limb were covered last. With but few exceptions (probably not observed at the right time), 'hair islands' were seen particularly on the posterior part of the dorsum, but they were obliterated within a few days by the appearance of hair on the intervening patches.

The differences in the appearance of the two sides of the body are slight and in no case comparable with the contrast in the coloration of individuals representing buff and dark extremes within the species.

6. DISCUSSION

A study of the details of moult in living juvenal *Peromyscus* discloses a greater regularity in the process than appears to be characteristic of adult mammals in general.

It is found that the change occurs more or less independently on different parts of the body, suggesting tracts somewhat comparable to the pterylae in birds. This is most clearly seen in the method of moult on the dorsal surface of the head where growth proceeds from the neck anteriorly, and from the tip of the snout posteriorly to the ears. Then again, moult appears independently, although synchronously on opposite sides of the body.

While the marked regularity of replacement of feathers on the wings of birds may be regarded as an adaptation for the preservation of the power of flight, the sequence of moult on the various pterylae, of the body proper, and the similar phenomenon in mice as well could scarcely be interpreted in the same light. In this connection, Dwight ('00) writes as follows:

The important part that the blood supply plays in this plan appears to have been quite overlooked nor have I had the opportunity to fully investigate it. I may say, however, that the radiation of the moult from given points corresponds very closely to the distribution of the superficial arteries, beginning where the main trunks come to the surface and ending with their ultimate ramifications (p. 84).

This same idea is suggested rather indirectly by Schultz ('16), who regards the color markings of mammals as due to differen-

tials in growth which are due, in turn, to inequalities in the peripheral blood supply. We shall consider this theory more at length in the discussion of his studies of the regeneration of hair.

In the species of *Peromyscus* studied I find some deviations from the process of moult as described by Osgood ('09) in his monograph of the genus. With reference to the postjuvenal moult he writes: "This [i.e., juvenal] stage is succeeded by the adolescent pelage, which first appears on the middle of the sides" (p. 20). I do not find this to be the case in any of the three species examined. Another difference is in regard to the regions last invested. Instead of the "rump and nape usually being the last parts to be covered," the juvenal pelage normally persists on the head between and just anterior to the ears for days, often for weeks after the complete investment of the rump region. In these regards, the species in question do not appear to be typical of the genus.

The precocious appearance of feathers or hair characteristic of a later plumage or pelage has been mentioned by a number of observers. With reference to the varying hares, Allen ('94b) says:

In the case of wounds from fighting or other cause, resulting in the violent removal of large bunches of fur, it is interesting to note that in the autumn the new hair comes out white, often weeks in advance of the general change, and that in spring, under similar circumstances, the hair comes out brown, like the summer coat, much in advance of the general change from winter to summer pelage (p. 121).

A similar condition has been described by Schultz ('15) in the Himalayan rabbit. In this animal, which is a pink-eyed albino with black feet, muzzle, and ears, the black markings do not appear in the juvenal pelage. By plucking out the hair on one ear, Schultz obtained animals in which one ear was black while the other remained unchanged until the next pelage was assumed.

In the domestic fowl the secondary sexual feathers which are characteristic only of the adult plumage of the male may be caused to appear prematurely by plucking out the undifferentiated body feathers which precede them. According to Pearl and Boring ('14), "If the juvenile feather is removed from the follicle the next feather produced by that follicle will be the

secondary sexual feather, and not a feather of the juvenile type. After that all further regenerations are of the sexually differentiated feather" (p. 144).

I have occasionally noticed the premature appearance of post-juvinal pelage without operation in young mice which had lost a patch of hair before the time of the regular moult, or in places where apparently the juvinal hair had failed to appear.

In the course of his rather extensive studies of the regeneration of hair in rabbits, Schultz describes certain phenomena, similar to those which I have found to occur in mice.

For example, he found after shaving large patches on the dorsal and ventral surfaces of an adult black and tan rabbit that restoration was accomplished quickly on the ventral surface, while the depilated region on the dorsum, with the exception of a few 'hair islands,' remained bare for a year after the operation. On the other hand, when the pelage was plucked out, restoration was found to occur promptly at all seasons of the year and in animals of different ages.

As already pointed out in my account of the regeneration of adult pelages,⁸ the conditions are quite similar in the case of *Peromyscus*. In both animals the activation of the hair follicles is more readily accomplished when the mechanical stimulus is added to the effects of temperature upon the exposed skin.

Schultz regards the appearance of 'hair islands' as due to differences in the peripheral blood supply. Furthermore, he sees in this phenomenon an evanescent manifestation of the mottled color pattern, as seen, for example, in dappled gray horses.

Another of Schultz' experiments may be briefly mentioned because of its general bearing on his theory of animal coloration. In the Himalayan rabbit, according to his account, when white fur was plucked out it was replaced by black, although this color is normally limited to the feet, ears, and muzzle. The capacity for pigment formation seemed to be general and markings could be produced at will on parts of the body where they never occur in nature. In the course of his experiments, it became

⁸ See page 87 above.

evident, so he believed, that light played an important rôle in the production of pigment in the skin of the depilated surfaces. On the margins of the depilated areas, shaded by the surrounding fur, the regenerated hair was found to be white, while that in the partially shaded region was less intensely pigmented than the fully exposed central area. Furthermore, he describes having obtained hairs of the banded or agouti type by exposing the denuded skin to light at certain intervals only.

The experiments were repeated on a number of other rodents with negative results. Nevertheless, Schultz suggests that the differential coloration of the dorsal and ventral surfaces characteristic of many mammals may be due largely to differences in illumination.

While my own investigations have not as yet been carried far enough to warrant the formulation of an alternative hypothesis, it nevertheless appears obvious that the theories advanced by Dwight and Schultz are inadequate to account for some of the phenomena observed in the moults and color patterns of mammals.

Dwight's theory of the correlation between the distribution of peripheral blood-vessels, and the points of origin and the sequence of moult on different parts of the body of birds does not appear to be applicable in the case of mice. We should scarcely expect to find differences in the arrangement of superficial blood-vessels sufficient to account for the differences in points of origin of the moult observed in species of the same genus. But, more than this, the fact that, in regeneration following removal of pelage, the normal sequence is so markedly modified speaks against this hypothesis.

In no mammal are the differences in coloration of the dorsal and ventral surfaces more marked, nor are the two regions more sharply delimited than in some of the species of *Peromyscus*. The sharpest contrast is seen on the tail.

Whatever the rôle of light may have been in the evolution of this color pattern, it appears to be a negligible factor in its ontogenetic development. Since these animals are mainly crepuscular or nocturnal in habit, the growth of the hair occurs in diffuse light. Differences in illumination of the dorsal and

ventral surfaces are practically nil. Then, too, the dorsal surface of the tail is rarely wholly covered by the median stripe. Here, under identical conditions of illumination, heavily pigmented and pigmentless hairs develop side by side.

Furthermore, I have observed no differences in the color of hairs of the shaded margins and of the exposed central portions of depilated areas. The capacity for the production of hairs of the agouti type appears to be quite definitely confined to the dorsum, the position of the lateral line apparently being unaffected by the operation. Recognizing the fact that in a large number of cases the markings of animals obviously cannot be attributed to differences in intensity of illumination, Schultz has recourse to a second theory, namely, that such color markings are due to the inequalities in the peripheral blood supply. The black markings of the Himalayan rabbit are found on the extremities where the blood supply is somewhat reduced. The dorsal median stripe found in many mammals, in *Peromyscus* for example (figs. 7, 9, 15), is said to be due to the pressure on the skin of the underlying vertebrae, which impedes the circulation. The rings on a cat's tail overlie vertebral processes, and so on through the category. It must be pointed out in this connection that Schultz appears to be somewhat inconsistent in his application of this theory. In one paragraph we read:

Meine Ergebnisse, dass wachsendes Haar besonders für Farbstoffbildung geeignet ist, und zwar um so mehr, je lebhafter die Wachstumsvorgänge, sind eine Art Nachahmung der von Darwin bemerkten Naturerscheinung, dass weisse Taubenrassen unbefiedert, dunkle befiedert dem Ei entschlüpfen. Die Kaninchenalbinos, die ich hielt, schienen mir bei der Geburt auch so gut wie kahl, die farbig geborenen Rassen aber stärker behaart.

In vielen Naturmustern finden wir die stärksten Farbstoffanhäufungen gerade an Stellen, die durch stärkstes Haarwachstum gekennzeichnet sind, und an solchen Vorsprüngen und Ausbeutelungen der Haut, die zeitweilig stärker wachsen müssen als ihre Umgebung, z. B. Mähne, Schweif und Beine der Grauschimmel (p. 161).

However, in regard to the black markings of the Himalayan rabbit, he writes:

Betrachtet man die Russenkaninchen als Ganzes, so erhält man den Eindruck, dass an ihnen die mehr innen gelegenen Teile farblos bleiben, daher nicht nur die andern inneren Gewebe, sondern sogar die roten Augen, welche nach innen versenkt sind. Die dem Herzen ferneren, den Schädigungen der Aussenwelt und der schlechteren Durchblutung mehr ausgesetzten Teile, Nase, Schwanz, Ohren, Füsse, sind der Färbung verfallen, überhaupt neigt daher insbesondere die Haut zur Farbstoffbildung. Die inneren Organe scheinen gerade wegen ihrer besseren Durchblutung, geringeren Schädigung wegen Farblosigkeit zu besitzen (pp. 551 and 552).

That is to say, pigment formation is most pronounced where the processes of growth are most active, and at the same time, in regions having a relatively poor blood supply. From which it appears to follow that an adequate supply of blood tends to inhibit growth.

It appears that, at best, Schultz' theory of the relation of blood supply to pigmentation is applicable only in a limited number of cases. The list of exceptions is overwhelmingly large.

To cite a specific case, the hair on the feet of *Peromyscus* is pigmentless. This is characteristic of the genus, whence the name, 'white-footed mice.'

Furthermore, in many species of small mammals, individuals having white-tipped tails are of frequent occurrence. In the case of *Zapus insignis*, as cited by Miller ('93), this white-tipped condition has become characteristic of the species. In certain species of *Peromyscus*, Sumner ('18) describes the occasional appearance of the same character, and of pigmentless snouts as well. In the alternative inheritance of many color patterns, we are confronted by another category of facts which are not readily interpreted in the light of Schultz' hypothesis.

In conclusion, we may refer to the interesting and suggestive researches of G. M. Allen. This investigator has found that in general in mammals and birds, pigmentation centers in eleven separate areas, five paired, and one unpaired. Pigmentless markings are said to arise when contiguous areas fail to meet. Each area may vary independently.

Further investigations along these lines may go far toward clearing up some of the puzzling problems which one encounters in a study of animal coloration.

7. SUMMARY

1. The process of normal moult has been followed in a large series of living mice representing several species of *Peromyscus*.

2. In this study of the living material, the process of moult is found to be, in a measure, comparable in regularity of sequence and directions of growth with the moults of birds.

3. In the postjuvinal moult, growth occurs more or less independently on certain regions of the body, suggesting the mode of moult in the pterylae of birds.

4. The moults of adults are generally of a more irregular character.

5. In young mice the change of pelage is quite obvious, but in adults it may be quite insidious and evident only upon close examination.

6. In general, the process of moult is quite similar in different species, but in some instances there appear to be certain minor differences.

7. By plucking out juvenal hair, the precocious appearance of the postjuvinal pelage may be induced.

8. Under certain conditions, the appearance of this postjuvinal pelage, after artificial removal of the juvenal, is preceded by the outgrowth of an aberrant type of hair which persists only for a short time. Within these hairs the localization of pigment is abnormal.

9. The normal sequence of the incoming hair is profoundly modified by artificially induced regeneration.

10. Restoration of pelage in adults occurs irrespective of season, after the plucking out or clipping of the old hair.

11. This restoration is accomplished by the outgrowth of new hairs, except in case of the vibrissae, which are replaced by the elongation of the cut hairs.

12. Restoration is much more rapid when the hairs are plucked out than when merely cut.

13. The differences in coloration of the old and the new pelages as seen on opposite sides of the body of adult *gambeli* are

slight, never approaching the differences between individuals representing light and dark extremes within the species.

14. Light appears to be a negligible factor in the development of the differential coloration of the dorsal and ventral surfaces.

BIBLIOGRAPHY

- ALLEN, G. M. 1914 Pattern development in mammals and birds. *Amer. Nat.*, vol. 48, no. 571, July, pp. 385-412. no. 572, Aug., pp. 467-484; no. 573, Sept., pp. 550-566.
- ALLEN, J. A. 1894a First plumages. *Auk*, vol. 11, no. 2, Apr. pp. 91-93.
1894b On the seasonal changes of color in the varying hare (*Lepus americanus* Erxl.). *Bull. Am. Mus. Nat. Hist.*, vol. 6, pp. 107-128.
- BARRETT-HAMILTON, GERALD E. H. 1912 A history of British mammals. Part XII. London: Gurney and Jackson, pp. 304-306.
1916 A history of British mammals, Part XIX. London, pp. 600-648.
- COUES, ELLIOTT 1903 Key to North American birds. Vol. 1. Boston: Dana, Estes & Co., xli+535 pp.
- DWIGHT, JONATHAN, JR. 1900 The sequence of plumages and moult of the passerine birds of New York. *New York Academy of Sciences Annals*, pp. 73-360.
- MILLER, G. S. 1893 A jumping mouse (*Zapus insignis* Miller), new to the United States. *Proc. Biol. Soc. Washington*, vol. 8, pp. 1-8.
- NELSON, E. W. 1909 The rabbits of North America. Washington: Bureau of Biological Survey, North American Fauna, No. 29, 314 pp.
- OSGOOD, WILFRED H. 1909 Revision of the mice of the American genus *Peromyscus*. Washington: Bureau of Biological Survey, North American Fauna, No. 28, 285 pp.
- PEARL, RAYMOND, AND BORING, ALICE M. 1914 Some physiological observations regarding plumage patterns. *Science, N.S.*, vol. 39, pp. 143-144.
- RIDGWAY, ROBERT 1912 Color standards and nomenclature. Washington: published by the author, 43 pp., 53 pls.
- SCHULTZ, WALTHER 1915 Schwarzfärbung weisser Haare durch Rasur und die Entwicklungsmechanik der Farben von Haaren und Federn. I. *Arch. f. Entwm.*, vol. 41, p. 535-557.
1916a Schwarzfärbung weisser Haare durch Rasur und die Entwicklungsmechanik der Farben von Haaren und Federn. Ab. II. *Arch. f. Entwm.*, vol. 42, pp. 139-167.
1916b Schwarzfärbung weisser Haare durch Rasur und die Entwicklungsmechanik der Farben von Haaren und Federn. Ab. III. *Arch. f. Entwm.*, vol. 42, pp. 222-242.
- SUMNER, F. B. 1918 Continuous and discontinuous variations and their inheritance in *Peromyscus*. *Am. Nat.*, vol. 52, no. 616, Apr., May, pp. 177-208; nos. 618-619, June-July, pp. 290-301; nos. 620-621, Aug.-Sept., pp. 439-455.
- WHITMAN, C. O. 1904 The problem of the origin of species. *Congress of Arts and Science, Universal Exposition, St. Louis*, vol. 5, pp. 1-18.

PLATE 1

EXPLANATION OF FIGURES

4 to 9 show various stages in the postjuvénal moult of *P. maniculatus gambeli*.

4 Young in full juvenal pelage.

5 Showing the growth of the postjuvénal pelage from the lateral line (*L. l.*) upward.

6 Early 'saddle phase.' The lateral areas, as seen in figure 5 have become confluent on the dorsal median line.

7 Late 'saddle phase,' in which the juvenal pelage still persists on the head and back of the neck, and on the rump. The dark strip extending from the shoulders posteriorly to the rump is the dorsal median stripe of the postjuvénal pelage. The difference between this stripe and the juvenal pelage on the rump is not well shown in the figure, though the actual colors are quite unlike.

8 A later phase showing further decrease in size of the areas of juvenal pelage on the head and rump.

9 Full postjuvénal pelage.

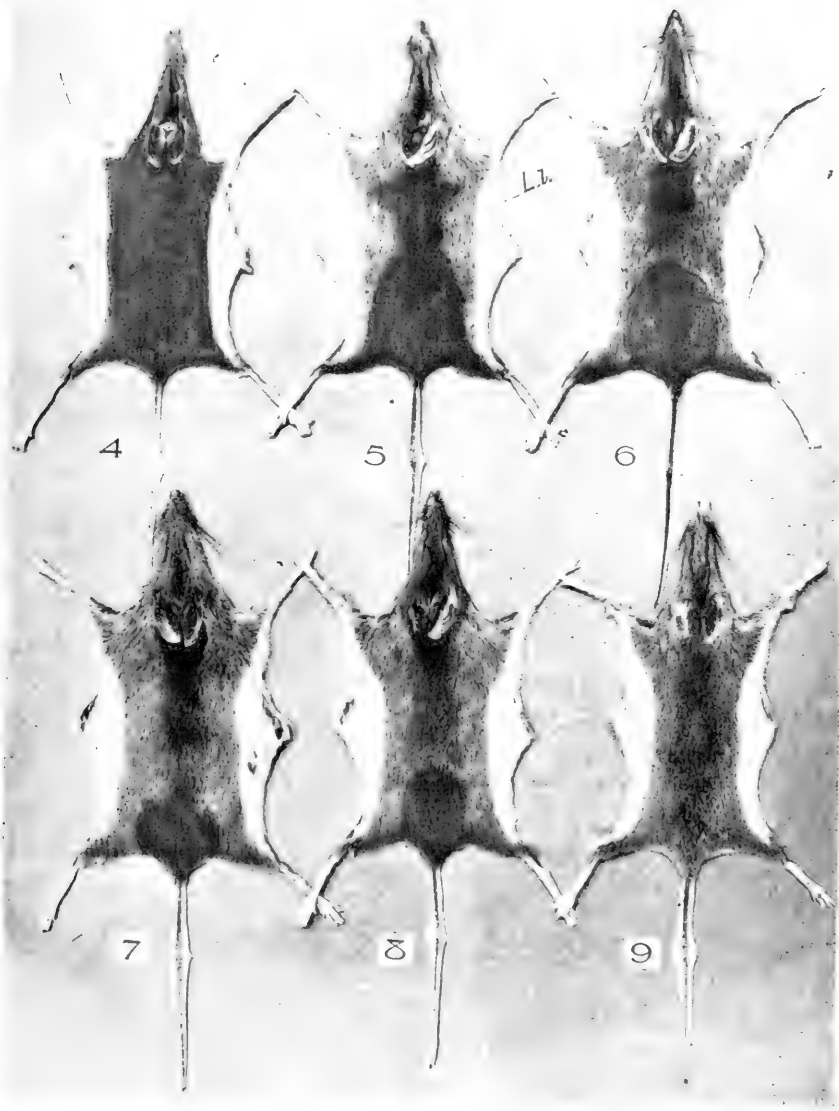

PLATE 2

EXPLANATION OF FIGURES

10 to 14 show various abnormal phases and the precocious appearance of postjuvenile pelage, as the result of depilation in *P. maniculatus gambeli*.

10 Showing postjuvenile pelage on the head, also on the rump extending barely above the lateral line anteriorly to the forelimbs.

11 A phase similar to that shown in figure 10, but more nearly symmetrical in pattern.

12 Showing the simultaneous occurrence of normal moult on the sides above the lateral line and of induced regeneration on the rump.

13 An 'island' of juvenal pelage in the median dorsal region—an inversion of the normal process. See pl. 1, fig. 6.

14 Juvenal pelage on the left side of the body, postjuvenile on the right.

15 Skin of an adult with new pelage on the left side of the body and the old pelage on the right, one month after the operation.

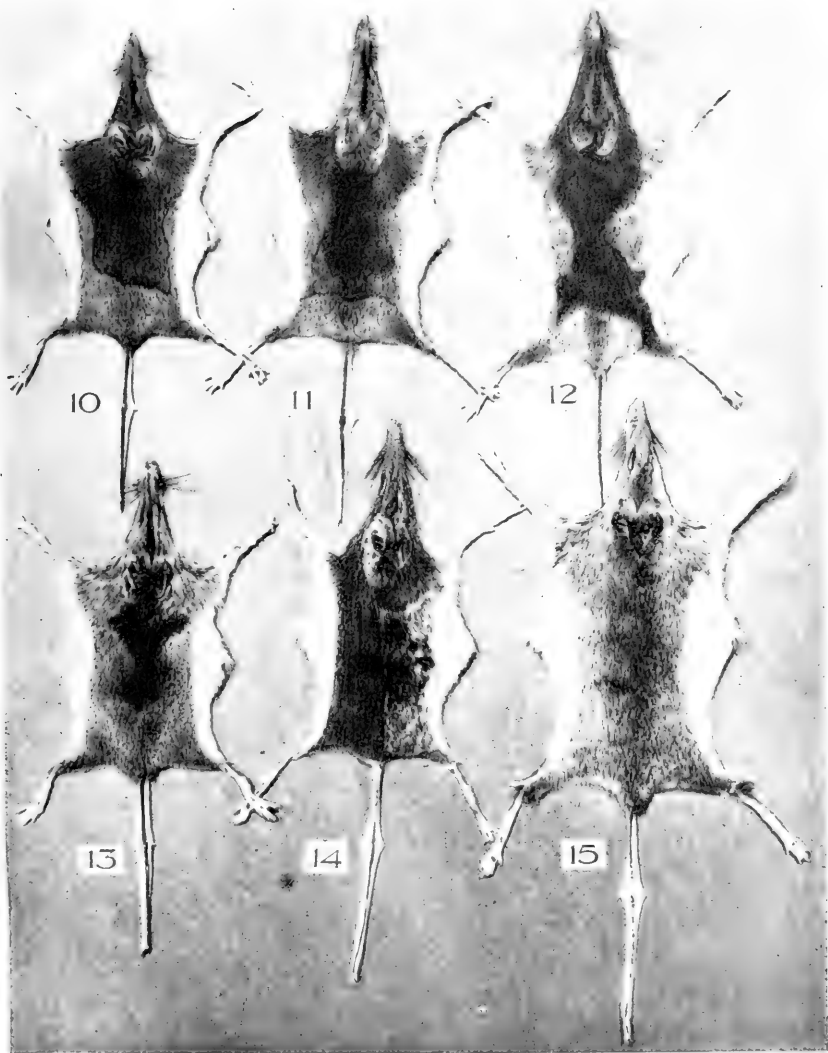



THE REACTION OF SELACHII TO INJECTIONS OF VARIOUS NON-TOXIC SOLUTIONS AND SUSPENSIONS (INCLUDING VITAL DYES), AND TO EXCRETORY TOXINS

E. R. HOSKINS AND M. M. HOSKINS

New York University and Bellevue Hospital Medical College

TWENTY-SEVEN FIGURES (SIX PLATES)

CONTENTS

Introduction.....	101
Material and methods.....	103
Experiments.....	104
1. Non-toxic solutions.....	104
2. Suspensions (vital dyes).....	108
3. Excretory toxins.....	115
Discussion.....	124
1. Digitiform gland.....	124
2. Kidney.....	126
3. Liver.....	131
4. Spleen.....	133
5. Spiral valve.....	134
6. Stomach.....	135
7. Gills.....	135
8. Body wall.....	137
9. Vascular system.....	137
Summary and conclusions.....	138
Literature cited.....	141

INTRODUCTION

The present study grew out of an attempt to determine the function of the digitiform gland, the development of which has recently been described (Hoskins, '17). This gland is peculiar to selachians, being found in no other group of animals, although in *Chimaera*, there is present in the wall of the posterior portion of the intestine a group of cells which may possibly correspond to it (Disselhorst, '04).

Nearly every reasonable function has been ascribed to the digitiform gland, but usually from morphological or hypothetical rather than physiological evidence (Hoskins, '17). The gland is a compound tubular structure with a large central lumen or duct which empties into the intestine about half way between the spiral valve and the cloaca. It is suspended in the mesentery above the intestine. Cytologically, the gland is not unlike the kidney tubules, and this, together with the fact that its secretion is discharged into the intestine posterior to the region where digestion occurs, leads to the expectation that it has an excretory function. The fact that the gland appears to be the same in both sexes argues against the probability that it is accessory to the sexual apparatus.

Another part of the work is a study of the function of the kidney (mesonephros) compared with that of mammals (metanephros). It is common knowledge that the former is a less efficient excretory organ than the latter, but the subject has never been completely studied experimentally. A study is made also of the excretory function of the liver, which is of considerable importance in selachians, on account of the inefficiency of the kidney. In selachians the liver undergoes fatty metamorphosis to such extent that nearly every cell appears filled with fat, yet the organ is able to excrete solutions and particles freely and in large amounts.

Denis ('13) has shown that dogfish are able to withstand large doses of excretory toxins, but this author did not study the problem histologically. The question of vital staining is considered here only incidentally and no attempt is made to describe completely the reaction of the dogfish to vital stains. These substances were used primarily as an aid to the study of the excretory function.

Most of the experiments were performed at the Marine Biological Laboratory at Woods' Hole, Massachusetts, in quarters provided us through the kindness of the Department of Zoology of Yale University and of Dr. Frank Lillie. The accompanying photomicrographs were made at the Osborn Zoological Laboratory of Yale University. Two experiments were done at the

Aquarium in New York. We desire here to express our thanks to the Zoology Department of Yale University, to Dr. Lillie, and to Dr. C. H. Townsend, of the Aquarium.

MATERIAL AND METHODS

The animal used in most of the experiments is the dogfish *Mustelus canis*, which is fairly abundant at Wood's Hole. In the two experiments performed at the New York Aquarium we used *Acanthias*. In all about seventy-five animals were made use of. These were of both sexes and of various sizes, but most of them were adult males.

The study was divided into three phases; *a*) the reaction to non-toxic solutions; *b*) the reaction to suspended particles, and, *c*) the reaction to excretory toxins. The solutions used are indigo-carmin, potassium iodide, dextrose, sucrose, phenol-sulphonaphthalein, and Weed's potassium ferrocyanide-iron ammonium citrate solution. The suspensions are carmin, Congo red, neutral red, and trypan blue. The toxins are potassium chromate, tartaric acid, and uranium nitrate. All were prepared with sea-water, which is isotonic with the blood of dogfish. In preparing Weed's solution, sea-water, diluted one-third, was used.

Injections were made either into the muscles of the tail and back or intravascularly. In the latter method the large vessels of the pectoral fins were used. A small wooden peg may be used for a hemostat and is very convenient as it can be easily removed for repeated injections. Intravascular injections may be made, also, directly into the sinuses of the head.

A simple device for holding the animals during the experiment may be made from a board 4 inches wide and 2 feet long. A long hole is made near one end for the dorsal fins and a row of nails driven partly in along each side of the board. The animal will be securely held on this if a cord is laced from the nails back and forth across its body. A tube of running water inserted into the animal's mouth will provide for respiration during an operation. The entire apparatus with the fish in normal position may be immersed in the aquarium if it is necessary that

the animal be kept immobilized. In collecting urine from an immersed animal the receptacle can be sealed tight and weighted to keep it under the water. A long glass tube leading into it will permit the air to escape as the urine accumulates. If a long rubber tube is used to connect the cannula with the collecting bottle the animal can even be permitted to swim about in the aquarium while the urine is being collected. Denis ('12) also describes a good method for collecting urine.

The duct of the digitiform gland enters the intestine at a peculiar angle, being completely bent on itself. In order to insert a cannula into the duct it is best to reach into the intestine with a pair of blunt forceps and turn the gut inside out through the cloaca. This straightens the duct and a cannula can then be introduced directly into it. No anaesthetic is required in operations as the animal will lie quietly in the apparatus described above and seems insensible to pain. Antiseptics were also found to be unnecessary in operations.

EXPERIMENTS

1. Solutions

A. Indigo-carmin. 1. An adult male dogfish was injected intramuscularly with 5 cc. of 0.5 per cent indigo-carmin. This appeared in the urine in fifteen minutes. It did not appear in the stomach, spiral-valve or digitiform gland contents, at least in detectable quantities. The bile was bluer than normal.

2. The experiment was repeated with a female, and similar results obtained.

3. Two animals, a male and a female, each received 5 cc. of the above solution intravenously. It was recovered from the urine of each after eight minutes.

4. A female was injected as in '3' and permitted to live five hours, at which time the urine was still dark blue in color.

All five of the above-mentioned animals were autopsied at various times after injections, varying from a half-hour to five hours. All secretions examined gave the same reactions as in

'1.' Also in every case the anterior portion of the kidney and liver was of a light blue color. The posterior portion of the kidney was dark blue and a dissection of the liver showed the bile ducts to be colored blue rather than the usual green. The other organs of the body cavity were not distinctly blue in color.

Glands were fixed in absolute alcohol, but the dye soon disappeared either by fading or going into solution. Sections were made and examined microscopically, but no blue granules were seen even though the gross specimens were blue. The dye was probably impure and hence dissolved out in the alcohol, as was found to be true in some cases by Heidenhain ('83) working with other animals.

B. Potassium iodide. An adult male fish received 10 cc. of a 3 per cent solution of potassium iodide intravenously. After three and a half hours tests were made with nitric acid and starch (Hawk, '16), and the iodide was found to be present in the urine in the gastric and intestinal fluids, the bile, and the secretion of the digitiform gland.

C. Dextrose. An adult female fish received intravenously 15 cc. of 25 per cent dextrose solution. At the end of one hour the urine was negative to Benedict's sugar test (Hawk, '16), but was positive after four hours and negative again after nine hours. At the latter time the bile gave a positive reaction, but the secretion of the digitiform gland reacted negatively.

D. Sucrose. The animal received intravenously 15 cc. of 30 per cent sucrose, and after six and one-half hours was autopsied. The reaction to Benedict's test was positive in the case of the urine, bile, and blood serum, but negative with the gastric and spiral-valve contents. The digitiform gland secretion was not tested.

E. Phenosulphonepthalein (Rowntree and Geraghty, '12).
1. One and two-tenths cc. of this pthalein was injected intramuscularly. It appeared in the urine in fourteen minutes. At autopsy it was not present in detectable amounts in the stomach, intestines, or digitiform gland.

2. An animal received intravenously 1 cc. of pthalein. Autopsy was performed after one hour. At this time the pthalein

was present in the urine, bile, and in the stomach and spiral-valve contents. The secretion of the digitiform gland and an extract of the spleen were negative.

3. An adult fish received 1.4 cc. of pthalein. The urine was collected for five and a half hours and the bile in the gall-bladder was removed at the end of that time. The urine, bile, and 1.4 cc. of pthalein in graduated cylinders were each diluted with water, acidified and all compared (Rowntree and Geraghty, '12). By this comparison it was shown that approximately one-half of the injected pthalein had been recovered, and of this, about one-fourth was in the urine and three-fourths in the bile. The bile pigments interfere slightly with the test. A trace of pthalein was found in the serum, digitiform gland secretion, and in the stomach and spiral-valve contents. That in the latter two may have come from excreted bile.

4. An adult received 1 cc. of pthalein. A cannula was inserted to collect the urine and the animal was then permitted to swim about in the aquarium for four and a half hours in order that the excretion might not in any way be interfered with by the unnatural position of the animal in the holding apparatus that was used in the first three experiments. In this specimen as in the others more pthalein was recovered in the bile than in the urine. Pthalein was also found in the spiral valve, but not in the stomach.

F. Weed's solution (potassium ferrocyanide and iron ammonium citrate, Weed, '12). 1. A young male (0.8 kg.) received intra muscularly 7.5 cc. of Weed's solution and was autopsied after four hours. The urine and bile gave the Prussian-blue reaction with acid. The serum and the stomach and spiral-valve contents were negative to the test.

2. A young animal (0.5 kg.) received intramuscularly 9 cc. of Weed's solution, followed after five hours by 9 cc., and after twenty-two hours by 8 cc. Twenty-five hours after the first injection the Prussian-blue reaction was obtained with the urine, bile, and serum. The liver turned blue on standing.

3. A young female (0.5 kg.) received, as above, 10 cc. of the solution, followed by 5 cc. after four hours, and 5 cc. after seven

hours. Autopsy was performed eight hours after the first injection. The Prussian-blue reaction was obtained from the serum and urine, but not from the bile, or stomach and spiral-valve contents. Pieces of organs were fixed in 20 per cent formaldehyde acidified to 1 per cent with hydrochloric acid.

4. An adult (*Acanthias*) received four hourly injections of 6 cc. each of Weed's solution, and was autopsied four and a half hours after the first dose. Organs were fixed in absolute alcohol acidified as above.

5. An adult (*Acanthias*) received three injections of 9 cc. each of Weed's solution at hour intervals and was autopsied forty-five minutes after the last injection. Forty per cent formaldehyde acidified to 1 per cent was used as a fixative. Microscopic examinations were made of various organs from the animals, '3,' '4,' and '5' with the following results:

a. Digitiform gland. In all the specimens examined there is a central, distinctly blue zone, the width of about one-half the radius of the gland as seen in transverse sections. Microscopically, the blue granules are seen almost entirely within the blood-vessels, although a very few are found in the cells of the tubules, but none in the lumen. The granules are present in the capillaries and central venous sinuses in greater concentration than in the vessels of any other organ.

b. Kidney. The gross specimens are dark blue in color. Sections show many Prussian-blue granules in the blood-vessels and tubules. A very few only are present in the glomerular cavities. They are found in the cytoplasm of both the secretory and excretory tubules. Blue granules are found also in the connective tissue of the kidney.

c. Liver. The gross specimens are all light blue in color. In a few hepatic cells blue granules are seen and they are present in greater number in the ducts. This indicates either that the solution passed directly into the ducts, as was thought to be the case of trypan blue in bony fishes (Wislocki, '17), or else that the solution passed through the epithelium quickly and out of the ducts more slowly, thus becoming concentrated in the ducts. In the liver of animal '3' the endothelium and the leucocytes of

the hepatic sinuses have a deposit of blue granules on or in them. This condition is not seen in other organs of the same animal nor in the liver of other animals.

d. Spleen. Blue granules are scattered throughout the spleen among, but not within the cells.

e. Spiral-valve, stomach, gills, and muscle. All these have blue granules in the blood-vessels and scattered through the connective tissue, but none within any cells. In gross free-hand sections the epithelium of the stomach and spiral-valve appears white, in striking contrast with the dark blue connective-tissue.

2. *Suspensions*

A. Carmine. Powdered carmine was used for coarse granules, although some of it seems to go into solution in sea-water. It will not all settle out on standing, cannot be separated out with ordinary filter-paper, and will even pass through a celloidin membrane. After passing through celloidin no granules can be seen with the ordinary microscope. This may not be in true solution, but if not it is practically so.

1. Filtered carmine after settling for several days was injected intravenously into an adult male dogfish. The animal received four daily doses of 12 cc. each and was autopsied eight hours after the last injection. Microscopic examination of the various organs failed to show the presence of any carmine granules, although the spleen appeared distinctly red after fixation. The granules were either too small and too much scattered to be seen or else the carmine was in solution and washed out in preparing the sections. The urine was not collected.

2. Ten adult animals were injected intravenously each with 10 cc. of a heavy suspension of powdered carmine in sea-water and autopsied after various periods as follows: 1½, 6½, 21, 24, 50, and 96 hours. This carmine was not filtered. Pieces of the various organs and tissues were fixed in formalin, sectioned in paraffin, and stained with haematoxylin, or examined unstained.

Urine was collected from several of the animals, but in only one specimen of it was any carmine found, and in that but one

granule. This sample of urine also contained a few blood corpuscles and hence the carmine probably entered with the blood.

Microscopical examination. *a.* Digitiform gland. Carmine is present in the endothelium and leucocytes of the blood-vessels in this gland in all stages, but very little in the first ($1\frac{1}{2}$ hours), and less in all the sections than in the endothelium of the kidney, liver, spleen, and gills. In the 21-, 24-, and 50-hour specimens there is an occasional carmine granule seen in the cytoplasm of the tubules. These few granules may possibly have been dragged into the cells in the cutting of the sections and in any case are too few in number to be of any importance. None was seen in the lumen of the tubules.

b. Kidney. In the first two stages there is considerable amount of free carmine in the capillaries, much of it in large clumps filling the entire vessel, and a few leucocytes and endothelial cells contain carmine granules.

In later stages (21 to 96 hours) there is a gradual decrease in the amount of free carmine in the capillaries and there are no large masses of it present. There is a decreasing amount seen in the leucocytes and endothelium. A few sections have carmine granules in the connective-tissue cells. In only three tubules of the hundreds of sections examined are carmine granules to be seen in the cytoplasm. These few granules may have been carried in, in the preparation, and as in the digitiform gland are considered to be of no practical significance. Each of two tubules of one section contained a granule in the lumen, but one also finds blood corpuscles occasionally in the tubules and these carmine granules may have entered accidentally.

c. Liver. Carmine granules are seen in all stages after the first, in the leucocytes and endothelial cells of the sinusoids, in the hepatic cells, and in the normal pigment accumulations, which are very abundant in the liver of the dogfish.

Carmine was found in the bile in all stages after the first, as free granules, in cells resembling leucocytes and mixed with the normal pigment.

d. Spleen. Carmine is present in all the sections of spleen examined and in decreasing amounts in later stages (fig. 1).

In all stages carmine may be seen as granules free in the sinuses, and ingested by the endothelium of the sinuses and by splenic cells. The insert in figure 1 shows an endothelial cell that has extended a pseudopodial process and engulfed a very large granule. The figure also shows an endothelial cell filled with carmine and apparently about to be liberated as a free phagocyte (macrophage?). In many places the ingested carmine seems to be enclosed in vacuoles.

There is a decided increase in the number of mitotic figures seen in the spleen beginning with the 21-hour stage, indicating a leucocytosis.

e. Spiral-valve and stomach. In these organs there is an occasional phagocyte in the capillaries that contains carmine. There is no carmine outside the vessels.

f. Gills. The large sinuses which are interposed between the branchial arterial arches and the capillaries in the filaments are lined with an endothelium which is very phagocytic. This will be described in detail under 'Trypan blue.' In the earlier stages the gills were not examined, but sections of later stages (50 and 96 hours) show the endothelial cells of the sinuses to be engorged with carmine granules. Many of these cells have also been 'budded off' and lie in the channel as free phagocytes. This endothelium is doubtless one of the sources of circulating phagocytes in the dogfish.

Even the arterial arches are lined with phagocytic endothelium especially along the side next to the sinuses.

g. Heart. The 1½-hour stage shows a few cells of the endocardium that are phagocytic to carmine. The heart in other stages was not examined.

h. Blood. In all stages the blood contains free carmine and granules ingested by phagocytes. The number of free granules decreases in the later stages.

B. Neutral red. Two series of experiments were conducted with neutral red and to some extent with different results. In 1916 the sample of neutral red used seemed to form a true suspension, as it could all be separated from the water with ordinary filter-paper.

1. An adult received intravenously 10 cc. of suspension of neutral red and was permitted to swim about in the aquarium. At that time the animal was immobilized, received an additional 18 cc. of the suspension, and its urine was collected for five hours without any of the neutral red appearing in it. Autopsy showed the bile to be reddish brown. This turned orange with alkali and dark lilac with acid. Serum gave a similar reaction, but the gastric fluid was negative. The suspension was prepared by stirring neutral red in sea-water and allowing the mixture to settle.

2. An adult was injected intravenously with 15 cc. of saturated neutral red suspension. The urine was collected for six hours and was at all times free of the dye. Autopsy showed neutral red in the bile in a considerable amount.

3. A female received intravenously, 10 cc. of the neutral red suspension and the urine was collected for eight and a half hours without any of the dye appearing in it. As above, it was present in the bile.

The two following experiments were carried out a year later than the former, with a different sample of neutral red. This could not all be removed by filtering and part of it even passed through a celloidin sac, so that it probably was partly in solution.

4. Ten cc. of filtered neutral red in sea-water was injected intravenously into an adult fish. Four hours later, examination showed the dye to be in both the bile and urine, but not in the stomach or spiral-valve contents.

5. Eight cc. of the dye in the above form was injected intravenously into an adult dogfish. There was 24 cc. of bright red urine collected in twenty-four hours, and at autopsy 2.5 cc of reddish-brown bile was removed from the gall-bladder. The 24 cc. of urine was diluted to 100 cc. with water and the 2.5 cc. of bile to 200 cc. Maximum redness was produced by neutralizing, and the color of the two were then of about the same intensity. Thus the total excretion of the dye by the liver was more than eighty times as much as that excreted by the kidney. The total amount of dye removed by the liver was not collected

because some escaped with bile into the intestine. The neutral red in the urine appeared to be in solution when examined under the microscope, whereas some, at least, of that in the bile was in granular form. Before the filtered neutral red was injected it appeared to have only very minute granules, smaller than those in the bile, so that in passing through the liver, granules must have collected together. Denis ('12) found the urine acid to litmus, but neutral red excreted in it retained its red color.

C. Congo red. The Congo red used could easily be removed by filtration or settling and would not pass through a celloidin membrane.

1. Two adult dogfish received intravenously each 5 cc. of a heavy suspension of Congo red in sea-water. After twelve hours the urine was still free from the dye, as was the stomach and spiral-valve contents. A considerable amount was present in the bile.

2. A young fish (0.25 kg.) received doses of Congo red of 12 cc. and 18 cc., respectively, on two successive days and was autopsied forty-eight hours after the first injection. The liver and spleen were stained deeply with the dye, but the other organs of the body cavity appeared practically normal in color. The gills were not examined. A large amount of the dye was present in the bile, a small amount in the spiral valve, and a trace in the stomach. The dye in the spiral valve entered with the bile probably entirely and that in the stomach probably was regurgitated from the spiral-valve.

D. Trypan blue. Trypan blue was used primarily in studying the excretory function. Its action as a vital stain, although not exhaustively studied, will be considered also from the data we have, because the reaction in selachians seems to be in some ways different from that in teleosts as described recently by Wislocki ('17). A brief review of our results with this dye has been published (Hoskins and Hoskins, '18).

1. An adult male was injected intravenously with 9 cc. of a $\frac{1}{2}$ per cent suspension of filtered trypan blue in sea-water. Four hours later the animal received 6 cc. more. Fifteen hours later another injection of 6 cc. was made. Autopsy was performed

thirty hours after the first injection. The urine was examined several times and was free of dye until nearly the time of autopsy, when a trace of the red portion (Wislocki, '17) was present. The bile contained a considerable amount of the whole dye. It was also recovered from the serum, but not from the stomach or spiral-valve contents. The liver and spleen were of a slightly darker blue color than the other organs, but all of the organs as well as the skin and peritoneum appeared slightly colored by the dye.

Microscopical examinations were made of the digitiform gland, kidney, liver, spleen, spiral valve, stomach, skin, and musculature. All of these retained their blue color after fixation as seen in gross specimens, but blue granules are found under the microscope, definitely, in only the endothelium of the liver and spleen. The stain in the other organs and tissues is either too diffuse to be seen microscopically or else was all free in the blood-vessels, and hence washed out in preparing the sections.

2. A young fish (0.25 kg.) was given four daily intravenous injections of 3 cc. each of the above-mentioned trypan blue, and was autopsied five days after the first injection. The dye was found in considerable amount in the bile and serum and was also present in the spiral-valve, but not in the stomach contents. The liver and spleen were very dark blue in color as were the gills at the base of the filaments. The skin was dark blue before fixation, but light blue afterwards. The digitiform gland, spiral valve, post valvular intestine, peritoneum, and fascia of the muscles were light blue in color, the stomach was still lighter, and the kidney, except the peritoneal covering and connective tissue, was practically normal in color.

All these organs except the first three were of a lighter shade after fixation than before, owing doubtless to loss of blood which contained trypan blue.

Microscopical examination. a. Digitiform gland. Most of the dye is too diffuse to be located microscopically. A few leucocytes and endothelial cells of the capillaries of the parenchyma and serosa contain blue granules and one cell of a tubule contains eight such granules in a vacuole, but the amount of

the dye detectable in this organ is too small to be of practical importance.

b. Kidney. Microscopically, the dye can be seen in only a few leucocytes and endothelial cells of the capillaries.

c. Liver. The liver contains most of the fixed trypan blue in the entire body. This organ is relatively large and in almost every cell in a large number of sections examined there are from five to twenty blue granules of different sizes (fig. 2). In places the granules appear to be in vacuoles. A rather large number of endothelial cells of the sinusoids likewise are seen to contain the dye. In figure 2 one such is seen nearly separated from the wall of the vessel and so full of stain that the nucleus is barely visible. In the liver of the dogfish there is a relatively large amount of normal pigment both in the sinusoids and in the parenchyma, collected into large masses. These black granules are often found in phagocytes. The large mass shown in a sinusoid in figure 2 is made up both of this black pigment and trypan blue granules. These black pigment masses may be found in the bile normally, and in the present experiment both black masses and masses of both blue and black granules were seen. There were found also in the bile many blue granules free and in escaped cells which are present also in normal bile. All the granules shown in figure 2 in the hepatic and endothelial cells and in the leucocyte are trypan blue. The mass at *x* is mostly normal black pigment.

d. Spleen. A free-hand section of the spleen showed the dye to be scattered uniformly through the tissue. The specimen was not examined microscopically, but nearly every cell must have ingested the dye.

e. The spiral valve, stomach, postvalvular portion of the intestine, muscles, and skin were still light blue in color after being embedded in paraffin, but under the microscope definite blue granules can be seen in only a few free phagocytes in the blood-vessels. A free-hand tangential section of the integument was cleared in oil, but the dye present was too diffuse to be made out after clearing. The pigment in the melanophores was all black and the subcutaneous vessels were colorless.

f. Gills. The sinuses which intervene between the arterial arches and the capillaries in the filaments, as described in the experiments with carmine, are lined with endothelium very phagocytic to trypan blue. The dye is in greater concentration in these cells than in any others examined. In some sinuses (figs. 3 and 4) every cell is engorged with the dye. Even in the large artery (fig. 3) a few of the endothelial cells contain blue granules. In figure 4 the cells and nuclei have rounded. Many are nearly detached or are lying free in the sinus ready to move with the blood stream as circulating phagocytes. Some of the granules in the cells seem to be contained in vacuoles, although the fact is not shown in the drawing. Most of the granules shown are trypan blue, but two cells marked 'x' contain also some normal black pigment. In some cells the dye completely hides the nucleus. Practically all the sinuses examined are completely lined with cells filled with trypan blue, but a few sinuses are unstained.

A few cells in the capillaries contain blue granules. The epithelium covering the filaments does not contain trypan blue, although some investigators have suggested that the gills may excrete other substances besides gas.

3. *Excretory toxins*

A. *Potassium chromate*. 1. An adult dogfish received intramuscularly 150 mg. per kg. body weight of potassium chromate in a 1 per cent solution. Autopsy was performed after thirty hours and when the animal was moribund.

The kidneys and spiral valve were greatly congested, the latter containing a bloody fluid. Other organs appeared to be normal at autopsy.

2. An adult received intramuscularly 75 mg. per kg. body weight of potassium chromate in 1 per cent solution. Autopsy was performed after twenty-four hours while the animal was still active. The amount of toxin injected was less than that which Denis ('14) found to be necessary to kill a dogfish. In this specimen all the organs appeared normal except the spiral valve and kidney, which were slightly congested.

3. Four adults were injected intravenously with 100 mg. per kg. body weight of potassium chromate in dilute solution, to study the effect of sudden intoxication. Every one of the four died in a short time, varying from a few minutes to three hours, although they received much less toxin than is necessary to kill them if it were injected intramuscularly and slowly absorbed. In each of them at autopsy the blood was brown and 'granular' in appearance, showing that the erythrocytes had been destroyed and the haemoglobin oxidized by the chromate, which is a commonly used oxidizing reagent.

Microscopical examination. a. Digitiform gland. This organ in animal '1' is severely congested (fig. 10), but there is no great increase in the relative number of leucocytes. The central venous sinuses are greatly distended with blood. At the periphery most of the tubules have undergone vacuolar (hydropic) degeneration (figs. 11, 12, 13), which in some places is complete. Here the epithelial cells are cytolysed and the nuclei shrunken and darkly stained and in some cases are pyknotic. A few nuclei, on the other hand, are swollen and hypochromatic.

The area of extreme degeneration is about one-twelfth as wide as the radius of the gland. In a narrow strip, internal to this area, there is a gradual transition to normal condition, the cells exhibiting varying degrees of cytolysis and pyknosis or karyolysis. Scattered through the remainder of the gland are individual tubules showing mild cellular degeneration. It should be noted that in normal animals a few cells occasionally are degenerate, probably from cell inanition, (a term applied by Jackson ('16) in a study of the thyroid).

Cellular debris containing degenerated nuclei may be seen in some tubules and in the central lumen of the gland.

The erythrocytes in the digitiform artery appear normal, but in the central sinuses all appear granular and some are completely broken down.

2. The digitiform gland in the second animal was not injured by the potassium chromate.

b. Kidney. 1. The kidney in the first two animals is severely congested. Capillaries are dilated in the glomeruli and among the tubules. Erythrocytes show signs of degeneration. The glomeruli are not destroyed, but are probably somewhat injured. Many of their nuclei (fig. 6) are either hypochromatic or hyperchromatic and an occasional vacuole is seen in the capsule.

Two distinct types of degeneration are seen in the tubules of this specimen and a third type in the second animal. These two types we may call granular and hydropic (vacuolar), and of these, the former greatly predominates.

The granular degenerative process occurs as follows: First the cytoplasm loses its network appearance (fig. 7) in which the granules are very small and brightly stained with eosin. The granules become dull and adjacent cell walls disappear and finally the cytoplasm breaks through into the lumen. At the same time the entire tubule may shrink in places and pull away from its connective-tissue capsule. The degenerated mass of cytoplasm may spread and lose all shape (fig. 9). While these processes are occurring the nuclei are degenerating in the following manner. Most of them shrink, becoming hyperchromatic, and stain poorly. The chromatin may become merely a dull mass (fig. 8). The nuclei may shrink to nearly invisible size. In some tubules the nuclei degenerate differently. These gradually swell, becoming hypochromatic, and then undergo complete karyolysis. Both kinds may be seen in the same tubule.

The hydropic type of cellular degeneration is that in which vacuoles appear in the cells which gradually undergo cytolysis. The cytoplasm at first undergoes slight granular degeneration. In these cells the nuclei may undergo either hyperchromatosis or karyolysis. There is relatively little hydropic degeneration present in the chromate nephritis and it will be described later.

Destruction of epithelium is largely confined to the thick-walled secretory tubules of the posterior region of the kidney, where nearly every such tubule shows signs of degeneration.

There is an increase in the number of leucocytes present in the degenerated areas.

2. The kidney of the second animal was much less severely injured than in the first, as was to be expected since it received a smaller dose and was autopsied sooner

The glomeruli are seen to be very slightly injured, as is evidenced by their hyperchromatic and hypochromatic nuclei. A considerable number of secretory tubules show the beginning of either granular or hydropic degeneration. Animal '2' shows in 20 per cent of the tubules in the posterior part of the kidney a third type of nephritis that may be called hyaline. It is not seen in the kidney of the first animal. In this type there is a gradual accumulation in the cells of droplets of a bright homogeneous substance which stains readily with eosin. In extreme cases the tubule is completely changed into a mere mass of these droplets. The nuclei may appear normal or hyperchromatic. The hyaline degeneration will be described later.

e. Liver. There is no serious degeneration in the first animal and almost none at all in the second. In the former a number of nuclei are hyperchromatic and in places the cytoplasm stains poorly. There is a slight congestion in both specimens. The ducts and gall-bladder are uninjured.

d. Spleen. The spleen was examined microscopically in the first animal only. It is congested, the capillaries and sinuses being somewhat dilated. They contain erythrocytes which appear to be degenerated. In these the nuclei are darkly stained and the haemoglobin appears granular. Some erythrocytes are entirely broken down and are shown only as nuclei surrounded by a few granules. The splenic cells proper and endothelium are intact but some stain poorly.

e. Spiral valve (figs. 14 and 15). The spiral valve shows similar changes in both animals, but the injury in the second is less severe than in the other.

Both are greatly congested and oedematous. The surface epithelium has completely desquamated in large patches, especially where it is most exposed, on the folds of the mucosa (fig. 15). The surface epithelium remaining stains poorly, appearing dull, and the nuclei are either hypochromatic or hyperchromatic. A few cells are cytolysed. The epithelium in the bottom of the

crypts is nearly normal in appearance. The erythrocytes in the spiral valve of the first animal show considerable injury, but those in the second do not.

f. Stomach. The stomach is not seriously injured in the first specimen and not at all in the second. In the former there is slight congestion, the surface epithelium contains a few hyperchromatic and a few hypochromatic nuclei and the deepest glands show slight cytolysis in a few cells.

g. Blood. As indicated above, severe injury to erythrocytes is done with potassium chromate. In some of the vessels of every organ examined there are degenerated red blood-cells, although in other vessels the cells are normal in appearance. The injury is greatest in congested areas where the flow of blood was interfered with. Intravenous injections of potassium chromate lakes the blood rather quickly.

B. Tartaric acid. An adult male received intramuscularly 100 mg. per kg. body weight of tartaric acid and was autopsied after thirty hours when it was moribund. All of the organs appeared normal except the spleen, which was pale.

Microscopical examination. *a. Digitiform gland.* This organ is severely congested, but except for a very slight cytolysis and hypochromatosis near the periphery there is evidently no injury to the tubules.

b. Kidney. Nephritis in all regions of the kidney is very severe. Congestion is marked. The glomeruli are not particularly affected, but have hyperchromatic nuclei. In some transverse sections of the posterior part of the kidney fully 90 per cent of the secretory tubules and many of the excretory tubules show signs of degeneration, ranging from mild changes to complete destruction (fig. 17).

All three types of nephritis are present, but the granular variety (fig. 19) predominates. Granular nephritis is much the same as that described in chromate nephritis (see figs. 8, 9, 18, 19, and 20). The destruction in the case of the tartaric acid nephritis is more complete (fig. 20), and in addition there is present in the surrounding tissue a very considerable number of cells with large eosinophilic granules and nuclei of different

sizes. These granules stain more readily than the tubules. Some of these cells might possibly be degenerated erythrocytes, but most of them have nuclei resembling leucocytes and endothelial phagocytes. These cells were found only in this experiment. In places even the connective tissue and blood-vessels are injured.

Hydropic degeneration is confined largely to the thinner-walled (collecting) tubules, as may be seen from a careful study of figure 17. In some of these tubules the cell outline is fairly distinct and the nucleus nearly normal in appearance, but every bit of cytoplasm has dissolved out. In other tubules the nuclei are shrunken and darkly stained and the cell's walls are indistinguishable. Only a few of the secretory tubules contain vacuoles.

Hyaline degeneration is confined entirely to the secretory tubules. In this type the hyaline substance first appears in very small droplets near the nucleus. The small black dots in the cytoplasm in figure 17 are of this hyaline substance. The hyaline droplets gradually increase in size and number (fig. 21). They finally break through into the lumen of the tubule. During the process the nuclei may shrink and become hyperchromatic or swell and become hypochromatic, but they are not so severely injured as in granular degeneration.

c. Liver. The liver is not greatly congested. The tubules contain more debris than usual and both hypochromatic and hyperchromatic nuclei are rather numerous. In the sinuses are many cells with eosinophilic granules like those seen in the kidney, but in smaller number.

d. Spleen. The spleen itself is uninjured, but contains many of the eosinophilic cells noted above and also a considerable number of degenerate erythrocytes and free nuclei. There are also a few peculiarly shaped nuclei which will be described below.

e. Spiral valve. The injury done to the spiral valve by the tartaric acid is about as extensive as in the case of potassium chromate. Both karyorrhexis and pyknosis are shown in the epithelium. In the lamina propria of the mucosa there are

numerous eosinophilic leucocytes. In sections of the spiral valve stained together with sections of a normal spiral valve the chromatin in the epithelial cells of the former which appear otherwise normal in structure stains much less darkly with haematoxylin than does that of the normal tissue.

g. Stomach. The stomach is in about the same condition as in the 'chromate' specimen. There are present in the blood-vessels and lamina propria numerous eosinophilic leucocytes.

C. Uranium nitrate. 1. An adult received intramuscularly 90 mg. per kg. body weight of uranium nitrate in 1 per cent solution. It lived forty-four hours and was then autopsied at once. The spiral valve was greatly congested, but the other organs appeared normal.

2. A male of 1 kg. received 100 mg. of uranium nitrate as above. Respiration ceased after two hours, but was restored by an hour of artificial respiration produced by inserting a tube of running water into the animal's mouth. The fish died after twenty-eight and a half hours and was immediately autopsied. The spiral valve contained bloody fluid and its mucosa was congested. A few small hemorrhages appeared in the kidney. No other abnormalities were noted.

3. An adult of 1 kg. received intramuscularly 100 mg. of uranium nitrate. A cannula was inserted into the bile duct to prevent any toxin that might be in the bile from reaching the spiral valve. After five hours the urine was tested and found to contain uranium nitrate. The next morning the animal received an additional 90 mg. of the toxin. At 8 P.M. it was still active, but died in the early morning, about forty hours after the first injection. The body was not yet rigid at 8 A.M., so tissues were fixed for microscopical examination, as few postmortem changes had had time to occur. This was confirmed by the microscopical examination. The kidneys were congested, but other organs appeared normal.

4. Eight dogfish of various sizes were injected with 100 mg. to 200 mg. per kg. body weight, of uranium nitrate. A cannula was inserted into the bile duct to protect the spiral valve from toxin in the bile. The urine was collected. Uranium nitrate

was found in the urine, but the color of the bile made it uncertain whether or not the toxin was present there. One animal receiving 200 mg. of the toxin in two equal daily doses survived for eighty hours, the others dying in shorter time. Two animals while still living were noticed to have a bloody discharge from the cloaca. Autopsy showed that in all the animals the spiral valve was greatly congested and its mucosa was injured. The stomach and the postvalvular portion of the intestine appeared to be uninjured.

Microscopical examination. Sections of the various organs of the first three animals described above, were examined microscopically.

a. Digitiform gland. In all specimens there is considerable congestion and slight cytolysis at the periphery and scattered through the gland, caused either directly by the toxin or by its interference with the blood supply, or from both causes. The injury was not very severe in any case.

b. Kidney. The kidney in every case is greatly congested, especially in the posterior region. The glomeruli are not very seriously injured in these specimens, but in most of them the capillaries are dilated and the nuclei of the capsule are hyperchromatic and shrunken.

Injury to the tubules is confined largely to the secretory tubules of the posterior portion of the gland (figs. 22, 23, 24, 25). In the third animal the changes are most severe, due either to the fact that it received more toxin than the first two animals, or else to postmortem changes, or to both reasons. In the third animal nearly every tubule in the posterior region is degenerated and some have completely disappeared. All three types of degeneration are seen, but the granular type predominates. Both hyperchromatization and hypochromatization of the nuclei are evident. In the former the nucleus gradually shrinks until it finally disappears (fig. 23). In the latter the nucleus absorbs water and swells often to two or three times the original diameter, the chromatin gradually disappearing until the nucleus looks like a ring. In the third specimen almost every nucleus has changed from the normal oval to the spherical shape, and

most of them have suffered chromatin changes. The blood-vessels in the kidney of this animal contain a large amount of debris.

In the first animal there are present in the blood-vessels of the degenerated region of the kidney many nuclei of a very peculiar shape (fig. 26). This may indicate an attempt at amitosis by phagocytes, probably in the spleen and gills. One cannot make out any cytoplasm, so that if a cell wall is present it is tightly adherent to the nucleus. On the whole, the kidney is less seriously injured in the uranium series than in the chromate or tartaric. However, the size of the dose of the toxin and the time element are probably the most important factors in the amount of injury produced.

In the anterior region the tubules show no signs of degeneration in some sections, and very few in any. The congestion is mild as compared with that in the posterior region. A few tubules stain poorly and their cytoplasm is quite granular.

e. Liver. The liver and gall-bladder are practically uninjured even in the third animal. In all sections a few nuclei of the hepatic cells and ducts are hyperchromatic and shrunken, but not in more than 12 per cent at most. In the third animal (which received a large dose and which died before autopsy) the ducts contain considerable debris, and a few of their cells are very slightly cytolysed.

d. Spleen. The spleen is congested in every specimen. The sinuses are dilated and contain granular debris, which probably has come in from the kidney. The endothelial cells of the sinuses contain these granules and their nuclei are often swollen and hypochromatic. In the first animal (fig. 27) there are many peculiar-shaped nuclei which resemble those seen in the kidney and gills. Some of these at least are endothelial in origin, as they can be seen in the cells lining the sinuses. They may represent abnormal amitosis. Many mitotic figures can be seen in the spleen of this animal, although they are fewer than when carmine was injected. The splenic cells proper are not particularly abnormal in appearance, although a few have hypochromatic nuclei.

e. Spiral-valve. In the first two animals in which the bile (presumably containing the toxin) was allowed to enter the gut, the spiral valve showed approximately the same amount of injury as in the chromate and tartaric experiments. In the third animal in which the bile was kept out of the intestine the injury is less extensive than in the others, although there is some congestion of the mucosa and desquamation of its surface epithelium. This was true also of other animals which were not examined microscopically, as stated above (4).

f. Stomach. The stomach in the first two animals resembles that in the chromate experiments. In the third, the stomach is practically normal, and the very few alterations observed might be postmortem in origin, or the result of vascular injury which causes cell inanition.

g. Postvalvular intestine. That portion of the intestine posterior to the spiral valve was examined microscopically in the second animal, and is entirely normal in appearance, although the spiral valve which empties into it is seriously injured. Its epithelium is stratified while that of the spiral valve is simple columnar.

h. Gills. The gills of the first animal were examined and show some signs of injury. In the sinuses at the base of the filaments the endothelial cells have rounded as they do when granules are injected. Here are seen many peculiar nuclei (fig. 27) such as were seen in the spleen and kidney, some of which may be found protruding from the endothelium. The endothelial cells in places are full of dull granules which have come originally from the blood, or else are formed in the cells by degeneration. Many free cells are to be found in the sinuses, indicating a proliferation of the endothelium.

DISCUSSION

1. Digitiform gland

The digitiform gland reacted somewhat as an excretory organ, but it is not very efficient as such. In this it resembles the kidney. Its normal secretion collected from three adult dogfish

averaged only 0.25 cc. in six hours, or at the rate of 1 cc. a day. The excretion is alkaline to litmus. It is clear, but contains bits of mucus. The amount of this excretion is not copious, but the entire amount produced by both kidneys is only a little over 20 cc. in twenty-four hours. Since the size of the digitiform gland is much less than one-twentieth of that of the kidneys, its excretion is relatively greater than the amount of urine given off. Crawford ('99) obtained urea from the digitiform gland and suggested the possibility of excretory function for this organ. Hyrtl ('58) regarded it as an accessory sex gland, and Blanchard ('82) stated that it is potentially able to aid digestion because an extract of it splits starch and emulsifies fat. An extract is, however, not the same thing as a secretion and hence Blanchard's conclusion may not be correct. It should be borne in mind that the product from the gland is discharged into the intestine just above the cloaca at a place where digestion has doubtless ceased. Morgera ('16) thought that the digitiform gland has an internal secretion which causes the intestines to contract, thus aiding in the passage of substances through the gut, because he found that passage of food through the intestine was checked by extirpation of the gland and restored by the injection of an extract of it. One must consider that the interference with the passage of food in these experiments may have been but a temporary disturbance from the operation, that would have disappeared later. Also, as stated above a glandular extract is not the same thing as a normal secretion of the gland.

Cushny ('17) believes that urine is excreted by glomeruli and not by the renal tubules. If the secretion of the digitiform gland is a true excretion, then the renal tubules may also be able to excrete, in which case, Cushny's theory is incorrect.

We were able to recover in the excretion from the digitiform gland after injection into the animal two solutions, namely, potassium iodide and pthalein, but not any of the others used. The other solutions if present were too dilute to be demonstrated. Weed's solution passed into the cells of the tubules, as shown microscopically, only in small amounts, although it was present in the blood-vessels in relatively concentrated form.

Particulate matter is not taken into the tubules of the digitiform gland, except for an occasional granule, even though the particles are very small. In this the gland resembles the kidney, so the failure to take in granules does not argue against possible excretory function.

Excretory toxins caused congestion in all cases, but in only one animal receiving potassium chromate was the injury to the tubules very severe. Morgera ('16) obtained cytolysis of the tubules by cutting off the blood supply, and the congestion noted in our animals may account in this way for some of the degeneration noticed. One finds occasional cytolysed cells in the digitiform gland of normal animals. The question of cellular inanition must be considered in all experimental degeneration of tissues produced by administered toxins. The toxins we used certainly were injurious to erythrocytes, and this together with interference with blood supply in congested organs must deprive the cells of needed substances. However, we believe that a part of the injury seen was caused by the toxins which the gland was trying to excrete.

2. *Kidney*

The kidney (mesonephros) of the dogfish is of far less importance to the animal than the kidney (metanephros) of mammals, as has been noted previously. Denis ('12) found that adults produce an average of only 21.7 cc. of urine a day, and in our experiments the greatest amount of urine obtained was 24 cc. in twenty four hours, from an animal weighing more than 1.5 kg. The urea in the urine amounts to 0.6 to 1.4 per cent, or less than half the concentration of that in the blood (Baglioni, '06) and less than half that in mammalian urine. This difference is made up partly at least by a considerable amount of urea excreted in the bile. The great concentration of urea in the blood seems to be necessary to preserve life, for Baglioni ('05) found that isotonic (3.5 per cent) salt solution without urea was unsatisfactory for perfusion experiments. This requirement does not account for the small amount of urea excreted, as has

been argued, because, an equilibrium having been established, all urea formed would need to be eliminated. Hence if there is little urea excreted it is because relatively little is formed. The limited excretion of urea in the urine is dependent upon the metabolism, which must proceed at a slow rate in these forms, and also upon the amount of urea excreted in the bile.

MacCallum, in the 1917 Herter Lectures in New York, stated that the selachians entered the sea when its salt concentration was less than it now is and that as the sea became concentrated the selachians retained more and more urea in the blood to keep it isotonic with the sea-water.

We found that the dogfish kidney is able to excrete injected solutions quite as rapidly as the mammalian kidney and hence the inefficiency of the former is not one of rate of excretion, but of amount and of inability to eliminate certain kinds of substance. Non-toxic solutions of all kinds when injected into the muscles of the body wall appeared in the urine in fourteen or fifteen minutes, and when injected intravenously appeared in the urine in about eight minutes. In this rate the dogfish compares favorably with mammals (Rowntree and Geraghty, '12). The dogfish kidney would probably eliminate all of an injected solution in time, if it were not for the fact that the liver quickly eliminates the larger part of it. The liver is many times larger than the kidneys and has taken over much of the excretory function. As noted above, when pheno-sulphonethalein was injected, the liver excreted in a given time more than twice as much of it as did the kidneys, and in concentration many times greater. However, the difference in amount excreted by the two organs was less than the relative difference in size by which the liver surpasses the kidney.

Colored solutions stained the posterior part of the kidney more intensely than the anterior end, thus demonstrating the fact that in the former the excretory function is better developed than in the anterior or sexual (Felix, '12) end. The anterior region is able to excrete some part of solutions injected, so it is not entirely devoid of excretory function, as some investigators have believed. This point should be studied further. The

ability of the urine to reduce copper sulphate after sucrose had been injected demonstrates that the selachians can invert this sugar as mammals do (Kuryama, '16).

The dogfish kidney was not stained vitally by injected suspensions of various dyes, since they were not removed from the blood by the kidney, at least up to five days' time, even when administered in very considerable amounts. There was no difference in this respect between the reaction to very minute particles (trypan blue) or coarse granules (powdered carmine). One sample of neutral red passed through the kidney and one did not do so. The first probably formed a true solution. Attention of investigators should be called to the fact that some differences they obtain in the use of vital dyes in experiments may well be due to differences in the manufacture of these substances. Colloidal dyes, if impure, may be soluble.

The inability of the kidney of dogfish to remove particulate matter from the blood is another difference between this organ and the kidney of higher animals, as shown in the very numerous experiments of Chrzonszczewski ('64), Siebel ('86), Schmidt ('91), Muscatello ('95), Buxton and Torrey ('06), Suzuki ('12), Höber ('14), Kiyono ('14), Evans-Schuleman ('14), Downey ('17), and many others.

In higher animals the renal epithelium and sometimes the cavity of the glomerulus may be seen to contain particles that have been injected, but in the dogfish, if such matter is present in the kidney parenchyma or glomeruli, it is much too diffuse to be detected in our preparations. The only dye which really stained the kidneys in our animals was indigo-carmine, and this appeared to be in solution. Fresh kidney tissue was not examined microscopically in the trypan blue experiments, but it probably contained the pink substance that Wislocki noted in teleosts, as the urine was pink.

The endothelium of the renal capillaries in the dogfish is but poorly able to ingest particulate matter from the blood as compared with that of the renal portal vessels of teleosts, as described by Wislocki ('17). Wislocki found that this endothelium becomes blue from ingested dye after injections of trypan blue, while in our

animals up to five days only an occasional one of these cells was able to take in visible amounts of carmine or trypan blue. It is possible that after a greater length of time this endothelium in dogfish would react as does that of teleosts toward trypan blue. Wislocki also found a small amount of dye in the epithelium of the kidney in teleosts. This he believed might have been resorbed from the urine. Previous investigators have agreed with him (Cushny, '17). He also implies that the endothelium of the vessels in the kidney developed from the aorta is not able to take in and store trypan blue, but it is difficult in microscopical sections to distinguish the efferent glomerular vessels from renal-portal vessels.

Wislocki suggests three possible functions of the renal-portal endothelium in the kidney which he calls a mechanism. The first function is to prevent loss of colloidal metabolites, thus accounting for the relatively low output of nitrogen in fish urine, but the real reason for this is probably in the slow rate of metabolism in fish and a large output of nitrogen in the bile. The second function Wislocki attributes to the renal-portal endothelium is to protect the animal from toxic substances, but in an animal not being experimented on, any toxic substances present would more likely be in solution than in suspension, and solutions pass freely through the kidney. The third function referred to is a resorption of substances from the urine, but the reaction to trypan blue does not prove any such function, as it has not been shown that in these experiments the endothelium in question absorbed dye in this way. The possibility of such resorption of dyes has been considered previously, as noted above. All that Wislocki's experiments actually prove is that the endothelium of the renal vessels is phagocytic, but not very permeable, if permeable at all, to particulate matter.

The liver excretes particles freely, but whether such function failed to develop in the kidney because of this fact or whether the inability of the kidney to excrete particulate matter forced the liver to develop the function cannot be determined. Normally, particles in the circulation which are to be eliminated are mostly bile pigments which of course need not go into the urine.

The effects of excretory toxins on the kidney in dogfish are somewhat the same as in mammals, as described by Ophuls ('08, '11), Schlayer-Takayasu ('09), Suzuki ('12), Pohl ('12), Dickson ('12), Christian-O'Hare ('13), Underhill-Blatherwick ('14), Potter-Bell ('15), Tribe-Hopkins-Barcroft (16), and various others who administered potassium chromate, tartaric acid, and uranium nitrate. Denis ('13) noted that dogfish can withstand many times as much potassium chromate and uranium nitrate as will kill a mammal, and we can add tartaric acid to the list. One of our fish which received 200 mg. per kg. body weight of uranium nitrate lived for eighty hours. In extreme cases the dogfish kidney shows nearly complete destruction of the tubules by these poisons. The blood-vessels usually are not noticeably injured, but severe congestion occurs. The glomeruli, as in mammals, are injured only slightly when at all. Three distinct types of degenerative processes in the tubules are produced by all three of the toxins used. The deposit of hyaline substance in renal tubules in mammals after injection of tartaric acid was noted by Underhill-Blatherwick, and Christian-O'Hare found it in blood-vessels after uranium poisoning. Granular degeneration is probably a constant type in all such experiments, and hydropic degeneration usually but not always occurs with it. In our specimens there is some vacuolization in the cells showing the former type of degeneration, but some cells undergo cytolysis without first passing through granular change. The reason for these three different kinds of degeneration is not apparent. All three types were present in the same animal in some of the experiments and often two could be seen in a single tubule. They are not simply different steps in one and the same process as a study of the accompanying figures easily shows. In the hyaline type a definite new substance is formed. There are two distinct types of nuclear degeneration in our experiments with nephritis and they are exactly opposite in nature. In one type the nucleus absorbs water, swells to two or three times its normal size, and the nuclear substances gradually go into solution, while in the other type the nucleus becomes opaque and shrinks until it completely disappears. This shrinkage is

gradual at times and the nucleus retains a regular outline, but in other cases the loss of karyoplasm is sudden and the nuclear membrane collapses and is then irregular. Both types of nuclear degeneration are found in all the specimens examined and both may occur in the same tubule.

The cellular changes which one observes in nephritis are doubtless due to cellular inanition as well as to poisoning of the cells. Jackson ('16) has described some of these changes in the thyroid of starved rats. Congestion of the organs and injury or destruction of erythrocytes interferes with the general metabolism of the cells, thus bringing about inanition changes.

Differences in the process of degeneration in different cells and nuclei in nephritic kidneys may be influenced by their sudden or their slow death.

3. *Liver*

The liver of selachians and probably of other fish is a very important excretory organ, although Pillet ('90) stated that its biliary function is not well developed. Denis ('13) stated that the liver of dogfish apparently has an excretory function, but did not give any reasons for the belief. The liver, like the other organs of selachii contains a large amount of urea (Staedler-Frerichs, '58). v. Schroeder ('90) stated that this amounts to 1.36 per cent of the entire liver substance. Heidenhain ('83) found urea in the bile of selachians, Hammersten ('97) stated that it occurs there in large amounts, and Van Slyke-White ('11) determined the concentration of urea in the bile to be 1.7 per cent. This is greater than that in the urine (Baglioni, '06), and more than half as great as that in the blood (2.6 per cent, v. Schroeder, '90).

All the non-toxic solutions we injected were recovered in the bile. A quantitative determination of the relative amount of an injected solution (pthalein) excreted by the liver showed that there was present in the gall-bladder five and a half hours after injection three times as much pthalein as had been excreted in the urine. Some pthalein had escaped with bile into the intestine and some was still present in the bile ducts. In mammals

the kidneys normally excrete nearly all of such injected pthalein in four hours and very little appears in the bile at all (Rown-tree and Geraghty, '12). In mammals with tartrate nephritis, or with their renal veins ligated, injected pthalein is excreted by the liver (Underhill-Blatherwick, '14).

All of the injected granular dyes appeared in the bile in considerable concentration, and were not excreted by any organ other than the liver, so far as determined. Siebel ('86) believed that frogs and dogs receiving injections of carmine excreted such particles through the liver, lungs, and tonsils, and Kiyono ('14) and numerous other investigators have found that mammals excrete lithium carmine through the kidney.

In our experiments one sample of neutral red appeared after injection in both the urine and bile, but its concentration in the latter was more than eighty times as great as in the former. It is believed that some of this neutral red was in solution and that it was this part which passed through the kidney. The liver was able to excrete the dye both in the dissolved and in the granular form. Another sample of neutral red was excreted only in the bile.

Trypan blue after injection into dogfish collects in the hepatic parenchyma and the cells lining the sinusoids. Wislocki ('17) noted this also. It is excreted freely into the bile. In bony fishes Wislocki found that trypan blue entered the bile, but was not stored in the liver cells. He thought that it diffused directly into the bile ducts from the blood-vessels but more probably it passed through the liver cells too diffusely to be seen under the microscope.

In the dogfish there is present normally in the liver and bile a very large amount of bile pigment (Pillet, '90) and after injection of trypan blue some of the masses of pigment seen in sections of the liver contain both trypan blue granules and normal pigment mixed together. These masses of mixed pigment may be seen in the bile also, thus showing that the excretion of particulate matter by the liver is a normal function and is not due merely to experimental conditions. Experimenters are often inclined to overlook the fact that results they obtain do not

necessarily portray normal functions, because their experiments place their animals under abnormal conditions.

Excretory toxins usually caused congestion of the liver, but not serious injury to the parenchyma. We did not prove absolutely that the toxins passed through the liver into the bile, but we believe that they did so because all the other solutions and suspensions were recovered in the bile, and because the liver itself was injured by the toxins. Tests were made for uranium nitrate, but the green color of the bile prevented our determining whether the injected toxin was present or not. Injury to the liver was indicated by relatively few hyperchromatic shrunken nuclei and an increased amount of granular débris in the bile ducts. In none of the sections examined did more than 12 per cent of the nuclei appear injured. If the liver is able to eliminate excretory toxins, as it probably does, and without serious injury to itself, we must agree with Denis ('13) that this helps explain why dogfish are able to withstand large doses of such poisons.

4. Spleen

The spleen in the experiments with Weed's solution was seen to be impregnated with Prussian blue granules. This indicates that the vessels open directly into the pulp or else that the endothelium is very permeable to solutions because relatively more Prussian blue was found in this organ than in other non-excretory organs. The spleen of the dogfish seems to be very well adapted for phagocytic activity, although Wislocki ('17) believes that such is not the case in bony fishes.

Injected granules of dyes are taken up very quickly by the spleen which thus becomes deeply stained. In this respect it is equaled only by the liver. Injection of particulate matter was followed by a leucocytosis, and the number of mitotic figures seen in such cases is greatly increased.

Toxins caused congestion in the spleen in most specimens. In one uranium nitrate experiment there were present in the spleen a very large number of peculiar-shaped nuclei. These are found only occasionally in the other specimens. They

probably indicate an abnormal attempt at leucocytosis by amitotic division.

Other masses of lymphoid tissue were not examined, but they probably are phagocytic to dye granules.

5. Spiral valve and postvalvular intestine

Denis ('13) mentions the possibility of an excretory function possessed by the intestine of dogfish. Several of the solutions and dyes which we injected were found later in the spiral valve. However, these entered the intestine partly if not entirely in the bile. With Weed's solution Prussian blue was not deposited in the epithelium nor were any granules of injected dye found in it. Potassium iodide was obtained in the spiral valve after injection, but this will go through almost any gland and is not a specific test. Indigo-carmin did not stain the epithelium, nor could it be detected in the contents of the spiral valve. Experiments in which solutions of various kinds, including dyes, are injected, should be performed with dogfish in which bile is prevented from entering the intestine. We hope to do this at a later date. The toxins injected caused severe injury to the spiral valve whether the bile was permitted to enter the intestine or not. In every case there was severe congestion and destruction of a considerable amount of the epithelium. The capillaries in the mucosa ruptured producing hemorrhage into the intestine. These vessels were injured probably more than those in any other organ, although there was some vascular injury in the kidney. The spiral-valve contents were tested for the toxins that had been injected, but even with small amounts of blood and bile present the tests were not sufficient to determine the presence of the toxins. Probably more delicate tests would be successful. Our not finding some of the injected solutions in the spiral-valve contents also was due possibly to tests not sufficiently delicate. While the injury of the spiral valve by excretory toxins does not absolutely prove that this organ has normally an excretory function, it tends to support the theory. The fact that intestine posterior to the spiral valve was not injured at all by the injected poisons adds evidence in favor of this theory.

6. *Stomach*

A few solutions and one granular dye were recovered in the stomach, but the possibility of regurgitated bile was not eliminated as should have been done. Weed's Prussian blue was not deposited in the epithelium of the stomach nor were any of the injected dyes. The excretory toxins caused slight congestion of the stomach in some cases and in a few specimens the surface epithelium stained poorly. A small amount of cytolysis was present in some cases, but the slight damage noted in the stomach might have been done by toxin regurgitated from the intestine or by cell inanition resulting from vascular injury. Regurgitation is often observed.

Cecil-Weil ('17) found that after injection of Congo-red into patients with gastric ulcers it could be recovered in the stomach contents, but they admitted the fact that it is excreted in the bile and they did not eliminate the possibility of regurgitation of bile into the stomach. The stomach in selachians apparently is able to excrete only a few injected solutions, and is probably not normally an excretory organ of any importance, if it has this function at all.

7. *Gills*

In the experiments with non-toxic solutions the gills were examined in only those animals receiving Weed's solution. In these specimens Prussian blue was found in the blood-vessels of course, but there was none in the epithelium covering the gills nor in the connective tissue. This argues against the theory that the gills can excrete solutions. Since the gills are bathed by the isotonic sea-water, it would seem natural that solutions might diffuse into it from the branchial vessels, but we have no evidence that this occurs.

Granular dyes are ingested freely by the endothelium which lines the sinuses that are interposed between the arterial arches and the capillaries in the gill filaments. It is also ingested by the endothelium of the branchial arteries. In fact, in these cells of the gill sinuses the phagocytic function seems to be

more highly developed than in any other cells in the entire body. They are described in a previous section (see 'Experiments'). These cells lining the sinuses are one of the sources of free phagocytes which circulate through the body. Wislocki ('17) does not mention these cells in his discussion of endothelial phagocytes in fishes. He states that in no endothelium in fishes has trypan blue been seen except in the lymphatics, renal- and hepatic-portal vessels, and splenic sinuses. He apparently would use trypan blue to distinguish between blood-vascular endothelium (other than 'specialized' endothelium of the kidney, spleen, and liver) and lymphatic endothelium. He also would use trypan blue to solve the problem of the origin of lymphatics in fishes. We do not believe that trypan blue or other particulate substances can be used in this way. It is highly probable that more extensive research would disclose the fact that the endothelium in various blood-vessels, both arterial and venous, in different parts of the fish's body, is able to ingest trypan blue. The rate at which the dye moves through the vessels is probably one of the most important factors in this, as is believed by Downey ('17). This could be tested by decreasing the rate of blood flow in different vessels with ligatures or other means. Downey ('17) stopped the blood flow completely and found that the leucocytes could then ingest dye granules. In an attempt to distinguish between lymphatic and blood-vascular endothelium from the ingestion of trypan blue, one should not set aside all blood-vascular endothelium that is phagocytic to the dye as 'specialized endothelium.'

Cells in general react toward trypan blue as they do toward other small particles in the circulation and it is not to be used as a specific cure-all for our angiological troubles. Arey ('17) and Downey ('17) have pointed out several ways in which the use of trypan blue has been overdone.

In our experiments the sinuses in the gills were affected by toxins in somewhat the same way as those in the spleen. There was a proliferation of the endothelium to produce free phagocytes. Some of these cells stain poorly and in some the cytoplasm is coarsely granular. There are present in one specimen

poisoned with uranium nitrate, peculiarly shaped nuclei like those found in the spleen which probably indicate an abnormal amitosis.

8. *Body wall (muscles, skin, and peritoneum)*

In these tissues dyes were recovered only in the blood-vessels and connective tissue where an occasional phagocyte is seen. These tissues were not injured by the toxins so far as could be determined.

9. *Vascular system*

This system has already been discussed in part. Leucocytes and fixed phagocytes of endothelial and tissue origin were seen to contain trypan blue and carmine granules. Carmine was found ingested by endothelial cells lining the heart. Fixed phagocytes in the spleen, kidney, and gills apparently are injured by circulating toxins. Phagocytes containing carmine were found in the circulating blood within two hours after injection of the dye.

The blood-vessels of all the organs examined were congested by the excretory toxins injected, the most severe congestion occurring in the digitiform gland, kidney, and spiral valve. All three toxins—potassium chromate, tartaric acid, and uranium nitrate—caused injury to the erythrocytes, and when potassium chromate was injected directly into the blood-vessels these cells were destroyed, sometimes in a few minutes. Ophuls ('11) stated, in his paper on potassium chromate nephritis in mammals, that the cause of death in such experiments is not due to the injury to the kidney. It is probable that death is due to injury to the blood corpuscles, especially the erythrocytes. In all our sections of tissues, from animals that had received injections of excretory toxins, degenerated erythrocytes can be seen. When we injected potassium chromate intravascularly, the blood was laked and the hemoglobin oxidized, as shown by the 'granular' appearance and brown color of the blood at autopsy. Lymphatics were not stained by trypan blue or carmine to any noticeable extent up to the end of five days' time, although they might take up these dyes if more time were allowed.

SUMMARY AND CONCLUSIONS

1. Digitiform gland

The digitiform gland of *Mustelus* excretes about 1 cc. a day of clear alkaline fluid containing urea. Certain injected solutions, but no suspensions, were recovered in this excretion. Injections of excretory toxins injure this gland.

2. Kidney (mesonephros)

The selachian kidney is a less efficient excretory organ than the mammalian kidney (metanephros). The daily urine output amounts to about 18 cc. per kg. body weight, with a urea content of about 1 per cent (Baglioni, '06). The dogfish kidney excretes injected solutions as rapidly as the mammalian kidney, but only in small amounts, the solutions appearing in the urine in eight minutes after intravenous injection and in fourteen minutes after intramuscular injection. The dogfish kidney does not excrete injected particulate matter and the tubules are not noticeably stained by insoluble vital dyes, at least in five days. Large amounts of renal toxins (potassium chromate, tartaric acid, and uranium nitrate) are withstood by the dogfish for long periods. These toxins produce nephritis in which three different types of degeneration occur. These are hyaline, granular, and hydropic degeneration of the cytoplasm, especially of the excretory tubules. The nuclei are destroyed after either hyperchromatosis or hypochromatosis. Some of these cellular changes are due to inanition. The blood-vessels in the glomeruli and among the tubules are not seriously affected except after severe necrosis. The capsules of the glomeruli are only slightly injured.

3. Liver

The liver in dogfish is relatively a very efficient excretory organ. The bile contains 1.7 per cent of urea (Van Slyke-White, '11). The liver eliminates injected solutions and suspensions readily and in great concentration. In a given time the liver excretes injected solutions in several times the amount excreted by the kidney. The liver is the only organ in the

body definitely proven in our experiments as able to excrete particulate matter. It is stained deeply by such substances. The liver contains a great deal of normal pigment which is excreted in the bile in the same way that injected pigments are excreted, thus demonstrating that the latter act is a normal process.

Excretory toxins are probably excreted by the liver and they cause very little injury to this organ. When the kidneys were almost entirely destroyed, the liver showed slight injury to about 12 per cent of the nuclei, which were hyperchromatic and slightly shrunken, and in the bile ducts there was more than the usual amount of granular substance, probably degenerated cytoplasm. The vessels of the liver are discussed below.

4. Spleen

The spleen is very well adapted for phagocytic activity, and is stained deeply by injected insoluble dyes. Injected particles produce leucocytosis. Toxins cause congestion in the spleen, the endothelium appears to be injured, very peculiarly shaped nuclei may be produced, and many nuclei become hypochromatic.

5. Spiral valve

The spiral valve has previously been considered to possess excretory function and may have such function for certain dissolved substances, but not all solutions we injected could be recovered in the intestine and none of the dyes were taken up by the epithelium. Excretory toxins pass through this epithelium and destroy it, although they do not injure the intestine immediately anterior or posterior to the spiral valve. We believe with Denis ('13) that the spiral valve has some excretory function.

6. Stomach

A few injected solutions were recovered from the stomach, but we do not believe that this organ has an excretory function. Excretory toxins do not injure it directly and vital dyes do not stain its epithelium.

7. Gills

The endothelium lining the arterial arches and especially the large sinuses in the gills is very phagocytic to injected trypan blue and coarsely powdered carmine. It stores such substances in concentration greater than that in any other cells examined, and at the same time it proliferates and produces free phagocytes which circulate through the body. Such proliferation and an abnormal amitosis occur after injection of excretory toxins, which also seem to produce degeneration of these cells. There is no indication that the gills are able to excrete solutions or particulate matter into the water surrounding them. They are probably a normal source of phagocytes for the circulation.

8. Body wall

The muscles, skin, and peritoneum had in general a negative reaction to non-toxic solutions, vital dyes, and toxins.

9. Vascular system

The blood-vascular system reacted negatively to non-toxic solutions so far as determined, except that sucrose in the blood was inverted. Trypan blue and carmine were found in occasional leucocytes and endothelial cells in the blood-vessels of the kidney, digitiform gland, spiral valve, stomach, and body wall. Endothelium lining the branchial and splenic sinuses and hepatic sinusoids is very phagocytic toward trypan blue and carmine. The arterial arches of the gills are lined with endothelium phagocytic to trypan blue.

The lymphatics were not noticeably stained with vital dyes up to five days, but the subject needs further study.

Excretory toxins cause slight injury to the fixed endothelial phagocytes, especially in the spleen and gills. They cause congestion in all the organs especially in the kidney, digitiform gland, and spiral valve. If injected intramuscularly they cause slow degeneration of the erythrocytes, and if injected intravenously, sudden destruction of these cells. This destruction is probably the cause of death in some cases of experimental nephritis studied by other investigators.

LITERATURE CITED

- AREY, L. B. 1917 Phagocytosis by osteoclasts. *Anat. Rec.*, vol. 13.
- BAGLIONI, S. 1905 Die Bedeutung des Harnstoffs bei den Selachieren. *Zentral. f. Physiol.*, Bd. 19.
- 1906 Einige Daten zur Kenntnis der quantitativen Zusammensetzung verschiedener Körperflüssigkeit von Seetieren (Fischen und einige Wirbellosen). *Beitr. z. Chem. Physiol. und Pathol.*, Bd. 9.
- BLANCHARD, R. 1882 Sur les fonctions de la glande digitiforme ou superanale des Plagistomes. *Soc. Zool. d. France, Bull.* 7.
- BUXTON, H., AND TORREY, J. C. 1906 Absorption from the abdominal cavity. I. Absorption of particles in suspension. *Jour. Med. Res.*, vol. 10.
- CECIL, R. L., AND WEIL, R. 1917 The excretion of Congo red by the stomach. *Proc. Soc. Exp. Biol. and Med.*, vol. 14.
- CHRISTIAN, H. A., AND O'HARE, J. P., 1913 Glomerular lesions in acute experimental uranium nephritis in the rabbit. *Jour. Med. Res.*, vol. 28.
- CHRZONSZCZEWSKI, 1864 (cited by Cushny, '17, on injection of carmine).
- CRAWFORD, J. 1899 The rectal gland in elasmobranchs. *Proc. Roy. Soc. Edinburgh*, vol. 23.
- CUSHNY, A. R. 1917 The secretion of urine. Longmans Green & Co., New York.
- DENIS, W. 1912 Metabolism studies on cold-blooded animals. I. The urine of fish. *Jour. Biol. Chem.*, vol. 13.
- 1913 Note on the tolerance shown by elasmobranch fish toward certain nephrotoxic agents. *Jour. Biol. Chem.*, vol. 16.
- DICKSON, E. C. 1912 A further report on the production of experimental chronic nephritis in animals by the administration of uranium nitrate. *Arch. Int. Med.*, vol. 9.
- DISSELHORST, R. 1904 Ausführapparat und Anhangsdrüsen der männlichen Geschlechtsorgane. *Oppel's Lehrbuch der vergleichenden mikroskopischen Anatomie. Teil, IV.* G. Fischer, Jena.
- DOWNEY, H. 1917 Reactions of blood and tissue cells to acid colloidal dyes under experimental conditions. *Anat. Rec.*, vol. 12.
- EVANS, H. M., AND SCHULEMANN, W. 1914 The action of vital stains belonging to the benzidine group. *Science*, vol. 39.
- EVANS, H. M., BOWMAN, F. B., AND WINTERITZ, M. C. 1914 An experimental study of the histogenesis of the miliary tubercle in vitally stained animals. *Jour. Exp. Med.*, vol. 19.
- FELIX, W. 1912 Development of the urino-genital organs. *Keibel and Mall's Human Embryology*, vol. 2. Philadelphia.
- HAMMERSTEN, O. 1897 Über eine neue Gruppe gepaarter Gallensäuren. *Zeit. f. Physiol. Chem.*, Bd. 24.
- HAWK, P. B. 1912 *Physiological chemistry.* Blakiston's Sons, Philadelphia.
- HEIDENHAIN, R. 1883 Die Harnabsonderung. *Herman's Handbuch der Physiologie*, Bd. 5.
- HÖBER, R. 1914 *Physikalische Chemie der Zelle und der Gewebe.* Leipzig.
- HOSKINS, E. R. 1917 On the development of the digitiform gland and the post-valvular segment of the intestine in *Squalus acanthias*. *Jour. Morph.*, vol. 28.

- HOSKINS, E. R., AND HOSKINS, M. M. The reaction of Selachii to vital stains. *Proc. Am. Assoc. Anat., Anat. Rec.*, vol. 13.
- HYRTL, J. 1858 Das arterielle Gefäss-system der Rochen. *Deutschr. d. kais. Akad. d. Wissensch. Wien*, Bd. 5.
- KIYONO, K. 1914 Die vitale Karminspeicherung. G. Fischer, Jena.
- KURYAMA, S. 1916 The utilization of sucrose and the inverting power of the blood serum after parenteral administration of sucrose. *Jour. Biol. Chem.*, vol. 25.
- MORGERA, A. 1916 Ricerche sulla morfologia e fisiologia della glandola cecale (appendice digitiforme) degli Scyllium e sulla funzione del processo vermiforme dell' uomo e dei mammiferi. *Arch. Zool. ital., Liv.* 8.
- OPHULS, W. 1908 Some interesting points in regard to experimental chronic nephritis. *Jour. Med. Res.*, vol. 13.
1911 Experimental nephritis in guinea pigs by subcutaneous injections of chromates. *Proc. Soc. Exp. Med. and Biol.*, vol. 9.
- PILLIET, A. H. 1890 Recherches sur la structure du foie des Selachiens. *Comp. rend. Soc. Biol., Ser. 9, T.* 2.
- POHL, J. 1912 Über subakute nephritis. *Arch. f. exp. Path. und Pharm.*, Bd. 67.
- POTTER, R. C., AND BELL, E. T. 1915 Functional tests in experimental tartrate nephritis. *Amer. Jour. Med. Scien.*, vol. 149.
- RIBBERT, H. 1904 Die Abscheidung intra-venös injizierten gelösten Karmins in den Geweben. *Zeitschr. f. allgem. Physiol.*, Bd. 4.
- ROWNTREE AND GERAGHTY, J. T. 1912 An experimental and clinical study of phenosulphonethalein in relation to renal function in health and disease. *Arch. Int. Med.*, vol. 9.
- SCHLAYER UND TAKAYASU, R. 1909 Untersuchung über die kranken Nieren. *Deutsch. Arch. f. klin. Med.*, Bd. 98.
- SCHMIDT, A. 1891 Zur Physiologie der Niere. Über den Ort und den Vorgang der Karminabscheidung. *Arch. f. d. ges. Physiol.*, Bd. 48.
- VON SCHROEDER, W. 1890 Über die Harnstoffbildung der Haifische. *Zeitschr. f. Physiol. Chem.*, Bd. 14.
- SIEBEL, W. 1886 Über das Schicksal von Fremdkörpern in der Blutbahn.
- STAEDELER AND FRERICHS, L. 1858 *Jour. f. pract. Chem.*, Bd. 73 (cited).
- SUZUKI, T. 1912 Zur Morphologie der Nieren-sekretion unter physiologischen und pathologischen Bedingungen. G. Fischer, Jena.
- TRIBE, E. M., HOPKINS, F. G., AND BARCROFT, J. 1916 Vascular and metabolic conditions in kidneys of rabbits injected with uranium nitrate. *Jour. Physiol.*, vol. 50.
- UNDERHILL, F. P., AND BLATHERWICK, N. R. 1914 The elimination of phenosulphonethalein in acute and chronic nephritis, *Jour. Biol. Chem.* vol. 19.
- VAN SLYKE, D. D., AND WHITE, G. F. 1911 Digestion of protein in the stomach and intestine of dogfish. *Jour Biol. Chem.*, vol. 9.
- WEED, L. H. 1914 Studies on cerebro-spinal fluid. II. The theories of drainage of cerebro-spinal fluid with an analysis of the methods of investigation. *Jour. Med. Res.*, vol. 26.
- WISLOCKI, G. B. 1917 The action of vital dyes on teleosts. *Anat. Rec.*, vol. 12.

PLATES

PLATE I

EXPLANATION OF FIGURES

VITAL DYES

1 Spleen four days after injection of coarse carmine granules. The black bodies are carmine. Insert shows an endothelial cell with a pseudopodial process full of carmine.

2. Liver five days after injection of trypan blue. Black bodies are trypan blue except in the cell at x which contains both trypan blue and normal black pigment.

3 to 5 Gill five days after injection of trypan blue. Figure 3 shows arterial arch and sinuses at the base of the filaments lined with endothelium which has ingested trypan blue, and containing free phagocytes filled with the dye; figure 4 shows normal endothelium from a sinus, and figure 5 shows two sinuses from figure 3, showing the reaction to the injected dye. The phagocyte at x contains both blue and black granules.

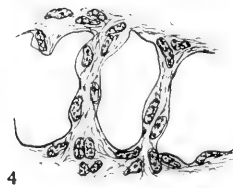
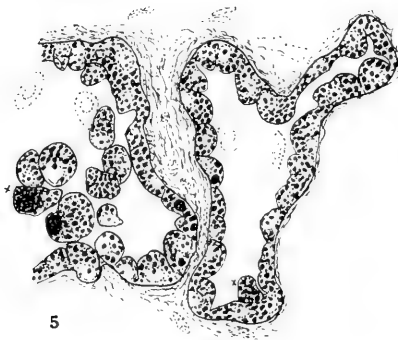
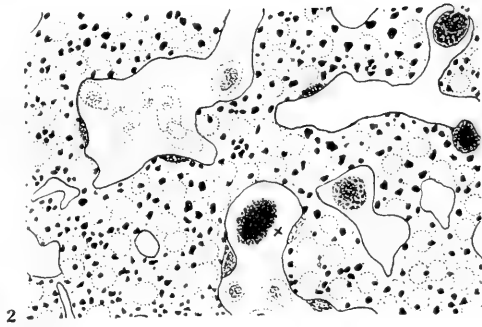

PLATE 2

EXPLANATION OF FIGURES

KIDNEY. POTASSIUM CHROMATE

- 6 Normal excretory tubule.
- 7 Glomerulus and collecting tubule after poisoning. Note the shrunken nuclei and vacuoles.
- 8 Excretory tubule. Note the granular degeneration and shrunken nuclei.
- 9 Extreme case of granular degeneration. The supporting connective tissue has broken and allowed the débris to spread. Desquamated cells become round. Hyaline and hydropic degeneration not shown.

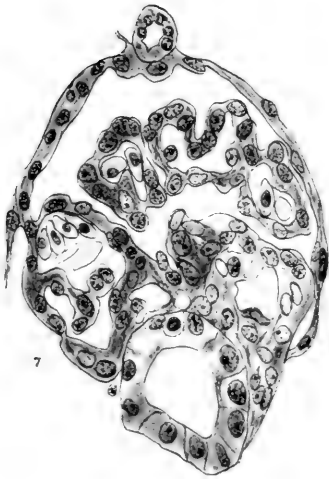
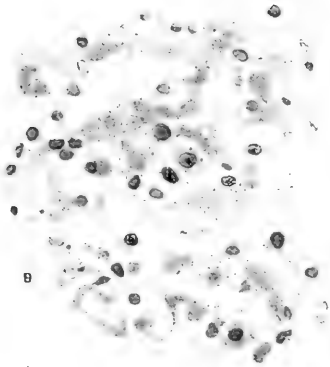
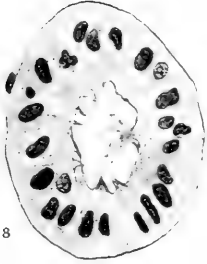

PLATE 3

EXPLANATION OF FIGURES

DIGITIFORM GLAND. POTASSIUM CHROMATE

- 10 Shows congestion at the center and cytolysis at the periphery.
- 11 Shows a normal tubule.
- 12 and 13 Show different degrees of cytolysis with shrunken, opaque nuclei.

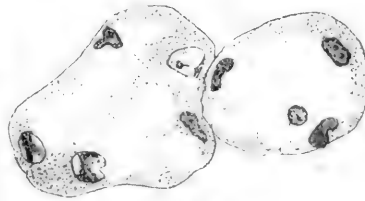
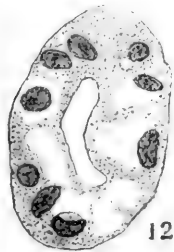

PLATE 4

EXPLANATION OF FIGURES

SPIRAL VALVE. POTASSIUM CHROMATE

14 Normal spiral valve.

15 Effect on spiral valve of potassium chromate poisoning. Note the loss of innermost epithelium. Severe congestion. The entire section is poorly stained, although it was prepared similarly and stained simultaneously with the section shown in figure 14.

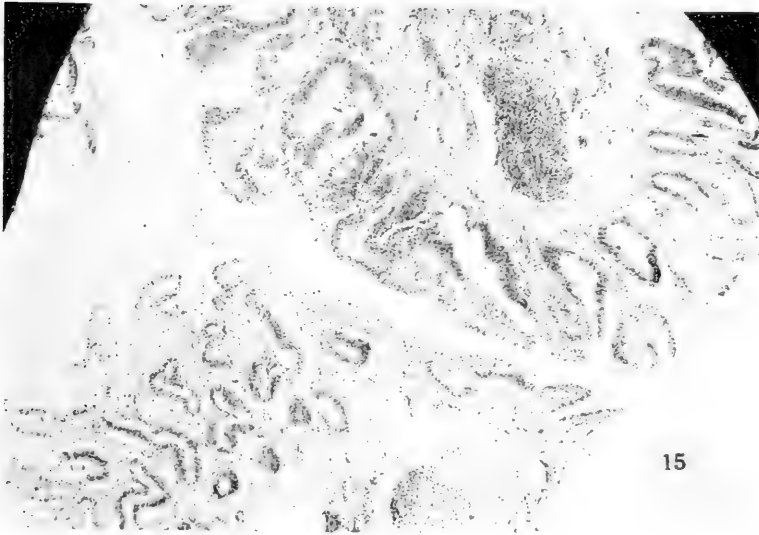
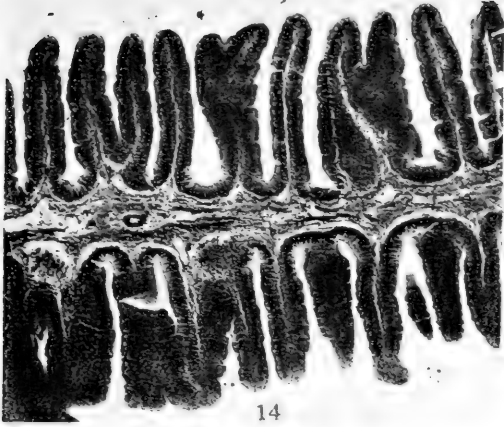

PLATE 5

EXPLANATION OF FIGURES

KIDNEY. TARTARIC ACID

- 16 Normal kidney.
- 17 Kidney poisoned with tartaric acid. Note the shrunken nuclei, broken tubules, and débris. The very small black bodies in the cells of the excretory tubules are of eosinophilic hyaline substance.
- 18 Normal excretory tubule.

EFFECT OF TARTARIC ACID

- 19 Small excretory tubule showing granular degeneration with shrunken opaque nuclei.
- 20 Extreme stage of granular degeneration. The tubule is represented by a mere mass of débris. Note the surrounding cells with large eosinophilic granules.
- 21 Hyaline degeneration, showing hyaline droplets and shrunken nuclei.

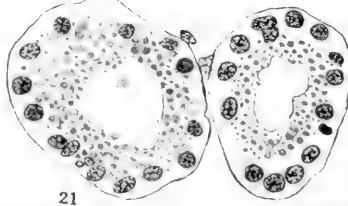
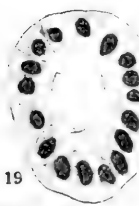
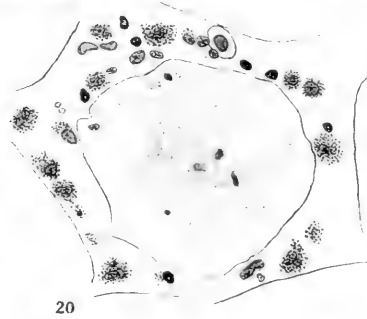
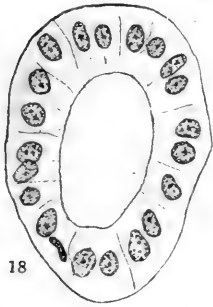
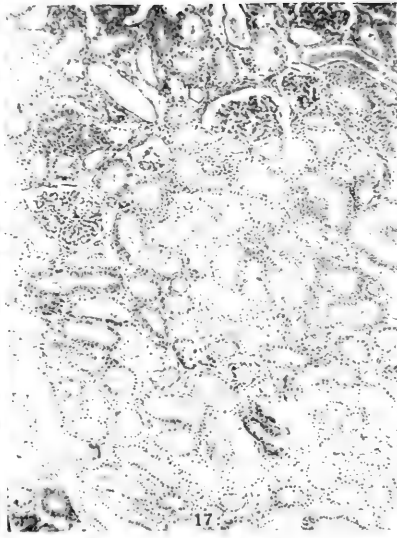
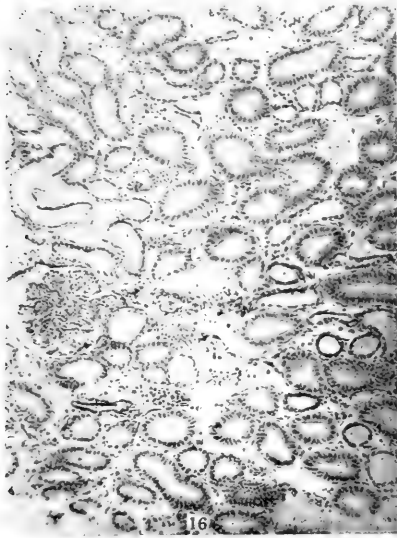

PLATE 6

EXPLANATION OF FIGURES

KIDNEY, SPLEEN, AND GILL. URANIUM NITRATE

(See figure 18 for normal kidney)

- 22 Mild granular degeneration.
- 23 Late granular degeneration.
- 24 Granular and hydropic degeneration, but not typical of the latter type.
- 25 Beginning of hyaline degeneration. Late stage not shown.
- 26 Nuclei found in the blood-vessels and connective tissue of kidney, coming probably from endothelium of spleen and gills.
- 27 Nuclei from the endothelium of the spleen and gill sinuses and probably representing abnormal amitosis in production of phagocytes. The cell 'x' represents a mitotic figure seen in the spleen.

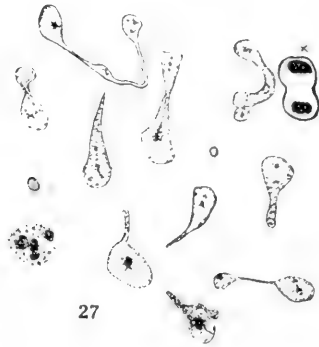
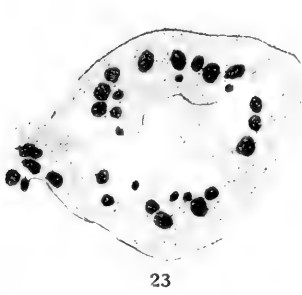



FLUCTUATIONS IN A RECESSIVE MENDELIAN CHARACTER AND SELECTION¹

ELMER ROBERTS

University of Illinois, Urbana, Illinois

TWO PLATES AND THREE TEXT-FIGURES

CONTENTS

I. Introduction	157
II. Material and methods	158
1. Sources of error	160
III. Experimental data	161
1. Selected series A	161
a. Effect of selection	161
b. Control series B	163
c. Effect of temperature	163
2. 'Crossed-in-and-selected' series C	164
a. Effect of selection	164
b. Effect of 'crossing-in'	166
c. Effect of temperature	168
3. Form of wings	169
IV. Summary of results	170
V. Discussion	171
1. Effect of selection	171
2. Effect of 'crossing-in'	172
VI. Literature cited	176
Plates	178
Tables	182

I. INTRODUCTION

During the past few years there has been much discussion concerning the purity of the germ-plasm and the constancy of Mendelian characters. Johannsen, De Vries, and others have

¹ Paper No. 7 from the Laboratory of Genetics, Department of Animal Husbandry, University of Illinois. The writer wishes to acknowledge his indebtedness to Dr. J. A. Detlefsen, under whose direction the work was carried on, for many valuable suggestions and criticisms.

maintained that in asexually reproduced organisms and in individuals arising by self-fertilization selection is futile except for the purpose of isolating pure lines. The original interpretation of a pure line was that it consisted of the offspring of a self-fertilized individual. Later, the term, pure line, was extended to homozygous characters in individuals reproduced dioeciously or biparentally. It has been the belief of the majority of workers in genetics that selection only separates pure lines and is ineffective when applied to a unit character. Such an hypothesis must also assume a gametic or factorial purity which is unchanging except through mutation.

The questions with which the present investigation deals are:

1. Does long-continued selection have an effect upon a Mendelian character?
2. Can there be a gametic or factorial contamination of a character, and, if so, is selection then efficacious?

II. MATERIAL AND METHODS

In *Drosophila ampelophila*, the fruit fly, there is a wingless or vestigial winged variety, the origin of which was described by Morgan and Lynch ('12). This vestigial wing behaves as a recessive character when crossed to individuals with normal long wings. The offspring in the first generation have long wings while in the second generation both long-winged and vestigial-winged are produced. However, the ratio of long-winged to vestigial-winged is not 3:1. In this experiment, 9248 F₂ individuals were produced, 7381 of which were long-winged and 1867 vestigial, or a ratio 3.95:1. With this number of individuals such a departure from a 3:1 ratio cannot be attributed to chance. Morgan explains the departure from the theoretical ratio as being due to the low viability of the vestigial-winged variety. A vestigial and a normal wing are shown in plate 1, figures 1 and 14. This character, vestigial wing, is well adapted to such an investigation as outlined, because it is a well-defined Mendelian character and shows some variability in size and venation. The stock was originally obtained through the courtesy of Prof. T. H. Morgan, of Columbia University.

One male and one female were taken at random as the beginning of all the series. From the offspring of these two individuals, the male and female with the longest vestigial wings were used to begin selected series A. The brothers and sisters of these bred inter se started control series B to be used as a check. The third series, which will be referred to as 'crossed-in-and-selected' series C, had its origin as follows: ten selected males from the sixteenth generation of selected series A were crossed to long-winged females of wild *Drosophila* obtained from bananas in a local grocery. The first generation was long-winged, while in the second, long-winged and vestigial-winged appeared. Selection was begun among the vestigial-winged segregates of the second generation, those individuals with the longest vestigial wings being used as parents of the next generation, and so on. Some of the vestigial-winged males of the second generation of the cross were mated again to long-winged females. This process of 'crossing-in' was repeated eight times in some of the series, but in this paper a series which was crossed-in only once is reported for the reason that it consists of a larger number of generations than any of the others. Duplicate series were also run, formed by crossing vestigial-winged females to long-winged males, the reciprocal of the above cross.

The length of the vestigial wing is the measurement used to determine the effect of selection and of 'crossing-in.' The ideal method would have been to measure the surface of the wing and note the venation, but this was prohibitive on account of the labor involved. However, the length is a good character to use as an indication of any changes in size. It is better than width, for in large thin vestigial wings, curling sometimes renders the measurement of the width impossible or extremely difficult. The generations were preserved in 75 per cent alcohol and measurements made later.

In all cases selections were made by simple inspection with a hand lens, the effectiveness of which can be seen from tables 1, 3, 5, 6, 7 and 9.

Measurements were made by the use of a camera lucida, tracing the length of the wing and measuring the line thus pro-

duced. The most convenient method of placing the flies under the microscope was by means of a grooved microscopic slide, using glycerin to support them in a horizontal position. The magnification is 29 expressed in millimeters. This magnification is used in the text and tables without reduction to actual sizes. In generations containing several hundred individuals, one hundred of each sex, taken at random, were measured.

In selecting the parents, the length of the vestigial wing was not the only factor taken into consideration. The goal in view was a perfect wing, hence the breadth and the position of the wing relative to the body of the fly were also considered. The usual method of feeding fermented banana, as described by Morgan, Sturtevant, Muller and Bridges ('15), was used.

1. Sources of error

As a possible source of error, it may be mentioned that the wings were broken off in some cases, rendering the inclusion of such individuals in the tabulations impossible. This was more common among the parents than among the others of the generation, since the parents were kept much longer before preservation than were the others. Some of the parents died in the breeding bottles and occasionally the wings became mutilated to such an extent that measurement was impossible. Also there was a slight tendency to curling and shrinking among the larger wings, this type being more common among parents selected for wing length.

For the most part, mass selection was practiced because of the danger of losing the series if only two individuals were used. Consequently, those selected for parents differed in size of vestigial wing. Therefore, one cannot be sure which of those selected were the actual parents of the next generation in case all did not mate or if mating was indiscriminate. Since the average of the parents was always larger than the average of the generation from which they were selected, except in cases where all the offspring were used as parents, this is not a very serious objection.

The object of the experiment was to select toward the normal long wing. In some instances individuals with shorter wings were given preference in selection, for the reason that they approached more nearly the long-wing type in form and venation.

It is assumed that the expression of this somatic character, vestigial wing, is an index of the germinal constitution. In any selection experiment, without the progeny test, selection is effective only when the somatic character is an index of the germinal constitution to some degree at least. However, environmental factors may affect the somatic expression and thus render selection less effective.

III. EXPERIMENTAL DATA

1. *Selected series A*

This series began, as described in section II, with a mating of a vestigial-winged male and female taken at random, and was continued for thirty-four generations. Table 1 gives the means, standard deviations, and coefficients of variability of males and females in each generation. The males and females are treated separately in order to show any sex differences.

a. Effect of selection. In table 5 are found the weighted average wing lengths of parents and offspring for each generation in selected series A. By an inspection of text figure 1, which is constructed from table 5, it is at once seen that no increase in size of wing was made during the process of selection. This is further borne out by the correlation between the average wing length of the parents and that of the offspring which is

$$r = + 0.329 \pm 0.103.$$

This correlation is not significant when judged by the probable error. To be sure, a marked correlation is not necessarily a measure of the amount of progress made by selection, for environment may produce a significant correlation, but it is obvious that if there is no significant correlation between the size of the parents and the size of the offspring selection is of no avail.

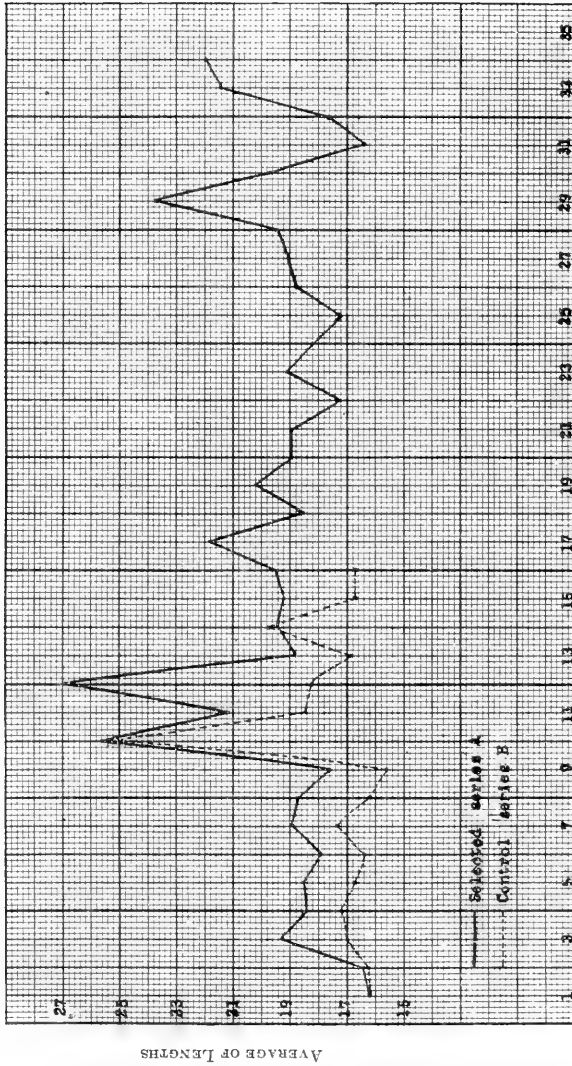

Text-figure 1. Average lengths of vestigial wings in selected series A and control series B.

GENERATIONS

From table 1, it is to be noted that some generations are much more variable than others when judged by the standard deviations which range from 2.11 ± 0.010 to 11.30 ± 0.60 in the males and 1.69 ± 0.17 to 7.68 ± 0.49 in the females. The coefficients of variability are 10.85 ± 1.58 to 42.50 ± 2.61 for the males and 8.86 ± 0.89 to 31.66 ± 2.19 for the females. The means of the wing lengths of the different generations vary from 16.23 to 26.88.

b. Control series B. Control series B had its origin in the random mating of the brothers and sisters of the two individuals used for selected series A, and was carried for sixteen generations. Table 2 gives the means, standard deviations, and coefficients of variability of the males and females separately, while in table 4 are found the averages of the wing lengths of males and females in the different generations.

This series shows in general the same things as selected series A. It is to be noted from text figure 1, which is constructed from the means of the generations given in table 4, that the wing length in the control series is smaller in every generation, except the F_{14} , than in the selected series. It is thought that this difference is due to the method of handling rather than to any inherent difference. In the selected series only a few parents were in the breeding bottle and the offspring were removed every eighteen hours or more often, while in the control series, the flies were not removed so frequently and a large number of parents was used. The food conditions and space in the breeding bottles were not so favorable in the control as in the selected series. In working with the flies, one received the impression that those of the control series were smaller than those of the selected series. Measurements of the body lengths of males in the sixth generation of each series were made, giving 62.9 for the selected and 60.4 for the control. Males were measured in preference to the females in this comparison because the body size in the males is more constant than in females due to the presence or absence of eggs in the latter.

c. Effect of temperature. The high means in the F_{10} generation of control series B and in the F_{10} , F_{12} , and F_{29} generations of se-

lected series A occurred during the summer of 1914 and 1915 when there was extremely warm weather. The connection between high temperature and size of wing was unknown at first and consequently no temperature records were kept during the first part of the experiment. Thereafter records were kept and a series of flies was subjected to high temperature in an incubator, the outcome of which is discussed later in this paper. It is significant to note that during the production of the F_{29} generation in selected series A, higher temperature occurred than in either the F_{28} or F_{30} generation. The males are more affected than the females, as can be seen from the means, standard deviations, and coefficients of variability in the generations noted above (tables 1 and 2).

2. 'Crossed-in-and-selected' series C

This series was obtained as described in section II, by the crossing of ten vestigial-winged males from the F_{16} generation of selected series A with long-winged females. Selection was started among the vestigial-winged segregates appearing in the second subsequent generation. Table 3 exhibits the means, standard deviations, and coefficients of variability of males and females separately. The means of the males and females combined are given in table 6.

a. Effect of selection. Text figure 2 is constructed from the means of the generations given in table 6. By an inspection of this graph, one cannot say that selection has been effective. If the experiment had been brought to an end in the twenty-first generation, probably one would have concluded that selection had been effective, but such fluctuations as are found in the F_{22} and F_{29} generations prevent such a conclusion. However, it may have been that the somatic appearance was not always an index of the germinal constitution, in which case there is a possibility that selection may have been effective, but that environmental factors suppressed the full expression of the germinal potency or constitution. Under the conditions of this experiment, selection had no visible effect upon the expression of the character in question.

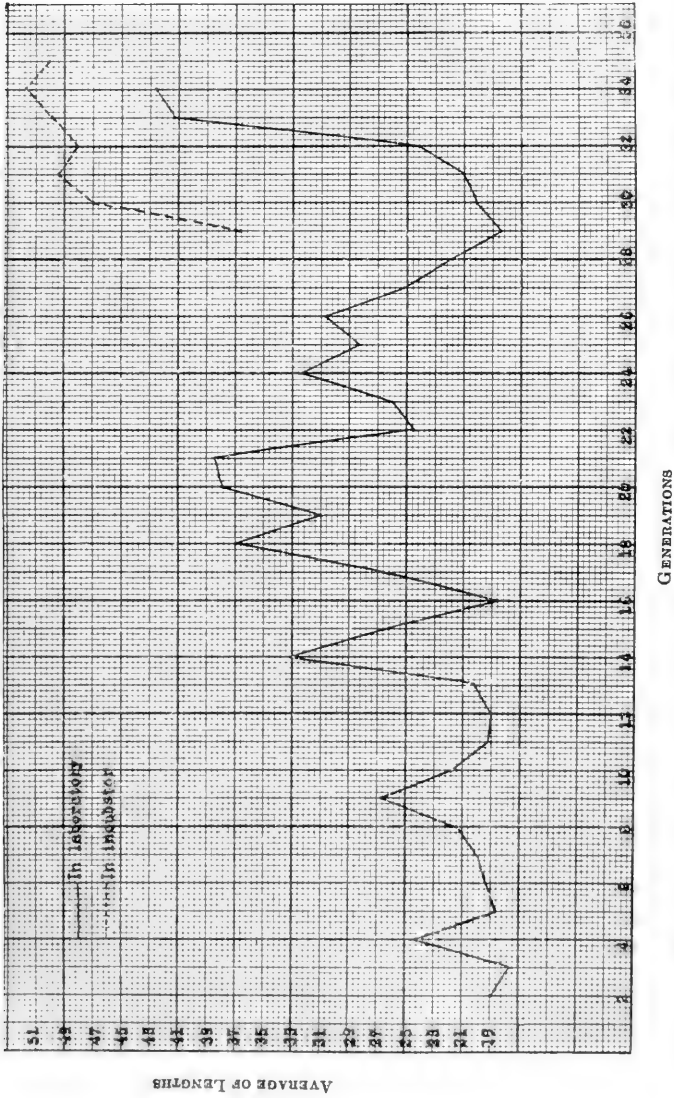

Text-figure 2. Average of lengths of wings in 'crossed-in-and-selected' series C and of generations produced in the incubator.

b. Effect of 'crossing-in.' If selection had no effect in either of the two series, then the differences existing must have some other explanation. It will be of value to compare the generations in the two series, which were produced during the same period of time. Generations F_{22} to F_{34} of selected series A and F_7 to F_{19} of 'crossed-in-and-selected' series C were produced at the same time and were subject to the same conditions, except that the latter series had been crossed to long-winged stock a few generations back in its history.

Text figure 3 shows the curves of the means for the contemporary generations of these series noted above. In only one case, the twelfth generation, does the 'crossed-in-and-selected' series fall as low as the simple selected series. By taking the average of the means of the males and females in each of these series, we have 19.07 ± 0.069 for selected series A (F_{22} to F_{34}) and 25.62 ± 0.12 for 'crossed-in-and-selected' series C (F_7 to F_{19}). This is a significant difference. As the average of all the generations in each series, we have 19.27 ± 0.043 for selected series A and 25.68 ± 0.073 for 'crossed-in-and-selected' series C. This is also a significant difference when judged by their probable errors.²

The males were more affected by 'crossing-in' than were the females. The average of the males for generations noted above in the 'crossed-in-and-selected' series is 27.99 ± 0.19 and of the females 23.40 ± 0.14 . That this difference is due to having been crossed with the long wing is proved by the fact that in the generations of selected series A produced at the same time (F_{22} to F_{34}) the average of the males is 19.43 ± 0.11 , and of the females 18.69 ± 0.078 . For all the generations in 'crossed-in-and-selected' series C, the males average 27.70 ± 0.12 and the females 23.73 ± 0.090 , while selected series A gives 19.40 ± 0.068

² The probable error of an average of averages was calculated from the formula:

$$E = \frac{1}{N} \sqrt{n_1^2 e_1^2 + n_2^2 e_2^2 + \dots + n_m^2 e_m^2}$$

in which n is the number of individuals in the generation, e the probable error, and N the total number of individuals.

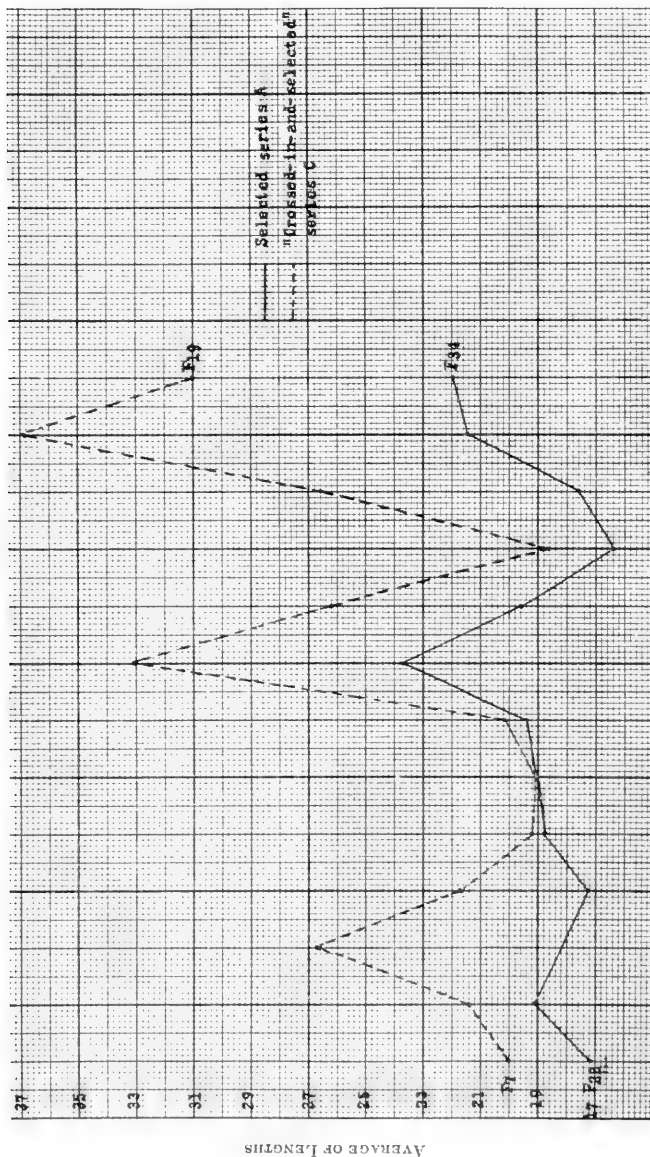

GENERATIONS

Text-figure 3. Generations F₂₂ to F₃₄ in selected series A, and F₇ to F₁₉ in the 'crossed-in-and-selected' series C.

for the males and 19.13 ± 0.052 for the females. There can be no doubt, then, that 'crossing-in' has modified the character.

c. Effect of temperature. In this series, as in the other, high temperature increased the size of the wing, and the increase was greater among the males than among the females. To determine more exactly the effect of temperature, the following experiment was performed. After the parents were selected for the F_{29} generation of 'crossed-in-and-selected' series C, they were allowed to deposit eggs in four bottles, two of which were put into an incubator set to run from 27°C. to 28°C. The temperature, however, ranged from 26.7°C. to 35.7°C. This high temperature was caused by the extremely warm weather in the summer of 1916. The other two bottles were kept at the laboratory temperature, which ranged from 18°C. to 35.1°C. , but for the most part around 22°C. to 24°C. Readings were made twice daily, morning and evening. The average temperature in the incubator during the experiment was 28.4°C. and in the laboratory 25.9°C. Table 7 gives the means, standard deviations, and coefficients of variability of males and females separately. Table 9 gives the means of the generations by combining the males and females.

From text figure 2 a comparison can be made between the generations produced in the incubator and those kept in the laboratory. The difference is very marked even though the temperature in the laboratory approached that in the incubator, due to the hot summer weather. The average of the means of the males and females in the laboratory is 24.49 ± 0.14 and of those in the incubator 42.79 ± 0.25 . These averages are for F_{29} to F_{33} generations in both the laboratory and incubator series. It must be clear, then, that temperature has a marked effect upon the somatic expression of vestigial wings.

It is to be noted that in the incubator series the F_{29} generation has a much lower mean than any of the other generations. The two bottles were not placed in the incubator until after all the eggs had been deposited and many pupae formed. This seems to indicate that the effect of high temperature took place between the fertilization of the egg and the pupal stage.

From tables 3 and 7 it is to be seen that the coefficients of variability have decreased in the generations produced under high temperature, but that the standard deviations are about the same. This does not necessarily mean that the range of variation has decreased. Since the coefficient of variability is obtained by dividing the standard deviation by the mean, $C = \frac{\sigma}{M}$, it is quite obvious that as M increases, C decreases if σ remains constant. When dealing with biological materials of the same kind, standard deviation is sometimes a much safer criterion of variability than the coefficient of variability.

Another fact brought out by an inspection of table 7 is that there is little difference between the males and females with regard to length of wing. The average for the males is 45.90 ± 0.26 and for the females 42.50 ± 0.35 (F_{29} to F_{35}). By leaving out of the calculations the F_{29} generation which underwent some of its development outside of the incubator, the averages become 49.25 ± 0.23 for the males and 48.35 ± 0.27 for the females. This shows a much smaller difference than above, and is not significant when judged by their probable errors. Judging from the very large differences existing between the males and females in the series outside the incubator, it seems that the males are more easily affected by high temperature than are the females, but that under constantly high temperature both males and females were equally affected.

3. *Form of wings*

Some of the types of wings found in these series are shown in plate 1. There is great variability in the size, shape, and venation. A very good graded series could have been obtained from the normal vestigial type (1) to the normal long wing (14). Figure 13 shows a common type of wing produced in the high-temperature series and less frequently in the other series. It is in size and venation like a normal long wing. Other types similar to 'strap,' truncate, and beaded as described by Morgan ('16) appeared.

In none of the series did the individuals breed true for the type of wing possessed. Under high temperature the size, judged by length of wing, was constantly much larger than the normal vestigial wing, but the form was variable, though more wings were produced like the normal long wing than under any other conditions. It is interesting to compare the length of wings in wild *Drosophila* with the length of vestigial wings found in this experiment. For twenty-four wild males the average length is 57.7 and for twenty-six females 68. Some of the vestigial wings were as long as the long wings of the wild stock. The position of the wing in relation to the body was also variable. In the normal vestigial-winged fly, the wing seems to be stationary and projects from the side of the body at an angle of about 60° . In many of the flies with large vestigial wings produced in these series, the wings were in the position of the normal wing and some functioned as normal wings. In fact, a few individuals escaped by flying away. These wings were thinner than those of the wild *Drosophila*.

In vestigial-winged *Drosophila* the balancers are much reduced in size. Normal balancers from long-winged flies are shown in plate 2, figures 21 and 22, while figures 15 and 16 show the balancers from normal vestigial-winged flies. In those flies with large vestigial wings, balancers of the normal type were present (figs. 17 to 20).

Unfortunately, the experiment was brought to a close by the hot weather and further work on fixing these types was brought to an end.

The other series, previously noted, obtained by crossing vestigial-winged individuals two, four, and eight successive times to long-winged, gave in general the same results as the series reported at length in this paper.

IV. SUMMARY OF RESULTS

1. Selection failed to modify the size of vestigial wing in *Drosophila* (tables 5 and 6, and text figs. 1 and 2).
2. The size and form of the vestigial wing were affected by crossing to long-winged flies (tables 1 and 3, and text fig. 3).

3. The males showed greater effects from 'crossing-in' than did the females (table 3).

4. The size and form of the vestigial wing were affected by high temperature (tables 1, 2 and 3, and text figs. 1 and 2).

5. The males were more easily affected by high temperature than were the females (tables 1 and 2).

V. DISCUSSION

1. *Effect of selection*

It is possible to assume that selection had no effect upon the size of vestigial wing in this experiment, because of the gametic purity of this character. Upon this assumption the variability was due to environmental factors alone and under such conditions one would not expect selection to be effective. Such an hypothesis is supported by evidence from the work of Johannsen ('03, '09) with beans, Jennings ('09) with the protozoan *Paramecium*, Tower ('06) with the potato-beetle, *Leptinotarsa decemlineata*, Ewing ('14 a, '14 b, '16) with *Aphis*, and Lashley ('15, '16) with *Hydra*.

However, there is also evidence that in some cases unit-characters do change under the process of selection. Castle and Phillips ('14) found that the amount of pigment in the hooded rat could be increased or decreased at will by selection. Cuénot ('04) noted the same results in working with spotted mice. The work of Jennings ('16) on *Diffugia corona*, the reproduction of which is uniparental, showed that selection was effective in changing the number and length of spines and size of body. Similar results were obtained by Middleton ('15) with *Stylonychia* and Stocking ('15) with *Paramecium*. All of these results may be explained by assuming that the factors themselves are variable. Castle held this view concerning the hooded character in rats. The pure-linist attempts to explain Castle's results upon the assumption that modifiers are present and that selection separates diverse types. Concerning the work of Jennings on *Diffugia*, Morgan ('16) says: "If through sexual union (a process that occurs in *Diffugia*) the germ plasm (chromatin) of these

wild types has in times past been recombined, then selection would be expected to separate certain types again, if, at division, irregular sampling of the germ plasm takes place."

In this case Morgan desires proof that the characters were not in a heterozygous condition. On the other hand, the question might be asked if there is any proof of the occurrence of irregular sampling of the germ plasm in *Diffugia*.

Since an environmental factor, temperature, affects the vestigial wing to a marked degree, a consistent germinal selection may not have been in operation in these experiments. In generations occurring at a time favorable to the production of large vestigial wings, selection was easily possible, but in generations when the vestigial wing was inhibited by a low temperature, selection of individuals potent for larger wings could not be made except as they were included by chance.

2. *Effect of 'crossing-in'*

The data establish beyond question that crossing the vestigial-winged flies to normal long-winged had a very marked influence on increasing the size of vestigial wings in the 'crossed-in' series. Castle ('15) reported on some unpublished work of Dr. D. H. Wenrich that the extracted vestigials from a vestigial, long-wing cross showed greater variability in length of wing than did the uncrossed. To what this increase is due is not known, but there are two possible explanations:

1. The increased size and variability may have been due to the introduction of modifying factors from the wild stock, these factors acting more effectively when the temperature was higher than the normal; or

2. A gametic contamination may have occurred when the vestigial wing factor came into association with its allelomorph, long wing (or the association of the developer for wings with the absence of this developer).

There is some evidence in favor of the first explanation gained from the following experiment performed to test this view. A large vestigial-winged male from F_{32} generation produced in the

incubator, having a wing of the general form shown in plate 1, figure 13, was mated to small vestigial-winged females from the original stock. This cross was carried through the second generation and was kept from the beginning in the incubator. Table 8 summarizes the means, standard deviations, and coefficients of variability of the males and females separately. It is to be noted that the variability in the second generation, when judged by the standard deviation, is greater than in the first—a condition to be expected if differential factors were involved. The difference between the males in the first and second generations is not highly significant when judged by the probable errors, but that between the females is. However, the variability of the males is greater in the second generation than in the first. The average variability of the males and females combined in the F_1 generation is 5.81 ± 0.48 and in the F_2 9.93 ± 0.76 . That the males are more affected than the females is again brought out in this cross.

The correlation between the averages of wing lengths in the parents and in the offspring for the 'crossed-in' series is expressed by

$$r = 0.528 \pm 0.086$$

This probably indicates that both parents and offspring were produced at a time favorable to the development of large vestigial wings.

If the increased size and variable form of wing are due to factors, the original stock must have contained at least some of these factors since, under high temperature, the size and form of wing were much affected in the simple selected series (table 1). Morgan ('16) writes concerning the vestigial wing character: "This condition arose at a single step and breeds true, although it appears to be influenced to some extent by temperature, also by modifiers that sometimes appear in the stock."

Morgan and Lynch ('12) state that the vestigial wing was crossed to the long wing and segregated again in order to increase viability. Hence, factors may have been introduced and carried in the stock from that time, and were effective only when temperature was favorable.

There are other cases in *Drosophila* of factors which find expression only under certain environmental conditions. Miss Hoge ('15) found that in a certain stock of *Drosophila* supernumerary legs were produced in a Mendelian ratio at about 10°C., but at normal temperature this character was very rare. Morgan ('15) described the case of abnormal abdomen in which the black bands, normally present, are broken and irregular or entirely absent. This abnormal condition is induced by the presence of moist food, but when the food becomes more dry, the individuals that emerge are entirely normal in appearance. Dexter ('14) also found that more beaded wings were produced in a wet culture than in a dry, and more in alkaline than in acid cultures. Extra number of bristles in *Drosophila* was decreased by a scanty food supply (MacDowell, '15).

Further investigation under a constant environment will be necessary before one can come to a conclusion concerning the efficacy of selection on the size of vestigial wing. On the basis of this explanation, selection failed because the somatic expression of this character was not indicative of the full germinal potency.

The second plausible explanation of the increased size and variability of the vestigial wing in the 'crossed-in' series is factorial contamination. Castle, particularly, held that such a contamination might occur—that gametes are subject to change and inconstant. Castle and Forbes ('06) concluded that there was contamination of the germ-cells produced by the cross-breds of long- and short-haired guinea pigs, due to the association of the factors for long and short hair. Likewise, MacCurdy and Castle ('07) were of the opinion that the gametes of cross-breds from a cross of hooded and Irish rats had changed because the extracted patterns were somewhat changed. Contamination of the gametes would mean variation of the unit-character in question. It was the variability in this hooded pattern of rats which furnished the foundation for the extensive selection experiment by Castle and Phillips ('14). The results of their experiment showed that the amount of pigment could be diminished or increased at will by selection. They adopted the hypothesis that

some of the variability was due to modifying factors, but later Castle ('16) claimed to have disproved that modifying factors were concerned because there was no decrease in the rapidity of change after seventeen successive selections. For this and other reasons Castle (Castle and Wright, '16; Castle, '17) rejects the hypothesis of modifying factors.

On the other hand, Marshall and Muller ('17) found that the factor for balloon wing which is variable showed no evidence of contamination after having been in association with its allelomorph for more than fifty generations. Morgan ('15) concluded from the evidence furnished by the character, abnormal abdomen, that no contamination of genes or gametes occurred. The expression of this character is dependent upon the environment, rendering it possible for the individual to be normal in appearance when the character is either heterozygous or homozygous for abnormal. If the environment is favorable, a heterozygous individual will be abnormal. In none of his work did Morgan find any evidence to support the theory of gametic contamination.

Either gametic contamination or modifying factors would cause characters to vary, and in both cases progress by selection would be possible. Zeleny and Mattoon ('15) found that the number of facets in 'bar eye' *Drosophila* could be increased or decreased by selection. They are inclined to the belief that the variability in the number of facets is due to 'differences in factorial composition.' MacDowell ('15) showed that selection was effective in increasing the number of extra bristles in *Drosophila*. He says: "The hypothesis of accessory factors will explain all the facts, and that of modification of a Mendelian factor may be employed to interpret most of them."

Morgan ('16) reports that in his laboratory Muller selected for shorter wings in the truncate stock of *Drosophila* and obtained individuals at the end of the experiment with much shorter wings than those with which he started. He showed by means of linkage experiments "that at least three factors were present that modified the wings." Dexter ('14) found that the variability of beaded wing was affected by a modifying factor in the second chromosome, which could be eliminated or preserved, thus making

selection effective. Lutz ('11) decreased the length of veins in the wings of *Drosophila*. Whether modifying factors were involved in this case is not known. All must agree that unit characters vary, but there is some difference of opinion as to whether the germinal cause of variability is modifiers or gametic contamination.

It might be thought that selection was effective, since the flies placed in the incubator at high temperature showed constantly large wings. This, however, may have been due to crossing the vestigial-winged to long-winged flies, introducing factors from the long-winged stock which would have increased the wing size among the vestigial winged segregates in the second generation, if the environment had been favorable. It is also conceivable that there was a factorial contamination which would show fully only under high temperature.

Why the males were affected more easily by temperature than the females is not known. Investigation is now in progress with some hope of finding evidence on this point.

VI. LITERATURE CITED

- CASTLE, W. E. 1915 Mr. Muller on the constancy of Mendelian factors. *Am. Nat.*, vol. 49, pp. 37-42.
 1916 *Genetics and eugenics*. Harvard Univ. Press. Cambridge.
 1917 Piebald rats and multiple factors. *Am. Nat.*, vol. 51, pp. 102-114.
- CASTLE, W. E., AND ALEXANDER FORBES 1906 Heredity of hair-length in guinea-pigs and its bearing on the theory of pure gametes. Carnegie Instit. Wash., Publ. No. 49.
- CASTLE, W. E., AND JOHN C. PHILLIPS 1914 Piebald rats and selection. Carnegie Instit. Wash., Publ. No. 195.
- CASTLE, W. E., AND SEWALL WRIGHT 1916 Studies of inheritance in guinea-pigs and rats. Carnegie Instit. Wash., Publ. No. 241.
- CUÉNOT, L. 1904 L'hérédité de la pigmentation chez les souris. (3me note.) *Arch. de Zool. expér. et gén.* (Sér. 4), T. 2, notes et Revue, pp. 45-46.
- DEXTER, JOHN B. 1914 The analysis of a case of continuous variation in *Drosophila* by a study of its linkage relations. *Am. Nat.*, vol. 48, pp. 712-758.
- EWING, H. E. 1914 a Pure line inheritance and parthenogenesis. *Biol. Bull.*, vol. 26, pp. 25-35.
 1914 b Notes on regression in a pure line of plant lice. *Biol. Bull.*, vol. 27, pp. 164-168.

- EWING, H. E. 1916 Eighty-seven generations in a parthenogenetic pure line of *Aphis avenae* Fab. *Biol. Bull.*, vol. 31, pp. 53-112.
- HOGUE, MILDRED A. 1915 The influence of temperature on the development of a Mendelian character. *Jour. Exp. Zool.*, vol. 18, pp. 241-297.
- JENNINGS, H. S. 1909 Heredity and variations in the simplest organisms. *Am. Nat.*, vol. 43, pp. 321-337.
1916 Heredity, variation and the results of selection in the uniparental reproduction of *Diffugia corona*. *Genetics*, vol. 1, pp. 407-534.
- JOHANNSEN, W. 1903 *Über Erblichkeit in Populationen und in reinen Linien*. Jena.
1909 *Elemente der exakten Erblichkeitslehre*. Jena.
- LASHLEY, K. S. 1915 Inheritance in the asexual reproduction of *Hydra*. *Jour. Exp. Zool.*, vol. 19, pp. 157-210.
1916 Results of continued selection in *Hydra*. *Jour. Exp. Zool.*, vol. 20, pp. 19-26.
- LUTZ, FRANK E. 1911 Experiments with *Drosophila ampelophila* concerning evolution. *Carnegie Instit. Wash.*, Publ. No. 143.
- MACCURDY, HANSFORD, AND W. E. CASTLE 1907 Selection and cross-breeding in relation to the inheritance of coat-pigments and coat-patterns in rats and guinea-pigs. *Carnegie Instit. Wash.*, Publ. No. 70.
- MACDOWELL, E. C. 1915 Bristle inheritance in *Drosophila*. *Jour. Exp. Zool.*, vol. 19, pp. 61-98.
- MARSHALL, WALTER W., AND HERMANN J. MULLER 1917 The effect of long-continued heterozygosis on a variable character in *Drosophila*. *Jour. Exp. Zool.*, vol. 22, pp. 457-470.
- MIDDLETON, A. R. 1915 Heritable variations and the results of selection in the fission rate of *Stylynychia pustulata*. *Jour. Exp. Zool.*, vol. 19, pp. 451-503.
- MORGAN, T. H. 1915 The rôle of the environment in the realization of a sex-linked Mendelian character in *Drosophila*. *Am. Nat.*, vol. 49, pp. 385-429.
1916 *A critique of the theory of evolution*. Princeton University Press, Princeton.
- MORGAN, T. H., AND CLARA J. LYNCH 1912 The linkage of two factors in *Drosophila* that are not sex-linked. *Biol. Bull.*, vol. 25, pp. 174-182.
- MORGAN, T. H., A. H. STURTEVANT, H. J. MULLER, AND C. B. BRIDGES 1915 *The mechanism of Mendelian heredity*. New York, Henry Holt & Co.
- STOCKING, RUTH J. 1915 Variations and inheritance in abnormalities occurring after conjugation in *Paramecium cadatum*. *Jour. Exp. Zool.*, vol. 19, no. 4, pp. 387-449.
- TOWER, W. L. 1906 An investigation of evolution in Chrysomelid beetles of the genus *Leptinotarsa*. *Carnegie Instit. Wash.*, Publ. No. 48.
- ZELENY, CHARLES, AND E. W. MATTOON 1915 The effect of selection upon the 'bar eye' mutant of *Drosophila*. *Jour. Exp. Zool.*, vol. 19, pp. 515-529.

PLATE 1

EXPLANATION OF FIGURES

Photographs of camera-lucida drawings. $\times 38$.

1 Short vestigial wing.

2, 3, 5, 6, 8, 9 From selected series A.

4, 7, 10, 12 From 'crossed-in-and-selected' series C.

13 From the 'crossed-in-and-selected' series subjected to high temperature.

14 Normal long wings.

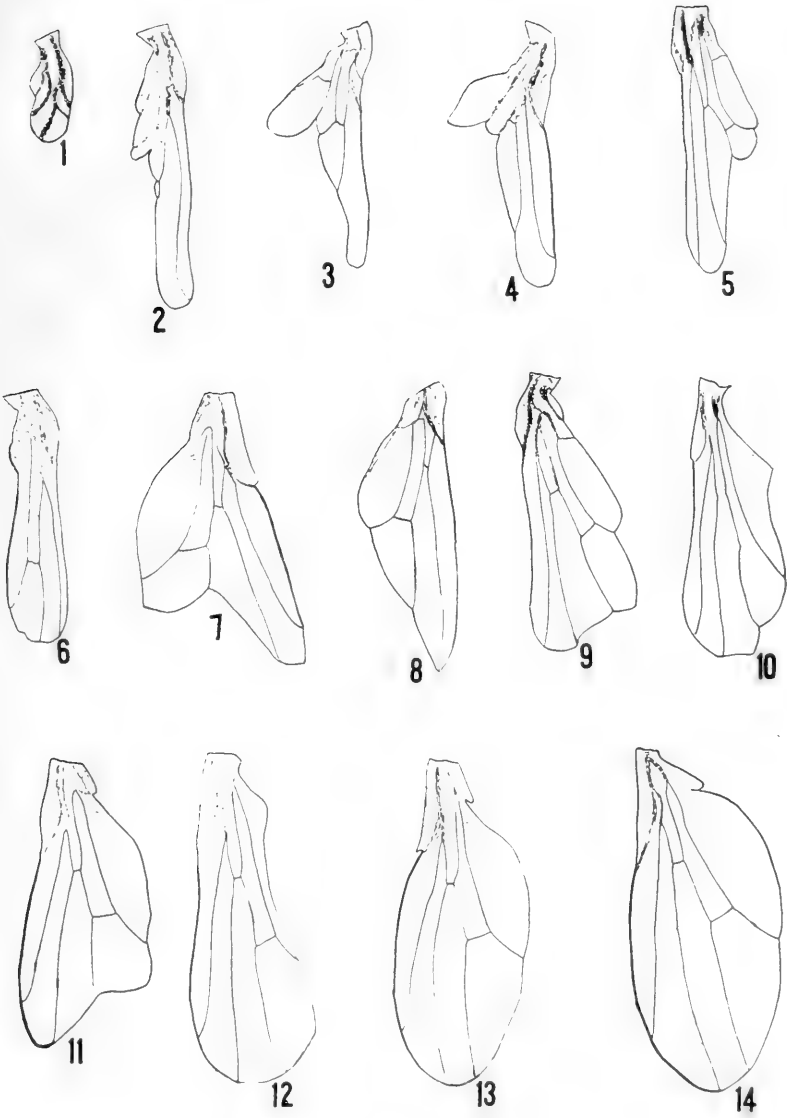

PLATE 2

EXPLANATION OF FIGURES

Photographs of camera-lucida drawings of balancers. $\times 50$.
15, 16 From short vestigial winged flies.
17, 18, 19, 20 From vestigial-winged flies with large wings.
21, 22 From normal long-winged.



15



16



17



18



20



19

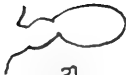

21



22

TABLE 1

Means, standard deviations, and coefficients of variability of length of vestigial wings in selected series A

GENERATION	SEX	PARENTS		OFFSPRING			
		Number	Means	Number	Means	Standard deviation	Coefficient of variability
F ₁	♂	1	18.00	9	16.22 ± 0.92	4.08 ± 0.65	25.15 ± 4.24
	♀	1	22.00	21	16.24 ± 0.41	2.79 ± 0.29	17.18 ± 1.84
F ₂	♂	1	23.00	54	16.69 ± 0.24	2.57 ± 0.17	15.40 ± 1.02
	♀	1	16.00	45	16.04 ± 0.33	3.25 ± 0.23	20.26 ± 1.50
F ₃	♂	1	20.00	23	19.41 ± 0.67	4.74 ± 0.47	24.42 ± 2.57
	♀	3	17.33	23	19.09 ± 0.24	1.69 ± 0.17	8.86 ± 0.89
F ₄	♂	4	27.75	52	18.19 ± 0.20	2.13 ± 0.14	11.71 ± 0.79
	♀	4	20.75	37	18.81 ± 0.31	2.80 ± 0.22	14.89 ± 1.19
F ₅	♂	6	19.33	40	17.35 ± 0.27	2.50 ± 0.19	14.41 ± 1.11
	♀	8	20.00	47	19.45 ± 0.31	3.19 ± 0.22	16.40 ± 1.17
F ₆	♂	2	19.50	89	17.97 ± 0.22	3.01 ± 0.15	16.75 ± 0.87
	♀	7	22.86	64	17.92 ± 0.22	2.61 ± 0.16	14.56 ± 0.89
F ₇	♂	5	22.40	72	18.97 ± 0.23	2.85 ± 0.16	15.02 ± 0.86
	♀	7	21.43	64	18.75 ± 0.25	2.99 ± 0.18	15.95 ± 0.97
F ₈	♂	6	20.00	77	18.65 ± 0.25	3.24 ± 0.18	17.37 ± 0.97
	♀	5	22.80	85	18.75 ± 0.21	2.91 ± 0.15	15.52 ± 0.82
F ₉	♂	5	24.40	100	17.08 ± 0.20	3.00 ± 0.14	17.56 ± 0.86
	♀	7	20.57	100	18.06 ± 0.22	3.31 ± 0.16	18.33 ± 0.90
F ₁₀	♂	9	20.67	82	26.59 ± 0.84	11.30 ± 0.60	42.50 ± 2.61
	♀	10	19.80	57	24.26 ± 0.69	7.68 ± 0.49	31.66 ± 2.19
F ₁₁	♂	14	44.50	100	21.48 ± 0.28	4.20 ± 0.20	19.55 ± 0.97
	♀	12	35.75	100	20.76 ± 0.23	3.34 ± 0.16	16.09 ± 0.79
F ₁₂	♂	9	28.78	14	28.50 ± 1.41	7.82 ± 1.00	27.44 ± 3.75
	♀	10	24.60	12	25.00 ± 0.77	3.98 ± 0.55	15.92 ± 2.25
F ₁₃	♂	6	35.83	34	19.00 ± 0.28	2.40 ± 0.20	12.63 ± 1.05
	♀	7	26.29	56	18.68 ± 0.27	2.97 ± 0.19	15.90 ± 1.04
F ₁₄	♂	3	21.33	100	20.06 ± 0.33	4.89 ± 0.23	24.38 ± 1.23
	♀	8	21.00	100	18.75 ± 0.22	3.31 ± 0.16	17.66 ± 0.87

TABLE 1—Continued

GENERATION	SEX	PARENTS		OFFSPRING			
		Number	Means	Number	Means	Standard deviation	Coefficient of variability
F ₁₅	♂	8	26.75	43	18.99 ± 0.44	4.32 ± 0.31	22.75 ± 1.74
	♀	5	19.40	44	19.32 ± 0.34	3.37 ± 0.24	17.44 ± 1.29
F ₁₆	♂	10	22.20	78	18.88 ± 0.30	3.99 ± 0.22	21.13 ± 1.19
	♀	10	22.70	69	20.12 ± 0.35	4.35 ± 0.25	21.62 ± 1.30
F ₁₇	♂	8	24.63	28	21.43 ± 0.54	4.26 ± 0.38	19.88 ± 1.86
	♀	7	26.29	39	22.01 ± 0.35	3.26 ± 0.25	14.81 ± 1.16
F ₁₈	♂	8	24.89	100	18.07 ± 0.19	2.75 ± 0.13	15.22 ± 0.74
	♀	11	23.73	100	19.18 ± 0.19	2.88 ± 0.14	15.02 ± 0.73
F ₁₉	♂	8	20.87	80	19.70 ± 0.22	2.96 ± 0.16	15.03 ± 0.82
	♀	9	20.67	68	20.74 ± 0.33	4.07 ± 0.24	19.62 ± 1.18
F ₂₀	♂	5	22.20	51	17.98 ± 0.27	2.87 ± 0.19	15.96 ± 1.09
	♀	7	25.57	30	20.43 ± 0.56	4.52 ± 0.39	22.12 ± 2.02
F ₂₁	♂	5	20.60	44	18.32 ± 0.33	3.23 ± 0.23	17.63 ± 1.31
	♀	5	23.20	50	19.50 ± 0.32	3.35 ± 0.23	17.18 ± 1.19
F ₂₂	♂	6	20.50	111	16.74 ± 0.14	2.11 ± 0.10	12.60 ± 0.58
	♀	8	20.63	109	17.66 ± 0.16	2.46 ± 0.11	13.93 ± 0.65
F ₂₃	♂	4	18.25	50	19.20 ± 0.27	2.88 ± 0.19	15.00 ± 1.03
	♀	7	21.00	37	19.03 ± 0.36	3.21 ± 0.25	16.87 ± 1.36
F ₂₄	♂	6	22.50	83	19.10 ± 0.35	4.77 ± 0.25	24.97 ± 1.39
	♀	7	23.29	100	17.42 ± 0.17	2.55 ± 0.12	14.64 ± 0.71
F ₂₅	♂	7	26.57	100	17.09 ± 0.15	2.26 ± 0.11	13.22 ± 0.64
	♀	12	20.00	99	17.38 ± 0.17	2.45 ± 0.12	14.10 ± 0.69
F ₂₆	♂	4	21.50	39	18.33 ± 0.26	2.45 ± 0.19	13.37 ± 1.04
	♀	8	21.00	25	19.52 ± 0.30	2.23 ± 0.21	11.42 ± 1.10
F ₂₇	♂	5	20.60	47	18.89 ± 0.38	3.87 ± 0.27	20.49 ± 1.48
	♀	6	20.67	38	19.21 ± 0.41	3.74 ± 0.29	19.47 ± 1.56
F ₂₈	♂	6	24.67	28	18.71 ± 0.31	2.43 ± 0.22	12.99 ± 1.19
	♀	7	23.71	26	20.15 ± 0.47	3.52 ± 0.33	17.47 ± 1.68

TABLE 1—*Concluded*

GENERA- TION	SEX	PARENTS		OFFSPRING			
		Num- ber	Means	Num- ber	Means	Standard deviation	Coefficient of variability
F ₂₉	♂	3	21.67	117	24.77 ± 0.56	8.95 ± 0.39	36.13 ± 1.79
	♀	4	24.00	101	22.41 ± 0.40	6.02 ± 0.29	26.86 ± 1.36
F ₃₀	♂	7	36.57	25	20.00 ± 0.34	2.50 ± 0.24	12.50 ± 1.21
	♀	8	33.38	21	19.19 ± 0.48	3.28 ± 0.34	17.09 ± 1.83
F ₃₁	♂	6	21.83	61	16.52 ± 0.20	2.28 ± 0.14	13.80 ± 0.86
	♀	10	20.30	85	16.26 ± 0.18	2.52 ± 0.13	15.50 ± 0.82
F ₃₂	♂	5	18.20	100	17.86 ± 0.25	3.75 ± 0.18	21.00 ± 1.04
	♀	9	18.00	100	17.32 ± 0.16	2.36 ± 0.11	13.63 ± 0.66
F ₃₃	♂	5	28.00	114	22.43 ± 0.45	7.19 ± 0.32	32.06 ± 1.57
	♀	9	20.11	104	20.38 ± 0.26	3.89 ± 0.18	19.09 ± 0.92
F ₃₄	♂	3	35.00	11	20.55 ± 0.45	2.23 ± 0.32	10.85 ± 1.58
	♀	4	31.50	14	23.07 ± 0.61	3.39 ± 0.43	14.69 ± 1.91

TABLE 2

Means, standard deviations, and coefficients of variability of length of vestigial wings in control series B

GENERATION	SEX	NUMBER	MEAN	STANDARD DEVIATION	COEFFICIENT OF VARIABILITY
P ₁	♂	1	18.00		
	♀	1	22.00		
F ₁	♂	9	16.22 ± 0.92	4.08 ± 0.65	25.15 ± 4.24
	♀	21	16.24 ± 0.41	2.79 ± 0.29	17.18 ± 1.84
F ₂	♂	19	16.32 ± 0.41	2.64 ± 0.29	16.18 ± 1.82
	♀	17	16.24 ± 0.40	2.46 ± 0.28	15.15 ± 1.79
F ₃	♂	100	16.36 ± 0.25	3.74 ± 0.18	22.86 ± 1.15
	♀	106	17.66 ± 0.18	2.72 ± 0.13	15.40 ± 0.73
F ₄	♂	9	17.89 ± 0.82	3.63 ± 0.58	20.29 ± 3.36
	♀	12	16.67 ± 0.45	2.32 ± 0.32	13.92 ± 1.95
F ₅	♂	65	17.53 ± 0.30	3.57 ± 0.21	20.37 ± 1.25
	♀	78	16.10 ± 0.26	3.41 ± 0.18	21.18 ± 1.19
F ₆	♂	13	17.08 ± 0.38	2.02 ± 0.27	11.83 ± 1.59
	♀	19	15.95 ± 0.37	2.37 ± 0.26	14.86 ± 1.66
F ₇	♂	59	17.76 ± 0.26	2.97 ± 0.18	16.72 ± 1.07
	♀	56	16.73 ± 0.25	2.74 ± 0.17	16.38 ± 1.07
F ₈	♂	61	16.30 ± 0.21	2.39 ± 0.15	14.66 ± 0.91
	♀	58	16.19 ± 0.24	2.74 ± 0.17	16.92 ± 1.09
F ₉	♂	88	15.78 ± 0.18	2.48 ± 0.13	15.72 ± 0.82
	♀	96	15.42 ± 0.16	2.35 ± 0.11	15.24 ± 0.76
F ₁₀	♂	133	26.77 ± 0.65	11.15 ± 0.46	41.65 ± 2.00
	♀	110	23.57 ± 0.54	8.43 ± 0.38	35.77 ± 1.82
F ₁₁	♂	67	19.02 ± 0.53	6.48 ± 0.38	34.07 ± 2.20
	♀	91	18.01 ± 0.27	3.83 ± 0.19	21.27 ± 1.11
F ₁₂	♂	93	18.42 ± 0.27	3.93 ± 0.19	21.34 ± 1.10
	♀	78	18.05 ± 0.23	3.05 ± 0.16	16.90 ± 0.94
F ₁₃	♂	75	16.63 ± 0.21	2.65 ± 0.15	15.94 ± 0.90
	♀	67	17.21 ± 0.23	2.78 ± 0.16	16.15 ± 0.97

TABLE 2—*Concluded*

GENERATION	SEX	NUM- BER	MEAN	STANDARD DEVIATION	COEFFICIENT OF VARIABILITY
F ₁₄	♂	54	21.43 ± 0.50	5.42 ± 0.35	25.29 ± 1.74
	♀	81	18.64 ± 0.33	4.39 ± 0.23	23.55 ± 1.32
F ₁₅	♂	24	16.42 ± 0.30	2.16 ± 0.21	13.15 ± 1.30
	♀	38	16.92 ± 0.17	1.51 ± 0.12	8.92 ± 0.70
F ₁₆	♂	79	16.92 ± 0.20	2.63 ± 0.14	15.54 ± 0.85
	♀	83	16.53 ± 0.18	2.48 ± 0.13	15.00 ± 0.80

TABLE 3

Means, standard deviations, and coefficients of variability in 'crossed-in-and-selected' series C

GENERATION	SEX	PARENTS		OFFSPRING			
		Number	Means	Number	Means	Standard deviation	Coefficient of variability
F ₁	♂	10	20.50		Long winged		
	♀	12	Long winged		Long winged		
F ₂	♂		Long winged	102	19.74 ± 0.40	5.96 ± 0.28	30.19 ± 1.55
	♀		Long winged	97	18.06 ± 0.21	3.02 ± 0.15	16.72 ± 0.83
F ₃	♂	5	36.60	102	17.81 ± 0.21	3.08 ± 0.15	17.29 ± 0.84
	♀	8	23.62	100	17.49 ± 0.17	2.52 ± 0.12	14.41 ± 0.70
F ₄	♂	3	22.67	12	24.58 ± 1.33	6.82 ± 0.94	27.75 ± 4.10
	♀	2	25.00	7	23.71 ± 0.75	2.96 ± 0.53	12.48 ± 2.28
F ₅	♂	5	30.20	24	19.50 ± 0.67	4.90 ± 0.48	25.13 ± 2.60
	♀	7	23.71	33	18.39 ± 0.29	2.49 ± 0.21	13.54 ± 1.14
F ₆	♂	4	28.25	53	19.27 ± 0.34	3.68 ± 0.24	19.10 ± 1.30
	♀	6	21.50	45	19.51 ± 0.29	2.86 ± 0.20	14.66 ± 1.06
F ₇	♂	6	25.00	72	21.36 ± 0.42	5.33 ± 0.30	24.95 ± 1.49
	♀	7	22.29	112	19.04 ± 0.14	2.27 ± 0.10	11.92 ± 0.54
F ₈	♂	5	34.00	70	23.01 ± 0.43	5.32 ± 0.30	23.12 ± 1.39
	♀	7	21.86	94	20.29 ± 0.20	2.90 ± 0.14	14.29 ± 0.72
F ₉	♂	5	30.40	64	30.50 ± 0.66	7.83 ± 0.47	25.67 ± 1.63
	♀	8	24.00	61	22.81 ± 0.47	5.48 ± 0.33	24.02 ± 1.55
F ₁₀	♂	12	39.42	58	21.71 ± 0.53	5.97 ± 0.37	27.50 ± 1.85
	♀	18	28.83	62	21.61 ± 0.33	3.86 ± 0.23	17.86 ± 1.12
F ₁₁	♂	3	32.00	10	19.30 ± 0.76	3.58 ± 0.54	18.55 ± 2.89
	♀	7	29.14	11	19.18 ± 0.64	3.16 ± 0.45	16.48 ± 2.43
F ₁₂	♂	4	22.50	20	19.20 ± 0.84	5.56 ± 0.59	28.96 ± 3.34
	♀	6	21.67	18	18.89 ± 0.47	2.94 ± 0.33	15.56 ± 1.79
F ₁₃	♂	4	28.75	60	21.53 ± 0.55	6.26 ± 0.39	29.08 ± 1.94
	♀	8	20.87	49	18.57 ± 0.24	2.51 ± 0.17	13.52 ± 0.94

TABLE 3—Continued

GENERATION	SEX	PARENTS		OFFSPRING			
		Number	Means	Number	Means	Standard deviation	Coefficient of variability
F ₁₄	♂	3	25.67	64	33.97 ± 0.91	10.78 ± 0.64	31.73 ± 2.07
	♀	3	23.67	34	31.47 ± 1.33	11.52 ± 0.94	36.61 ± 3.37
F ₁₅	♂	16	45.31	19	28.53 ± 1.39	8.99 ± 0.98	31.51 ± 3.77
	♀	9	46.67	19	23.79 ± 0.52	3.37 ± 0.37	14.17 ± 1.58
F ₁₆	♂	7	37.57	34	19.74 ± 0.46	3.99 ± 0.33	20.21 ± 1.72
	♀	8	26.00	28	17.46 ± 0.35	2.78 ± 0.25	15.92 ± 1.47
F ₁₇	♂	5	26.00	47	30.31 ± 0.77	7.87 ± 0.55	25.97 ± 1.92
	♀	8	19.25	62	23.82 ± 0.58	6.75 ± 0.41	28.34 ± 1.85
F ₁₈	♂	8	36.88	60	39.15 ± 0.64	7.33 ± 0.45	18.72 ± 1.19
	♀	9	33.78	74	35.04 ± 0.67	8.49 ± 0.47	24.23 ± 1.42
F ₁₉	♂	14	43.14	102	35.71 ± 0.64	9.51 ± 0.45	26.63 ± 1.34
	♀	25	42.56	101	26.27 ± 0.51	7.54 ± 0.36	28.70 ± 1.47
F ₂₀	♂	11	42.27	106	40.60 ± 0.46	7.01 ± 0.32	17.27 ± 0.82
	♀	23	34.78	97	34.94 ± 0.64	9.41 ± 0.46	26.93 ± 1.40
F ₂₁	♂	21	44.10	71	39.23 ± 0.67	8.43 ± 0.48	21.49 ± 1.27
	♀	24	44.00	68	37.43 ± 0.83	10.14 ± 0.59	27.09 ± 1.68
F ₂₂	♂	11	43.82	29	24.74 ± 0.92	7.36 ± 0.65	29.75 ± 2.86
	♀	17	46.59	23	24.17 ± 0.59	4.17 ± 0.41	17.25 ± 1.77
F ₂₃	♂	5	32.40	50	27.32 ± 0.87	9.12 ± 0.62	33.38 ± 2.49
	♀	8	27.00	62	24.89 ± 0.57	6.63 ± 0.40	26.64 ± 1.72
F ₂₄	♂	12	38.08	40	36.05 ± 0.88	8.29 ± 0.63	23.00 ± 1.82
	♀	18	32.28	56	29.70 ± 0.91	10.05 ± 0.64	33.84 ± 2.39
F ₂₅	♂	6	40.00	49	31.57 ± 0.90	9.39 ± 0.64	29.74 ± 2.20
	♀	9	39.89	50	25.40 ± 0.76	8.00 ± 0.54	31.50 ± 2.33
F ₂₆	♂	6	44.67	41	33.54 ± 1.22	11.55 ± 0.86	34.44 ± 2.85
	♀	10	32.70	28	26.54 ± 1.05	8.26 ± 0.74	31.12 ± 3.06
F ₂₇	♂	6	48.33	89	27.52 ± 0.65	9.06 ± 0.46	32.92 ± 1.84
	♀	6	31.83	63	22.10 ± 0.44	5.17 ± 0.31	23.39 ± 1.48

TABLE 3—Concluded

GENERATION	SEX	PARENTS		OFFSPRING			
		Number	Means	Number	Means	Standard deviation	Coefficient of variability
F ₂₈	♂	9	32.78	70	23.41 ± 0.45	5.55 ± 0.32	23.71 ± 1.43
	♀	5	31.00	72	20.60 ± 0.29	3.60 ± 0.20	17.48 ± 1.01
F ₂₉	♂	7	28.57	41	18.32 ± 0.42	3.97 ± 0.30	21.67 ± 1.69
	♀	7	22.43	34	18.53 ± 0.29	2.53 ± 0.21	13.65 ± 1.14
F ₃₀	♂	3	22.00	71	21.87 ± 0.48	5.98 ± 0.34	27.34 ± 1.66
	♀	6	20.83	107	19.16 ± 0.18	2.69 ± 0.12	14.04 ± 0.66
F ₃₁	♂	2	24.00	91	23.66 ± 0.58	8.21 ± 0.41	34.70 ± 1.93
	♀	6	24.00	105	18.83 ± 0.21	3.18 ± 0.15	16.89 ± 0.81
F ₃₂	♂	4	40.50	47	28.11 ± 0.91	9.20 ± 0.64	32.73 ± 2.51
	♀	5	27.20	65	21.38 ± 0.35	4.21 ± 0.25	19.69 ± 1.21
F ₃₃	♂	3	38.00	59	43.23 ± 0.40	4.56 ± 0.28	10.55 ± 0.66
	♀	7	27.86	55	39.15 ± 0.66	7.39 ± 0.47	18.62 ± 1.24
F ₃₄	♂	15	40.73	2	49.50		
	♀	12	44.33	6	40.33 ± 1.82	6.60 ± 1.29	16.36 ± 3.27

TABLE 4

Average of length of vestigial wings of males and females in control series B

GENERATION	NUMBER	AVERAGE OF OFFSPRING	GENERATION	NUMBER	AVERAGE OF OFFSPRING
P ₁	2	20.00	F ₉	184	15.59
F ₁	30	16.23	F ₁₀	243	25.32
F ₂	36	16.28	F ₁₁	158	18.44
F ₃	206	17.03	F ₁₂	171	18.25
F ₄	21	17.19	F ₁₃	142	16.90
F ₅	143	16.75	F ₁₄	135	19.76
F ₆	32	16.41	F ₁₅	62	16.73
F ₇	115	17.26	F ₁₆	162	16.72
F ₈	119	16.25			

TABLE 5

Average of length of vestigial wings of males and females in selected series A

GENERATION	AVERAGE OF PARENTS	AVERAGE OF OFFSPRING	GENERATION	AVERAGE OF PARENTS	AVERAGE OF OFFSPRING
F ₁	20.00	16.23	F ₁₈	24.22	18.62
F ₂	19.50	16.39	F ₁₉	20.76	20.18
F ₃	18.00	19.25	F ₂₀	24.17	18.89
F ₄	24.25	18.45	F ₂₁	21.90	18.95
F ₅	19.71	18.48	F ₂₂	20.57	17.20
F ₆	22.11	17.95	F ₂₃	20.00	19.13
F ₇	21.83	18.87	F ₂₄	22.93	18.18
F ₈	21.27	18.70	F ₂₅	22.42	17.23
F ₉	22.17	17.57	F ₂₆	21.17	18.79
F ₁₀	20.21	25.63	F ₂₇	20.64	19.03
F ₁₁	40.46	21.12	F ₂₈	24.15	19.40
F ₁₂	26.58	26.88	F ₂₉	23.00	23.68
F ₁₃	30.69	18.80	F ₃₀	34.87	19.63
F ₁₄	21.09	19.40	F ₃₁	20.87	16.37
F ₁₅	23.92	19.16	F ₃₂	18.07	17.59
F ₁₆	22.45	19.46	F ₃₃	22.93	21.45
F ₁₇	25.40	21.77	F ₃₄	33.00	21.96

TABLE 6

Average of length of vestigial wings of males and females in 'crossed-in-and-selected' series C

GENERATION	AVERAGE OF PARENTS	AVERAGE OF OFFSPRING	GENERATION	AVERAGE OF PARENTS	AVERAGE OF OFFSPRING
F ₁	20.50 and long-winged	Long-winged	F ₁₈	35.24	36.88
F ₂	Long-winged	18.92	F ₁₉	42.77	31.01
F ₃	28.62	17.65	F ₂₀	37.20	37.90
F ₄	23.60	24.26	F ₂₁	44.05	38.35
F ₅	26.41	18.86	F ₂₂	45.50	24.49
F ₆	24.20	19.38	F ₂₃	29.08	25.97
F ₇	23.54	19.95	F ₂₄	34.60	32.35
F ₈	26.92	21.45	F ₂₅	39.93	28.45
F ₉	26.46	26.75	F ₂₆	37.19	30.70
F ₁₀	33.07	21.66	F ₂₇	40.08	25.27
F ₁₁	30.00	19.24	F ₂₈	32.14	21.99
F ₁₂	22.00	19.05	F ₂₉	25.50	18.42
F ₁₃	23.50	20.20	F ₃₀	21.22	20.24
F ₁₄	24.67	33.10	F ₃₁	24.00	21.07
F ₁₅	45.80	26.16	F ₃₂	33.11	24.20
F ₁₆	31.40	18.71	F ₃₃	30.90	41.26
F ₁₇	21.85	26.52	F ₃₄	42.33	42.62

TABLE 7

Means, standard deviations, and coefficients of variability in 'crossed-in-and-selected' series C subjected to high temperature

GENERATION	SEX	PARENTS		OFFSPRING			
		Number	Means	Number	Means	Standard deviation	Coefficient of variability
F ₂₉	♂	7	28.57	83	39.73 ± 0.60	8.13 ± 0.43	20.46 ± 1.12
	♀	7	22.43	95	33.77 ± 0.66	9.48 ± 0.46	28.07 ± 1.48
F ₃₀	♂	1	53.00	37	48.64 ± 0.61	5.53 ± 0.43	11.37 ± 0.90
	♀	3	42.67	39	45.46 ± 0.83	7.65 ± 0.58	16.83 ± 1.32
F ₃₁	♂	1	55.00	11	53.64 ± 0.99	4.85 ± 0.70	9.04 ± 1.31
	♀	2	50.50	7	42.86 ± 1.40	5.51 ± 0.99	12.86 ± 2.36
F ₃₂	♂	11	53.64	44	47.93 ± 0.39	3.88 ± 0.28	8.10 ± 0.59
	♀	7	42.86	40	48.35 ± 0.69	6.45 ± 0.49	13.34 ± 1.02
F ₃₃	♂	8	49.87	15	49.73 ± 0.43	2.46 ± 0.30	4.95 ± 0.51
	♀	12	52.75	16	50.06 ± 1.05	6.25 ± 0.75	12.49 ± 1.51
F ₃₄	♂	15	49.73	11	51.09 ± 0.77	3.78 ± 0.54	7.40 ± 1.07
	♀	16	50.06	16	52.19 ± 1.10	6.54 ± 0.78	12.53 ± 1.52
F ₃₅	♂	11	51.09	35	49.37 ± 0.43	3.80 ± 0.31	7.70 ± 0.62
	♀	16	52.19	24	50.96 ± 0.67	4.84 ± 0.47	9.50 ± 0.93

TABLE 8

Means, standard deviations, and coefficients of variability in a cross of a long vestigial-winged male and short vestigial-winged females, under high temperature

GENERATION	SEX	NUMBER	MEAN	STANDARD DEVIATION	COEFFICIENT OF VARIABILITY
P ₁	♂	1	With almost perfect wings—length about 50		
	♀	3	16.33		
F ₁	♂	70	32.13 ± 0.62	7.71 ± 0.44	24.00 ± 1.44
	♀	89	22.63 ± 0.28	3.92 ± 0.20	17.32 ± 0.90
F ₂	♂	56	40.14 ± 0.90	10.04 ± 0.64	25.01 ± 1.69
	♀	132	31.64 ± 0.58	9.83 ± 0.41	31.07 ± 1.41

TABLE 9

Average of length of vestigial wings of males and females in 'crossed-in-and-selected' series C subjected to high temperature

GENERATION	AVERAGE OF PARENTS	AVERAGE OF GENERATION	GENERATION	AVERAGE OF PARENTS	AVERAGE OF GENERATION
F ₂₉	25.50	36.55	F ₃₃	51.60	49.90
F ₃₀	45.25	47.01	F ₃₄	49.90	51.74
F ₃₁	52.00	49.45	F ₃₅	51.74	50.02
F ₃₂	49.45	48.13			

REACTIONS OF LAND ISOPODS TO LIGHT

CHARLES HARLAN ABBOTT

Biological Laboratory, Brown University

CONTENTS

I. Introduction.....	194
II. Historical.....	195
III. Material.....	196
IV. Normal behavior.....	197
A. Reactions to light.....	197
1. Photokinesis.....	197
2. Phototaxis.....	197
3. Vision.....	198
B. Relation of contact and vision.....	198
V. Experiments with directive light.....	199
A. Apparatus.....	199
B. Normal reactions.....	205
1. Positive and negative responses.....	206
2. Orientation.....	208
3. Angle of negativeness.....	211
4. Conclusions.....	214
C. Modifiability of the light reactions.....	215
1. Reaction to different intensities.....	216
2. Effect of repeated stimulation.....	220
3. Comparison of reactions following exposure to light and to dark.....	223
4. Comparison of reactions of individuals from dry and moist habitats.....	225
5. Reaction in water.....	226
6. Comparison of phototaxis in <i>Oniscus</i> and <i>Porcellio</i>	228
7. Conclusions.....	230
VI. Discussion.....	231
A. Ecological analysis.....	231
1. Habitat.....	232
2. Structural and physiological adaptations.....	232
a. Respiration.....	232
b. Food.....	233
c. Care of young.....	233
d. Behavior.....	233

3. Reactions of land isopods.....	234
a. Reactions to humidity and evaporation.....	234
b. Reactions to contact.....	235
c. Reactions to light.....	235
B. The problem of orientation.....	238
1. Direct orientation versus method of trial.....	239
2. Constant intensity versus change of intensity.....	239
3. Conclusions.....	243
VII. Summary.....	243
VIII. Bibliography.....	245

I. INTRODUCTION

Land isopods, commonly called sowbugs, have always been of interest as the only Crustacea which are truly terrestrial. However, most previous studies of the adaptation of this group of animals to a land environment have been devoted only to the structure and function of the respiratory organs. The behavior has been almost entirely neglected. Behavior studies, always of interest to comparative psychologists, have been made increasingly important by the recent development of animal ecology into an experimental science, in which behavior is used as a test of the influence of environment. This use of behavior investigations is emphasized in the general ecological works of Adams ('13) and Shelford ('13), and has been applied by Banta ('10) and Allee ('12, '14) to the study of fresh-water isopods.

The present study of land isopods has therefore been undertaken in order to learn if their behavior is of ecological importance. The plan has been, 1) to study the reactions to individual factors of the environment, and 2) to find out if these reactions assist in fitting the animals in question to occupy their present habitat.

This paper reports a study of the behavior of land isopods with respect to one of the most important environmental factors, namely, light. Although the results are considered also from the standpoint of the problems which particularly interest all students of animal behavior, the ecological viewpoint has been the guiding principle throughout.

The experiments were carried on at the Biological Laboratory, Brown University. I wish to thank the authorities of the uni-

versity and of the laboratory for the opportunities and facilities for research which were furnished me. My greatest debt is to Prof. H. E. Walter, under whose supervision the work was done, for stimulating my first interest in behavior studies, and for helpful suggestions and criticisms at every stage of the investigation.

II. HISTORICAL

While naturalists have commonly concluded that land isopods are negatively phototactic, very little experimental work has been done on their reactions. The papers of Cole ('07) and Torrey and Hays ('14) appear to form the entire literature on the subject.

Cole ('07, pp. 371 to 375) in "an experimental study of the image-forming powers of various types of eyes" found *Oniscus asellus* negative to light, but not so uniformly as some other animals, for example the mealworm (larva of *Tenebrio molitor* Linn.). "Only 45 per cent to 51 per cent of the reactions were away from the light, in excess of those toward the light." Cole exposed *Oniscus* to illumination from the side, and recorded the place where the animal crossed the circumference of a circle which had a radius of 10 cm. The intensity of the light used varied from 1.5 to 5 candle meters. Cole further found that *Oniscus* shows a slight discrimination between two sources of light of different diameters which deliver the same intensity on the animal.

Torrey and Hays ('14), working on the orientation of *Porcellio scaber*, recorded that the animal has a negative response to light, and may be oriented very accurately, 1) by a constant light from behind, 2) by a sudden exposure to lateral light, or 3) by a "sudden exposure to light from the front at angles between 90° and 15° ." "When exposed suddenly to light coming from the front at angles less than 15° , *Porcellio* moved with less consistency away from the light, but the reactions were, on the whole, markedly negative." These authors concluded that the orientation of this species is direct, and is not brought about by selection of random movements.

In the experiments of Torrey and Hays the source of illumination was a Mazda bulb held near the animal. No attempt was made to measure the intensity, but apparently all the work was done with rather high intensities.

Many of the questions which arise with regard to the light reactions of land isopods are not answered by either of the papers just referred to. The present study is an attempt to gain a more thorough understanding of the reaction of land isopods to light, in order to interpret the ecological significance of the behavior.

III. MATERIAL

The common species of land isopods belong to the superfamily Oniscoidea and to the family Oniscidae. They are favorable for experimental work because they are abundant, are generalized in their mode of life, and are suited to life in a laboratory. The species *Oniscus asellus* Linn. was used chiefly for the study, but for comparative purposes two other common species, *Porcellio rathkei* Brandt and *Porcellio scaber* Latreille, were also tested in many of the experiments. Complete descriptions of these species are found in Richardson's Monograph (Richardson, '05), and it is not necessary to repeat them here. Various points in the description important from an environmental standpoint, particularly differences between the genera, are given in succeeding pages.

As sowbugs live normally under almost any object that furnishes concealment together with a certain degree of moisture, and as they frequently invade houses, it is not difficult to duplicate their natural surroundings in the laboratory. They were kept in round glass dishes, containing earth, dry leaves, and bark, and covered to prevent evaporation. To allow for possible results of differences in temperature, some were placed in ordinary heated rooms, while others were left out of doors in wooden boxes. Attempts to keep them alive outside the building during the winter months were, however, unsuccessful. Otherwise many of them lived an apparently normal life for several months in the various habitats, and some which were kept in a warm room produced broods of young in December.

IV. NORMAL BEHAVIOR

A. REACTIONS TO LIGHT

Animals respond to photic stimuli by three methods:

1. Increased or decreased activity, without orientation. (Photokinesis.)

2. Definite orientation with respect to the source of light, usually accompanied by locomotion toward or away from the light. (Phototaxis.)

3. In animals with image-forming eyes, response to some sort of image made upon the photoreceptive cells. (Vision.)

Inasmuch as sowbugs live in concealed places, the part which light normally plays in their activity is not easily observed. It is, however, clear that they can become accustomed to living in the ordinary daily rhythm of light and dark, because they lived a normal life for weeks in the laboratory under these conditions.

1. Photokinesis

Sowbugs appear to respond to sudden increases in intensity of light, both when they are exposed by the overturning of a log under which they are concealed. and, in the laboratory, when a near-by artificial light is turned on. Two types of response follow under either of the described conditions:

1. Increased activity.

2. Complete cessation of activity.

If the response is one of increased activity, the animals usually keep moving until they reach concealment or, at least, partial concealment in a crevice. The individuals which are inactive at first later become active and seek a more protected situation. No sowbugs are left in sight a short time after a log which has concealed them is overturned.

2. Phototaxis

Under the conditions just described, the light is too diffuse to bring about any definite orientation of the isopods. When,

however, they accidentally start to wander out from dark cavities, a definite phototactic reaction probably turns them back into the dark again. This behavior is difficult to observe in the field, and analysis is, moreover, complicated by reaction to contact.

Simple experiments show that land isopods have a phototactic response to light, even when the light is somewhat diffuse. For example, at 4 P.M. on January 19th, when the light entering the room through a north window was becoming rather dim, individuals of *Oniseus*, placed on a table several feet from the window, definitely and consistently turned away from the light and traveled in the opposite direction. Such experiments show that these animals have a definite negative phototaxis in ordinary daylight.

The experiments in the following sections are devoted to analysis of this reaction.

3. *Vision*

Land isopods have rather primitive compound eyes, and are to be classed among the animals which have the beginning of vision. As they live constantly in the dark, it does not seem probable that vision plays any appreciable part in their normal life. Observation of the use of the antennae in ordinary isopod activity indicates that vision is of much less importance than reaction to contact in the ordinary life of these animals.

B. RELATION OF CONTACT AND VISION

The antennae, the most important contact organs of the isopod, are in constant use during ordinary locomotion. They are extended in front of the head and the tips are repeatedly touched to the substratum. The animal often pauses and waves its antennae about in the air or rubs them over any object which chances to be in its path. The antennae are used to test the nature of the environment in a way similar to that in which a blind person, by passing the finger-tips over objects and by the use of a cane when walking, uses the sense of contact as a substitute for the sense of sight.

When the isopod is at rest, the antennae are often spread on the substratum before it. They are frequently moved independently of the rest of the body either just before locomotion begins or, sometimes, at the moment when the animal pauses before changing the direction of its course. When the animal is stimulated by directive light, similar movements of the antennae usually occur before locomotion is started. They are described by Torrey and Hays ('14) as analogous to the so-called 'random movements' of the earthworm or blowfly larva.

Another common movement of sowbugs, both during ordinary activity and when stimulated, is that of 'wiping' or 'cleaning' the antennae. This 'cleaning,' which occurs in other higher Crustacea as well, consists in passing the first walking leg over the antenna as if cleaning it.

The importance of the antennae is shown further by observation of the locomotion after the antennae are removed. Without antennae, obstructions in the path are not usually avoided until the head or the anterior walking legs come in contact with them. On the other hand, according to Torrey and Hays ('14), "totally blind individuals avoid obstacles with the ease of normal individuals." These results following blinding and removal of antennae indicate that the eyes are not normally used for vision.

V. EXPERIMENTS WITH DIRECTIVE LIGHT

A. APPARATUS

The experiments were performed in an experimental dark-room in the basement of the Arnold Biological Laboratory, Brown University. A description will be given of the apparatus which was employed after applying the 'trial and error method' to the devising of apparatus. A table, 122 x 75 cm., painted dead black, was placed in the center of the room, under a convenient overhead light. This table, with space for the observer, was surrounded by a black curtain which cut off both the dim light from the ventilator of the room and reflections from all other objects which were not painted black.

At one end of the table was placed a wooden box, black both inside and outside, containing the source of light—a 60-watt, 250-volt Mazda lamp. To insure symmetrical illumination of both sides of the field, the lamp was placed in a vertical position in the box. The light passed out through a horizontal slit, 41 x 3 mm., in a diaphragm. The lower edge of this slit was 5 mm. above the table top, insuring the illumination of the surface of the table and at the same time allowing the light to strike the eyes of the isopod from a horizontal direction. The slit was covered with thin paraffined paper in order to make a source of even illumination. The relation between the table top and the source of light is shown in figures 1 and 2.

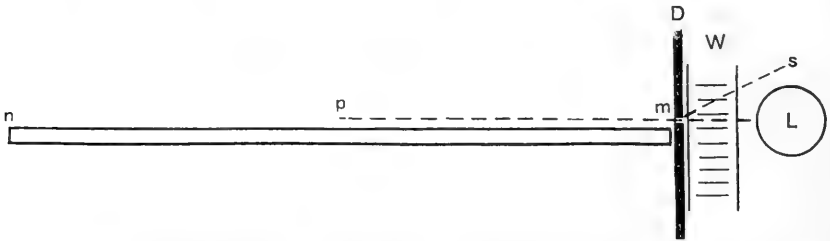

Fig. 1 Vertical diagram of apparatus: *mn*, table top; *D*, diaphragm; *s*, slit in diaphragm through which light passes; *L*, light; *W*, rectangular jar of distilled water to cut out heat; *p*, position where animals were placed; *mp*, path of light to point *p*.

A horizontal field, 60 x 40 cm., divided into squares 10 cm. on a side, was marked out on a part of the table next to the light (fig. 2). This gave an area with the intensity gradually diminishing both from the source of light to the opposite end of the field and from the center to the sides. As the slit in the diaphragm through which the light passed was only 41 mm. in length, dark corners (fig. 2, *c* and *c'*), were left at the sides and not included in the experimental field. Black strips of wood were placed along the lines *ef* and *jk* to shut off possible side reflections. The diaphragm was 5 mm. from the edge of the field.

In most of the experiments the animals were exposed to the light after they had been placed in the center of the field, i.e.,

30.5 cm. from the diaphragm and 20 cm. from the sides of the field. A circle with a radius of 10 cm. was drawn about this point as a center, and was divided into sixteen sectors, which were numbered 1 to 8 on each side of the central axis mn (fig. 2).

The intensity of the light was measured by means of a Macbeth illuminometer, which was kindly loaned by Prof. W. E. Kenerson, of the Engineering Department. Intensities in candle meters (C.M.) of the principal points of the field, determined

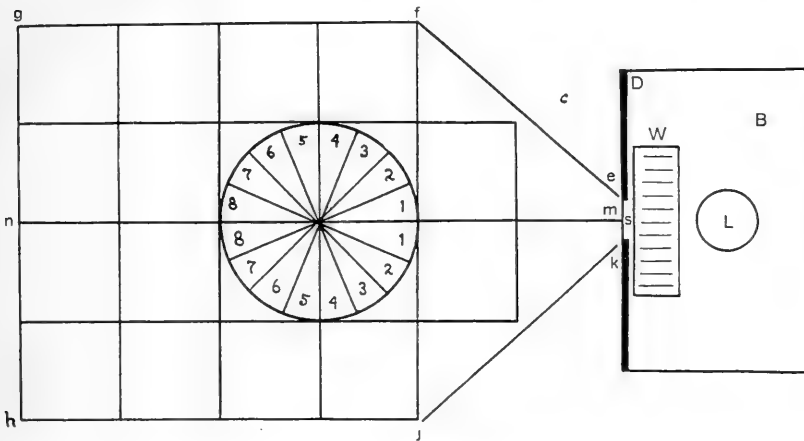

Fig. 2 Horizontal diagram of apparatus: $efghjk$, experimental field, divided into squares 10 cm. on a side, with a circle of 10 cm. radius at the center; mn , central axis of field, receiving the most intense light; c and c' , dark corners; B , box containing light; L , light; D , diaphragm; s , slit in diaphragm; W , rectangular jar of distilled water to cut out heat.

early in the experiments, are indicated in figure 3. The intensities at three points along the axis mn , i.e., at 20.5, 30.5, and 40.5 cm. from the diaphragm, were determined with considerable accuracy. The intensities of the other points indicated were less easily determined, due to the angles at which it was necessary to make the readings and to the rapidly decreasing light on the sides of the field. This difficulty will account for the differences in the readings from the two sides. The constancy of illumination throughout the experiments is indicated by a reading of

12.79 C.M. for the central point, made six weeks after the reading of 12.955 C.M. recorded in figure 3.

It can be seen from figure 3 that an animal starting from the central point will go into a region of diminished intensity unless it travels into the quadrant of the circle toward the source of

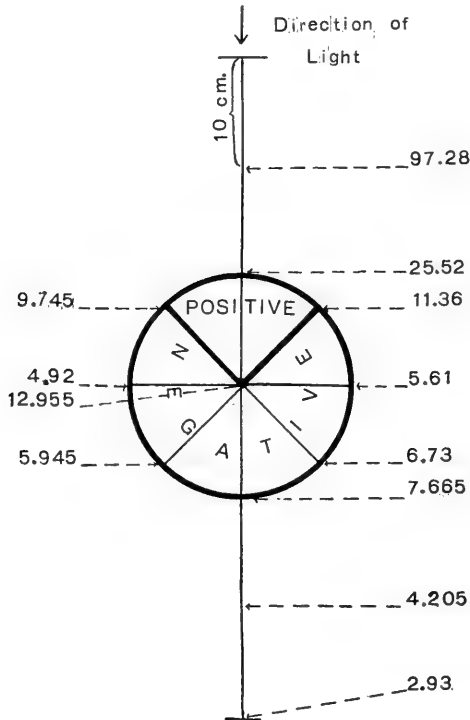

Fig. 3 Diagram of experimental field, showing intensities of light in C.M. at principal points of the field, measured with Macbeth illuminometer. Heavy black line shows the division of the circle into two parts, negative and positive.

light. This fact makes possible a division of the circle into the two parts shown in figure 3. If the animal leaves the circle in the quadrant nearest the light, it goes into a region of increased illumination, and hence shows a positive response. If it goes in any other direction, the response is negative.

For convenience in manipulating the animals, small cardboard boxes were used, a little longer than the animal and just wide enough to enclose it without allowing it to turn around (fig. 4). When the sowbug had been shoved to the desired position, the box was removed, and the course taken by the animal was observed and recorded.

In the experiments the isopod was tested successively in four different positions, namely, facing the light (A), facing away from the light (B), with the right side illuminated (C), and with the left side illuminated (D). This was to eliminate errors due to a possible tendency of the isopod to travel in the direction in which it was already headed.

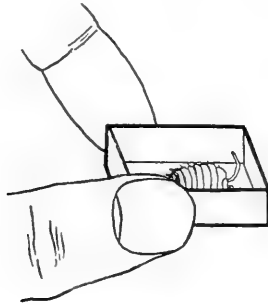

Fig. 4 Diagram of frame with which animals were manipulated on the table top.

The reactions were recorded on printed sheets of paper like that shown in figure 5. It contains four diagrams of the experimental field, the squares corresponding to the 10-cm. squares on the table. With the aid of the squares it was possible for the observer to duplicate the course of the animal with considerable accuracy. The four diagrams were used for the four positions A, B, C, D just referred to. Each record consisted of twenty trials, five each in the four positions. These were made in the order A, B, C, D, A, B, etc., to avoid effects of immediate repetition of the same stimulus. The responses were numbered in the order in which they occurred in the series. Figure 5 is a typical record of the reactions of a normally negative *Oniscus*.

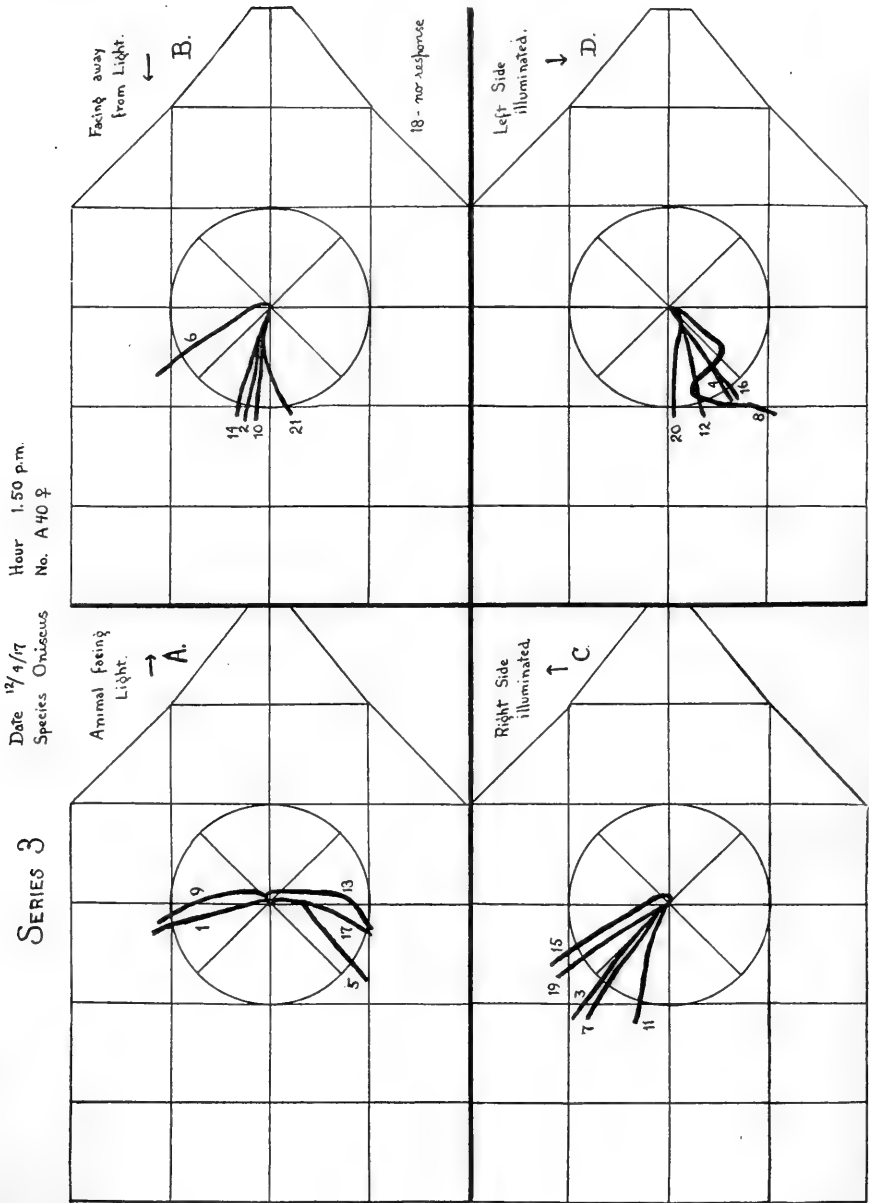

Fig. 5 A typical record of the reaction of an individual animal, showing twenty responses. The numbers indicate the order in which the responses occurred. The animal was negative in all instances.

B. NORMAL REACTIONS

The actual record of the single set of responses shown in figure 5 gives an idea of the usual behavior of *Oniscus*. That this individual was unquestionably negative to light is shown by a comparison of the reactions in the four positions. The only instance in which the animal continued in the direction in which it was headed occurred when it was illuminated from behind and movement straight ahead carried it away from the light. In all other cases it turned very decidedly away from the source of illumination.

Three different conditions may be noted in the activity of the animal when the box was removed, exposing it to the light: 1) the animal had not come to rest, and merely continued in locomotion; 2) the animal had come to rest, but started locomotion at once when exposed to the light; 3) the animal had come to rest, and did not start locomotion at once when exposed to the light. On account of this variation in the initial conditions, these experiments with directive light do not show whether locomotion was an effect of stimulation by light. The matter is further complicated by the fact that handling the animals may have had an activating effect, an inhibitory effect, or, as is most probable, sometimes one and sometimes the other. However, as these experiments were a test only of the directive influence of light when the animal was already in locomotion, the question whether more than one of these factors entered into the cause of the locomotion need not be considered. For this reason no record was made of the interval before response in most cases. When there was a delay before response, the antennae were often kept moving, particularly just before locomotion was started, although few if any of these movements could properly be called 'trial movements.'

Much individual variation was observed. While the direction of locomotion was usually determined by the light, there were many turns and circles, the causes of which were not so easily analyzed. An example is shown in figure 5, D, response no. 8.

An examination of a large number of records showed that *Oniscus* is decidedly negative to light. This conclusion is shown best, however, by applying to the records more than one method of analysis, in order to give a clearer idea of what is involved in the negative reaction. Three methods will be described on the basis of results obtained while studying the individual behavior of these isopods on successive days. The three animals which will be particularly considered are designated as A 10, A 11, and A 12. They were placed in all cases in the center of the field, as in the typical method described, and exposed to an average intensity of 12.955 candle meters.

In making each record, the sex of the animal was recorded. However, no differences were found between the reactions of the two sexes, so that the results of both were used indiscriminately in compiling tables and angles.

1. Positive and negative response—first method of analysis

This method of tabulating results is shown in table 1, which summarizes the results from *Oniscus* A 10, extending over seventeen days.

Responses are classified as positive or negative according to the grouping explained in figure 3. When the animal crossed the circle within the positive quadrant, the response was recorded as positive; otherwise, it was considered negative, because the animal went into a region of diminished intensity. The letters A, B, C, D refer to the four positions in which the animal was placed with reference to the light.

The results are given in percentages of each kind of response. The positive responses number 5.9 per cent, and the negative responses, 94.1 per cent. The variation in the four columns A, B, C, and D is slight, showing that the direction in which the isopod was headed made little difference in the nature of the response. This *Oniscus* was thoroughly negative to light, although in a few isolated instances it went toward the light. If the positive response were 25 per cent of the total, it might be concluded that the animal was indifferent to light, as the posi-

TABLE 1

Reaction of Oniscus A 10 to directive light of 12.955 C.M., showing results of daily tests for 17 days. Tests were made with the animal facing the light (A), facing away from the light (B), and illuminated on the right (C) and left (D) sides

DAY	POSITIVE REACTIONS					NEGATIVE REACTIONS				
	A	B	C	D	Total	A	B	C	D	Total
1					0	5	5	5	5	20
2					0	4	4	4	4	16
3	2			2	4	3	5	5	3	16
4					0	5	5	5	5	20
5				1	1 ¹	4	5	4	4	17 ¹
6				1	1	4	5	5	4	18
7			1		1	4	2	3	4	13
8		1		1	2	5	4	4	4	17
9					0	5	4	4	5	18
10	1		1	1	3	4	3	4	4	15
11	2	1		1	4	3	4	4	4	15
12					0	5	4	5	5	19
13	1				1	2	3	4	3	12
14					0	4	4	4	3	15
15					0	4	5	3	4	16
16					0	1	3	2	2	8
17					0	4	4	4	5	17
Totals.....	6	2	2	7	17	66	69	69	68	272
Percentages.....	8.3	2.8	2.8	9.3	5.9	91.7	97.2	97.2	90.7	94.1

¹ When less than 20 responses are recorded, the animal failed to respond in the other instances.

tive section of the field is only 25 per cent of the whole. However, the 5.9 per cent calculated shows that the animal was unquestionably negative. The occasion when it would naturally have gone toward the light if it were indifferent, was when it was facing the light at the start, but even under that condition it turned away in 91.7 per cent of the trials.

A similar tabulation of percentages is shown in table 2 for *Oniscus A 11*, tested for fifteen days.

A higher record of positiveness was made by *Oniscus A 12*, which received fifteen daily tests. Most of the positive responses came in the first four days, the animal being 45 per cent positive on the first day. After the fourth day, the reaction was as

TABLE 2

Summary of reaction of Oniscus A 11, to directive light of 12.955 C.M., showing results of daily tests for 15 days. Tests were made with the animal facing the light (A), facing away from the light (B), and illuminated on the right (C) and left (D) sides

DAY	POSITIVE REACTIONS					NEGATIVE REACTIONS				
	A	B	C	D	Total	A	B	C	D	Total
Totals.....	4	0	3	5	12	59	61	61	57	238
Percentages.....	6.3	0.0	4.7	8.1	4.8	93.7	100	95.3	91.9	95.2

typically negative as that of either of the other individuals just described. Table 3 shows how this isopod gradually changed from indifferent or positive to negative.

As an indifferent animal would be about 25 per cent positive, the 45 per cent recorded on the first day shows a considerable degree of positiveness on that day.

This method of classification shows that these isopods, when stimulated by directive light, usually avoid the light by locomotion to regions of lower intensity. As the light stimulus is received through the eyes, it is further important to know the result of unequal stimulation of the two eyes. This is shown by a study of the angle of the course taken by the animal after it has been exposed to the light.

2. Orientation—second method

As was shown in figure 2, the circle on the light field was divided into sixteen sectors, numbered 1 to 8 on each side of the central axis *mn*. If the homologous classes on the right and left sides are grouped together, the responses of any individual isopod can be divided into eight degrees of negativeness, according to the sector of the circle which the animal crossed after exposure to the light.

The same records which were summarized in tables 1 and 3 are shown graphically in figures 6 and 7, after tabulation according to this second method. Figure 6 shows the degree of negativeness of *Oniscus A 10*, the numerals on the abscissae corresponding

TABLE 3

Reaction of Oniscus A 12 to directive light of 12.955 C.M., showing results of daily tests for 15 days. Tests were made with the animal facing the light (A), facing away from the light (B), and illuminated on the right (C) and left (D) sides

DAY	POSITIVE REACTION					NEGATIVE REACTIONS				
	A	B	C	D	Total	A	B	C	D	Total
1	3	1	3	2	9	2	4	2	3	11
2	2			3	5	3	5	5	2	15
3	2		2		4	3	5	3	5	16
4	2		2		4	2	4	3	4	13
5				1	1	2	4	2	3	11
6					0	3	4	4	3	14
7					0	3	4	5	2	14
8	2				2	3	5	5	5	18
9				1	1	5	5	5	5	20
10					0	4	5	4	5	18
11				1	1	5	5	5	4	19
11 ¹					0	2	2	4	2	10
12					0	5	5	5	5	20
13	1				1	1	4	4	2	11
14	1				1	3	4	5	4	16
15	1				1	1	4	3	3	11
Totals.....	14	1	7	8	30	47	69	64	57	237
Percentages.....	23.0	1.4	9.9	12.3	11.2	77.0	98.6	90.1	87.7	88.8

¹ A second set of responses was recorded on the eleventh day.

to the eight degrees of negativeness just referred to and the numerals on the ordinates being the number of responses which fall into each of these eight classes. The lines A, B, C, D represent the four positions with respect to the light in which the animal was placed, while the dotted line is the average of the four positions.

As would be expected, the greatest degree of negativeness is when the animal is headed away from the light, and the lowest, when facing the light. As only data in classes 1 and 2 on the abscissa indicate a positive response, all of the curves show that this isopod was thoroughly negative. There is a close correspondence between the nearly identical reactions in positions C and D and the average for all positions. This indicates that the

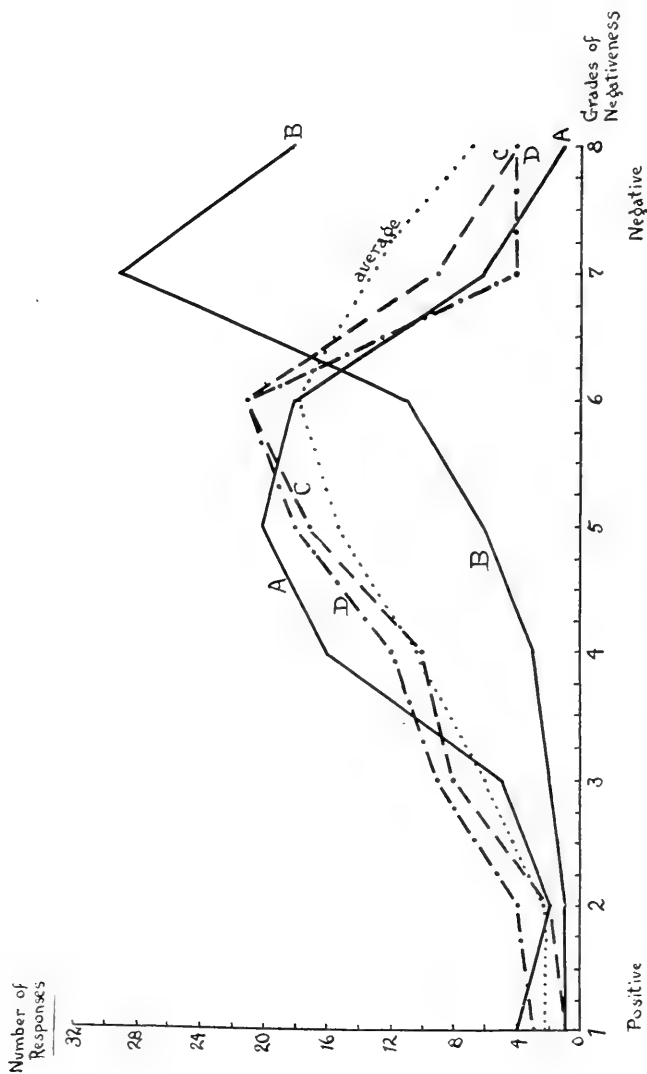

Fig. 6 Reaction of *Oniscus* A10, tested daily for seventeen days. Numbers on abscissa indicate the eight degrees of negativity shown in figure 2. Numbers on ordinate indicate total number of responses in each of the eight classes. *A*, animal facing the light; *B*, animal facing away from the light; *C*, right side illuminated; *D*, left side illuminated. The dotted line represents the average of *A*, *B*, *C*, *D*. Record of a negative animal.

reaction when the animal is illuminated on the side shows the true degree of negative reaction, and, moreover, that the results in positions A and B balance each other, so that the average in all four positions is a suitable control for the correctness of the results from stimulation on the side.

The reaction of *Oniscus* A 12 is given in figure 7. These curves show more positive responses than occurred in A 10, due to the many instances in which this isopod went toward the light during the first four days. From the average for the entire period of the experiment, it appears that A 12 became the more negative of the two animals, because, in spite of the degree of positiveness at first, the average in figure 7 shows the greatest number of responses in classes 7 and 8 on the abscissa, while in figure 6 classes 5 and 6 are the largest. In figure 7 the correspondence between the average reaction and the reaction in positions C and D is not quite so close as in figure 6, but the average is much nearer to these than to the reactions in positions A and B.

The graphical method shows more definitely what is involved in the negative reaction than was shown by a simple enumeration of positive and negative responses. The animals regularly turned away from the light in whatever position they were originally placed, except that when they were already headed away from the light they nearly always traveled in the direction in which they were headed. From this method of analysis it may be concluded that *Oniscus* is definitely oriented by the light and that the response involves something more than moving at random into a lower intensity.

3. Angle of negativeness—third method

This method was devised to express the degree of negativeness of any one individual isopod or group of isopods by a single figure, which might be used for comparison with the results obtained in succeeding experiments. For this purpose the angle of negativeness was chosen. This term will be applied to the average angle of the course taken by the animal with respect to the position of the source of light.

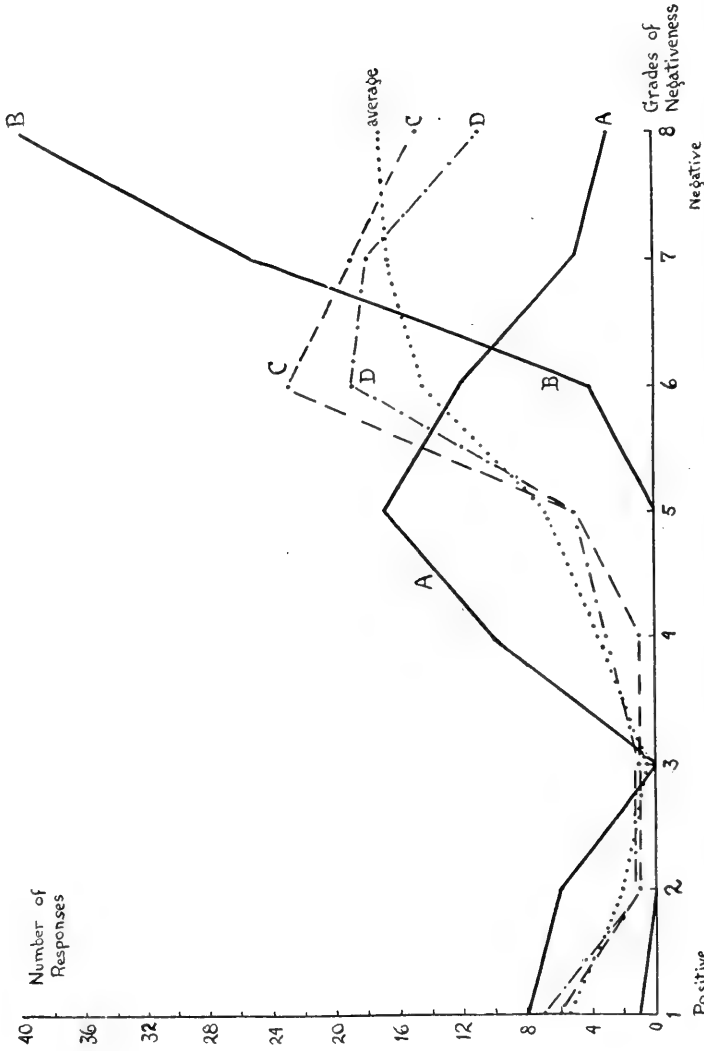

Fig. 7 Reaction of Oniscus A12, tested daily for fifteen days. Numbers on abscissa indicate the eight degrees of negativeness shown in figure 2. Numbers on ordinate indicate total number of responses in each of the eight classes. A, animal facing the light; B, animal facing away from the light; C, right side illuminated; D, left side illuminated. The dotted line represents the average of A, B, C, D. Record of a negative animal, with more individual positive responses than the individual of figure 6.

The method of calculation is as follows: Each response is given the number of the sector in which it falls as in the second method (fig. 2). For example, in the records of class A in figure 4, four of the responses fall into sector 5 and one into sector 6. The average of the five responses is thus 5.2. The middle points of the eight sectors, expressed in terms of angular deviation from the central axis mn are: 1. 11.25° ; 2. 33.75° ; 3. 56.25° ; 4. 78.75° ; 5. 101.25° ; 6. 123.75° ; 7. 146.25° ; 8. 168.75° . The difference between each of these figures and the succeeding one is 22.50° , or one-sixteenth of 360° . The figure 5.2 expressed in angles is equivalent to the angle just given for 5, 101.25° , plus two-tenths of 22.50° , making 105.75° , the angle of negativeness for the responses recorded in figure 4, A, when the animal was facing the light.

As an application of this method, table 4 expresses the angle of negativeness for the reactions which were shown graphically in figures 6 and 7.

The table shows that both of these animals were negative, because they turned, on the average, at least 90° away from the light when they were facing the light, and, respectively, 14° and 32° away when they were already at right angles to the light.

The fact that *Oniscus A 12* was positive or indifferent on the first day and gradually became negative is shown by the angles, when the animal was stimulated on the side, for the first seven days of the experiment: 1st day, 78.75° ; 2nd, 96.75° ; 3rd, 103.50° ; 4th, 85.50° ; 5th, 108.00° ; 6th, 139.50° ; 7th, 139.50° .

TABLE 4

Angle of negativeness for Oniscus A 10 (tested for 17 days) and A 12 (tested for 15 days). Intensity of light 12.955 C.M. Tests were made with the animals facing the light (A), facing away from the light (B), and illuminated on the right (C) and left (D) sides

ANIMAL	A	B	C	D	TOTAL A, B, C, D	TOTAL C, D
10	96.75°	135.00°	105.75°	101.25°	108.00°	104.625°
12	90.00°	155.25°	148.50°	119.25°	130.50°	122.40°

As an angle of negativeness of 90° represents the average course of an animal placed at right angles to the light, if it is indifferent to light, the angle for the first day shows that this individual was somewhat positive on that day, because it turned on the average 11.25° toward the light. This accords with the 45 per cent positive response calculated according to the first method.

The responses in any record fall into three classes with respect to the angle of negativeness:

1. When the animal is facing the light (position A), it is possible to measure only the angle of turning away from the light.

2. When the animal is facing away from the light (position B), it is possible to measure only the angle of turning toward the light.

3. When the light strikes the animal on the side (positions C and D) either the angle of turning away from the light or the angle of turning toward the light can be measured.

This difference raised the question whether the angle of negativeness should be measured only from the results in positions C and D or from those of the four positions combined. A test series showed that the results are approximately the same, whichever method is used. Of course the smallest angle is obtained when the animal is facing the light and the largest when facing away from the light, but these two extremes balance each other. The series which shows this is given in the section on the comparison of *Oniscus* and *Porcellio* (table 10, page 228). Compare also the last two columns in table 4. In the following pages, wherever the angle is given without further explanation, the angle calculated from the positions C and D is given.

4. Conclusions

- a. The individual isopods which have been considered in the preceding pages were, except in the instance of one individual on a single day, definitely negative to light. This is shown by the calculation of a high percentage of negative responses and by the measurement of the average angles through which these animals turned in their movements away from the light.

b. The results which have been analyzed are typical for the species *Oniscus asellus*. The reaction of nearly all individuals is negative, with only occasional reversals to positiveness. The constancy of these results will be shown in the experiments to be described later in this paper.

c. Nothing has been said as yet about the reactions of *Porcellio*. The two species of *Porcellio* are also negative to light, but the reaction is less consistent than that of *Oniscus*. The difference between the two genera will be shown repeatedly in the following pages, and, finally, will be summarized in the section on the comparison of *Oniscus* and *Porcellio*.

C. MODIFIABILITY OF THE LIGHT REACTIONS

A consideration of the ecological importance of isopod behavior involves the question whether the behavior is constant or is easily modified by environmental changes. Shelford has pointed out the fallacy of the assumption that the behavior of a given species is a constant characteristic, whatever the environmental conditions. In recent studies of fresh-water animals (Shelford, '14) and marine forms (Shelford, '16), he has shown that behavior characters belong to a community even more than to a species, and that behavior differences between individuals of a single species from different habitats may be greater than those between widely diverse species which occupy the same habitat.

As an illustration of this principle, Allee ('12) has shown differences in the rheotaxis of the fresh-water isopod *Asellus communis* Say, according as the individuals tested came from ponds or from streams.

Modification of behavior, however caused, is shown in many ways, of which the three following are important: 1) by a partial or entire failure to respond to the stimulus; 2) by an intensification of response; 3) by a reversal of response. Allee ('12, '14) obtained the first two of these modifications by subjecting *Asellus* to various experimental conditions which changed the metabolism of the animal. He found that conditions similar to

those of stream life induced a definite positive rheotaxis in pond isopods, while conditions similar to those of pond life decreased the rheotaxis of stream isopods. That these differences are adaptive is shown by the fact that reaction to current is important in the normal life of stream forms, but of less significance for animals that live in quiet water.

The third result, a reversal of response, has been observed in various animals, due to many different causes. The work on this subject is well summarized by Holmes ('16) in a chapter entitled "The Reversal of Tropisms."

The following problems were undertaken, in order to learn whether the behavior of land isopods is constant or is easily changed by external conditions:

1. Reaction to various intensities of light.
2. Effect on reaction of repeated stimulation by the same light intensity.
3. Comparison of reactions following exposure to light and to dark.
4. Comparison of reactions of individuals from dry and moist habitats.
5. Reaction in water.

1. Reaction to different intensities

a. Average intensities. Studies of the effect of different intensities were easily accomplished by placing the isopods at various distances from the source of light. The intensities at the points chosen furnished a range from 3 to 100 C.M. The actual intensities, as determined by the illuminometer, are given below.

POSITION	DISTANCE FROM DIAPHRAGM (CM.)	INTENSITY
	<i>cm.</i>	<i>C.M.</i>
1	10.5	97.28
2	20.5	25.52
3	30.5	12.955
4	40.5	7.665
5	50.5	4.205
6	60.5	2.93

The test was made by three methods: 1) testing individual animals for a series of days, each day at a different intensity; 2) testing several animals from the same habitat on the same day, each animal at a different intensity, and 3) trying the different intensities in turn on each animal.

The experiments showed that the response is in general the same to all intensities which were tried. If an individual isopod is negative it is negative to all intensities, while if it is indifferent, it is alike indifferent to all intensities. This result was obtained by all three of the methods described, so that the different methods furnish a check on each other.

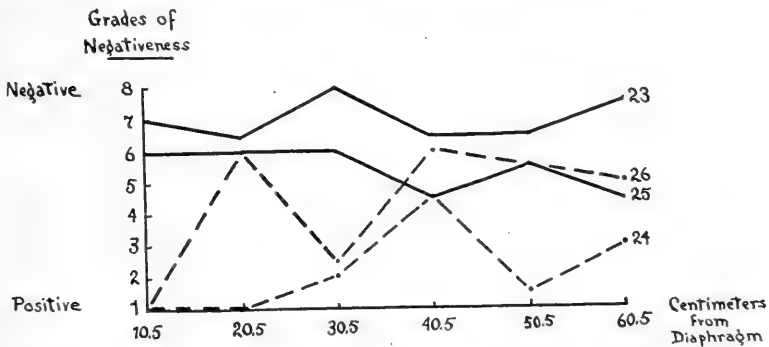

Fig. 8 Reactions to light of different intensities. Two individuals of *Oniscus* (23 and 25) and two of *Porcellio rathkei* (24 and 26). Numbers on abscissa indicate distances in centimeters from slit in diaphragm through which light passes. Intensities at each of these points are given in the table on page 216. Numbers on ordinate indicate the eight degrees of negativeness shown in figure 2. Shows no consistent variation corresponding to the intensity.

The third method is perhaps the most satisfactory, because it eliminates errors due to differences between individuals and to variations in 'physiological state' on successive days. It has the disadvantage that the result is based on four responses only (one in each position) at each intensity, rather than on twenty responses.

The reactions of four isopods, classified according to this method, are shown graphically in figure 8. The numbers on the abscissae indicate the distances from the light, which correspond

to the intensities given in the above table, while the numbers on the ordinates refer to the eight degrees of negativeness, according to the classification of figure 2.

In the diagram the reactions of the two individuals of *Oniscus* (A 23 and A 25) are represented by nearly straight lines, showing approximately the same negative response to all intensities used in the experiment. *Porcellio rathkei* (A 24 and A 26) has the usual variations for the species, but these bear no relation to the intensity. The figure merely illustrates graphically the conclusions given above.

When tested by the first method described above, *Porcellio scaber* gave its normal reaction also at a point 5.5 cm. from the diaphragm, where the intensity was approximately 400 C.M.

b. Low intensities. Some species of animals which are normally negative to light are indifferent to low intensities, while a few are positive under the same conditions. For this reason, a series of tests with low intensities was arranged. These intensities were obtained by using Mazda and carbon lights of lower power and by increasing the distance between the isopod and the source of light.

After finding *Oniscus* negative to intensities of 0.859 C.M. and 0.648 C.M., a final series was tried with intensities which were too low to be measured directly by the illuminometer, but which could be calculated from illuminometer readings at other points, according to the law of inverse squares. The results in this series, given in table 5, represent the reaction of ten individuals each of *Oniscus* and *Porcellio scaber* at each intensity, the figures referring to the average reaction for each individual, rather than to the individual responses.

As the animals were tested when facing the light only, those which went toward the light were perhaps indifferent instead of positive.

Table 5 shows that *Oniscus* was negative, even at these low intensities. This was shown so strikingly by the test at the lowest intensity recorded (0.0119 C.M.) that a further description will be given of this particular experiment. The illumination of the table was so slight that the sowbugs were

TABLE 5

Reactions to low intensities of light. Numbers refer to the average reactions of individual isopods

ISOPODS	INTENSITY	REACTION			
		Negative	Positive	Indifferent	No response
	<i>C. M.</i>				
Oniscus.....	0.169	10			
	0.0749	7	1	2	
	0.0255	10			
	0.0119	9		1	
Perceilio.....	0.169	6	3	1	
	0.0749	7	2	1	
	0.0255	3	2	2	3
	0.0119	7	1		2

almost invisible, although scarcely 30 cm. from the eye of the observer. A faint reflection on the chitin covering made it possible, but not easy, to determine the position of the animal, particularly during locomotion. Of course the actual horizontal illumination which reached the eyes of the animal was considerably greater than was reflected to the observer above. In spite of the fact that the light was so dim, *Oniscus* turned away from it as definitely as from the stronger intensities between 1 and 100 C.M. Nearly all of the individual animals, on starting locomotion, turned directly away, without describing as large an arc as is common when higher intensities are used.

As a control for this experiment, ten individuals of *Oniscus* were tested immediately afterwards in total darkness. The result showed no orientation to any external stimulus, and in most instances locomotion was in the direction in which the animals were already headed. The actual course taken was determined by means of a flashlight after the isopod had been in the dark long enough to start in a definite direction. As all conditions except exposure to light were the same in the control as in the experiment, the results with low intensities must have been due solely to the light.

According to Patten ('17, p. 260), "It is the abruptness with which orientation is attained, rather than the final accuracy of

orientation, which shows the results of slight differences in effectiveness of the receptive mechanism." If that be so, the abrupt and definite orientation of *Oniscus* to low intensities indicates that *Oniscus* is extremely sensitive to light and is definitely oriented by light.

The reactions of *Porcellio* to low intensities show as usual more variation than those of *Oniscus*, but they are in the main negative, and essentially the same as the reactions to higher intensities. They show that *Porcellio*, as well as *Oniscus*, is responsive to extremely low intensities of light.

These results are particularly interesting, because Banta ('10) found *Asellus communis* unresponsive to light of an intensity of 1 C.M. or less. As will be considered later, *Oniscus* and *Porcellio* appear to be more sensitive to light than is *Asellus*, the common fresh-water isopod.

The conclusion to be derived from these experiments is that land isopods are sensitive to a wide range of light intensity and their reaction to all intensities is essentially the same.

2. *Effect of repeated stimulation*

A second condition which might change or reverse the reaction is repeated stimulation. For these experiments, *Oniscus*, since it is definitely negative, was chosen, in order to watch for a possible reversal from negative to positive phototaxis. The animals were placed facing the light, so that every negative response would necessarily mean a definite turning away from the source of the stimulus. Records were made in each instance of the course taken and of the interval before response. Whenever no response occurred during sixty seconds, the result was recorded as "no response, sixty seconds."

Sixteen individuals were used in these experiments and were given a varying number of successive stimuli: one animal received 100 successive stimuli, three received 60, one received 40, five received 30, and six received 20. The longest time used in testing any one animal was one hour. The first individual mentioned, which gave 100 responses in one hour, was unusually active.

TABLE 6

Results of experiments testing the influence of repeated stimulation on Oniscus. The animals were facing the light in all instances. Intensity 12.955 C.M.

RESPONSES	NUMBER OF INDIVIDUALS ¹	ANGLE OF NEGATIVENESS	INTERVAL IN SECONDS BEFORE RESPONSE
1-10	16	81.00°	9.25
11-20	16	78.75°	21.01
21-30	10	87.75°	25.60
31-40	5	90.00°	15.56
41-50	4	91.125°	16.875
51-60	4	81.00°	25.625

¹ The numbers in this column diminish, because the tests of only four individuals were continued through 60 stimuli, others extending only to 40, 30, and 20.

The results were compiled by dividing the responses into groups of ten successive responses and measuring the average angle of negativeness.

Table 6, which summarizes the reactions of these sixteen animals, shows no influence of repetition upon the character of the response.

The average turning from the light was as definite after sixty successive stimuli as at first.

Whatever effect was caused by the delay is shown by a lessening of activity as is indicated by the interval before response, shown in the last column of table 6. The figures are only approximate, as all delays over 60 seconds were counted as 60 seconds in making the averages. The essential conclusion is that after the first few trials there is usually a slight decrease in responsiveness, but from that time on there is little change. The delay is probably due chiefly to the effects of handling, as a similar delay occurs just as readily when the animals are moved about on the table by the same method of manipulation, but not exposed to light at all.

Furthermore, while there were changes in individual behavior which are not shown in the above table, there was no consistent change in phototaxis which could be traced to the effects of repetition. In some individuals the angle of negativeness decreased with continued stimulation, in others it increased, while in still others it passed through both of these variations successively.

TABLE 7

Analysis of the reaction of Oniscus F 2, exposed to light of 12.955 C.M. for 100 successive stimuli. Duration of experiment one hour

RESPONSES	ANGLE OF NEGATIVENESS	INTERVAL IN SECONDS BEFORE RESPONSE
1-10	49.50°	5.5
11-20	90.00°	7.0
21-30	96.75°	7.0
31-40	74.75°	3.0
41-50	81.00°	8.0
51-60	94.50°	15.0
61-70	40.50°	12.5
71-80	54.00°	7.0
81-90	51.75°	9.0
91-100	42.75°	0.0

Some individuals appeared to 'tire out,' others continued active as long as they were tested, but no correlation was observed between delayed reaction and definiteness of turning from the light.

As an example of individual rather than of species behavior, a summary is given in table 7, of the reaction of *Oniscus F 2* which responded to 100 successive stimuli.

The characteristics of this animal were that it was very active without any diminution of activity at the end of 100 stimuli and that it was not as negative to light as are most individuals of this species. In the first ten responses it was indifferent or positive, then it became much more negative for fifty successive responses, after which it became once more somewhat indifferent. These changes are shown in the table by the column for the angles of negativeness. As the animal was not negative at the beginning, this table does not illustrate the usual behavior for the species.

From this series of experiments on repeated stimulation it may be concluded that the phototaxis of *Oniscus* is not changed or reversed by a long series of successive responses. Even when the animals become gradually less active, they continue to turn away from the light by as definite an angle as when they were first exposed to it.

3. Comparison of reactions following exposure to light and to dark

Most of the isopods used in the preceding experiments had been living in the dark, but some had been exposed to the daily changes of an ordinary room. No relation was observed between the degree of negative phototaxis and this difference of exposure.

The effect of continued illumination by strong artificial light was tested in a few individuals of both *Oniscus* and *Porcellio*. They were placed in a dark room and exposed for a few hours, and in some instances for a longer period, to an electric light, with a rectangular glass jar of water to absorb the heat, between the light and the terrarium. While most of the experiments already described furnish a suitable control on these results, additional tests were made, using animals which had been placed in a dark corner of the room during the time that the other individuals were exposed to light. In a few instances, the same animals were placed alternately in the two habitats.

A comparison of the reactions of isopods from these two sources is shown by the diagrams in figures 9 and 10, and by the angles of negativeness in table 8.

TABLE 8

Comparison of the angles of negativeness, following exposure to artificial light and to darkness. Oniscus and Porcellio rathkei

	ONISCUS	PORCELLIO
From light.....	117.00°	67.50°
From dark.....	112.40°	103.50°

The results after exposure to light are compiled from five individuals each of *Oniscus* and *Porcellio rathkei*. The control for *Porcellio* is compiled from records for ten individuals. That for *Oniscus* is a summary of the daily reaction for fifteen days of *Oniscus* A 12 (tables 3 and 4, fig. 7), which was a member of this control series. In the charts, the eight degrees of negative reaction are represented by the abscissae, while the ordinates indicate the proportional number of responses, all the curves being drawn to the same scale.

A generic difference appears in the results. *Oniscus* was negative, regardless of previous exposure, with the reaction apparently uninfluenced by strong light. On the other hand, *Porcellio* showed a high degree of positiveness after exposure to light. A probable explanation for the two modes in the curve for *Porcellio* (after exposure to light) is that three out of five indi-

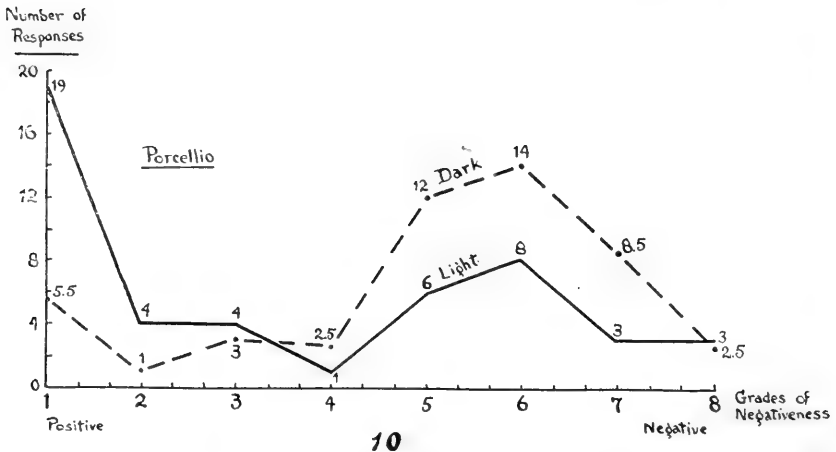
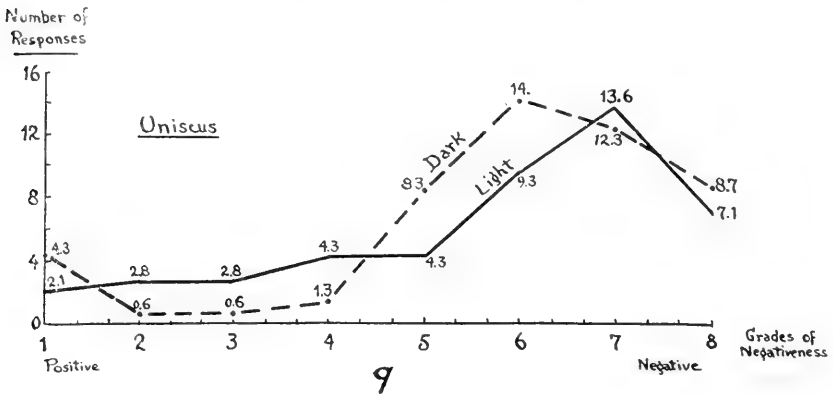

Figs. 9 and 10 Comparison of reactions after exposure to strong artificial light and to dark. Fig. 9, *Oniscus*; Fig. 10, *Porcellio rathkei*. Numbers on abscissae indicate grades of negativeness shown in figure 2. Numbers on ordinates indicate number of responses in each of the eight classes. Fig. 9 shows little difference between the responses of *Oniscus* under the two conditions. Fig. 10 shows that *Porcellio* was somewhat positive after exposure to strong light.

viduals tested were decidedly positive, while the other two were negative. The positive animals were in fact so decidedly positive that two of the three gave positive responses even when they were headed away from the light. The difference is shown in table 9, which summarizes the individual reactions of the five animals after exposure to light, together with a second series of reactions after exposure to dark, made two days later by approximately the same individuals.

In table 9 the numbers are arranged in order of magnitude, but most of the individuals appear in both columns.

TABLE 9

Individual behavior in the species Porcellio rathkei after exposure to light and to dark. Intensity 12.955 C.M.

FROM LIGHT (NOVEMBER 20)		FROM DARK (NOVEMBER 22)	
Identification number	Angle of negativ- ness	Identification number	Angle of negativ- ness
B8.....	31.25°	C11.....	76.50°
B14.....	31.25°	C12.....	78.75°
B11.....	42.75°	C10.....	108.00°
B12.....	99.00°	C13.....	126.00°
B13.....	130.50°	C9.....	139.50°
Average.....	67.50°	Average.....	103.50°

These experiments on the influence of preceding illumination, while they were not carried far, indicate the possibility that negative phototaxis in land isopods may be diminished or reversed by exposure to strong light. This appears from the experiments to have been true for some individuals of *Porcellio*, but the fact that a like result was not obtained from *Oniscus* makes it less conclusive.

4. *Comparison of reactions of individuals from dry and moist habitats*

The moisture conditions of a habitat are not easily measured, but it is possible to place sowbugs in what must be close to the extremes in which they can live, so far as moisture is concerned. For a minimum of moisture, they can be kept in an environment

so dry that few individuals of *Oniscus* survive, *Oniscus* requiring more moisture in its surroundings than does *Porcellio*. For a maximum, the substratum can easily be kept saturated with water.

A comparison of the reactions, after keeping the isopods for over a month in these two extreme habitats, is shown in figures 11 and 12.

According to figure 11, *Oniscus* gave essentially the same negative reaction regardless of preceding moisture conditions. Both curves are typically negative and resemble each other closely.

On the other hand, *Porcellio scaber* (fig. 12) from the dry habitat was somewhat less negative than the same species from moist surroundings, but both curves for *Porcellio* show a considerable degree of indifference to the stimulus.

There is, therefore, little evidence that the reaction varies greatly according to the amount of moisture in an isopod's environment. The chief observable difference in the effect of the two habitats is an increase of activity under dry conditions, which has no apparent relation to the character of the phototaxis. It is interesting that, although, of the two genera, *Porcellio* is the more adapted to survive atmospheric dryness, lack of moisture should apparently affect its behavior more than that of *Oniscus*.

5. Reaction in water

In studying the amphipod, *Orchestia agilis*, which spends most of its life out of water, Holmes found ('16, p. 105) that, when thrown into water, these normally positive Crustaceans became at once strongly negative. As sowbugs, when placed in water, will remain active for some time before showing ill effects, it was possible to try a similar test with them. Five individuals each of *Oniscus* and *Porcellio rathkei* were placed in a rectangular jar of water and exposed to horizontal light of an intensity close to that used in most of the experiments previously described. The isopods moved about to a considerable extent, but there was no orientation with respect to the position of the light.

Apparently the unnatural condition of being submerged in water made them indifferent to light.

This change from a negative reaction to indifference corresponds to the changes found by Holmes, in that normal photo-

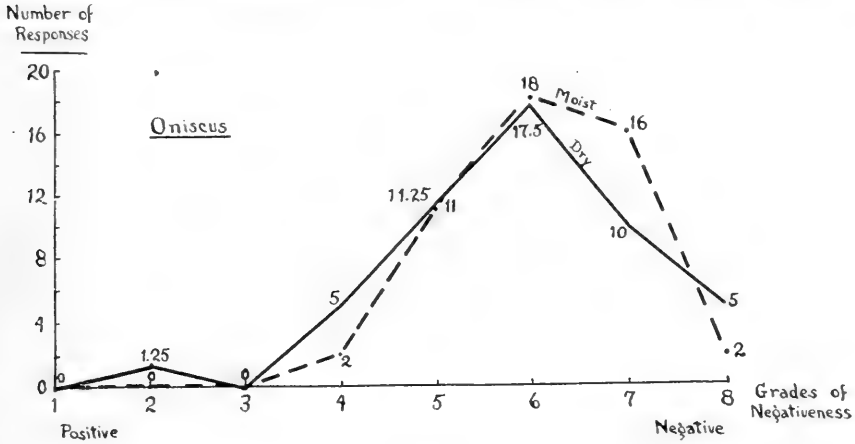

11

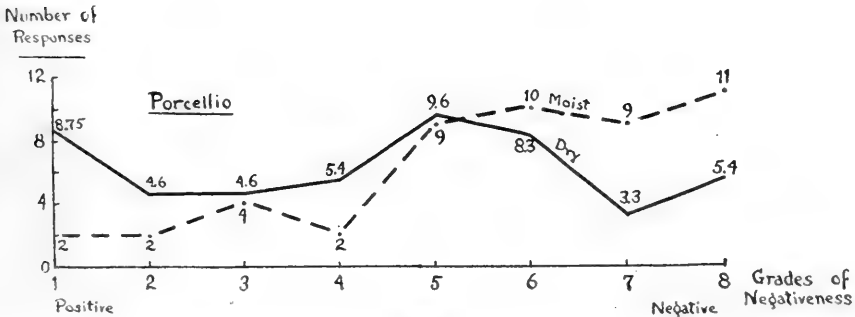

12

Figs. 11 and 12 Comparison of reactions after exposure to a minimum and maximum of environmental moisture. Fig. 11, *Oniscus*; Fig. 12, *Porcellio* scaber. Numbers on abscissae indicate grades of negativeness shown in figure 2. Numbers on ordinates indicate number of responses in each class. Fig. 11 shows practically no difference between the responses of *Oniscus* under the two conditions. Fig. 12 shows a slight difference in *Porcellio* under the two conditions, the animals being less negative after living in a dry habitat.

taxis is altered by throwing the animals into water. The effect is due, according to Holmes' explanation, to unusual contact stimuli.

6. Comparison of phototaxis in *Oniscus* and *Porcellio*

In the foregoing discussion many references have been made to differences between *Oniscus* and *Porcellio*. Any conclusions which may be drawn from these experiments in modifiability of behavior will be more clear after consideration of this generic difference.

A comparative study of the phototaxis of *Oniscus* and of *Porcellio* is given in table 10, which records the angles of negativeness in six series of experiments, most of them already reported in the preceding pages.

TABLE 10

Comparison of angles of negativeness of Oniscus and Porcellio in various phototaxis experiments. A, animal facing light; B, animal facing away from light; C, right side illuminated; D, left side illuminated

MATERIAL	ONISCUS		PORCELLIO		SPECIES
	Summary A, B, C, D	Summary C, D	Summary A, B, C, D	Summary C, D	
Newly collected.....	139.50°	135.00°	110.25°	105.75°	} <i>Porcellio</i> <i>scaber</i>
From maximum of moisture.....	123.75°	126.00°	117.00°	119.25°	
From minimum of moisture.....	121.50°	123.75°	92.25°	87.75°	
From dark.....	130.50°	122.40°	101.25°	103.50°	} <i>Porcellio</i> <i>rathkei</i>
From strong light.....	114.75°	117.00°	72.00°	67.50°	
At different intensities.....	128.25°	126.00°	72.00°	61.87°	

As the parallel columns show little differences in the two methods of compiling results, the angles from positions C and D will be referred to, whenever, in the discussion, quotations are made from the table.

1. The phototactic response of *Oniscus* was negative, with little variation in the degree of negativeness under the different conditions. The averages, from the lowest (117°) to the highest (135°), show a range of only 18°, which is less than the difference

(22.5°) between any two adjoining classes of the eight grades of negativeness (fig. 2). The smallness of this range is shown diagrammatically in figure 13.

2. *Porcellio* showed a much wider variation, the differences between the lowest (61.87°) and the highest (119.25°) averages recorded being 57.38° . This also is shown in figure 13,

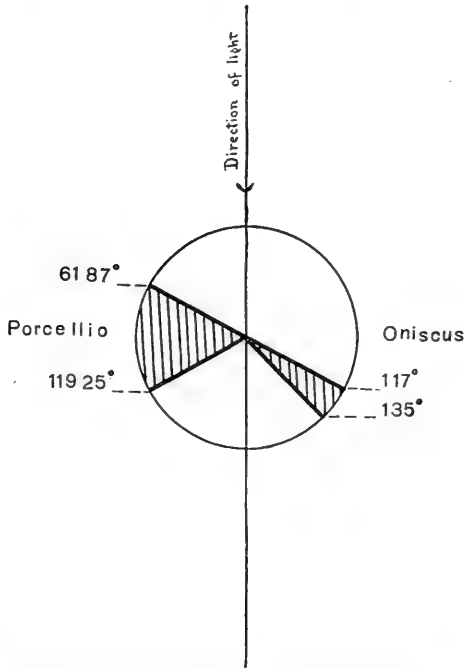

Fig. 13 Diagrammatic representation of the comparison of the reactions of *Oniscus* and *Porcellio* given in table 10. The shaded areas show the range of the average angles of negativeness under the six conditions, when the animals were illuminated on the side (positions C and D). *Porcellio* has a wider range than *Oniscus*, part of the averages showing a slight turn toward the light.

which shows a considerable degree of variability. In what were probably the more normal of the conditions (i.e., when newly collected, from a dark normal habitat, and from a maximum of moisture), the reaction of *Porcellio* was negative, but, after continued exposure to strong light and when exposed successively to light of different intensities, the reaction tended to be positive.

The reactions of the two species of *Porcellio* appeared in various experiments to be essentially alike, but no comparative tests were made. The present paper deals only with generic differences.

3. *Oniscus* was more negative than *Porcellio* under all conditions¹ in which comparative experiments were made, and, as is shown in figure 13, the range of reaction in *Porcellio* was much greater. Furthermore, a decided reversal of reaction from negative to positive was observed more frequently in *Porcellio* than in *Oniscus*. While in most instances the cause of this reversal was not determined, one apparent cause in the case of *Porcellio* was continued exposure to strong artificial light (fig. 10, table 9).

4. To summarize the preceding statements, *Oniscus* and *Porcellio* are both negative to directive light, but *Porcellio* is the less negative. The reaction of *Porcellio* appears to be modified more readily by changes in both internal and external conditions. The possible ecological significance of this difference between the genera will be considered in a later section.

7. Conclusions

The reaction of *Oniscus* is negative under nearly all of the conditions tried and is not easily modified. At times in the course of the experiments, individuals of this species have shown a high degree of positiveness, but the cause for this occasional behavior has not as yet been found in any of the modifying conditions tried. The normal negative phototaxis was lost under the unnatural conditions of an aquatic environment.

¹ In the one instance where there is apparently little difference between the two genera, when the animals were taken from a maximum of moisture, the real contrast is shown by a comparison of figures 9 and 10. The arithmetical mean (A.M.), from which the figures for the angle of negativeness were derived, was similar in the two instances, but the true distinction is shown by the average deviation (A.D.), and by calculating the coefficient of variability (C.V.) by the formula $C.V. = \frac{A.D.}{A.M.}$. The results are shown in a table.

Genus.....	A.M.	A.D.	C.V.
<i>Oniscus</i>	6.1	0.741	0.121
<i>Porcellio</i>	5.8	1.555	0.268

According to the experiments, the behavior of *Porcellio* appears to be somewhat modified by external conditions. These animals were less negative after living in a dry atmosphere, after exposure to strong light, and when exposed successively to different intensities. The most striking result was a reversal to positiveness which occurred in certain individuals after exposure to strong light (fig. 10, table 9).

As was shown in the preceding section, the normal phototaxis of *Porcellio* shows a great amount of variation, and hence it is difficult to say to what extent these modifications are actually due to the external conditions of the experiments.

VI. DISCUSSION

A. ECOLOGICAL ANALYSIS

Ecology is the study of the relation between organisms and their environment. Ecological studies deal both with the distribution of animals and plants and with adaptation, which may be defined as the sum of the structural and functional methods by which the organism is fitted to its environment. The word adaptation is used without implying any theory as to the cause of adaptation. Inasmuch as the present emphasis of studies in animal and plant ecology is particularly on adaptations of a physiological nature, the study of animal behavior has become of increasing ecological importance.

One of the essential distinctions between structure and behavior is that structure, in the main, is dependent on genetic relationships, while behavior is closely related to the nature of the environment. Without attempting to settle the problem whether environment is the cause of behavior, the facts remain that animals of various structures tend to have the same behavior, if they occupy the same environment (Shelford, '14, '16) and that individuals of a single species from different environments often have a difference in behavior corresponding to the environment (Allee, '12, '14; Adams, '15). A particular plan of structure may be suited to a wide variation in environment, provided that the behavior of the animal varies according to the

environment. Because of this fact, such diverse animals as annelid worms, gasteropods, and crustaceans, which are all found in a wide variety of habitats, frequently occur together in the same ecological association.

The environmental importance of behavior characters is shown further in a discussion by Vestal ('14), in which he compares in detail five sets of characters—structural, physiological, psychological, biographical, and numerical. Vestal concludes that, at least so far as competition with other animals is concerned, 'psychological' or, as he preferably calls them in another connection, behavior characters, are actually the most important of all.

In order to discuss intelligently the significance of the phototaxis of land isopods, a partial ecological analysis of these animals will be given.

1. *Habitat*

A habitat analysis may be made on the basis of a table by Adams ('15, p. 95), which summarizes for comparative purposes the habitats of prairie and forest invertebrates. The ground stratum of the forest, which land isopods typically occupy, is a region where they are exposed, comparatively speaking, to a large amount of humidity, a small amount of evaporation, and a fairly constant temperature. For animals only slightly adapted to land life, these appear to be the optimum conditions.

2. *Structural and physiological adaptations*

A brief discussion will be given of a few of the characteristics of land isopods which make possible their living in a habitat furnishing the conditions just mentioned.

a. Respiration. Land isopods have a somewhat generalized crustacean structure, with a hard outer covering of chitin, which prevents evaporation of water from the body. The organs of respiration, as in the aquatic isopods, are modified abdominal appendages (pleopods). The nature of the mechanism of respiration is still somewhat in doubt, although the subject has

always been the center of interest in these animals, and recent studies have been made by Stoller ('99), Bepler ('09), Bernecker ('09), Unwin ('09), Müller ('10), and Herold ('13). The following statements represent perhaps the most widely accepted opinion among these investigators.

1. In most and probably all genera the thin-walled inner branches (endopodites) of the pleopods are used for respiration. They are covered and thus protected by the outer branches (exopodites) and are kept moist by glandular secretions.

2. The outer branches in most forms, besides serving as a protection for the inner branches, have trachea-like modifications for breathing atmospheric air. Of the two genera used in the experiments reported in the present paper, *Porcellio* has these structures better developed than *Oniscus*. Correlated with this fact is the ability of *Porcellio* to live in drier situations than *Oniscus*. Of the species of *Porcellio*, *P. rathkei* is somewhat better adapted to air-breathing than *P. scaber*.

3. The character of the endopodites resembles closely that of the same structures in *Asellus communis*, the fresh-water isopod previously referred to. The most primitive land isopods, the family Ligydidae, have 'gills' closely resembling those of *Asellus*. This seems to indicate that isopods as a group were particularly suited to a change from water to land, since only slight modifications in the respiratory mechanism proved necessary.

b. Food. The food and feeding habits of land isopods and of *Asellus* have been investigated, respectively, by Murlin ('02) and Banta ('10, p. 477). Both kinds of animals exercise little selection in their choice of food and take a large percentage of inorganic matter into the digestive tract with the food.

c. Care of young. The developing young of isopods remain in a brood-pouch on the ventral surface of the female until they have developed into the adult structure. In this way the young are protected during their early existence and no special device during the early stages is necessary to adapt them to land life.

d. Behavior. So far as respiration, feeding habits, and protection of developing young are concerned, land isopods are little different from their aquatic relatives. The isopod plan of

structure seems to be suited to terrestrial as well as aquatic life. However, land isopods are confined to a limited, protected environment, and are not suited, like insects, to become dominant land animals. The fact that they remain in the environment in which they are fitted to survive is probably due chiefly to another set of characters, those which make up the behavior. These characters will now be considered.

3. *Reactions of land isopods*

Although the entire behavior complex is involved in adaptation, it is possible to make a partial analysis into reactions to various classes of stimuli. Among the most important factors of the environment of land animals are humidity, evaporation, contact, and light.

a. Reactions to humidity and evaporation. So far as observation shows, the effect on land isopods of exposure to a dry atmosphere, including the first effect in desiccation experiments, is an increase of activity. This is a useful adaptation, provided the activity carries them to other regions where moisture conditions approach more nearly the optimum.

The problem whether these animals have a definite reaction to differences in humidity and evaporation has not been investigated. The most satisfactory method yet devised for making such tests is doubtless that of Shelford for testing reactions to the evaporating power of air. Among the species of animals in which he has found such a response (Shelford, '13 a) are several commonly associated with sowbugs, including ground beetles, salamanders, snails, and the yellow-margined millipede (*Fontaria corrugate* Wood). No similar experiments have thus far been recorded for land isopods, but it is quite possible that they, too, give a negative reaction to increased evaporating power of air, and as a result remain in places where evaporation is at a minimum. The somewhat unusual occasions when they visit exposed places may possibly be only at times when there is a large amount of atmospheric humidity.

b. Reactions to contact. Isopods as a group have the general plan of structure common to contact animals, as is seen best of all in the oval bodies, with flattened ventral surfaces, which characterize the Oniscoidea. Positive thigmotaxis is doubtless an important factor in keeping them in a suitable habitat. The use of the sense of contact as a substitute for the sense of sight has already been referred to (page 198).

c. Reactions to light. With the recognition that land isopods are contact animals and that further studies will probably show reactions to other classes of stimuli, the part in their normal life played by the reaction to light remains to be considered. Since studies of the reaction, both to artificial light and to daylight, have shown that sowbugs are decidedly negative, even to low intensities and since the reaction is constant under most conditions, it seems reasonable to conclude that negative phototaxis is a character to be considered in an ecological interpretation of these animals.

Inasmuch as sowbugs usually live in the dark, it seems probable that during the greater part of the time light is not an influential factor in their lives. When, however, they accidentally wander from their places of concealment, their reaction to light may be expected to turn them back again into the dark. Their actual behavior out of doors when exposed to light can be observed when a log or other object concealing them is overturned. Under these conditions, some of the sowbugs become active at once, soon disappearing in crevices or under the log, while others crouch down motionless. In the latter case, when thigmotaxis apparently overcomes phototaxis, the result is only temporary, for in a short time no sowbugs are in sight. Although the light is so diffuse that it cannot direct their course as unmistakably as under experimental conditions, yet its influence seems sufficient to carry them to dark places and to keep them there. From this fact it may be concluded that light serves as a stimulus to turn them back whenever they wander into it in the course of their ordinary activities. The same is probably true in the early morning, whenever they leave their places of concealment at night.

The fact that the reaction of *Porcellio* appeared from the experiments to be less negative than that of *Oniscus* is correlated with other generic differences. *Porcellio*, because of the structure of its respiratory appendages, is better provided for living in dry situations than is *Oniscus*, and hence has perhaps less need of a definite negative reaction to keep it in its proper environment.

Furthermore, the phototaxis of *Porcellio* seems to be reversed from negative to indifferent or positive more easily than that of *Oniscus*. This has been observed under natural as well as experimental conditions. A good example was noted at Cold Spring Harbor, Long Island, in July, 1916, when *Porcellio* was found commonly for three or four days on green plants at a height of four or five feet from the ground. Among the possible causes for this unusual behavior was a partial or complete flooding of the ground habitat, but, whatever the cause, it was apparently accompanied by a reversal from the usual negative phototaxis, with perhaps also a reversal of geotaxis.

Table 10 also suggests, although in this case it does not offer a suitable basis for comparison, that possibly *Porcellio rathkei* is less negative than *P. scaber*. If so, this furnishes a further correlation, since, as has been mentioned, the breathing appendages of *P. rathkei* are, of the two species, the better adapted to air respiration, and its habitat is probably slightly less restricted.

Whether or not it is possible to find any evolutionary significance in this behavior, it is, at any rate, worth while to compare the phototaxis of land and of water isopods. The most complete study of the light reactions of any aquatic isopods which has yet been made is that by Banta ('10). Table 11 compares the results for *Oniscus*, recorded in the present paper, with Banta's summary ('10, p. 268) of the reactions of *Asellus communis*.

This comparison indicates that, of the two genera, *Oniscus* is the more definitely negative. The negative reaction helps to prevent *Oniscus* from leaving its habitat in the daytime, while *Asellus*, with no such restricted habitat, is at definite times positive to light.

TABLE 11

Comparison of phototaxis of Oniscus asellus (this paper) and of Asellus communis (Banta '10, p. 268)

ONISCUS	ASELLUS
Reacts to intensities as low as 0.0119 C.M.	Does not react to intensities of 1 C.M. or less
Negative to light, regardless of previous exposure	Negative after exposure to diffuse daylight Positive for a few hours after exposure to darkness

When Porcellio is compared with Asellus, the contrast is not so striking, because Porcellio is somewhat like Asellus in not being always negative. However, the fact that Porcellio, like Oniscus, responds to intensities as low as 0.0119 C.M. suggests that it, too, is more discriminating in its reaction to light than Asellus. Whether or not negative phototaxis was intensified as an adjustment to land life, it at least appears to be a more important factor in the activities of land isopods than of aquatic isopods.

In this connection a few observations will be given concerning one of the most primitive of land isopods, so regarded because its structure is less specialized for life on land. The large active isopod, known as the sea slater (genus *Ligyda*), lives in crevices of rocky shores just above the high-tide line among the San Juan Islands of the northern part of Puget Sound. At low tide these isopods emerge from their hiding-places and migrate down the rocks nearly to the low-tide line. During this period they can often be seen moving about with apparent disregard of the bright sunlight. At other times, however, they are found in crevices, and in the laboratory they give a negative reaction to sunlight. In their case the reversal of reaction keeps them in the damp region close to the water's edge, so perhaps it is advantageous for them not to have so consistent a negative reaction to light as that of *Oniscus*.

From this ecological study of the phototaxis of land isopods it may be concluded that the usual negative phototaxis is advan-

tageous to this group of animals, because it keeps them in a suitable habitat. Such reversals of reaction as occur are probably adaptive also. Unless other reactions are so important as to overcome the influence of the phototaxis in ways not yet determined, observations and experiments indicate that this reaction is an important ecological character, and, further, that it may have been one of the factors which made possible the migration of the ancestors of the present land isopods from water to land.

B. THE PROBLEM OF ORIENTATION

In addition to the ecological analysis, a few observations can be related to the problem of orientation, which has a large place in behavior studies. The subject of orientation has been so thoroughly discussed, particularly in such general works as those of Jennings ('06), Mast ('11), Loeb ('16), and Holmes ('16), that no extended introduction is necessary. A distinction which Darwin ('80) made, according to Mast, is, however of importance. To quote from Mast ('11, p. 47): "To explain orientation, Darwin said, we do not need to account for movement; it is only necessary to account for changes in the direction of movement."

The problem is well formulated by Bancroft ('13) in two questions which he applies to *Euglena*, but which could be asked equally well with regard to any other organism:

1. Does *Euglena* become oriented to light as directly as its method of orientation admits, or does it orient indirectly by the method of trial and error? In either case the reaction will be heliotropic, but the method of orientation will be different.
2. Is heliotropism in *Euglena* brought about by response to temporal changes in light intensity, or is it caused by the continuous action of the light independent of changes in intensity?

This division of the subject by Bancroft into two distinct problems avoids a source of confusion which has occurred in most discussions of the question.

1. *Direct orientation versus method of trial*

The study of Torrey and Hays ('14) on the orientation of *Porcellio* to light resulted in the conclusion that orientation is direct and that the many preliminary movements of the antennae before locomotion, which appear to correspond to the 'random movements' in the forms studied by Holmes ('05), have no relation to orientation. These authors concluded that: "The consistency with which many individuals turned *away* from the light, whether the latter was on one side or the other, left no room for doubt that the reaction was *forced in a definite direction*."

Although the present investigation was not made specifically to determine the mechanics of response, observations in the ordinary experiments indicated that there is a definite orientation, which is little obscured by random movements. In the usual negative responses there is a time difference which makes possible a division into three classes of responses: 1) those in which orientation occurs without locomotion; 2) those in which orientation occurs abruptly at the beginning of locomotion; 3) those in which orientation occurs gradually during locomotion. Of these, the first is not frequent, although a characteristic response, while the second and third are both common. The third method, where orientation is secured by a gradually curved course, is in reality just as direct as the other two. If necessary allowance is made for individual peculiarities in the response, due probably to internal causes, the response seems to involve a direct orientation by the light, in which trial movements do not play any essential part.

2. *Constant intensity versus change of intensity*

The basis of most present discussions of orientation is, however, the second of those quoted from Bancroft, the question whether the response is due to continuous stimulation from light acting at a constant intensity or to the shock resulting from changes of intensity. A possible contribution to the solution of this problem may be found in an analysis of the frequent delays before response. Even when an isopod responds vigorously at

first, the delay sets in on the average after ten responses, so that in nearly every ordinary series of twenty trials some responses occur only after an interval.

When an animal does not respond to the initial light stimulus, there are three possible explanations why it responds later. These are: 1) a delayed response to the initial stimulus; 2) a response to the continuous stimulus, and 3) a response due to causes wholly other than light stimuli. Whichever of these is true, the difference between immediate and delayed response is a difference in photokinesis rather than in phototaxis, because orientation is quite as definite when the response is delayed as when it is immediate.

The opportunity for observing the influence of continuous stimulation after delayed reaction is found in those instances when orientation occurs before locomotion, whether or not it is accompanied by locomotion. Under these circumstances, the first locomotor movement of the animal after a delay is a turning movement, and the cause of the turning cannot be found in any change of intensity which has occurred since the initial stimulus on the eyes of the animal. That is, the reaction under these conditions must be due either to the continuous constant stimulus or to an after-effect of the shock produced by the initial stimulus.

This raises the further question: Would an isopod give an orienting response after a delay if the stimulus were not continued? Mast ('12) tested fireflies from this point of view, and in his summary says:

The males do not orient when exposed to continuous illumination. They respond only to flashes of light and the reaction does not begin until after the light has disappeared. Removal of the female immediately after she glows has no effect on the reaction. Thus orientation may take place in total darkness, and it is surprising how accurately these animals turn through the proper angle in the total absence of the stimulating agent. Here we have a case in which it is clearly demonstrated that light does not act continuously in the process of orientation as demanded by Loeb's theories, a case in which it is also clearly demonstrated that the continuous action of the stimulating agent is not necessary to keep the organism oriented.

This statement is not at all surprising, because sudden flashes of light are a part of the natural environment of the firefly, and the firefly is adapted to them in a unique way. On the other hand, since most animals are exposed to constant illumination and to gradual changes rather than to sudden changes, the firefly is hardly a typical animal in which to test out this point.

For this reason an experiment was devised to determine whether *Oniscus* can be oriented after a delay, in the absence of the original stimulus. Twelve individuals of *Oniscus* were tested in the position facing the light, according to the usual method. Record was made only when there was a delay in response lasting more than five seconds. In approximately half of these instances of delayed response in each animal, the light was turned off after five seconds; in the other half the animals were exposed to the light until they responded. (If no response occurred during 60 seconds, it was recorded as 'no response.')

The course taken by the animal and the interval before response were both recorded in each instance. The individual animals were given repeated stimuli until several delayed responses had been recorded under each of the two conditions.

In order to observe the animal after the light was turned off, the influence of overhead lights was tested until one was found so dim as not to affect the accuracy of orientation and yet strong enough to make it possible to watch the movements of the animals. In a preliminary test series with the light finally chosen, five individuals of *Oniscus* showed an average angle of negativity of 126° , which is thoroughly normal, and shows that the overhead light did not disturb the normal reaction to horizontal illumination. This light was, therefore, used during the entire experiment.

The result is shown in figure 14 and table 12. According to figure 14, the greatest number of responses when the light had been turned off fell into class 1 on the abscissa, with a gradually decreasing number of responses in the other classes. This shows that the animals moved in general in the direction in which they were headed, with no apparent response to the initial light stimulus. On the other hand, the curve of the responses when the

TABLE 12

Comparison of reactions of *Oniscus* after delay when light is continuous and when light is extinguished after 5 seconds. Intensity, 12.79 C.M.

	WITH CONTINUOUS LIGHT	WITHOUT CONTINUOUS LIGHT
Whole number of delays in response considered.....	84	80
Responses after delay.....	58 (69 per cent)	50 (62.5 per cent)
Failures to respond after delay.....	26	30
Average interval before delayed response....	31.7 seconds	34.6 seconds
Average angle of negativeness in delayed response.....	76.50°	49.50°

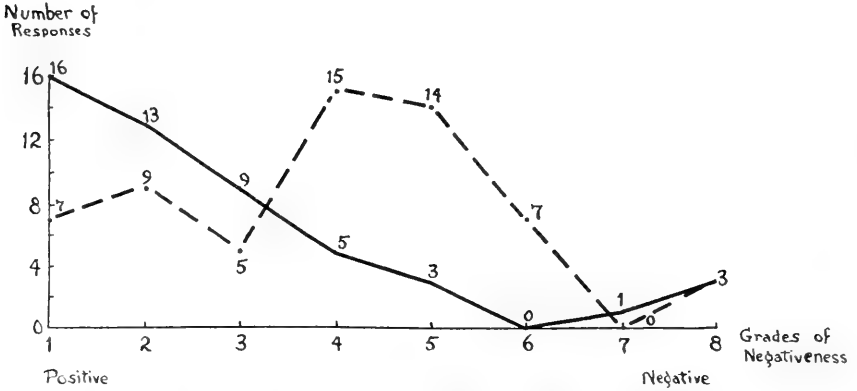

Fig. 14 Comparison of responses of *Oniscus* in instances of delayed response, when the light is turned off after five seconds (solid line) and when the light is continued (broken line). Numbers on abscissa indicate grades of negativeness in figure 2. Numbers on ordinate indicate number of each type of response. Shows practically no response after delay unless the light is continued.

light was continuous is nearly typical for the ordinary negative reaction of an animal facing the light. (Compare with A in figs. 6 and 7.) This set of responses after delay has a larger proportion of positive responses than was shown in figures 6 and 7, but it forms essentially the same type of curve and is quite different from the results when the light was turned off. The same difference is shown, though less noticeably, in table 12, where the angles of negativeness differ by 27°.

According to table 12, the length of the intervals before response and the percentage of response after delay are essentially the same under the two conditions of the experiment. This is, however, probably a matter of photokinesis rather than of phototaxis.

From this experiment it may be concluded that orientation in land isopods occurs after delayed response only when the stimulus is continuous. In other words, if the initial stimulus is not sufficient to bring about immediate response, the stimulus must be continued in order for orientation to occur. Since, then, the response to a continuous constant intensity can occur in cases of delayed response, there appears to be no reason why the same type of stimulus cannot be a cause of the reaction when the response is not delayed.

3. Conclusions

From the preceding experiments and discussion the following conclusions may be drawn:

a. Orientation of land isopods appears to be direct, and not the result of a selection of random movements.

b. Orientation is at times due to the continuous action of light acting at constant intensity, even though it may also be due to the shock produced by changes of intensity.

VII. SUMMARY

A study of the reactions to light of three species of land isopods, *Oniscus asellus*, *Porcellio rathkei*, and *Porcellio scaber*, resulted in the following conclusions:

1. Land isopods respond to light stimuli in three ways: by *photokinesis*, by *phototaxis*, and by *vision*. Vision is, however, only slightly developed. The experiments were confined to *phototaxis*.

2. *Oniscus* is negative to diffuse daylight and to controlled horizontal illumination by artificial light. The latter was shown in detail by a study of the percentage of negative responses, by a graphical representation of the degree of turning away

from the light, and by calculation of the average 'angle of negativeness.'

3. Porcellio is in general negative to the same stimuli as Oniscus, but is, of the two genera, the less consistently negative.

4. Oniscus and Porcellio were found to respond to a range of intensities from 100 C.M. to 0.01 C.M. *The response is the same to all intensities.* On account of the extreme sensitiveness to low intensities, the threshold of stimulation was not determined.

5. No consistent change in the phototaxis of Oniscus was caused by repetition of stimuli. Under these conditions, the animal usually became less active, but accuracy of orientation was not interfered with.

6. The reaction of Oniscus was essentially the same whether previously exposed to strong light or to dark and whether kept in a maximum or minimum of moisture. Porcellio was somewhat less negative after living in a dry habitat, and some individuals of this genus were found to be positive after exposure to strong light.

7. When the isopods were immersed in water, they did not respond to light.

8. Land isopods are not greatly different structurally from their aquatic relatives. They are confined to a limited habitat on the land, where humidity is comparatively high and the evaporating power of the air is relatively low.

9. Negative phototaxis appears to be a factor in keeping these animals in a suitable habitat, and is thus important in fitting them for life on land.

10. Oniscus, with a more restricted habitat than Porcellio, has a more consistent negative reaction to light.

11. Land isopods are more definitely negative to light than the fresh-water isopod, *Asellus communis*. Negative phototaxis appears to be a more important ecological factor for land isopods than for aquatic isopods.

12. Oniscus appears to be oriented directly by light, and to respond, at least under some circumstances, to a continuous light stimulus acting at a constant intensity.

VIII. BIBLIOGRAPHY

- ADAMS, C. C. 1913 Guide to the study of animal ecology. New York.
1915 An ecological study of prairie and forest invertebrates. Bull. Ill. State Lab. Nat. Hist., vol. 11, pp. 33-280.
- ALLEE, W. C. 1912 An experimental analysis of the relation between physiological states and rheotaxis in Isopoda. Jour. Exp. Zoöl., vol. 13, pp. 269-344.
1914 The ecological importance of the rheotactic reaction of stream isopods. Biol. Bull., vol. 27, pp. 52-66.
- BANCROFT, F. W. 1913 Heliotropism, differential sensibility, and galvanotropism in Euglena. Jour. Exp. Zoöl., vol. 15, pp. 383-428.
- BANTA, A. M. 1910 A comparison of the reactions of a species of surface isopod with those of a subterranean species. Jour. Exp. Zoöl., vol. 8, pp. 243-310, 439-488.
- BEPLER, H. 1909 Über die Atmung der Oniscoideen. Inaug.-Diss. Greifswald.
- BERNECKER, A. 1909 Zur Histologie der Respirationsorgane bei Crustaceen. Zool. Jahrb., Abt. f. Anat., Bd. 27, S. 583-630.
- COLE, L. J. 1907 An experimental study of the image-forming powers of various types of eyes. Proc. Am. Acad. Arts and Sci., vol. 42, pp. 335-417.
- DARWIN, C., AND DARWIN, F. 1880 Power of movement in plants. London.
- HEROLD, W. 1913 Beiträge zur Anatomie und Physiologie einiger Land-isopoden. Häutung-Sekretion-Atmung. Zool. Jahrb., Abt. f. Anat., Bd. 35, S. 457-526.
- HOLMES, S. J. 1905 The selection of random movements as a factor in phototaxis. Jour. Comp. Neur., vol. 15, pp. 98-112.
1916 Studies in animal behavior. Boston.
- JENNINGS, H. S. 1906 Behavior of the lower organisms. New York.
- LOEB, J. 1916 The organism as a whole. New York.
- MAST, S. O. 1911 Light and the behavior of organisms. New York.
1912 Behavior of fire-flies (*Photinus pyralis*)? with special reference to the problem of orientation. Jour. Animal Behavior, vol. 2, pp. 256-272.
- MÜLLER, G. W. 1910 [Über die Atmung der Landasseln]. Mitt. nat. Ver. Neu-Vorpommern, Rügen Jahrg., Bd. 41, S. 21-22. [Not seen by writer.]
- MURLIN, J. R. 1902 Absorption and secretion in the digestive system of the land isopods. Proc. Acad. Nat. Sc., Philadelphia, vol. 54, pp. 284-359.
- PATEN, B. M. 1917 Reactions of the whip-tail scorpion to light. Jour. Exp. Zoöl., vol. 23, pp. 251-275.
- RICHARDSON, H. 1905 A monograph on the isopods of North America. Bull. U. S. Nat. Museum, no. 54.
- SHELFORD, V. E. 1913 Animal communities in temperate America. Chicago.
1913 a The reactions of certain animals to gradients of evaporating power of air. A study in experimental ecology. (With a method of establishing evaporation gradients by V. E. Shelford and E. O. Deere.) Biol. Bull., vol. 25, pp. 79-120.

- SHELFORD, V. E. 1914 An experimental study of the behavior agreement among the animals of an animal community. *Biol. Bull.*, vol. 26, pp. 294-315.
1916 Physiological differences between marine animals from different depths. *Puget Sound Marine Sta. Pub.*, vol. 1, no. 14, pp. 157-174.
- STOLLER, J. H. 1899 On the organs of respiration of the Oniscidae. *Zoologica*, Bd, 10, Heft 25.
- TORREY, H. B., AND HAYS, G. P. 1914 The rôle of random movements in the orientation of *Porcellio scaber* to light. *Jour. Animal Behavior*, vol. 4, pp. 110-120.
- UNWIN, E. E. 1909 The respiration of land isopods. *Irish Natural.*, vol. 17, p. 236; *Rep. 78th Meet. Brit. Ass. Adv. Sc.*, pp. 736-737.
- VESTAL, A. G. 1914 Internal relations of terrestrial associations. *Am. Nat.*, vol. 48, pp. 413-445.

ASSORTIVE MATING IN A NUDIBRANCH, *CHROMODORIS ZEBRA* HEILPRIN¹

W. J. CROZIER

Bermuda Biological Station for Research

TWENTY-THREE FIGURES AND CHARTS

CONTENTS

I. Introductory.....	247
II. Mating pairs under natural conditions.....	249
III. Measurements.....	250
IV. Assortive mating in nature.....	254
1. Total length.....	254
2. Other measurements.....	259
V. Matings in mass experiments.....	265
1. Method and findings.....	265
2. Comparison with normal conditions.....	266
VI. The basis of homogamy.....	268
1. Homogamy in <i>Paramecium</i> and in man.....	268
2. Mating behavior of nudibranchs.....	270
VII. On the consequence of homogamy.....	278
1. Number of larvae produced.....	280
2. Size.....	286
3. Species crossing.....	287
VIII. Summary.....	287
IX. Postscript.....	288
X. References.....	291

I INTRODUCTION

Observation of copulating pairs of the large nudibranch *Chromodoris zebra* Heilprin under natural conditions in the field suggested that the component members of a pair tend to be of nearly the same size. Sexually mature individuals of this species which engage in mating at the same time and within a restricted area are found to range in total length from 4 to 18 cms. A difference in the size of two closely approximated specimens is

¹ Contributions from the Bermuda Biological Station for Research No. 98.

usually quite evident to the eye when the pair is viewed through a water glass. Two animals were considered to constitute a mating pair when they were found together in the proper relative attitudes and were seen to be stationary in these attitudes for some minutes. Copulating individuals remain in close contact for a relatively long time, in some cases several hours.

It is true that when collecting in a fathom or more of water from a boat, mistakes may be made in judging mating couples, although I believe that this error has not been great. Because of this possibility, however, and a desire to observe more closely the details of behavior in copulation, with reference to the possible mechanism of assortive mating (should this condition be found to exist), experiments were performed under laboratory conditions with a large number of individuals.

The pairs collected in the field, and those obtained in laboratory matings were measured in the living condition. Analysis of the dimensions of the individuals found spontaneously copulating amply confirms the impression derived from the inspection of mating couples under natural conditions. A moderately high degree of correlation between the sizes of the two individuals forming a mating pair is evident in the measurements obtained. This can only be understood in terms of the conclusion,—which is substantiated by the study of individual behavior in conjugation,—that assortive mating with respect to size (? age) is practiced by *Chromodoris zebra*.

The magnitude of the correlation index for the 'total length' measurements is somewhat greater than the average known for cultures of *Paramecium* containing a mixture of races. The principal significance of assortive mating in *Chromodoris* is, however, probably different from that assigned to homogamy in *Paramecium* (Jennings). It seems that in *C. zebra* the immediate result of assortive mating is to increase the number of larvae beyond that which could be established by random pairing.

From the standpoint of species survival and dispersal, granted the condition that animals of very different sizes are sexually mature, this effect of homogamy is distinctly purposeful. It is

desirable to emphasize the probably mechanical nature of the origin and maintenance of this 'adaptive' condition, which can be shown to depend upon the way in which the body of *Chromodoris* is constructed.

II MATING PAIRS UNDER NATURAL CONDITIONS

The copulating couples used in this study were gathered during the month April 5 to May 5, 1917. All the specimens were taken in Fairyland Creek, a broad, shallow, tidal stream bordered by mangroves, near the laboratory of the Bermuda Biological Station. Collecting was purposely restricted to this one locality. The nudibranchs are very plentiful there, at certain times. *Chromodoris* copulates at all hours of the day, but it seems that a somewhat larger number of pairs are obtained here during the three or four hours after sunrise, and again in the late afternoon, than during the middle of the day. The state of the tide has, in some places, a secondary influence upon the occurrence of mating, the creek being so shallow that in certain spots the bottom is exposed to the air at low water; the free movement of the nudibranchs is thus restricted, and they are forced to lie hidden under the thick masses of *Zostera*, *Halimeda*, *Laurentia*, and associated plants which cover the greater portion of the muddy bed of the creek. When they are free to move about, their positive phototropism² assists in causing them to appear freely upon brightly illuminated areas, where their conspicuous coloration renders them easily visible.

As each pair was secured it was deposited in a separate aquarium jar, the different pairs being carefully kept distinct until the dimensions of the animals had been ascertained, after the return to the laboratory. Non-mating animals, found creeping alone over the bottom, were frequently collected at the same time; these individuals furnished a basis upon which to compare the size of conjugants with that of non-conjugants, and also sup-

² The phototropism of *C. zebra* is not in any sense a "laboratory product," but on the contrary a very real element in its behavior under conditions of freedom in nature. Some account of the natural movements and behavior of *C. zebra* will be given in another place.

plied a part of the material for mating experiments. Each time that a collection was made it was attempted to secure all the mating pairs present within the area considered, no selection being exercised other than that involved in deciding whether or not a given couple was actually engaged in copulation; as a rule no difficulty was experienced upon this point. The correlation tables (vide infra) include data on all the pairs found during the interval April 5–May 5, with the exception of three pairs necessarily rejected because one or both members were, owing to injury (as subsequently explained), unfit for measurement.

The animals were measured on the same day as that on which they were collected, and usually within a few hours after their removal from the sea. This was thought necessary since certain dimensions might have been altered if the nudibranchs had been allowed time in which to deposit their large egg masses. When, in the process of collection, a copulating couple is disturbed, one or both of the individuals, without subsequent conjugation, may within the next twenty-four hours deposit a large or a small (abnormal) egg mass.

III MEASUREMENTS

The body of a *Chromodoris zebra* is soft, contractile, within certain limits easily changed in shape, and without any hard supporting skeleton. The accurate estimation of its dimensions therefore presents a certain amount of difficulty. It was not practicable to get consistent results by the measurement of length while the animal was creeping freely over a smooth horizontal surface. By removing the specimen from the water, however, and placing it, dorsal surface downward, upon a horizontal plate of smooth glass freshly wetted with seawater,³ it was possible to get length measurements which could be duplicated in successive trials to within 0.3₅ cm. Since the mean

³ On a dry surface, or upon a glass plate wetted with seawater which has been allowed to evaporate somewhat, the nudibranchs were stimulated to restless contortions. When treated in the manner above outlined they become extended to their maximal length and remain so, quietly, for several minutes, during which the length of the body can be measured with fair precision.

length of the nudibranchs was 11–12 cms., with a range of 4–18 cms., these measurements were of sufficient refinement for statistical purposes. The measurements were always made in duplicate.

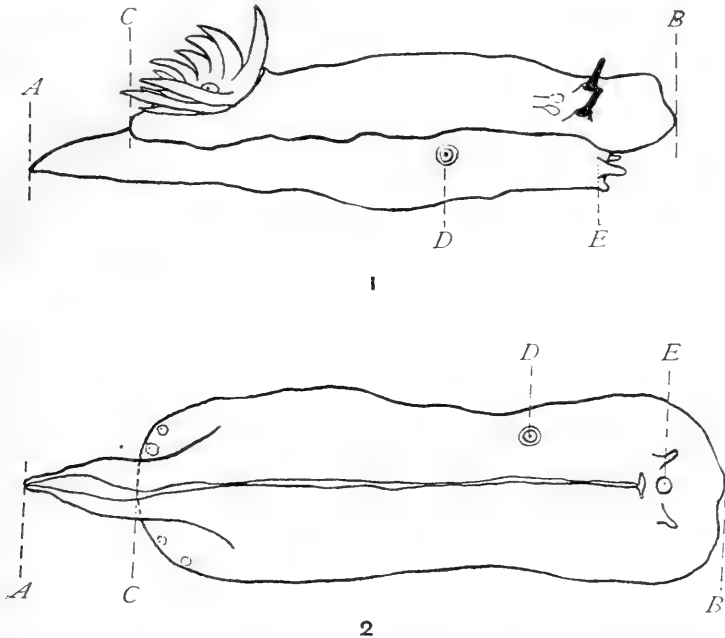

Fig. 1 *Chromodoris zebra*, seen from the right side and above, showing dimensions measured. *A-B*, total length; *C-B*, mantle length; *D-E*, distance of genital papilla from the mouth. The animal is shown as it appears when creeping upon a horizontal surface.

Fig. 2 *Chromodoris zebra*. The animal is shown as it appears when placed dorsal surface downward upon a glass plate which is moistened with seawater. The characteristic reaction in which the lateral margins of the foot are closely approximated when the organ is not applied to a flat surface should be noted. Lettering as in Fig. 1. (See text.)

The dimensions considered will be understood by reference to figures 1 and 2. They include:

- 1) the *total length*, from the anterior edge of the buccal veil to the posterior termination of the foot;
- 2) the *mantle length*, from the anterior margin of the buccal veil to the posterior edge of the caudal veil;

3) the *distance between the genital papilla and the mouth*, measured from the external orifice of the genital atrium (center of the papilla) to the center of the mouth, along a horizontal line parallel to the median plane of the body;

4) the *distance of the genital aperture above the surface of the foot*.

Some of these dimensions were studied in independent series of individuals, not included in the series of mating couples, and for other series of individuals, included among the pairs of copulating nudibranchs, the weight and the volume were ascertained for each individual. The weights were obtained with a platform balance accurate to 0.1 gm., the nudibranchs being dried and deprived of superficial slime by rolling them gently in a towel before weighing. Volumes were ascertained by the displacement of sea water in a narrow graduated cylinder, the animals being given a preliminary drying as in finding the weight; successive determinations of the volume of the same animal agreed to within 1-2 cc.

It was not possible to carry out all of these measurements upon each individual, owing to lack of time. My first object being merely to ascertain whether or not assortive mating occurs in *Chromodoris*, and if so, to measure its intensity, it was considered that the measurements made were sufficient for this purpose.

A word of explanation is required concerning the choice of points between which measurements were made, particularly with reference to the estimation of total length (*A-B*, fig. 2), upon which the chief reliance is placed. Under ideal conditions it would probably be preferable to employ the mantle length as defined above. The projecting 'tail' of the foot is contractile, and its length when at rest may vary in a way not closely correlated with the length of the individual. But with a number of specimens it was not permissible to employ the mantle length, because the animals had suffered a very curious type of natural injury.

In a preliminary paper concerned with the question of "warning" coloration in *C. zebra* (Crozier, '16 b), I stated that the

only type of structural injury shown by specimens of this species as obtained in the field amounted to a slight, and relatively infrequent, damage to the projecting margin of the mantle. This statement was correct so far as concerns the several thousand specimens which had passed through my hands in the preceding two years. In 1917, however, collecting over the same territory as in previous years and particularly in Fairyland Creek, a considerable number of individuals were obtained in which a piece, of varying size, had obviously been bitten from the middle of the dorsal surface.⁴ As many as 20-50 per cent of the specimens collected at one time would be found so injured. Animals thus afflicted were seen to engage in normal copulation (with uninjured or with damaged partners, in equal frequency), and in the

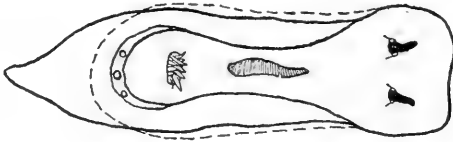

Fig. 3 Showing the type of injury found inflicted upon *C. zebra* in nature, and its effect in producing puckering and a shortening of the "mantle length;" a somewhat extreme case, dorsal view. The corresponding outline of an undamaged specimen is indicated approximately by dashes.

great majority of instances they already showed signs of regenerative activity appropriate to the ultimate repair of the injury. They were found to deposit good egg-masses. In all these cases there was present a greater or less degree of puckering on the dorsal surface (fig. 3), which caused the actual "mantle length" (*B-C*, figs. 1, 2) to be shorter than that of uninjured specimens of about the same general size. This was especially true when the wounded dorsal parts were stimulated by contact with the glass plate during measurement. The amount of tissue lost as the result of injury was rarely considerable, and the *total length* (*A-B*, figs. 1, 2) of the damaged nudibranchs seemed not to be seriously influenced. Since it was desirable to include *all* the mating

⁴ The nature, distribution, frequency, and significance of these injuries will be discussed in another place.

couples obtained, the 'total length' measurement was mainly used.

The length of a *Chromodoris* as measured in the way described is somewhat greater than that obtained from the quietly creeping specimen. The body is of but little greater density than sea water (1.062–1.072 gms./ccm., as compared with 1.0265), but is so soft that when adjusted upon the measuring plate its weight is sufficient to noticeably flatten the animal. The distortion induced in this way is probably greater, proportionally, in the case of large individuals, weighing up to 75 gms., than in the smaller specimens, which weighed 10–15 gms. The flattening of the body through the pressure of its own mass, under the conditions imposed during the measurement, helps to obscure the smoothness of the expected theoretical relation between *length* and *volume* (fig. 4). It should also be remarked that the nudibranchs may tend to elongate somewhat, by muscular contractions, as a preliminary to righting movements. The volume and weight of a *Chromodoris* may also vary independently of the length, owing to the influence of such factors as: 1) the number of egg masses which have been deposited, and 2) the amount of water contained in the intramuscular spaces of the foot and body-wall. Nevertheless, the qualitative agreement between the indices of correlation in mating calculated from the several kinds of measurements taken shows that the estimations of 'total length' as here carried out are adequate for the determination of assortive mating with respect to size. The characteristic reaction of the foot when removed from contact with a flat substratum, namely the rolling up into close approximation of its lateral borders in the median plane (fig. 2), helped to insure a uniform attitude among the various individuals during measurement.

IV ASSORTIVE MATING IN NATURE

1. *Total length*. No significant difference was observed between the size of the nudibranchs obtained as members of conjugating couples and those taken singly, either in the collections of any one day (illustrated by the data in figures 5 and 6), or

in the total population examined. Laboratory observation proved that specimens of any length between 4 and 18 cms. would copulate successfully with appropriate mates, and deposit eggs; hence it is probable that all the animals seen in the

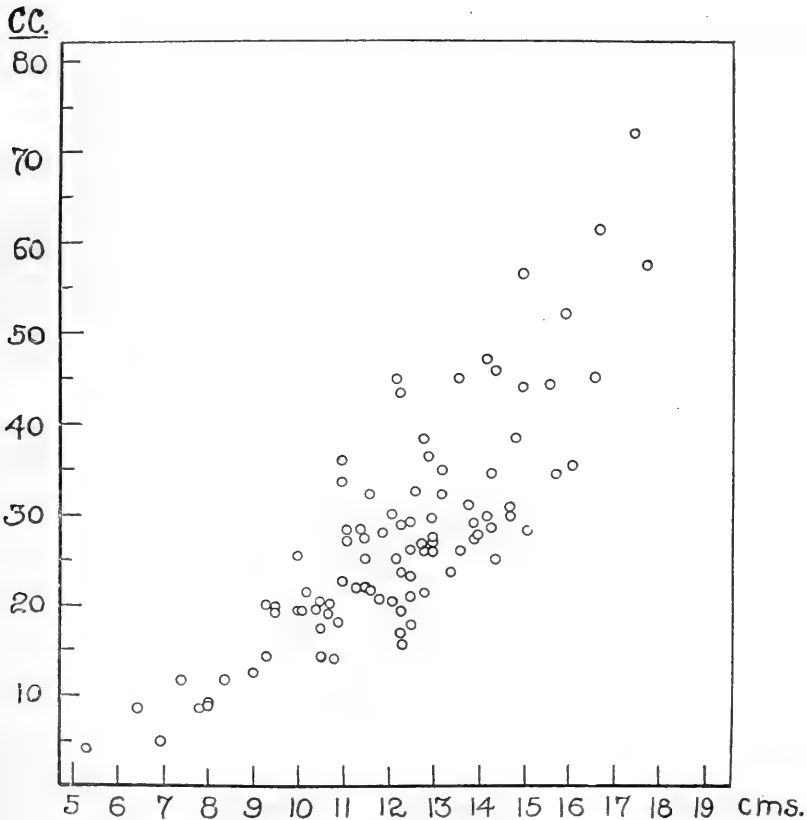
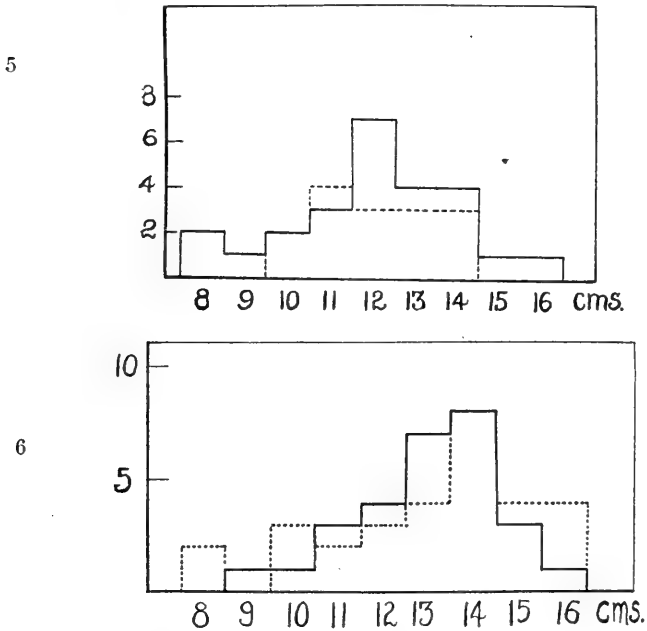

Fig. 4 Showing the irregular distribution of the volumes of 95 specimens of *Chromodoris zebra* in relation to the "total length." Animals measured immediately after being taken from the sea.

field were (or had recently been) physiologically primed for conjugation, and that chance, in combination with the normal rapidity of repeated pairing for animals of different sizes, as related to the size-frequency distribution, determined the number and kind of pairs obtained in the various collections. It

should be noted, further, that there is no detectable tendency for individuals of any given size to copulate at a different time of day, or season, from those of any other size.

One hundred and forty-eight pairs gathered in Fairyland Creek were composed of individuals giving the length-frequency distribution exhibited in figure 7. The relation between the



Figs. 5 and 6 The frequency distribution of sizes (total lengths) for mating and non-mating individuals in two random collections (Apr. 24th and Apr. 30th, respectively); the continuous line denotes mating individuals, the dotted line non-mating individuals. Showing that there was no significant difference between the sizes of mating and of non-mating specimens.

lengths of the two individuals constituting a pair is set forth in table 1. This is a single-entry correlation table, constructed and used in accord with the manner suggested by Jennings ('11 a, '11 b) for cases of this kind. The coefficient of correlation is found to be

$$r = 0.608 \pm 0.024_7$$

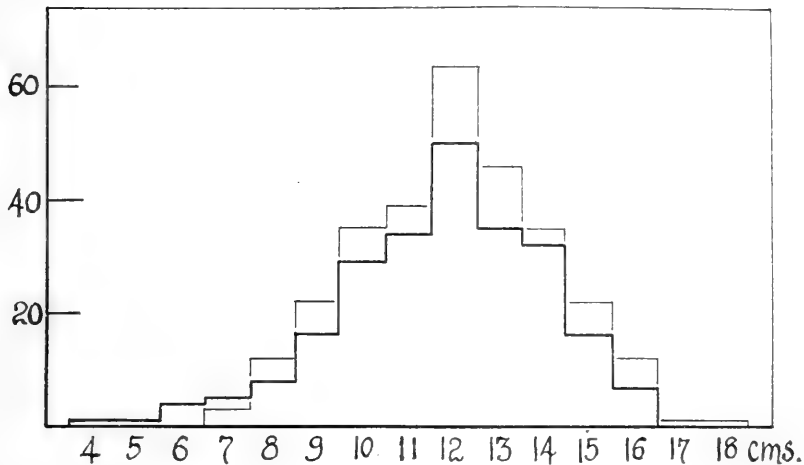

Fig. 7 The lighter line shows the frequency distribution of total-lengths for the constituents of pairs of *Chromodoris zebra* obtained in the field (148 pairs, 296 individuals); the heavier line shows the same for pairs formed in laboratory experiments (119 pairs, 238 individuals).

TABLE 1

Correlation table for the lengths of 148 pairs of *Chromodoris zebra* found under natural conditions. The larger member of a pair is entered in the vertical columns, the smaller in the horizontal rows. The unit of measurement is 1 cm. The index of correlation is $r = 0.608 \pm 0.024$.

	8	9	10	11	12	13	14	15	16	17	18	
7	2		1									3
8	2	3	1		1		1					8
9		2	2	4	4	3	2					17
10			6	6	4	6	1	2				25
11				7	9	2	2	1	1			22
12					10	9	10	4	3			36
13						4	11	4	1	1	1	22
14							3	4	2			9
15								2	3			5
16									1			1
	4	5	10	17	28	24	30	17	11	1	1	148

The degree of correlation between the sizes of individuals mating together is further shown graphically in a regression plot (fig. 8). The two components of a copulating pair are usually not of identical size. The value of the index of correlation signifies, however, that as a rule large individuals mate with

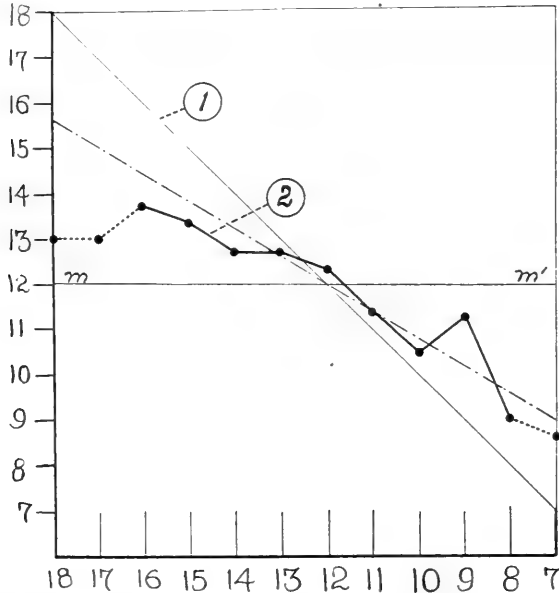

Fig. 8 Showing the relation between the length of specimens of *C. zebra* (abscissas) and the average lengths of their mates (ordinates), for 148 pairs. If there were no correlation between the lengths of components of mating pairs the observed points, [2], would fall upon the line $m-m'$ (= the general mean); if assortive mating were perfect, the line [2] would coincide with [1]. The smoothed line of regression is shown by the dot-and-dash line; in this and succeeding plots it is assumed that the regression is linear throughout. This is possibly not quite correct, but does not affect the special conclusion drawn from these data, namely that large individuals mate together. The class unit is 1 cm. The index of correlation is $r = 0.608$.

large, small individuals with small. For each 1.0 cm. difference in the total lengths of two specimens of *C. zebra* there will, on the average, be found a difference, corresponding in sign, of about 0.6 cm. between the lengths of the partners during their conjugation under natural circumstances.

TABLE 2

Correlation table for the mantle-length of 89 pairs of *C. zebra*. The larger member of a pair is entered in the vertical columns, the smaller in the horizontal rows. The class unit is 1 cm. The index of correlation is $r = 0.518 \pm 0.052_{37}$.

	7	8	9	10	11	12	13	14	15	16	
6	1										1
7	1			1							2
8		1	1	5	5	1					13
9			4	4	3	3	1				15
10				6	8	2	3				19
11					8	13	5				26
12						6	2			1	9
13							2	1			3
14								1			1
	2	1	5	16	24	25	13	2	0	1	89

2. *Other measurements.* The degree of homogamy shown by the measurements of other characters may be briefly considered.

A. A series of mating pairs, comprising 89 normal uninjured couples obtained successively in the field, whereof the mantle-length was determined for each specimen, gave data summarized in table 2. A small, homogeneous series was used, consisting of a set of animals collected at one time and measured with particular reference to the mantle-length, rather than a larger series selected from among the general field collections. Such a selection would otherwise have been necessary, owing to the relatively frequent occurrence, at this time, of injuries upon the dorsal surface of *Chromodoris*. As previously stated, these injuries, in addition to making the nudibranchs difficult to measure, resulted in the distortion of the "mantle length" through puckering about the wound.

The coefficient of correlation calculated from table 2 is

$$r = 0.518 \pm 0.052_3$$

The result is in sufficiently good agreement with that obtained from the measurements of 'total length' ($r = 0.608$). The corresponding regression plot is given in figure 9. The number of pairs (89) involved in the tabulation of mantle lengths is smaller

than that measured for the total length (148). For the same group the correlation based upon total length estimations is $r = 0.492$ (table 3). This agreement (fig. 10) is sufficient to show that the method of measuring 'total length,' as previously described, is free from serious objection so far as the variable length of the 'tail' of the foot is concerned. Even with small

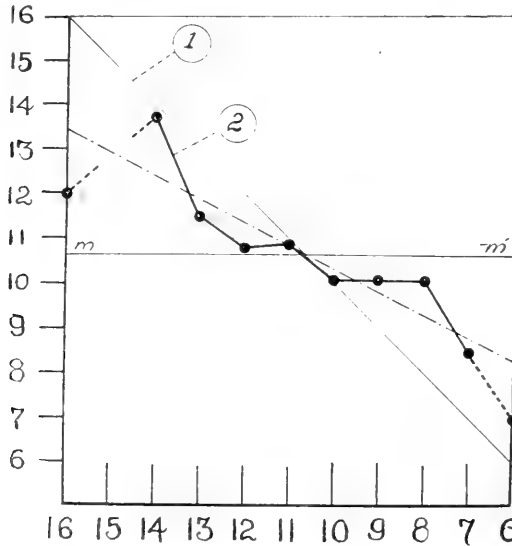

Fig. 9 Showing the relation between the "mantle-length" of specimens of *C. zebra* (abscissas) and the average length of their mates (ordinates), for 89 pairs; (1) is the line upon which the observed points, (2), would fall if no correlation were involved; $m-m'$ is the mean for all. The smoothed regression line is shown thus $\cdots\cdots\cdots$. The class unit is 1 cm.; $r = 0.518$.

numbers of this sort the correlation is entirely too high to be explained as the result of assortive mating.

B. In one small series of 66 pairs the volume of the animals was measured. The frequency distribution of volumes is shown in figure 12. The correlation index for these pairs, on a volume basis, is low ($r = 0.1353$), as shown in table 4, and the distribution of the measurements is very irregular (fig. 13). This series is not extensive, yet the result of its examination has some value. The volume of a *Chromodoris* may in part de-

TABLE 3

Correlation table for the "total lengths" of the 89 pairs of *C. zebra* whose "mantle-length" correlation is given in table 2 (see fig. 10), $r = 0.492$.

	8	9	10	11	12	13	14	15	16	17	18	
8	2											2
9		1										13
10			2									15
11			5	2								13
12				4	4							16
13				3	6	2						20
14					5	4	4					7
15						6	9	3			1	2
16							4	2	1			1
16								1	1			1
16									1			1
	2	1	7	9	16	17	20	11	5		1	89

TABLE 4

Correlation between the volumes of members of 66 pairs of *C. zebra*; $r = 0.1353$

	10	15	20	25	30	35	40	45	50	55	
10	2	3									5
15		2	6	2	2			1			13
20			6	8	4	1		2			21
25				2	8	1	2	1		1	15
30					4	4					8
35							1	3			3
40							1				1
	2	5	12	12	18	6	4	6	0	1	66

pend upon the condition of the gonad and associated reproductive glands; perhaps in some additional manner the volume of an individual may be a function of the number of egg masses which the nudibranch has recently deposited. If this interpretation be correct, it follows that length (and correlated external dimensions), rather than reproductive condition (provided the animals in question be still capable of being stimulated to copulate), is the basis of selection in pairing. This would explain the low correlation for homogamy in the volume series of measurements (although the small number of cases may be responsible), and would be intelligible in view of the irregular relation between volume

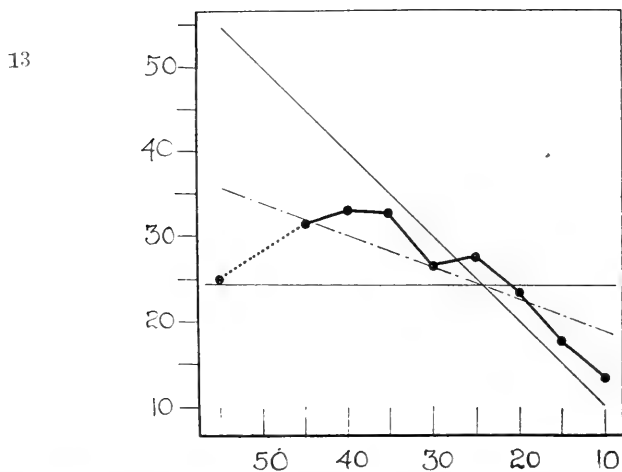
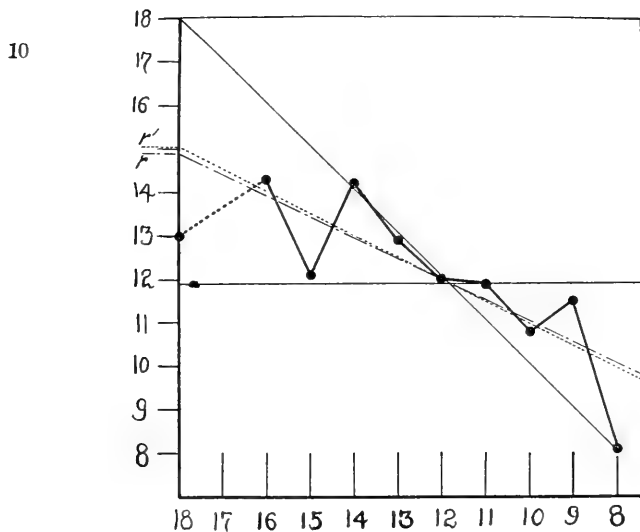
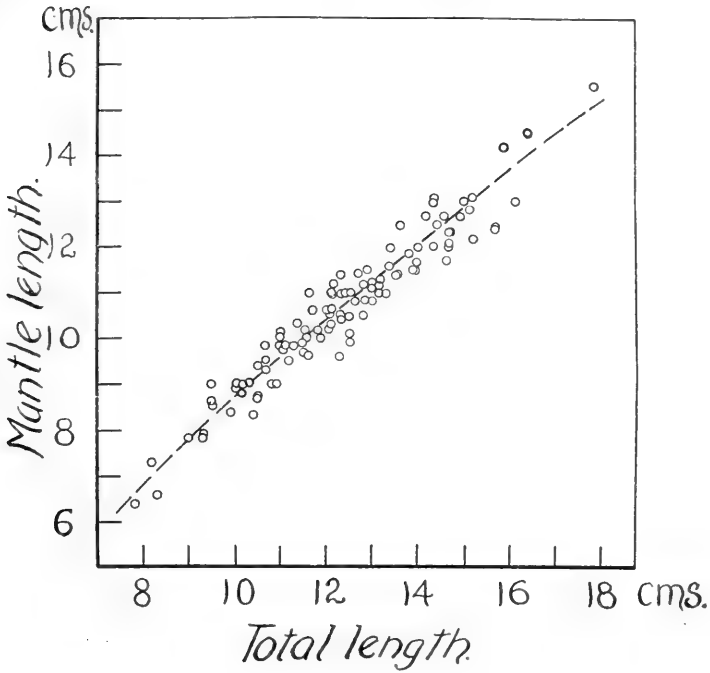
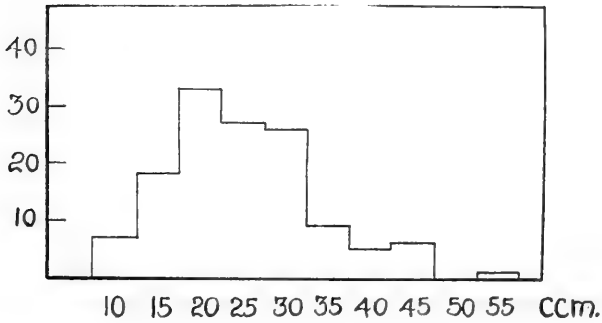

Fig. 10 Regression plot for data in Table III; r' = regression line as calculated from "mantle-length;" r , same as calculated from "total-length" measurements for the same 89 pairs. (See text.)

Fig. 13 Regression plot for correlation in volume between members of 66 mating pairs (see Table IV). The regression is probably not strictly linear (cf. Fig. 8). The unit of classification is 5 cm.



11



12

Fig. 11 Showing the relation between "total length" and "mantle length" in 103 uninjured specimens of *C. zebra* (cf. Fig. 2). The relation is almost, if not quite exactly, linear.

Fig. 12 Frequency distribution of the volumes of specimens of *C. zebra*. The class unit is 5 cm.

and length (fig. 4), and between weight and length (fig. 14). This point of view is supported by the results of mating experiments with starved animals, tests which are discussed in a subsequent section.

C. The distance of the genital papilla from the anterior end of the animal (mouth), and its height above the ventral surface of the foot, were also measured in a number of specimens. These

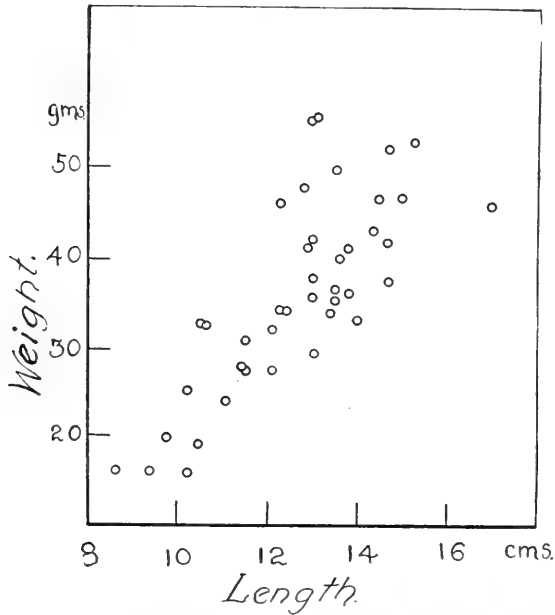

Fig. 14 Showing the irregular relation between length and weight in freshly collected individuals, which cannot be due to irregularities in the weight of the stomach contents.

figures are neither numerous enough nor sufficiently homogeneous to enable cross-correlation indices to be calculated; moreover, such calculations would be unnecessary for present purposes. The data obtained in this connection are detailed on a subsequent page; they are intended to give an idea of the topographical position of the genital papilla in nudibranchs of different sizes. The important point is that the genital papilla

is situated in almost precisely the same relative position in individuals of all sizes, its distance from the mouth and from the surface of the foot being each proportional to the length of the animal.

V MATINGS IN MASS EXPERIMENTS

1. *Method and findings.* Approximately four hundred specimens, freshly collected, were allowed to mate together in laboratory aquaria. The experiments were made during the time covered by the collection of the field data. About half of the animals involved had originally been obtained as members of copulating pairs, the other half being collected as single, non-mating individuals. Forty to fifty animals, taken at random but including in every instance a fair representation of the different sizes of specimens, were put into each of a number of nine-gallon aquaria. The 'crowding together' brought about in this way was intentional. The nudibranchs mate with sufficient frequency, at this time of year (April), so that the pairs observed under these conditions did not involve merely the originally non-mating individuals.

The aquaria were supplied with running seawater, as the nudibranchs will neither copulate nor deposit eggs in still water. The water of the laboratory supply-system was less alkaline than the "outside" sea water, but the chromodorids lived in it for many months. The water inlet was so arranged as to be in about the center of the aquarium, and midway from top to bottom. This precaution was important, as when the incoming water was allowed to form a current starting at the wall of the aquarium a considerable number of the individuals became massed about the inlet. Copulating pairs would under these conditions have been difficult to distinguish with certainty; with the arrangement here specified, localized crowding was largely avoided, and it was easy to be sure that a given pair was actually engaged in conjugation.

There is a very pronounced tendency toward the occurrence of epidemics of pairing. Many conjugating couples occur at about the same time in any one aquarium. This is advan-

tageous, as a large number of couples were in this way obtainable at the same time. It is also important as pointing to the possible existence of specific secretions which may induce pairing.

Twenty-four to forty-eight hours after the nudibranchs had been put into an aquarium, the mating-pairs noted were removed, placed separately in small dishes, and as soon as possible submitted to measurement. In this way data were secured

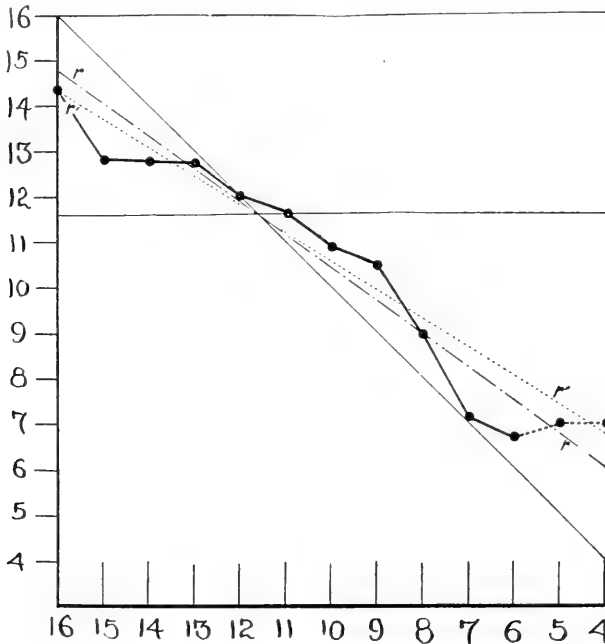

Fig. 15 Regression plot (r , r') for data in Table V; r' , r' , regression line obtained from pairs collected in nature (Fig. 8).

regarding the lengths of the constituents of 119 pairs (cf. fig. 7). These figures are arranged in table 5, and in a regression plot (fig. 15). The index of correlation for the total lengths of the components of mating couples is here $r = 0.721 \pm 0.023$.

2. *Comparison with normal conditions.* The degree of homogeneity exhibited in this series of laboratory matings is appreciably higher than that found for the pairs collected in the field (fig. 15). This may be the outcome of chance variation incident to

TABLE 5

Correlation table for total lengths of 119 pairs of *C. zebra* obtained in laboratory matings (mass experiments); $r = 0.721 \pm 0.023$ (cf. Fig. 15)

	6	7	8	9	10	11	12	13	14	15	16	
4		1										1
5		1										1
6	1	1	1									3
7				1			1					2
8			1	2	2		1					6
9				2	2		4	1	2			11
10					5	6	3	3	2	1		20
11						5	12	2	3	1		23
12							5	5	7	6	1	24
13								7	7	2	1	17
14									2	5	2	9
15											1	1
16											1	1
	1	3	2	5	9	11	26	18	23	15	6	119

the restricted number of matings available for study. Several other influences may also be concerned. In the aquaria the nudibranchs creep over a smooth substratum, and there is less opportunity than in nature for discrepancy in the sizes of two specimens to be discounted by the unevenness of the bottom upon which they might be resting. From this point of view the irregular substratum presented by masses of algae, rocks, and sand would be regarded as favoring the apposition of the genital papillae in the case of two animals differing somewhat as to size. The efficiency of this influence cannot be very great, however; its exact value I am unable to estimate. It is, in addition, entirely possible that some 'pairs' collected in the field were in reality misjudged, in which event the index of regression obtained from the mass experiments would perhaps more nearly represent the true state of affairs.

The significant point, however, lies in the fact that the laboratory matings confirm the qualitative correctness of the conclusion that there is practiced by *Chromodoris zebra* a rather intensive degree of homogamy with respect to size (Crozier,

'17 c). Given the conditions imposed upon the nudibranchs in the experiments just described, it is legitimate to conceive that here, if ever, the animals would have conjugated according to the chance dictates of random contact. The magnitude of the correlation index makes untenable the idea of random pairing; moreover, close study of the behavior of *C. zebra* in copulation fully substantiates the proposition that true selective conjugation does indeed occur.

VI THE BASIS OF HOMOGAMY

1. *Homogamy in Paramecium and in man.* In human marriages there occurs, according to Pearson (Pearson and Lee, '03) and others, an appreciable degree of positive correlation between the two members of a mating pair as regards their stature and certain other characters. The evidence available with reference to this matter has been reviewed in an interesting essay by Harris ('12 a). The cause of assortive mating in man is in most cases far from obvious; its significance, its consequences, cannot be followed in detail.

For *Paramecium* the case is clearer. It was proved by Pearl ('07) that in *Paramecium* there exists a rather high degree of correlation between the lengths of the components of conjugating pairs. Pearl held this correlation to be the result of assortive mating, and he was inclined to accept as its explanation a relatively simple mechanical condition concerned with the manner in which two conjugants become adjusted to each other in a successful mating. According to Pearl, if two individuals, in the proper physiological condition for conjugation, are by a chance mutual approach induced to draw together, "their oral surfaces adhere in whole or in part. The extreme anterior ends of the oral grooves firmly adhere to one another first. If the two individuals are so nearly the same size that the mouths approximately coincide when the anterior ends are together, firm union occurs at the mouth regions and definite conjugation follows" (Pearl, '07, p. 267). If the two individuals do not 'fit,' they separate, or die. "The homogamic correlations arise, then, as a result of the necessity for the mouths of the two individuals

to come together (or 'fit') when the extreme anterior ends are united." This explanation was not based upon personal observation, and later work has shown it to be somewhat too schematic, although entirely correct in principle.

Jennings ('11 b) substantiated Pearl's discovery of assortive mating in *Paramecium*, and was able to make certain the conclusion that the observed correlation between the lengths of conjugating individuals is indeed largely due to true homogamy, rather than to any process of mutual equalization of sizes during the progress of conjugation. Jennings is also in essential agreement with Pearl regarding the mechanical cause of assortive mating. On the basis of direct observation of the mating process, Jennings showed that in a general way the explanation offered by Pearl, as previously quoted, is quite sound. However, in many cases conjugants of unequal length are able to pair successfully through a series of bending movements and contractions which cause their lengths to become more or less equalized. This influence is, nevertheless, found inadequate to account for more than a small part of the correlation. It remains true that two individuals conjugate most readily when they are of nearly the same size. This is the automatic outcome of the manner in which the conjugation-postures of *Paramecium* are brought about, and of the fact that the total length of *Paramecium* (and any other dimension which may be used as an index of size) is rather closely correlated with the distance from the anterior end to the mouth. Upon the equality of the latter character in two individuals the possibility of their successful conjugation is in large measure mechanically dependent.

It does not appear that the pairing of animals, other than *Paramecium*, several other infusorians (Jennings, '11 b, p. 85-88), and man, has ever been examined with reference to the possible occurrence of assortive mating. Yet it is generally recognized that this matter of homogamy is one of great importance. In addition to its implications for other phases of evolutionary speculation, assortive mating (where it can be shown to occur) may provide in particular an interesting example of a mechanically determined result having the superficial characteristics of a

'purposeful adaptation.' This phase of the matter does not seem to have received sufficient emphasis, although the scanty observations available with reference to selective pairing contain little evidence that such a process might be directly "beneficial" to a species. The case of *Chromodoris zebra* affords an instance among metazoans which is exceptionally favorable for study. It becomes, then, of special interest to discover, if possible, the basis, or method, of the assortive mating practiced by this nudibranch.

2. *Mating behavior of nudibranchs.* Assortive mating with regard to size would be expected to occur only where there is available some physical basis for the process of mutual selection ('fitting') which is necessarily involved. According to Orton (1914 a), the sea urchin *Echinus miliaris*, in its breeding season, "has the habit of associating together in pairs;" the association is often close, and in many instances the pairs found together contain one individual of either sex. I have noticed instances of this sort in *Lytechinus variegatus*, and several good examples of the same nature have been observed by me with *Tripneustes esculentus*. These cases have not yet been examined for the occurrence of assortive pairing. In passing, it may be remarked that if this type of "conjugation" is indeed at all general among echinoids, it is apparently not sufficiently specific altogether to prevent hybridization in nature (Shearer, de Morgan, and Fuchs, '14). A possible basis might readily be conceived upon which might be founded a correlation between the sizes of individuals 'pairing' in this way. Nevertheless it seems probable that invertebrates which reproduce by external fertilization will not, in general, yield evidence of assortive mating with respect to size. Among nudibranchs, however, where a true copulation is a prerequisite for the internal fertilization of the eggs,—as may be demonstrated experimentally, and by the existence in some forms, e.g., *Doto*, of recognizable anatomical arrangements making for the prevention of self fertilization (Dreyer, '12, p. 342),—there is a possibility that the mechanical conditions controlling copulation may determine real homogamy as to size. This is more especially true since, image-forming eyes being absent,

tactile and chemical senses seem the main, if not the only, channels through which the manouvers of conjugation may be controlled and directed.

The mating behavior of certain nudibranchs other than *Chromodoris* throws an interesting light upon this question, although the material available for comparison is very limited. In the littoral nudibranch *Cenia*, as described by Pelseener ('99, p. 518, footnote 2), the three widely separated external genital openings of one member of a mating couple are simultaneously brought into close relation with the appropriate openings of the other individual, the posterior female orifice of each receiving the 'opposite' penis. If it be true that this type of conjugation is necessary in *Cenia* (further observations on the point would be valuable), and if mutual equalization of the sizes of conjugants be inadequate to overcome natural variation in the sizes of reproducing individuals, then in this species there is an obvious mechanical basis upon which assortive mating might be required to operate. There is the difficulty, in the case of *Cenia*, and of other "Elysiens" which I have been able to study, that the conjugating population is of very nearly uniform size, which is decidedly not the case with *Chromodoris*. The important fact, however, which indeed forms the basis of selection in pairing, is the necessity for the reproductive openings to be brought into close contact. In at least one nudibranch (*Cumanotus*) there are present somewhat unusual 'claspings organs,' which help to insure the close approximation of the respective male and female apertures (Crawshay, quoted by Eliot, '08). This is necessary both in cases where the male and female openings are distinctly separated, and in species where they are concentrated upon a relatively small papilla (Montagua, Smallwood, '03; *Chromodoris*), and is of course the condition obtaining in some other gastropods (cf. Meisenheimer, '07). *C. zebra* conjugates after the fashion employed by other members of its family. Two individuals come together with their right sides in contact, and when the central aperture of the genital papilla of one specimen is closely applied to that of its mate, the short conical penis of one is inserted into the aperture of the other and insemination then proceeds.

There is evidently some influence other than chance contact which is at work to bring mating individuals together. Shoreward movements out of deep water at certain periods (Crozier, '17 b), which nevertheless do not appear to be carried out "for" purposes of reproduction, play a part in this process. So do the reactions leading to the concentration of individuals in the mangrove creeks and upon open sandy bottoms. In one particular place it has been clear that water currents have been important in bringing a number of individuals to come near to one another. This spot is along one border of a shallow strip across which there is a water connection between two arms of Fairyland Creek. A row of flat stones is situated along the north edge of this strip, and with the change in the tide a strong current flows over the narrow neck. A number of chromodorids were usually found in pockets hollowed out by the current underneath the stones referred to. This is probably the result of their being "entrapped" there at periods when the current is not strong; they move into the "pockets," or are forcibly carried there, in a somewhat passive fashion, as the animals are not rheotropic. This is the only place where I have found *C. zebra* under stones; it paired in this situation, and deposited eggs. Unlike some other species of this genus, *C. zebra* moves toward the light. This positive phototropism is in itself a factor tending to bring into company a large number of individuals.

It is a noteworthy fact that these nudibranchs are very seldom found to occur singly. If only a very few specimens are discovered in the course of a day's collecting, it is nevertheless usually found that the animals tend to occur in groups, the individuals being relatively near together. When the nudibranchs are actively engaged in breeding, groups of specimens, such as are illustrated in the following records, are not infrequent:—

May 2nd 1917. Groups of *C. zebra* observed in Fairyland Creek. All the individuals in each group were closely packed together, each group being well separated from all the others. The individuals mating together in each group (when copulating couples could be distinguished with certainty) are bracketed together. The measurements are those of 'total length,' in cms.

<i>Group</i>		<i>Group</i>		<i>Group</i>	
1.	12.3	4.	14.4	6.	13.5
	10.8		12.5		10.7
	9.3		13.9		9.3
			15.3		
2.	12.2		11.9	7.	15.7
	12.2		8.9		12.0
	11.6				12.5
	10.6	5.	11.4		
			12.0		
3.	14.2		16.3		
	14.2		14.5		
	11.7				

To what extent 'attractive' secretions may be involved in producing these groupings, I am as yet unable to state. The matter will be studied further, as it is of interest, among other things, to determine why the several species of *Chromodoris* cannot be made to conjugate with one another. *C. zebra* does possess a characteristic and very penetrating odor.

The details of copulations were examined in the laboratory. When two individuals come near together it is frequently to be observed that one of them is stationary, the other moving toward it. This occurs in still (non-circulating) water. When they have come within about 10 cms. of each other, if not before, the genital papillae are frequently protruded. In many instances the protrusion is evidenced by one of the animals earlier, or more strikingly, than by the other; in a number of cases it was noted that the former individual was relatively stationary, the latter moving toward it. Often the animals come together either with their left sides in apposition, or 'head on;' in either event they slowly move about until finally, headed in opposite directions, the surfaces of the right sides are in contact. This operation may require as much as an hour, or longer. The genital papillae become gradually more prominent, and exhibit movements of extension and partial retraction which are more or less rhythmic. Not uncommonly the protrusible pharynx is everted, and the lips are passed over the surface of the other animal. This behavior has also been observed in the field.

When the two individuals are of nearly the same size, they become fitted to one another after the manner sketched in figure 16.

Sometimes conjugation is effected with less trouble, or more speedily, because the specimens are of nearly identical size and are from the first so situated that their right sides are in contact (figs. 17, 18); in other cases difficulty is experienced in bringing the reproductive openings together. Two nudibranchs differing greatly in size are, under ordinary conditions, unable to accomplish this (fig. 19), and, following futile attempts at copulation, will (usually after a short time) wander apart.

The whole character of the animal's behavior in these experiments supports the contention that the nudibranchs are 'attracted' to one another as a result of reactions to specific secretions; the 'epidemics' of conjugation in aquaria, referred to in a previous section, may also be cited in this connection. The consummation of pairing depends upon these specific reactions (including those of the terminal papilla of the genital ducts), and upon the mechanical condition that the papillae may be brought together.

A certain amount of equalization of 'size' does occur, but it is not efficient in promoting copulation between individuals differing several centimeters in length. The openings of the reproductive ducts are situated in the same relative position in specimens of all sizes, the distance from the mouth and height above the surface of the foot (when the animal is quietly creeping) being each directly proportional to the total length of the animal (fig. 20). Contractions of the general body musculature, and movements of the protruded genital papilla, are both involved in the efforts to overcome differences in the sizes of individuals endeavoring to mate; the latter movements are the less important. These nudibranchs can contract to such an extent that the length 'over all' is about 80-85 per cent of its normal extent when not specially contracted; the distance between mouth and genital atrium can be similarly shortened. In the copulation of two specimens of equal size the animals are sometimes contracted to a certain extent, but the usual condition in such a case does not involve noticeable shortening. The principal effect of the shortening is to bring about an elevation of the genital orifice. It may in this way be employed by a smaller

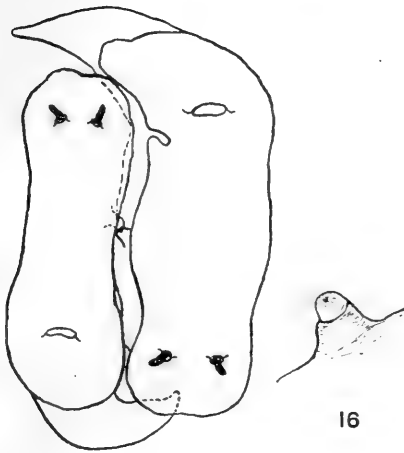

16

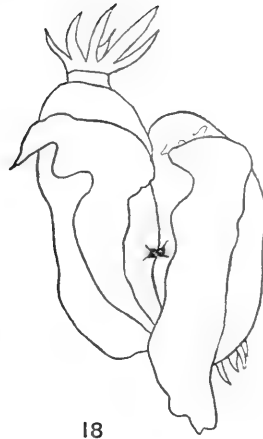

18

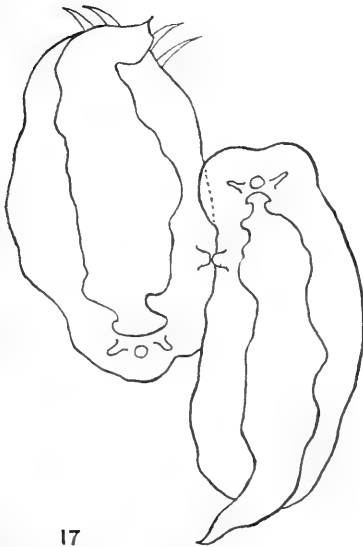

17



19

Fig. 16 Illustrating the attempted conjugation of two specimens of somewhat different size. Outline sketch, dorsal view (gills omitted). $\times \frac{2}{3}$. At the side, sketch showing manner in which the genital papilla is protruded. $\times 1$.

Fig. 17 Illustrating the copulation of two individuals of equal size; seen from the ventral surface, through glass wall of aquarium; as contrasted with the pair shown in Fig. 16. The animals here are somewhat contracted. $\times \frac{2}{3}$.

Fig. 18 A case similar to that in Fig. 17. The anterior end of individual to the left is extended, the lips being passed over the surface of its partner. $\times \frac{2}{3}$.

Fig. 19 Unsuccessful attempt of two individuals of different sizes to engage in conjugation. Relative positions of reproductive apertures indicated by dotted circles (2, that of individual to the left; 1, of that to the right; 2 was about 1 cm. higher than 1). $\times \frac{1}{2}$.

animal endeavoring to mate with a large one, but such attempts are not as a rule successful. In special situations this process of 'equalization' of sizes may be effective, but it is not of primary importance.

Nor, as a rule, are the movements of the elevated genital papilla effective in 'equalizing' the size of two nudibranchs. During the close approach of two specimens which are attempting to copulate their papillae are considerably protruded. In the center of each papilla is the opening which communicates with

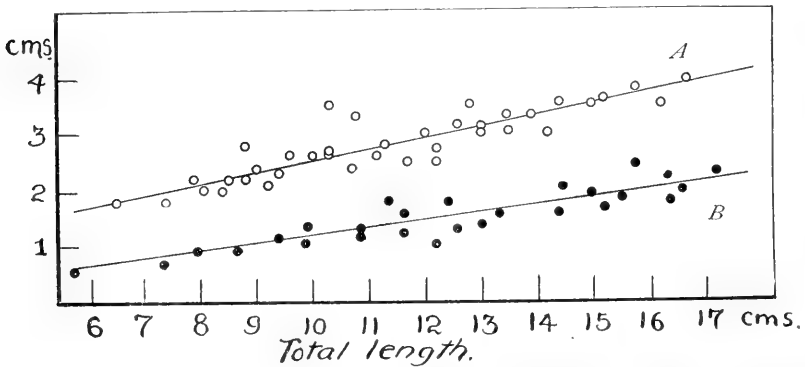

Fig. 20 Showing the relation (A) between total length and distance of genital papilla from mouth; and (B) between total length and height of the papilla above ventral surface of the foot, in creeping.

the sperm-receptacle and seminal duct. The surface of the papilla apparently corresponds to the inner surface of the 'genital atrium' of Smallwood and Clark ('12), who give a diagrammatic figure of the reproductive apparatus in this species. As the two papillae are brought nearer and nearer together, they become still further enlarged, and when their tips come into contact the movements of the animals as a whole cease. A slow pulsatile motion of extension and retraction is now evidenced by each papilla, the movements being reciprocal and the two papillae remaining closely pressed together. If two individuals in this condition are separated by a slight displacement of one of them with a glass rod, the genital papillae become widely protruded, and are usually quickly successful in returning to their

former position when the rod is withdrawn. If one individual of a pair be slowly moved away from its mate, the papilla of the untouched nudibranch endeavors to follow its partner in its enforced retreat. The termination of the preparatory manoeuvres comes when the penis of one *Chromodoris* is inserted into the central opening of the papilla of its mate. The reproductive apertures are in this case pressed together by muscular contractions, and not held in place, as in some other nudibranchs, either by copulatory clasping organs (*Cumanotus*; Eliot, '08), or by a thickened mucous secretion (*Montagua*; Smallwood, '03). The penis is unarmed.

I have made attempts, but without success as yet, to determine whether or not that individual of a pair which has been most active in conjugation (the moving member of the typical pair previously described) is in every case, or in most cases, the first to engage in insemination. If the pair be undisturbed, mutual insemination frequently occurs, and I believe it to be usually the case here, as in other large nudibranchs.

Finally, some examples may be cited which serve to illustrate the efficiency of the process of mutual selection with respect to size. Where the difference in the length of two specimens amounted to 5 or 6 cms., the 'trial and rejection' (to use a convenient but misleading phrase) occupied but a few minutes. The observations here given are typical of many others which were collected.

Expt. 10.42. April 18, 1917. *Chromodorids* maintained in the laboratory three and one-half months, without food. Their sizes had decreased to such an extent that most of the specimens were one-half to two-thirds their original length. The following pairs were observed to be in copulation at one time, there being in all 13 specimens of different sizes in the one aquarium.

PAIR	LENGTH	
	<i>cms.</i>	<i>cms.</i>
1	6.3	6.5
2	6.1	5.7
3	7.9	10.2
4	8.9	9.8
5	9.2	10.0

Expt. 10.57. April 24. In an aquarium containing 18 freshly collected chromodorids, a specimen 13.5 cms. long was seen to be unsuccessful in attempting to copulate with another 8.7 cms. in length; 15 min. later it 'refused' a second one, 9.5 cms. long. After 30 min. it mated successfully with an individual which measured 12.2 cms.

Expts. 10.61-10.64. In each of the following cases the animals whose lengths are tabulated together were placed in a single aquarium. The individuals which conjugated are enclosed in brackets.

		EXPERIMENT				
		a	b	c	d	e
		cms.	cms.	cms.	cms.	cms.
Lengths.....	}	15.0	17.0	11.4	13.9	14.0
		12.0	12.0	9.5	13.8	13.0
		12.5	11.0	9.3	12.6	12.5
						12.6
					10.3	

Expt. 10.93.1. May 18. Five *C. zebra* were placed in a 9-gallon aquarium supplied with running water. Their lengths were respectively

ANIMAL				
a	b	c	d	e
cms.	cms.	cms.	cms.	cms.
5.8	7.0	13.5	15.0	16.1

These individuals were all collected on May 18, but in different places, (a) and (c) being obtained in Millbrook Creek, the rest in Fairyland Creek. They were 'ear-marked,' so as to be separately recognizable, by having a small piece clipped from different parts of the mantle; this injury caused the nudibranchs no inconvenience.

After two hours, a was observed unsuccessfully attempting to copulate with e, and b with c. On May 19, there were found pairing together a with b and c with d. The animals were isolated, and b and d subsequently laid egg masses.

VII ON THE CONSEQUENCE OF HOMOGAMY

This paper is concerned primarily with the demonstration of the fact of assortive-mating in *Chromodoris*. It may nevertheless be well to consider some of the possible results of homogamy in this nudibranch, although several of the matters con-

cerned in this discussion are in need of more complete treatment; the evidence required for such treatment I hope to obtain in the near future. On some points the evidence already secured is, I believe, sufficiently clear.

When two specimens of *C. zebra* have successfully copulated they after a time wander apart and usually proceed each to deposit an egg mass. This does not invariably occur, since sometimes only one member of a couple will lay eggs, but it is by far the more usual condition. There is here no evidence of functional protandric hermaphroditism, as claimed by Orton ('14 b, p. 324) for some small nudibranchs (*Galvina*); indeed, it would seem improbable that protandry could coexist with assortive mating, whatever be the relative rates at which the eggs and sperm are originally matured. Active sperm was found in the vas deferens of animals which contained well developed eggs, as well as in some which had just deposited egg masses after conjugation, including certain small specimens (5 cms. long), as well as some of average length, and some very large ones (18 cms. long).

During the copulation of *Chromodoris* the exchange of sperm is not simultaneous, but one individual first acts as a male, then the other; so that if two conjugating specimens be artificially separated after they have been united for a short time, it is frequently to be observed that sperm is flowing from the short penis of one nudibranch, which had been inserted into the vaginal orifice of the other. When conjugating specimens are segregated in separate aquaria, it is found that in many instances one nudibranch will deposit eggs, the other not; while in still other cases both animals will deposit egg ribbons, although one of these may be very imperfect and contain but a few fertilized eggs. From such observations I draw the conclusion, that as a rule mutual fertilization takes place during the conjugation of *Chromodoris*. This conclusion rests further upon the continued observation of animals which had conjugated in aquaria and had subsequently wandered apart without being in any way disturbed; in most instances two egg masses were the result of such matings.

It is true, however, that a number of instances have been watched in detail where the animals after conjugation separated in the absence of outside intervention, yet only one of them deposited eggs. In these instances the same two nudibranchs, when placed together in a separate aquarium, were found to pair together again within the next day or two, the result being that the other specimen deposited an egg ribbon.

These observations receive additional support from the field collections. It is not uncommon to find two *Chromodoris* and two nearby egg masses in the contents of a single dredge haul. Moreover, in the one situation (described on a previous page) where *C. zebra* has been found in 'pockets' under the cover of stones, I was able to convince myself at different times that the number of freshly attached egg ribbons noted in these places corresponded to the number of animals present.

Hence it is, I believe, safe to employ the idea that, broadly speaking, reciprocal fertilization occurs in these nudibranchs; if this is not true at each particular act of conjugation, at least it can be held that animals of nearly the same size fertilize each other, and that each animal deposits eggs.

1. *Number of larvae produced.* The size of the egg mass deposited by *C. zebra* is a function of the size of the animal. This concerns the length of the egg ribbon as well as its breadth, the latter probably depending upon the diameter of the oviduct. The number of eggs contained in each mass also depends upon the size of the individual. The length of an egg ribbon and the number of its contained eggs may, of course, be determined by other, additional, influences—such, for example, as the number of eggs already laid during the season. The reception of some sperm is apparently sufficient to induce the beginning of egg laying, and there is a certain amount of evidence going to show that once started the process of deposition continues automatically, whether the ribbon of jelly contains fertilized eggs or not. Thus, if an individual be separated from its mate before insemination has been carried to completion, it will in many cases lay a ribbon of jelly which is of normal size, but in which only the part first deposited contains fertilized eggs, these being sometimes fol-

lowed by an unorganized mass of unfertilized ones. Also, if the nudibranch be disturbed during the act of egg laying, the egg string is usually broken off and another (disorganized) one formed subsequently. Very few irregular egg masses are ever found in nature, however, and it is unlikely that the animals are disturbed to any extent while engaged in egg-laying. The number of eggs lost through this agency cannot, consequently, be very great. On the other hand, the abnormal egg masses, including many unfertilized eggs, which are laid by *Chromodoris* as the result of insufficient insemination, have an important bearing upon the possible significance of assortive conjugation.

It is well known that most nudibranchs deposit large quantities of eggs (cf. Eliot, '10). For *Chromodoris zebra*, Smallwood ('10, p. 140) calculated that 8,000–10,000 eggs were contained in each spiral. It is said that in *Doris tuberculata* 50,000 eggs may be laid in a single mass, and correspondingly large numbers have been observed for some other genera. I made estimations of the number of eggs in the ribbons deposited by *C. zebra*, and found this number to vary from 2,380 to about 20,000. The eggs when laid are imbedded in a flat, fairly regular, closely coiled spiral ribbon of jelly. The estimates were made by carefully counting the number of eggs in each of three or five turns at different positions in the spiral, and then multiplying the averages of these counts by the number of turns in the whole ribbon. The data are plotted in figure 21. The egg-masses involved in this tabulation were laid by freshly collected nudibranchs, segregated in the laboratory, so that the origin of the eggs was definitely known. Egg masses obviously abnormal were excluded from the counts.

Egg masses collected in natural surroundings were also examined, and found in some instances to contain a little larger number of eggs than the largest one incorporated in figure 21. The range of sizes, and of numbers of eggs, was not, however, significantly different from that for the egg ribbons laid in the aquaria. It is therefore legitimate to conclude that the larger nudibranchs normally deposit many more eggs at a single laying than do the small ones.

It was to be expected that the number of eggs laid by *Chromodoris* would increase with the size of the animal. This has been shown to be the case with other molluscs,—in *Crepidula*, for

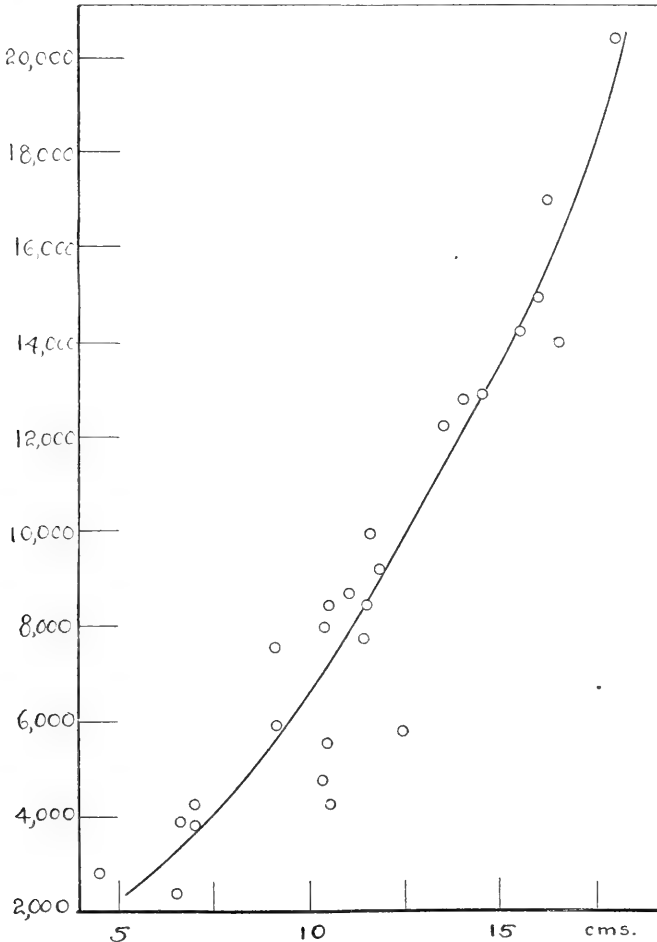

Fig. 21 Showing the relation between length of individual and number of eggs deposited in one egg ribbon.

example (Conklin, '12). By analogy with other processes, such as rhythmic movements (Crozier, '16 a, p. 311) and the production of water currents (e.g., in *Ascidia*; Hecht, '16), we should

expect manifestations of energy transformation per unit weight of individual (within a given species) to decrease with increasing size of the animal. In *Chromodoris* the number of eggs deposited at one time is almost directly proportional to the length of the animal (fig. 21), the slope of the curve even increasing somewhat with the larger lengths. Figure 22 makes it appear that the production of eggs at one time per unit weight of animal, as in the other instances of energy transformation cited, falls off somewhat with increasing weight.

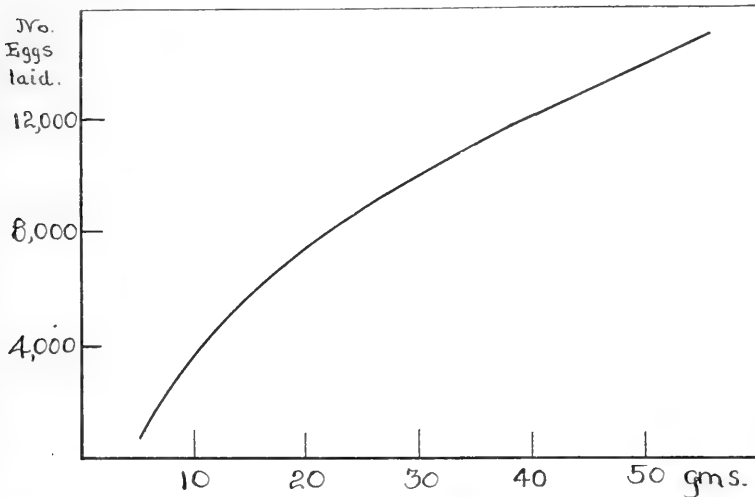

Fig. 22 Curve indicating, on the basis of Figs. 14 and 21, the general relation between weight of animal and number of eggs deposited at one time.

It is possible that the larger animals mate oftener, and lay a greater number of egg masses, than do the small ones; if this is indeed the case, their relative importance in propagation is to that degree enhanced.

From the foregoing discussion it will appear that in any attempt to appraise the significance of assortive conjugation in *Chromodoris* the following items must be considered:—

- 1) Effective mutual fertilization is involved.
- 2) As the result of insemination, a single egg mass is deposited.
- 3) If the sperm received be insufficient in amount, a disorganized mass of unfertilized eggs is frequently deposited.

4) The number of eggs contained in a single normal egg ribbon is proportional to the size of the animal.

These facts lead to the view that assortive mating is distinctly advantageous to *C. zebra*. It results in the conservation of eggs (presumably of sperm also), and, through the coupling of large individuals, insures that the number of fertilized eggs actually set free shall be greater than that which would follow from random pairing. Both of these effects may be regarded as making more certain the establishment of the greatest possible number of larvae.

The adult *C. zebra*, as I have elsewhere described (Crozier, '16 b; '17 a), is well provided with the means for securing immunity from destructive attack. This opinion is not vitiated, but is on the contrary emphatically substantiated, by the occurrence of injured specimens, as previously noted in this paper. This nudibranch is in fact one of the most plentiful animals in Bermuda waters. That the pelagic veliger is equally immune, seems highly improbable. For the continuance and increase of the species the larvae must be as numerous as possible, and toward this end many features in the ecology of *Chromodoris* cooperate. From April to June the eggs require 15 to 20 days (in the field) before they escape from the ribbon of jelly and lead for a time a free swimming existence; this is about the period recorded by other observers for the development to hatching in various *Doris* eggs (Pelseneer, '99, p. 515, where the hatching time of *Eolis* eggs is given as 9-17 days; and Eliot, '10). During this early developmental period, the eggs are protected by a repugnant jelly. I have never found an egg mass in nature which had been damaged, and no animals will partake of them, although they are commonly deposited in exposed situations, and are of a bright red color (becoming pale orange as development proceeds). Among the notable features of this case the following may be mentioned: 1) reproduction throughout the year; 2) the shoreward migrations of many individuals at certain periods, and the responses which at such times result in the concentration of the nudibranchs within the boundaries of creeks and bays, so that large numbers (sometimes hundreds)

of the animals in proper physiological condition for reproduction are simultaneously brought near together; 3) the immunity of the adults, and of their egg ribbons; and 4) the practice of assortive mating with respect to size.

Concerning the last of these points, it has been shown that assortive coupling probably operates by conserving the genital products and by insuring that as the result of any particular copulation the number of eggs fertilized and liberated is, on the average, greater than that which would be the outcome of random pairing. On these grounds I believe it not entirely correct to say, as Pearl does ('07, p. 274), that assortive mating in somas is probably vastly less important than it would be if it occurred in the fusion of gametes. It is well known that some littoral molluses which pass through a pelagic stage (e.g., *Ischnochiton*; Heath, 1899) lay vast numbers of eggs, very few of which are able to attain the adult state. For the continuance of the race—and for the multiplication of its members, thus possibly affording greater opportunities for its evolution—any influence tending to further the production of numerous young is clearly of the utmost consequence.

From the standpoint of the theory of adaptation it is, I take it, highly significant that this "adaptive" result may be understood to follow mechanically from the circumstance that *Chromodoris* of different sizes are sexually mature. This is not exactly a case which can be grouped with the striking instances of adaptation to which Eigenmann, Cuénot, Loeb ('16, p. 343), and others have applied the term (or idea) of 'preadaptation.' It is rather one of those eminently 'purposeful' practices—yielding no specific ulterior advantage to the individual, yet probably significant in the history of the race—which nevertheless depend automatically upon the structure of the organism (Parker, '13),⁵ in itself determined by quite independent and unrelated causes.

⁵ In this connection it may be noted that in the interesting case of some viviparous teleosts there is exhibited a condition which might at first be taken to favor assortive mating, in the sense that homogamy of a certain type might thereby be rendered "valuable to the species." There is, however, no evidence of assortive pairing, and indeed, with respect to the character in question, it could not occur. According to Eigenmann (1894, p. 417), in *Cymatogaster* the

2. *Size.* It is said that many nudibranchs die soon after depositing eggs (Eliot, '10, p. 18). These animals are often supposed to live for but one year, passing through a single breeding season. The life history of *Aplysia* is said also to be of this sort (Storror, '15). Available knowledge of the life histories of marine animals is far too fragmentary to allow of much generalization, but as a rule this particular kind of life cycle seems typical of species exhibiting a restricted period of breeding initiated by some special kind of behavior (e.g., the case of the medusa *Linerges*; Conklin, '08); in many of these instances the mature animals are all of about the same size.

With *Chromodoris zebra* I find it difficult to believe either that the individuals live but one year, or that they breed but once. The size frequency distribution is practically identical throughout the year. It is true that, after depositing eggs, some individuals quickly succumb when confined in aquaria; it is also true, however, that specimens of lengths ranging from 4 to 17 cms. will, even in the absence of food, live in the laboratory for several months after they have first deposited eggs, during which period they usually lay several additional egg ribbons. The several moribund specimens which I have been able to discover in the field were each 14–16 cms. long. Provided the idea were correct that *C. zebra* is an annual, and that the size variation could not wholly be accounted for on the basis of the amounts of food assimilated in different cases, then it might be necessary to fall back upon the conception of "pure lines" possessing differential genetic factors for size, as in *Paramecium*. In this event,—which is, however, highly problematical,—assortive pairing would have the effect ascribed to it in *Paramecium* (Jennings, '11 b), namely that the boundaries of the several 'pure lines' would through this influence tend to be perpetuated and maintained as

number of eggs or embryos contained in a single female increases with the size of the animal; the larger females are said to mature earlier than the smaller ones. But conjugation with males (which are smaller than the female) occurs in June or early July, whereas the eggs are not fertilized, at the earliest, until the ensuing December. This may, I believe, be regarded as one of those instances in which part at least of the apparatus essential for highly "purposeful" behavior seems to be available, yet remains unused.

the result of biparental inheritance. Beyond commenting on the possibility of such an effect, there is no good reason to speculate upon the matter.

The coloration of *C. zebra* is rather variable. Certain fairly distinct types of coloration may be distinguished. There is no correlation between color variation and size, and there is no detectable tendency for specimens of the same color type to pair together.

3. *Species crossing.* One other species of *Chromodoris*, *C. roseapicta* Verrill, is also found at Bermuda. It is commonly of about the same size as *C. zebra*, but it is much less numerous and its habits are quite different. The two species have never been found in association. So far as size merely is concerned, there seems no a priori reason why members of these two species should not pair. In nature it is probable that they meet rarely if at all. Even when they are confined in small dishes I have never succeeded in inducing *C. zebra* to mate with *roseapicta*. The mutual attraction of members of each species probably depends upon reactions to specific substances which the ripe individuals secrete. Assortive mating can play no part in the prevention of interspecific crossing.

VIII SUMMARY

1. Conjugating pairs of the nudibranch *Chromodoris zebra* mating under natural conditions were secured to the number of 148. Copulating individuals ranged from about 4 to 18 cms. in total length.

There is found a rather high degree of correlation between total length (and other dimensions) of the two components of a pair. For the total length, $r = 0.608$.

2. Mass experiments under laboratory conditions substantiate this finding. The index of correlation for total length, in 119 pairs, was $r = 0.721$.

3. Direct observation of mating behavior shows how this correlation is the result of assortive mating. In most cases large individuals mate successfully with large, small individuals with small. The homogamic correlations for different dimensions of

pairs in nature also suggest that size as such, and not (?) position in the reproductive cycle, is the basis of selection.

4. *C. zebra* is functionally hermaphroditic, and effective reciprocal insemination is practiced.

5. The number of eggs deposited in a single mass varies from 2,000 to 20,000, and is almost directly proportional to the length of the animal. The larger animals possibly lay several more egg masses in a given time than do the small ones.

6. It is consequently of advantage to the species that large individuals should mate together. In this way the numbers of eggs fertilized, and presumably of larvae set free, as the result of any one mating, is on the average greater than that which would be produced if random pairing were the rule. Moreover, by means of assortive conjugation eggs (and sperm?) are conserved.

7. Selective pairing has in this case a result which is therefore of a distinctly advantageous or "purposeful" character, since it makes for the multiplication of the species. This "adaptive" behavior is nevertheless clearly an automatic consequence 1) of the fact that the eggs are fertilized internally, necessitating the copulation of adults; and 2), more immediately, of the very condition that the size of the body is not identical in all sexually mature individuals.

IX POSTSCRIPT

The preceding account is based on observations made in late spring (April 5–May 5, 1917). It was thought to be of sufficient importance, as part of a further study of this matter, to see to what extent similar findings would result at another season of the year. Early in December, 1917, at the beginning of a period of shoreward flocking (Crozier, '17 c), naturally occurring pairs were very infrequent in Fairyland Creek, the area dealt with in the collections of the previous spring; not enough material of a homogeneous order could be secured for the purpose in view before the work had to be interrupted, although in the isolated pairs secured it was evident that assortive conjugation was the rule. Recourse was therefore had to a mating experiment, carried out with animals secured at this time.

Between forty and fifty random individuals of various sizes were placed in a large jar of running sea water. Two days later nineteen mating pairs were simultaneously secured in this population, and measured. The method of measurement was as given in the early part of this paper. The accompanying table (table 6) and figure (fig. 23) present a summary of the evidence thus obtained. The number of pairs (19) is small, yet affords adequate ground for the contention that at this season (December) the intensity of homogamy with respect to size is as great as that found in April.

It seemed that toward the end of the first week in June, 1917, the abundance of *Chromodoris* in shallow situations began notably to decrease; this was not due to my "overfishing" in the area most intensively studied, since it was equally true in other, unmolested, areas normally frequented by this nudibranch. In December they began again to increase in number in shallow regions near the shore. If it were to be held that these months mark approximately the termination of one 'breeding season' and the initiation of the next succeeding 'reproductive period,' we should be faced by the difficulty that individuals of such diverse sizes are about equally engaged in propagation at the beginning and at the conclusion of a 'reproductive season.' This condition is, however, consistent with, and adds something to, a conclusion elsewhere (Crozier, '17b, p. 381) favored, namely that the more or less periodic shoreward flocking of *C. zebra* does not signify the incidence of a special propagative period.

In December, under laboratory conditions, two individuals of average size (10 cms.) will conjugate, or attempt to, at intervals of four or five days. One pair laid four egg masses (two each) in twelve days, and other couples deposited eggs in six-day to seven-day periods; however, after the third egg laying, which comprised a relatively small number of eggs, no further masses were obtained.⁶ Egg laying, at this season, occurs two and a half to three days after conjugation; in June, within one to two days. The number of eggs contained in a single mass is, for animals of

⁶ In most cases after a variable number of weeks, even without food, eggs are again deposited.

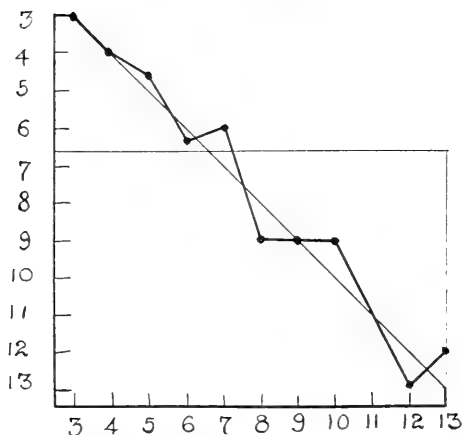

Fig. 23 Showing the relation between the length of *C. zebra* and the average size of its mates in conjugation, for 19 pairs obtained in an experiment under laboratory conditions. The class unit is 1 cm., the measurements being of total length. Length classes, abscissae; average length of mates, ordinates.

TABLE 6

Single-entry correlation table (Jennings), showing the size relations in 19 pairs of *C. zebra* obtained in one mating experiment (see text)

NOTE: The unusually high correlation observed in this table is an accidental result of the small number of pairs (19) concerned.

	3	4	5	6	7	8	9	10	11	12	13	
3	1		1									2
4		1										1
5			2	1								3
6				3	5							8
7												
8							2					2
9								2				2
10									2			
11												
12											1	1
	1	1	3	4	5		2	2			1	38

about the same size, somewhat less in December than in May-June; thus, in May, with a sea temperature of 26°, 11 animals between 9 and 12 cms. length laid on the average 7,870 eggs in a

single mass, while in December, with a sea temperature of 18°, 9 masses laid by individuals 9 to 12 cms. long contained on the average 5,290 eggs (indicating a "temperature coefficient (?)" of about 1.6). The time required for the deposition of a mass containing 4,000-6,000 eggs varies from 3 to 5½ hours.⁷

IX LITERATURE CITED⁸

- CONKLIN, E. G. 1908 The habits and early development of *Lineriges mercurius*. Carnegie Instn. Wash., Publ. 103, p. 153-170.
1912 Cell size and body size. *Jour. Morph.*, vol. 23, p. 159-188.
- CROZIER, W. J. 1916 a The rhythmic pulsation of the cloaca of holothurians. *Jour. Exp. Zoöl.*, vol. 20, p. 297-356.
1916 b On the immunity coloration of some nudibranchs. *Proc. Nat. Acad. Sci.*, vol. 2, p. 672-675.
1917 a The nature of the conical bodies on the mantle of certain nudibranchs. *Nautilus*, vol. 30, p. 103-106.
1917 b On the shoreward migrations of tropical nudibranchs. *Amer. Nat.*, vol. 51, p. 377-382. (The two figures illustrating this article have by some means undergone an interchange of legends.)
1917 c Evidence of assortive mating in a nudibranch. *Proc. Nat. Acad. Sci.*, vol. 3, p. 519-522.
- DREYER, T. F. 1912 A contribution to our knowledge of the reproductive organs of the nudibranchiata. *Rept. 9th Ann. Meet. South African Assn. Adv. Sci.* (1911), p. 340-348.
- EIGENMANN, C. H. 1894 On the viviparous fishes of the Pacific coast of North America. *Bull. U. S. Fish Comm.*, vol. 12 (1892), p. 381-478.
- ELIOT, C. 1908 On the genus *Cumanotus*. *Jour. Mar. Biol. Assn. (Plymouth)*, vol. 8, p. 313-314.
1910 The British nudibranchiate mollusca, Part VIII (Supplementary). *Ray Soc.*, 1917 pp., 8 pls.
- HARRIS, J. A. 1912 a Assortive mating in man. *Pop. Sci. Mo.*, May, p. 476-492.
1912 b Pearl and Jennings on assortive conjugation in the Protozoa. [Review.] *Science, N. S.*, vol. 35, p. 740, 741.
- HEATH, H. 1899 The development of *Isechnochiton*. *Zool. Jahrb., Abt. Ontog.*, vol. 12, p. 1-90.
- HECHT, S. 1916 The water current produced by *Ascidia atra* Lesueur. *Jour. Exp. Zoöl.*, vol. 20, p. 429-434.
- JENNINGS, H. S. 1911 a Computing correlation in cases where symmetrical tables are commonly used. *Amer. Nat.*, vol. 45, p. 123-128.
1911 b Assortive mating, variability and inheritance of size, in the conjugation of *Paramecium*. *Jour. Exp. Zoöl.*, vol. 11, p. 1-134.

⁷ Proof of this paper has been read by Dr. E. L. Mark. It has not been possible to submit it to the author for his revision.—EDITOR.

⁸ I am indebted to Prof. E. L. Mark for the use of separates of a number of the articles consulted, and to Prof. H. S. Jennings for a copy of his paper, 1911 a.

- JENNINGS, H. S., AND LASHLEY, K. S. 1913 a Biparental inheritance and the question of sexuality in *Paramecium*. *ibid.*, vol. 14, p. 393-466.
 1913 b Biparental inheritance of size in *Paramecium*. *ibid.*, vol. 15, p. 193-199.
- LOEB, J. 1916 *The organism as a whole*. New York, X + 379 pp.
- MEISENHEIMER, J. 1907 *Biologie, Morphologie und Physiologie des Begattungsvorgangs und der Eiablage von Helix pomatia*. *Zool. Jahrb.*, Abt. Biol., Bd. 25, p. 461-502, 3 Taf.
- ORTON, J. H. 1914 a On the breeding habits of *Echinus miliaris*, with a note on the feeding habits of *Patella vulgata*. *Jour. Mar. Biol. Assn. (Plymouth)*, vol. 10, p. 254-257.
 1914 b Preliminary account of a contribution to an evaluation of the sea. *ibid.*, p. 312-326.
- PARKER, G. H. 1913 Adaptation in animal reactions. *Amer. Nat.*, vol. 47, p. 83-89.
- PEARL, R. 1907 A biometrical study of conjugation in *Paramecium*. *Biometrika*, vol. 5, p. 213-297.
- PEARSON, K., AND LEE, ALICE 1903 On the laws of inheritance in man. I, Inheritance of physical characters. *ibid.*, vol. 2, p. 372-377.
- PELSENEER, P. 1894 Hermaphroditism in mollusca. *Quart. Jour. Micr. Sci.*, vol. 37, p. 19-46.
 1899 La condensation embryogénique chez un nudibranche. *Trav. Stat. Zool. Wimereux, Tom. 7 (Miscel. biol. dédiées au Prof. A. Giard)*, p. 513-520, 1 pl.
- SHEARER, C., DE MORGAN, W., AND FUCHS, H. M. 1914 On the experimental hybridization of echinoids. *Phil. Trans. Roy. Soc.*, B, vol. 204, p. 255-363.
- SMALLWOOD, W. M. 1903 Notes on the natural history of some of the nudibranchs. *Bull. Syracuse Univ.*, Ser. 4, No. 1, p. 14-17.
 1910 Notes on the hydroids and nudibranchs of Bermuda. *Proc. Zool. Soc. Lond.*, 1910 (I), p. 137-145.
- SMALLWOOD, W. M., AND CLARK, ELIZABETH G. 1912 *Chromodoris zebra* Heilprin: a distinct species. *Jour. Morph.*, vol. 23, p. 625-636.
- STORROW, B. 1915 Faunistic Notes. *Rept. Dove Mar. Lab.*, p. 59.

19
19
19

Resumido por el autor, Gary N. Calkins.

Uroleptus mobilis Engelm.

I. Historia de los núcleos durante la división y conjugación.

Uroleptus mobilis, un ciliado hipótrico muy raro, se divide y conjuga fácilmente cuando se cultiva en una infusión de heno y harina. El macronúcleo está formado por ocho núcleos separados que se fusionan en uno solo antes de la división; este último se divide tres veces sin mitosis antes que la célula se divida, y una vez después de la división de esta. El número de micronúcleos es variable (cuatro a seis). Con excepción de dos de ellos todos los demás son absorbidos antes de la división celular: los dos que persisten se dividen por mitosis dos o tres veces y un número variable de los así producidos desaparece por absorción. Durante la conjugación los macronúcleos no se fusionan pero sufren una degeneración granular y finalmente son absorbidos por el citoplasma. Los micronúcleos experimentan dos divisiones madurativas, caracterizada la primera de ellas por una profase en forma de paracaídas, de la cual se derivan un huso típico y ocho cromosomas. En la segunda división madurativa el número de cromosomas se reduce a cuatro. Los pronúcleos funcionales se forman por una tercera división de uno de los núcleos producidos en la segunda división madurativa, si bien pueden producirse hasta ocho pronúcleos de los cuales seis son absorbidos. El pronúcleo emigrante se caracteriza por la presencia de una esfera atractiva. La fusión de los pronúcleos produce un anfinúcleo con ocho cromosomas, que se divide inmediatamente en dos grandes micronúcleos, uno de los cuales se divide de nuevo para formar un gran núcleo vesicular destinado a desarrollarse en los ocho nuevos macronúcleos y un producto más pequeño, homogéneo, que degenera y desaparece. El otro gran micronúcleo se divide para formar los dos micronúcleos funcionales del nuevo organismo. La reorganización de la célula, después de tener lugar la conjugación, requiere un periodo de cinco días.

UROLEPTUS MOBILIS, ENGELM.

I. HISTORY OF THE NUCLEI DURING DIVISION AND CONJUGATION

GARY N. CALKINS

Columbia University, New York City

NINETY-FIVE TEXT FIGURES

Uroleptus mobilis is a rare hypotrichous ciliate first described by Engelmann ('62) and apparently not recognized since then, for I find no further description of it in any of the more important contributions to taxonomy of the Infusoria.

In October, 1917, the organism appeared in considerable numbers in an old hay infusion that had been standing for several months in the zoological laboratory of Columbia University. It was successfully cultivated, and abundant material for study of all the important phases of the life history was secured.

Engelmann's description of *Uroleptus mobilis* is as follows:

Body form constant; plastic; circular in section; about 12 times longer than broad; tapering gradually to a broadly pointed posterior end. Lateral cilia equally long throughout. With six elongate nuclei. This species, which came from the Boticzbach near Prag, is distinguished from the other species of *Uroleptus* recently described by Stein, by the constant presence of six nuclei arranged one behind the other. It stands close to Stein's *Uroleptus rattulus* but, unlike this species, it possesses no sharply pointed posterior end, and the lateral cilia are equally long on the tail and body. The adoral row of cilia (adoral zone) occupies about one-ninth of the total body length, with an undulating membrane fastened on its inner side; a peristome field appears to be entirely absent, or at least extremely narrow. Whether, as in other *Uroleptus* species, two longitudinal rows of fine ventral cilia are present, I could not make out since the animal is very lively and inclined to creep about, snake-like, between plant remains. Our species, moreover, which appeared in great numbers, measured on the average, 0.30 mm. All specimens were about of the same size. Division was not observed. (Loc. cit., p. 386.)

The essential characteristics here are the elongate cylindrical body with circular section, the frontal cirri, the equally long

lateral cilia, the multiple macronuclei, and the tapering posterior end with a broad point. Less important characteristics are the size, the exact number of macronuclei, and the position of the contractile vacuole. (Engelmann does not mention the contractile vacuole in his description, but in the two figures which he gives it is represented as a simple spherical vessel lying in the posterior part of the anterior third of the body.)

The New York variety differs in respect to these minor characteristics as indicated in the following description:

New York variety of *Uroleptus mobilis*. Body form constant, plastic, circular in section (figs. 1, 3); about 10.5 times longer than broad (based on averages of measurements of length and of breadth at center of body), and tapering gradually to a broadly pointed posterior end. The posterior end is permanently curved towards the ventral side. (Engelmann does not mention this curvature, but represents it in his figure.) The lateral cilia are long and distinct and sparsely distributed along straight rows running from end to end and around the posterior end of the body. Owing to density of the protoplasm, the ventral cilia cannot be made out on the living organism, but in cross-sections it is evident that three rows of ventral cilia are present, and that they are finer and shorter than the lateral cilia (fig. 3). The frontal cirri, three in number, are placed in an oblique row at the extreme anterior end of the ventral surface. The terminal cilia of the ventral rows are conspicuous at the anterior end and give the impression of five or six frontal cirri.

The peristome occupies about one-sixth of the entire length of the body and this region is slightly flattened. The peristome is very narrow with an obliquely curved row of powerful pyramidal membranelles on the left side, but almost filling the peristomial area. The right margin is sharply cut with a narrow undulating membrane inserted between it and the adoral zone (fig. 2).

The macronuclei are eight in number, and, in the vegetative stages, each possesses a typical nuclear cleft. The micronuclei are variable in number from two to six. They are minute and homogeneous.

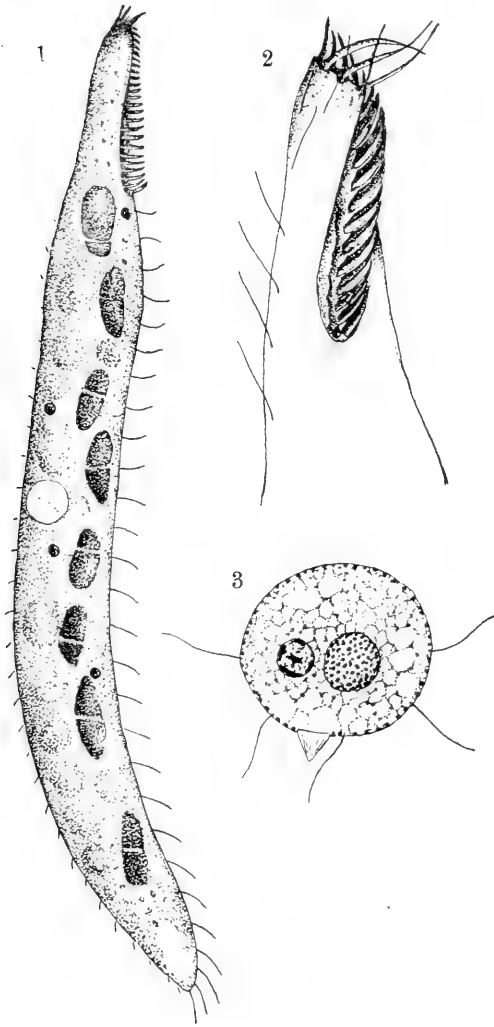

Fig. 1 *Uroleptus mobilis* Engelmann. Normal vegetative individual with characteristic curvature of posterior end; eight macronuclei each with a nuclear cleft; four micronuclei and central contractile vacuole. $\times 800$.

Fig. 2 Peristomial details. Adoral zone, undulating membrane and three frontal cirri. $\times 1500$.

Fig. 3 Cross-section through anterior region near the mouth of a conjugating individual. Two lateral and three ventral cilia are shown in characteristic position, indicating the five lines of cilia. The asymmetrical peristome is indicated by the single membranelle. The section also shows the anterior macronucleus and one of the maturation micronuclei. $\times 1500$.

The contractile vacuole is single, spherical, and lies in the center of the body near the dorsal surface.

The protoplasm is dense and alveolar with few granules in the endoplasm, but with many refringent granules forming a heavy granular coating in the cortex. These granules may possibly be mitochondria, although the mitochondria methods have not been used to determine this point. They are spherical in the ordinary vegetative stages, but are drawn out into rods which divide transversely during division stages.

The length of vegetative forms varies from 140 to 165 μ , and the diameter at the center of the body, from 11 to 17 μ .

The cysts are spherical and the cyst wall smooth with an average diameter of 32.7 μ .

While Engelmann's species averages 300 μ in length, the present form averages only 158 μ in the normal vegetative condition. The dividing and conjugating stages are much shorter, but have a larger diameter. These measurements are shown in the accompanying table:

	AVERAGE LENGTH	AVERAGE DIAMETER	EXTREMES
Vegetative stages.....	158.6 μ	15 μ	146 μ -168 μ
Division stages.....	99.0 μ	30 μ	93 μ -115 μ
Conjugation stages.....	105.2 μ	15 μ	85 μ -120 μ

A second variation from Engelmann's species is the number of macronuclei. While in the earlier description six macronuclei is given as the invariable number, in the New York variety the number is eight, six being found in only one individual out of many hundreds examined; nine, ten, eleven, and even twelve macronuclei are found more frequently than six.

A third variation is the position of the contractile vacuole which lies in the center of the body and not in the anterior third.

These variations are not important enough to warrant a new species of *Uroleptus*; they are consistent and permanent, however, and justify the belief that the present organism is a new and a well-marked variety of *Uroleptus mobilis*.

I. TECHNIQUE

A. *Culture methods*

The first attempts to cultivate *Uroleptus* on hay infusion failed. The organisms were gradually accustomed to the standard hay infusion diet by placing individuals on successive days in the medium in which they were found, diluted each day with increasing proportions of fresh standard infusion. In all of these attempts, after the organisms were finally accustomed to fresh twenty-four-hour hay infusion, their vitality was soon lost and death resulted. Fresh hay infusion was then discarded, and boiled flour water, twenty-four hours old, was substituted. To make this, 150 mg. of white flour is boiled for ten minutes in 100 cc. of spring water and allowed to stand exposed to the air for twenty-four hours.

With this medium it was found that the organisms would live and would divide about once in three days. Later, a more satisfactory medium was obtained by mixing two parts of this flour water, two parts of spring water, and one part of old hay infusion. This improved medium was used for nearly three months, the individuals dividing approximately once a day. Finally, a still better medium was obtained by boiling 100 mg. of chopped hay with 130 mg. of flour in 100 cc. of spring water for ten minutes, and diluting this, when twenty-four hours old, with an equal part of fresh spring water. With this medium made fresh every day, the organisms divide from one to three times per day, giving abundant material for the study of various vital activities.

As in previous culture work, a single individual is transferred to about 200 mg. of the culture medium contained in a flat, 40-mm. square, ground glass, hollowed dish, 8 mm. in thickness. On the following day the number of individuals is counted and a record is made of the number of divisions that have taken place. A single individual from these is then isolated and transferred to fresh culture medium made the day before. This procedure is followed daily, the records furnishing data for comparison of the states of vitality of the race that is not allowed to conjugate.

After an individual is transferred to fresh medium, the remaining individuals are placed in a Syracuse dish containing about 10 cc. of the fresh culture medium. Here they multiply in large numbers, constituting the 'stock' material, the source of dividing and conjugating forms.

B. Total preparations

In handling the material for fixing and staining, the following methods have been used. A dividing individual, or a conjugating pair, is drawn up in a capillary pipette and deposited on a clean slide with a minimum of water. The object is then covered with a couple of drops of killing fluid. After three to five minutes, the object is drawn into a second capillary pipette (used only for the killing agent) and transferred to a watch-glass containing 95 per cent alcohol. A clean, thin cover-glass is then prepared by smearing one surface with egg albumen. The specimen is then drawn up in a third capillary pipette from the alcohol and spurted on the smeared side of the cover-glass. The accompanying alcohol coagulates the albumen which holds the object during subsequent treatment. Care must be taken to prevent drying of the specimen when the alcohol evaporates; this is accomplished by flooding the smeared surface with the stain to be used, and setting the cover-glass in a moist chamber. To dehydrate, after staining, the cover-glass is placed, with forceps, into salt cellars or Syracuse dishes containing successive grades of alcohol. It is well to use at least two dishes of absolute alcohol to prepare the object for xylol. After clearing in xylol the unsmearred surface of the cover-glass is carefully wiped with a dry cloth, and the object is finally mounted in balsam.

For study of the nuclear structures, I have found that, for killing, a saturated aqueous solution of bichloride of mercury, with a trace of acetic acid, gives excellent results when followed by the iron-haematoxylin stain, and this method was mainly used in the present investigation. All stages were confirmed on material fixed in Flemming's fluid, Bouin's fluid, and Schaudinn's fluid.

C. Sections

The only sure method of getting good sections of conjugating or dividing forms is to embed and section each individual, or pair, separately, after staining with eosin in absolute alcohol. This, however, is a laborious method, and for purposes of confirming or supplementing the observations on total preparations, fixing and embedding en masse is adequate. For this purpose I use the following method. Only rich cultures of conjugating or dividing forms should be used. These should be collected in a pipette with as little water as possible and spurted into a test-tube filled with the killing agent. At the same time a quantity of thick zoogloea from an old hay infusion is fixed with the organisms to be sectioned.

The test-tube is thoroughly shaken in order to entangle the organisms in the zoogloea. After these have settled, the fluid is decanted and the process repeated with the different fluids needed for washing and dehydrating. The material is stained with eosin in absolute alcohol, and the zoogloea, now a compact, rounded mass, is finally embedded and sectioned. This method has been employed for many kinds of minute organisms.

II. THE NUCLEI IN DIVISION

In the living material early stages of division are easily recognized by the reduced length and the increased diameter of the body. If a good culture, which has not been recently fed, is transferred to fresh culture medium, a rich harvest of dividing forms may be obtained in a few hours, and all stages of division will be found amongst them.

A. The macronuclei

The eight resting macronuclei of *Uroleptus mobilis*, all have the same structure (fig. 1). They are densely granular, with a delicate membrane about them, and with the nuclear cleft (Kernspalt) characteristic of the hypotrichous ciliates. As to the significance of this nuclear cleft, I shall have something to say in a

subsequent paper. It is not present in young cells after division, nor during conjugation, and disappears at an early stage of the division activities.

The two portions of each macronucleus, separated by the nuclear cleft, are, apparently different in chromatin make-up,

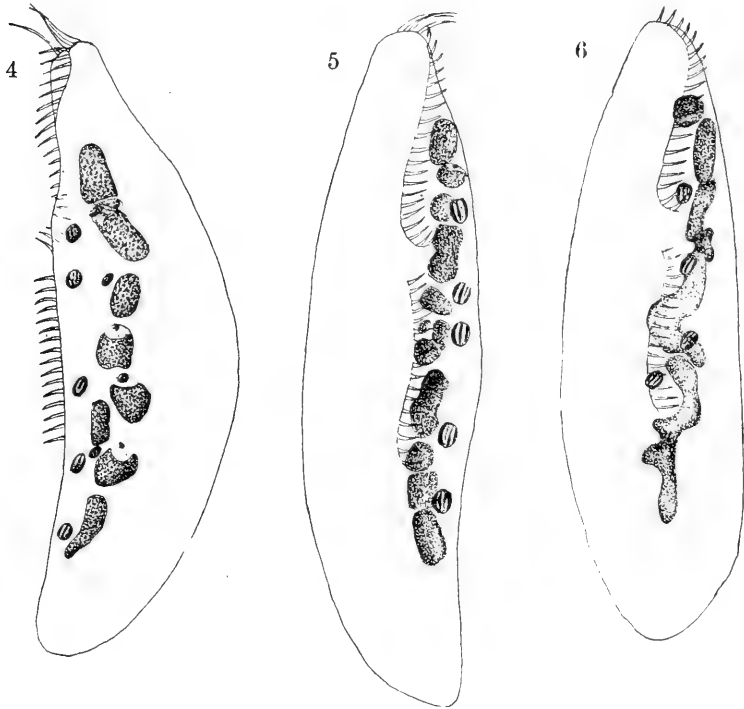

Fig. 4 Early stage of division. The macronuclei have lost, or are losing, the nuclear cleft and the distal chromatin; the five micronuclei are in mitosis; the new adoral zone forms anteriorly to the center of the body. $\times 800$.

Fig. 5 Division stage with fragmented macronucleus preparatory to fusion. $\times 800$.

Fig. 6 Fusion of the macronuclei. Four micronuclei in mitosis. $\times 800$.

one portion being less dense than the other. At an early stage in division the chromatin granules of the less dense portion, concentrate into a single granule in each nucleus (fig. 4). Later, these granules are cast off, and are absorbed in the cytoplasm (fig. 5). This differentiation may be accompanied by further

fragmentation of the remaining nuclear parts, resulting in from twelve to fourteen smaller masses (fig. 5). In all cases, however, after elimination of the chromatin granules, the nuclear fragments fuse to form a single elongate and irregularly wound nuclear mass (figs. 6 to 9). The granular contents condense, with shortening

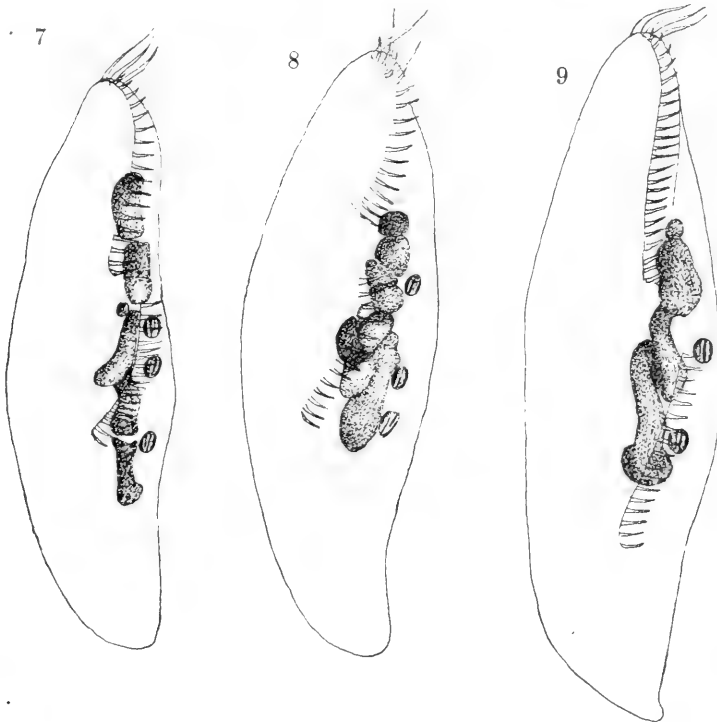

Figs. 7, 8, and 9 Stages in concentration of the macronucleus. Three and two mitotic nuclei. $\times 800$.

and loss of the irregularities, until a single, densely granular and massive, nucleus results (fig. 10). It is now ready to divide; it assumes an ellipsoidal form; its chromatin granules become arranged in lines running from end to end (figs. 11 and 12), and it constricts in the center, forming a typical dumb-bell figure before there is any external sign of cytoplasmic division (figs. 13 and 14).

The daughter nuclei next divide to form four nuclei, and these in turn form eight, four of which belong to the anterior half, four to the posterior. The lines of densely staining chromatin granules are retained throughout all of these division stages, a characteristic dumb-bell nucleus being formed at each stage (figs. 15 to 18). During the division from four into eight the cell constriction deepens in the division zone, and the cell divides, the two daughter cells having four nuclei each (figs. 18 and 19).

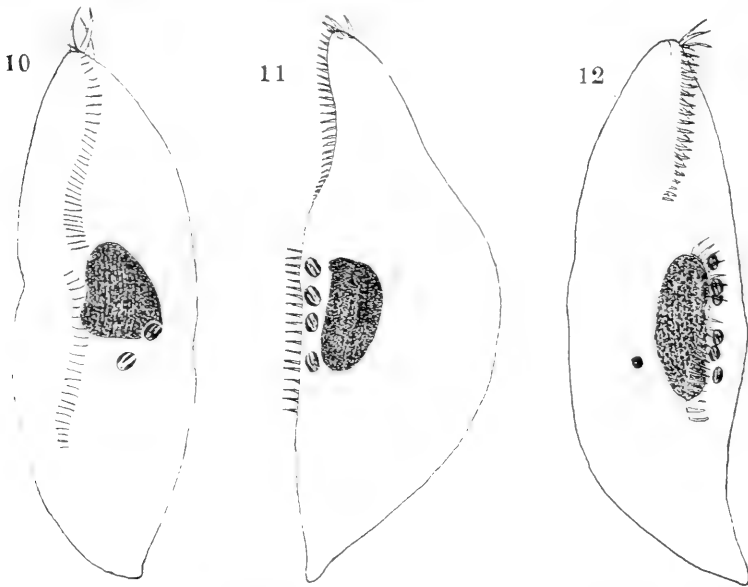

Figs. 10, 11 and 12 In figure 10 the nuclei are fully prepared for division; figures 11 and 12 show elongation of the macronucleus and increase of micronuclei to four and six, one degenerating micronucleus in figure 12. $\times 800$.

The four nuclei finally divide once again, after division of the cell and after separation, and the eight nuclei, characteristic of the normal vegetative phase, are formed (figs. 20 and 21). At each nuclear division the connecting strands are severed so that the daughter nuclei are not connected by any linin or chromatin material.

The formation and significance of the nuclear cleft after division is a complicated problem in itself which will be discussed in

a subsequent publication in connection with its appearance after encystment, after conjugation, and during regeneration.

In connection with the history of the macronucleus as given above, I find it difficult to interpret Engelmann's statement that the number of these nuclei, in his species, is constantly six. Such a condition might arise if two of the nuclei produced by the second division, should divide again; or it might arise if two of

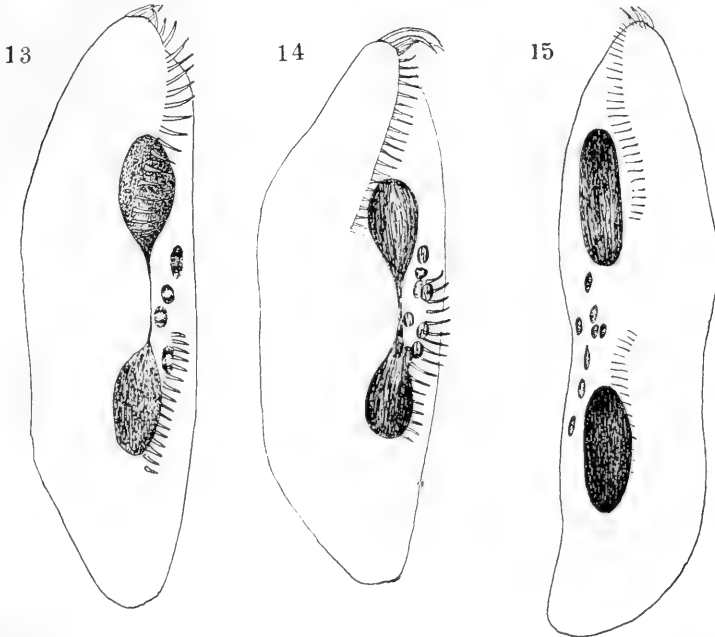

Figs. 13, 14, and 15 Division of the macronucleus and beginning cell division. $\times 800$.

the eight nuclei formed by the third division should degenerate. A third possibility seems more probable, viz., that Engelmann was mistaken.

B. The micronuclei

The history of the micronuclei during cell division is much less clear than that of the macronuclei. This is due mainly to the fact that the number is not constant; some cells have six,

some five, some four, others three, and still others only two. The minimum number, apparently, is two; this is the number present during reconstruction of the nuclear apparatus after conjugation and the number that undergo the second maturation division. That some micronuclei disappear by absorption

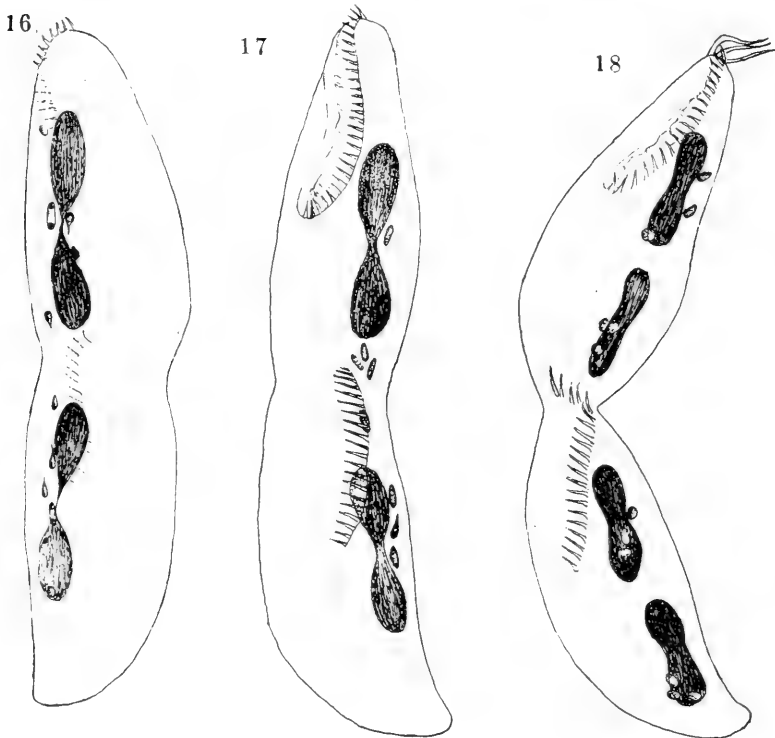

Figs. 16, 17 and 18 Second division of macronuclei, eight and twelve micronuclei. $\times 800$.

during vegetative stages is evident from the not infrequent presence of faintly staining ghosts of micronuclei. That some divide and others fail to divide is evident in some cases. That reduction in number is due to fusion or coalescence is not supported by evidence of any kind. I should interpret the variation in number, therefore, as due to absorption and irregular division, but not to fusion.

In the vegetative stages the micronuclei are very minute (1.6μ in diameter) and homogeneous in structure. They are variously distributed in the cell, a typical distribution being shown in figure 1. They lie, as a rule, close to the macronuclei, but are never embedded in the latter. They undergo mitosis

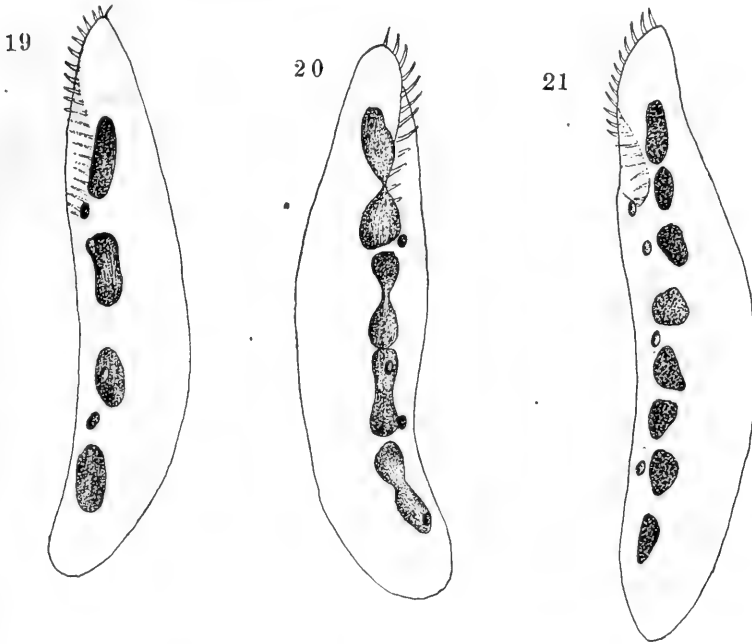

Figs. 19, 20, and 21 Cell division completed; four macronuclei present (fig. 19) which divide to form eight after daughter cells separate. The six micronuclei are reduced to four. $\times 800$.

which must be a slow process, for mitotic figures persist from the beginning of segregation of the macronuclei until the ellipsoidal nucleus is formed and ready to divide. Actual division of all such mitotic nuclei does not occur, for there is no increase in number at this period.

On the contrary, the number actually decreases until, when the macronucleus is ready to divide, there are only two micronuclei, and these are in mitosis (figs. 4 to 10). This decrease is

due, probably, to absorption, for pale micronuclei are frequently found in addition to the densely staining mitotic nuclei. At any rate, when the macronucleus is ready for division, as in the later coalescence phases, there are only two micronuclei. Their division is completed prior to division of the macronucleus, the four daughter nuclei always forming a characteristic linear group on the side of the macronucleus (fig. 11). These daughter nuclei pass directly from the telophase of the first division to the metaphase of the second, as indicated by the absence of resting nuclei during these stages. The second division may result in eight nuclei (figs. 14 and 15), or one of the four may disappear while the remaining three divide, thus giving rise to six micronuclei (fig. 12). If eight are formed, two of them disappear and six are left; finally these six divide for the third time, forming twelve micronuclei, and the cell, now ready for division, contains two sets of six, one set passing to each daughter individual (figs. 16 to 18). In some young daughter cells there are only four micronuclei (figs. 17, 19, and 21); in others there are six (figs. 16 and 18), and in others there are only five. These variations are probably due to the earlier or later disappearance of the micronuclei. The normal number would be eight had none disappeared, this number agreeing with the number of macronuclei. In the majority of hypotrichous ciliates the typical arrangement is one micronucleus for each macronucleus, but here the characteristic pairing is lost. The disappearance may be due to absorption of the nuclei in the cytoplasm, abundant evidence for which is given by the frequent presence of faintly staining nuclei.

While the number is thus variable, the great majority of the individuals studied have only four micronuclei (figs. 1 and 21).

The formation of the mitotic spindles is the same throughout. The nucleus first swells in size, losing its characteristic homogeneous structure, and becomes vesicular. The chromatin is, at first, in the form of eight (?) granular masses which may become four double smooth, and homogeneous rods stretching from pole to pole, or combinations of double and single rods may occur. Whether these rods are divided transversely or longitudinally cannot be determined owing to their minute size and densely

packed condition. Whichever method occurs, they are continued as rods in the daughter nuclei where they undergo subsequent divisions until the definite nuclei are formed (figs. 10 to 17). The fully formed spindle measures 3μ in length (figs. 22 and 23).

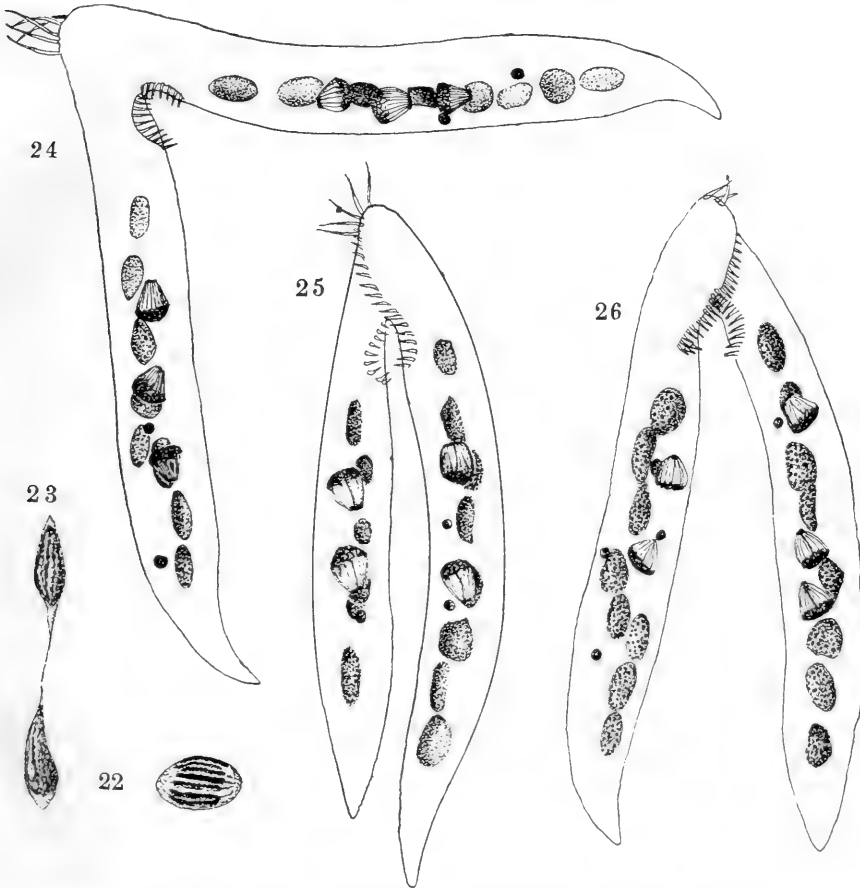

Fig. 22 Micronucleus in metaphase of vegetative mitosis. Seven chromosomes could be counted, probably eight are present. $\times 3200$.

Fig. 23 Telophase of vegetative mitosis. $\times 3200$.

Figs. 24, 25 and 26 Conjugating specimens with parachute stage of first maturation nuclei. One to three degenerating micronuclei. Macronuclei finely granular. $\times 800$.

III. THE NUCLEI IN CONJUGATION

Conjugation between closely related individuals of *Uroleptus mobilis* is a periodic phenomenon occurring at certain stages in the life cycle. Up to the present it has never taken place in the isolation culture dishes, but in the 'stock' dishes epidemics at certain periods are inevitable. The conditions under which such epidemics occur will be considered in a subsequent paper on the life history of the organism.

Epidemics of conjugation are invariably preceded by a characteristic massing or agglomeration of individuals. These masses vary in size from one-eighth to one-quarter of an inch in diameter and include thousands of individuals so closely packed together that it is impossible to see through the mass. It is a favorable opportunity for securing material for fixation in bulk of the pre-conjugation and early conjugation stages.

If such a mass of agglomerated individuals is transferred to another Syracuse dish containing fresh medium, an epidemic of conjugation will invariably follow, and material in different stages may be obtained during the following three days, as the time of conjugation varies from twenty-eight to thirty-six hours.

The organisms unite and fuse at the anterior ends. The extreme tips of the peristomes are the first to unite, and fantastic shapes of the pair, due to independent movements of the two individuals, are characteristic of this early stage. Later, the organisms settle into place and fusion of the peristomial grooves follows, until from two-thirds to three-quarters of the peristomial areas are securely united. The mouth regions are never fused. With this union the possibility of independent movements is limited and a characteristic V-form of the pair results. This and its variations are shown in figures 24 to 26. The various stages of maturation and interchange of nuclei are synchronous in the individuals of a pair.

A. The macronuclei during conjugation

The eight macronuclei retain their individuality throughout the entire process of conjugation and finally disappear on the fourth or fifth day after separation. While eight is the typical

number, a considerable percentage of individuals have from ten to twelve or even fourteen macronuclei during the early stages. I have not seen one with less than eight.

The first change undergone by these nuclei, as in preparation for division, is the loss of the nuclear cleft, and it is in this phase that the increase in number occurs, if at all. The finer structure at this time is finely granular and homogeneous (figs. 24 to 27).

As conjugation progresses a few scattered, larger granules appear in each nucleus. These increase in number and in size until, at the period of nuclear interchange, the granules are from $1\ \mu$ to $2\ \mu$ in diameter (figs. 68 and 69). The membranes are apparently lost, and what were homogeneous finely granular nuclei are now mere masses of large irregular chromatin bodies. The fixing fluids evidently have something to do with the apparent disappearance of the membranes, for they are apparent in all stages of conjugants fixed with Flemming, while the granules are always smaller than in material fixed with sublimate acetic. The nuclei are in this condition of granular disintegration at the time of separation of the conjugating individuals, and remain so for an hour or more after separation (figs. 76 and 80). This stage, however, is soon replaced by a highly characteristic phase. The masses of large granules again fuse, forming eight homogeneous, non-granular, and smooth spherical nuclei with an intense staining capacity. These slowly fade away in the cytoplasm, first one, then another disappearing, so that ex-conjugants with 8, 7, 6, 5, 4, 3, 2, and 1 degenerating macronuclei are found (figs. 86 to 90). Occasionally a mass of fine granules marks the spot where a nucleus has disappeared, but usually it vanishes without leaving a trace. The first evidence of degeneration is loss of staining capacity; six or seven of the nuclei may stain intensely while the others appear pale and ghost-like. Or four or five will stain deeply and there will be no trace of the others. Finally, at 96 hours after separation the old macronuclei are entirely absorbed in the cytoplasm and the new macronucleus begins to divide and to form the eight characteristic nuclei of the vegetative phases.

The new macronucleus is formed as a product of the second division of one nucleus resulting from the first division of the fertilization nucleus. This always occurs prior to separation of the two conjugants. The division starts in an equipolar mitotic nucleus, but in the telophase there is a marked difference in the two poles (figs. 83 to 85). One nucleus, which is ultimately absorbed, becomes a small, dense, homogeneous body of the typical micronucleus form 2μ in diameter; the other nucleus, 5μ in diameter, becomes vesicular with chromatin granules distributed about the periphery and with a linin network filling the interior (fig. 85). Granules of chromatin appear on the reticulum at a later state and the peripheral granules disappear. These internal granules have only a weak staining capacity, so that the young macronucleus at this period appears as a pale spherical body in striking contrast to the intensely stained chromatin of the old macronuclei and the new micronucleus. This is the condition of the new macronucleus at the period of separation of the conjugants, and its further history will be followed in connection with the changes which the ex-conjugants undergo (section IV).

B. History of the micronuclei

The variations in the number of micronuclei in vegetative stages make it difficult to determine the normal number that are active during conjugation. Careful study of more than 500 pairs convinces me that the number is inconstant, even during the important maturation stages. In order to determine if there is a constant difference in nuclei in the two individuals of a pair and in the early stages of conjugation, I made a careful count

Fig. 27 Conjugating specimens each with two parachute nuclei and three degenerating micronuclei. $\times 800$.

Figs. 28 to 44 Stages in the transformation of the parachute nucleus and formation of the first maturation spindle. $\times 3200$. Figures 28 to 34 show the centrosomes and connecting fibers, the homogeneous nucleus and its metamorphosis into, first, a chromatin network, and second, free granules of chromatin. Figures 35 to 39 represent the first type of maturation spindle with $24\pm$ chromosomes; Figures 38 to 39 telophase of same. Figure 40, second type of first maturation spindle with eight chromosomes; Figures 41 and 42, 43 and 44, anaphase and telophase of same.

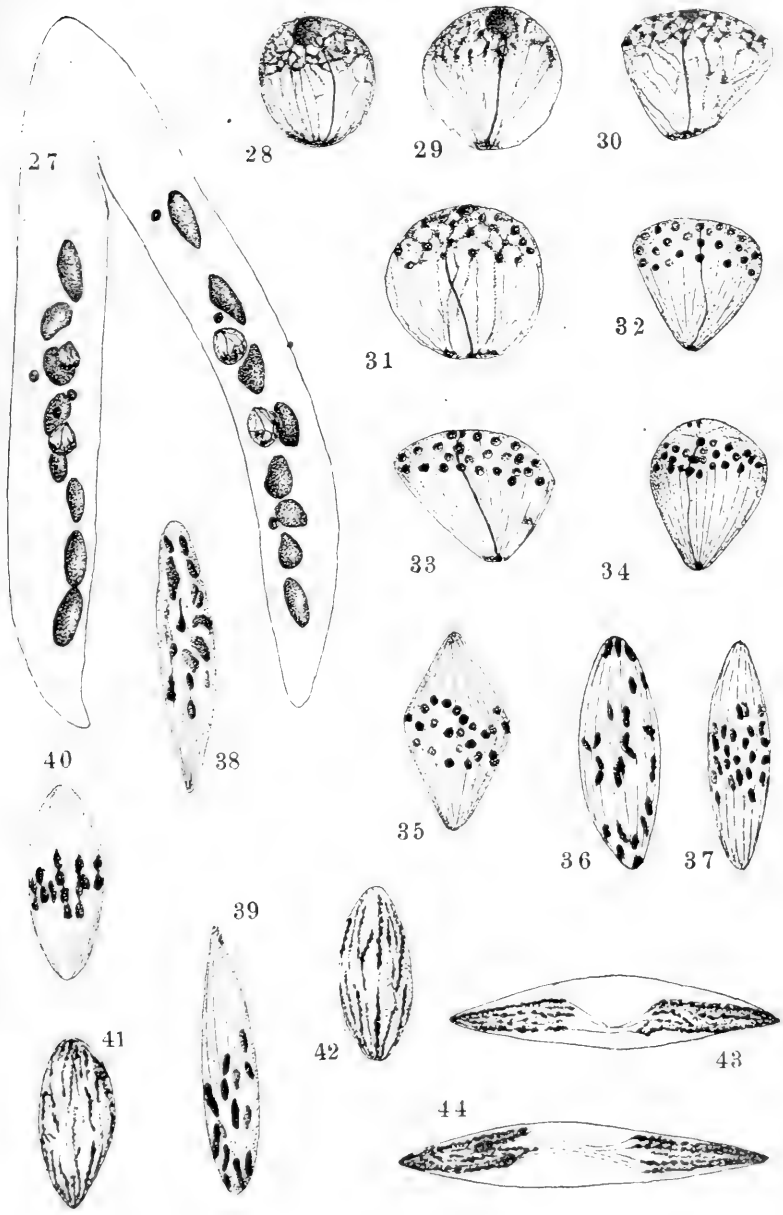

of the micronuclei in thirty-one pairs. This comparison was suggested by the possibility of sexual differences in the two individuals forming a pair. The results are tabulated in the accompanying table:

PAIRS	INDIVIDUALS		PAIRS	INDIVIDUALS		PAIRS	INDIVIDUALS		
	A	B		A	B		A	B	
1	6	4	11	5	4	21	5	4	16 pairs, 5 and 4
2	4	4	12	4	4	22	6	5	7 pairs, 4 and 4
3	4	4	13	5	4	23	6	5	3 pairs, 6 and 5
4	5	4	14	5	4	24	5	4	2 pairs, 5 and 5
5	5	4	15	5	4	25	5	5	2 pairs, 6 and 4
6	6	5	16	4	4	26	4	3	1 pair, 4 and 3
7	5	4	17	5	4	27	5	5	
8	5	4	18	4	4	28	5	4	
9	5	4	19	4	4	29	6	4	
10	4	4	20	5	4	30	5	4	
						31	5	4	

It is evident that no constant relation exists between the conjugating individuals and the number of micronuclei present at the beginning of conjugation. The predominating number is four and the predominating combination is five and four. In all cases one or more is degenerating. In later stages the differences are greater owing to the numbers of degenerating micronuclei resulting from the maturation mitoses.

Not all of the nuclei present at the beginning of conjugation take part in the maturation divisions. The largest number of first maturation spindles seen in any individual is four (fig. 47). and in this case all of the micronuclei participated; but in its mate, only three of five nuclei formed spindles. The fate of these unused nuclei is only conjectural, but they probably degenerate. Nor is there any morphological peculiarity to distinguish those nuclei which will form spindles from those which will not. It appears to be a matter of position, for the spindles are usually found in the anterior and central parts of the organism while the inactive nuclei are usually in the posterior ends.

The maturation divisions follow the usual sequence in ciliates, viz., first maturation, second maturation, and third, or pronuclei

forming, division. Three to four micronuclei take part in the first; two (very rarely three) nuclei take part in the second; and three or four take part in the third division. Thus of the eight possible products of the first division five or six degenerate. Of the four to six products of the second, two to five degenerate; and of the six or eight possible products of the third division, all but one pair degenerate, and this pair forms the wandering and the stationary pronuclei.

a. The first maturation mitosis. The formation of the first maturation spindle starts with the swelling of the homogeneous nucleus and the projection of one pole of the nuclear membrane. This projection contains one or more granules of intensely staining material which apparently corresponds with the intranuclear division center of a typical flagellate nucleus of the centronucleus type. As in the latter, a deeply staining fiber connects the projected granule with the nuclear mass (figs. 28 to 34). The projection forms a large vesicular region at one pole of the nucleus and is traversed by fibers running from the pole to the chromatin mass and surrounded by the nuclear membrane. At the outset of nuclear change the micronucleus is ellipsoidal and measures from $2\frac{1}{2} \mu$ to $3\frac{1}{2} \mu$ in its longest diameter. The projection forms on the side, not at the end, and when fully developed the nuclei measure from 5μ to 7μ (figs. 28 to 34). The granular mass in the projection forms one pole of the mitotic figure, while the fibers traversing the projection form the spindle fibers. One entire half of the mitotic figure is thus formed before there is any trace of the chromosomes or of the other pole of the spindle.

The 'chromosomes' are formed from the disintegrated chromatin mass of the micronucleus. At first a thick net-work of chromatin surrounds the denser chromatin mass (fig. 28). Later, distinct granules of chromatin appear at nodes on the net-work. Both network and granules are formed at the expense of the chromatin mass, which during this metamorphosis continually grows smaller (figs. 29 to 31). The entire micronuclear complex at this stage has a characteristic and striking appearance which suggests a parachute when examined with relatively low magnification (figs. 24, 25, and 26), and I shall refer to this phase here-

after as the parachute nucleus. It is analogous in its period of formation, and in its subsequent stages, to the crescent nucleus of *Paramecium* (*caudatum*, *aurelia*, and *bursaria*).

The 'chromosomes' are the chromatin granules formed by segregation of chromatin of the denser net-work derived from the mass of the micronucleus. A small granule, alone, remains as a reminiscence of the original dense micronucleus, and this granule forms the second pole of the mitotic figure (fig. 34).

The second pole of the mitotic spindle ultimately formed starts as a projection, again, from the, now granular, chromatin aggregate. A second vesicular region, traversed by fibers and surrounded by the nuclear membrane, is thus formed. The two poles of the spindle, therefore, are not developed simultaneously, although formed in the same way by migration of a granular constituent of the original chromatin mass. In the center, midway between the granule-holding poles, lies the group of chromatin granules which, by further segregation of the chromatin substance from the net-work, now lie as independent 'chromosomes' in and among the spindle fibers (figs. 35 and 36). The finished spindles measure from $8\ \mu$ to $10\ \mu$ in length and from $2\frac{1}{2}\ \mu$ to $4\ \mu$ in diameter at the widest part.

The granules of chromatin forming the nuclear plate of the metaphase stage undoubtedly correspond to the chromosomes of metazoon nuclei. But, of these there are two distinct types in these first maturation spindles (figs. 47 and 48). In one type, owing to their very minute size and to their usually crowded arrangement, it is impossible to count them with any degree of accuracy. A few favorable specimens (figs. 35, 36, and 37) show conclusively, however, that they are more numerous than twenty, and my best counts average twenty-four. In this type of mitosis the granules apparently pass undivided to the daughter nuclei (figs. 38 and 39).

In the second type of the first maturation spindle the chromosomes are larger, more compact, and form a definite nuclear plate (fig. 40 to 44). Here they are distinctly eight in number and eight daughter chromosomes pass to each pole of the spindle. An early anaphase stage is shown in figure 40, from which it might

be inferred that division of the chromosomes is transverse. The evidence for this, however, is by no means convincing and the plane of chromosome division, for the present at least, must remain an open question.

In later anaphase stages, these daughter chromosomes become drawn out into loose and irregular lines of chromatin granules (figs. 41 and 42) and in the telophase stage a definite chromatin reticulum is present (figs. 43 and 44). After division, this chromatin reticulum resolves itself into homogeneous granules of the vesicular nucleus characteristic of the prophase of the second maturation division.

The absence of uniformity in these first maturation spindles is peculiar and difficult to interpret. If both types were found in the same individual we might conclude that the first and more indefinite type is characteristic of nuclei destined to take no further part in the maturation processes. Unfortunately, each conjugant contains only one type and, since almost all ex-conjugants continue to live after conjugation (of sixty isolated ex-conjugants all but seven continued to live and to divide), one type appears to be as potent as the other.

Not only is there a difference in the first maturation spindles, but there is also a difference in the prophases or parachute stages. I have been unable, however, to correlate these different and relatively rare types of prophase with either of the two types of maturation spindles. In the second type of prophase, the granule forming the first pole of the spindle is accompanied by approximately one-half of the total chromatin content of the micronucleus (figs. 49 to 53). I have not found spindles that can be interpreted as arising from these aberrant parachutes, and, from the number of micronuclei in individuals containing them, I regard them as nuclei undergoing degeneration.

b. The second maturation division and reduction of chromosomes. There are from four to eight products of the first maturation division, most of which undergo granular disintegration and disappear. Two or sometimes three of them take part in the second maturation division, but I have not seen any individual with more than three, while the great majority of pairs in this stage

of maturation have only two nuclei which complete the division process in each individual.

After the telophase of the first maturation division, the nuclei do not reform the dense homogeneous nuclei characteristic of the early stages of conjugation. They become more compact, but remain vesicular with a strong staining capacity. The chroma-

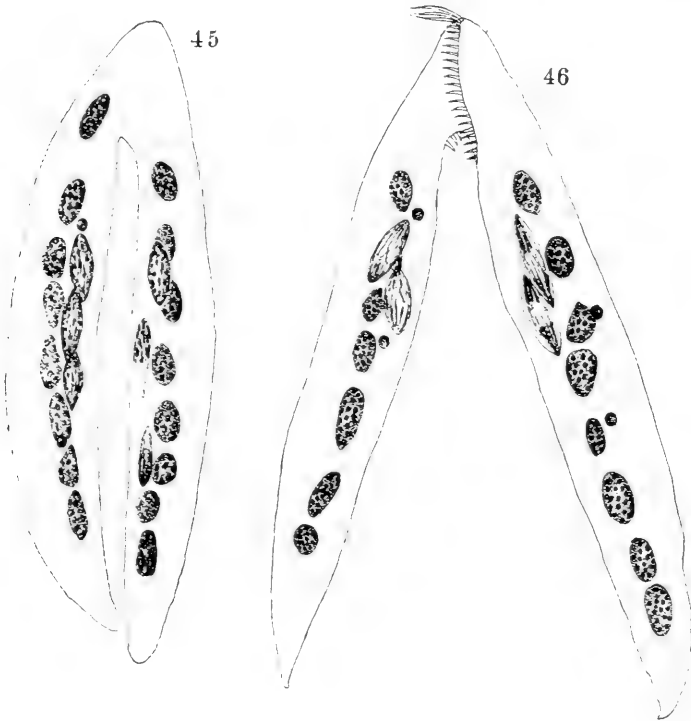

Figs. 45 and 46 Two pairs with different types of first maturation nuclei. $\times 800$.

tin at first is in a rather dense reticulum (figs. 54, *a*). It then collects into eight chromatin aggregates with irregular shapes, distributed throughout the nucleus. These aggregates are transformed into elongate rods or chromosomes (figs. 54, *b, c, d*).

The full history of this second maturation spindle is extremely difficult to work out. During its division, the number of chromosomes is reduced from eight to four, as proved by the four

chromosomes which appear in the ensuing third division, but, notwithstanding an abundance of material obtained in this stage of conjugation, I am unable to decide how the chromosomes actually divide. The minute size of the spindles and the close packing of the chromosomes are conditions which render direct observation uncertain and encourage any tendency which the

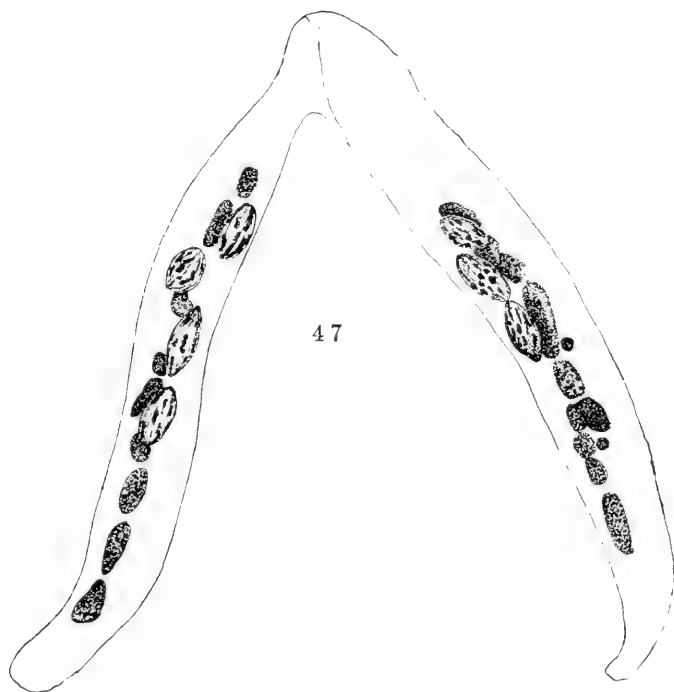

Fig. 47 First maturation spindles, first type, four in one individual, three in the other. $\times 800$.

observer may have to infer an interpretation along the lines of preconceived ideas of what the process should be. I will try to avoid the latter pitfall by describing some actual spindles as they appear under the highest lens system at my command.

The most conspicuous and the most frequent stage is illustrated in figure 55, *a*. In this stage the chromosomes are densely stained and appear as rods occupying the two central quarters

of the spindle. The number of rods is four but each rod is double. How these double chromosomes are formed from the eight single ones I am unable to decide. Another, and a less frequent stage, is illustrated in figure 55, *c*. Here there are eight

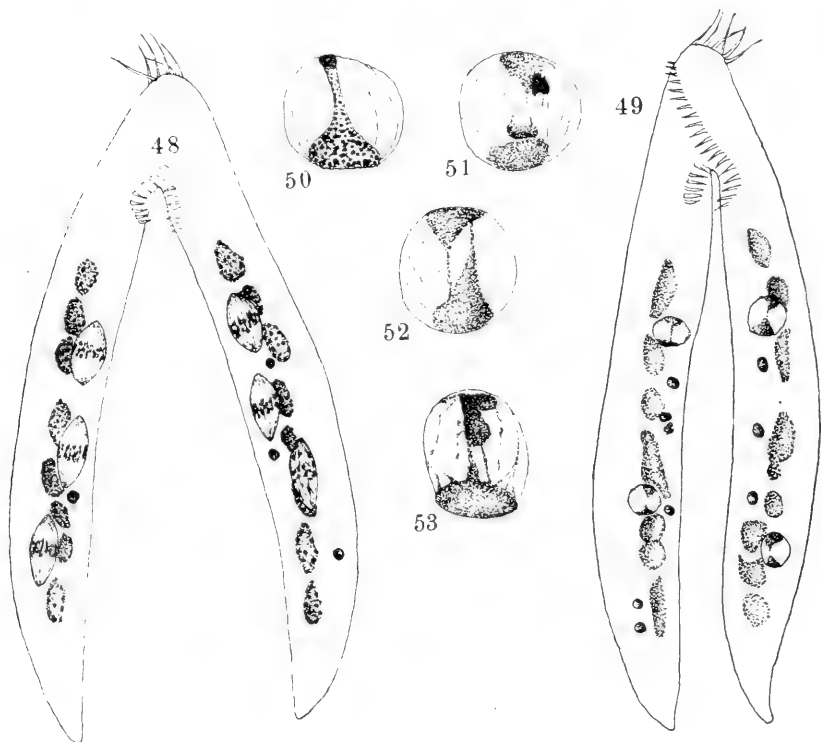

Fig. 48 First maturation spindles, second type, with definite nuclear plates. $\times 800$.

Fig. 49 Pair in prophase stage of first maturation division, with degenerating parachute nuclei. $\times 800$.

Figs. 50 to 53 Division of granular mass of chromatin in degeneration of first maturation nuclei into two parts, and vesicular swelling of the nuclear membrane. $\times 3200$.

distinct chromosomes arranged in groups of four. If the former stage is a metaphase, is the latter an anaphase or a prophase stage subsequent to that shown in figure 54, *d*? In no case found do the chromosomes lie with their long axes at right angles to the

long axis of the spindle, and in no case is there any evidence of V's or Y's. In some cases the rods appear to run unbroken from pole to pole of the spindle (figs. 55, *b*). In other cases there may be more than four distinct chromosomes, sometimes five or six or seven, in the nuclear plate. In still other cases there are four definite chromosomes at the poles of the anaphase stage (fig. 55, *d*).

Until I can be convinced of the exact method of chromosome division by further study of this phase, I will not offer an interpretation of this puzzling problem. Let it suffice here to state

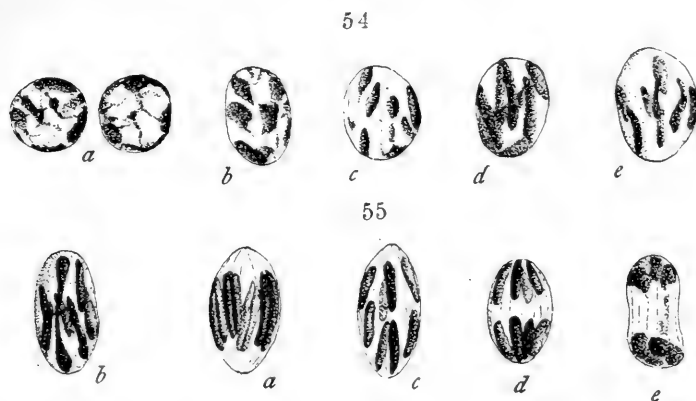

Figs. 54 and 55 Prophase, metaphase, anaphase, and telophase stages of second maturation mitosis where four double chromosomes are reduced to four single ones. Bouin fixation, iron-haematoxylin stain. $\times 3200$.

that the number of chromosomes is reduced from eight to four by this second division. The four chromosomes of the anaphase stage (fig. 55, *d*) lose their identity in the chromatin mass of the late telophase (fig. 55, *e*). The final division of the nuclei is rather abrupt, and there is no evidence of long connecting strands between the daughter products.

c. The third division. The products of the second division are small granular micronuclei, usually four in number, which are ready for the third division with no extensive intervening resting stage. In some individuals all four of them undergo this third division (fig. 57, left); in some only three, while in others only

two divide (figs. 56 and 60). In all individuals the functional pronuclei are only two in number and both come from the same one of the four original nuclei. The others disappear by absorption, although they may persist until some time after the union of pronuclei.



Fig. 56 Pair, each with two nuclei in the third maturation division. $\times 800$.

Fig. 57 Telophase of third division; four pairs of nuclei in one, three pairs in the other individual. Macronuclei fragmented. $\times 800$.

Figs. 58 and 59 Nuclei in metaphase and anaphase of third maturation division. $\times 3200$.

The early spindles of the third division are smaller (2μ wide and 6μ long), but are similar in type to those of the second maturation division (figs. 58 and 59). There are, again, four bars of chromatin, or four chromosomes, and four are present in the daughter nuclei after division (fig. 59), which is apparently transverse.

The third division figures are easily distinguished from those of the first and second divisions by the greatly elongated connecting body between the daughter nuclei. In some cases these connecting fibers attain a length of $30\ \mu$, and different stages of division are frequently found in the same individual or in the pair. The nuclear membrane plays the chief rôle in this con-

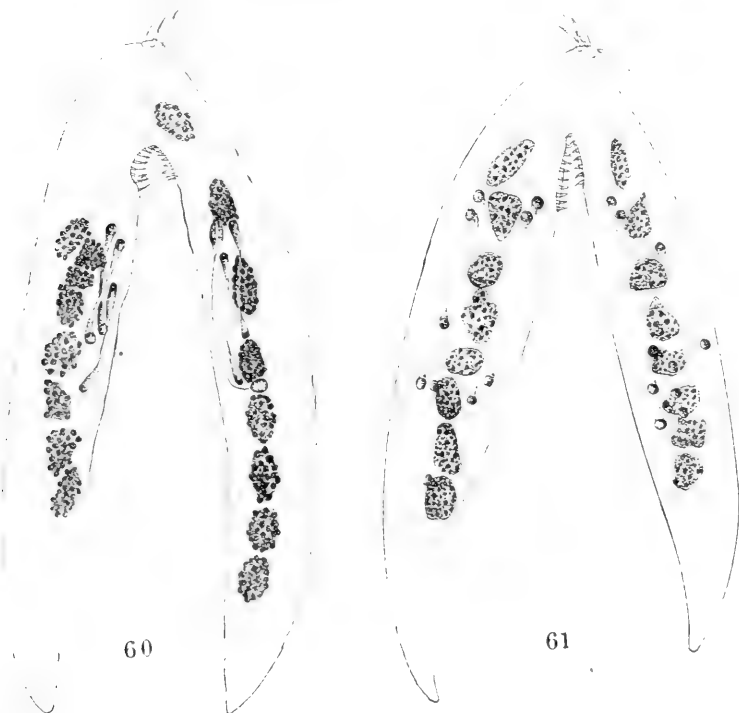
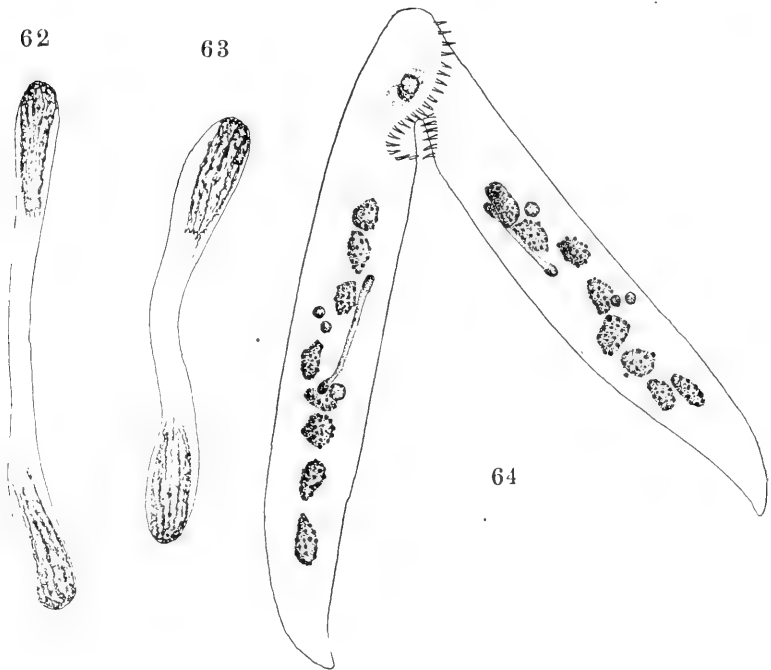

Fig. 60 Late telophase of third division and formation of pronuclei (on right). $\times 800$.

Fig. 61 Unusual phase in which eight daughter nuclei of the third division and two undivided nuclei are present without pronuclei formation. $\times 800$.

necting fiber, the chromatin apparently forming no part of it (figs. 62 and 63). As the nuclei separate the walls come together until they appear like a single connecting line (fig. 60). The chromatin now separates into granules which become distributed throughout the nuclear vesicle; the membrane closes and the pronucleus is formed.

This history is not followed by the nuclei which degenerate. With them no vesicle is formed, but the daughter nuclei, if they do not degenerate first, form homogeneous massive nuclei which gradually lose their staining capacity and ultimately disappear by absorption.



Figs. 62 and 63^a Intermediate telophase stages of the third division. $\times 3200$.
 Fig. 64 Stage of interchange. The two migrating pronuclei with their attraction spheres, are passing one another in the anterior fused region. One undivided third division nucleus is present in each cell. $\times 800$.

d. The pronuclei and the interchange. There is no difference in type, although there may be a slight difference in size without significance, perceptible in the two pronuclei formed by this third division. The stationary pronucleus is nearly always in the central region of the cell where it is left after the third division. The migrating pronucleus, formed at the other pole of the dividing nucleus, is left some 30μ nearer the anterior end. While

there is no internal structural characteristic to distinguish it from the stationary pronucleus, a peculiar external or cytoplasmic structure now appears which is decidedly characteristic and which is absent from the stationary nucleus. This structure consists of a clearly defined homogeneous mass of very fine

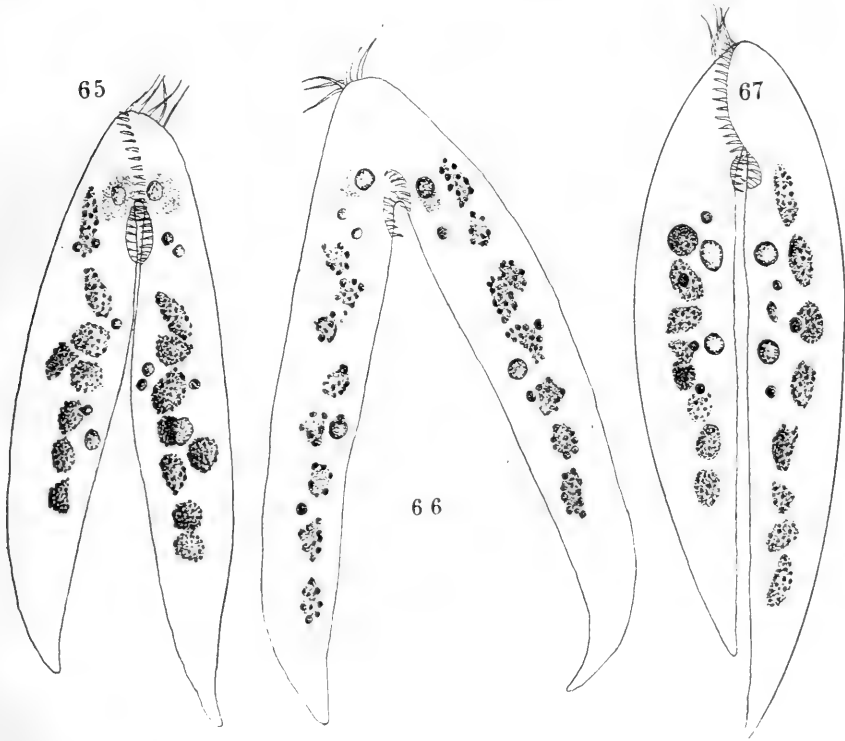

Figs. 65, 66, and 67 Three pairs with migrating pronuclei in different positions. The attraction sphere precedes the pronucleus. $\times 800$.

granules which replace the ordinary alveolar make-up of the cytoplasm. It resembles an attraction sphere and behaves as such in the later history (figs. 64 to 66 and 71 to 75).

The wandering pronucleus in each cell, preceded by this homogeneous granular mass, moves towards the anterior end where cell fusion has taken place (figs. 64, 65, 66, 71 to 75). The two pass

one another in the posterior part of the connecting bridge of protoplasm (fig. 64) and then each continues its migration in the foreign cytoplasm (fig. 66) down to the stationary micronucleus

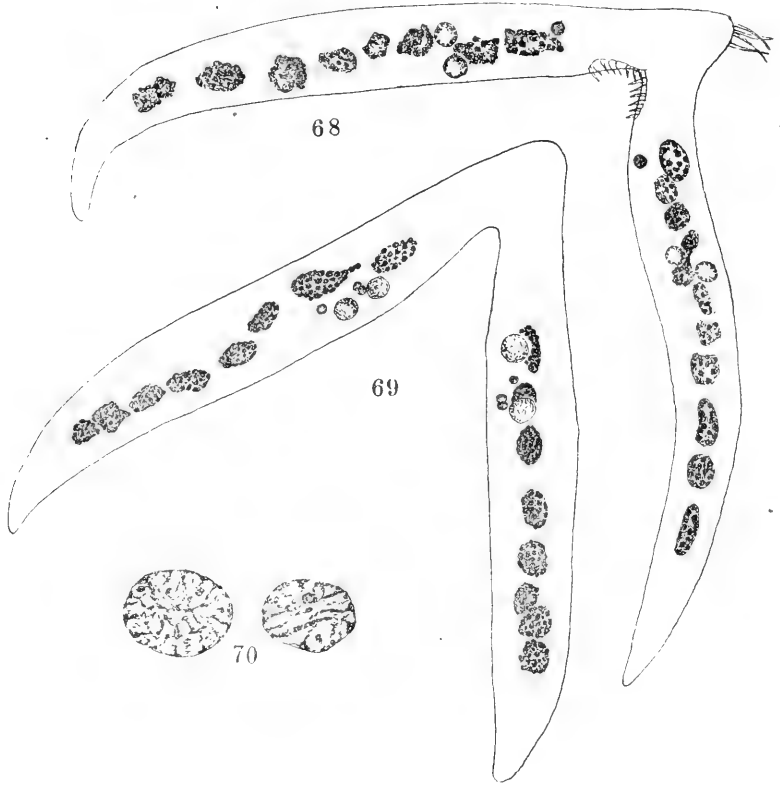

Figs. 68 and 69 Two pairs with pronuclei close together. The 'attraction spheres' have disappeared. $\times 800$.

Fig. 70 Two pronuclei about to fuse. The difference in size is without significance. $\times 3200$.

(figs. 68 and 69). Here the cytoplasmic guide can no longer be made out. The two spherical pronuclei lie close to one another, then elongate to form two ellipsoidal nuclei (figs. 70, 76, 77 and 78), and finally fuse.

e. *The amphinucleus.* The two pronuclei unite in a region of the body slightly anterior to the geometrical center. There is

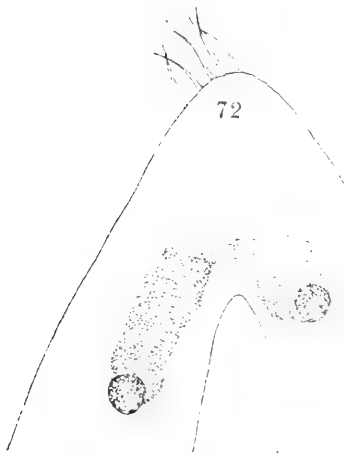
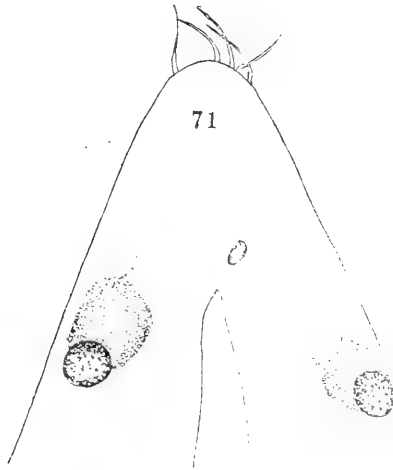

Figs. 71 and 72 Enlargements of the wandering pronuclei and 'attraction spheres.' $\times 1500$.

some evidence that the stationary nucleus advances to meet the migrating nucleus, since the former is formed either in the center, or posterior to the center, of the cell (figs. 64, 68, 69 and 76).

Each is spherical and vesicular (figs. 70 and 77) at first, but both elongate and become spindle-shaped before fusion occurs. This double spindle becomes the first cleavage spindle in which eight large, homogeneous chromosomes are present. In figure 81 the chromosomes of one side have divided before those of the other side. Its division results in two nuclei of similar size and character; one becomes the first micronucleus, the other (after a

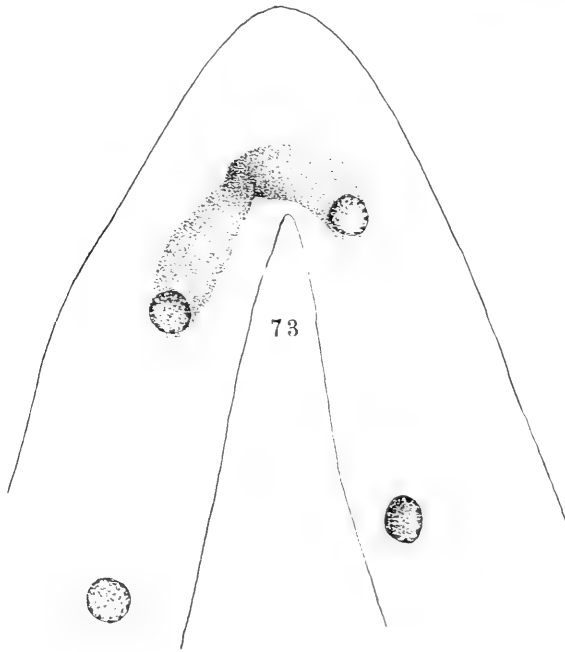
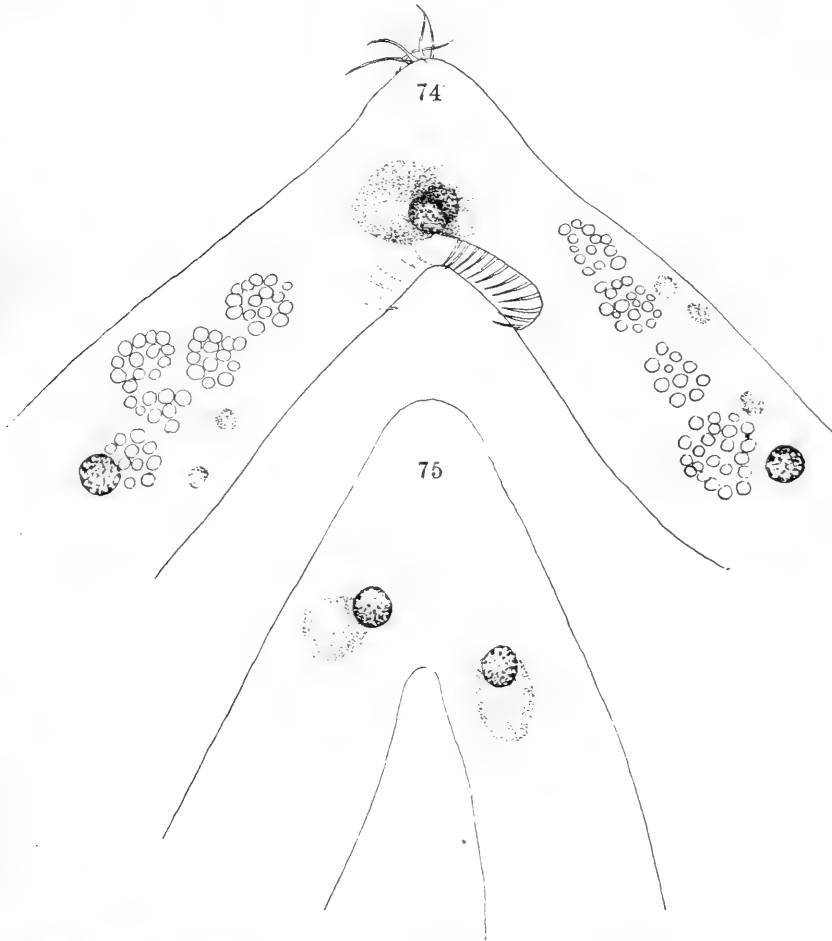

Fig. 73 Relative positions of wandering and stationary pronuclei and of 'attraction spheres' about to pass one another. $\times 1500$.

later division), the first macronucleus of the ex-conjugant (figs. 82 to 85). They are both small, and their chromatin is condensed into the homogeneous massive type of micronuclei. One is anterior, the other central in position. The former divides to form two micronuclei which condense to form the vegetative micronuclei, the other forms a spindle (fig. 82), which gives rise to two products of dissimilar fate, one becomes swollen and vesicular

with its chromatin collected in granules arranged about the periphery (figs. 83 to 85), the other degenerates. The vesicular phase of the former is preliminary to the formation of large,



Figs. 74 and 75 Wandering pronuclei passing and after passing one another. $\times 1500$.

poorly staining granules which fill the vesicular nucleus (figs. 86 and 87). As these granules are formed, the peripheral chromatin bodies disappear, their material evidently changing into

the larger, pale granules. With this new nuclear complex, viz., one ghost-like new macronucleus ('placenta'), one degenerating micronucleus, and two functional micronuclei, the conjugating individuals separate (figs. 79, 80, and 86).

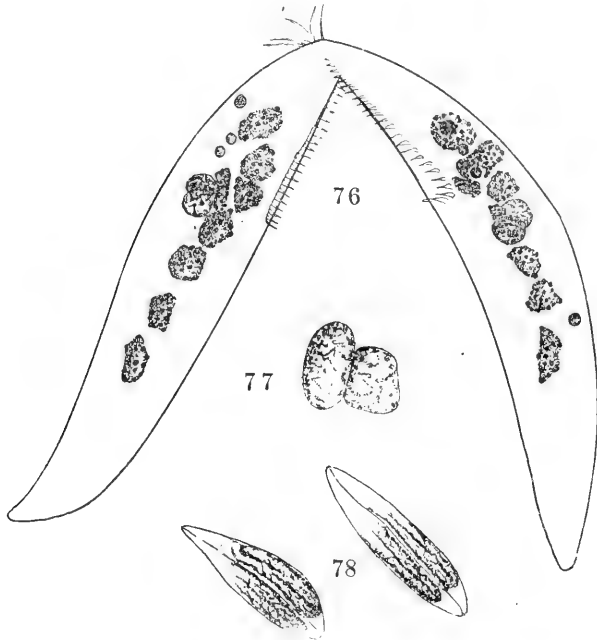

Fig. 76 Pair with pronuclei in each individual about to fuse. $\times 800$.

Fig. 77 Initial stage of fusion of the pronuclei. $\times 1500$.

Fig. 78 Elongation to spindle form of the fusing pronuclei. $\times 1500$.

IV. THE EX-CONJUGANT

Separation of the conjugating individuals begins at the posterior part of the fused regions, progress in separation being marked by the increasing length of the free peristomes (figs. 79 and 80). Finally, a connection remains only at the frontal margins, and the two cells pull apart. For a few seconds, only, they remain quiet, but within a few minutes their activities are fully restored.

Unlike most of the hypotrichous ciliates in culture, the great majority of *Uroleptus* individuals continue to live after conjugation. Of thirty pairs isolated, no less than fifty-three ex-conjugants continued to live and to divide. When we consider Bait-

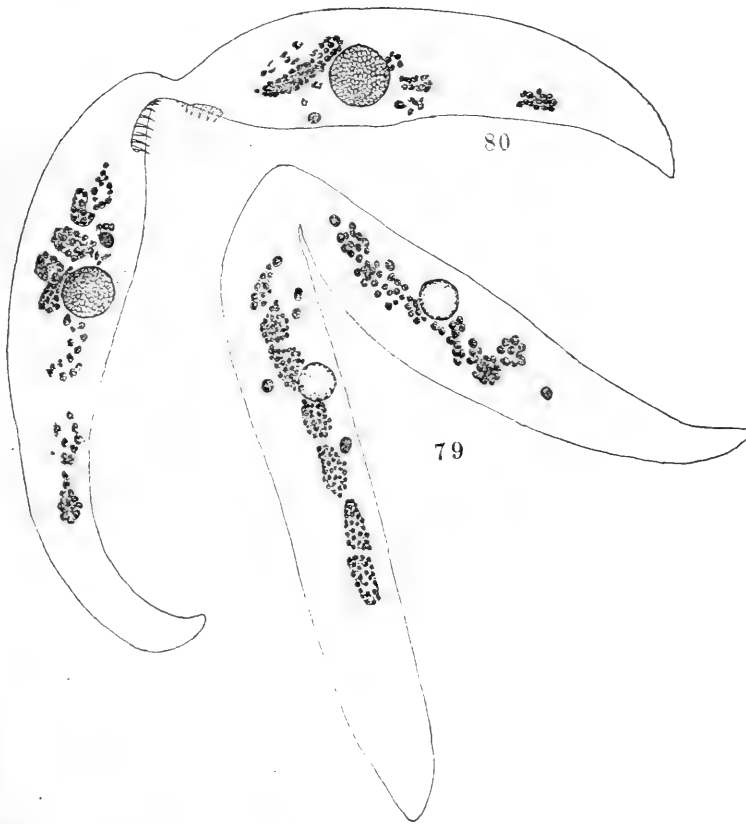

Figs. 79 and 80 Early stages in the development of the new macronuclei. \times 800.

sell's ('12) experience with *Stylonychia* and my own experience with the heterotrich *Blepharisma*, in which 100 per cent of the ex-conjugants died, this result is remarkable. Even *Paramecium* has a much larger post-conjugation mortality. There is no a priori reason why mortality in one genus should be higher than

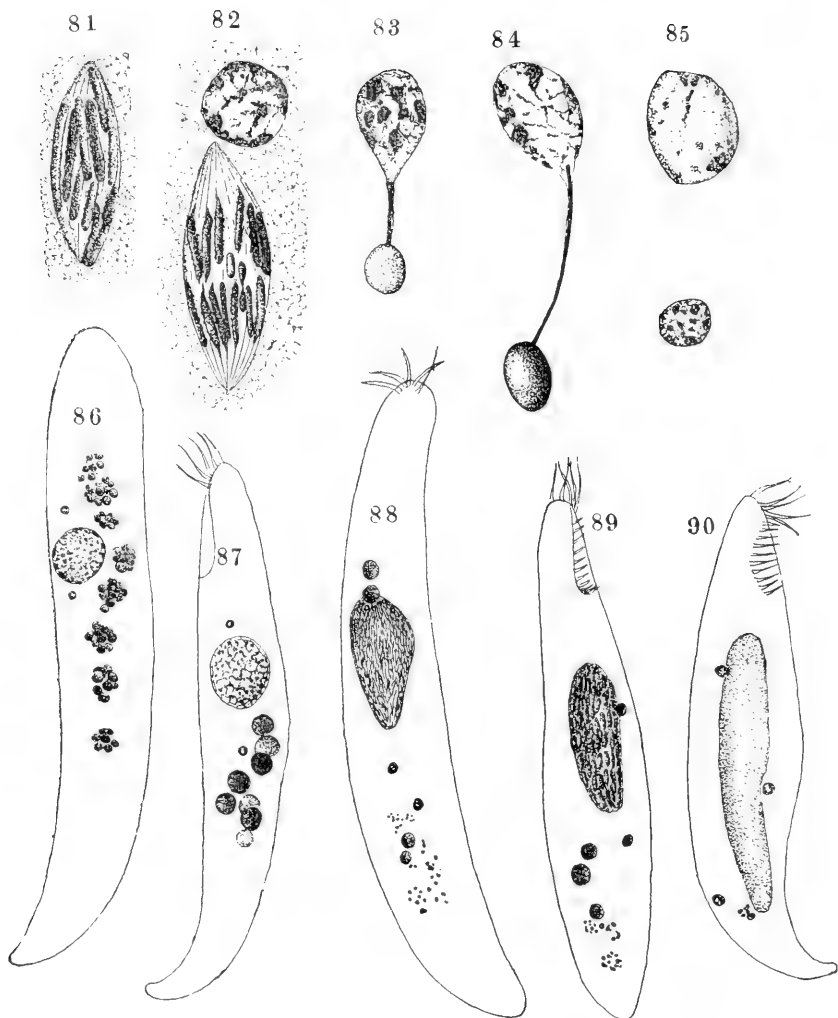

Fig. 81 First division metaphase of the amphinucleus; the chromosomes on one side are partly divided. $\times 3200$.

Fig. 82 Anaphase of the second division after fertilization with two sets of eight chromosomes, and resting nucleus, the other product of the first division. $\times 3200$.

Figs. 83, 84, and 85 Late telophase stages and final separation of the macronucleus-forming second division after fertilization. $\times 3200$.

Figs. 86 to 90 Stages in the development of the new macronucleus, concentration of the fragments of the old macronuclei and their ultimate disappearance, and stages in the concentration of the two new micronuclei. Figure 86 one hour old, the others from 48 hours to 96 hours old. $\times 800$.

that in another, and certainly no theoretical interpretation of the purpose of conjugation, admits a mortality of 100 per cent. The explanation of such mortality must be sought in the environmental conditions, and particularly in the culture medium used. The continued life of *Uroleptus* ex-conjugants indicates a normal condition of environment and a culture medium that satisfies all conditions of vitality.

The living ex-conjugants can be distinguished at a glance from individuals in any other phase of vitality. They are shorter than ordinary vegetative forms and larger in diameter. From dividing forms, or individuals immediately after division, they are distinguished by the clear, non-refractile, vesicular macronucleus which appears, vacuole-like, for two or three days after conjugation.

The young ex-conjugant contains, in addition to the new macronucleus and two new micronuclei, the granular remains of the eight original macronuclei (fig. 86, one hour old). In some individuals, the typical linear arrangement of the original macronuclei is retained (fig. 86). In others there is some confusion in arrangement with a tendency to mass near the center (fig. 87). In all cases such massing eventually occurs preliminary to final absorption and always in the posterior half of the cell. During the first forty-eight hours after separation, each of the eight macronuclei which had developed increasingly large granules during the conjugation stages again forms a compact, spherical, homogeneous mass of chromatin which takes an intense nuclear stain (fig. 87). These slowly disappear by absorption in the protoplasm. First one, then another, loses its staining capacity and fades away leaving no trace. In some cases, however, they again undergo granular fragmentation before being absorbed in the cytoplasm (figs. 88 and 89). Ultimately, four to five days after separation, not a trace remains of the old macronuclei.

In the meantime a new macronucleus is developing. The pale ghost-like character of this cell organ is retained for at least three days, but it becomes much larger and ellipsoidal in form during this period (figs. 89 to 91). The granules within, and solidly filling it, now assume a definite spherical form and begin

to stain more intensely. Each elongates to form a chromatin rod, and these arrange themselves in lines running from end to end of the nucleus. This ultimately divides by simple constriction with dumb-bell formation; the two daughter nuclei divide again, and these once again, until eight new macronuclei replace those that were absorbed (figs. 91 to 95).

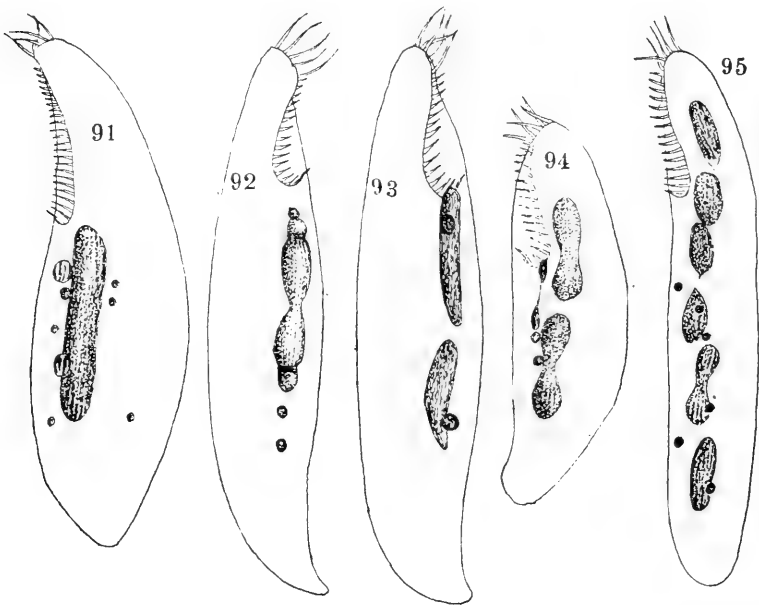

Figs. 91 to 95 Stages in the division of macronuclei and micronuclei leading to the formation of the typical nuclear complex of the vegetative forms, 96 to 120 hours after separation of the conjugants. $\times 800$.

The micronuclei also divide during this period until from six to eight are formed. Some of these degenerate, leaving the typical number four to six, in the young individual (figs. 93 to 95).

The formation of the nuclear clefts in the macronuclei of the young individuals involves some processes which strongly suggest the entrance of supernumerary micronuclei. This will be left for further investigation, however, and will be dealt with in a separate paper on the formation and significance of the nuclear cleft.

V. COMPARISONS

A. *Multiple nuclei in ciliates*

In many ciliates a multiple number of nuclei, both macronuclei and micronuclei, is the rule. Balbiani ('60, '61), in his earlier work at least, held that the number of micronuclei is always the same as the number of macronuclei, or in beaded forms, as many as there are segments of the macronucleus. Maupas ('83), Gruber ('87), Bütschli ('88), and many later observers, disproved this view and demonstrated that, in some cases, the numbers are the same (as in the majority of Oxytrichidae); in other cases, e.g., *Trachelius ovum*, *Condylostoma patens*, *Stentor*, etc., the micronuclei outnumber the macronuclei; and in still other cases the macronuclei outnumber the micronuclei (e.g., *Uronychia transfuga*, *Gonostomum pediculiforme*, *Holosticha lacazei*, *Loxophyllum meleagris*, *Spirostomum ambiguum*, etc.). The relative numbers of the two types of nuclei, furthermore, may differ in different individuals of the same species. This is the case in *Uroleptus mobilis*, where also the number of micronuclei is inferior to the number of macronuclei.

a. *Fusion of macronuclei during division.* It is quite probable that the multinucleate condition of macronuclei is only an advanced stage in physiological adaptation to the needs of the cell. At one extreme, the more generalized condition, we find the typical uninucleate cells of the majority of the infusoria. At the other extreme are forms like *Dileptus gigas*, in which the endoplasm is filled with minute chromatin bodies each of which behaves like a granular nucleus. Between these two extremes lie the ciliates with band-form, branched, beaded, or multiple macronuclei. The single nucleus of *Spathidium spathula* is drawn out as a rod; in *Euplotes*, *Aspidisca*, *Didinium*, *Vorticella*, etc., the rod becomes horseshoe shape; in many species of *Suctorina* it becomes much branched; in *Stentor*, *Spirostomum ambiguum*, *Bursaria*, and others the rod becomes more or less constricted at intervals to form the characteristic beaded nuclei. All of these conditions are modifications of the uninucleate type.

The transition to the multinucleate type is by no means abrupt. In the genus *Stentor*, for example, Johnson ('93) shows that in *S. polymorpha* the connecting strands (commissures) are relatively thick and conspicuous, while in *S. pyriformis* and in *S. igneus* no trace of such commissures could be found. In these two species, therefore, the multinucleate condition results from a fragmentation of the beaded rod form. A similar fragmentation of a homogeneous rod results in the formation of ten to fourteen nuclei of *Uronychia transfuga*, but in this case a very delicate connecting membrane can be made out. An extreme case, again, is the multiple fragmentation observed by Lebedew ('08) in *Trachelocerca*.

Balbani, Bütschli ('88), Maupas ('83), and others have maintained that, with few exceptions, in all multinucleate forms, the separate nuclei, or fragments, are held together by similar commissures and are in effect, therefore, single nuclei. This conclusion was based in part upon the obvious connecting strands in many forms and in part upon the fusion, prior to division, of all the parts, or fragments, to form a single homogeneous dividing nucleus. The fact of fusion was regarded as proof of the fact of invisible commissures.

Against this view, which is unquestionably too general, are the facts associated with those forms in which the multinucleate condition is a result, not of fragmentation, but of consecutive nuclear division. In most of the binucleate *Oxytrichidae* the two nuclei arise by equal division, the division taking place just prior to cell division. Here there is, indeed, no fusion, and the effect is that of a single nucleus which has divided precociously for the following cell division.

Gruber ('87) showed that a similar fusion of entirely disconnected small nuclei of *Holosticha scutellum* occurs during preparation for division, and that these nuclei arise from the repeated independent divisions of a single nucleus during and immediately subsequent to cell division. Exactly the same phenomenon occurs in *Uroleptus mobilis*; the disconnected nuclei, both after division and after conjugation, arise by repeated consecutive divisions of a single nucleus.

It is obvious, in these cases, that the multinucleate phase is an adaptation from the uninucleate condition, and the conclusion may be drawn that the independent nuclei, by fusion, return to a more primitive and more generalized uninucleate condition prior to division.

In some forms, finally, the independent nuclei do not fuse again prior to division and each divides independently, the progeny passing to the daughter cell in which they happen to be (*Trachelocerca*, *Dileptus gigas*, *Ichthyophthirius*, *Opalina*).

b. Absence of fusion of micronuclei during division. The number of micronuclei in *Uroleptus mobilis* varies between two and six. At no time during vegetative life, division, or conjugation is the number reduced to one, except for the very brief period during conjugation, when the functional pronuclei fuse, and before the first division of the synkaryon. Even at this time, however, there are still from three to five degenerating pronuclei in the cytoplasm of each individual. During the five days required for reorganization of the cell after conjugation, there are two micronuclei, and they begin to divide in the same period as the new macronucleus. As a result of their division, the fully reorganized cell has six to seven micronuclei. During the early phases of division, viz., during the fusion of the macronuclei, these micronuclei are found in full mitosis (figs. 4 to 14). I have never seen as many as six in mitosis at one time, but have frequently found individuals with five and four at this period of macronuclear concentration. When the macronucleus is ready to divide I have found individuals with two and with four micronuclei in mitosis (figs. 10 and 11), but never with more. If two is the initial number as indicated by ex-conjugants, then it is reasonable to infer that the number becomes reduced to two before division of the macronucleus. If this is the case, how has the reduction taken place? On this point I have no certain evidence.

Balbani ('60, '61) at first believed that multiple micronuclei are bound together in a common pouch with fine connectives like those between multiple macronuclei. No later observer has confirmed the hypothesis, and Balbani himself retracted this

view in 1881. Gruber ('87) observed a single micronucleus in the dividing stage of *Stichotricha scutellum* and followed it through two or three divisions, after which he was unable to detect any trace of micronuclei. He inferred that they become progressively reduced in size until they could not be identified among the many macronuclei. He also inferred that the conspicuous micronucleus at the time of division is a product of the fusion of all the minute nuclei distributed throughout the cell, just as the single macronucleus is the fusion product of all the macronuclei. At best this was only an hypothesis. Other cases of fusion have been suspected either during so-called autogamous fertilization (*Ichthyophthirius*, Neresheimer, '08; Buschkiel, '11) or during encystment (*Stylonychia*, Fermor, '12). In no case, except at fertilization, has the fusion of micronuclei been established.

Nor in *Uroleptus mobilis* have I any evidence that the reduction of micronuclei at division is due to fusion. The two micronuclei at this period are no larger than the five nuclei at an earlier stage (figs. 10 and 11). All that I can say is that some micronuclei, after attaining a condition of full mitosis, simply disappear.

B. Conjugation

There are approximately 1800 species of ciliated protozoa known to science. In 98 per cent of these the conjugation processes are entirely unknown, while the facts regarding conjugation in the remainder are in many cases only fragmentary and the full history is largely conjectural. In a few instances the story is fairly complete and, verified by different observers, has come to be regarded as the characteristic history of conjugation in all ciliates. How far this is true can only be determined by independent study of conjugation in different species and a study uninfluenced by preconceived notions of what the process should be. The widely diverging accounts of the details in forms like *Paramecium* (Hertwig, Maupas, Hamburger, Calkins and Cull), *Anoplophrya* (Collin), *Trachelocerca* (Lebedew), *Ichthyophthirius* (Neresheimer, Buschkiel) show that no uniformity characterizes the phenomena and that, until many more data are obtained, generalizations have little value.

Very few complete studies have been made of conjugation in hypotrichs. Apart from, and since, the classical, epoch-making work of Maupas, who included the full history of conjugation in the hypotrich *Onychodromus grandis* and a somewhat less complete history of *Stylonychia pustulata*, of *Euplotes patella*, and *E. charon*, there has been only one work on hypotrichs, that of Prowazek on *Stylonychia pustulata* in 1899.

As is well known, Maupas ('88) described eight (A to H) phases common to all types in the process of conjugation. Phase A, the initial phase, is characterized by the growth and early changes of the micronucleus; the second phase, B, by the first division of the micronucleus. In modern terms this phase is called the first maturation division or first meiotic division. The third phase, C, is the period of the second division, now called the second maturation or second meiotic division. The fourth phase, D, is the period of the third division resulting in the formation of the pronuclei. The fifth phase, E, is the period of interchange and fusion of the pronuclei; the sixth, F, and seventh, G, are the stages of the first and second divisions, respectively, of the fertilization nucleus or amphinucleus. The last phase, H, finally is the period between the second division of the amphinucleus and the first fission of the cell after conjugation. The keen powers of observation and generalization which Maupas possessed are well shown by this recognition of the successive stages in conjugation, particularly in connection with the distinction between the first and second divisions of the micronucleus, and at a time when the significance of these divisions in maturation phenomena was quite unknown. Subsequent investigations have shown that, with minor variations, these successive phases hold good for the great majority of cases.

a. The preparatory stage (phase A) of Uroleptus mobilis. The difficulties in working out the initial stages of conjugation in *Uroleptus* are increased because of the multinucleate condition of the conjugating organisms. The number of micronuclei in vegetative stages varies from four to six and the same variable numbers appear in the conjugating individuals. Analogous conditions are found in *Paramecium aurelia* (Hertwig, Maupas),

Onychodromus grandis (Maupas), *Stylonychia pustulata* (Maupas, Prowazek, '99), each having two micronuclei; in *Didinium nasutum*, with two or three (Prandtl, '06), in *Blepharisma undulans*, with from four to five micronuclei (Calkins, '12) and in *Bursaria truncatella* with from sixteen to eighteen micronuclei (Prowazek, '99).

Maupas ('88) described an anomalous, additional, or preliminary division in the case of *Euplotes patella* and in *E. charon*, where it is found in both conjugants. In other cases where such a division occurs (in the peritrichida) it is limited to the microgamete (*Vorticella monilata*, *V. nebulifera* (Maupas, '88), *Carchesium polypinum* (Maupas, '88; Popoff, '08), *Ophrydium versatile* (Kaltenbach, '15), and *Opercularia coaretata* (Enriques, '07).

The prophases of the first maturation spindle in ciliates are frequently highly characteristic. In *Loxophyllum meleagris* (Maupas, '88), *Spirostomum teres* (Maupas, '88), *Euplotes patella* (Maupas, '88), *Colpidium colpoda* (Hoyer, '99), and in *Blepharisma undulans* (Calkins, '12) however, there appears to be no typical prophase stages beyond the swelling of the nucleus, fragmentation of the homogeneous chromatin of the micronucleus and formation of the chromosomes. Hoyer ('99) describes a typical spireme in the case of *Colpidium colpoda*, but this is very exceptional in ciliates and needs confirmation.

In *Paramecium* (*aurelia*, *bursaria*, and *caudatum*) a very typical prophase stage occurs in the form of a crescent, derived from the homogeneous micronucleus which first draws out in the form of a long cylinder which later forms the characteristic crescent. A modification of the crescent occurs in *Chilodon uncinatus* (Maupas, '88; Enriques, '08), where the chromatin is drawn out in the form of an elongate comma-shaped band. This is still further modified in *Cryptochilum-nigricans* (Maupas, '88), *Vorticella monilata* and *V. nebulifera* (Maupas, '88), and in *Opercularia coaretata* (Enriques, '07), where a long chromatin rod extends, in some cases, the entire length of the cell.

Still another type of prophase, and a type to which *Uroleptus* belongs, is found in *Onychodromus grandis* (Maupas, '88), *Bursaria truncatella* (Prowazek, '99), *Didinium nasutum* (Prandtl,

'06), and *Anoplophrya branchiarum* (Collin, '09). Here the nuclear membrane first swells up to form a nucleus two or three times the diameter of the original micronucleus, while the compact mass of chromatin, placed either centrally or peripherally, fragments into numerous chromatin granules. In *Uroleptus mobilis* there is an intranuclear centrosome which divides, one-half passing to the periphery of the nucleus at the pole opposite the chromatin mass, while the other half remains in this mass. The two halves remain connected by a deeply staining strand (primary centrosomes) throughout the prophase period, but none of these structures can be demonstrated in the fully formed spindle (figs. 28 to 34). The distal centrosome is the focal point of spindle fibers which spread out from it to the fragmenting chromatin mass and forms one pole of the mitotic figure. It was a similar stage in *Anoplophrya* that suggested the term 'candelabra' to Collin. I have called it the parachute nucleus.

So far as I am aware, this is the first demonstration of the centronucleus type of nucleus in ciliates.

The majority of investigators show signs of embarrassment when it comes to the description of the formation of the second pole, or the full spindle, of the first maturation nucleus. In the transformation of the crescent type, Maupas, Hertwig, and Hamburger all agree that the spindle is formed by the shortening of the long axis of the crescent and that the tips of the crescent form the poles of the spindle. Calkins and Cull, however, find that the division center or kinoplasmic mass which forms the poles of the spindle, migrates from its terminal position in the crescent to the center of the convex side. This new position becomes the first pole of the spindle.

In the candelabra or parachute type, the second pole is formed by the outgrowth from the chromatin mass, of a second pole similar to the first, the chromatin granules thus being left in the nuclear plate position or center of the spindle figure. In *Uroleptus mobilis* this second pole is formed by the migration of the proximal centrosome from the chromatin mass while the connecting strand between the two centrosomes becomes thinner and impossible to distinguish, in the later stages, from the spindle fibers.

b. *First maturation spindle and the chromosome problem.* In the conjugation of ciliates with multiple micronuclei the usual result of the prophase activities is the formation of one first maturation spindle for each of the micronuclei present. In *Onychodromus grandis* each of the two micronuclei forms a spindle (Maupas, '88). The same is true of *Stylonychia pustulata* (Maupas, '88; Prowazek, '99), and *Paramecium aurelia* (Hertwig, '89). In *Didinium nasutum* (Prandtl, '06), and in *Blepharisma undulans* (Calkins, '12), if more than two micronuclei are present, only two of them form spindles; in *Bursaria truncatella*, on the other hand, all of the sixteen to eighteen micronuclei are active at this stage (Prowazek, '99). In *Uroleptus mobilis* there may be two, three, or four of these primary spindles (figs. 45 to 47).

The chief interest of these first maturation nuclei lies in the so-called chromosomes, especially in the methods of their formation and division. Unfortunately, we have but little exact knowledge on these points owing to the frequent large numbers and small size of the chromatin elements.

Maupas ('88) made no attempt to enumerate the chromosomes; nor did he describe their formation beyond the brief account of the fragmentation of the homogeneous chromatin masses of the micronuclei. Hertwig ('89) believed that there were eight or nine chromosomes in *Paramecium aurelia*, basing his view not on the chromosomes, but on the number of fibers which he could distinguish in the connecting strand between the two daughter nuclei. Later observers find that the number, in all species of *Paramecium*, is very much greater than this (more than 100 (Hamburger, Calkins, and Cull)).

In some more favorable types than *Paramecium* the number of chromosomes has been made out with some degree of accuracy. Prandtl ('06) finds sixteen in *Didinium nasutum*, a number which I have been able to confirm (unpublished). Prowazek ('99) was a little in doubt whether there were twelve or thirteen in the nuclei of *Bursaria truncatella*, but describes six chromosomes in *Stylonychia pustulata*. Stevens ('10) describes four chromosomes in *Boveria subcylindrica*, var. *concharum*, but gives no details as to

their formation or reduction; Enriques ('08) finds the same number in *Chilodon uncinatus*. Popoff ('08) enumerates sixteen chromosomes in *Carchesium polypinum* in the first maturation spindle, and Enriques ('07) finds the same number in *Opercularia coarctata*, while Kaltenbach ('15), somewhat doubtfully, attributes twenty chromosomes to *Ophrydium versatile*. Collin ('09), finally describes six chromosomal elements in the first spindle of *Anoplophrya branchiarum*.

Hamburger ('04) is a bit hazy in her description of the origin of the chromosomes in *Paramecium bursaria*. The late stage of the crescent is regarded as a spireme from which the chromosomes are formed as short, curved, or V-shaped rods. Calkins and Cull derive the chromosomes of *Paramecium caudatum* from a synezeisis stage which precedes the crescent, and from which the chromosomes emerge as double rods which are fully divided by the time the first spindle is completed. According to this account, the metaphase stage occurs during the metamorphosis of the crescent into the spindle, so that the latter when formed is always in the early anaphase stage.

The process of chromosome formation in *Paramecium caudatum* may be regarded as a linear fragmentation of the dense chromatin of the micronucleus. In the other forms in which the chromatin history has been followed, the process may be interpreted as a granular fragmentation, and the problem is to construct the chromosomes from these granules. The parachute nucleus, which is characteristic of most of the ciliates with a small number of chromosomes, may be compared with the *Paramecium* nucleus at the time when the division center has migrated from the apex of the crescent to the middle of the convex side. The chromatin content of such parachute nuclei consists of separated granules of chromatin, of which the number is difficult to count. In *Uroleptus mobilis* when diffusion of the granules has apparently reached its limit, I find from twenty-four to twenty-eight such granules (figs. 35 to 37). Prandtl's figures show that there are approximately thirty-two in *Didinium nasutum*. Enriques ('08) and Collin ('09) describe a similar fragmentation of the comma-form chromatin rod of *Chilodon uncinatus* and of the homogeneous

chromatin mass of *Anoplophrya branchiarum*, the granules of chromatin collecting in the center of the first maturation spindle. In *Didinium*, *Chilodon* and *Anoplophrya*, these granules fuse until a definite number of chromosomes result, sixteen in *Didinium*, four in *Chilodon* and six in *Anoplophrya*. In *Uroleptus* there may be such a fusion of granules to form eight chromosomes (fig. 40), or the nucleus may divide without such fusion, the granules being distributed in two equal groups in the daughter nuclei (figs. 38 and 39). It is tempting to assume that the former mode is typical and that eight chromosomes represent the normal condition of the first maturation spindle. This assumption would bring *Uroleptus* in line with the maturation phenomena of higher animals. But the fact of the matter is that I find just as many spindles of one type as of the other, and both types are, apparently, equally potent.

In no ciliate, in which the number of chromosomes can be counted, does this first division result in a reduction to one-half. Furthermore, there is much uncertainty as to whether the division of the chromosomes is longitudinal or transverse. Prandtl ('06) could not determine which it is in *Didinium nasutum*; Collin ('09) was equally uncertain; indeed, he seems to have had some doubts as to whether these granular elements on the first maturation spindle were even to be regarded as chromosomes. Enriques ('08), while admitting the difficulties of interpretation, is convinced that the chromosomes of *Chilodon uncinatus* are transversely divided. Popoff ('08) did not observe the fact, but assumes, apparently from analogy with conditions in many metazoa, that this first division in *Carchesium polypinum* is equational.

In *Paramecium* the chromosomes are not granules, but rods which are too numerous to count. With this form it should not be difficult to determine whether the division of each rod is transverse or longitudinal. Owing to the early views in regard to the origin of the first spindle from the crescent, it was generally assumed that division was transverse. Calkins and Cull ('07), however, found that the rods are double when formed and that the pairs are each separated in this first maturation division. Such a longitudinal division would correspond, therefore, with a

reducing division if the conditions in protozoa are the same as in metazoa. This, however, cannot be granted offhand for the second division is also longitudinal, and it was impossible to tell whether the double chromosomes were likewise longitudinally divided.

Waldeyer ('88) defines chromosomes as "the deeply staining bodies into which the chromatic nuclear net-work resolves itself during mitotic cell-division" (quoted from Wilson, '99). Apart from the chromatic nuclear net-work from which they originate, this definition would include the chromosomes of the ciliate micronucleus. But it would also include the granules of chromatin which elongate and divide in the typical macronucleus during division. The number of chromosomes, furthermore, is regarded as fixed for the same species, but the number of dividing chromatin granules in the macronucleus is immeasurably greater than the number of chromosomes of the micronucleus. It follows that either these dividing granules of chromatin are not all chromosomes or that the number of chromosomes is not fixed for the same species in all cases. It is obvious that, according to the definition, all chromatin bodies which arise from the chromatin of the resting nucleus are not chromosomes. The difficulty in most cases might be avoided by a strict interpretation of the definition which involves 'mitotic' cell division, although in some cases, e.g., *Spirochona gemmipara* (Hertwig, '77), the macronucleus divides by mitosis. The suggestion made by Rabl that the chromosomes retain their individuality throughout life of the organism has grown to a strong conviction in later years, especially through the work of Conklin, Morgan and recently Richards. I doubt very much, however, if anyone can be found hardy enough to apply this conception to the chromosomes of protozoa. Nevertheless, I believe that we are justified in regarding chromosomes in ciliates as equivalent structures to chromosomes of the metazoa. In the prophases of the first maturation spindle in ciliates we find parallel stages with those of the first maturation division in higher animals. The syzygosis stage is represented by the chromatic net-work which arises from the homogeneous chromatin in the parachute type of nucleus

(figs. 28 and 29) and the fusion of granules to form the chromosomes parallels their origin in higher forms.

c. The second maturation division. In all ciliates in which the number of chromosomes has been accurately counted, the reduction in number occurs during the second maturation division. This was first made out in the case of *Didinium nasutum* by Prandtl ('06), who found that the sixteen chromosomes resulting from the first maturation division, were separated into two groups of eight each in the second division. This method of reduction appears to be characteristic for ciliates and agrees with what Goldschmidt ('05) designates the 'first type of reduction' exemplified among metazoa by *Zoogonus mirus*.

Prior to Prandtl's work there were no conclusive observations on reduction in ciliates. Maupas ('88) and Hertwig ('89) made no attempt to follow the chromosome history. Prowazek ('99), while mentioning twelve to thirteen chromosomes in the first maturation division of *Bursaria truncatella* and six in *Stylonychia pustulata*, does not give their fate in the second division. Subsequent to Prandtl's work, we find a number of well-defined cases of chromosome reduction. In *Opercularia coarctata* Enriques ('07) finds a reduction from sixteen chromosomes to eight, the process agreeing with that in *Didinium*. In *Chilodon uncinatus* (Enriques, '08) the same observer describes the four chromosomes resulting from the first maturation division as fusing to form two pairs in the telophase stage. In the second division each pair divides, the daughter nuclei receiving two chromosomes each. A similar fusion of two pairs of chromosomes in vegetative mitosis was observed by Stevens ('10) in *Boveria subcylindrica*, but she was unable to trace the history of the four chromosomes in the maturation processes. In *Carchesium polypinum*, Popoff ('08) there are, again, sixteen chromosomes in the products of the first maturation division, which are separated into two groups of eight each by the second division. In *Anoplophrya branchiarum*, Collin ('09) describes six chromosomes in the first maturation spindle, each of which is equally divided. The second maturation spindles were not identified, but this excellent and equally candid observer finds only three

chromosomes in the nuclei undergoing the third division, and concludes that the reduction must have taken place during the second maturation division. In *Uroleptus mobilis*, finally, we find a process of reduction conforming to these processes in the other ciliates described. The eight chromosomes of the first maturation mitosis (or the many granules of chromatin in aberrant types, fig. 40), fuse, after division, to form eight chromosomes of the metaphase of the second maturation division (figs. 54 and 55). But these eight chromosomes become partially fused to form four pairs. This phenomenon is similar to that described by Enriques ('08) as occurring in *Chilodon uncinatus*; but in *Uroleptus* the fusion is not complete, the two distinct chromosomes of each pair simply lie in close contact (fig. 55, *a*). The early anaphase stages of this second division furnish some evidence indicating that the two members of each pair possibly slide apart in opposite directions, so that four single chromosomes finally collect at each pole (fig. 55).

The observations on chromosomes and reduction in ciliates may be summarized in tabular form as follows:

GENUS, SPECIES, AND ORDER	OBSERVER	NUMBER OF CHROMOSOMES AFTER 1ST MATURATION DIVISION	NUMBER OF CHROMOSOMES AFTER 2ND MATURATION DIVISION
<i>Anoplophrya branchiarum</i> (Holotrich).....	Collins, '09	6	3
<i>Boveria subeylindrica</i> (Holotrich).....	Stevens, '10	4	?
<i>Bursaria truncatella</i> (Heterotrich).....	Prowazek, '99	12-13	?
<i>Carchesium polypinum</i> (Peritrich).....	Popoff, '08	16	8
<i>Chilodon uncinatus</i> (Holotrich).....	Enriques, '08	16	8
<i>Didinium nasutum</i> (Holotrich).....	Prandtl, '06	16	8
<i>Opercularia coarctata</i> (Peritrich).....	Enriques, '07	16	8
<i>Ophrydium versatile</i> (Peritrich).....	Kaltenbach, '15	20±	?
<i>Stylonychia pustulata</i> (Hypotrich).....	Prowazek, '98	6	?
<i>Uroleptus mobilis</i> (Hypotrich).....	Calkins, '19	8	4

As to the number of nuclei participating in the second maturation or reducing division, we find many variations. In ciliates having but one micronucleus in the vegetative stages the numer-

ical relations are fairly uniform, two spindles in the second maturation division being the rule. There are, however, some exceptions. Thus in *Paramecium bursaria*, according to Hamburger ('04), one of the nuclei formed by the first maturation division degenerates without forming a spindle, so that only one nucleus undergoes the second maturation division. A second exception is found in *Euplotes patella* and in all vorticellidae examined up to the present time. Here the micronucleus undergoes one preliminary mitosis prior to the first maturation division (p. 338). The resulting two nuclei then undergo the first maturation division and the four resulting nuclei form eight by the second maturation division. In vorticellidae this unusual division occurs only in the microgamete. The micronucleus of the macrogametes, on the other hand, does not undergo a preliminary division and the usual history of uninucleate forms is followed.

In ciliates with two micronuclei, both undergo the first maturation division. According to Prowazek ('99), the four resulting nuclei in *Stylonychia pustulata* divide again, thus forming eight products of the second division. According to Maupas ('88), however, two of these first four nuclei of *Stylonychia pustulata*, and of *Onychodromus grandis* as well, degenerate so that only two nuclei divide in the second maturation division.

In ciliates with many micronuclei in the vegetative stage there seems to be no general rule as to the number which undergo the second maturation division, unless, indeed, it be variability. Prandtl ('06) found a variable number in *Didinium nasutum*; Prowazek, ('99) a large number in *Bursaria truncatella*, and I find a variable number in *Uroleptus mobilis*. The usual number of spindles in the second maturation division here is two, although three are frequently found, while individuals with one or with four have not been seen.

d. The third division. The third, or pronuclei-forming division, is a peculiarity apparently almost universal in the Infusoria. The spindles are frequently heteropolar (*Didinium*, *Paramecium*), and the telophase stage is often characterized by long connecting strands of nuclear substances (*Paramecium Blepharisma*, *Uro-*

leptis, etc.). There is no uniformity in regard to the number of nuclei to undergo this third division, although only one of the dividing nuclei provides the functional pronuclei. In Anoplophrya, Paramecium, Chilodon, Colpidium, Leucophrys, Glaucoma, Loxophyllum, Spirostomum, Bursaria, Blepharisma, Boveria, Lionotus, and in the vorticellidae only one spindle is formed for this third division. In Onychodromus, Stylonychia, and Euplotes, according to Maupas ('88), two spindles are present and four pronuclei are formed, two of which degenerate and disappear (in Stylonychia, according to Prowazek ('99), only one third division spindle is present). Uroleptus mobilis differs from the majority of other ciliates in having from two to four nuclei undergoing this third division at the same time, and as many as eight products of this division may be present in the cell before any two are metamorphosed into pronuclei (fig. 61).

e. The pronuclei. Prandtl ('06) was the first to note a difference in size between the wandering and the stationary pronuclei of Didinium nasutum. Calkins and Cull ('07) noted a similar difference in pronuclei of Paramecium caudatum, and were able to trace this difference back to a heteropolar third-division spindle. Other observers have failed to find any constant differences, and this is the case in Uroleptus mobilis, where the size relations of the fully formed pronuclei, as carefully measured in ten individuals, are as follows:

PAIR	INDIVIDUAL	WANDERING PRONUCLEUS	STATIONARY
1	A	$2\frac{1}{2} \times 3\mu$	$3 \times 3\mu$
	B	$3 \times 3\mu$	$2\frac{1}{2} \times 2\frac{1}{2} \mu$
2	A	$2\frac{1}{4} \times 2\frac{1}{2} \mu$	$3 \times 3 \mu$
	B	$3 \times 3 \mu$	$2\frac{1}{4} \times 3 \mu$
3	A	$3 \times 3 \mu$	$2\frac{1}{2} \times 3 \mu$
	B	$3 \times 3 \mu$	$2\frac{1}{4} \times 2\frac{1}{4} \mu$
4	A	$2\frac{1}{2} \times 2\frac{1}{2} \mu$	$2\frac{1}{2} \times 3 \mu$
	B	$3 \times 3 \mu$	$2\frac{1}{4} \times 3 \mu$
5 ¹	A	$3\frac{1}{2} \times 3\frac{1}{2} \mu$	$3 \times 3 \mu$
	B	$3 \times 3 \mu$	$4 \times 4\frac{1}{2} \mu$

¹ Pairs 1 to 4 were fixed in Bouin's fluid; pair 5 in sublimate acetic.

These differences are too uncertain to permit any conclusion as to the size relations between wandering and stationary pronuclei. In some cases the wandering pronucleus is smaller, in other cases larger than the stationary pronucleus.

Apart from size differences, we occasionally find structural differences between the wandering and the stationary pronuclei. Maupas ('88) was the first to note the presence of a dense aggregate of cytoplasmic granules at the forward end of the advancing pronucleus of *Euplotes patella*, while no such aggregate was seen in connection with the stationary pronucleus. Hoyer ('99) observed 'astral rays' about each of the pronuclei of *Colpidium colpoda*, but without distinctive differences; similar radiations, more pronounced about the wandering pronucleus, were described by Prandtl for *Didinium nasutum*. In *Uroleptus mobilis* there are no radiations such as occur in *Didinium*, but the granular aggregate at the forward end of the wandering pronucleus is highly characteristic and its presence confirmed in material fixed in sublimate acetic, in Flemming's fluid, in Bouin's fluid and in Schaudinn's fluid. It appears to be a directive center, possibly analogous to the centrosphere of *Noctiluca*. It cannot be interpreted as a collection of granules due to pressure of an advancing solid for the advanced end of the mass curves around the anterior end in a definite way (figs. 71 to 75). With the approach and union of the pronuclei this mass disappears.

f. Fusion of the pronuclei. The outcome of the interchange of pronuclei is the fusion of migrating and stationary pronuclei. In all ciliates which have been carefully examined, with the exception of the vorticellidae, this interchange and fusion is mutual. Hoyer ('99), however, holds a different view. He, like Maupas before him, failed to find evidence of the union of pronuclei in *Colpidium colpoda*, and concluded that no fusion occurs, the foreign pronucleus in each individual forming the functional micronucleus. In the face of the overwhelming evidence in other, and probably more favorable ciliates, this peculiar view cannot be admitted. In the vorticellidae the microgamete fuses with the macrogamete and loses its identity in the protoplasm of the larger conjugant. Here one of the two pronuclei formed by

each conjugant degenerates, and only a single fertilization nucleus is formed.

At the time of fusion the pronuclei may be either in the form of spherical and vesicular nuclei or drawn out into more or less pointed spindle form. We find the former type in *Anoplophrya branchiarum*, *Didinium nasutum*, *Spirostomum teres*, *Blepharisma undulans*, and *Opercularia coarctata*, while union of pronuclei in the spindle form is reported in all species of *Paramecium*, *Chilodon uncinatus*, *Leucophrys patula*, *Onychodromus grandis*, *Stylonychia pustulata*, *Vorticella nebulifera*, *Ophrydium versatile* and *Lionotus fasciola*. In some cases it seems to be immaterial whether the pronuclei are vesicular or spindle form at the time of fusion (*Loxophyllum meleagris*, *Carchesium polypinum*). *Uroleptus mobilis* appears to be an intermediate type, for here the pronuclei approach and meet while in the spherical and vesicular form, but before the fusion membrane dissolves both pronuclei elongate and assume the spindle shape (figs. 77 and 78). The chromatin, however, is not aggregated into chromosomes at this period, but lies in diffuse granular form exactly as in *Paramecium caudatum*. While the general form is that of a nucleus in division, these fusing pronuclei can no more be regarded as mitotic spindles than can the fusing spherical nuclei; in both types we have merely the antecedent phases of mitosis.

g. Reconstruction of the vegetative nuclei. The first division of the fertilization nucleus occurs very quickly after fusion and is not often seen. In *Uroleptus* I have found only one spindle that can be identified as the first division spindle (fig. 81). In this spindle the two sides are not symmetrical, indicating the division of chromosomes from one pronucleus earlier than in the other. The further history of the first two nuclei after conjugation differs in different cases, and for some species the accounts by different observers do not agree. According to Enriques ('08), in *Chilodon uncinatus* one of these first two forms the new macronucleus and the other the new micronucleus. This, perhaps, is the simplest case on record. In all of the other cases described by different observers the macronucleus is not differentiated from the micronucleus until at least four nuclei have been formed

by a second division of the first two. One or two of these four may degenerate; one or two may form macronuclei. Or the four may divide again, forming eight nuclei before differentiation begins. In *Anoplophrya branchiarum* and in *Euplotes patella* two of the four nuclei degenerate, the other two form one macronucleus and one micronucleus. In *Colpidium colpoda* (Hoyer, '99), *Stylonychia pustulata* (Maupas, '88) and in *Lionotus fasciola* (Prowazek, '09), only one of the four degenerates, two become functional micronuclei, and one becomes the macronucleus. In *Didinium nasutum* (Prandtl, '06), *Paramecium bursaria* (Hamburger, '04), *Glaucoma scintillans* (Maupas, '88), *Leucophrys patula* (Maupas), *Spirostonum teres* (Maupas), and in *Stylonychia pustulata* (Maupas), two of the four nuclei become macronuclei and two become micronuclei, none of the nuclei degenerating. In *Blepharisma undulans* (Calkins, '12) all four of this stage become macronuclei enclosing the micronuclei.

In another group the first four nuclei divide once again before the nuclei are differentiated. Here we find *Paramecium caudatum*, *Paramecium putrinum*, *Cryptochilum nigricans*, *Carchesium polypinum*, *Vorticella nebulifera*, and *Ophrydium versatile*. In the last three mentioned, seven of the eight nuclei form macronuclei. These fuse to form one in *Cryptochilum* (Maupas), but in the other three forms they remain separated and are distributed to the daughter cells by unequal division until each cell has one (Maupas, Kaltenbach, Popoff). In *Paramecium caudatum* and in *P. putrinum*, four of the eight nuclei form macronuclei, while the fate of the other four is differently interpreted. Maupas ('88) and Doflein ('11) hold that three of these degenerate, leaving one functional micronucleus. Calkins and Cull ('07) find that all four are functional.

An exceptional history is shown in the reorganization of *Bursaria truncatella*. Here no differentiation occurs until sixteen nuclei are formed (Prowazek, '99). Two to five of them form macronuclei, three or more form micronuclei, and the remainder degenerate.

In *Uroleptus mobilis* differentiation of the nuclei occurs with the second division of the fertilization nucleus. One of the two nuclei formed by the first division divides unequally into a large vesicu-

lar nucleus, the beginning of the macronuclei, and a small nucleus which degenerates. The chromosomes are eight in number in the first two divisions of the fertilization nucleus where they can be counted without much difficulty. After the differentiating second division there is a long pause, during which the young macronucleus undergoes its metamorphosis. During this period, which lasts for approximately 72 hours, the two functional micronuclei become more compact and smaller, and when they finally divide, the spindles are so minute that no sure observation can be made as to the number of chromosomes contained. In mitoses from ordinary vegetative divisions, however, the number is eight, the chromosomes frequently lying in four pairs similar to the condition in the second maturation division but occasionally one or more pairs are not united so that five, six, or seven may be counted.

h. Fate of the old macronucleus. All observers, with the exception of Prowazek ('99, '09), are agreed as to the fate of the old macronucleus. Prowazek, among the recent workers at least, appears to be alone in concluding that the old macronucleus is cast out of the cell as waste material. His conclusion is drawn from the premise that nucleins cannot be digested and must therefore be eliminated. As Collin ('09) points out, Prowazek describes the loss of staining power of the old macronucleus fragments, and to this extent at least admits that the nuclei are digested. As he offers no evidence of such elimination from direct observation of the reorganization processes of *Bursaria*, *Stylonychia pustulata*, and *Lionotus fasciola*, his conclusion may be dismissed as highly improbable.

The majority of observers have traced the gradual reduction in size of the old macronucleus or its fragments until nothing remains. This certainly is its history in *Uroleptus mobilis*, where the eight old macronuclei become greatly reduced in size and then fade away, one by one, until all are absorbed in the cytoplasm.

The following table is a summary of the points made by different observers on different species of ciliates and is useful for purposes of comparison. In most cases where two or more observers have worked on the same species only the most important papers are cited.

ORDER	GENUS AND SPECIES	OBSERVER	NUMBER OF SPINDLES				NUMBER OF CHROMOSOMES			TYPE OF PHASE 1st MATURATION MITOSIS	DIFFERENCE IN PRONUCLEI	PRONUCLEI AT FUSION	STAGE OF MACRONUCLEUS DIFFERENTIATION	DEGENERATING MICRONUCLEI AFTER-CONJUGATION	FATE OF OLD MACRONUCLEUS
			Vegetative division	First maturation division	Second maturation division	Vegetative mitosis	After first maturation division	After second maturation division	Preliminary mitosis						
	<i>Anoplophrya branchiarii</i>	Collin, 1906	1	1	2	6	3	None	Parachute	None	Vesicles	2d Division	2	Exchanged and absorbed	
	<i>Chilodon uncinatus</i>	Enriques, 1908	1	1	2	4	2	None	Rod	None	Spindles	1st Division	None	Absorbed	
	<i>Colpidium colpoda</i>	Hoyer, 1899	1	1	2	?	?	None	Vesicular	None	No fusion occurs!!	2d Division	1	Absorbed	
	<i>Cryptochilum nigricans</i>	Maupas, 1888	1	1	?	?	?	None	Rod	?	?	3d Division	7 nuclei fuse to form Mac.?	Absorbed	
	<i>Boveria sub-cylindrica</i>	Stevens, 1910	1	1	2	4	?	None	?	?	?	?	?	?	
	<i>Didinium nasutum</i>	Prandtl, 1906	2-3	2-3	Variable	?	16	8	Parachute	♂ smaller radiations?	Vesicles	2d Division	None	Absorbed	
	<i>Glaucomascintillans</i>	Maupas, 1888	1	1	2	?	?	?	Crescent	?	?	2d Division	None	Absorbed	
	<i>Ichthyophthirius multifiliis</i>	Nerescheimer, 1908	Conjugation phenomenon entirely different from other ciliates												
	<i>Leucophrys patula</i>	Maupas, 1888	1	1	2	?	?	?	Crescent	None	Vesicles	2d Division	None	Absorbed	
	<i>Lionotus fasciola</i>	Prowazek, 1909	1	1	2	?	?	?	Vesicular	None	Spindles	2d Division	1	Thrown out	
	<i>Lionotus fasciola</i> (Loxophyllum fasciola)	Maupas, 1888	1	1	2	?	?	?	Vesicular	None	Spindles	2d Division	None	Absorbed	
	<i>Paramecium aurelia</i>	Hertwig, 1889	2	4	4	?	8-12?	4-6?	Crescent	None	Spindles	2d Division	None	Absorbed	
	<i>Paramecium bursaria</i>	Hamburger 1904	1	1	1	100+	100+	?	Crescent	None	Spindles	2d Division	None	Absorbed	
	<i>Paramecium caudatum</i>	Calkins and Cull, 1907	1	1	2	150+	150+	?	Crescent	♂ smaller	Spindles	3d Division	None	Absorbed	
	<i>Paramecium putrinum</i>	Doflein, 1911	1	1	2	?	?	?	?	None	Spindles	3d Division	3	Absorbed	
	<i>Tracheocerca phoenicopterus</i>	Lebedew, 1908	Conjugation different from other ciliates.												

SUMMARY OF OBSERVATIONS

1. Subject *Uroleptus mobilis*, Engelmann, a ciliate belonging to the family Oxytrichidae, order Hypotrichida of the Infusoria.

2. Treatment. Description of species, pp. 293 to 296; technical methods, pp. 297 to 299; history of the nuclei during division, pp. 299 to 307; during conjugation, pp. 308 to 332; comparisons with other ciliates, pp. 333 to 353.

3. Macronuclei 8 in number. In preparation for cell division these fuse to form one (pp. 299 to 301). Prior to division of the cell this macronucleus divides twice; after division of the cell these four divide once again to form 8 (pp. 301 to 303). Divisions are amitotic.

4. Micronuclei variable in number from 2 to 6. They do not fuse in preparation for cell division but the number is reduced to 2, probably by absorption (pp. 303 to 305). With cell division the 2 nuclei divide. One of the 4 may degenerate or all may divide. In latter case 2 degenerate while 6 divide to form 12, 6 for each daughter cell. Of these 6, one or two may degenerate (pp. 306 to 307). Divisions are always mitotic with 8 single or partially fused chromosomes. Whether chromosome division is transverse or longitudinal could not be determined.

5. Paedogamous conjugation lasts from 28 to 36 hours. The macronuclei are retained throughout the process, but undergo progressive granular disintegration (pp. 308 to 309). They are finally absorbed in the protoplasm and have disappeared on the fourth or fifth day after conjugation (pp. 309 to 310).

6. Four micronuclei is the usual number in conjugants. All, or a part of them only, form first maturation spindles. The prophase stage for these is a characteristic nucleus termed the parachute nucleus, with an intranuclear division center (p. 313). The massed chromatin disperses first as a dense reticulum; chromatin collects at the nodes of this reticulum to form granules $24 \pm$ in number. Eight definite chromosomes may be formed by further fusion (type 2) or the nuclei may divide without such fusion (type 1), $12 \pm$ granules going to each daughter nucleus (p. 314). Whether division is transverse or longitudinal could not be determined (p. 315).

7. The second maturation spindles are usually 2 in number. Each contains 8 chromosomes arranged in 4 pairs. Division separates the members of each pair, resulting in reduction in chromosomes from 8 to 4 (p. 316).

8. All four products of the second division may undergo the third division; or one, or two, may degenerate. The functional pronuclei are always derived from the division of one of these 4, the remainder degenerate (p. 319). The spindles are characterized by 4 chromosomes in the metaphase and anaphase stages, and by long connecting strands in telophase stages (p. 321). The pronuclei are not differentiated in size or shape; the wandering pronucleus is accompanied by a granular 'attraction sphere' of cytoplasmic origin (p. 323).

9. Fusion of pronuclei begins while in the vesicular state; before fusion is complete the pronuclei assume a spindle form which becomes the first division spindle with 8 chromosomes (p. 326).

10. The first two nuclei divide again; one gives rise to the functional micronuclei, the other to one micronucleus which degenerates and to one which enlarges to form the new macronucleus (p. 326). The conjugants separate at this stage.

11. The new nuclear apparatus is formed by 3 divisions of the new macronucleus and two of the micronuclei during the first 6 days subsequent to conjugation and the first division of the ex-conjugant occurs on or about the sixth day.

Columbia University
May, 1918

LITERATURE CITED

- BAITSELL, G. A. 1912 Experiments on the reproduction of the hypotrichous Infusoria. I. Conjugation between closely related individuals of *Stylonychia pustulata*. Jour. Exp. Zool., vol. 13, no. 1.
- BALBIANI, G. 1860 Observat. et expér. sur les phénom. de la reprod. fissipare chez les Infusoires ciliés. C. R. Ac. Sc. Paris, T. 50, p. 1191.
- 1861 Recherches sur les phénom. sexuelles des Infusoires. Jour. de la Physiol., T. 4.
- 1881 Les Protozoaires. Jour. de Micrograph., T. 5.
- BUSCHKIEL, A. L. 1911 Ichthyophthirius multifiliis. Arch. Protist., vol. 21.
- BÜTSCHLI, O. 1888 Protozoa. Bronn's Thierreich. I, part 3.
- CALKINS, G. N. 1912 The Paedogamous Conjugation of *Blepharisma undulans*. Jour. Morph., vol. 23.
- CALKINS, G. N., AND CULL, S. W. 1907 The conjugation of *Paramecium aurelia* (caudatum). Arch. Protist., vol. 10.
- COLLIN, B. 1909 La conjugaison d'*Anoplophrya branchiarum* St. Arch. d. Zool. Exp. et Gén., 5th Series, T. 1.
- DOFLEIN, F. 1911 Lehrb. d. Protozoenkunde. 3rd edition, p. 188 (*Param. putrinum*).
- ENGELMANN, W. 1862 Zur Naturgesch. d. Infusionsthier. Zeit. wiss. Zool., Bd. 11.
- ENRIQUES, P. 1907 La coniugatione e il differenziamto sessuale negli Infusori. Arch. Protist., vol. 9, p. 195.
- 1908 Die Conjugation und sexuelle Differenzierung der Infusorien. Arch. Protist., vol. 12, S. 213.
- FERMOR, X. 1913 Die Bedeutung der Encystierung bei *Stylonychia pustulata* Ehr. Zool. Anz., Bd. 42, p. 380.
- GOLDSCHMIDT, R. 1905 Eireifung, Befruchtung und Embryonalentwick. des *Zoogonus mirus* Lss. Zool. Jahrb. (Anat.), Bd. 21.
- GRUBER, A. 1887 Weitere Beobachtungen an vielkernigen Infusorien. Ber. d. Naturf. Ges. z. Freiburg, Bd. 3, S. 57.
- HAMBURGER, C. 1904 Die Konjugation von *Paramecium bursaria* Foche. Arch. Protist., vol. 4, p. 199.
- HERTWIG, R. 1877 Über den Bau u. die Entwickl. v. *Spirochona gemmipara*. Jen. Zeit. f. Naturges., Bd. 11, S. 149.
- 1889 Über die Konjugation der Infusorien. Abh. d. kgl. Bayr. Akad. d. Wiss. 2Kl., Bd. 17.
- HOYER, H. 1899 Über das Verhalten der Kerne bei der Konjugation des Infusors *Colpidium colpoda* St. Arch. mik. Anat., Bd. 54, S. 95.
- JOHNSON, H. P. 1893 A contribution to the morphology and biology of the Stentors. Jour. Morph., vol. 8, no. 3, p. 467.
- KALTENBACH, R. 1915 Die Conjugation von *Ophrydium versatile*. Arch. Protist., vol. 36, p. 67.
- LEBEDEW, W. 1908 Über *Trachelocerca phoenicopterus*, ein marines Infusor. Arch. Protist., vol. 13, p. 70.

- MAUPAS, E. 1883 Contrib. a l'étude morpholog. et anatomiq. des Infusoires ciliées. Arch. d. Zool. Exp. et Gén., 2nd Ser., T. 1.
1888 Le rajeunissement karyogamique chez les ciliés. Arch. d. Zool. Exp. et Gén., 2nd. Ser., T. 7, p. 149.
- NERESCHEIMER, E. 1908 Fortpflanz. eines parasitischen Infusors (Ichthyophthirius). Sitz. Ber. Ges. Morph. Physiol. in München, Bd. 23.
- POPOFF, M. 1908 Die Gametenbildung u. d. Conjugation von Carchesium poly-pinum. Zeit. w. Zool., Bd. 89, S. 478.
- PRANDTL, H. 1906 Die Konjugation von Didinium nasutum O. F. M. Arch. Protist., vol. 7, p. 229.
- PROWAZEK, S. 1899 Protozoenstudien. (Bursaria truncatella and Stylonychia pustulata). Arb. a. d. Zool. Inst. Univers. Wien., Bd. 2, S. 195.
1909 Conjugation von Lionotus. Zool. Anz., Bd. 34, S. 626.
- STEVENS, N. M. 1910 The chromosomes and conjugation in Boveria subcylindrica var. concharum. Arch. Protist., vol. 20, p. 126.
- WALDEYER, W. 1888 Über Karyokinese u. ihre Beziehungen z. d. Befruchtungsvorgängen. Arch. Mik. Anat., Bd. 32.
- WILSON, E. B. 1899 The cell in development and inheritance. New York, 1899.

Resumido por el autor, W. J. Crozier.

Sobre el uso del pié en algunos moluscos.

El presente trabajo añade un nuevo tipo de locomoción (el "salto" de *Xenophora*) a los conocidos entre los gasterópodos; suministra un segundo buen ejemplo de progresión pedia aritmética (*Conus*) y agrega tres especies de Chiton (*Ischnochiton*, *Acanthochites*, *Tonica*) a la lista de los moluscos conocidos que se mueven por medio de ondas pedias retrógradas. *Ischnochiton* se mueve hacia atrás, conservando el caracter retrógrado de sus ondas pedias, con considerable libertad y por distancias apreciables. *Ischnochiton* también presenta un "galope" como el de *Helix*, el cual es independiente de las ondas pedias.

Translation by Dr. José F. Nonidez,
Columbia University.

ON THE USE OF THE FOOT IN SOME MOLLUSKS¹

W. J. CROZIER

Bermuda Biological Station

ONE FIGURE

From time to time I have had the opportunity of observing the method of locomotion in some mollusks which appear not to have been studied previously from this standpoint; since these observations add somewhat to our knowledge of the distribution and variety of pedal movements in chitons and in gastropods, they may be briefly recorded.

Ischnochiton purpurascens Ad., *Acanthochites spiculosus* Reeve,² and an undetermined species of *Tonicia* were found to agree with the two chitons whose locomotion has hitherto been observed, namely, *Acanthochites fascicularis* (by Vlès, '07) and *Chiton tuberculatus* (by Parker, '11), since they all progress anteriorly by means of monotaxic retrograde pedal waves. They add, therefore, to the conclusion (Parker, '11) that a certain mode of pedal activity may be of general occurrence throughout single morphologic groups of creeping mollusks. Similarly, a small species of *Onchidiella* I find to move by means of direct monotaxic waves, like *Onchidium* (Vlès, '07; Parker, '11); in this *Onchidiella* the foot is quite small, 1.2 mm. x 3 mm., and usually one, but sometimes two, waves are present on the foot at one time. Three species of *Crepidula* which I have observed

¹ Contributions from the Bermuda Biological Station for Research, No. 100.

² This species or one of its so-called 'varieties.' Some of the 'varieties' recorded in the taxonomic literature of the chitons are nothing more than 'color varieties' induced by the conditions of food supply, as I know from studies of *Chiton tuberculatus*. The *Acanthochites*, now for the first time recorded from the Bermuda area, had brownish spinules, not greenish, as is recorded for some varieties of *A. spiculosus*.

move, as Parker ('11) has described for *C. fornicata*, by means of direct waves. In one of these crepidulas the use of the whole foot as a sucker was very clear, and in fact sometimes during creeping the circumference only of the foot was in contact with the substratum (of smooth glass).

Ischnochiton was of particular interest, as it moved in a posterior direction with great freedom. The animal is long and narrow (15 mm. x 5 mm.), the foot being about 2 mm. broad. When disturbed it presses the girdle firmly to the substratum and elevates the midregion of the body, in this way exerting suction and thereby adhering tightly to the rock or other surface. The girdle is in fact the prime 'holdfast' organ in all the chitons, and not the foot. During the process of exerting suction the foot of *Ischnochiton* may be more or less clearly removed, in its mid portion, from all contact with the supporting surface, and it exhibits also a type of reaction which is not without special interest: the foot shows a decided tendency to fold together longitudinally, a deep depression appearing along its middle, giving it a 'ditaxic' appearance. Usually, in creeping, one retrograde pedal wave is present on the foot. *Ischnochiton* does not carry out pivoting movements so readily as do some other chitons, but in contrast with them does move posteriorly in a 'spontaneous' way for considerable distances, although it does subsequently pivot or turn in a circular path if forced to move by continuous directive stimulating agencies.³ During posterior locomotion the retrograde character of the pedal wave is retained, as Olmsted ('17) found to be true in *Chiton tuberculatus*. Olmsted forced *C. tuberculatus* to creep posteriorly by attaching the posterior end of the foot to a glass plate. *Ischnochiton*, however, moves

³ This type of behavior is of special interest for the analysis of the phototropism of *Ischnochiton*. It might be remarked that in the present species without careful inspection there is some difficulty in distinguishing in dorsal view anterior and posterior ends, owing to the indistinct sutures between the valves. Hence it would appear that the lack of pronounced external signs of polarity is correlated with ready locomotion in either anterior or posterior direction. However, there is not the slightest reason to suspect that any ethological significant is involved in this correlation.

posteriorly, in a straight line, away from a source of light, and its backward creeping may therefore be studied with ease.

When *Ischnochiton* is creeping ventral side uppermost on a slip of glass, it sometimes (and almost always if stimulated by strong light) releases the anterior part of the foot, until finally it remains attached only by means of about 2 sq. mm. of foot surface. Hence it would appear that here, as in *Chiton* (Parker, '14), the foot sucks locally.

In moving anteriorly away from a strong light, the anterior part of the body is sometimes completely freed from the substratum, then brought back to it, and then attached at the anterior end of the foot, initiating in this way a 'giant wave,' which, traveling the length of the foot, gives the appearance of a 'gallop,' probably analogous to that of *Helix dupetithouarsii* and of *Aplysia* (Parker, '11, '17), since it is retrograde, 'monotaxic,' and involves the body musculature generally, not merely the foot. Five or six waves of this character, one at a time, but sometimes not quite coincident with the normal pedal wave (which may therefore be seen independently), may be carried out in succession.

In these chitons the essential mechanism of progression is undoubtedly that outlined by Parker ('11) and illustrated on a gross scale by the movements of *Aplysia californica* (Parker, '17). I have been able to verify this idea for a ditaxic foot, that of *Turbo*. This mollusk also has a retrograde pedal wave which, like that of *Tectarius*, is alternate ditaxic, anteriorly, but may become opposite ditaxic after the first third of the foot has been passed over. The foot is divided in the midline by a distinct groove. When creeping on a vertical surface in air, it can be clearly seen that the anterior region of one side of the foot is first lifted 3 or 4 mm. from the surface, extended, and attached at the anterior end; then the anterior portion of the opposite side is moved similarly. This snail is an active creeper. The foot measures 17 mm. x 25 mm., and the movements on its surface can easily be followed. In creeping under water the pedal waves are minute and frequently opposite ditaxic over the whole

length of the foot. In air, however, they are clearly alternate ditaxic at the anterior end, corresponding to Parker's ('11) analogy with the movements of a 'person in a sack walk.' In Trochus, where the pedal waves are ditaxic but direct, Gosse ('65, p. 8) long ago gave a somewhat accurate statement of this matter and employed the same comparison: "If your own two feet were enclosed in one elastic stocking, your own progress would appear very much like that of the Trochus," showing that he had correctly appreciated the essential mechanical features of this mode of progression.

The foot of *Conus agassizii* is relatively large and bulky. In full extension it measures 2 cm. x 4.5 cm., tapering somewhat posteriorly, but abruptly truncate at the anterior end. About 1 cm. from the anterior margin of the foot, in the midline, is lo-



Fig. 1. Diagrammatic cross-section of the foot of *Conus*, showing the way in which the foot is embedded in the mud. $\times \frac{2}{3}$.

cated the opening of the pedal gland. The ventral pedal surface can be pressed out completely in contact with a smooth surface, but usually this is not done. As collected, the shell is commonly found in a horizontal position partially imbedded in the mud, and it seems that the very distinct epipodial ridge has a special functional significance for locomotion when the animal is thus partly buried, although, as just stated, the distinction between epipodium and foot proper can be obliterated. The control of the foot is in some respects distinctly bilateral. If one side of the foot be touched lightly, that side as a whole is contracted toward the shell aperture. This mode of response (seen also in the fact that, if the shell be lightly pressed upon from above, a distinct depression appears along the midline of the foot, even though it may not be retracted) is undoubtedly connected with the fact that the shell aperture is long and narrow,

so that the foot must be folded together longitudinally before it may be withdrawn into the shell. When disturbed sufficiently to induce retraction of the foot, the right half of this organ is retracted first.

Withdrawal of the foot is very readily induced by even moderate stimulation; this is correlated with the condition that the foot is never very firmly attached to a substratum. Only with difficulty can a *Conus* attach the foot to a glass surface firmly enough to right itself when the shell aperture has been placed dorsally. Nor can the animal usually creep up a smooth surface inclined at an angle of more than 60° . The foot is conspicuously a burrowing organ, and is in this respect very efficient. At extremely low tides, *Conus* may be found on sandy beaches burrowing vertically into the sand, the spire being uppermost. This is accomplished by means of a clockwise rotation of the whole animal, the foot doing the work of excavation.

In spite of the fact that the foot of *Conus* is large enough to make observation an easy matter,⁴ and of the further fact that the positive phototropism of the animal may be used to induce it to creep with some rapidity (1.3 cm. per minute at 19°), neither when the animal is creeping in air nor when submerged in seawater have I been able to distinguish wave motions upon the pedal surface. In view of the powerful musculature of the foot and of its bilateral control in retraction, such movements might have been expected. Locomotion is, however, accomplished by a smooth gliding movement. No cilia can be demonstrated upon the foot, although there is abundant mucus, through which adhesion is mainly effected. Distinct variations in the rate of movement on the foot can, however, be detected along the anterior edge and at the sides. The foot is marked by longitudinally disposed pigment flecks, which would make the detection of rhythmic waves relatively easy. There seems no doubt, then, that *Conus* affords a second instance of that type of pedal locomotion which Parker ('11, p. 158) characterized as arhythmic, with

⁴ It was necessary, of course, to study the locomotion by means of observations from beneath, the animals being in a broad glass dish.

Alectrion (*Ilyanassa*) as example. Alectrion inhabits bottoms of soft mud, very much like those frequented by *Conus* so far as the physical consistency of the substratum is concerned; but on the other hand, *Conus* and *Turbo* (*vide ante*) are taken in company on the same bottom, yet have quite different methods of progression: hence little significance can perhaps be attached to this correlation; *Turbo* however, does not burrow as *Conus* does.

The genus *Xenophora* comprises snails which exhibit the interesting habit of reinforcing their shell with the dead shells and skeletons of other organisms. To the rough surface thus produced, various living mollusks, corals, ascidians, worms, algae, and so forth become attached, resulting in a shell mass which weighs in different cases from 150 to nearly 300 grams. The foot itself is relatively small, measuring, when spread out for attachment, about 2 cm. x 2 cm., whereas the circumference of the depressed conical shell-mass may be as much as 12 to 15 cm. There is correlated with this disparity between the size of foot and the size and weight of the shell a type of locomotion which is somewhat remarkable and finds no place in the present classification (*cf.* Olmsted, '17) of pedal operations among gastropods.

Xenophoras of apparently two species were obtained upon muddy bottoms in 5 to 8 fathoms. The method of locomotion must be observed from below, as the animal cannot creep up an inclined surface (nor can it right itself after being turned over). The foot is, when unattached, of a roughly dumb-bell outline, and in life is covered with a thin layer of mud held by a slime secretion. At its posterior end it carries the horny operculum. The anterior part of the foot is compact and tough, with a firm anterior margin. When the animal begins to creep, this anterior part is the first to be applied to the substratum. Before the foot is so applied, however, the anterior part of the animal's body is thrust forward or to one side as far as possible. The foot is then attached, beginning at its anterior margin and continuing with a smoothly 'flowing' motion until the whole foot is in contact, but there are no perceptible pedal waves. The central portion of the foot is then pulled sharply away from the substratum, forming a very efficient sucker, since the anterior

and posterior ends and the lateral margins remain firmly attached. The body musculature then contracts, pulling the whole shell forward into such a position that the aperture is immediately over the foot. A 'step' of 3 cm. can thus be taken in about one minute. Usually, when a freshly collected specimen is used, five or six steps in a more or less continuous series occur in succession. The direction of progression is readily altered by the body's being extended at an angle, previous to the attachment of the foot. I did not obtain any evidence of backward steps. The action of the foot as a sucker is clearly seen when the animal is at rest, in which case the foot is not attached to the substratum at all, but its middle third is distinctly arched, as it is in preserved specimens.

This type of locomotion is not exactly comparable with that of a measuring worm, although in a sense these movements are not dissimilar. The creeping of *Xenophora* under normal conditions is probably rhythmic, but involves the body musculature generally, and is in that sense non-pedal, although the suction of the foot is essential to progression. Perhaps this type of locomotion is for the present better classed with the 'gallop' of *Helix* (Carlson) and of *Ischnochiton*, although here again there are distinctive features.

SUMMARY

This paper adds a further type of locomotion to those known among gastropods (the 'looping' of *Xenophora*), provides a second good example of arhythmic pedal progression (*Conus*), and adds three species of chitons (*Ischnochiton*, *Acanthochites*, *Tonicia*), to the list of those known to move by means of retrograde pedal waves. *Ischnochiton* moves posteriorly, preserving the retrograde character of its pedal waves, with considerable freedom and for appreciable distances. *Ischnochiton* also exhibits a 'gallop,' like that of *Helix* (Carlson), which is independent of the pedal waves.

LITERATURE CITED

- Goss, P. H. 1865 A year at the shore. London, xii + 330 p., 36 pl.
- OLMSTED, J. M. D. 1917 Notes on the locomotion of certain Bermudian mollusks. Jour. Exp. Zoöl., vol. 24, p. 223-236.
- PARKER, G. H. 1911 The mechanism of locomotion in gastropods. Jour. Morph., vol. 22, p. 155-170.
- 1914 The locomotion of Chiton. Contrib. Bermuda Biol. Sta. vol. 2, no. 31, 2 pp.
- 1917 The pedal locomotion of the sea-hare *Aplysia californica*. Jour. Exp. Zoöl., vol. 24, p. 139-145.
- VLÈS, F. 1907 Sur les ondes pédieuses des Mollusques reptateurs. Compt. rend. Acad. Sci., Paris, T. 145, p. 276-278

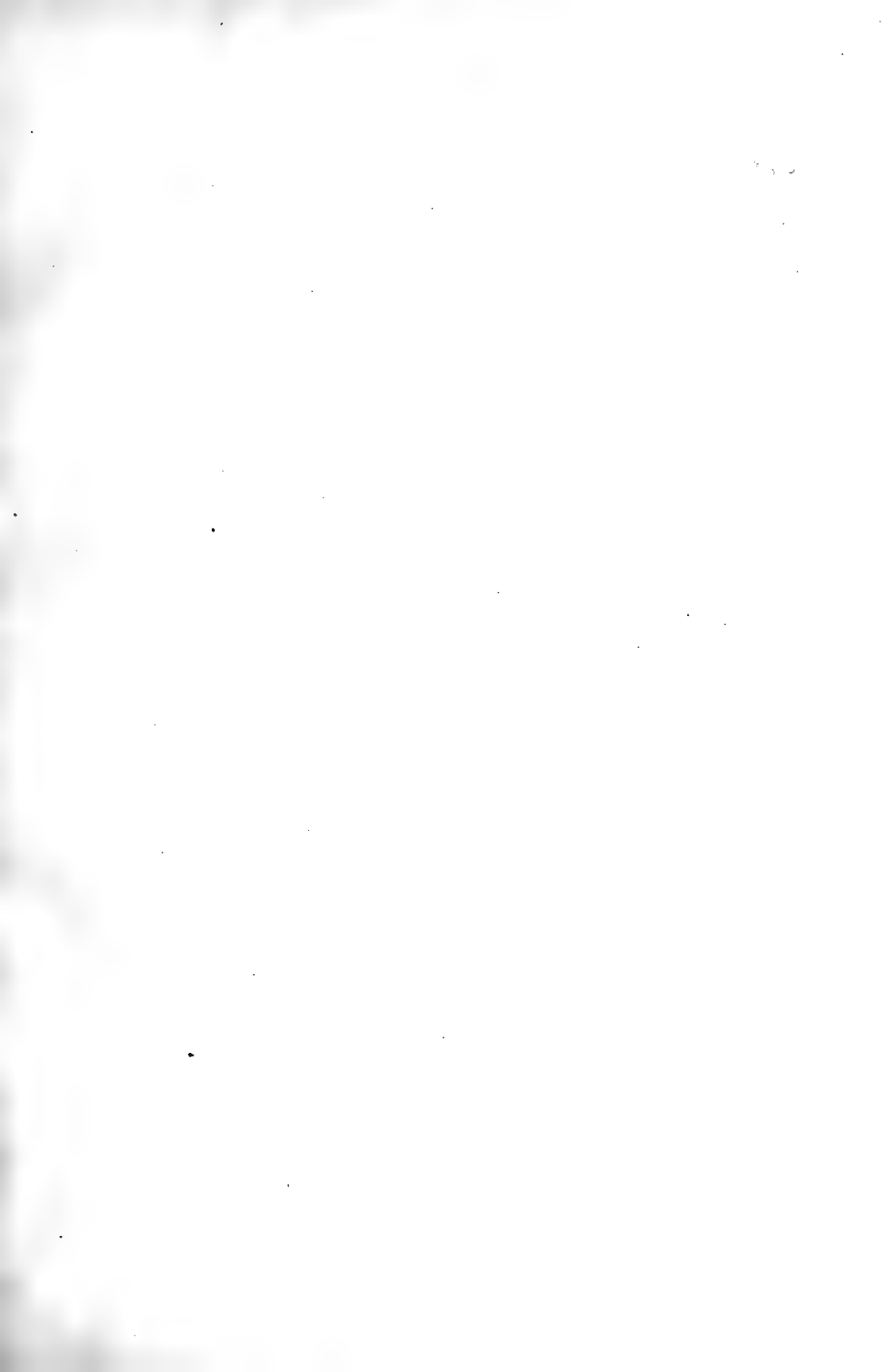

Resumido por el autor, S. O. Mast.

Reversión en la orientación hacia la luz en las formas coloniales
Volvox globator y *Pandorina morum*.

1. *Volvox* y *Pandorina* son generalmente positivos en la luz débil y negativos en la luz intensa, si están adaptados a la oscuridad; pero si están adaptados a la luz, lo contrario sucede a veces. 2. Si las colonias adaptadas a la oscuridad se exponen a una iluminación constante, al principio se comportan como neutrales, después se transforman en positivas, más tarde en negativas y finalmente en positivas otra vez. Cuánto más intensa es la iluminación más corto es el tiempo necesario para pasar por todos estos estados, pero en tales intensidades es necesaria mucha más energía para producir los cambios en la orientación que en una iluminación menos intensa. 3. La reversión depende en cierto grado de la cantidad de energía recibida, pero bajo ciertas condiciones parece depender principalmente de la duración del cambio de iluminación. 4. La reversión no está regida por la fotosíntesis. La luz roja y la amarilla, en las cuales la fotosíntesis se verifica con relativa intensidad, producen pocos efectos sobre la reversión, mientras que en la luz verde y en la azul, en las cuales la fotosíntesis es relativamente débil, son casi tan efectivas como la luz blanca. 5. Los rayos que poseen la mayor eficiencia estimulante (azul y verde) son los más potentes en la producción de la reversión. 6. El sentido de la orientación depende del estado fisiológico de las colonias, así como de la constitución del medio de cultivo. Depende también de la edad de las colonias. Las colonias jóvenes son más aptas para ser negativas que las de más edad. 7. La reversión está probablemente asociada con cambios en la permeabilidad.

Translation by Dr. José F. Nonidez,
Columbia University.

REVERSION IN THE SENSE OF ORIENTATION TO LIGHT IN THE COLONIAL FORMS, VOLVOX GLOBATOR AND PANDORINA MORUM

S. O. MAST

*Marine Biological Laboratory, Woods Hole, and the Zoological Laboratory of the
Johns Hopkins University*

TWO FIGURES

CONTENTS

Introduction.....	367
Materials and methods.....	368
Relation between illumination and reversion in orientation.....	369
Relation between reversion in orientation and the quantity of light energy	375
Relation between reversion in orientation and the time rate of change in illumination.....	377
Effect of the age of the colonies on reversion.....	378
Effect of photosynthesis on reversion.....	379
Effect of temperature on reversion.....	382
Effect of chemicals on reversion.....	383
Discussion.....	385
Summary.....	388
Literature cited.....	390

INTRODUCTION

The literature on reversion in the sense of orientation was briefly reviewed in a preceding paper which dealt primarily with the effect of chemicals on the sense of orientation to light in Spondylomorom (Mast, '18). The results presented in that paper indicate that reduction in alkalinity, increase in some anesthetics, increase in temperature and decrease in illumination all have the same effect on the sense of orientation, causing photonegative specimens to become photopositive. They also indicate that the same change in the sense of orientation may occur without any appreciable change in the environment. On the basis of these results it was concluded that reversion in the sense

of orientation is probably due to some specific change or state in the physiological processes of the organisms which can be induced by any one of the factors mentioned, i.e., alkalis, anesthetics, temperature, or light.

In this paper we shall deal primarily with the effect of illumination on the sense of orientation, but we shall also briefly consider some other factors.

MATERIALS AND METHODS

The specimens used in this investigation were all collected at Woods Hole in a fresh-water pond. *Volvox* appeared early in July and continued for nearly a month. It was found only at the edge of the pond in a few small puddles, but in these it was very abundant most of the time. *Pandorina* appeared early in August, shortly after *Volvox* had disappeared, and it continued nearly to the end of the month. It was not found in all parts of the pond, but was much more widely distributed than *Volvox* and equally abundant.

Pandorina thrived much better in the laboratory than *Volvox*, but neither lived more than a week or two. Most of the observations were consequently made on specimens within a few days after they had been collected.

The observations were all made in a large basement dark-room in which there was remarkably little variation in temperature throughout the season and practically none during the time occupied by any given experiment. The dark-room was so fitted up that either natural or artificial light could be used. Aside from ordinary electric lamps, there were two gas-filled stereopticon lamps, one 250 and the other 1,000 watt. These two lamps were mounted in an adjoining room from which light was admitted to the dark-room through a hole in the wall, which could be varied in size (fig. 1). Thus a horizontal beam of light of the desired size was produced. This extended through the dark-room parallel with the surface of a series of black tables 7 m. long. The two lamps could readily be interchanged in position. By this means and by varying the distance between the organisms

and the lamps it was possible to obtain quickly a wide range in illuminations. The beam of light, before it entered the dark-room; passed through a heat-screen consisting of a Pfeifer warming-stage containing distilled water. This screen was so arranged that a stream of water continuously flowed through it so as to prevent excessive heating. The observations were practically all made in six rectangular glass aquaria which were designated observation aquaria. These aquaria were 2.7 cm. wide, 2.7 cm. long and about 1 cm. deep. They were constructed from pieces of the best-quality microscope slides and Khotinsky sealing-wax.

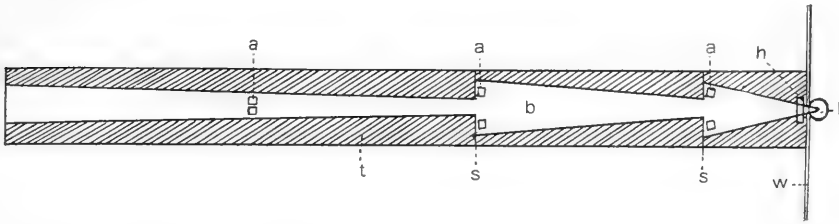

Fig. 1 Diagram representing arrangement of apparatus. *a*, rectangular observation aquaria; *l*, gas-filled stériopticon lamp; *b*, beam of light; *w*, wall between dark-room and room containing lamp; *h*, heat-screen containing running distilled water or saturated solution of chlorophyll in 96 per cent alcohol; *t*, dead black table, 7 m. long; *s*, light-screens.

RELATION BETWEEN ILLUMINATION AND REVERSION IN ORIENTATION

Both *Volvox* and *Pandorina* are very sensitive to light and they orient fairly precisely. Like a considerable number of other similar organisms, they have ordinarily been found to be positive in weak and negative in strong light. This has often been observed in previous work (Mast, '07, '11, '18) and it was repeatedly observed in the experiments performed in connection with this work. The following detailed description of a typical series of observations clearly illustrates the relation between this change in the sense of orientation and the intensity of illumination.

On August 8, 4.40 P. M., colonies of *Pandorina* which had been in darkness for nearly four days were exposed in strong direct sunlight. At first they were very inactive and there was no indi-

cation whatever of orientation. But after approximately one minute it could be seen clearly that they were swimming slowly from the light. Gradually they became more and more active, and as they became more active they became more strongly negative, until at 4.50 P.M. they were swimming rapidly and fairly directly from the source of light. At 4.55 P.M., they were moved 4 m. from the window and placed in diffuse light. Here they promptly became strongly positive. They were then returned to direct sunlight near the window, when they again promptly became strongly negative. These changes in illumination were repeated several times and the same results were obtained each time.

It is thus evident that strong illumination tends to make these organisms negative and that weak illumination tends to make them positive. Under certain conditions, however, just the opposite holds. In previous work this was observed only once (Mast, '07, p. 165). In the observations now under consideration it was, however, repeatedly observed both in *Volvox* and in *Pandorina*, and the conditions under which it occurs have been discovered. This is demonstrated by the results obtained in the observations described below:

On July 13, *Volvox* colonies were collected at 7.30 A.M., in a pool fully exposed to direct sunlight. They were taken to the laboratory, and put into two finger-bowls. One bowl was put into total darkness, the other was exposed in strong diffuse daylight. Thus one group of colonies remained light-adapted, while the other group became dark-adapted. At 3 P.M., light-adapted colonies and dark-adapted colonies were put, respectively, into each of six rectangular observation aquaria. These were then exposed in the dark-room in light from the 250-watt lamp, one aquarium containing dark- and one containing light-adapted colonies side by side in each of the following illuminations, 62.5 m.c., 250 m.c., and 4,000 m.c. (fig. 1). The dark-adapted colonies were strongly positive in all the illuminations and the light-adapted were negative in all, but they were clearly more strongly negative in the lowest intensity than they were in the highest. In 4,000 m.c. they were only slightly negative; in 250 m.c.

they were clearly more strongly negative. One of the aquaria was then moved nearer to the lamp into an illumination of 16,000 m.c. The colonies immediately became positive, although not strongly. The dark-adapted colonies were not tested in this intensity, but judging from results obtained in numerous other experiments, one of which is described in detail in the preceding pages, they probably would have been negative.

These results seem to indicate that long exposure in strong light produces changes in *Volvox* which make it negative in weak and positive in strong light. The following results obtained in observations on *Pandorina* support this conclusion.

August 4 was a bright clear day. At 11.30 A.M., *Pandorina* was taken in abundance from a small puddle at the edge of the collecting pond. This puddle had been fully exposed to direct sunlight all forenoon. The specimens collected were taken to the laboratory and some of them were immediately exposed to direct sunlight in an observation aquarium, surrounded by water which was changed from time to time so as to prevent excessive rise in temperature. They were strongly positive and remained so. At 3 P.M. the aquarium was placed on the stage of a microscope in direct sunlight, and a beam of direct sunlight, concentrated by means of the concave mirror, was thrown up through the aquarium. The colonies promptly aggregated in this extremely intense illumination forming a dense mass. At 5 P.M. many colonies were lying on the bottom inactive, but all the rest were still fairly strongly positive. These results indicate clearly that under certain conditions *Pandorina* cannot be made negative by exposure to intense light. The specimens used in this experiment were unfortunately not tested in weaker light, but judging from the results of other observations they probably would have been negative. For example, at 3 P.M., August 11, colonies adapted to strong diffuse light were exposed in an illumination of 16,000 m.c. They were inactive for a few moments and then became definitely positive. The illumination was then considerably reduced. The colonies continued to proceed toward the light, but only for a few moments, when practically all of them turned through 180 degrees and proceeded from the light.

This was repeated many times and the same results were persistently obtained. Thus it is clear that, under certain conditions, *Pandorina* is definitely positive in strong and definitely negative in weak light. What are the conditions under which this occurs?

It was repeatedly observed that colonies exposed in strong diffuse light, in which they were strongly positive, usually become negative in the evening at the approach of twilight. This suggests that the phenomena may be associated with the night and day variations in illumination and that it may be analogous to the so-called sleep movements in higher plants. The fact, however, that it does not occur in dark-adapted colonies and in colonies which have been exposed to relatively weak light does not support this contention.

The physiological condition in which the colonies are positive in strong and negative in weak light is, in all probability, dependent upon the amount of light energy received in the immediate past as the following results indicate.

At 8 A.M., August 23, dark-adapted specimens in observation aquaria were exposed in illuminations of 16,000 m.c., of 4,000 m.c. and in lower intensities. Twenty minutes later, 8.20 A.M., a few of the small colonies in 16,000 m.c. were negative, the rest were all strongly positive. The aquarium was left in this illumination in the dark-room and observations were made every hour. The temperature remained practically constant throughout the day. At 9 and 10 A.M., the reactions were practically the same as they had been at 8.20 A.M. At 11 A.M. practically all of the small colonies and a few of the large ones were negative. More and more continued to become negative, until at 3 P.M., practically all were negative. At 4 P.M. a few of the colonies were scattered, all the rest were negative. From this time on gradually more and more became scattered. At 7 P.M. many of the colonies were scattered, some were negative and some were distinctly positive. At 8 P.M. there were more positive colonies, and at 9 P.M., when the experiment was closed, there was a large positive collection.

In the aquarium in 4,000 m.c. the colonies were at first all positive. An hour later, 9 A.M., a few were negative. From

this time on gradually more became negative, until at 6 P.M. nearly all were negative. At 9 P.M., when the experiment was closed, more of the colonies were scattered than earlier, but there were no positive colonies. In 62.5 and 250 m.c. many of the colonies became negative, but some of them remained positive throughout the experiment. In all intensities lower than 62.5 m.c., none of the colonies became negative at all.

This experiment demonstrates that a certain intensity of light is necessary to induce reversion in the sense of orientation from positive to negative, that the time required depends upon the intensity, and that in strong illumination the colonies, after having become negative, become positive again if they are exposed long enough. Whether or not they continue positive indefinitely after the last reversion was not ascertained, nor was it ascertained in this experiment whether or not they would have been negative in low illumination after they had become positive in high. But in all probability these colonies would have remained positive in strong and would have been negative in weak illumination indefinitely, for negative orientation in weak light was never observed in dark-adapted colonies; it was observed only after long exposure to intense light, and continued exposure to such light failed to make the colonies negative after they had once become positive in this light.

The changes that occur in the reactions of *Pandorina* as indicated by the results described above may be visualized by means of a graph presented in figure 2. This graph indicates that dark-adapted colonies of *Pandorina* when first exposed to light are neutral for a short time, i.e., they do not orient (fig. 2, *a-b*), that they then become positive, increasing rapidly to a maximum (*b-c*) then decreasing slowly to a minimum (*c-d*), after which they become negative, passing through a maximum at *e*, and that they finally become positive again (*f-g*). It is probably during this last period that the colonies are positive in strong and negative in weak light.

As previously stated, this reaction is found only in light-adapted colonies, never in dark-adapted ones. What, now, is the difference in different illuminations in the reaction of colonies in these two states?

Numerous observations were made to ascertain this. In all of these observations dark-adapted colonies were put into one rectangular aquarium and light-adapted ones into another. These two aquaria were then placed side by side at the desired distance from the source of light and the reactions of the colonies compared. Frequently three sets of such aquaria were exposed in different illuminations at the same time.

The results obtained appear to be extremely contradictory. Usually the light-adapted colonies were found to be more strongly

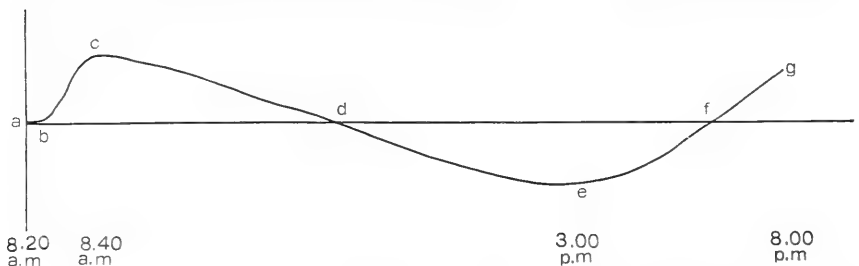

Fig. 2 Graph representing changes in the sense of orientation in dark-adapted *Pandorina* exposed to constant illumination of high intensity. The horizontal axis represents time, the vertical axis degree of orientation, above the base line positive, below the base line negative. The graph indicates that *Pandorina* was first neutral (*a-b*) then became positive, increasing to a maximum (*b-c*) then decreasing to a minimum (*c-d*), after which it became negative, increasing to a maximum (*d-e*), then decreasing to a minimum (*e-f*), after which it again became positive (*f-g*). After the colonies reach the last stage they are probably in a state such that they are positive in strong and negative in weak illumination.

positive in strong and less strongly positive in weak light than the dark-adapted ones, but in many instances precisely the opposite was found to be true and in some there was no appreciable difference in the reaction. Moreover, in a given intensity, e.g., 4,000 m.c., the light-adapted were in some instances more strongly positive and in others less strongly positive than the dark-adapted colonies. How can these puzzling results be explained?

Dark-adapted specimens, as we have seen, are frequently neutral when first exposed to light, then they become strongly positive and later negative. If they are in the strongly positive stage when their reactions are compared with those of light-

adapted specimens, they are likely to be more strongly positive than the light-adapted specimens; whereas if they are in the negative stage they will be found to be less strongly positive. Other contradictory features in these results can be similarly explained.

The cause of the passage through the various stages mentioned above, especially the return to positive orientation after having been negative, is not known. It may be associated with what is ordinarily called acclimatization or adjustment or with some sort of a periodicity. However this may be, reversion is undoubtedly associated with physiological processes or states and these processes are dependent both upon time and intensity of illumination. This the evidence presented clearly indicates. How are these processes related to the amount of light energy received?

RELATION BETWEEN REVERSION IN ORIENTATION AND THE QUANTITY OF LIGHT ENERGY

The relation between reversion and the amount of light energy received was ascertained as follows: Colonies of *Pandorina* adapted to darkness or to weak light were put into each of seven observation aquaria. These were then exposed in various intensities of light from the 1,000-watt lamp as indicated in table 1. Observations were then made, first at intervals of thirty minutes and later at intervals of one hour. After each observation the position of the colonies in each aquarium was recorded. From these records the approximate time at which reversion occurred in each intensity was ascertained. The results thus obtained appear in table 1.

When first exposed the colonies in all of the aquaria were neutral and relatively inactive. Gradually they became more and more active, and as they became more active they began to swim toward the side of the aquarium nearest the source of light, where in the course of several minutes practically all had collected in a dense mass. This occurred first in the aquarium in the highest and last in that in the lowest illumination. Later

the colonies began to scatter, evidently becoming neutral again. Thus they remained for some time, then they became negative, and finally collected along the side of the aquarium farthest from the source of light as definitely as they had formerly collected on the opposite side. This again occurred first in the highest and last in the lowest illumination.

In all of the aquaria the smaller colonies invariably became negative before the larger ones. Thus there was often found in

TABLE 1
Relation between time of exposure, intensity of illumination and reversion in orientation

	INTENSITY OF LIGHT IN METER-CANDLES	TIME OF DAY REVERSION OCCURRED	TIME IN HOURS REQUIRED TO INDUCE REVERSION	ENERGY IN METER-CANDLES HOURS REQUIRED TO INDUCE REVERSION
August 22. Specimens which had been in weak light several days	16,000.0	3.45 P.M.	5	80 000
	4,000.0	4.45	6	24,000
	1,000.0	5.45	7	7,000
	250.0	6.45	8	2,000
	111.0	6.45	8	888
	27.7	6.45	8	444
	20.4	(?)	?	160(?)
August 23 Same specimens after having been in darkness overnight	16,000.0	3	7	112,000
	4,000.0	4	8	32,000
	1,000.0	7	10	10,000
	250.0	8	11	2,750
	111.0	9(?)	13(?)	1,443(?)
	27.7	9	No reversion	
	20.0	9	No reversion	

aquaria a very definite positive collection and at the same time an equally definite negative collection. Later, however, practically all of the colonies became negative, and the record in the table indicates the time when this occurred in each aquarium.

The table mentioned contains the results obtained in two experiments made on two successive days with the same organisms. By referring to this table it will be seen at once that reversion from positive to negative orientation depends upon the intensity of illumination and upon the time of exposure, but that the energy

required to induce reversion varies with the intensity of the illumination and with the condition of the colonies. In one experiment it required in all intensities much more energy than it did in the same intensities in the other and in both experiments it required much more energy in the higher than in the lower intensities. In one experiment no reversion was observed in illuminations below 250 m.c., and longer exposure probably would not have induced it, for at the close of the experiment, 9 P.M., the colonies were inactive. In the other experiment reversion was observed, to some extent, in the lowest illumination tested, 20.4 m.c. The question as to whether or not it occurs in all intensities that induce positive orientation is consequently not definitely settled.

Why it requires more energy to induce reversion from positive to negative orientation in strong than it does in weak light is not clear. It is, however, well known that in *Euglena* and *Volvox* heat and light energy have opposite effects on reversion (Mast, '11, p. 300). The same is true for *Pandorina* as we shall demonstrate later. Now, a certain amount of light which is absorbed is doubtless transformed into heat. This probably occurs in all illuminations in the same proportion, but in the lower illuminations it occurs so slowly that radiation may have relatively a much greater effect than in the higher. Consequently, the heat produced would be more effective in the higher illuminations than in the lower, and since heat tends to make the colonies positive, it would require more light energy to overcome its effect in the higher than in the lower illuminations. The value of this suggestion could doubtless be ascertained by studying the effect of different regions in the spectrum on reversion.

RELATION BETWEEN REVERSION IN ORIENTATION AND THE TIME RATE OF CHANGE IN ILLUMINATION

In the experiments just discussed, it required to induce reversion, sufficient time to indicate that it is dependent upon the quantity of energy received. Under certain circumstances, reversion is, however, of such a nature that it appears to be asso-

ciated with the time-rate of change in illumination rather than with the quantity of light. For example, on August 8 colonies of *Pandorina* which had been in darkness four days were exposed to direct sunlight at 4.40 P.M. They were inactive for about one minute, then they began to swim, slowly at first and gradually more and more actively, and in practically every case from the light. They were definitely negative. The observation aquarium was now moved 4 m. from the window. Here the colonies were strongly positive. This change in illumination was repeated several times with the same results. The aquarium was then exposed in direct sunlight near the window a few centimeters from the diffuse light. The colonies soon began to swim rapidly from the light. The microscope was then carefully moved into the diffuse light without changing the distance from the window. The colonies immediately became strongly positive, but after they had proceeded toward the window about 1.5 c.m., they became neutral, and approximately one minute later they were strongly negative again. The aquarium was now returned to direct sunlight. The colonies remained negative. They were then again moved into diffuse light where they immediately again became strongly positive, than neutral and later negative. This change in illumination was repeated many times and the same results were always obtained.

Now, the reversion from negative to positive orientation observed in this experiment, after sudden reduction of intensity, was in all probability dependent upon the time-rate of change in illumination, for without any further change the colonies, in the course of about one minute, again became negative. This seems clearly to indicate that if the reduction had consumed sufficient time there would have been no reversion.

EFFECT OF THE AGE OF THE COLONIES ON REVERSION

In the preceding section it was pointed out that in the experiments on the relation between the intensity of the illumination the smaller colonies of *Pandorina* invariably became negative before the larger ones did. No observations in reference to this

were made on *Volvox*, but it was repeatedly observed in various cultures of *Pandorina*, especially in those left uncovered for some days, permitting evaporation.

Whether or not the younger colonies in dark-adapted cultures exposed to light became active and positive before the older ones was not ascertained.

EFFECT OF PHOTOSYNTHESIS ON REVERSION IN THE SENSE OF ORIENTATION

It is well known that acids added to the culture solution tend to make *Volvox* and similar organisms positive in their reactions to light and that under certain conditions low illuminations also tend to make them positive, while high illuminations tend to make them negative. In low illuminations there is, owing to limited photosynthesis and continued respiration, a tendency toward an accumulation of carbon dioxide, resulting in an increase in acidity, while in high illumination there is, owing to rapid photosynthesis, a tendency toward a reduction in carbon dioxide. This seems to indicate that the tendency toward positive orientation in low and negative orientation in high illumination may be dependent upon photosynthesis. If this is true, then red and yellow light in which photosynthesis is relatively strong should be more effective in producing reversion in the sense of orientation than blue and green in which photosynthesis is relatively weak. Numerous observations on both *Volvox* and *Pandorina* adapted to the colors mentioned were made as follows:

Some of the colonies to be tested were put into jars in each of four black light-tight boxes containing a large window made of blue, green, yellow, and red glass, respectively. Others were put into jars in absolute darkness and still others into jars in strong diffuse sunlight. After having been in these conditions eight hours or longer specimens were taken from each jar and put respectively into six observation aquaria. These aquaria were then placed side by side in the same illumination in the dark-room, others similarly treated were placed in other illuminations. In this way the reactions in different illuminations of the

colonies adapted to the various colors could readily and accurately be compared with each other and with those of the colonies adapted to darkness or to strong diffuse light.

Without going into details regarding the results obtained, it may be said that in practically every test the red- or yellow-adapted colonies responded essentially like dark-adapted colonies and the blue- or green-adapted ones responded essentially like light-adapted colonies. The red- and yellow-adapted colonies were usually negative in strong and positive in weak illumination, never the reverse; while the green- or blue-adapted colonies, like light-adapted ones, were frequently positive in strong and negative in weak illuminations.

The colors to which these colonies were adapted were not spectroscopically tested and the illumination was not measured. The question, consequently, arises as to whether or not, under the conditions of the experiments, photosynthesis in the red and the yellow was actually greater than in the blue and the green. This question was answered as follows:

A given amount of pond-water taken from a vessel containing colonies equally distributed was put into each of six 100-cc. wide-mouthed bottles. One of these bottles was now placed in each of the four boxes mentioned above, i.e., in the red, the yellow, the green, and the blue light used in the preceding experiments; one was put into darkness and the remaining one into strong diffuse light. After having been in these illuminations one or more days a given amount of solution was removed from each bottle and put into a test-tube. A drop of neutral red was now added to the solution in each tube. This solution was found to be distinctly alkaline in every case. Hydrochloric acid was then added to each tube until all were practically neutral and the same in color. The solution in the tube which required the greatest amount of hydrochloric acid was, of course, the most strongly alkaline, and in this solution photosynthesis had been most rapid, for carbon dioxid is consumed in the process of photosynthesis and the alkalinity is dependent upon the amount of carbon dioxid present.

There was considerable difference in the results obtained in the different tests, but taken as a whole they show conclusively that photosynthesis was most rapid in the diffuse white light and less rapid in the other illuminations in the following order: yellow, red, blue, green, darkness.

These results, consequently, demonstrate that photosynthesis was more rapid in the red and the yellow light used in these experiments than in the blue and the green. And since the blue and the green were more effective in producing reversion in the sense of orientation than the red and the yellow, it is evident that the effect of light on reversion is not determined by photosynthesis unless the photosynthesis which occurred during the exposure to white light in making the tests in the dark-room is involved. This, however, does not seem probable since all of the aquaria were exposed to the same illuminations. Moreover, essentially the same results were obtained in observations in which the aquaria were exposed to green light produced by means of passing the beam of light in the dark-room through a saturated solution of chlorophyl in 95 per cent alcohol. Now, since photosynthesis is reduced to a minimum in green light produced in this way and since the reactions of the colonies in the different aquaria were essentially the same as in white light, it is evident that photosynthesis during exposure in the dark-room is of no practical consequence. The conclusions, therefore, that reversion in the sense of orientation is not determined by photosynthesis appears to be valid.

The region in the spectrum of maximum stimulating efficiency lies in the green near wave-length $524 \mu\mu$ for *Pandorina* (Mast, '17, p. 509) and in the blue-green near wave-length $494 \mu\mu$ for *Volvox* (Laurens, '18). The results of the experiments described above indicate that the regions of maximum efficiency in producing reversion in the sense of orientation in *Pandorina* and *Volvox* probably have the same location as the regions of maximum stimulating efficiency. If this is true, it is probable, although by no means certain, that the processes involved in stimulation are also involved in reversion.

EFFECT OF TEMPERATURE ON REVERSION

In nearly all of the organisms that have been tested increase in temperature tends to induce positive and decrease in temperature negative orientation to light. There are only a few forms in which changes in temperature appear to have the opposite effect, but there are a considerable number in which changes in temperature have no effect on the sense of orientation (Mast, '11, pp. 272-279).

The sense of orientation is probably not specifically related to the temperature in any of the forms studied. For example, the results obtained in observations on *Euglena* (Mast, '11, pp. 274-277) indicate that this form may be, under certain conditions, negative or positive in practically all temperatures in which it orients at all.

The effect of changes in temperature on the sense of orientation in *Volvox* and *Pandorina* was ascertained as follows: The colonies were mounted on a Pfeifer warming-stage under a binocular. This stage was so arranged that hot or cold water could be passed through it at any rate desired. The whole apparatus was then exposed to constant illumination of the desired intensity.

The results obtained are in harmony with those obtained in the study of *Euglena*. The reactions of *Volvox* were, however, only superficially studied. Without going into details, it may be said that the results clearly show that a rise in temperature tends to produce positive, and a fall in temperature negative photic orientations, and that the sense of orientation is not directly dependent upon the temperature. For example, in one experiment it was found that *Pandorina* continuously exposed in a given illumination was, at 10.43 A.M., negative in 16 degrees, neutral in 17 degrees, and positive in 18 degrees; at 11.19 A.M., the same colonies were negative in 13.5 degrees, neutral in 14 degrees, and positive in higher temperature, and at 11.28 A.M. they were positive in 14 degrees. Thus the point at which they became positive changed from 18 degrees at 10.43 A.M. to 14 degrees at 11.28 A.M.

EFFECT OF CHEMICALS ON REVERSION

It is well known that acids and some narcotics tend to make many organisms that orient to light, photopositive. Salts and alkalis, on the other hand, rarely have any effect on the sense of orientation. In a recent paper on *Spondylomorom* ('18) it was fairly clearly demonstrated that the effect of the addition of acids is due to the reduction in the alkalinity of the culture medium and not to the acids as such. The results obtained in experiments on *Volvox* and *Pandorina* support this contention and they show that the response of the organism is not specifically dependent upon the chemical constitution of the surrounding medium.

The effect of acid on the sense of orientation in *Volvox* and *Pandorina* is in all essentials precisely the same as it is in *Spondylomorom* (Mast, '18). If a trace of acid is added to a solution containing negative colonies they become strongly positive, remain so a few moments and then become negative again. If more acid is now added they again become positive and later negative, just as they did after the first addition of acid. Thus they continue to become positive and negative after each addition of acid until the solution becomes fatal.

The water in the pond in which the *Volvox* and the *Pandorina* used in these experiments appeared gave, in every instance, a very definite alkaline reaction with neutral red, and when acid was added the sense of orientation was reversed long before the alkalinity was neutralized. In fact, sufficient acid to give even the slightest acid reaction invariably proved fatal. This seems to indicate that reversion in these forms, just as in *spondylomorom*, is due to a reduction in alkalinity, and not to the effect of acid as such. It also indicates that the sense of orientation is not directly related with the concentration of the alkalis.

The amount of reduction in alkalinity required to produce reversion varies with the concentration of the solution and the physiological state of the organisms. It is usually very small. For example, in one experiment titration against HCl showed that the water in which the colonies (*Pandorina*) lived was 0.0019

N alkaline. In this solution, under the conditions of the experiment, the colonies were strongly negative. After the addition of sufficient acid to make the colonies positive, the solution was 0.0015 N alkaline, and in a few other tests the reduction necessary was even less. In some it was, however, considerably more. This shows that the condition of the organism is involved in the process.

In *Spondylomorom* it was found that reduction in alkalinity produced by the addition of distilled water had little, if any, effect on the sense of orientation (Mast, '18, p. 512). Similar results were obtained in *Volvox* and *Pandorina*. Both of these forms live for several days in chemically pure water and respond normally, but only in relatively few tests was there any indication whatever of reversion due to the dilution of pond water with pure water, and in these tests the effect of the dilution was very slight. But that there was actually an effect was shown by the fact that in diluted pond water it required considerably less acid to induce positive reactions than it did in normal pond water. For example, in a given test in a solution consisting of one part of pond water and nine parts of pure water, it required only one-third as much acid to induce reversion as it did in the pond water. The dilution consequently seems to tend to make the colonies positive, but not in proportion to the degree of dilution.

If a reduction in alkalinity produces reversion from negative to positive orientation, it seems reasonable to expect the reverse if the alkalinity is increased by means of adding alkalis. This, however, does not appear to occur. I repeatedly added sodium hydrate to solutions containing positive colonies of *Volvox* or *Pandorina*, but never obtained any indication of reversion except in case the alkali was added immediately after the colonies had been made positive by the addition of acids, and in such cases there was always some question as to the actual effect of the alkali. However, an increase in the concentration of the solution due to slow evaporation clearly tends to make the colonies negative. These results are in full harmony with those obtained on *Spondylomorom* (Mast, '18, p. 512).

Chloroform has the same effect on reversion that acids have, but ether and alcohol have very little, if any effect. With ether, no clear case of reversion was obtained at all, and with alcohol reversion occurred only in colonies that were almost neutral. The concentration of alcohol necessary to kill these colonies, especially *Volvox*, is very surprising. In equal parts of pond water and 96 per cent alcohol they live for several hours.

The cause of the effect of anesthetics on reversion is not known, but it is certainly not dependent upon reduction in alkalinity, for the chloroform used was clearly slightly alkaline. This question will be discussed in the following section.

The evidence presented thus far indicates that the sense of orientation is dependent upon the constitution of the culture medium. This contention is further supported by the fact that ordinarily if colonies are negative in one jar and positive in another in the same illumination, as often happens, the solution in the former is more strongly alkaline than that in the latter. This is, however, by no means always true, and in some instances in which it was found to be true it was also found that the colonies retained their sense of orientation after they were interchanged. That is, the colonies which had been positive in the weaker solution were now positive in the stronger, and those which had been negative in the stronger were now negative in the weaker solution. This demonstrates conclusively that the state of the colonies may determine the sense of orientation.

DISCUSSION

It has been demonstrated in the preceding pages that decrease in illumination, decrease in alkalinity, increase in temperature, increase in anesthetics, and increase in the age of the colonies all tend to make them positive. It has also been demonstrated that light-adapted colonies are, under certain conditions, positive in strong and negative in weak light, and that reversion at times depends upon the time-rate of change in illumination. It has, moreover, been demonstrated that the region in the spectrum of maximum efficiency in producing reversion probably coincides with that for maximum stimulating efficiency. Reversion

in the sense of orientation, consequently, can be induced by a number of different factors, and this seems to indicate, as concluded in the preceding paper in this series ('18, p. 518) that it is due to some specific physiological change which can be produced by any one of the factors referred to.

The fact that the region of maximum efficiency for reversion probably coincides with that for stimulation indicates that the physiological phenomena associated with these two processes may be the same. Stimulation, however, is usually if not always accompanied with an increase in permeability and a decrease in electrical potential. Reversion, then, if our contention is correct, should also be accompanied with changes in permeability and all of the factors which produce positive orientation should induce changes in one direction while all those which produce negative orientation should induce changes in the opposite direction. As previously stated, decrease in illumination, decrease in alkalinity, increase in anesthetics, increase in temperature, and increase in age all tend to produce positive orientation. What effect have these factors on permeability?

Krabbe ('96) found in stems of *Helianthus annuus* that a rise in temperature greatly increases permeability, and Rysselberghe found the same in experiments on *Tradescantia* and *Spirogyra* (Tröndle, '10, p. 173). He maintains that the permeability for water, potassium nitrate, glycerine and urea increases slowly from 0 to 6 degrees, more rapidly from 6 to 20 degrees, and again more slowly from 20 to 30 degrees, and that it is eight times as rapid at 30 degrees as it is at zero. This shows clearly that increase in temperature produces increase in permeability. We have demonstrated, as stated above, that increase in temperature causes positive photic orientation. Therefore, if reversion is due to change in permeability, positive orientation must be associated with increase in permeability, and if this is true then all of the factors which produce positive orientation should cause increase in permeability.

The work of Lillie ('09, p. 248) indicates that this is true for decrease in alkalinity; Tröndle maintains that moderate illumination, such as favors positive orientation, causes increase in

permeability, and that strong illumination, in which negative orientation is usually found, causes decrease in permeability; and according to McClendon ('17, p. 141), a considerable number of investigators hold that anesthetics in low concentration stimulate. The concentrations of anesthetics that produce reversion, therefore, probably cause increase in permeability, although Osterhout ('13) in his ingenious experiments did not discover any such effect. We thus have considerable evidence in favor of the idea that positive orientation is dependent upon increase in permeability. However, if this is true, then permeability ought, under certain conditions, depend upon the time-rate of change in illumination; it ought to be greater in old than in young colonies and it ought, under certain conditions, be greater in intense than in moderate illumination. Moreover, all conditions which cause increase in permeability, e.g., NaCl, ought to produce positive orientation, while all those which cause decrease in permeability ought to produce negative orientation. With these questions, concerning which there is at present no trustworthy evidence, I hope to deal in the following paper in this series.

Some investigators maintain that in many of the unicellular and colonial forms orientation is due to a series of shock-reactions; others maintain that there is no definite relation between shock-reactions and orientation. However this may be, it is certain that *Euglena* and *Gonium* and probably all other similar organisms usually, if not always, respond with the shock-reaction to a sudden increase in illumination if they are negative and to a sudden decrease if they are positive. That is, the same reaction may be induced either by a sudden increase or by a sudden decrease in illumination, depending upon whether the organisms are negative or positive.

If shock-reactions are due to increase in permeability then increase in permeability must be due, in negative specimens, to increase and, in positive specimens, to decrease in illumination. And if orientation is due to shock-reactions, then reversion in orientation must be due to the phenomena which produce this change in the cause of increase in permeability. In relatively high temperature or moderate illumination and in solutions rela-

tively weak in alkalinity or relatively strong in narcotics, in all of which orientation is positive and permeability relatively high, a sudden *decrease* in illumination must produce an increase in permeability, and in relatively low temperature or intense light and in solutions strong in alkalinity or anesthetics, all of which tend to produce negative orientation and low permeability, a sudden *increase* in illumination must produce increase in permeability.

There is at present no evidence which bears on these problems. I have stated them in order to emphasize the fact, that whether orientation depends upon shock-reactions or not, any theory that accounts for reversion in orientation should account for the changes in the cause of the shock-reactions which accompany it.

SUMMARY

1. The reactions to light in *Volvox* and *Pandorina* are practically the same. Both forms orient fairly precisely and both may be either negative or positive.

2. Dark-adapted colonies are usually positive in weak and negative in strong illumination, never the opposite. Light-adapted colonies are sometimes positive in strong and negative in weak illumination.

3. If dark-adapted colonies are exposed to continuous illumination they are neutral for a short time, then they become positive, passing through a maximum, after which they become neutral again. then they become negative, passing through a maximum, after which they again become neutral and finally positive again. After they have reached this final state they remain positive no matter how intense the light may be, and they probably are negative in weak light.

4. The time required to pass through these various stages depends upon the intensity of the light. The higher the illumination, the shorter the time. Reversion is, therefore, dependent upon the time of exposure as well as upon the intensity of the illumination. But it requires much more energy to induce reversion in high than it does in low illumination.

5. Under certain conditions, sudden decrease in illumination makes negative colonies momentarily positive. This change in the sense of orientation is dependent upon the time-rate of change in the intensity of the illumination.

6. Reversion is not primarily dependent upon photosynthesis. Red and yellow light in which photosynthesis is relatively strong have little effect on reversion, while green and blue, in which photosynthesis is relatively weak, are nearly as effective as white light.

7. The rays of light which have the greatest stimulating efficiency (green and blue) are the most potent in producing reversion in the sense of orientation.

8. Increase in temperature causes negative specimens to become positive and decrease causes the opposite, but neither the degree nor the extent of change in the temperature is specific in its effect. Under certain conditions, the colonies may be negative or positive in practically all temperatures in which they orient at all.

9. Alkalis have little, if any effect on reversion. Acids and some anesthetics, especially chloroform, cause negative colonies to become strongly positive, but reversion is not specifically dependent upon the concentration of the chemicals. Colonies which are positive in a solution having a given chemical concentration may be negative in the same solution or even in a weaker solution. The effect of acids is probably due to the accompanying reduction in the alkalinity of the cultural solution.

10. The sense of orientation is dependent upon the physiological state of the colonies as well as upon the constitution of the culture medium.

11. The sense of orientation is dependent upon the age of the colonies. Young colonies are more likely to be negative than old ones. In a given solution the young specimens frequently collect at the side of the dish farthest from the light while the old ones collect at the opposite side.

12. Reversion in orientation is probably associated with changes in permeability, positive orientation being associated with an increase and negative orientation with a decrease in permeability.

LITERATURE CITED

- KRABBE, G. 1896 Über den Einfluss der Temperatur auf die osmotischen Prozesse lebender Zellen. *Jahrb. f. wiss. Bot.*, Bd. 29, S. 441-498.
- LAURENS, H. AND HOOKER, H. D. 1918 The relative sensitivity of *Volvox* to spectral lights of equal radiant energy content. *Anat. Rec.*, vol. 14, pp. 97-98.
- LILLIE, R. S. 1909 On the connection between stimulation and changes in the permeability of the plasma membranes of the irritable elements. *Sci.*, vol. 30, pp. 245-249.
- MAST, S. O. 1907 Light reactions in lower organisms. II. *Volvox*. *Jour. Comp. Neur. and Psy.*, vol. 17, pp. 99-180.
 1911 Light and the behavior of organisms. New York, 386 pp.
 1917 The relation between spectral color and stimulation in the lower organisms. *Jour. Exp. Zoöl.*, vol. 22, pp. 471-528.
 1918 Effect of chemicals on reversion in orientation to light in the colonial form, *Spondylomorom quarternarium*. *Jour. Exp. Zoöl.*, vol. 26, pp. 503-520.
- MCCLENDON, J. F. 1917 Physical chemistry of vital phenomena. Princeton, 240 pp.
- OSTERHOUT, W. J. V. 1913 The effect of anesthetics upon permeability. *Sci.*, vol. 37, pp. 111-112.
- RYSELBERGHE, FR. VAN 1902 Influence de la température sur la perméabilité du protoplasme vivant pour l'eau et les substances dissoutes. *Rec. de l'Inst. bot., Univ. de Brux.*, T. 5, p. 207.
- TRÖNDLE, A. 1910 Der Einfluss des Lichtes auf die Permeabilität der Plasmahaut. *Jahrb. f. wiss. Bot.*, Bd. 48, S. 170-282.

Numerous other references on this subject may be found in Washburn, *Animal Mind*, 1917, pp. 200-214; Holmes, *Studies in Animal Behavior*, 1916, pp. 116-119, and Mast, *Light and the behavior of organisms*, 1911, pp. 264-287.

Resumido por el autor, Andrew Johnson Bigney.

Los efectos de la adrenina sobre la emigración del pigmento en los melanóforos de la piel y en las células pigmentarias de la retina de la rana.

El presente estudio se ha efectuado sobre *Rana pipiens*, comparando los resultados obtenidos con los producidos en otras especies. El autor ha comprobado los efectos de la luz y la oscuridad sobre la rana normal. Los efectos de la adrenina sobre el pigmento de las células de la retina fueron estudiados en ranas sometidas a la acción de la luz y en otras colocadas en la oscuridad durante varias horas. En las ranas sometidas a la acción de la luz, el pigmento aparece difundido, como sucede normalmente en estas condiciones, pero en las ranas que han permanecido algún tiempo en la oscuridad también aparecía difundido, demostrando esto que la adrenina produce la difusión de dicha substancia. Puesto que los efectos de la adrenina y la luz son los mismos no pueden ser estudiados en las ranas colocadas a la luz, pero en las que han permanecido cierto tiempo en la oscuridad, que normalmente produce la contracción del pigmento, la influencia de la adrenina se hace notar; alcanza el máximo de intensidad a los siete minutos y sus efectos no cesan hasta pasadas unas cinco horas. Después de comprobar los puntos mencionados, el autor empleó diversas concentraciones y ha encontrado que con soluciones tan diluidas como la de 1:5,000,000, la influencia de la adrenina sobre el pigmento puede comprobarse. El pigmento de los melanóforos de la piel fué examinado bajo las mismas condiciones que el de la retina y se pudo comprobar que la adrenina produce su contracción a la luz, en vez de provocar su difusión.

Translation by Dr. José F. Nonidez,
Columbia University.

THE EFFECT OF ADRENIN ON THE PIGMENT
MIGRATION IN THE MELANOPHORES OF
THE SKIN AND IN THE PIGMENT
CELLS OF THE RETINA OF
THE FROG¹

ANDREW JOHNSON BIGNEY

The purpose of this paper is to discuss the influence of adrenin on the pigment migration in the dermal melanophores and the retinal pigment cells of the frog. It seems to be fairly well established by the work of a number of investigators that adrenin does induce a migration of the pigment granules from the cell processes into the body of the cell of the dermal melanophores of fishes, amphibians and reptiles. This has been proved in the frog by Corona e Moroni ('98) and by Lieben ('06). According to Klett ('08), the retinal pigment of the frog also migrates into the body of the cell under the influence of adrenin, but Fujita ('11) states that this drug produces just the opposite effect on this pigment. In order to clear up this uncertainty and to determine the relation of the retinal migration to that of the skin, the present investigation was undertaken. The work was suggested by that of Redfield ('17) and was done under the direction of Prof. G. H. Parker, to whom I make due acknowledgment for his many valuable suggestions.

The frogs used in these experiments were almost entirely *Rana pipiens* Schreber, though a few of *Rana clamitans* Latreille were used, but there was no difference seen in the migration of the pigment in either the skin or the retina of these two species. The adrenin employed was that prepared by Parke, Davis & Co. and sold under the name of "Adrenalin Chloride in strength 1 to 1000."

¹ Contributions from the Zoological Laboratory of the Museum of Comparative Zoölogy at Harvard College. No. 314.

In testing the effects of this drug on the melanophores of the skin, preliminary experiments were made on the effect of light and darkness on these cells. This was merely to confirm the work of previous investigators that in the light the pigment expands and in the dark it contracts. This action takes place in an hour or so; but to be sure that there was a complete migration, the frogs were kept either in the light or in the dark for six hours.

To determine the influence of adrenin on this pigment, two frogs were placed in strong, diffused daylight for six hours, after which 0.06 cc. of a solution of adrenin one part in a thousand was injected into the dorsal lymph spaces of each animal. The frogs were then kept a quarter of an hour in the light and killed and a small portion of the skin from the hip was removed and prepared for microscopic examination by fixing it in Perenyi's fluid and mounting it, unstained, by the usual method. In both instances the melanophores were found to be strongly retracted, which was opposite to the state induced by light.

Two more frogs were next treated in the same manner, but they were kept in the dark, and upon examining their skin the melanophores were found retracted, thus showing that the adrenin produces no other effect in the dark. These results harmonize with the investigations of previous workers.

To determine the strength of the adrenin necessary to produce these reactions, a number of frogs were kept in the light the usual time, then injected with the adrenin in concentrations, one part in ten thousand, one in fifty thousand, and one in five hundred thousand. The frogs were killed at the end of an hour. Those with one part in ten thousand had the pigment almost completely retracted, while those with one in fifty thousand had slight retraction, and those with one in five hundred thousand showed no effect.

The same concentrations were used on frogs kept in the dark and in all instances the melanophores remained retracted, as was to have been expected.

To determine how long the influence of the adrenin lasted, the usual amount, 0.06 cc. of a solution one in a thousand was in-

jected into the lymph spaces of a number of frogs kept in the light and they were killed at varying intervals from seven minutes to five hours. Complete retraction was found to last for about two hours; at three hours, moderate contraction was noted, while in four to five hours retraction was replaced by full expansion, thus showing that the influence of the adrenin had completely passed off.

The migration of the retinal pigment under the influence of light and darkness is well known to be outward from the cell in light and into the cell in the dark. To test the influence of adrenin on these pigment cells, eight frogs that had been kept in the light for five hours were injected each with 0.06 cc. of adrenin solution one in a thousand and were killed in pairs, the first pair after fifteen minutes' exposure to the drug, the second after thirty minutes, the third after forty-five minutes, and the fourth at the end of an hour. The eyes after removal were fixed in Perenyi's fluid, cut into sections, and mounted unstained. In all instances the retinal pigment was found to be fully expanded.

The experiment was then reversed, the frogs being kept in the dark five hours and subjected to the adrenin while still in the dark. They were also killed in pairs at quarter-hour intervals. To my surprise, the retinal pigment in every case was fully expanded. To avoid possible error, I repeated the experiment, with exactly the same results. Control frogs injected with physiological salt solution, instead of adrenin, were made to accompany the others. The retinal pigment in all of these remained retracted as in the regular dark condition. It is therefore certain that the adrenin acts upon the retinal pigment in the same way as light, as maintained by Fujita ('11). It thus appears that the action of adrenin on the retinal pigment cells is the opposite of what it is on the melanophores of the skin. My results, therefore, are opposed to those of Klett ('08), who maintained that adrenin caused a retraction of the retinal pigment. His results were obtained by an intra-ocular application and not by injecting it into the blood stream. He could get no results by the latter method. In all his experiments the frogs were in direct, strong light or in diffused light, but never in the dark,

and the concentration of adrenin was strong enough to be poisonous to the animals. It is, therefore, not surprising that he failed to observe the real action of the drug. Furthermore, since the adrenin and light act in the same way, the real action of the drug could not be noticed in the light condition. Had Klett carried on his tests with frogs kept in the dark instead of the light, I am convinced that his results would have agreed with Fujita's and mine.

To determine the concentration necessary to produce the migration of the retinal pigment, frogs that had been kept in the dark were injected with adrenin in strengths varying from one part in a thousand to one in one hundred million. The frogs were subjected to the influence of the drug for one hour and then killed. At concentration one to one thousand there was complete expansion of the pigment, at one to ten thousand almost complete, at one to fifty thousand there was less expansion and less regularity in the condition of the preparation, and at one to one million or one to five million the results were not very uniform. While the influence of the adrenin could still be detected at these dilutions, there was an irregularity which recalled the variation often noticed in normal frogs. The action of the drug on the retinal pigment is possible in even greater dilutions. This sensitiveness of the retina is in marked contrast with that of the skin, which is not nearly so responsive. There seems to be no sharp ending in its influence either on the skin or the retina, but a gradual diminution.

To determine how long the influence of the adrenin on the retinal pigment lasted, a number of frogs kept in the dark were injected with a solution of adrenin one in one thousand and the eyes were prepared at hour intervals from one to six. After an hour the pigment showed complete expansion; after two hours somewhat reduced expansion; in three to four hours still further reduction, and in five to six hours the retraction was complete, thus showing that the influence passes off in about four hours.

It is clear from these experiments that adrenin causes a contraction of the pigment in the dermal melanophores and an expansion of that in the retinal cells—processes precisely the opposite of each other.

Another interesting question presents itself. How does this drug act in causing the above results? Is it through the nerves or directly upon the cells by being carried in the blood? To answer these questions, frogs in which the optic nerve of one eye had been cut very close to the brain, the other optic nerve not having been disturbed, were injected with adrenin under the usual conditions. In this experiment the retinal pigment was found to be expanded in both eyes, thus showing that the optic nerve is not concerned in this action, but that it is very probably due to the drug carried in the blood.

Another experiment was performed in which the eyes of several frogs were removed and treated directly by injecting the adrenin into the eyeball of one side and physiological salt solution into the eyeball of the other side in each frog. Irregular results were obtained, the pigment sometimes being retracted, but most generally expanded in all the eyes. These irregularities were evident in the control frogs as in the experimental set. This led to the suspicion that the condition of the frogs was not satisfactory owing to the season of the year. The earlier part of this work was performed in the autumn and winter and the results were strikingly uniform and consistent, but the later part of it was done in the spring. It was, therefore, suspected that the advent of the breeding season had something to do with the results. It is not improbable that this irregular condition is dependent, as Fuchs ('06) has suggested, on an especially excited state of the animals whereby adrenin is secreted naturally and in considerable quantities by the frog itself. This suggestion, which seems plausible, is nevertheless purely hypothetical. It is intended to continue this part of the work with the view of a final determination as to the real cause of this irregularity.

BIBLIOGRAPHY

- CORONA, A., e MORONI, A. 1898 Contributo allo studio dell' estratto di capsuli surrenali. *La Riforma Medica*, anno 14. (Cited from van Rynberk, 1906.)
- FUCHS, R. F. 1906 Zur Physiologie der Pigmentzellen. *Biol. Centralbl.*, Bd. 26, S. 863-879, 888-910.
- FUJITA, H. 1911 Pigmentbewegung und Zapfenkontraktion im Dunkelauge des Frosches bei Einwirkung verschiedener Reize. *Arch. vergl. Ophthalm.*, Jahrg. 2, S. 164-179.
- KLETT 1908 Zur Beeinflussung der phototropen Epithelreaktion in der Froschetina durch Adrenalin. *Arch. Anat. Physiol.*, Jahrg. 1908, *Physiol. Abt., Suppl. Bd.*, S. 213-218.
- LIEBEN, S. 1906 Über die Wirkung von Extrakten chromaffinen Gewebes (Adrenalin) auf die Pigmentzellen. *Zentralbl. Physiol.*, Bd. 20, S. 108-117.
- REDFIELD, A. C. 1917 The coördination of the melanophore reactions of the horned toad. *Proceed. Nat. Acad. Sci.*, vol. 3, pp. 204-205.
- VAN RYNBERK, G. 1906 Über den durch Chromatophoren bedingten Farbenwechsel der Tiere. *Ergeb. Physiol.*, Jahrg. 5, S. 347-571.



Resumido por el autor, W. W. Swingle.

Estudios sobre la relación del iodo con la tiroides.

I. Los efectos de la alimentación iodada sobre los renacuajos normales y tiroidectomizados.

El presente estudio trata del problema entre la relación del iodo y sus compuestos con la actividad y función de la tiroides, determinada por los efectos que siguen a la ingestión de estas sustancias por las larvas de rana, normales y desprovistas de tiroides. Cuando se alimentan renacuajos normales con cristales de iodo, los cambios propios de la metamorfosis aparecen pocos días después y dicho proceso se lleva a cabo en corto tiempo si se alimentan con algun cuidado. La ingestión del iodoformo produce resultados semejantes pero sus efectos no son tan rápidos; con el ioduro potásico se obtienen los mismos resultados. El iodato potásico no parece producir efecto alguno sobre la metamorfosis. En animales privados de las glándulas tiroides cuando median 4 mm. de longitud, alimentados después con iodo, la metamorfosis se llevó a cabo rápidamente, a pesar de que en las larvas desprovistas de tiroides y alimentadas con los alimentos adecuados nunca aparecen cambios metamórficos, sino que, por el contrario, crecen hasta convertirse en renacuajos gigantes. El examen microscópico de estas larvas no pudo revelar indicación alguna de tejido tiroideo. La comparación entre la rapidez de la metamorfosis en las larvas alimentadas con iodo y las alimentadas con extracto de la tiroides o con tejido tiroideo demuestra que el iodo es mas potente en la producción de los cambios metamórficos. El autor consigna experimentos describiendo el efecto del iodo sobre el canal alimenticio y otros órganos y hace notar que el iodo actúa dentro de los tejidos como un verdadero hormon, sin intermedio de la glándula tiroides, que funciona principalmente como un reservorio del iodo.

STUDIES ON THE RELATION OF IODIN TO THE THYROID¹

I. THE EFFECTS OF FEEDING IODIN TO NORMAL AND THYROIDECTOMIZED TADPOLES

W. W. SWINGLE

Fellow in Biology, Princeton University

CONTENTS

Introduction.....	397
Literature.....	398
Material and methods.....	400
Observations (Feeding of iodine compounds to normal larvae).....	401
1. Potassium iodide.....	401
2. Iodine crystals.....	405
3. Iodoform.....	409
Feeding iodine to thyroidectomized larvae.....	411
Summary and conclusion.....	414

INTRODUCTION

Early in the spring, while carrying on a series of feeding experiments with tadpoles, the writer suggested to Mr. A. C. Eitzen, a student in the Medical School of the University of Kansas, that he undertake the problem of feeding inorganic iodine, and various organic compounds of this substance to frog larvae. The object was to note the macroscopic effect upon growth and metamorphosis and the histological effects on the thyroid and germ glands.

Most of the investigators who have dealt with the problem of the relation of iodine and its compounds to the activity of the thyroid have used mammals as experimental material, forms which, in the author's opinion, offer no such sure and certain

¹ The experimental work for this paper was done while the writer was instructor in zoology at the University of Kansas. Acknowledgment is made to this laboratory.

criteria for judging the effect of iodine administration and thyroid activity upon the organism as do frog larvae. The original work of Gudernatsch (since followed by that of Morse, Lenhart, and Swingle) showed that any increased stimulation of thyroid activity, as for instance by feeding thyroid extract, was at once indicated by metamorphic changes in the tadpoles. The present problem was to utilize these somatic changes as a criterion of hyperthyroid function and to gauge the effects of iodine upon the gland by feeding it to immature larvae.

Mr. Eitzen followed the suggestion, and, in conjunction with the writer, started the work, but owing to induction into military service shortly afterward gave up the problem. Consequently it fell to the writer to work out his own suggestion. The results obtained contribute some additional information regarding the relation of iodine to the physiological activity of the thyroid, to the probable rôle of this gland in the economy of the organism, and to the more general problem of amphibian metamorphosis.

LITERATURE

The active principle of the thyroid gland is at present unknown, or at any rate much in dispute. The relation of iodine to this gland has been for many years a matter of great interest to clinicians and investigators, and it has long been recognized that iodine holds an important place among the constituents of the thyroid. Since 1820 iodine has been used more or less in the treatment of thyroid diseases, but it was not until 1895 that it became known that the glands usually contain iodine. Baumann ('95) contributed this important information to our knowledge of the gland.

This investigator isolated a specific iodine compound from the gland which he named iodothyron. It apparently has many of the specific properties of the gland tissue itself.

Oswald ('02) succeeded in isolating the protein with which the iodine in the gland is combined. He called this protein thyroglobulin; it was found to constitute one-third to one-half of the weight of the dry gland. The iodine content varied from zero to 0.86 per cent or more. Baumann's iodothyron could be obtained from it by hydrolysis.

Kendall ('14) has reported the separation of the physiologically important thyroid constituents into two fractions: an A or alpha fraction, containing ten times the percentage of iodine of the original thyroid. This alpha fraction is toxic and its administration produces typical symptoms of excess thyroid feeding. The B fraction contains less iodine and is non-toxic.

The relation of iodine to the physiological activity of the thyroid is very close; in fact, the activity of the gland appears to depend upon its iodine content.

One investigator, Roos ('99), working with dogs, found that more nitrogen was excreted after the administration of thyroid rich in iodine than after that of thyroid containing little iodine.

Marine and Williams ('08) observed that thyroid containing a larger percentage of iodine caused a greater loss of weight in dogs than did a preparation containing a smaller percentage.

Hunt and Hunt and Seidell ('07 and '08), in an extended series of experiments in which the effects of thyroid upon the resistance of animals to certain poisons was determined, found that the physiological activity of the thyroid depended upon its iodine content.

Morse ('14) fed the larvae of *Rana pipiens* on various iodine compounds, but obtained negative results with all inorganic iodine. He was able to accelerate metamorphosis in these animals by feeding iodized amino-acids (3-5-di-iodo-tyrosin, $C_6H_5OHI_2CH_2.CH_2.CHNH_2COOH$). This amino-acid was derived from the thyroid tissue by acid hydrolysis.

Lenhart ('15) fed thyroid tissue to tadpoles and observed that the higher the iodine content of the gland fed, the more rapid the body metabolism.

This review is by no means exhaustive. Besides the investigators quoted, there are equally as many, if not more, who claim that iodine has no relation to thyroid activity and that it does not function within the organism.

MATERIAL AND METHODS

Late in March (1918) several bunches of *Rana pipiens* eggs in late segmentation stages were collected and brought to the laboratory to develop. All of the animals used in a single experiment were taken from cultures, the larvae of which came originally from the same bunch of eggs, hence were of the same age. The animals were separated into lots of fifty each when the free feeding stage was reached and kept in large glass containers under identical environmental conditions. Several groups of fifty tadpoles each were fed inorganic iodine crystals finely ground, mixed with wheat flour in the proportions of 1 to 100, using the same procedure described by the writer in a previous paper ('18) for administration of thyroid extract. Another lot of larvae was fed iodoform mixed with flour as described. Two other cultures were fed potassium iodide, also in flour, using the same proportions as before. Solutions of potassium iodide were prepared and an attempt made to rear the tadpoles in them, but the method proved unsatisfactory and so was abandoned.

The larvae were fed each day, care being taken not to overfeed; the water was changed daily, and with the advent of warm weather twice daily. Very early in the work it was observed that unless the iodine was mixed with food in some way, the larvae refused to eat it. This was especially true of the iodine crystals. Great mortality results if the crystals are merely thrown into the containers among the tadpoles. The quickest and most effective way of rendering the iodine palatable was to mix finely ground crystals with wheat flour (1 to 100) stir until the flour was a delicate brownish hue and then feed the dry mixture. Small bits of algae were fed the animals along with the iodine.

The various mixtures of iodine and flour prepared by the method described by the writer in a previous paper ('18) for thyroid administration keep well, with the exception of the iodine crystals and flour. The mixture appears to lose strength after about two weeks. Regarding the chemical nature of the substances formed by the mixture of iodine and its compounds with

flour, no mention will be made here. This phase of the work together with certain histological data gathered by examination of normal and thyroidectomized iodine-fed larvae, will be the subject-matter of part II of this paper. The results obtained with feeding normal larvae potassium iodine will be discussed first.

QBSERVATIONS

I. Experiments with feeding potassium iodide to normal tadpoles

The tadpoles were first fed potassium iodide and flour when they averaged 10 mm. in length; none of the animals showed indications of limb buds. April 11th, eight days after the first administration of potassium iodide, the animals were measured and examined with a microscope for limb buds. At this time some of the larvae appeared somewhat emaciated and about one-fourth of the animals had hind limb buds, though the buds were small. The controls were somewhat larger than the experimental larvae, but no limb buds were found. Table 1 gives the total length of twenty of the larvae from each culture, in millimeters and indicates those animals with limb buds.

April 18th. When examined on this date the potassium-iodide-fed animals were lighter in color than their controls but of about the same size. All of the experimental animals had hind limb buds whereas none of the controls had developed them (table 2). The emaciated appearance of the larvae, noted at the previous examination, had disappeared.

April 26th. The potassium-iodide-fed larvae had by this time outgrown their controls and were considerably lighter in color. All of the experimental animals had well-developed hind limbs showing differentiation into the two primary divisions with toe points. Only three of the controls had limb buds, none showed any differentiation of parts. The difference between the two cultures of larvae in regard to limb development was striking (table 3).

May 6th. The animals fed on the iodine compound were now distinctly larger than the algae-fed larvae. The light color of these animals was marked. Their limbs were well developed—

TABLE 1

April 11

KI-FED LARVAE		CONTROLS FOR KI-FED LARVAE	
Length	Limb buds	Length	Limb buds
<i>mm.</i>		<i>mm.</i>	
16.0	+	15.0	-
15.5	+	16.5	-
13.5	+	15.5	-
14.5	-	17.0	-
15.0	+	18.5	-
14.0	+	17.0	-
16.0	-	16.5	-
14.0	+	15.0	-
13.5	+	19.5	-
14.0	-	18.5	-
17.5	-	20.0	-
14.0	-	19.0	-
13.0	-	18.5	-
13.5	-	16.0	-
16.0	-	20.0	-
14.5	-	18.5	-
14.0	+	15.5	-
15.5	-	17.0	-
13.0	-	19.5	-
14.5	+	15.5	-
Average length..14.5		17.5	

much in advance of the controls (table 4). No mortality had occurred in the cultures of either group.

May 18th. The experimental animals were much larger than the controls, more sluggish, lighter in color, limbs much more highly developed and much larger. No other differences were noted (table 5).

The animals of this culture were not measured again, owing to the pressure of other work at this time. They were fed and tended as usual, however. It was observed sometime later that the potassium-iodide-fed animals appeared to be slowly falling behind in growth rate. They remained much lighter in color and had limbs much longer than the controls. The cultures were kept until the 1st of June. When it became impos-

TABLE 2

April 18

KI-FED LARVAE		CONTROLS FOR KI-FED LARVAE	
Length	Limbs	Length	Limbs
<i>mm.</i>		<i>mm.</i>	
21.0	+	23.0	—
18.5	+	18.5	—
17.0	+	22.0	—
20.0	+	21.5	—
21.5	+	20.0	—
19.5	+	22.0	—
18.0	+	19.0	—
21.0	+	20.5	—
22.0	+	22.5	—
19.5	+	18.5	—
20.0	+	19.0	—
23.0	+	21.0	—
21.5	+	19.5	—
17.5	+	23.0	—
22.0	+	18.0	—
20.5	+	24.0	—
19.0	+	20.5	—
23.5	+	22.0	—
22.0	+	23.5	—
20.5	+	23.0	—
20.37		21.07	

sible to prolong the experiment, the animals were killed and preserved for microscopic examination.

Discussion of potassium iodide feeding experiment. The results of this experiment, while not so interesting perhaps as those obtained by administration of iodine crystals, seemed worth recording in detail. The table of measurements shows that the growth capacities of the larvae receiving potassium iodide were much increased. It is interesting to note in this connection that Adler ('13), in a brief paper dealing with the effects of iodine upon the germ glands of amphibians and mammals, observed that iodine compounds appeared to stimulate the growth rate of the amphibian larvae with which he worked. He records no measurements, however, and made no observations regarding metamorphic changes.

TABLE 3

April 26

KI-FED LARVAE		CONTROLS FOR KI-FED LARVAE	
Length	Limbs	Length	Limbs
<i>mm.</i>		<i>mm.</i>	
28.5	+	26.5	+
27.0	+	28.0	+
27.5	+	26.0	-
30.0	+	27.5	-
29.5	+	25.5	-
28.0	+	30.0	-
31.5	+	27.5	+
29.5	+	26.0	+
32.0	+	23.0	-
32.5	+	26.5	-
33.0	+	29.0	+
30.0	+	27.5	-
33.0	+	24.5	+
32.5	+	26.0	-
29.5	+	27.5	-
31.0	+	31.0	-
29.0	+	25.5	-
33.5	+	25.0	+
30.5	+	27.0	-
32.0	+	28.5	-
30.5		27.05	

Potassium iodide in flour clearly stimulates the growth and differentiation of limbs. Morse ('14) was unable to produce metamorphic change by administration of iodine compounds to tadpoles, with the exception of iodized blood albumin. In the light of the results obtained by the writer with iodine crystals, it is difficult to understand why this investigator failed to get positive results. His method of feeding the iodine probably accounts for the discrepancy in our results. Why feeding potassium iodide stimulated the growth of tadpoles is not clear. Feeding other iodine compounds gives just the reverse results, i.e., growth ceases.

TABLE 4

May 6

KI-FED LARVAE		CONTROLS FOR KI-FED LARVAE	
Length	Limbs	Length	Limbs
<i>mm.</i>		<i>mm.</i>	
34.0	+	28.5	+
35.5	+	26.0	-
30.0	+	29.5	+
29.5	+	25.5	-
32.5	+	27.0	-
36.0	+	30.0	+
39.0	+	27.5	-
32.5	+	29.0	-
34.0	+	31.5	+
33.5	+	28.0	+
41.0	+	28.5	+
38.0	+	30.0	+
36.5	+	29.0	+
44.0	+	31.5	+
40.0	+	27.5	-
33.5	+	30.0	+
36.0	+	26.5	-
39.0	+	30.0	+
41.5	+	31.0	+
38.0	+	28.5	-
36.2		28.7	

2. Experiments with feeding iodine crystals to normal larvae

This experiment was conducted in the same manner as described for the potassium iodide experiment. The larvae averaged 10.5 mm. in length when the iodine was first fed, April 4th. None of the animals of either control or experimental cultures showed any indications of limb development. Seven days after the first feeding, the animals fed on the iodine had limb buds and showed other bodily changes not found in the controls (table 6). The larvae appeared emaciated; head much elongated (this change is only apparent and has been shown by the writer to be due to atrophy of the coiled gut); body thin; eyes bulging; pigmentation light. One or two of the animals showed signs of tail involution. All of the larvae were extremely sluggish and

TABLE 5
May 18

KI-FED LARVAE		CONTROL OF KI-FED LARVAE	
Length	Limbs	Length	Limbs
<i>mm.</i>		<i>mm.</i>	
44.0	Large	32.5	Very small
46.0	Large	31.0	Very small
45.5	Large	34.0	Very small
44.0	Large	31.0	Very small
39.5	Large	34.0	Very small
46.0	Large	33.5	Very small
46.5	Large	29.5	Very small
44.0	Large	35.0	Very small
47.0	Large	30.5	Very small
38.5	Large	30.0	Very small
45.0	Large	33.5	Very small
42.5	Large	31.0	Very small
40.0	Large	34.0	Very small
43.5	Large	33.5	Very small
39.0	Large	30.0	Very small
41.5	Large	33.0	Very small
42.0	Large	30.5	Very small
38.0	Large	29.5	Very small
40.5	Large	34.0	Very small
44.0	Large	30.5	Very small
42.3		32.05	

remained near the surface of the containers. The hind limbs were small, and as yet they had not differentiated into their two primary divisions with toe points.

These animals revealed clearly all of the symptoms of hyperthyroidism, the reaction to which is characteristic in this species. Examination of the controls showed none of these changes. None of the animals had limb buds.

April 17. On this date the differences between iodine-fed and control larvae were marked. All of the body changes noted on April 11th were now much more obvious. The tails of the iodine-fed animals were undergoing atrophy; the hind limbs were plainly visible and had differentiated toes. The total length of the animals had decreased owing to tail resorption (table 7). There was great mortality among the larvae of the iodine culture. Out of

TABLE 6

April 11

IODIN-FED LARVAE		CONTROL FOR IODIN-FED	
Length	Limbs	Length	• Limbs
<i>mm.</i>		<i>mm.</i>	
11.0	+	15.0	—
12.0	+	16.5	—
11.5	+	15.0	—
10.5	+	18.5	—
12.0	+	17.5	—
11.0	+	16.0	—
12.5	+	20.0	—
13.0	+	18.0	—
11.0	+	15.5	—
11.5	+	19.5	—
13.5	+	17.0	—
10.0	+	17.5	—
12.0	+	20.0	—
10.5	+	19.0	—
11.0	+	15.0	—
12.5	+	17.5	—
10.0	+	17.0	—
13.5	+	19.0	—
11.0	+	21.0	—
12.0	+	18.5	—
11.6	+	17.6	—

several cultures containing fifty larvae each, only thirty animals remained alive on this date. The controls had increased in size during this interval, but none showed signs of limb development.

A new series of cultures of iodine-fed animals was started. The animals averaged 13 mm. in length when first fed iodine. Eight days later the first indications of body change appeared, and ten days from the date of first feeding the limb buds of the experimental larvae averaged 0.8 mm. in length. The controls showed no signs of limb development. At this time the animals were taken off the iodine diet and fed algae in order to prolong the experiment, as the mortality rate was abnormally high. The control animals at this time averaged 19 mm. in length; the iodine-fed larvae, 14.5 mm. For several days both sets of tadpoles were fed only algae and then measured at the end of the period. The

TABLE 7
April 17

IODIN-FED LARVAE		CONTROL OF IODIN-FED	
Length	Limbs	Length	Limbs
<i>mm.</i>	<i>mm.</i>	<i>mm.</i>	
12.0	1.5	20.5	None
10.0	1.0	24.0	None
9.0	1.4	21.0	None
9.5	0.5	23.5	None
9.0	1.0	22.0	None
10.5	1.5	24.5	None
10.0	1.0	20.0	None
12.5	2.0	19.0	None
13.0	1.5	21.0	None
10.5	0.5	23.5	None
9.0	0.5	20.0	None
9.5	1.5	20.5	None
10.0	1.0	21.0	None
10.5	1.5	24.5	None
9.0	1.0	22.0	None
11.5	2.0	20.0	None
12.0	1.5	19.5	None
12.5	1.0	21.0	None
9.0	0.5	23.0	None
9.0	1.0	20.5	None
10.4	1.12	21.5	

controls averaged 23.5 mm.; the iodine fed, 16.5 mm. The latter had well-developed hind limbs. Iodine was again administered for eight days and the animals measured. Table 8 indicates the differences between the two sets of larvae.

The fore limbs of the iodine-fed larvae appeared shortly afterwards. Six of these animals were reared to metamorphosis before death occurred. One of the lot was the smallest frog the writer has ever seen. The controls for this lot developed normally, but have not at the present writing undergone metamorphosis. The fore limbs have not yet appeared.

In a previous paper the writer had found that when thyroid extract is administered to frog larvae, the alimentary tract undergoes a remarkable shortening process in a brief space of time.

TABLE 8

IODIN-FED LARVAE		CONTROL OF IODIN-FED	
Length	Limbs	Length	Limbs
<i>mm.</i>	<i>mm.</i>	<i>mm.</i>	<i>mm.</i>
17.5	6.0	27.0	0.3
16.0	4.5	28.5	0.5
15.5	5.0	30.0	0.5
15.0	6.5	25.5	0.6
16.5	6.0	23.0	0.4
16.5	4.0	29.5	0.2
14.5	5.5	32.0	0.3
18.0	7.0	26.5	0.6
17.0	6.0	28.0	0.4
16.5	3.5	28.5	0.3
15.0	4.0	31.0	0.5
16.5	5.5	29.5	0.6
15.0	5.0	26.0	0.2
14.5	4.5	28.0	0.3
14.0	7.0	30.0	0.5
18.5	5.0	33.0	0.6
17.0	4.0	27.5	0.4
17.5	8.0	29.0	0.2
14.0	7.0	30.5	0.3
16.0	4.0	26.5	0.4
15.0	5.4	28.6	0.405

An attempt was made to see if feeding iodine had the same effect upon the gut. A series of larvae appropriately controlled was started upon the iodine diet to test this matter. The animals were fed iodine for twenty days. Table 9 shows the effect upon the gut at the end of this interval.

3. Experiments with feeding iodoform to normal larvae

An experiment similar in all respects to the potassium iodide and iodine feeding was carried out in which iodoform and flour was used as food. The proportions of flour and iodoform used was the same as described for the other experiments. Iodoform appears to have a marked effect in accelerating metamorphic changes in frog larvae, although the reaction is not so rapid as when iodine crystals are used. The iodoform is toxic for the

TABLE 9

IODIN-FED LARVAE		CONTROL FOR IODIN-FED LARVAE	
Body length	Length of gut	Body length	Length of gut
<i>mm.</i>	<i>mm.</i>	<i>mm.</i>	<i>mm.</i>
20.5	33.0	25.0	107.0
20.0	35.0	23.0	102.0
19.5	32.0	23.5	121.0
21.0	36.0	26.0	117.0
19.5	38.0	25.5	111.0
20.0	32.0	27.0	119.0
20.0	31.0	27.5	97.0
16.5	36.0	24.5	123.0
22.5	24.0	30.0	99.0
19.0	28.0	27.0	116.0
20.0	31.0	25.0	102.0
17.5	35.0	28.5	97.0
20.0	34.0	26.0	114.0
18.0	29.0	23.5	118.0
21.5	24.0	28.0	99.0
18.5	27.0	22.0	105.0
20.0	30.0	24.5	122.0
18.5	25.0	29.0	96.0
19.0	28.0	25.5	98.0
17.5	30.0	26.0	110.0
19.45	30.9	25.85	108.6

animals and the mortality rate is very high when this compound is fed for any length of time. Several cultures were kept long enough to show the accelerating effect of this substance upon metamorphosis. One culture, the animals of which averaged 12.5 mm. when first fed the iodoform, was kept for ten days. During this interval the animals ceased to grow and showed the reaction characteristic of iodine or thyroid feeding. Limb buds were found on all of the experimental animals, but none on the controls. This phase of the work was not carried out in detail because of the toxicity of the iodoform mixture.

Discussion of the experiments with feeding iodine to normal larvae. The results obtained by feeding iodine crystals and iodoform are identical with those obtained when extract of the thyroid gland is used as food. The changes typical of hyper-

thyroidism appear a few days after administration of the substance. Overfeeding with iodine has the same result as overfeeding with thyroid extract—death of the organisms from a too rapid rate of metabolism. Iodine, if carefully administered, will stimulate metamorphosis in a shorter time than the fresh gland tissue. Two years ago the writer fed fresh thyroid gland to frog larvae and kept a record of the rate of body change and the time required for such changes to occur when the larvae were fed fresh tissue and the powdered extract. A comparison of these time intervals with those of the iodine-fed animals of the present experiment show clearly that the fresh gland tissue is not so effective in inducing metamorphic change as the inorganic iodine. The animals used in both cases were of the same species.

EXPERIMENTS WITH FEEDING THYROIDECTOMIZED LARVAE IODINE

Since normal larvae were found to react to iodine feeding by marked metamorphic changes, it was considered worth while to carry out the same experiment upon animals whose thyroids had been removed during early embryonic life. The work of Allen ('18) has shown that thyroidectomized larvae fail to undergo metamorphosis, but instead permanently retain their larval characters. If such thyroidless animals could be induced to metamorphose under the stimulus of iodine feeding, new light would be shed upon the iodine-thyroid problem and upon the causes of amphibian metamorphosis.

Eighty very young toad tadpoles, the thyroid glands of which had been removed at the 4-mm. stage by Prof. B. M. Allen, of the University of Kansas, were obtained through the generosity of this investigator when the larvae averaged 6.5 mm. in length. The animals were fed algae until they were 10 mm. long and then fed iodine crystals and flour. This series was controlled by both normal and other thyroidectomized larvae of the same age. The iodine mixture was first administered the 27th of May. Ten days later, examination of the culture revealed well-developed limbs on all of the thyroidless larvae. The limbs were visible without the aid of a lens and had differentiated toe points. The

animals appeared emaciated and showed other symptoms characteristic of hyperthyroidism. The controls had increased in size somewhat, and microscopic examination showed tiny limb buds. The iodine feeding was continued until the time of metamorphosis, which took place in a normal manner and was successfully completed by all with the exception of nine larvae which died during early metamorphic change. The thyroidless animals under the stimulus of the iodine completed metamorphosis in a much shorter time than the normal control animals with thyroid glands intact. The thyroidectomized animals used as controls for the series are at the present writing very large and show no signs of limb buds.

About this time twenty extremely large thyroidless toad larvae were obtained from Miss Mary Larson, of the University of Kansas. The glands of these animals had been removed several weeks before; they were much larger than normal toad tadpoles at metamorphosis; they were, in fact, typical giant thyroidectomized larvae like those described by Allen. These animals showed no indications of limb buds when started on the iodine diet, but are at the present writing (June 12th) undergoing metamorphosis. The fore and hind legs of the animals are well developed; mouth is changing from larval to adult form; tails almost completely resorbed.

Four of these giant thyroidless larvae used as controls for the iodine-fed culture are larger than at the beginning of the experiment, but show no signs of limb development.

A number of both large and small thyroidectomized tadpoles were killed at different stages of the experiment and preserved for microscopic examination. Careful search made for vestiges of the thyroid gland have yielded only negative results. No indications of accessory thyroid glands have been found in any of the thyroidectomized animals examined by me in connection with this work.

An experiment to test the ability of thyroidectomized larvae to withstand the deleterious effects of iodine in different concentrations was attempted. Iodine is only very slightly soluble in water, but if the crystals are finely ground, a certain pro-

portion is dissolved. It was soon found that both normal and thyroidless animals are quickly killed by very weak dilutions. Two cc. of such a solution of iodine in 500 cc. of water suffices to kill both kinds of animals in a few hours. No conclusions could be drawn from the results, save, perhaps, that flour when mixed with iodine must in some way protect the tissues of the larvae from the latter.

Discussion of effects of feeding iodine to thyroidectomized larvae. The results of iodine feeding just recorded should in some measure serve to clarify the conflicting views regarding the relation of iodine to the physiological activity of the thyroid and incidentally throw some light upon the causes underlying amphibian metamorphosis.

The various views regarding the relation of iodine to the thyroid held by investigators to-day may be briefly summarized under three heads: 1. Some are of the opinion that the activity of the thyroid depends upon its iodine content and that thyroid free of iodine has no physiological activity. 2. Another group of writers take the view that there is no relation whatever between the physiological activity of the thyroid and its iodine content; i.e., that the iodine usually present has no importance in the economy of the organism. 3. Still other investigators admit the parallelism between physiological activity and iodine content, but deny that iodine is the causal agent, believing rather it is simply associated accidentally with the active principle of the gland.

The effects of iodine feeding to normal tadpoles give additional confirmation to the first of these views. But especially interesting in this connection are the results with feeding iodine to thyroidless larvae. If animals without the vestige of a thyroid gland are stimulated to complete metamorphosis in an abnormally short time by iodine, it would appear that iodine functions within the organism as a hormone itself and that the gland functions chiefly for storage purposes. The evidence from the thyroidectomized larvae indicates that the animal body is capable of utilizing iodine directly without the intermediation of the gland.

The fact that the thyroid gland of man and animals does not invariably contain iodine (shown by Miwa and Stoeltzner, Roos

Töpfer and Jolin) and yet such individuals remain healthy may be explained by assuming that the tissues of such animals assimilate directly the iodine taken into the body, leaving no surplus to be collected by the thyroid. Since the tissues of thyroidec-tomized tadpoles can take up iodine in large quantities and use it, there seems nothing inherently improbable in the suggestion.

According to Voegtlin and Strouse, iodized amino-acid when fed to tadpoles accelerates the metamorphosis of the animals, but fails to replace the function of the thyroid in pathological cases where there is a deficiency of thyroid function.

The work of these authors, in so far as the acceleration of metamorphosis is concerned, agrees with the results obtained in the present experiments. The function of the thyroid in pathological cases, however, may be an entirely different question.

SUMMARY AND CONCLUSION

1. Iodine and its compounds when fed to the larvae of *Rana pipiens* and *Bufo lentiginosus* stimulate metamorphosis in these animals very rapidly.
2. Inorganic iodine when fed to thyroidless larvae of *Bufo lentiginosus* brings about metamorphosis in an abnormally short time.
3. Iodine appears to function within the organism as a hormone itself without the intermediation of the gland.
4. The suggestion is made that the extraction of iodine from the blood and its storage is the chief function of the thyroid gland.

LITERATURE CITED

- ALLEN, B. M. 1918 *Jour. Exp. Zoöl.*, vol. 24, no. 3.
- BASINGER 1916 *Arch. Int. Med.*, vol. 17, p. 260.
- BAUMANN, E. 1895 *Zeits. f. physiol. Chem.*, Bd. 21, p. 319.
- BIEDL, ARTHUR 1913 *The internal secretory organs.*
- HUNT, R. 1907 *J. Am. Med. Assn.*, vol. 49, p. 1325.
- HUNT, R., AND SEIDELL, A. 1908 *Bull. No. 47. Hyg. Lab, U. S. Pub. Health and Mar. Hosp. Serv., Wash., D. C.*
- HUTCHINSON, R. 1896 *Jour. Physiol.* 20. S. 494.
- 1898 *Jour. Physiol.*, vol. 23, p. 181.
- JOLIN, S. 1896 *Festschrift. O. Hammarsten, Upsala.*
- KENDALL, E. C. 1914 *Jour. of Biol. Chem.*, vol. 20, p. 501.
- 1917 *Jour. Amer. Med. Assn.*, vol. 66, p. 811.
- LENHART, C. H. 1915 *Jour. Exp. Med.*, vol. 22, p. 739.
- MENDEL, L. B. 1900 *Am. J. Physiol.*, vol. 3, p. 290.
- MARINE, D., AND WILLIAMS, W. W., 1908, *Arch. Int. Med.*, vol. 1, p. 378
- MIWA, S., AND STOELTZNER, W. 1897 *Jahrb. f. Kinderh.*, Bd. 45, S. 83.
- MORSE, M. W. 1914 *Jour. Biol. Chem.*, vol. 19, no. 3, p. 421.
- 1918 *Biol. Bull.*, vol. 34, no. 3.
- OSWALD, A. 1902 *Arch. f. Path. Anat.*, Bd. 169, S. 461.
- 1902 *Beitr. z. Chem. Physiol. u. Path.*, Bd. 2, S. 555.
- SWINGLE, W. W. 1918 *Jour. Exp. Zoöl.*, vol. 24, no. 3, p. 521.
- 1918 *Jour. Exp. Zoöl.*, vol. 24, no. 3, p. 545.
- 1917 *Biol. Bull.*, vol. 33, no. 2, p. 116.
- TÖFFER 1896, *Wien, klin. Wehnschr.*, Bd. 9, S. 141 (quoted by Hunt and Seidell).

Resumido por el autor, W. W. Swingle.

Estudios sobre la relación del iodo con la tiroides.

II. Comparación entre la tiroides de las larvas normales de rana y la de las larvas alimentadas con iodo.

En este trabajo el autor demuestra que la ingestión del iodo y sus compuestos, iodoformo y ioduro potásico, por las larvas de rana, produce rápidamente la metamorfosis, estimulando de este modo la acción del tejido o del extracto tiroideos. El exámen microscópico de la tiroides de larvas alimentadas con iodo y el de la misma glándula de larvas normales de la misma edad, mantenidas con el mismo tamaño que los animales sujetos al experimento por medio de una nutrición deficiente, demuestra que las glándulas de aquellas son mayores que las de las larvas normales y contienen mas substancia iodada. La comparación entre la tiroides de larvas de una longitud media de 10.5 mm., alimentadas con iodo, y la de larvas normales de la misma edad pero de una longitud media de 21.5 mm., producida por una alimentación abundante, demuestra que las glándulas de ambos grupos de animales son aparentemente del mismo tamaño. El autor describe experimentos en los que se ha comparado la rapidez de acción de varios compuestos iodados sobre la iniciación de la metamorfosis. El iodo inorgánico resultó ser el mas eficiente y en segundo y tercer lugar el iodoformo y ioduro potásico, respectivamente. Los experimentos llevados a cabo para determinar la solubilidad del iodo en el suero sanguíneo normal demuestran que el del conejo a 37°C. actúa como disolvente de los cristales de iodo en una proporción de .00075 gramos de esta substancia por centímetro cúbico. El poder disolvente del suero de la rana es algo menor que el del conejo, pero considerablemente mayor que el del agua. El autor incluye en el trabajo una discusión sobre la relación del iodo con la metamorfosis de los anfibios y la función tiroídea.

Translation by Dr. José F. Nonidez,
Columbia University.

STUDIES ON THE RELATION OF IODIN TO THE THYROID¹

II. COMPARISON OF THE THYROID GLANDS OF IODIN-FED AND NORMAL FROG LARVAE

W. W. SWINGLE

Fellow in Biology, Princeton University

INTRODUCTION

In the foregoing paper (part I of these studies) the writer described the effects of feeding iodine and various of its compounds to normal and thyroidless frog larvae. It was found that the administration of iodine, iodoform, and potassium iodide greatly accelerated metamorphosis in these animals, despite the fact that normally thyroidless tadpoles never assume the adult characters.

The results obtained with feeding iodine to thyroidectomized larvae had led the writer to advance the view that iodine functions within the organism as a hormone itself, without the intermediation of the gland. Furthermore, it was suggested that the chief function of the thyroid appears to be that of iodine storage, and not, as the current view would have us believe, the elaboration of internal secretion. The present paper is a presentation of the results of a comparative study of the thyroid glands of iodine-fed and normal animals of the same age together with some additional data gathered since the publication of part I of this series on iodine feeding and amphibian metamorphosis.

MATERIAL AND METHODS

Some of the material used in the present work was obtained from the iodine-fed and control cultures described in part I. The

¹The experimental work for this paper was done while the writer was instructor in zoology at the University of Kansas.

material taken from these earlier cultures consisted entirely of *Rana pipiens* larvae. The remainder of the material was taken from cultures of iodine-fed *Bufo* larvae. All animals used were appropriately controlled with animals of the same age and reared under the same environmental conditions. The iodine-fed larvae were killed and preserved for microscopic examination when they showed marked indications of hyperthyroidism. The fixing fluid used was potassium-bichromate-acetic (Tellye-snický's). Only the lower jaw and heart region were preserved. After washing thoroughly, the tissue was placed in toto in alum-cochineal for thirty hours; washed in distilled water and run up through the alcohols to absolute. The tissue was cleared and kept in oil of wintergreen until ready for use. All measurements recorded for the glands were made with an eye-piece micrometer, Bausch & Lomb microscope, 16-mm. objective, ocular 1. The greatest length and width of the gland only were measured.

CULTURE I. IODINE-FED AND CONTROL LARVAE

The animals of this culture averaged 10.5 mm. in length when first started on the iodine diet; none of the animals revealed any indications of limb buds. Thirteen days from the date of first iodine administration all of the experimental animals showed marked symptoms of hyperthyroidism, the indications of which are characteristic in this species (*Rana pipiens*). All growth of the larvae had ceased with the first iodine feeding, and from then on had in many of the animals actually decreased, owing to tail resorption; the larvae were emaciated; tail atrophy was apparent; movement sluggish; all iodine-fed animals had well-developed hind limbs. The controls for this culture showed none of the changes enumerated, but had increased considerably in size. None of the controls had limb buds.

Table 1 gives the length of the animals of both experimental and control groups and indicates the condition of the limbs thirteen days from the beginning of the experiment. Two sets of controls were used for each iodine-fed culture, one set was fed beef and large quantities of algae each day, the other set

was fed very little in order to hold the growth of the animals in check so as to keep them approximately of the same body length as the animals of the iodine-fed culture. The length of the well-fed group of controls only is indicated in the table; the animals of the underfed culture measured 10.5 mm.

TABLE 1

IODIN-FED LARVAE		CONTROLS FOR IODIN-FED LARVAE	
Total length	Limbs	Total length	Limbs
<i>mm.</i>		<i>mm.</i>	
12.0	+	20.5	—
10.0	+	24.0	—
9.0	+	21.0	—
9.5	+	23.5	—
9.0	+	22.0	—
10.5	+	24.5	—
12.5	+	20.0	—
10.0	+	19.0	—
13.0	+	21.0	—
10.5	+	23.5	—
9.0	+	20.0	—
9.5	+	20.5	—
10.0	+	21.0	—
10.5	+	24.5	—
9.0	+	22.0	—
11.0	+	20.0	—
12.0	+	19.5	—
12.5	+	21.0	—
9.0	+	23.0	—
9.0	+	20.5	—
10.36		21.55	

Microscopic examination of the thyroid glands of this series of tadpoles revealed a rather interesting condition; the glands of the iodine-fed larvae were approximately of equal size with those of the controls. This, despite the fact that in regard to body size, the iodine-fed animals were only half the size of the controls as a glance at table 1 shows. When the glands of the iodine-fed animals were compared with those of normal animals of the same age held at 10.5 mm. by underfeeding, it was found that the iodine-fed larvae had considerably larger glands. The average

length and width of twenty thyroid glands of these underfed animals compared with those of iodine-fed and overfed animals is shown in table 2. The measurements given are of the right glands; the left glands were also measured, but as they showed nothing unusual the measurement for them are not recorded in the table.

TABLE 2
Measurements of the thyroid

IODINE-FED LARVAE		CONTROL (UNDERFED)		CONTROL (WELL-FED)	
Length	Width	Length	Width	Length	Width
<i>mm.</i>	<i>mm.</i>	<i>mm.</i>	<i>mm.</i>	<i>mm.</i>	<i>mm.</i>
0.2727	0.0909	0.1818	0.0545	0.3636	0.1270
0.3090	0.1090	0.1727	0.0545	0.3181	0.1181
0.2363	0.0818	0.1727	0.0636	0.2363	0.0909
0.3726	0.1636	0.1545	0.0545	0.2999	0.1090
0.3181	0.1270	0.1818	0.0818	0.2727	0.0999
0.2908	0.1090	0.1636	0.0727	0.2636	0.0999
0.2727	0.0999	0.1818	0.0727	0.3272	0.1270
0.2817	0.1181	0.1727	0.0636	0.2636	0.0909
0.2727	0.1090	0.1454	0.0818	0.2727	0.1090
0.2908	0.0909	0.1636	0.0454	0.3090	0.1181
0.2545	0.0909	0.1363	0.0545	0.2545	0.0909
0.2727	0.0818	0.1818	0.0727	0.2999	0.1270
0.2636	0.1181	0.1636	0.0727	0.2545	0.0999
0.2999	0.0999	0.1727	0.0545	0.2272	0.0818
0.2817	0.0999	0.1454	0.0454	0.2999	0.1090
0.2454	0.0909	0.1545	0.0818	0.2454	0.1090
0.2636	0.0818	0.1636	0.0636	0.2636	0.1181
0.2727	0.0818	0.1908	0.0909	0.3181	0.1270
0.2545	0.1090	0.1454	0.0545	0.2908	0.1181
0.2999	0.1090	0.1818	0.0818	0.2363	0.0818
0.2812	0.1031	0.1663	0.0658	0.2808	0.1076

It is obvious from these figures that the thyroid glands of iodine-fed larvae are larger than those of normal larvae of the same age and body size (held at 10.5 mm. length by under-feeding), though they are not larger than the glands of normal animals of the same age presenting marked size differences due to overfeeding. As is well known, the thyroids of frog larvae increase in size with the growth of the organism as a whole. When the fact is taken into consideration that the iodine-fed tadpoles

are just half the size of the animals of the well-fed culture of controls, it is clear the iodine-fed animals have relatively much the larger glands. Microscopic examination of the colloid content of the glands of the experimental and the two control cultures of larvae, shows a marked difference in the amount of colloid visible in the follicles. The glands of the iodine-fed animals were packed with this substance, whereas the glands of the controls showed a rather scanty amount.

Since the completion of part I of these studies, the writer has carried out several more iodine-feeding experiments in order to test various points left untouched in the earlier work. One of these points barely touched upon was the comparative rapidity of action of the various iodine compounds in accelerating metamorphosis in normal and thyroidless tadpoles. A detailed account of the experiment will not be given here, as it was for the most part a repetition of the experiments described in the earlier paper. Suffice to state here that iodine crystals when fed to frog or toad larvae with and without thyroid glands bring about metamorphic changes in the larvae much more rapidly than any of the compounds used; iodoform is somewhat slower in its action, but is much more rapid than potassium iodide. Three feeding experiments were carried out in which potassium iodate was used as food, but as only negative results were obtained the conclusion is justified that this compound has no accelerating effect upon metamorphosis. The larvae eat the substance, but apparently are unable to break it down sufficiently to release free iodine.

While engaged in the experimental work which formed the subject-matter of the previous paper, the writer was under the impression that perhaps the results obtained from feeding iodine to tadpoles were due to the mixture of flour, iodine, and water used, and not entirely to the iodine itself. This erroneous idea was due to the fact that in several earlier experiments made to test this point it was observed that frog larvae die very quickly if placed in containers with inorganic iodine crystals or in weak solutions of this substance. However, further work along this

line has shown that both normal or thyroidless frog or toad larvae will undergo metamorphosis very quickly if placed in extremely weak solutions of iodine. The defect in the earlier work was that the solutions were too strong. Just a trace of iodine in the water is sufficient to produce results if the solution is kept fresh. Cultures of tadpoles fed on wheat-flower paste showed no changes whatever when compared with beef-fed or algae-fed controls. This experiment shows clearly that iodine is the active principle of the mixture of flour, iodine, and water, fed in the previous work, and that the flour has nothing to do with the results obtained.

The fact that thyroidless tadpoles readily undergo metamorphosis when fed iodine led the writer to suggest that the function of this gland is chiefly that of iodine storage, rather than the elaboration of a specific hormone, and, moreover, that the tissues of animals are capable of utilizing iodine directly without the intermediation of the gland. In this connection the results of tests made to determine the solubility of iodine in normal blood serum may be of interest. The serum of amphibians and mammals was used; the amphibian serum was obtained from adult *Rana pipiens*, the mammal serum from rabbits. The serum of the latter at 37°C. acts as a solvent for finely ground iodine crystals to the extent of 0.00075 gram per cubic centimeter when stirred vigorously. The solvent power of *Rana pipiens* serum is somewhat less than that of rabbits, though considerably more than that of water.

DISCUSSION

The iodine-feeding experiments described in this and the preceding paper should prove of interest to students of amphibian metamorphosis, as they give a clue as to the nature of one of the underlying causes of this phenomenon. It has been assumed, and probably correctly so, that one of the prime requisites of the change from the larval to adult condition in Anurans is a heightened metabolism. The work of Gudernatsch with feeding thyroid to tadpoles showed that this substance accelerated metamorphosis, and it is generally agreed that the effect of thyroid

extract on tadpoles is accomplished chiefly by greatly accelerating catabolic activities. The writer in 1915-1916 (results published in 1918) in an experiment to test the effects of inanition upon the development of the germ cells and germ glands of frog larvae, found that starvation totally inhibits all body growth and differentiation, the animals consequently never assuming the adult condition. Such prolonged starvation undoubtedly acts as a depressor of metabolism. Later Allen observed that thyroidless tadpoles do not undergo metamorphosis, but instead grow abnormally large. In this case the absence of the thyroid function had led to a prolonging of the anabolic phase of the metabolic activities. In part I of this series of iodine studies it was shown that iodine accelerates metamorphosis in both normal and thyroidless tadpoles. The iodine effect like that of the thyroid tissue or extract (and indeed iodine seems to be the active principle of the thyroid) is in heightening catabolism.

In these four experiments there is fairly good evidence for the view that amphibian metamorphosis was due, in part at least, to heightened metabolism of the catabolic type. In a state of nature the metamorphosis of frog larvae, is under normal conditions, effected by none of the experimental agencies mentioned, except iodine. This substance is found in many plants (though perhaps accidentally present, as some authors believe); it is present in the soil in combination with other substances and present in the thyroids of most animals. Iodine in some form or other may be said to constitute a normal environmental factor of amphibians, a factor which, when considered in connection with the hereditary factors governing growth processes in larval amphibians, gives a rationale of the factors involved in the metamorphosis of these animals.

As pointed out by Morse ('18), it is impossible to bring about complete metamorphosis in extremely young larvae, when an attempt to do so is made by feeding large quantities of thyroid or iodine, the animals die. Marked metamorphic changes appear, but death usually supervenes before complete transformation takes place. A certain cycle of events must take place before metamorphosis, and this normal cycle is in all probability de-

terminated by the hereditary constitution of the organism. *Bufo* metamorphoses after a few weeks, *Rana pipiens* requires at least two months; *Rana catesbiana* is said to require two, three, and sometimes four seasons for complete metamorphosis. The difference in the time required by these amphibians to metamorphose is very great, and yet at certain stages in their life history they may all be found living together in the same pool. It is obvious that the hereditary factors controlling the growth processes play a very great rôle in determining the time of metamorphosis, and that iodine is simply an initiator of the process.

SUMMARY AND CONCLUSION

1. The thyroid glands of iodine-fed frog larvae are larger than the glands of control animals held at the same body length as the animals of the iodine-fed culture by underfeeding.
2. The follicles of the glands of such iodine-fed larvae contain much greater colloid mass than the follicles of the controls.
3. Solutions of iodine will bring about metamorphosis in both normal and thyroidless tadpoles in a short time.
4. Iodine is much more active in accelerating metamorphosis than any of its compounds. Next in order of activity are iodiform, potassium iodide. Potassium iodate appears to have no effect.
5. The suggestion is made that amphibian metamorphosis is a result of the interaction of environmental agencies, such as iodine and its compounds, with the hereditary factors controlling the growth processes.

LITERATURE CITED

- ALLEN, B. M. 1918 The results of thyroid removal in the larvae of *Rana pipiens*. *Jour. Exp. Zoöl.*, vol. 24, no. 3.
- GUDERNATSCH, J. F. 1914 Feeding experiments with tadpoles; a further contribution to the knowledge of organs with internal secretions. *Am. Jour. Anat.*, vol. 15.
1916 Studies on internal secretions. IV. Treatment of tadpoles with thyroid and thymus extracts. Reported at the thirty-third session of the Am. Asso. of Anatomists.
- MORSE, M. 1914 The effective principle in thyroid accelerating involution in frog larvae. *Jour. Biol. Chem.*, vol. 19, p. 421.
1918 Factors involved in the atrophy of the organs of the larval frog. *Biol. Bull.*, vol. 34, no. 3.
- SWINGLE, W. W. 1918 The acceleration of metamorphosis in frog larvae by thyroid feeding and the effects upon the alimentary tract and sex glands. *Jour. Exp. Zoöl.*, vol. 24, no. 3.
1918 The effect of inanition upon the development of the germ cells and germ glands of frog larvae. *Jour. Exp. Zoöl.*, vol. 24, no. 3.

Resumido por el autor, Merkel Henry Jacobs.

La aclimatación como factor capaz de afectar el punto en que
acaee la muerte de los organismos sometidos a
temperaturas elevadas

Si se conoce el tiempo necesario para producir la muerte de las larvas de estrella de mar sometidas a una cierta temperatura elevada, el tiempo necesario para producir el mismo efecto a cualquier otra temperatura puede determinarse con un grado muy aproximado de exactitud. En general, el coeficiente de temperatura es próximamente 2 para cada elevación térmica de 1°C. El coeficiente de temperatura de *Paramecium* bajo condiciones semejantes está mucho más sujeto a variación, pudiendo ser 3 o mas algunas veces, en otras ocasiones menos de 2. Durante la elevación gradual de la temperatura en las larvas de estrella de mar, se suman los efectos nocivos de todas las temperaturas por las cuales han pasado durante dicha elevación y mueren casi en el mismo momento en que se alcanza el punto en que deben morir teóricamente como resultado de la suma de todos los efectos nocivos. El punto en que tiene lugar la muerte del animal es tanto más bajo cuanto más lenta es la elevación de la temperatura. En *Paramecium*, por el contrario, el punto en que el animal muere es tanto más alto cuanto más lenta es la elevación de la temperatura. En esta especie la aclimatación modifica las relaciones tan simples que se presentan en la larva de la estrella de mar. El grado de aclimatación en una forma determinada puede estimarse cuantitativamente determinando el "exceso de resistencia" (surplus resistance) mediante el método que el autor describe en el trabajo. Medido en términos de cantidad de efectos nocivos necesarios para producir un resultado fatal, este "exceso de resistencia" es próximo a cero en las larvas de estrella de mar, mientras que en *Paramecium* llega a ser 45. Estas cifras dan una medida aproximada de la capacidad de adaptación a temperaturas más y más elevadas en las dos especies mencionadas.

Translation by Dr. José F. Nonidez,
Columbia University.

ACCLIMATIZATION AS A FACTOR AFFECTING THE UPPER THERMAL DEATH POINTS OF ORGANISMS

M. H. JACOBS

University of Pennsylvania

1. INTRODUCTION

The question of the effects produced on organisms by high temperatures is one which has received the attention of biologists for many years. The older workers were interested chiefly in the determination of the so-called 'upper thermal death points.' A résumé of their observations is given by Davenport ('97). In more recent times, the importance of the time factor, overlooked in this earlier work, has been recognized, and modern investigators have been more concerned with 'temperature coefficients' (Pütter, '14; Kanitz, '15) and with the possible causes of injury at the elevated temperatures. In most of the recent, and in practically all of the older work, however, a factor not sufficiently taken into account is the method by which the temperatures used in the experiments have been attained.

There are, in general, three chief ways of bringing an organism to a given high temperature. 1) The change may be practically instantaneous, as, for example, if a minute animal in a small quantity of water is suddenly expelled from a pipette into a large volume of water at the required temperature. 2) The change may be gradual, but uniform, as, for example, if the animal is placed in a vessel of water at room temperature, and heat applied in such a way that the rise per minute remains constant until the desired point is reached. 3) The change may be gradual, but at a constantly decreasing rate, as, for example, if the animal is placed in a test-tube containing water at room temperature, and the test-tube is then plunged into a large

vessel of water which is kept at the final temperature. In this case, the rise is at first rapid, becoming progressively slower and slower—being represented, in fact, by the logarithmic curve of Newton's well-known 'law of cooling bodies,' except that the temperature in this case is increasing instead of decreasing.

Of the three methods mentioned, the third is generally undesirable, partly because of the greater difficulty of making allowance for a constantly changing rate of temperature increase, partly on account of the difficulty of determining the exact time when the desired temperature has been reached, and chiefly because of the great length of exposure (due to the slow rate of change as the end point is approached) to temperatures whose effects are almost as great as those of the one finally attained. Method 1, in exact work, is applicable only to very small organisms, since any attempt to apply it to large ones results in securing essentially the effects of method 3, with the additional disadvantage that on account of the slow conduction of heat, different parts of the body reach the final temperature at different times. Method 2, therefore, which involves raising the temperature at a known rate until the desired point has been reached, is the most suitable one for all except very small organisms and has been most frequently employed. But in the past very little effort has been made to take into account the influence on the final result of the rate at which the temperature is raised. That this factor is probably of importance is obvious, but to predict in advance in what direction and to what extent it will operate is not always an easy matter.

Suppose, for example, that in a certain experiment a lot of organisms are brought in the course of ten minutes from room temperature to 40°C . and kept at the latter point until death occurs. Would the time required to cause death at 40° be greater, or less, if in another similar experiment the preliminary rise were allowed to occupy thirty minutes instead of ten? It might be argued, on the one hand, that the slower rate would be less favorable to the organisms than the rapid one because of the greater length of exposure to temperatures below 40° , but still sufficiently high to produce in the aggregate considerable

injury before the final temperature had been attained. The possibility exists, however, on the other hand, that the slower rate would be more favorable than the rapid one in giving greater opportunity for adjustment or acclimatization to occur. Which of these two alternatives is the correct one for a given form can, as a matter of fact, be decided only by experiment.

In the present paper a method is suggested for determining this point and for dealing quantitatively with certain other aspects of the general problem of acclimatization. The writer wishes to express his indebtedness to Prof. F. R. Lillie for kindly placing at his disposal on several occasions the facilities of the Marine Biological Laboratory at Woods Hole and to Mr. Francis H. Adler for assistance in making certain of the observations on which the paper is based.

2. MATERIAL AND APPARATUS

In the experiments to be described, the use of both methods 1 and 2 was necessary for the quantitative estimation of the extent to which acclimatization occurs. For this reason, only small organisms were employed, starfish larvae eighteen to forty-eight hours old and *Paramecium caudatum* being the ones chosen. The medium in which they were heated was for the starfish larvae fresh sea-water and for *Paramecium*, in most cases, the natural culture fluid filtered to remove all animals. It was recognized that the complex nature of the culture fluid might introduce undesirable complicating factors, but preliminary experiments showed that, as a matter of fact, distilled water, which would naturally have been preferred on account of its uniform composition and in which the animals lived normally at room temperature for days, was quite unsuitable for sudden exposures to high temperatures, the animals dying far more quickly in it than in their own culture medium, and the results obtained being markedly irregular. That at least part of the effect of the distilled water was of an osmotic nature was shown by the fact that the addition to the same water of slight amounts of neutral salts or even of cane sugar made it considerably less injurious. It

is perhaps possible also that the absence of appreciable amounts of 'buffer substances' may have been another of the factors concerned, since there is some evidence of the production of abnormal amounts of acids at elevated temperatures. At any rate, it was found that apparently the most reliable results could be obtained when normal culture fluid was used, although very similar results were also secured in some cases with pond-water when the animals had been kept in it for at least twelve hours previous to the experiments.

The apparatus employed was of a simple nature. It consisted of a 2-liter beaker, used as a water-bath, supported on a stand and heated from below by an alcohol lamp whose position could be altered to furnish much or little heat as desired. In the beaker were placed a number of test-tubes containing enough water or culture fluid to make them float upright. The transparency of the whole apparatus was found to be of advantage, not only in favoring such manipulations of the material as were necessary, but in making it possible to observe the visible effects of the high temperature on, for example, the movements of the animals.

When a sudden exposure was desired, the water in the water-bath and in the test-tubes was first allowed to assume the proper temperature, and then a considerable number of the organisms were taken in the smallest possible quantity of water in a capillary pipette (this being very easy in the case of both of the animals used on account of their habit of collecting in a dense ring around the edges of the culture jar) and suddenly forced into one of the test-tubes in such a way as to insure thorough mixing. The quantity of water used was so small as practically not to affect the temperature of the water in the test-tube, calculation showing that the momentary lowering of its temperature, which was not even indicated on an ordinary mercurial thermometer, could not have been, as a rule, more than 0.1°C . After this sudden introduction to the temperature of the experiment the organisms were either all allowed to remain in the test-tube for the required length of time and then suddenly poured into sufficient cool water to bring them back immediately to within their normal

range of temperature, or they were removed, a few at a time, at the proper intervals with a capillary pipette.

Where a gradual rate of temperature increase was desired, the same general methods were employed except that the animals, instead of being introduced suddenly into the test-tubes, were placed in them at room temperature and the whole apparatus was heated at the desired rate, samples of the animals being removed, usually at half-degree intervals. The animals, whether suddenly or gradually exposed, were kept under observation after removal in Syracuse watch-glasses until they had either died or recovered, which in some cases required as much as twenty-four hours, although as a rule their behavior when first examined left little doubt as to the ultimate outcome of the experiment.

3. METHOD OF ESTIMATING ACCLIMATIZATION

The extent to which acclimatization occurs during a slow rise of temperature may theoretically be estimated by first finding by method 1 (where there is no opportunity for preliminary acclimatization to occur) the amount of injury inflicted in unit time at the various temperatures passed through during the rise, and in them adding together these separate injuries, beginning with the lowest temperature, and taking into account the duration of each, until a total just sufficient theoretically to cause death is arrived at. The point at which this total is reached is compared with the observed death point in the case of the gradual rise. If the two points practically coincide, it may be said that there is no evidence of acclimatization. If, on the other hand, the observed death point is higher than the calculated one, the presumption is that acclimatization has occurred and the amount of the latter can be estimated, roughly at least, in quantitative form. It must be remembered, of course, that the calculated death point cannot be determined by merely adding the theoretical amounts of injury at, for example, 34° , 35° , 36° , etc., since the rise does not proceed by a series of sudden jumps, but continuously. Since, however, the relation of

the amount of injury inflicted in unit time at any one temperature to that inflicted in the same time at any other temperature is, for a certain range, in the forms studied, governed by a simple mathematical law, it is possible by making observations at a few selected temperatures, and thus determining the necessary constants, to calculate the theoretical effect of a continuous change of temperature at any desired rate. The details of the method will be made clearer in the following sections where the actual experiments are discussed.

4. EXPERIMENTS ON STARFISH LARVAE

Since the results obtained with starfish larvae are simpler than those with *Paramecium*, they may be considered first. In table 1 are given the lengths of exposure found to cause death when the animals were suddenly subjected by method 1 to the temperatures in question. The fatal exposure in each case is

TABLE 1

Times required to kill approximately one-half of the individuals of starfish larvae when suddenly subjected to various temperatures

TEMPERATURE deg. C.	JUNE 16, 18 HOURS OLD.		JUNE 21, 48 HOURS OLD		JUNE 22, 24 HOURS OLD		JUNE 23, 24 HOURS OLD
	Fatal exposure	Q ₁	Fatal exposure	Q ₁	Fatal exposure	Q ₁	Fatal exposure
40	8 seconds		10 seconds				
		1.9		1.8			
39	15 seconds		18 seconds				
		1.5		1.7			
38	23 seconds		30 seconds				
		2.2		1.7			
37	50 seconds		50 seconds		45 seconds		35 seconds
		1.5		1.9		2.0	
36	1.25 minutes		95 seconds		1.5 minutes		
		2.2		2.2		2.7	
35	2.75 minutes		3.5 minutes		4 minutes		2.5 minutes
		2.5		2.3		2.0	
34	7 minutes		8 minutes		8 minutes		
		2.1				2.5	
33	15 minutes				20 minutes		13 minutes
						2.3	
32					45 minutes		30 minutes

taken somewhat arbitrarily, as the time required to produce injuries from which approximately half of the individuals failed to recover. The actual death of the animals, according to the temperatures employed, may occur in from a few minutes to twenty-four hours or more after restoration to normal conditions. Undoubtedly such differences are in certain respects significant, but for purposes of immediate comparison they may be disregarded and the degree of injury which is just sufficient ultimately to lead to death, regardless of the time required, may be accepted as the most satisfactory available criterion. It may be mentioned that the starfish gastrulae obtained from a single lot of eggs show little individual variation; the fatal exposure is very nearly the same for all. In this respect they differ from *Paramecium* in which the individual differences are large.

It will be noticed in table 1 that the time required to produce fatal injury at any temperature bears a fairly definite relation to the time required at other temperatures. Thus, at 34°, for example, about twice as long a time is required as at 35° and about one-half as long a time as at 33°. Expressed in mathematical symbols,

$$\frac{L_{\theta}}{L_{\theta+1}} = Q_1 = 2$$

where L denotes the length of life, θ the temperature, and Q_1 the temperature coefficient for a change of one degree. Values of Q_1 are given in alternate columns of table 1. The general average of all of the values of Q_1 is 2.1. This value agrees closely with that found, for example, by Loeb ('08) for the eggs of *Strongylocentrotus* and Moore ('10) for *Tubularia crocea*.

These results may also be stated in another form (table 2). The amount of injury (I_{θ}) inflicted at the temperature θ by an exposure of unit time (one minute) can be expressed in quantitative form by taking as unity the amount of injury just sufficient to produce death. Thus at 38°, in the series selected for table 2, where an exposure of twenty-three seconds is necessary to cause death, $I_{38^{\circ}} = 2.6$; in the same way $I_{34^{\circ}} = 0.14$; and the other values are given in column 2 of table 2. The mathematical

TABLE 2

*Theoretical amounts of injury inflicted on starfish larvae at various temperatures.
The fatal exposures are taken from column 1 of table 1*

TEMPERATURE	TOTAL EXPOSURE	INJURY IN UNIT TIME
<i>deg. C.</i>	<i>seconds</i>	
40	8	7.5
39	15	4.0
38	23	2.6
37	50	1.2
36	75	0.8
35	165	0.36
34	420	0.14
33	900	0.07

relation that exists between the amounts of injury inflicted in unit time at different temperatures is

$$I_p = I_0 Q_1^p$$

where I_0 is the amount of injury inflicted at the temperature chosen as the standard for comparison, and I_p the amount inflicted at any other temperature separated from the first one by p degrees. If the second temperature is lower than the first, p , of course, has a negative sign. Of the two constants in the above expression, Q_1 may in general be taken for starfish larvae with sufficient accuracy as equal approximately to 2, and I_0 may be determined experimentally for a given lot of organisms for any convenient temperature, preferably a rather low one, as the percentage of error is then less. Having these two constants, it is possible to calculate not only the amount of injury that would be inflicted by an exposure of any length to any temperature to which the above equation applies, but likewise the amount of injury that ought theoretically to be inflicted during a gradual rise from room temperature to any desired temperature. In the latter case, the amount of injury would be represented graphically by the area of the curve:

$$y = a Q_1^x$$

between the limits $x = -b$ (room temperature) and $x = p$ (the highest temperature attained); b and p , of course, being measured from the temperature selected as the point of comparison. The constant a is the amount of injury, I_0 , inflicted in unit time at this temperature. The area of the curve, A , which represents the total injury, I , therefore is:

$$A = I = a \int_{-b}^p Q_1^x dx = a \left(\frac{Q_1^p}{\log_e Q_1} - \frac{Q_1^{-b}}{\log_e Q_1} \right)$$

Since b (the number of degrees the room temperature lies below the temperature chosen for comparison) is relatively large, the second half of the expression within the parentheses becomes negligibly small and may be disregarded. This is equivalent to calculating the injury that would be inflicted in a rise from an infinitely low temperature instead of from room temperature, but this amounts to practically the same thing, since even considerably above room temperature the injury inflicted in any ordinary time has ceased to be appreciable.

If instead of raising the temperature at the rate of one degree per minute as implied in the calculation just given, the rate had been slower, say one degree in t minutes, the right-hand side of the equation would have to be multiplied by t . The general expression therefore for the area, A , which represents the total injury, I , inflicted up to the temperature p° when the rate of rise is one degree in t minutes becomes (when a is replaced by its equivalent I_0):

$$I = t I_0 \cdot \frac{Q_1^p}{\log_e Q_1}$$

In the case of starfish larvae where Q_1 is equal to approximately 2.0 and $\log_e Q_1$ therefore to approximately 0.7 we have finally:

$$I = t I_0 \cdot \frac{2^p}{0.7}$$

In case it is desired to know how high the temperature would have to be raised to inflict just fatal injury, it is only necessary

to substitute for I the numerical value 1.0 and solve the equation for p. In such cases (taking $\log_{10} 2 = 0.3$)

$$p = \frac{\log_{10} \left(\frac{0.7}{tI_0} \right)}{0.3} \quad ?$$

The results of applying this method to a gradual and regular rate of temperature increase in the case of starfish larvae are shown in table 3. In the first column is given the rate at which the temperature was raised, in the second the observed death point, and in the third the point at which death ought theoretically to have occurred (i.e., the point at which the area enclosed by the curve becomes unity) when the value of the constant, Q_1 , was taken as equal to 2 (this value holding approximately for all of the starfish larvae studied). The value of I_0 , which varies somewhat for different lots of larvae according to age, etc., was determined especially for the animals used in these experiments, and was found to be 0.05 at the temperature (33°C.) chosen for comparison.

It must be recognized, of course, that for the portion of the curve between room temperature and 32°, no exact observations are available, and it is uncertain to what extent the above equation applies to it. But the area of this portion of the curve is in any case so small as compared with that above 32° that the final result would be little affected even if a different relation were

TABLE 3

Temperatures at which death of starfish larvae occurred after varying rates of temperature increase from a starting point of approximately 20°C.

RATE OF TEMPERATURE INCREASE IN DEGREES PER MINUTE	OBSERVED DEATH TEMPERATURE	THEORETICAL DEATH TEMPERATURE CALCULATED FROM $Q_1 = 2.0$	THEORETICAL DEATH TEMPERATURE CALCULATED FROM $Q_1 = 2.2$
1°C. in 1.8 minutes	About one-third dead at 36.0°	36.0°	35.8°
1°C. in 4 minutes	35.0°	34.8°	34.8°
1°C. in 5 minutes	34.5°	34.5°	34.5°
1°C. in 8 minutes	All living at 33.5°, all dead at 34.0°	33.8°	33.9°

shown to hold in this region. It may also be noticed that for the region from 32° to the point of death in these particular experiments the value of Q_1 is in general higher than 2.0, the approximate average value for the whole range of temperature studied. In the last column of table 3, the theoretical death temperature is therefore calculated for comparison from the value, $Q_1 = 2.2$. It will be noticed that in either case the calculated death temperature lies within a few tenths of a degree of that actually observed, and the amount of acclimatization that has occurred, if any, is consequently extremely small. In similar experiments on Paramecium, immediately to be described, the difference may amount to several degrees.

5. EXPERIMENTS ON PARAMECIUM CAUDATUM.

In the case of Paramecium, the results are more complicated. In the first place, there is considerably more cultural and racial variation in the length of life at any given temperature (determined by method 1) than in the case of starfish larvae where the results, on the whole, seem to be remarkably uniform. This is shown in table 4 where some of the results obtained with this form are summarized.

The figures in columns 6 and 7 and probably in column 1 are for the three-vacuolated race described by Hance ('15, '17), which

TABLE 4

Times required to kill approximately one-half of the individuals of Paramecium caudatum of different races at different temperatures

TEMPERATURE	RACE 1 (?)	RACE 2	RACE 3	RACE 4	RACE 5	RACE 6	RACE 6
<i>deg. C.</i>							
43	30.0 sec.					15 sec.	30 sec.
42	1.5 min.	15.0 sec.	20.0 sec.	20.0 sec.	20 sec.	1 min.	2 min.
41	4.5 min.	45.0 sec.	45 sec.	1.0 min.	1 min.	8 min.	4 min.
40	13.0 min.	2.5 min.	2.5 min.	2.5 min.	5 min.	20 min.	7 min.
39	18.0 min.	3.0 min.	3.0 min.	4.0 min.	9 min.		18 min.
38			3.5 min.	7.0 min.			
37			4.0 min.				
36			6.0 min.				

in these, as well as in other experiments, has shown itself to be remarkably resistant to high temperatures as compared with the ordinary races. In the second place, the temperature coefficient, Q_1 , in a given set of experiments is subject to far more variation than in the case of starfish larvae, being as a rule much higher (usually approximately 3) in the region above 40° than in that below this temperature, and being subject at all times to considerable and sometimes inexplicable fluctuations. For this reason, calculations made by the method described are not so exact as in the case of the starfish larvae, but fortunately this is not necessary since *Paramecium* shows such a high degree of acclimatization that the error due to the simplifying assumption that the value, $Q_1=3$, applies to all temperatures is not able to disguise this fact. In other words, the error that arises from taking this value of Q_1 for the entire range, while, as a matter of fact, it is considerably less at lower temperatures, is of such a nature as simply to make the difference between the calculated and observed death points less striking than it would otherwise have been. If acclimatization is shown when such a simplifying assumption is made, it would a fortiori be indicated if more exact calculations had been made.

This point will be made clearer by an actual example. It was found in one set of experiments that for the three-vacuolated race, Q_1 between 40° and 43° was equal to almost exactly 3.0. The length of life after a sudden exposure to 41° was found to be 4.5 minutes, i.e., I_0 (taking this temperature as the standard of comparison) was equal to 0.22. It was also found that when the animals were heated gradually, at the rate of 1° in eight minutes, the observed death point was very close to 44° . The calculated death point, on the assumption that Q_1 is equal to 3.0 for all temperatures is approximately 40.6° , a difference of 3.4° , indicating a very considerable amount of acclimatization. If instead of assuming that below 40° the injury at any temperature in unit time is only one-third as great as that at the temperature one degree higher (as implied by the value, $Q_1=3$), we had taken into account the lower values of the temperature coefficient which usually apply to this region, it is clear that the amount of

injury inflicted at the temperatures below 40° would not drop off so rapidly, or, in other words, that the animals would be more injured during their gradual rise by the time they had reached 40°, and that consequently the calculated death temperature would be even lower than before. But this would only make stronger the evidence of acclimatization already obtained by the rough calculation.

It is of some interest not merely to show that acclimatization occurs, but to attempt to express its extent in quantitative form. This can be done in an approximate fashion by calculating the area enclosed by the given curve up to $\theta = 44^\circ$ and comparing this area with that which represents unit injury, i.e., death. Such results, of course, are only rough approximations, but have nevertheless a considerable interest. Using the formula already given:

$$I = t I_0 \cdot \frac{Q_1^p}{\log_e Q_1}$$

the area in the case just mentioned proves to be 44 units of injury. In other words, before death occurred, during the gradual rise, the animals had withstood about forty-four times the usual fatal injury. It is suggested that in this and in similar cases the excess in area enclosed by the curve of injury, up to the point of death, over the area (taken as unity) which represents an amount of injury just fatal when the change is sudden, may be called the surplus resistance, and be used as a rough quantitative measure of the extent of acclimatization. In this case the surplus resistance is equal to 43. The animals have, in other words, added to their normal lives, so to speak, forty-three additional lives by their ability to adjust themselves to the changing environment.

The favorable effect of a slow as compared with a rapid rise of temperature on *Paramecium* is shown by another experiment in which method 3 was combined with method 2. In this case, a tube of very small caliber (3 mm.) with extremely thin walls was prepared by drawing out the lower portion of a thin-walled test-tube in a flame to a considerable length and sealing the small

end. Drops of water containing *Paramecium* could be placed in it and removed with a capillary pipette. It was found by the insertion of a thermocouple in such a drop of water and another in a vessel of water at 41°C. into which the tube was plunged, that the water in the tube reached approximately the temperature of that in the surrounding vessel in about twenty seconds. This fact being known, a number of animals were placed in it and plunged into water at 41° for two minutes and twenty seconds (giving therefore an exposure of two minutes at 41°). On removal, it was found that all were fatally injured. Another lot were placed in the same tube, but they were brought at a uniform rate from room temperature to 41° in two minutes and then kept at exactly 41° for two minutes longer. In this case about one-quarter of the individuals recovered. A third lot were treated in the same way except that in this case the rise to 41° occupied twelve minutes. About one-half of these animals recovered. Doubtless a slower increase of temperature would have given even a higher percentage of recoveries. With starfish larvae, it may be mentioned, that experiments made in the same manner showed in every case exactly the reverse effect, i.e., the slower the rate of temperature increase, the higher the mortality.

A considerable number of other experiments were tried with *Paramecium* with the same general results as those mentioned. The degree to which a slow change increased the final resistance varied considerably with different races and under different experimental conditions, but in all cases it was very appreciable. It is apparent, therefore, that in the case of this organism, at least, the upper thermal death points that will be obtained in different experiments by the methods usually employed may be expected to be subject to considerable variations, which in many cases will be difficult to predict. To what extent the same principle will be found to apply in the case of other organisms can be determined only by further observations. In any event, however, the author believes that to be of value, data on the upper thermal death points of organisms must include not only the length of

exposure to the particular fatal temperature under consideration, but in addition, an exact statement of the manner in which this temperature was reached.

SUMMARY

1. The length of life of starfish larvae eighteen to forty-eight hours old at temperatures between 32° and 40°C. is governed with a very fair degree of accuracy by the relation:

$$\frac{L_{\theta}}{L_{\theta+1}} = Q_1 = \text{approximately } 2.$$

For *Paramecium*, the value of Q_1 is subject to considerably more variation; above 40°C. it is frequently in the vicinity of 3; below 40° often less than 2.

2. Knowing the above relation and the length of life after a sudden exposure to one or more selected temperatures, it is possible to calculate by the method given in the body of the paper the point at which death ought theoretically to occur when the temperature is raised uniformly at any given rate. By comparing this point with the observed death point under the same conditions, it can usually be determined whether or not acclimatization has occurred.

3. With the different rates of temperature increase employed in these experiments the observed death points of starfish larvae agree very closely with the calculated ones, indicating practically no acclimatization. With *Paramecium caudatum* the observed death point may be much higher than the calculated one, indicating that acclimatization occurs even in experiments of short duration.

4. If desired, the 'surplus resistance' in a given experiment may be obtained in quantitative form by determining the excess in area enclosed by the curve of injury up to the point of death, over the area (taken as unity) which represents an amount of injury just fatal when the temperature is changed suddenly.

5. As determined in this way, the 'surplus resistance' for starfish larvae for a number of different rates of increase of tempera-

ture was found to be in the vicinity of zero. For *Paramecium caudatum*, on the other hand, a 'surplus resistance' as high as 43 has been found.

6. In general, the slower rates of temperature increase are more favorable for *Paramecium* and more unfavorable for starfish larvae than the more rapid ones.

7. It is suggested that future data on upper thermal death points, etc., shall include not only the times of exposure to the temperatures in question, but exact statements as to the methods by which these temperatures have been reached.

LITERATURE CITED

- DAVENPORT, C. B. 1897 *Experimental Morphology*. New York. Vol. 1.
- HANCE, R. T. 1915 The inheritance of extra contractile vacuoles in an unusual race of *Paramecium caudatum*. *Science*, N.S., 42.
- 1917 Studies on a race of *Paramecium caudatum* possessing extra contractile vacuoles. *Jour Exp. Zool.*, vol. 23.
- KANITZ, A. 1915 *Temperatur und Lebensvorgänge*. Berlin.
- LOEB, J. 1908 Über den Temperaturkoeffizienten für die Lebensdauer kaltblütiger Tiere und über die Ursache des natürlichen Todes. *Pflüger's Archiv*, 124.
- MOORE, A. R. 1910 The temperature coefficient of the duration of life in *Tubularia crocea*. *Arch. Entwickl.*, Bd. 29.

472^a

11

Resumido por el autor, G. M. White.

La asociación y distinción de los colores por los peces *Umbra limi* y *Eucalia inconstans*.

Los peces de agua dulce *Umbra limi* y *Eucalia inconstans* fueron enseñados a asociar los alimentos con un cierto color y al mismo tiempo a asociar sustancias insípidas, tales como el papel, con otro color. Los individuos de *Umbra* distinguían entre sí las siguientes luces monocromáticas: roja y verde, roja y azul, amarilla y verde. La variación de intensidad de las luces roja y verde desde 1.4 cm. hasta 4.9 cm. no impide la distinción del color por parte de los peces, indicando esto que su reacción en tales circunstancias se debe más bien al color de la luz que a su intensidad. Mientras que los individuos de *Eucalia* distinguían entre las luces roja y verde, asociándolas con el alimento y el papel, nunca pudieron aprender a diferenciar el azul del amarillo. Ambas clases de peces fueron también sometidos a la acción de la luz transmitida a través de placas fotográficas veladas con diferentes tonos de gris, para probar si podían asociar con ellas los alimentos y sustancias insípidas, conforme habían hecho con las luces de otros colores. Tal asociación no se llevó a cabo, lo cual prueba aún mejor que la distinción de los colores por parte de estos animales se debe más bien a sus longitudes de onda que a su intensidad. Los experimentos efectuados con ambos peces para comprobar si pueden percibir diversos dibujos dieron tan solo resultados negativos, indicando esto que su distinción así como la de las diferencias en los fondos no son de gran importancia en la busca del alimento. La percepción del color y la del movimiento parecen ser de la mayor importancia para este fin.

Translation by Dr. José F. Nonidez
Columbia University

PT. OF NO. 1, P. 1-3
SER. 1010.

ASSOCIATION AND COLOR DISCRIMINATION IN MUDMINNOWS AND STICKLEBACKS

GERTRUDE MAREAN WHITE

Department of Zoology, University of Wisconsin

TEN FIGURES

CONTENTS

Introduction.....	444
Review of literature on the behavior of fishes.....	444
General review of literature on color vision in fishes.....	446
Conditions of experimentation.....	452
Instinctive movements.....	453
Periodic activities and daily rhythm of the mudminnow.....	453
Sense organs used in seeking food.....	455
Color discrimination.....	456
Experiments performed upon the mudminnow.....	458
Colored papers.....	458
Monochromatic light filters.....	462
Constant and varied intensity of illumination.....	466
Monochromatic green and yellow filters.....	469
'Fogged' photographic plates.....	474
Summary of experiments in regard to color vision of mudminnows.....	475
Experiments performed upon the stickleback.....	475
Monochromatic blue and yellow filters.....	481
Monochromatic red and green filters.....	481
Aquarium of sticklebacks.....	483
'Fogged' photographic plates.....	485
Summary of results in regard to color vision in fishes.....	485
Experiments on the discrimination of patterns.....	488
Associations formed by fishes.....	489
Types of associations.....	489
Delicacy of associations.....	491
Complexity of associations.....	491
Permanence of associations.....	492
Modification of associations.....	492
General discussion and conclusions.....	493
Summary.....	494

The behavior of fishes has been a subject of special interest to a large number of scientific investigators. While observations have been made upon a number of species, insufficient evidence has thus far been brought together to furnish a basis for the comparison of various aspects of the psychology of fishes with those of other vertebrates. In connection with this general problem, a series of experiments on the behavior of the mud-minnow, *Umbra limi* (Kirtland), and the stickleback, *Eucalia inconstans* (Kirtland), were undertaken to determine their ability to form associations and to discriminate colors and patterns. These experiments were performed in the Zoological Laboratories of the University of Wisconsin. The problem was suggested by Prof. A. S. Pearse, from whom valuable criticism and assistance were received.

REVIEW OF THE LITERATURE ON THE BEHAVIOR OF FISHES

The gustatory and olfactory senses of fishes have been studied by Parker, Copeland, and Herrick. Herrick ('03) concludes that the bullhead, the shiner, and the spotted sucker perceive their food through gustatory sense organs. They detect food from a distance and exhibit a 'seeking reaction.' The gadoid fishes (pollock, hake, tomcod) are stimulated to take food by the gustatory sense, which is located on the fins as well as about the mouth. The tactile sense is also used in finding food, combined with the gustatory sense in these gadoid fishes. Parker ('10, '11, '12, '13) shows that a true sense of smell, distinct from taste, exists in the bullhead, the dogfish, and the killifish. He defines smell in water as the perception of very dilute substances emanating from a distance; taste as the perception of substances near at hand and present in comparatively large amount. Copeland ('12) shows that the puffer possesses a sense of smell by which it is able to discover hidden food.

That fishes are able to hear is a tradition universally accepted by fishermen. Yet Bateson ('89-90) asserts that fishes are not disturbed by sounds made in the air, and that on the whole shocks and concussions do not play much part in the activities of fishes.

Parker ('03, '08, '10, '11) believes that certain sounds of low vibration, like the discharge of a gun, are heard and that the sacculus is the chief organ of hearing.

According to Parker ('04), the lateral line organs are genetically related to the ear, and are not stimulated by light, heat, salinity of the surrounding water, food, carbon dioxide, oxygen, foulness of the water, currents, or sound, but by vibrations of low frequency—about six per second. Since these organs appear to be affected by such stimuli as disturbances caused by winds and by bodies falling into the water, they may be of significance in orientation, but take no more part in equilibration than the skin, and are less important in this connection than the eye and ear.

The sense of touch is well developed in fishes. Bateson ('89-'90) states that the sole appears to use this sense in discovering its food. Herrick ('03) finds that the gadoid fishes which he observed detect their food by means of the tactile sense combined with gustatory.

Shelford and Allee ('13, '14) made elaborate experiments showing that fishes may react in various ways to gradients of dissolved gases, but no study was made of the sense organs concerned. The resistance of fishes to different concentrations of oxygen and carbon dioxide is discussed by Wells ('15).

In a delicate and ingenious series of experiments, Lyon ('04) proved that the reaction to current in the killifish, the scup, the stickleback, and the butterfish is an optical reflex—as the fish is carried down stream by current, the bottom of the stream appears to move in the opposite direction; the fish has a tendency to follow its passing field of vision, and consequently swims against the current.

Experiments to show that goldfish and *Fundulus* can find their way through mazes are reported by Churchhill ('16) and Thorndike ('11), respectively.

Eigenmann ('00) shows that the integumentary nerves of the blind fishes, *Chologaster* and *Amblyopsis*, are sensitive to light. According to Parker ('05, '09), the same is true of ammocoetes; but no salt-water fishes which he observed possessed such photo-

receptors on the skin. Tschermak ('15) gives a good survey of vision in fishes, in which he discusses conditions of vision in water, the absorption of light by water, the formation of an image in the fish eye, accommodation, and bifocal vision.

LITERATURE ON COLOR VISION IN FISHES

The question of color perception in fishes has been a matter of considerable dispute and evidence concerning it has been accumulated from various sources.

Adaptation to background by the pigment cells of the skin. The expansion and contraction of pigment cells in such a way as to conform the color and pattern of the skin to the background against which the animal rests have been observed in many fishes. If such changes in the pigment cells are brought about by stimulation received through the eyes and central nervous system, they may serve as evidence of color vision. Lowe ('17) states that the cells of the brook-trout begin to react to background after the yolk-sac is absorbed. When the trout are placed in a dark dish, the pigment cells expand, making the fishes appear dark; but when the fishes are in a light dish, the cells are contracted, giving the skin a pale appearance.

Frisch ('12, '14) finds that *Crenilabrus roissali* changes in color when subjected to red, green, and blue light. Adaptation to green and blue light is by means of the contraction of the pigment cells and also by an increase of the blue-green coloring matter. He argues that the adaptation is to color rather than to luminosity, for if the colors used are arranged as they would appear according to their intensity to a color-blind person—yellow, green, blue, red—the fish is reacting to the brightest by contraction and to the darkest by expansion. This is contrary to all other experiments on the reaction of pigment cells. Frisch also finds that *Phoxinus laevis* adapts itself to green, blue, and violet by the contraction of its pigment cells which produces a lighter color, and to red and yellow by expansion of the red and yellow pigment cells; the color patterns remaining unchanged for months under constant stimulation. The color markings

of the skin conform to the general background rather than to some particular part. In males the reactions are more pronounced than in females. Frisch concludes that the stimulus is received through the eye, since blinded fishes show no adaptive changes.

Sumner ('11) states that the skin of the flatfishes, *Rhomboidichthys podas*, *Phombas laevis*, and *Lophopsetta maculata*, shows adaptation in pattern, shade, and color. They react to black, brown, and gray, but not to red and yellow. Such changes take place irrespective of the intensity of illumination.

Mast ('14) finds that the flounders, *Paralichthys* and *Ancylosetta*, simulate their background in shade, color, and pattern, exhibiting a remarkable ability to mimic blue, green, yellow, orange, pink, and brown backgrounds. Production of color changes is regulated by stimulation through the eye and depends upon the length of the light waves. That this indicates color vision is supported by the fact that flounders adapted to blue and green, when allowed a choice of backgrounds of different colors, prefer the background with which they harmonize in shade and color.

In his observations on coral-reef fishes, Longley ('14, '15, '17) finds that color changes in the pigmentation of the skin are common among even the most brightly tinted fishes, and that the colors have a tendency to resemble those of the surroundings.

In general, these observations seem to indicate that fishes of various genera exhibit adaptive reactions in their pigment cells to backgrounds of various colors, that the stimulus is received by the eye and transmitted through the central nervous system.

Mating colors. Bright colors, particularly reds and yellows, appear on the ventral side of the males of many species at the time of spawning. The amount of light at the place of spawning must be sufficient for the female to perceive the colors if they have any recognition value. Frisch ('12) cites examples of fishes possessing such colors and spawning in shallow water by day light and also of fishes spawning in deep water or at night which do not exhibit decorative coloration.

Warning coloration. There seems to be no valid case of warning coloration in any animal fed upon by fishes. Reighard ('08) tried to discover whether the conspicuousness of coral-reef fishes might not have this significance. He found that the gray snapper could be taught to avoid snapping at red fishes when they were treated so as to be unpalatable, but that when none were artificially treated the gray snapper devoured all species of coral-reef fishes with the same avidity. Longly ('17) rejects the hypothesis of warning coloration as accounting for the bright colors of coral-reef fishes.

Choice of colored lights and backgrounds. The method has been tried of illuminating different parts of an aquarium containing fishes with lights of different colors, or of placing variously colored papers or glasses under or around the aquarium. The fishes are allowed to choose the part of the tank they prefer. The chief difficulty with this type of experiment is that unless spectral light is used the colors are not pure, and it is extremely difficult to obtain lights of various wave-lengths which have the same luminosity. Pigmented papers have not been made which will reflect light of a single color.

The first experiments relating to color discrimination were performed by Graber ('84), who used glass slides of different colors. Such screens were not 'pure,' but allowed light of various wave-lengths to pass through. Although the fishes *Cobitis barbatula* and *Alburnus spec.* showed decided preferences for red, there is little to indicate that the choice was necessarily due to the length of the light waves.

Bauer ('10) reports a difference between light and dark adapted fishes. Light adapted *Charax puntazzo* and *Atherina hepsetus* avoided a light shining through a red filter 680μ to 710μ , but when 'dark adapted' these fishes preferred red to blue, which Bauer considered to be of the same intensity. These observations were interpreted to mean that fishes are able to recognize colors, but that when they are 'dark adapted' color perception of the red end of the spectrum ceases much sooner than for normal human eyes.

Goldsmith ('12) arranged aquaria with colored bottoms. Young plaice preferred red to any other color and came to rest there, while gobies avoided red, refusing to go through a red passageway until it had been sanded. Red, yellow, green, and blue were chosen in order by *Gasterosteus*. This author thinks that her results show a color sense, but the possibility that the fishes were reacting to brightness does not seem to be eliminated.

Feeding experiments. In such experiments a motive is introduced. Discrimination on the part of the fish is indicated by an attempt to take food.

Zolotnitzky ('01) placed pieces of wool of different colors having the shape and size of chironomid larvae on the wall of an aquarium containing *Macropodes*. The fish snapped often at the red wool, less frequently at the yellow, and left the other colors untouched.

Frisch ('14) placed bits of food on colored paper of various shades. Fishes that had been accustomed to eat yellow food snapped at it in preference to other colors and red food was taken by fishes trained to eat red. Red food was taken on a black background, but black food was not taken from a black surface nor gray from a gray background. Red and yellow were often confused with each other and with purplish red, but not with gray, green, or blue.

Minkiewicz ('12) taught a *Julis vulgaris* to seek food dropped into the tank through a blue tube and at the same time to disregard a piece of thread dropped in through a yellow tube.

Goldsmith ('12) reports that plaice and gobies learned to take food from colored forceps thrust into the water, and later chose the color which had been associated with food even when the relative position of the forceps was changed. The fishes persisted in examining the same forceps after an interval of four days even when no food was present.

Washburn and Bently ('06) were able to establish an association involving 'color' discrimination in the creek club. This fish was fed from forceps to which red sticks were attached. When a similar pair of forceps attached to green sticks was offered simultaneously, the fish preferred the red forceps, even when

neither fork contained food. The probability that the discrimination was based upon luminosity was said to be lessened by using a much lighter red in some of the tests. Blue forceps were distinguished from red in the same way. Food was later placed in the green forceps, and the fish learned to go to the green first.

According to Reighard ('08), the gray snapper can distinguish colors. White *Atherinas* were taken in preference to those that had been stained blue. Though blue, light green, and dark green *Atherinas* were taken indiscriminately, red *Atherinas* were snapped at least often. Red *Atherinas* with the tentacles of the medusa, *Cassiopea xamachana*, sewed into their mouths, were refused, and very soon all red *Atherinas* were refused whether tentacled or not. This association of unpalatability with red lasted without any further practice from July 19 to August 8.

The feeding experiments taken as a whole offer strong evidence of a color sense in the fishes observed. The same criticism may be made of all of them, however; pure colors were not used, and the possibility exists that the fishes were reacting to brightness.

Hess ('09, '12, '13) is the chief opponent of color vision in fishes, maintaining that fishes see colors only as shades of gray—as a totally color-blind person perceives them. He offers the following reasons for this view:

In spectral light young *Atherina hepsetus* and young *Squalus cephalus* congregated in the yellow-green and green, i.e., in the brightest part of the spectrum of the dark adapted totally color-blind human eye. Some were found in the green-blue, very few in the red. By moving a black card along the spectrum and intercepting certain rays, the fishes could be driven into the blue or even into the violet, though they always returned when the card was removed. The longer light waves in the red produced no more effect upon the fishes than complete darkness. The luminosity values of different parts of the spectrum were worked out. This was done by lighting one-half of the tank with monochromatic light and the other with equivalent mixed

light which could be varied in intensity. When the fishes were arranged evenly in both parts of the tank, Hess considered that the two lights were equally bright. By measuring the intensity of white lights which had the same effect on the fishes as various colored lights, he obtained a luminosity curve which agreed very well with that of the totally color-blind human eye.

Hess offered the fishes imitation baits of various colors on different backgrounds. If the brightness of the bait corresponded with that of the background, it was not taken.

Contrary to the observations of Frisch, Hess found no adaptation to brightness in the pigment cells of the epithelium of *Crenilabrus*.

For fishes living any distance below the surface, Hess insists that a color sense would be useless because of the increasing absorption of light by the water as greater depth is reached, particularly the longer waves. Hence mating colors are valueless. Hess admits the possibility, however, that fishes living in shallow water may possess the ability to discriminate colors.

Hess also attempts to account for the reactions of *Daphnia* and some other animals by assuming that they react to the luminosity of the spectrum as it appears to the color-blind human eye. Loeb and Wasteney's ('15) criticism of this assumption on the ground that there is no proof that the heliotropic effects of light in lower animals are accompanied or determined by sensations of brightness, and, furthermore, that color-blind human beings do not show any positive heliotropism. Hess' further contention that animals and plants are sensitive to different parts of the spectrum—all animals to the yellowish-green, and all plants to the blue—is shown to be incorrect.

From the sources discussed considerable evidence has been accumulated to show that fishes perceive colors. Adaptive changes in the pigment cells of the skin of various species in relation to backgrounds of different colors have been observed, and when allowed a choice, fishes show preferences for backgrounds of particular colors. Mating colors may furnish further evidence of color discrimination. Thus far there seems to be no valid case of warning coloration in animals serving as food

for fishes. The results of feeding experiments are strongly indicative of a color sense. On the other hand, Hess contends that fishes see colors as shades of gray, as a totally color-blind human being perceives them.

CONDITIONS OF EXPERIMENTATION

The mudminnows and sticklebacks used in the experiments to be described in this paper were obtained from Lake Wingra and Lake Mendota, near Madison, Wisconsin. They were not kept in running water, since it was found that they thrived equally well without it, provided the water was changed from one to three times a week. City water was used because it is drawn from an artesian well and contains few organisms injurious to fishes. Individuals were kept in separate jars and carefully observed, as many experiments as possible being performed upon each fish. One mudminnow which is still alive has been under observation over three years.

When first introduced into aquaria the fishes were left undisturbed for something like a week, except for changing the water. They commonly refused to eat during this period of adjustment; usually some died at first, but thereafter few were lost. By the end of a week the survivors were likely to be hungry and sufficiently accustomed to the presence of persons in the room to eat bits of food dropped into the water. Shortly after this they could generally be induced to take food at the surface, and after several days to jump out of the water for food. It was necessary to estimate carefully the amount of food to be given, as the fishes have a tendency to consume large quantities at one time and then fast for several days. In most cases feeding was carried on in the laboratory from one to three months before experiments were begun, or until the fishes had formed the habit of taking food daily.

Although the following observations were made especially on the mudminnow, they apparently apply to the stickleback as well. In making selection for training experiments, marked differences in the adaptability of fishes of different ages were found. Whereas mature mudminnows spend most of the time

lying quietly in the bottom of the aquarium and are wary about coming to the surface for food, the younger fishes swim about actively, are less easily disturbed by jars and movements, and take food more eagerly. But fry under one and a half inches in length are undesirable for such work, as their movements are irregular and unsteady.

INSTINCTIVE MOVEMENTS

Instinctive movements may be defined as locomotor responses exhibited by an animal without previous training. Taken as a whole, these responses make up what Jennings has defined as the 'action' system, and they nearly always determine how any animal is going to react under a given set of conditions. The mudminnow and the stickleback have the same types of instinctive movements, namely, swimming, leaping out of water, and flopping about on land. The mudminnow swims rather deliberately with a smooth motion. When accustomed to laboratory conditions, it sometimes springs up and seizes objects outside of the water. Before doing so, it usually hesitates a short distance from the surface, switching its tail in an agitated manner. If the tank containing the mudminnows is left uncovered, the fishes are liable to leap entirely out of the receptacle.¹ Mudminnows bury themselves in the mud to tide over dry seasons.

The stickleback swims in a jerky, nervous manner, never going far in one direction, but darting hither and thither. It leaps out of water, but usually not so far as the mudminnow; generally it comes to the surface and bobs up and down, thrusting out only its nose. It is less timid, though always wary.

PERIODIC ACTIVITIES AND DAILY RHYTHM OF THE MUDMINNOW

Seasonal variations in the activities of fishes are not readily subject to laboratory observation. In almost all cases, however, the best results in the training experiments to be described were

¹ It is reported by Mast ('15) that *Fundulus* leaps from tide pools and succeeds in transporting itself by flopping along on land across a barrier of dry ground more than 3 m. wide and 10 cm. high.

obtained in July, August, January, February, March, and April, since during the summer and winter months the fishes were less restless and came for food more readily. That better results were not always recorded for experiments during the fall might be due to the fact that fishes were usually obtained in September and early October and were not yet adjusted to laboratory conditions.

In the middle of April, May, and early June a marked restlessness was noticed—often the fishes ate erratically and were unfit for experimental work. It hardly seems probable that this was due to a rise in temperature, as the fishes had been kept in a room at ordinary temperature during the winter, and a series of experiments had been carried on successfully during the hottest weeks of the summer. It was probably due to breeding activities. The breeding season of the mudminnow comes during the spring after the ice leaves the creeks and ponds where they live. The fishes which have been confined in the laboratory during the winter rarely, if ever, mature eggs, but there is probably a change in the gonads at this season. Two fishes which had been accustomed to eat daily from forceps during the winter months became restless in the spring, eating very irregularly, but in July and August were again available for experiment.

The mudminnow was the subject of a series of observations on daily rhythm of activity. Across one corner of a room was hung a large opaque window shade. In this a hole was cut three inches square and about three feet from the floor. A table was placed in front of the curtain in such a position that vessels containing fishes could be seen by the observer who was seated behind the curtain. The space behind the curtain was darkened, and the observer kept as quiet as possible so that her movements might not disturb the fishes. The vessels containing the fishes were always allowed to remain on the table several hours before observations were made. During the hours of the day and night, the movements of individual fishes within the tanks were carefully mapped out on paper with as much minuteness as possible, and the amount of time spent in each position recorded with a stop-watch.

Twenty fishes (all young fry— $1\frac{1}{4}$ to $1\frac{3}{4}$ inches—except one) were observed during an entire night in November from 10:30 P.M. until 7:30 A.M. The vessels containing them were placed on tables where there was only enough illumination to faintly discern the outlines of the fishes. The position of each fish was noted every half hour, also whether it was active or at rest. Of 201 observations made, the fishes were in 124 instances near the surface, and in 77 instances the fishes rested on or near the bottom. At daybreak nearly all the fishes were moving about actively. Likewise, nineteen fishes were observed at half-hour intervals during one afternoon and evening. From all these observations it was concluded that mudminnows, while only slightly less active at night than during the day, exhibit somewhat greater activity at daybreak. Although very young individuals came to rest anywhere in the dish, they spent relatively more time at the surface than on the bottom, whereas older individuals evinced a preference for the bottom. Protective adaptation would seem to cause the young fry to stay at the surface, since the large fishes which are their natural enemies are usually found near the bottom.

SENSE ORGANS USED IN SEEKING FOOD

In these fishes the senses of sight and smell are most used in seeking food. The stickleback displays more alertness in using both senses and much higher degree of acuteness of the olfactory sense. The method used by Parker ('11) in testing the olfactory sense of fishes was tried with both mudminnows and sticklebacks. Cloth packets, one of which contained meat and the other cotton, were suspended at opposite ends of the aquarium. The mudminnows did not show that they perceived either packet though they swam in close proximity to both.

The sticklebacks behaved differently. The appearance of the packets attracted them at once. Those fishes which went towards the packet containing meat darted furiously upon it and pulled at it with great excitement, but those which swam in the direction of the packet of cotton in most cases stopped about 4 cm. away and turned off sharply in another direction. Only

once or twice did they actually snap at the cotton packet. Then perceiving the struggles of the rest of the fishes with the other packet, they swam over and joined them. Repetition of this experiment gave similar results. At Woods Hole, Massachusetts, the same test was performed upon *Fundulus heteroclitus* for comparison, since this species had been found by Parker to discriminate between the packets. The sticklebacks reacted fully as well to the stimulus of concealed food as did *Fundulus*.

In the use of the sense of sight the mudminnow compares more favorably with the stickleback, though the latter reacts more quickly. Both species pursue moving objects without odor, such as bits of paper, or objects above the surface of the water; both exhibit skioptic reactions, and are stimulated by an increase in the amount of illumination.

COLOR DISCRIMINATION

Notwithstanding numerous investigations, the question as to whether fishes possess color vision is still somewhat unsettled. Fishes live in a medium where, except at the surface, the light is rather dim. The permeability of water to light depends largely upon its depth and clearness. There is an unequal absorption of different parts of the spectrum as rays of light penetrate; the red end is absorbed more rapidly than the blue, so that at a depth of several meters in clear water fishes see as if through a blue-green glass. This fact might lead one to the view that for fishes living at any great depth, the ability to discriminate colors would be valueless. There is the possibility, however, that the eye of such fishes is better adapted to perceive minute differences in shade and color of objects in a dim light than is our own—a consideration which should not be rejected because fishes are rather unspecialized in structure compared with other vertebrates. Even though fishes, which live at a depth where red, orange, and yellow rays of light do not penetrate, may have no use for a color sense, this cannot be true of fishes living and feeding at the surface, where rays of light are only slightly refracted and absorbed by the water.

In dealing with this problem there are certain questions to be considered:

1. Do the fishes studied discriminate colors?
2. If so, is the discrimination due to wave-length or to intensity? In other words, do fishes see colors as such, or as shades of gray?
3. If the eyes of fishes are affected by differences in wave-length, is their color vision like that of a normal human being?
4. Can fishes form associations with colors?
5. Would such associations be of value to them in their struggle for existence?
6. How do the results agree with present theories of color vision?

The following series of experiments were aimed to answer these questions and to supplement the evidence furnished by other workers. They were planned with a view to training fishes to secure food in particular ways, and extended through three years.

The general problem presented to the fishes was that of learning to associate food with a certain color and at the same time associate unpalatable substances such as paper with another color. The mudminnow and the stickleback are both shallow-water fishes which discover their food largely by sense of sight. Various methods of presenting food were tried. Considerable time was consumed at the beginning by using colored electrodes. These were thrust into the water at the sides of the dish and food was offered on forceps in the water. The fishes were given a mild electric shock when they snapped at bait on the wrong color. This method had to be abandoned because one shock often caused a fish to refuse food for several days.

Instead of this, the fishes were fed on only one color, while on the color with which unpalatability was to be associated, they were offered balls of paper closely matching the food in appearance and color. In order that there might be no chance to smell the food, the bait was not dropped into the water, but the fishes were taught to leap out of water regularly and take it from forceps. Minced snail meat was the most attractive bait in the long run, although this was varied at times with chopped earthworms, slugs, and liver. Repeated trials deter-

mined that the fishes were not able to distinguish between the imitation baits and the food when both were offered out of water under the same conditions. The use of this method usually caused some delay on account of the necessary training of a week or two at the beginning of a set of experiments. The proportion of mudminnows successfully trained was only about two out of every five, but nearly all the sticklebacks could be taught to take food as desired.

EXPERIMENTS WITH MUDMINNOWS

Experiments with colored papers

The first set of experiments with mudminnows was carried on during the winter of 1914 to 1915. Five were placed in separate bowls to be trained, but only two of these could be induced to eat with regularity. The experiments were performed by day before a large window. Discs of colored² papers were cut 7.3 cm. in diameter and stiffened with cardboard. An aperture was made in the center of each large enough to allow the discs to be slipped down over the ends of the forceps from which the fishes were fed. The fishes were at first somewhat disturbed by the paper discs and required a little time to become accustomed to them. In a week this timidity vanished; the appearance of a colored disc became a signal for the fishes to dart to the surface and spring out of the water after food. When this association with one color seemed to be thoroughly established, a disc of another color was substituted with paper closely resembling the food in color and appearance in the forceps. The same pair of forceps was never used for both food and paper so that there should be no possibility that the taste of food might be transferred to the paper. The colored discs slipped down over the forceps were offered alternately. This furnished a severer test of the power of association than did the experiments of Washburn and Bently ('06) in which the forceps of two different colors with only one holding food were thrust into the water simultaneously.

² The colors correspond with the following numbers in Klingsiek and Valette's Code de Couleur: red: rouge no. 2, blue: blue no. 431, violet: blue-violet, no. 481.

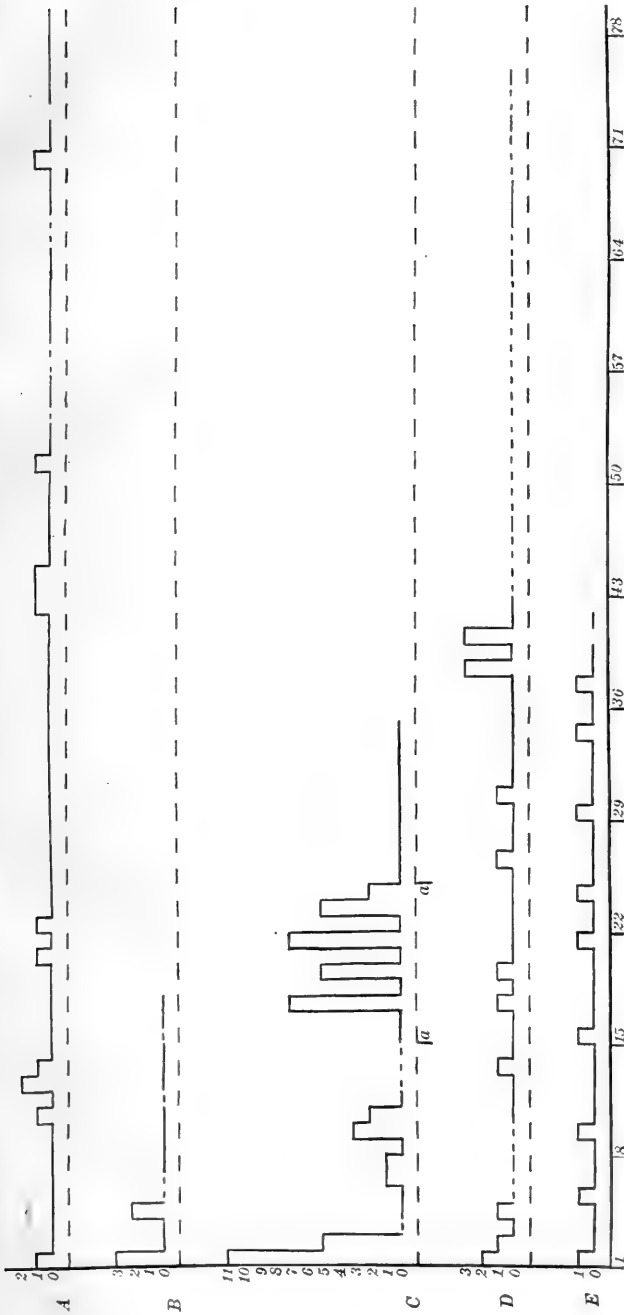

Fig. 1 Curves representing the results of experiments on color discrimination of mudminnows. The number of errors on each successive day is shown on the ordinate and the days of the experiment on the abscissa. When the record for a certain day is perfect the line is at 0. A dotted line indicates that a fish was offered food, but refused to eat. A blank space indicates that food was not offered.

A. Mudminnow no. 25. Blue and red cards presented simultaneously; blue indicated presence of food and red indicated gray paper. Duration of the experiment was 79 days, March 3 to May 22.

B. Mudminnow no. 27. Blue and red cards presented alternately; blue indicated presence of food and red indicated gray paper. Duration of the experiment was 17 days, February 11 to February 27.

C. Mudminnow no. 27. Blue and red monochromatic gelatin filters in the end of a flashlight; blue represented food and red represented paper. Duration of the experiment, 34 days, July 9 to August 11. *a-a*, batteries weakened giving a dim light.

D. Mudminnow no. 27. Blue and violet cards; blue indicated presence of food and violet indicated paper. Duration of the experiment, 75 days, March 3 to May 17.

E. Mudminnow no. 60. Green and yellow lights, green indicated presence of food and yellow indicated paper. Duration of the experiment, 41 days, February 26 to April 6.

The first test was successfully accomplished by only one fish, no. 27. The colored discs offered were blue as a signal that the forceps held food and red to represent paper. The forceps with the colored discs attached were presented singly. The duration of the experiment was seventeen days (February 11 to February 27). The results are shown in figure 1, B. On the first day three errors were made, i.e., the fish snapped at the paper under the red disc three times. On the second and third days the fish refused to eat on red, but took food on the appearance of the blue disc. Two mistakes were made on the fourth day, after which the fish no longer attempted to obtain food on red. In two instances a day intervened when the fish was not fed, in one instance two consecutive days, after which intervals the fish made a perfect record.

The curves for all the experiments to be described are plotted in the same way. The days of the experiments are shown in the abscissa and the number of errors recorded each day on the ordinate. When no mistakes were made the curve is at 0, but the number of correct tests is not designated in the curves. The results of all the experiments with the mudminnows and sticklebacks are summarized in tables 1 and 3, respectively, showing the duration of each experiment, the total number of trials, the number of errors and of correct records, and the percentage of errors and of successes in each case.

After mudminnow no. 27 had learned to distinguish between the red and the blue discs, violet was substituted for the blue disc. (Fig. 1, D, and table 1.) The entire experiment con-

TABLE 1

Results of experiments in which mudminnows were taught to take food offered with certain colored papers or with light passed through monochromatic gelatin filters, and to refuse paper resembling food in appearance when offered with certain other colored papers or other monochromatic lights. 'Lights from flashlight' means that the source of illumination was a hand electric flashlight and that the light passed through a monochromatic gelatin filter before reaching the fish; 'lights dim' means that the dry cell in the flashlight ran down so that the light had a low intensity. 'Lights' means that an incandescent electric lamp was used and that the light was passed through monochromatic gelatin filters. 'Intensity varied' means that differ-

ent known intensities of light were passed through the monochromatic gelatin filters. 'Colors reversed' means that the color which in the first part of an experiment had indicated the presence of food was changed to mean paper, and that food was now given on the color with which paper had formerly been associated. The letters indicate the colors; blue is represented by B, green by G, red by R, violet by V and yellow by Y. 'Gray plates' means that 'fogged' photographic plates were used and that the source of the light shining through them was an incandescent lamp. 'Square and dots' means that, instead of monochromatic gelatin filters, glass plates with these designs on them were used with the light from an incandescent lamp passed through them. The appearance of the square was accompanied by food and the dots by paper.

FISH	TYPE OF EXPERIMENT	DURATION OF EXPERIMENT	NUMBER OF TRIALS	NUMBER OF TIMES CORRECT	NUMBER OF ERRORS	PER CENT OF TIMES CORRECT	PER CENT OF ERRORS
No. 25	R and G papers.....	79	108	94	12	88.89	11.11
	R and G lights from flash-lights.....	12	33	21	12	57.14	42.8
	Lights dim.....	10	27	14	13	51.06	48.14
	Batteries renewed.....	14	15	14	1	93.34	6.66
No. 27	B and R papers.....	17	20	15	5	75.00	25.00
	V and B papers.....	65	74	59	15	79.72	20.28
	B and R lights from flash-lights.....	14	43	20	23	46.51	53.49
	Lights dim.....	10	44	18	26	41.36	58.64
	Batteries renewed.....	10	10	10	0	100.00	0.00
	R and G lights.....	48	69	45	24	65.22	34.78
	Intensity varied.....	22	48	41	7	85.42	14.58
Square and dots.....	38	52	5	47	9.8	90.2	
No. 40	G and R lights from flash-light.....	11	24	21	3	87.5	12.50
	Lights dim.....	10	37	22	15	40.54	59.46
	Batteries renewed.....	10	14	14	0	100.00	0.00
	Colors reversed.....	10	31	15	16	48.38	51.62
	G and R lights.....	10	12	12	0	100.00	0.00
	Intensity varied.....	33	50	32	18	64.00	36.00
No. 55	G and R lights.....	22	47	39	8	82.98	17.02
	G and R lights.....	24	24	20	4	83.34	16.66
	Intensity varied.....	12	22	22	0	100.00	0.00
	G and R lights.....	33	31	27	4	87.10	12.9
	Intensity varied.....	36	27	24	3	88.89	11.11
Gray plates.....	30	28	5	23	17.85	82.15	
No. 60	G and Y lights.....	41	39	30	9	76.93	23.07
	Gray plates.....	51	38	1	37	2.63	93.37

tinued seventy-five days (March 3 to May 17). During the last thirty-five days (April 18 to May 17) not a single mistake occurred. This period included thirteen consecutive days when the fish would not eat, but the associational impression was retained during the interval. The blue-violet combination seemed a more difficult one for the fish to master than the red-blue, since the time required for enough consecutive perfect records to be made to show that the association was established was much longer than in the previous experiment. The previously formed association did not seem to be of any assistance as a preparation for learning the new combination.

Mudminnow no. 25 was also tested with the red and the blue discs presented alternately under the same conditions used with mudminnow no. 27, but no color association was formed. The discs were then offered simultaneously to discover whether the failure was due to the complexity of the test or to lack of color vision. When the two discs appeared at the same time, the fish learned to seek the blue first. This showed that while the fish was able to discriminate between the red and the blue papers, it did not inhibit the impulse to take food when one disc was shown separately. The duration of the test was seventy-nine days (March 3 to May 22.) (Fig. 1, A, and table 1.)

These experiments are subject to the criticism made upon the work of other investigators, as the colors are not spectrally pure. In any case, however, they clearly demonstrate that fishes are capable of forming associations and receiving suggestions from the conditions connected with obtaining their food, and that these associations may persist for a considerable time.

Experiments with monochromatic light filters attached to the end of a flashlight

In order to test accurately what wave-lengths of light could be discriminated by the fishes, monochromatic filters were used instead of the colored papers. A set of Wratten monochromatic gelatin filters was obtained from Eastman Kodak Company. The set consists of seven filters, mounted between glass slides, which allow light of the following waves-lengths to pass through:

Red no. 70: 640μ to 730μ

Red no. 71: 600μ to 730μ

Orange no. 72: 580μ to 630μ 660μ to 710μ

Yellow no. 73: 550μ to 630μ 570μ to 720μ

Green no. 74: 510 to 570μ

Green no. 75: 460μ to 540μ

Blue no. 76: 420μ to 480μ

A flashlight was fitted out with a tin hood like the accompanying diagram (fig. 2). The hood, *H*, was slipped over the

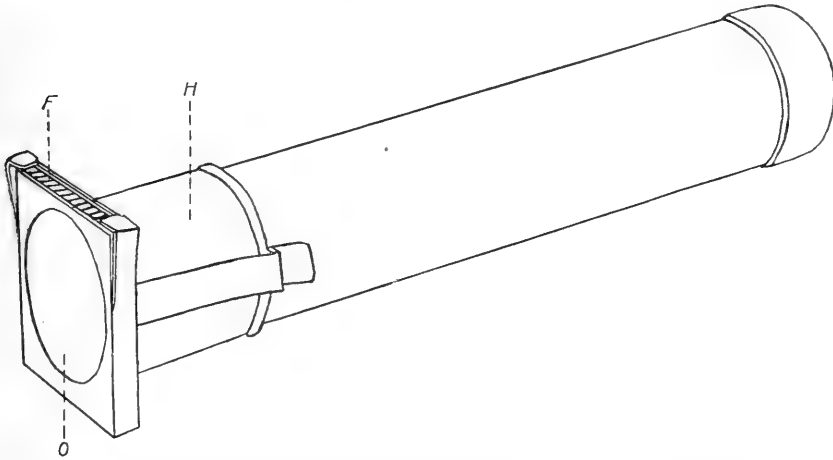

Fig. 2 Flashlight with hood, *H*, attached at the end to hold the gelatin filters, *F*. The light shines through the filters at the opening, *O*.

end of the flashlight and the monochromatic gelatin filter inserted in a groove in the end of the hood where it could be locked in position, *F*. The light was directed from above on the vessel containing the fishes and food offered from forceps held beneath the light. The experiments were performed at twilight during the summer months. Of six mudminnows which were fed at the beginning, only three ate regularly enough to give results of value. As before, the fishes were made to spring out of the water after their food, and paper which matched the food was offered on the color which was to be refused.

Mudminnow no. 27, with which the two previous sets of experiments with the colored discs had been successfully completed, learned to discriminate between red and blue lights shining through monochromatic filters (red, no. 71; blue, no. 76) when they were presented alternately; blue representing the food stimulus and red, paper. The duration of the experiment was thirty-four days (July 9 to August 11). No errors were made during the last ten days. Red no. 70 was substituted for red no. 71 without affecting the outcome (fig. 1, C).

Fish no. 25 (which during the winter had not given successful results when the red and blue discs were presented alternately, but had later learned to discriminate between them when they appeared simultaneously) made a perfect record for ten days with the lights red no. 71 and green no. 74 in a series of tests which lasted thirty-six days (July 11 to August 15). The lights were flashed upon the vessels alternately, red representing food and green, paper. During this experiment red no. 70 and green no. 75 were several times substituted for the filters habitually used, and the fish reacted in the same manner as it was accustomed to react to red no. 71 and green no. 74. (Fig. 3, A, and table 1.)

In both of these experiments with the gelatin filters a rather interesting occurrence took place. The flashlight batteries began to grow dim about the thirteenth day and were not renewed until the twenty-third day. During the period when the lights were dim, there was a great increase in the number of errors, which ceased as soon as the batteries were renewed. A sudden rise in curve C, figure 1 (*a-a*), and curve A, figure 3 (*a-a*) during the time when the lights were dim may be noted.

The greatest aptitude displayed by any fish was that of mudminnow no. 40, a female ready to spawn. The colored lights used were green no. 74 for food and red no. 71 to be rejected. On the first day when both colors were offered, the fish made three failures, attempting three times to take food in red light. For the eleven days following this she made correct discriminations. Her behavior at the appearance of the two lights was different. To green she responded by rising immediately to the surface; when red was flashed upon her, she swam about rather excitedly,

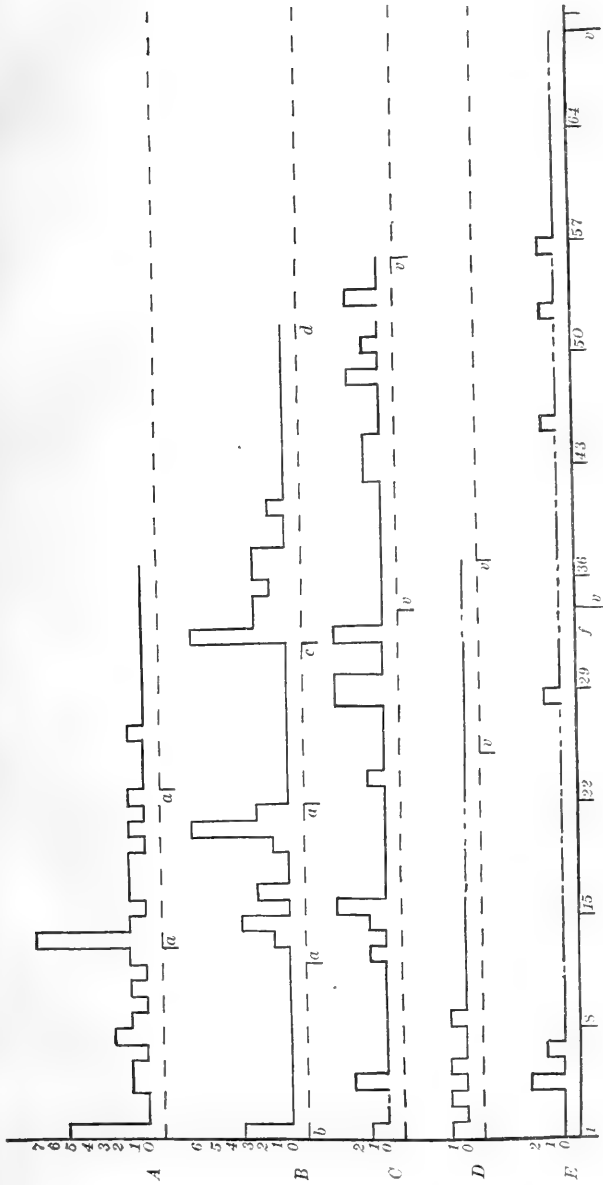

Fig. 3 Curves representing the results of experiments on color discrimination of mudminnows. Construction of curves and lettering same as in figure 1.

A. Mudminnow no. 25. Red and green monochromatic gelatin filters in the end of a flashlight, red indicated presence of food and green, paper. Duration of the experiment, 36 days, July 11 to August 15. *a-a*, batteries weakened giving a dim light.

B. Mudminnow no. 40. Green and red monochromatic gelatin filters in the end of a flashlight. During the first 31 days (*b-c*) green light indicated the presence of food and red indicated paper; during the last 20 days (*c-d*) red indicated food and green indicated paper. Duration of the entire experiment, 51 days, July 12 to August 31. *a-a*, batteries weakened giving a dim light.

C. Mudminnow no. 40. Red and green lights, red indicated presence of food and green, paper. During the last 22 days the intensity of the lights was varied (*p-v*). Duration of the entire experiment, 55 days, April 24 to June 17. D. Mudminnow no. 55. Green and red lights, green indicated presence of food and red, paper. During the last 15 days of the experiment the lights were varied (*p-v*). Duration of the entire experiment, 36 days, October 25 to November 29.

E. Mudminnow no. 55. Repetition of experiment represented in curve D after 41 days' lapse. During the last 36 days the intensity of the lights was varied (*p-v*). On the thirty-second day of this experiment (*f*) the fish was accidentally frozen and then thawed out. Duration of the entire experiment, 69 days, January 12 to March 21.

but seldom came to the top. She also was confused by the dimming down of the lights, as is shown by the sudden rise in curve B, figure 3 (*a-a*), but with the renewing of the batteries the errors ceased. The experiment was continued until ten consecutive errorless days were recorded.

Using the same mudminnow, the colors were then reversed. (Fig. 3, B, *c*.) Although the forceps under the green light now contained paper, the mudminnow persisted in leaping out at them, but refused to do so when red light with food was substituted. For five days this fish could not be induced to take food in red light, so that it was necessary to drop bits of food into the water without colored illumination in order to keep her in proper condition for experiment. On the sixth day she ate once in red light after snapping at paper in green light, but would not take food again in light of either color. On the seventh and eighth days she would not eat except when food was dropped into the water without colored lights. She sprang out after food in light of either color on the ninth day. Then followed eleven days of perfect record when she consistently took food under red light, but refused to do so under green light, (Fig. 3, B, and table 1.)

Experiments with constant and varied intensity of illumination

Since a flashlight does not yield a uniform illumination for any considerable length of time, an apparatus was contrived in which an electric lamp could be used for passing light through the gelatin filters (Fig. 4). An oblong tin box was constructed, 6 cm. x 6 cm. x 12.5 cm. The electric light bulb was fitted into one end of the box. At the other was an opening 4 cm. in diameter before which was a groove to hold the gelatin filters in position. Two plates of glass (*P, P'*) were inserted between the light and the gelatin plates to prevent the plates being overheated. A sliding cover was fitted tightly over the top of the box.

The electric lamp was connected with a rheostat (fig. 5, *R*) by which the intensity of the light could be regulated and varied.

Thus, although no method was at hand for determining the intensity of a colored light, lights of varying intensity could be passed through the monochromatic filters and the effect noted. The following intensities of light were used: 4.9 candlemeters, 2.5 candlemeters, 1.4 candlemeters, 0.68 candlemeters. These values were obtained by measuring the light when it was in the box shining through the two glass plates inserted to protect the gelatin filters. When the color filters were in position, the in-

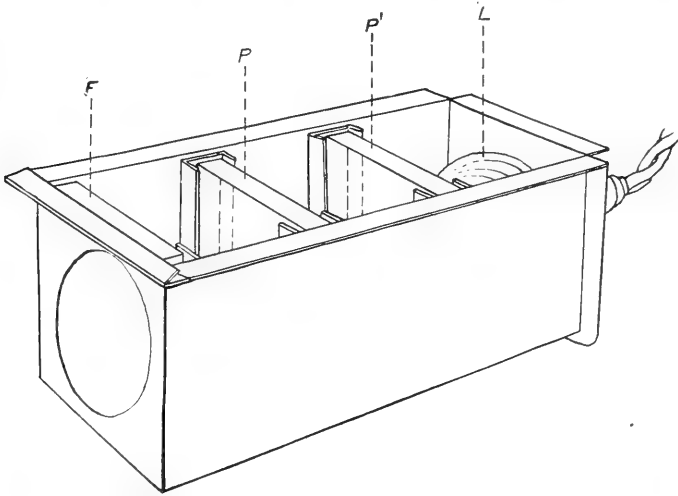

Fig. 4 Tin box in which light from an electric lamp, *L*, was passed through the gelatin filters, *F*. *P*, *P'* are glass plates inserted to prevent overheating the gelatin filters, *F*. During the experiments the box was covered with a tight lid which is not shown in the diagram.

tensity was greatly decreased. During these experiments the translucent window shades were tightly drawn to increase the effect of the colored lights, and the fish tanks were surrounded by a black opaque screen (*S*) so that the fishes might not be influenced by the movements of the investigator.

Experiments were first carried on with mudminnow no. 27 and mudminnow no. 40. The light was first used full strength (4.9 c.m.) with red no. 71 for paper and green no. 74 for food. When these fishes has shown by a perfect record that they had formed

the association, the intensity of the light was varied, but no increase was noted in the number of mistakes, nor did the discrepancies seem to be correlated with the relative intensities of the light (fig. 3, C, and table 1).

Mudminnow no. 55 was tested in two sets of experiments. The first set was carried on in the fall of 1916 between October

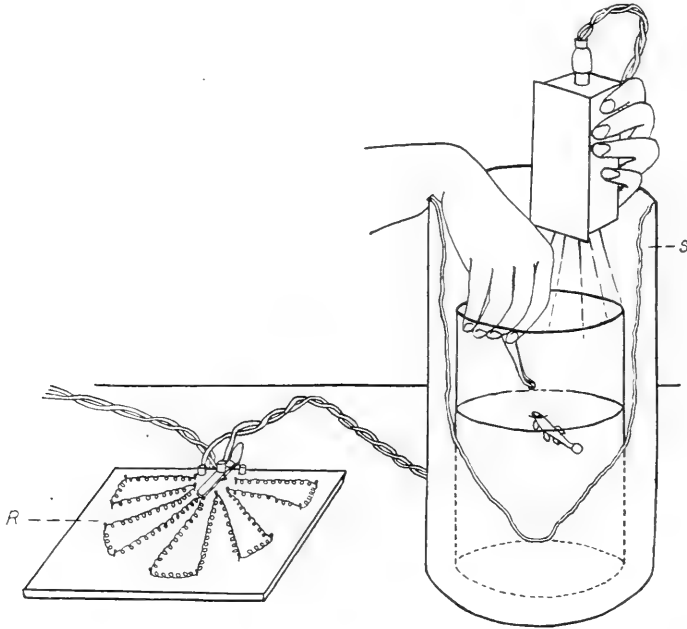

Fig. 5 Representing the conditions of experiments with gelatin filters illuminated by an electric lamp. The electric lamp in box, *B*, was connected with the rheostat, *R*, by which the intensity of the light could be varied. During the experiments the jar containing the fish was surrounded by an opaque screen, *S*, and the colored light was flashed upon the fish at the same time that food was offered from forceps.

25 and November 29 (thirty-six days), with green light indicating the presence of food and red indicating paper. No errors were recorded after November 1, the eighth day of the experiment, as the fish consistently refrained from snapping at paper in red light, but took food in green light. Beginning with November 15th, the lights were varied in intensity. The results of this ex-

periment and the one following are tabulated so as to show exactly what occurred at each feeding and with each intensity of light (fig. 3, D, and tables 1 and 2).

Beginning with January 12th, this experiment was repeated with the same mudminnow and continued for sixty-nine days. An especially interesting fact in connection with this experiment was that no failures were noted during the first three days, although the time which had elapsed since the completion of the first experiment was forty-two days (table 2). This occurrence may have been an accident, but if so, it was the only time a fish made no failures at the beginning of an experiment. It seems more logical to suppose that the fish had preserved the acquired association of green light with food and red with paper throughout this interval. The experiment seems to show a clear case of color discrimination. The number of errors was in all only seven. Three of these occurred during the time when the lights were being varied, but as with fish no. 27 and fish no. 40, there seemed to be no correlation between the errors and the relative intensities of the lights. On one occasion the fish snapped at the bait in the red light when the light which shone through the red filter was 1.4 candlemeters without the color screen and that which shone through the green filter 4.9 candlemeters (February 25). At another time, the fish was confused when the light passing through the red filter was 4.9 candlemeters and that illuminating the green 2.5 candlemeters (March 4). On another day the red was 2.5 candlemeters and the green 4.9 candlemeters (March 8). On two occasions when errors were made, the light passing through the green filter was the more intense, but in the other instance, the red was stronger. (Fig. 3, E, and tables 1 and 2.)

Experiments with green and yellow filters

Mudminnow no. 60 was given the problem of distinguishing green no. 74 from yellow no. 73. The yellow, which, it may be noted, had two absorption bands, appeared to the human eye considerably brighter than the green. On this account a weaker

TABLE 2

Detailed results of two experiments with mudminnow No. 55 described on p. 468-9. The table shows the number of times food was taken or refused with each intensity of light passed through a green monochromatic gelatin filter on each day of the experiment; also the number of times paper was taken or refused with each intensity of light passed through a red monochromatic gelatin filter on each day of the experiment. All light intensities are given in candle meters as measured with the monochromatic gelatin filters removed.

DATE	GREEN		RED	
	Light intensity	Number of times food was taken	Light Intensity	Number of times paper was taken
	<i>cm.</i>		<i>cm.</i>	
October 25.....	4.9	3	4.9	1
				0
October 26.....	4.9	2	4.9	0
October 27.....	4.9	2	4.9	1
October 28.....	4.9	2	4.9	0
October 29.....	4.9	3	4.9	1
				0
October 30.....	4.9	2	4.9	0
October 31.....	4.9	2	4.9	0
November 1.....	4.9	2	4.9	1
		0		0
November 2.....	4.9	2	4.9	0
				0
November 3.....	4.9	2	4.9	0
November 4.....	4.9	2	4.9	0
November 5.....	4.9	2	4.9	0
November 6.....	4.9	2	4.9	0
November 7.....	4.9	2	4.9	0
November 9.....	4.9	0	4.9	0
November 10.....	4.9	1	4.9	0
November 11.....	4.9	2	4.9	0
November 12.....	4.9	0	4.9	0
November 13.....	4.9	0	4.9	0
November 14.....	4.9	0	4.9	0
November 15.....	4.9	1	4.9	0
November 16.....	4.9	2	4.9	0
November 17.....	4.9	2	4.9	0
November 18.....	4.9	3	4.9	0
			2.5	0
November 19.....	4.9	2	4.9	0
	1.4	1	2.5	0
	4.9	1	4.9	0
November 20.....	2.5	1	1.4	0
	0.6S	1		

TABLE 2—Continued

DATE	GREEN		RED	
	Light intensity	Number of times food was taken	Light intensity	Number of times paper was taken
	<i>cm.</i>		<i>cm.</i>	
November 21.....	4.9	1	4.9	0
	2.5	1	1.4	0
	0.68	1		
November 22.....	4.9	1	4.9	0
	1.4	1	2.5	0
	0.68	1		
November 23.....	2.5	1		
	4.9	1	2.5	0
	0.68	1	1.4	0
November 24.....	1.4	1		
	4.9	1	4.9	0
	1.4	1	2.5	0
November 25.....	4.9	0	4.9	0
November 26.....	4.9	0	4.9	0
November 27.....	4.9	1	4.9	0
	0.68	1	1.4	0
	0.68	1	4.9	0
November 28.....	2.5	1		
	4.9	1	4.9	0
	0.68	1	1.4	0
November 29.....	2.5	1		
	2.5	1	4.9	0
	4.9	1	1.4	0
November 30-January 11....	0.68	1	2.5	0
	4.9	1		
	2.5	1		
Experiments discontinued				
January 12.....	4.9	2	4.9	0
January 13.....	4.9	3	4.9	0
January 14.....	4.9	2	4.9	0
January 15.....	4.9	2	4.9	2
				0
				0
January 16.....	4.9	2	4.9	0
January 17.....	4.9	2	4.9	1
		0		0
January 18.....	4.9	2	4.9	0
January 19.....	4.9	2	4.9	0
January 20.....	4.9	2	4.9	0
January 21.....	4.9	2	4.9	0
January 22.....	4.9	0	4.9	0

TABLE 2—Continued

DATE	GREEN		RED	
	Light intensity	Number of times food was taken	Light intensity	Number of times paper was taken
	<i>cm.</i>		<i>cm.</i>	
January 23.....	4.9	2	4.9	0
January 24.....	4.9	2	4.9	0
January 25.....	4.9	2	4.9	0
January 26.....	4.9	2	4.9	0
January 27.....	4.9	1	4.9	0
		0		
January 28.....	4.9	2	4.9	0
January 29.....	4.9	2	4.9	0
January 30.....	4.9	0	4.9	0
January 31.....	4.9	2	4.9	0
February 1.....	4.9	2	4.9	0
February 2.....	4.9	1	4.9	0
		0		
February 3.....	4.9	2	4.9	0
February 4.....	4.9	2	4.9	0
February 5.....	4.9	0	4.9	0
February 6.....	4.9	1	4.9	0
		0		
February 7.....	4.9	0	4.9	0
February 8.....	4.9	2	4.9	1
February 9.....	4.9	2	4.9	0
	4.9	1	4.9	0
February 10.....	2.5	1		
	1.4	1		
February 11.....	4.9	1	4.9	0
		1		
February 12.....	Fish was frozen into ice and thawed out			
February 13.....	4.9	0	4.9	0
February 14.....	4.9	2	2.5	0
February 15.....	4.9	0	4.9	0
February 16.....	4.9	0	4.9	0
	4.9	1	2.5	0
February 17.....	1.4	1		
	2.5	1	4.9	0
February 18.....	1.4	1		
	1.4	1	4.9	0
February 19.....	2.5	1		
February 20.....	4.9	0	4.9	0
	4.9	1	4.9	0
February 21.....	2.5	1	1.4	0

TABLE 2—Continued

DATE	GREEN		RED	
	Light intensity	Number of times food was taken	Light intensity	Number of times paper was taken
	<i>cm.</i>		<i>cm.</i>	
February 22.....	4.9	1	4.9	0
	2.5	1		
February 23.....	4.9	0	4.9	0
February 24.....	4.9	0	4.9	0
	4.9	1	1.4	1
February 25.....	1.4	1		
	4.9	1	4.9	0
February 26.....	1.4	1		
	4.9	1	2.5	0
February 27.....	1.4	1		
	4.9	1	2.5	0
February 28.....	1.4	1		
March 1.....	1.4	1	4.9	0
March 2.....	2.5	1	4.9	0
March 3.....	4.5	0	4.9	0
March 4.....	2.5	3	4.9	1
			4.9	0
March 5.....	4.9	1	4.9	0
	2.5	1		
March 6.....	2.5	2	4.9	0
March 7.....	4.9	0	4.9	0
March 8.....	4.9	2	2.5	1
March 9.....	4.9	2	2.5	0
March 10.....	4.9	2	4.9	0
	4.9	1	4.9	0
March 11.....	1.4	1		
	4.9	1	4.9	0
March 12.....	2.5	1		
March 13.....	4.9	1	4.9	0
March 14.....	4.9	1	2.5	0
	1.4	1		
	2.5	1	4.9	0
March 15.....	4.9	1		
	1.4	1		
March 16.....	2.5	1	4.9	0
	1.4	1		
March 17.....	2.5	1	4.9	0
March 18.....	4.9	0	4.9	0
March 19.....	4.9	0	4.9	0
March 20.....	4.9	2	2.5	0
March 21.....	4.9	2	2.5	0

light (2.5 c.m.) was frequently used with the yellow filter (4.9 c.m. being used for the green). The experiment lasted forty-one days (February 25 to April 6). On each of nine days one mistake was made, but errors were never recorded on two consecutive days. The fish never made a perfect record for so long a period as did the fishes in the experiments previously described, but in two instances a perfect record was shown for five successive days, and in two instances for four successive days. It seems safe to conclude that mudminnows are able to distinguish green from yellow, but that these colors are not so readily discriminated as are green and red, and blue and red (fig. 1, E).

Experiments with gray filters

In order to check up Hess' theory that fishes perceive colors as shades of gray, as a totally color-blind human being perceives them, further experiments were performed. Two photographic plates were exposed to the light one second and four seconds, respectively, producing on one a light and on the other a dark gray surface. These plates were cut to the size of the gelatin filters and the gelatin surface protected by glass so that they could be inserted without scratching in the box shown in figures 4 and 5, and the experiment performed under the same conditions as the color tests. If the fishes were reacting to shades of gray, they ought to be able to distinguish between the two photographic plates just as they had done with the colored filters. Mudminnow no. 60, which had distinguished green and yellow, did not show the slightest sign that it could perceive any difference between the two photographic plates during fifty-one days (April 21 to June 10). It took food a little irregularly, as sometimes happens in the spring, but the results were consistent throughout, since the fish attempted in the same manner to take whatever was offered with both plates (fig. 6, B, and table 1).

Mudminnow no. 55, which had learned the red-green combination, was also used with the two grays. The fish also gave no evidence of a perception of difference between the light and dark plates (fig. 6, A, and table 1).

Summary of experiments in regard to color vision of mudminnows

1. Mudminnows are able to distinguish between the following wave lengths of light: red, 600μ to 730μ and green 510μ to 570μ ; red 600μ to 730μ and blue 420μ to 480μ ; yellow 580μ to 630μ , 660μ to 710μ , and green 510μ to 570μ , as is shown by the formation of associations of paper and food with these colored lights.

2. Red and blue, and red and violet papers are distinguished in the same way.

3. Varying the relative intensities of the colored lights from 1.4 c.m. to 4.9 c.m. does not affect the result, which indicates that the reaction is to color rather than to intensity.

4. This conclusion is further supported by the fact that fishes (no. 55 and no. 60) which had previously shown that they perceived the difference between monochromatic gelatin filters (mudminnow no. 55 has shown a nearly perfect record with red and green, fig. 3, D) could not distinguish between photographic plates which had been 'fogged' to different shades of gray.

EXPERIMENTS WITH STICKLEBACKS

The tests applied to the sticklebacks were similar to those made upon the mudminnow. Experiments were performed using the electrical apparatus attached to the rheostat previously described (fig. 5). Two sets of monochromatic filters were presented to the fishes; these were yellow no. 73 with blue no. 76, and red no. 71 with green no. 74. After repeated tests with the red and green filters, the light intensity was varied, as had been done with the mudminnows. Observations were also made to test the discrimination of shades of gray.

EXPLANATION OF FIGURES ON FOLDER

Fig. 6 Curves representing the results of experiments on the discrimination of light shining through photographic plates 'fogged' to different shades of gray. Construction of curves same as in figure 1.

A. Mudminnow no. 55. Dark gray plate indicating presence of food and lighter gray plate indicating presence of paper. Duration of the experiment, 30 days, May 12 to June 10.

B. Mudminnow no. 60. Dark gray plate indicated presence of food and light gray plate indicated presence of paper. Duration of the experiment, 51 days, April 21 to June 10. There was no day without one or more errors.

Fig. 7 Curves representing the results of experiments on the discrimination of colors and light intensities by sticklebacks. Construction of curves same as in preceding figures.

A. Stickleback no. 65. Blue and yellow lights, blue indicated presence of food and yellow indicated paper. Duration of experiment, 18 days, April 28 to May 15.

B. Stickleback no. 66. Blue and yellow lights, blue indicated presence of food and yellow indicated paper. Duration of the experiment, 16 days, April 26 to May 13.

C. Stickleback no. 65. Green and red lights; green indicated presence of food and red indicated paper. Duration of the experiment, 21 days, May 16 to June 5.

D. Stickleback no. 66. Green and red lights, green indicated presence of food and red indicated paper. Duration of the experiment, 17 days, May 16 to June 1.

E. Stickleback no. 65. Light shining through photographic plates 'fogged' different shades of gray, the darker plate (exposed to light 4 seconds) indicated presence of food and the lighter plate (exposed to light 1 second) indicated paper. Duration of the experiment, 32 days, March 27 to April 27.

F. Stickleback no. 66. Light shining through photographic plates 'fogged' different shades of gray, the darker plate (exposed to light 4 seconds) indicated presence of food and the lighter plate (exposed to light 1 second) indicated paper. Duration of the experiment, 32 days, March 27 to April 27.

Fig. 8 Curves representing the results of experiments on the discrimination of colored lights by sticklebacks. Construction of curves and lettering same as in figure 1.

A. Stickleback no. 46. Green and red lights. During the first 34 days (*b-c*) green indicated presence of food and red indicated paper; during the remaining 56 days, red indicated presence of food and green indicated paper. The duration of the entire experiment was 90 days, December 5 to April 3.

B. Stickleback no. 50. Green and red lights. During the first 32 days (*b-c*) green indicated presence of food and red indicated paper; during the remaining 92 days (*c-d*) red indicated food and green indicated paper. During the last 20 days the lights were varied in intensity (*v-v*). Duration of the entire experiment, 124 days, January 6 to May 8.

Fig. 9 Curve representing the results of experiment on the discrimination of patterns by mudminnow no. 27. Construction of curves same as in preceding figures. A square of black paper 2.7 cm. indicated presence of food and four black dots 1 cm. in diameter indicated paper. Duration of the experiment, 38 days, February 27 to April 5.

Fig. 10 Curves representing the results of experiments on the discrimination of calves' liver and gray paper offered alternately to stickleback no. 57. As in figure 1, only the errors of each day's record are shown in the curves.

A. Duration of the experiment, 35 days, October 24 to November 28.

B. Repetition of experiment represented by curve A. This was begun 44 days after the first experiment had been discontinued. Duration of the experiment, 30 days, January 12 to February 10.

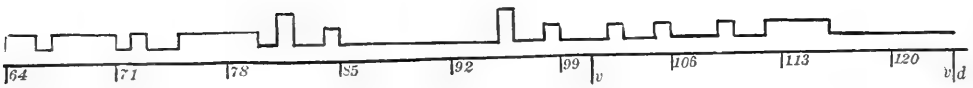
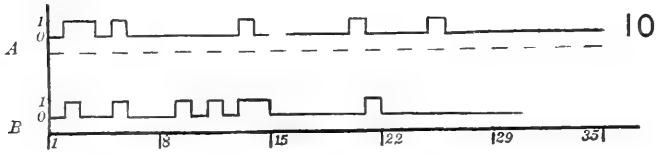
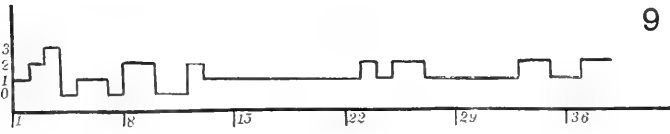
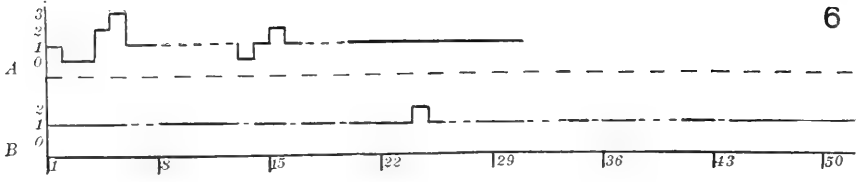

7

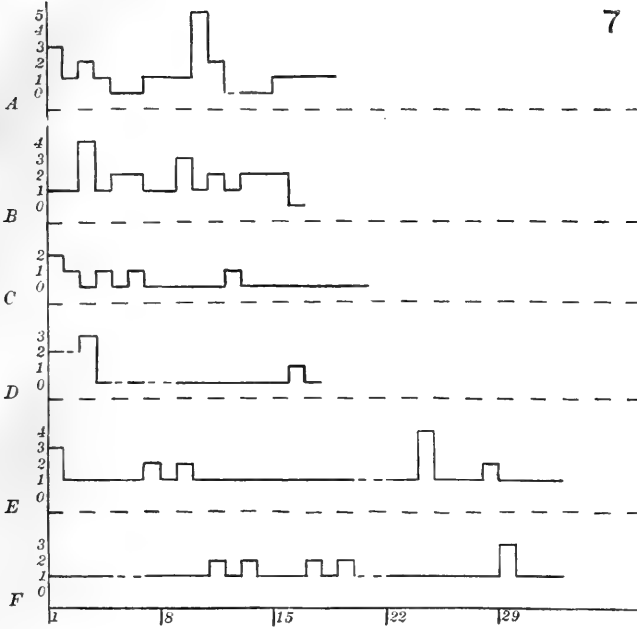

8

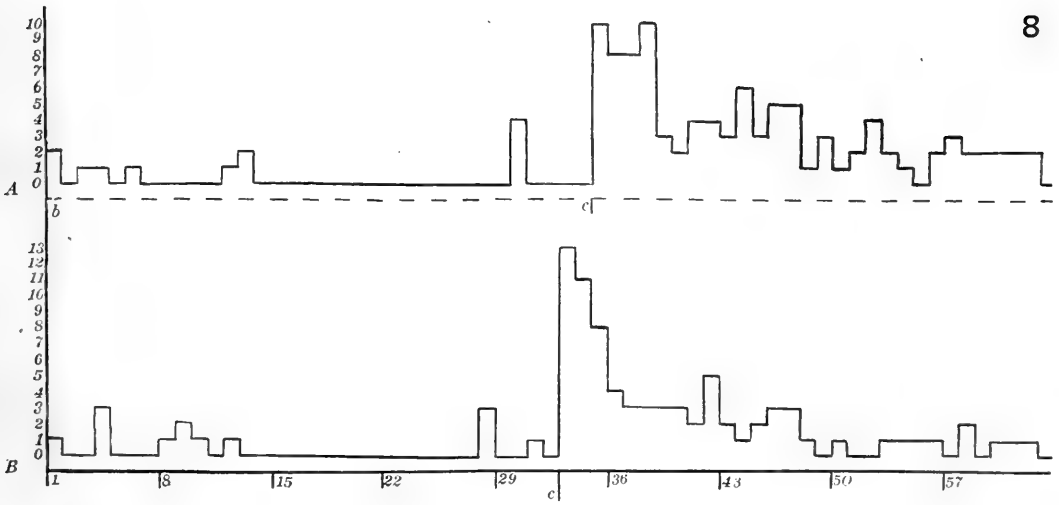

Experiments with monochromatic blue and yellow filters

Tests with blue and yellow filters were applied to two sticklebacks, no. 65 and no. 66. The lights were flashed alternately upon the fishes, the blue being associated with food and the yellow with paper. The yellow light seemed to the human eye considerably brighter than the blue, and the blue plate was much more opaque than the green plate which was used in combination with the yellow in the test made upon mudminnow no. 60. If intensity of light was the determining factor in these discriminations by the fishes, the yellow-blue combination offered the greatest contrast of any experiment tried and might have been expected to secure the most positive results. But, strange to say, the records of this experiment fail to show any clear evidence of discrimination. Only 22.22 per cent of the total number of trials proved to be correct for stickleback no. 65, and 16.12 per cent in the case of stickleback no. 66. It was demonstrated in a later experiment that the failure was not due to the complexity of the test since these fishes learned to discriminate red and green lights (fig. 7, A, B; table 3).

Experiments with monochromatic red and green filters

Red and green lights were presented alternately to four sticklebacks including the two which had given negative results in the experiment with blue and yellow lights just described.

The experiments on no. 65 and no. 66 were among the last tests made, but an account will be given of them here so that these results may be compared with the yellow-blue experiment. The fishes very soon demonstrated that they detected qualitative differences in the green (no. 74) and red (no. 71) lights which were flashed upon them, reacting differently to each light. After several trials the fishes exhibited hesitation in approaching the forceps in red light or refused to do so altogether, while in every case they snapped at the forceps in green illumination. The test lasted only seventeen days for stickleback no. 66 and twenty days with stickleback no. 65, since it was the purpose of this experiment to observe whether they could discriminate

TABLE 3

Results of experiments in which sticklebacks were taught to take food offered with light passed through monochromatic gelatin filters, and to refuse paper resembling food in appearance, when offered with other monochromatic lights. 'Lights,' 'colors reversed,' 'intensity varied,' 'gray plates,' have the same meaning as in table 1 and the colors are as before represented by B for blue, G for green, R for red, and Y for yellow. 'Food and paper' means that calves' liver and gray paper quite different in appearance were offered alternately without colored illumination

FISH	TYPE OF EXPERIMENT	DURATION OF EXPERIMENT	NUMBER OF TRIALS	NUMBER OF TIMES CORRECT	NUMBER OF ERRORS	PER CENT OF TIMES CORRECT	PER CENT OF ERRORS
		<i>days</i>					
No. 46	G and R lights.....	34	66	54	12	81.82	18.18
	Colors reversed.....	28	108	8	100	8.00	92.00
		28	34	24	10	70.59	29.41
No. 50	G and R lights.....	32	58	45	13	77.59	22.41
	Colors reversed.....	20	83	15	68	18.07	81.93
		20	50	34	16	68.00	32.00
		20	52	41	11	78.85	21.15
	Intensity varied.....	23	91	84	7	92.32	7.68
No. 65	Gray plates.....	32	39	1	38	2.56	97.44
	B and Y lights.....	18	27	6	21	22.22	77.78
	R and G lights.....	20	22	1	5	77.18	22.72
No. 66	Gray plates.....	32	34	00	34	00.00	100.00
	B and Y lights.....	16	31	5	26	16.12	83.18
	R and G lights.....	17	17	11	6	64.72	35.28
No. 57	Food and paper.....	35	39	33	6	84.62	15.38
	Food and paper.....	30	41	34	7	82.93	17.07

between the colored lights, rather than whether a permanent association could be formed (fig. 7, C, D; table 3).

Experiments of longer duration were performed on stickleback no. 46 and stickleback no. 50. No. 46 was first trained to come for food in green light, and to inhibit the impulse when paper closely resembling the food in color was offered in red light. This test continued thirty-four days, January 5 to February 7. On only seven days do the records show errors, and during sixteen successive days a perfect record was maintained. On the thirty-fifth day the colors were reversed. The permanency

of the acquired association was demonstrated by the fact that during the twenty days following the fish persisted in attempting to take the paper under the green light which had previously shone upon its food. The reversal of the colors seemed to confuse the fish, and an errorless record with the new conditions was never shown as in the previous test. It required a much longer period to form the habit of taking food in red light and refusing paper in green light than to form the first association. The entire experiment lasted ninety days, January 5 to April 3 (fig. 8, A; table 3).

Stickleback no. 50 learned to react negatively to paper offered in red light and positively to food in green light in a series of tests continuing thirty-two days, at the end of which there was a perfect record of fifteen days. Stickleback no. 50 reacted in the same manner to the reversal of colors as had stickleback no. 46. The association of food with green light was overcome with great difficulty, but after seventy-one days of experiment had elapsed, the fish was tested on ten successive days without errors being made. Although the light intensity was varied for the last twenty-three days of the experiment, the oscillations of successes and failures which took place seemed not to be correlated with the relative intensities of the lights, and it may be noted in the tabulated results (table 2) that the highest percentage of successes for the whole experiment was recorded during this period (fig. 8, B).

Like the mudminnows, the sticklebacks tested showed that they were able to distinguish between red (600μ to 730μ) and green (510μ to 570μ), but the experiments indicated that with blue (420μ to 480μ) and yellow (580μ to 630μ , 660μ to 710μ) there was no such discrimination.

Experiment with an aquarium of sticklebacks

An interesting piece of evidence was obtained from an aquarium containing fourteen sticklebacks. These fishes were kept under observation for several months, during which they were regularly fed and became very tame. Calves' liver was given to

them nearly every day from forceps. It was very amusing to see all fourteen of them dart to the top at a slight movement of anyone near them and begin sticking their noses out of the water in anticipation of food. When food was held a slight distance out of water, they would with one accord leap out after it, and at times hang on so tightly that they could be lifted several inches out of the water before letting go their hold.

On one occasion, after the sticklebacks had been given a small piece of calves' liver, the forceps were held out to them empty. None of the sticklebacks approached the forceps, but the merest bit of dark red liver was sufficient to attract them,

A bit of rather bright red paper rolled into a ball and substituted for the food was at once attacked. Tan-yellow presented in the same way elicited no positive response. Lavender which had a pinkish tinge was snapped at twice, while dark blue, gray, yellow, and green failed to attract. When dark red paper, which most closely resembled the color of the liver, appeared the fishes darted towards it from all directions seizing it voraciously. Reddish purple was snapped at several times. These papers were compared with Klingsiek and Valette's Code de Couleur and were found to resemble most closely the following numbers:

Dark red—rouge no. 3

Red—rouge no. 6

Tan-yellow—orange no. 146

Yellow—orange-jaune no. 166

Green—vert no. 301

Blue—bleu violet no. 452

Gray—bleu violet no. 460

Lavender—violet no. 528B

Purple—violet rouge no. 571

This experiment indicates that the color of the food which sticklebacks take habitually makes an impression difficult to eradicate. Red no. 6 seemed to the eye to be very bright; red no. 3 was quite as dark as blue no. 452, and not so dark as gray no. 460 which was rejected.

Experiments with gray filters

Gray filters were presented alternately to the two sticklebacks no. 65 and no. 66 exactly as they had been offered to mudminnows no. 55 and no. 60. It may be noted that these were the same sticklebacks which had been subjected to the experiment with yellow and blue lights and to the experiment with red and green; both had manifested the power to discriminate between red and green. In contrast the experiment with the gray filters was very striking, for on no occasion does the record show a day without error for either fish. Neither of the curves touches the point at *O* at any time during the experiments (fig. 7, E, F; table 3).

Summary of results in regard to color vision of sticklebacks

1. Sticklebacks were not able to distinguish between blue and yellow lights of the following wave-lengths: 420μ to 480μ and 580μ to 630μ and 660μ to 710μ .
2. Red 600μ to 730μ and green 510μ to 570μ were distinguished even when the relative intensities of these lights are varied from 1.4 c.m. to 4.9 c.m.
3. Photographic plates 'fogged' to a light and a dark gray were not distinguished.
4. Sticklebacks form decided associations respecting the color of the food which they habitually eat.

GENERAL CONCLUSIONS ON COLOR VISION IN FISHES

The experiments described in this paper and the work of other investigators furnish evidence that some species of fishes perceive differences in colors, and that this discrimination is based upon the wave-length of the light, not on intensity. It seems rather unlikely that the color vision of fishes approximates in character that of human beings. It would be of interest to know what range of colors fishes react to. The stickleback, at least, seems unable to discriminate between blue (420μ to 480μ) and yellow (580μ to 630μ , 660μ to 710μ). Whether these colors are confused by mudminnows also has not been tested.

Color perception seems to be of some importance in the lives of fishes, since color associations are formed and persist for a considerable time. Such associations may be formed even when the colors are not present simultaneously. The value of such associations to fishes which seek their food in shallow water would be obvious. Food of a particular color once found to be desirable may be singled out and pursued and undesirable substances more easily avoided.

It is somewhat premature to discuss at length the theory of color vision which the results of these experiments would seem to support. The duplicity theory of von Kries assumes that achromatic scotopic (dark-adapted) human vision is carried out through the mediation of the rods alone, the cones being the organ of photopic (light-adapted) vision. This conclusion is derived from the fact that the fovea of the eye consists entirely of cones, while the extreme periphery contains only rods; the remainder of the retina had both rods and cones. The visual purple is located in the rods. For the light-adapted eye, the fovea is the point of keenest vision, and the brightest part of the spectrum is in the yellow. When the eye is dark-adapted, on the other hand, the fovea is no longer the seat of keenest vision, but instead objects are seen more clearly when focused at points away from the center of the eye. Green appears to the dark-adapted eye as the brightest area of the spectrum and it is in green light that visual purple is most strongly bleached. The theory accounts very well for cases of total color-blindness where the fovea of the eye is affected and the eye is unable to focus strongly on any object. In such instances bright light hinders vision. Night blindness might be explained on the basis of a defect in the rods' interfering with vision in low illumination, but leaving vision in light of higher intensity unimpaired. The researches of Hess on the comparative physiology of vision in the lower animals, however, give little support to the duplicity theory, since the eyes of all classes of vertebrates show adaptation to light and darkness, even including tortoises which have neither rods nor visual purple. The results of the experiments with the sticklebacks described in this paper seem to have little or no bearing upon this theory.

Hering bases his theory of opponent colors on the sensations of complementary colors. When certain wave-lengths of red and green are presented to the human eye simultaneously, the result is a colorless sensation. The simultaneous perception of yellow and blue of certain wave-lengths produces the same effect. These four color sensations, red, green, blue, and yellow, are regarded by Hering as the primary ones from mixtures or dilutions of which all other color sensations are derived. To these are added the primary sensations, black and white, which on mixture result in sensations of gray. This theory maintains that there exists in the eye three distinct visual substances affected by pairs of antagonistic physiological processes in such a way as to produce the six primary sensations, white-black, red-green, and yellow-blue. In favor of this theory is claimed for consideration the color sensitivity of the part of the normal human retina lying outside of the fovea. The extreme periphery of the retina is color-blind. Within this totally color-blind zone lies an area which is red-green blind, but is sensitive to blue and yellow stimuli, while the center of the retina is sensitive to all colors. The most common form of color-blindness is that in which red and green are not discriminated, and cases are known in which yellow and blue are confused. Either type of color-blindness might be explained by the absence of one of the physiological substances. The same explanation might be applied to account for the failure of the sticklebacks in the experiments described to discriminate between yellow and blue.

The observation that on mixture red, green, and blue produce white is the basis for the Young-Helmholtz theory, according to which there are three primary colors instead of four from which all other colors are derived. The wave-lengths of the red and the blue are closely identical with the fundamental colors chosen by the upholders of the four-color theory, while the green lies on the yellow side of the green of Hering's theory. This theory explains very well certain cases of partial color-blindness by assuming the absence or diminution of one of the three theoretical components. If this theory accounts for the inability of sticklebacks in these experiments to discriminate between blue

and yellow, the blue component must be assumed to be lacking. These results seem to be explained equally well according to the four-color theory of Hering and the three-color theory of Young-Helmholtz.

EXPERIMENTS IN THE DISCRIMINATION OF PATTERNS

Mast ('14) and Sumner ('11) have shown that certain flat fishes adapt the color markings of their skin to the background against which they rest. Such an adaptation would be frequently of protective value. According to Mast, such stimulation is received through the eye. One naturally inquires whether recognition of differences in the configuration of their environment is of use to fishes in seeking their food. Experiments with a view to ascertaining whether this is the case were carried out on the stickleback and the mudminnow.

Mudminnows no. 27 and no. 40 which had given positive results in the color experiments were tested in several ways to discover whether they could form associations of food and paper with various patterns. On the center of a round piece of cardboard 7 cm. in diameter was pasted a five-pointed star of black paper. A ring of black paper 5.3 cm. in diameter and 1 cm. wide was pasted to a similar white card. When the star was held above the tank containing the fish, forceps containing food were presented, while the circle signified gray paper which matched the food. As in the color tests, the fishes were made to leap out of water to obtain the bait. Mudminnow no. 40 when subjected to this test exhibited during twelve days no signs of forming an association with the patterns.

Dots and stripes were the test next applied. Black stripes 1 cm. wide were pasted on white cardboard 1 cm. apart. On another white cardboard were pasted black dots 1.8 cm. in diameter and the same distance apart. Except for the designs on the cards the test was in all respects similar to the previous one, and the results were similar, for mudminnows no. 27 and no. 40 to which it was applied attempted to take food in the same manner when either card was held above them.

A circle of black paper 4.5 cm. in diameter pasted on a white card was not distinguished from a black square 4 cm. across, when they were presented under the same conditions as those used in the tests described above, by mudminnow no. 39 during thirty-seven days.

In order as nearly as possible to duplicate the conditions of the experiments with colored lights, two pieces of glass were cut the size of the gelatin filters. Upon the center of one was placed a square of black paper 2.7 cm. across and upon the other four black circles 1 cm. in diameter. These plates of glass were inserted in the tin box and the light flashed through them upon the fishes. The appearance of the square was accompanied by food and the black dots were to suggest paper. At the end of thirty-eight days (February 27 to April 5) mudminnow no. 27 showed no signs of discrimination (fig. 9).

Two sticklebacks, no. 63 and no. 64, were subjected to the following experiment. Glass plates fitting into the tin box were used. On one was a square 2 cm. in size and on the other a black circle 2.5 cm. in diameter. Neither fish showed that it perceived the difference between them, though the experiment continued sixty days.

While these experiments do not absolutely prove that differences in pattern are not perceived by mudminnows and sticklebacks, they suggest that the discrimination of patterns and differences in backgrounds does not have a very important function in their search for food. No associations appeared to be formed with the patterns used. These results are in sharp contrast with those of the tests with colors.

ASSOCIATIONS FORMED IN FISHES

Types of associations

The analysis of the psychology of a fish, like that of any other animal, can only be made by interpreting its immediate reactions to stimuli of various sorts. The nature of the sense organs and the reacting organism must determine the types of associations formed, whether they are merely associations of particular

muscular reactions with special stimuli without apparent consciousness of their purpose on the part of the animal, or psychological associations of a higher type.

The formation of associations with color stimuli has already been shown to exist, but under similar conditions associations with patterns were not formed in the tests made.

Associations with objects were found to occur. A large live dobson-larva was dropped into a tank containing a mudminnow. At first the larva was repeatedly attacked, but when, after a dozen or more trials, the fish was unable to devour it, the larva was completely ignored, although living Crustacea, worms, and other baits were taken. At other times forceps containing no food attracted mudminnows.

Moving objects and shadows nearly always induced reaction. Sudden movements caused the fishes to swim about rapidly as if frightened and in search of cover. After the fishes had become accustomed to being fed at the top of the water, the approach of anyone caused the fishes to swim to the surface. Short, jerky, wriggling motions as those of a worm attracted and agitated them.

Jarring the tank produced the same result, probably owing to the fact that it was customary to lift the vessel containing a fish about to be tested and set it on the front of the table. While moving a receptacle, it was necessary to keep it covered because the fishes were likely to leap out of the water, sometimes landing outside of the vessel. Fishes freshly brought into the laboratory or those which had not been experimented upon could be carried about in small vessels without showing any inclination to jump out. A very definite motor association seemed to exist in all the fishes with which tests were made, for shadows, movements of the investigator, jarring the aquaria, all excited the fishes to leap out of water, even when no food was in sight.

There is some evidence that the fishes associated a certain time of day with their feeding. It was generally the custom to perform the experiments at about the same hour each day; usually in the afternoon. Changing the water in the tanks was found to be a more difficult proceeding if it was done at the usual feeding

hour, even if the fishes had been fed, for they were more likely to become excited. Goldsmith ('12) reports place association in gobies and plaice. This has not been confirmed by tests on the mudminnow and the stickleback in any respect other than their swimming to the surface for food. An effort was made to induce them to seek habitually a certain end of the tank where food was dropped in through a tube, but there was no indication that such a habit had been formed.

Delicacy of associations

It was presumed that associations formed in the nervous organism of fishes would not be such as to admit of fine discriminations; this was borne out by the experiments. Filters of different shades of red and green could be interchanged without affecting the reactions. The pattern experiments brought no positive results.

A stickleback, no. 57, was offered minced liver and gray paper alternately thirty-nine times in thirty-five days. The fish learned very quickly to refuse the paper and to leap out after the liver, but small pieces of angletworm could be substituted for the liver without the fish obviously perceiving the difference. The successes were 84.62 per cent and the errors 15.38 per cent; during the last ten days of the experiment not a single error was recorded. A similar record was shown when the experiment was repeated with the same stickleback, when in thirty days the successes were 83.03 per cent and the mistakes were 17.07 per cent; all the reactions during the last nine days were perfect (fig. 10; table 3).

Complexity of associations.

Fishes are evidently capable of forming only very simple associations directly related to their struggle for existence. This is to be expected, since, so far as is indicated, they possess only the kind of attention which leads directly to activity. Thorndike ('11) reports being able to induce *Fundulus* to seek exit from

a box into the sun through an opening. According to Churchill ('16), goldfish are able to 'learn a maze' consisting of two partitions placed at intervals across a vessel a short distance from each other. The fishes were placed in a compartment at one end and were obliged to pass through holes in the two partitions in order to reach the opposite end of the aquarium where food was located. The habit proved to be fairly well established, for, after thirteen days' lapse, the fishes were able to follow the route correctly.

In the present experiments sticklebacks showed no disposition to lessen the time of passing through a triangular opening at the bottom of a glass partition when food was dropped on the other side, but simply darted against the glass until they chanced to hit the opening and swim through. The experiment continued thirty-four days, two fishes being used. The trials were carefully timed with a stop-watch, and no improvement or lessening of the time was noted.

Permanence of associations

The results of the experiments described have some bearing on the permanence of associations. Mudminnow no. 55 showed the influence of previous training by red and green filters forty-two days after the first series of experiments had ceased. During the color tests perfect records of ten or more consecutive days were frequently shown, while in one instance a fish made no mistakes during fifteen days and in another instance during sixteen days. Discontinuing an experiment for a day or two after an association was fairly well established never seemed to dull the impression received. When trained to spring out of water after food, the fishes repeated the action indefinitely as long as food could be procured in that manner and almost completely ignored bits of food dropped into the water.

Modification of associations

Associations once established persisted in a rather stereotyped fashion. After being accustomed to take food in light of a certain

color, mudminnows, and even more especially the sticklebacks were confused by the reversal of the food and paper in relation to the colors. The reversed combination seemed to be more difficult to master than the original one.

GENERAL CONCLUSIONS FROM THE EXPERIMENTS DESCRIBED

Compared with land vertebrates, fishes live in a constant medium where little premium is put upon sensory specialization. None of the sense organs have a marked degree of perfection. The behavior of fishes is stereotyped. Their associations are simple, few in number, and are not readily modified, though they are often fairly permanent when once formed. 'Learning' seems to consist for the most part in the gradual elimination of useless movements and the establishing of useful ones.

There is little evidence of the formation of new types of movements. A considerable period of training in concentrating the attention upon the object in view seems to be necessary before associations can be formed.

That instincts may be inhibited is demonstrated in the color experiments where the fishes gradually overcame the impulse to leap out after paper which resembles their food in light of a certain color when they had thus been several times unsuccessful in obtaining food. Stickleback no. 57, after being repeatedly offered gray paper alternately with pieces of liver, refused to spring out after the paper.

Fishes do not seem to be capable of anything which might properly be called a concept, nor to exhibit memory in the sense of having ideas about absent objects. They do react more readily to present objects with which they have had experience in the past, particularly if this experience has been several times repeated. There is nothing to indicate that they are able to recall an image of their past experience. After some repetition of a reaction they form associations and habits.

Imitation in fishes is well described by Hobhouse's definition of sensory-motor imitation: "the perception of what is done discharges a motor impulse to do the same thing quite apart from any purpose to be served by doing it." Sticklebacks which

swim in schools show no evidence of an intelligent purpose in swimming in any particular direction other than that one individual, not always the same one, happens to make a sudden dart. The movement is perceived by the rest and immediately followed. If one of the fishes chances to obtain a bit of food, the others attracted by the motion, are as likely to pounce upon the fortunate one as they are to attack the food lying close at hand. They strike their rival quite as often on the tail or fins as on the mouth. If the aggregation of fishes into schools represents the beginning of social consciousness it must be very dim and obscure. It is quite possible that fishes of the same school are attracted to each other by characteristic odors and the movements peculiar to the species. There seems to be no clear proof of the subordination of the welfare of the individual to the general good of its kind, nor any decided development of a social or gregarious instinct.

GENERAL SUMMARY

1. Mudminnows were able to discriminate between the following wave-lengths of light: red 600μ to 730μ and green 510μ to 570μ , red 600μ to 730μ , and blue 420μ to 480μ , yellow 580μ to 630μ , 660μ to 710μ , and green 510μ to 570μ , as is shown by associations of paper and food with these colored lights (pp. 462-474).

2. Varying the intensity of the red and green lights and the yellow and green lights from 1.4 c.m. to 4.9 c.m. did not affect such discrimination, indicating that the reactions were to color rather than to intensity. This conclusion is further supported by the fact that fishes which had previously shown that they perceived differences between monochromatic gelatin filters were not able to distinguish between photographic plates which had been 'fogged' to different shades of gray (pp. 466-474).

3. Sticklebacks were not able to discriminate between the following wave-lengths of light: blue 420μ to 480μ and yellow 580μ to 630μ , 660μ to 710μ , but were able to discriminate between red 600μ to 730μ and green 510μ to 570μ , forming associations of food and paper with them. These associations per-

sisted unchanged even when the relative intensities of these lights were varied from 1.4 c.m. to 4.9 c.m. Differences in the intensity of light passing through photographic plates 'fogged' to a light and dark gray were not distinguished (pp. 475-483, 485).

4. That sticklebacks form decided associations respecting the color of the food which they habitually eat was further shown by the experiment in which fourteen sticklebacks in an aquarium were offered food and paper of various colors (pp. 483-484).

5. Although the experiments summarized above show that the discrimination of differences in colors by mudminnows and sticklebacks is based upon wave-length rather than intensity, it seems unlikely that the color vision of fishes is as highly developed as that of man, for sticklebacks, at least, seem unable to distinguish between blue 420μ to 480μ and yellow 580μ to 630μ , 660μ to 710μ .

6. The results of the experiments with sticklebacks give little support to the duplicity theory of v. Kries, but might be explained upon the basis of Hering's theory of opponent colors if it is assumed that the yellow-blue substance is lacking. The conclusions seem to accord with the Young-Helmholtz theory if it is supposed that the eye of sticklebacks has none of the blue component.

7. The negative results in the experiments with patterns strongly suggest that the discrimination of patterns and differences in backgrounds by mudminnows and sticklebacks does not have a very important function in their search for food. The perception of color and movement seem to be of the most importance. In sticklebacks the sense of smell is also used to a considerable extent.

8. The behavior of fishes is stereotyped. The associations formed are simple, few in number, and not open to ready modification, though they may be fairly permanent, and may involve considerable acuity in sensory discrimination. 'Learning' seems to consist for the most part in the gradual elimination of useless movements and the establishing of those which are useful.

BIBLIOGRAPHY

- BATESON, W. 1889-1890 Sense organs and perceptions of fishes with remarks on the supply of bait. *Jour. Marine Biol. Assoc. V. K., N. S.*, vol. 1, pp. 225-256.
- BAUER, V. 1910 Über das Farbenunterscheidungsvermögen der Fische. *Pflüger's Arch. f. d. ges. Physiol.*, Bd. 133, S. 7-26.
1911 Zu meinen Versuchen über das Farbenunterscheidungsvermögen der Fische. *Ibid.*, Bd. 137, S. 622-625.
- CHURCHILL, E. P., JR. 1916 The learning of a maze by goldfish. *Jour. An. Beh.*, vol. 6, pp. 247-255.
- COPELAND, M. 1912 The olfactory reactions of the puffer, or swellfish, *Spheroides maculatus* (Bloch and Schneider). *Jour. Exper. Zoöl.*, vol. 12, pp. 363-368.
- EDINGER, E. 1899 Have fishes memory? *Annual Rept., Smithsonian Inst.*, 1899, pp. 375-394.
- FRISCH, K. 1912 Über farbige Anpassung bei Fischen. *Zool. Jahrb., Allge. Zool.*, Bd. 32, S. 171-230.
1912 Sind die Fische farbenblind? *Ibid.*, Bd. 33, S. 107-126.
1912 Über die Farbenanpassung des *Crenilabrus*. *Ibid.*, Bd. 33, S. 151-164.
1914 Weitere Untersuchungen über den Farbensinn der Fische. *Ibid.*, Bd. 34, S. 43-68.
- GOLDSMITH, M. 1912 Contribution a l'étude de la mémoire chez les poissons. *Bull. Inst. Gén. Psych.*, T. 12, pp. 161-176.
- GRABER, V. 1884 Grundlinien zur Erforschung des Helligkeits- und Farbensinnes der Tiere. *Prag und Leipsig*, S. 126-132.
- HERRICK, C. J. 1903 The organ and sense of taste in fishes. *Bull. U. S. Bur. Fish.*, vol. 22, pp. 237-272.
- HESS, C. 1909 Untersuchungen über den Lichtsinn bei Fischen. *Arch. Augenheilkde., Ergänzungsheft*, Bd. 64, S. 1-38.
1912 Untersuchungen zur Frage noch dem Vorkommen von Farbensinn bei Fischen. *Zool. Jahrb., Allge. Zool.*, Bd. 31, S. 629-646.
1913 Neue Untersuchungen zur vergleichenden Physiologie des Gesichtsinnes. *Ibid.*, Bd. 33, S. 387-440.
- LOEB, J., AND WASTENEYS, H. 1915 The identity of heliotropism in animals and plants. *Science, N. S.*, vol. 41, pp. 328-330.
- LONGLEY, W. H. 1914 Report upon the color of fishes of the Torgugas Reefs. *Year Book of the Carnegie Inst. of Wash.*, no. 13, pp. 207-208.
1915 Coloration of tropical reef fishes. *Ibid.*, no. 14, pp. 208-209.
1917 Studies upon the biological significance of animal coloration. I. Colors and color changes of coral-reef fishes. *Jour. Exper. Zoöl.*, vol. 23, pp. 533-599.
- LYON, E. P. 1904 On rheotropism. I. Rheotropism in fishes. *Amer. Jour. Physiol.*, vol. 12, pp. 149-161.
- MAST, S. O. 1914 Changes in shade, color, and pattern in fishes, and their bearing on the problem of adaptation and behavior, with special

- reference to the flounders *Paralichthys* and *Ancylopsetta*. Bull. U. S. Bur. Fish., vol. 34, pp. 173-238.
- 1915 The behaviour of *Fundulus* with especial reference to overland escape from tide pools and locomotion on land. Jour. An. Beh., vol. 5, pp. 341-350.
- MINKIEWICZ, R. 1912 Recherches sur la formation des habitudes, le sens des couleurs, et la mémoire chez les poissons. Annales de l'Inst. Océanographique (Monaco), T. 5, Fasc. IV, pp. 1-53.
- PARKER, G. H. 1903 Hearing and allied senses in fishes. Bull. U. S. Bur. Fish., vol. 22, pp. 45-64.
- 1905 The function of the lateral line organ in fishes. Ibid., vol. 24, pp. 183-207.
- 1909 The integumentary nerves of fishes as photoreceptors and their significance for the origin of the vertebrate eye. Am. Jour. Physiol., vol. 25, pp. 77-80.
- 1910 Structure and functions of the ear of the Squeteague. Bull. U. S. Bur. Fish., vol. 28, pp. 1211-1224.
- 1910 Influence of the eyes, ears, and other allied sense organs on the movements of the dogfish, *Mustelus canis* (Mitchell). Ibid., vol. 29, pp. 43-55.
- 1910 Olfactory reactions of fishes. Jour. Exper. Zoöl., vol. 8, pp. 535-542.
- 1911 The olfactory reactions of the common killifish, *Fundulus heteroclitus* (Linn.). Jour. Exper. Zoöl., vol. 10, pp. 1-5.
- 1911 Effects of explosive sounds such as those produced by motor boats and guns upon fishes. U. S. Bur. Fish., Doc., no. 752, pp. 3-9.
- 1912 Sound as a directing influence in the movements of fishes. Bull. U. S. Bur. Fish., vol. 30, pp. 97-104.
- 1913 The directive influence of the sense of smell in the dogfish. Ibid., vol. 33, pp. 61-68.
- PARKER, G. H., AND SHELDON, R. L. 1912 The sense of smell in fishes. Bull. U. S. Bur. Fish., vol. 32, pp. 35-46.
- PARSONS, J. H. 1915 An introduction to the study of color vision. Cambridge: at the University Press, New York: G. P. Putnam's Sons.
- REIGHARD, J. 1908 An experimental field-study of warning coloration in coral-reef fishes. Papers from the Tortugas Lab., Carnegie Inst. Wash., vol. 2, pp. 257-325.
- SHELFORD, V. E., AND ALLEE, W. C. 1913 The reactions of fishes to gradients of dissolved atmospheric gases. Jour. Exper. Zoöl., vol. 14, pp. 207-266.
- 1914 Rapid modification of the behavior of fishes by contact with modified water. Jour. An. Beh., vol. 4, pp. 1-30.
- SUMNER, F. B. 1911 The adjustment of flatfishes to various backgrounds: a study of adaptive color change. Jour. Exper. Zoöl., vol. 10, pp. 409-505.
- THORNDIKE, E. L. 1911 Animal intelligence. Macmillan Co., New York. pp. 169-171.

- TSCHERMAK, V. A. 1915 Das Sehen der Fische. Die Naturwissenschaften, vol. 3, S. 177-181.
- WASHBURN, M. F. 1913 The animal mind. Macmillan Co., New York, pp. 214, 221, 248, 251.
- WASHBURN, M. F., AND BENTLEY, I. M. 1906 The establishment of an association involving color discrimination in the creek chub, *Semotilus atromaculatus*. Jour. Comp. Neur. and Psych., vol. 16, pp. 113-125.
- WELLS, M. H. 1915 Reactions and resistance of fishes in their natural environment to acidity, alkalinity, and neutrality. Biol. Bull., vol. 29, pp. 221-257.
- ZOLOTNITZKY, N. 1901 Les poissons distinguent ils les couleurs? Arch. de Zool. Expér. et Gén. 3^e Série, T. 9, no. 1, pp. I-V (Notes et Revue).

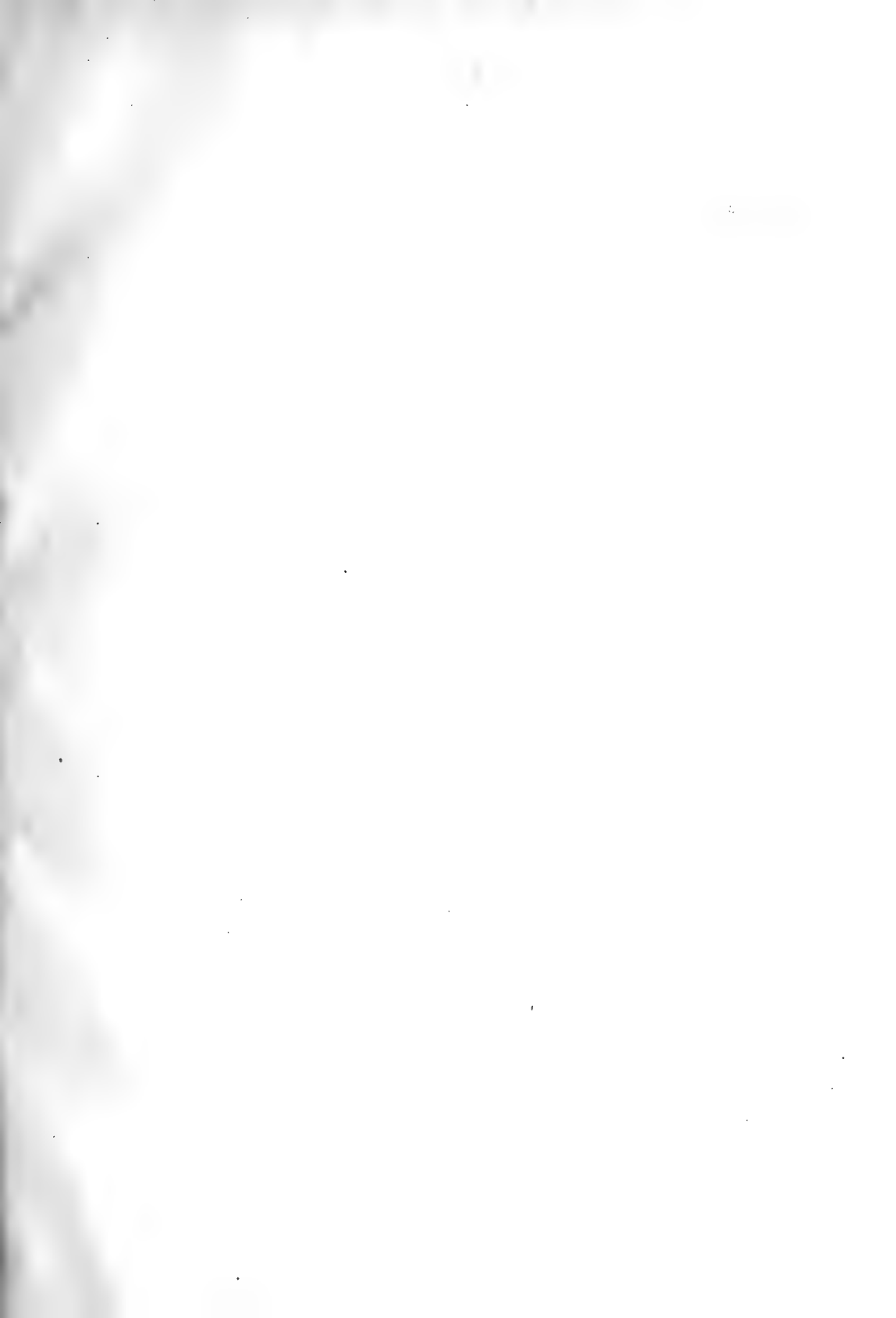

Resumido por el autor, George Howard Parker.

La organización de Renilla.

La rapidez de transmisión en la red nerviosa del borde del pié en la columna de la anémone de mar *Metridium* fué medida por el autor sirviéndose del método empleado comunmente para determinar la velocidad de transmisión en las fibras nerviosas. A la temperatura de 21°C., la velocidad de transmisión en dicha red nerviosa es de 121 a 146 mm. por segundo.

Translation by Dr. José F. Nonidez
Columbia University

THE ORGANIZATION OF RENILLA¹

G. H. PARKER

ONE FIGURE

The curious sea-pen *Renilla* is a most favorable form in which to study colonial organization, for the relatively large size of its autozooids and its complete and natural freedom from attachment make it an unusually satisfactory organism for experimental study. The species upon which the work recorded in this paper was done was *Renilla amethystina* Verrill from the coast of Southern California, and I am under obligations to the staff of the Scripps Institution for Biological Research at La Jolla for many courtesies while I was carrying on this work.

Renilla is unlike other pennatulids in that its rachis, instead of being elongate, is expanded into a broad heart-shaped or kidney-shaped disc, only one surface of which carries zooids. The peduncle is a fleshy tail-like extension and is peculiar in that it is without an axial skeleton. In *Renilla amethystina* the expanded rachis may measure as much as 6 or 7 cm. in breadth and may carry several hundred autozooids and many more siphonozooids. The peduncle, when distended, may reach the length of 5 to 6 cm. Some confusion exists as to the terminology used for the surfaces of *Renilla*. In the conventional system employed for pennatulids the face corresponding to that on which the zooids are borne in *Renilla* is known as the ventral face and the opposite as the dorsal one. As *Renilla* rests on the sand in natural position the upper face is what according to this system would be called ventral, hence this condition has led to some confusion in terminology, for not a few authors have naturally

¹ Contributions from the Zoological Laboratory of the Museum of Comparative Zoölogy at Harvard College, No. 316.

called the upper face dorsal. I shall, therefore, not use the terms dorsal and ventral for the parts in *Renilla*, but shall employ superior and inferior as indicated by the natural position of the animal. The face of the rachis that is upper when the animal is normally at rest and that carries the zoöids is superior, the opposite face inferior.

If an expanded *Renilla* is watched in sea-water its autozoöids, generally distended, will be seen to exhibit from time to time spontaneous withdrawals and expansions. When one of these withdraws, its eight tentacles are first folded together, after which the whole zoöid bends sharply to one side so as to appear to be lying almost flat on the surface of the colony while it slowly slips backward into the cavity occupied by it in the colony as a whole. The complete withdrawal is accomplished in a few seconds. In spontaneous expansion the eight tentacles first open at the aperture in the colonial flesh into which the autozoöid has withdrawn and its body next slowly elongates and rises out of this aperture till it becomes fully extended. The process of expansion requires also only a few seconds, but is usually somewhat slower than that of withdrawal.

In spontaneous withdrawal and expansion the various autozoöids seem to act with complete independence, for no unanimity or sequence of response was observable among them. The individual autozoöids are extremely inert to mechanical stimulation. It is scarcely possible to induce them to respond even to vigorous prodding. They are, however, very responsive to a faradic current, withdrawing at once when this stimulus is applied to them. In this instance, as in spontaneous withdrawal, they act with complete independence and repeated attempts to influence adjacent autozoöids by stimulating a given one always resulted negatively. Only under particular conditions did many of them respond together. When the flesh of the colony as a whole contracted and the contained fluids were thus put under unusual pressure, many autozoöids—withdrawn but apparently relaxed—expanded in unison. Muscular action also appeared at times to increase the volume of the colony as a whole and, under these conditions, many autozoöids simultaneously withdrew.

Both these states, however, were quite obviously dependent upon internal pressure relations and yielded no evidence in favor of the view that one autozoöid has effective nervous connections with another, and thus acts in unison with its neighbor. In fact, the evidence seemed conclusive that so far as nervous organization is concerned the autozoöids are strikingly independent of one another and resemble in this independence the separate fingers of such a sponge as *Stylotella*.

The control of the pressure relations within the body of *Renilla* is accomplished by a mechanism that has been more or less worked out by previous investigators. If a freshly collected *Renilla* is placed in a basin of sea-water, its volume will be found to be much reduced and its autozoöids mostly contracted. Gradually it will be observed to become more and more inflated and its autozoöids will slowly expand, as already described by Müller ('64, p. 354). During the time the *Renilla* is filling itself with water, for such the operation is, the peduncle exhibits rhythmic contractions that have a striking resemblance to intestinal peristalsis. At each onset of activity a wave of contraction can be seen to start in the region where the peduncle is attached to the rachis and proceed thence to the distal end of the peduncle. Waves of this kind run over the peduncle with considerable regularity and occur ordinarily every thirty-five to forty-five seconds. The regular association of this movement of the peduncle with the distention of the body of *Renilla* suggests that the activity of the peduncle is the chief means of accomplishing the distention of the colony as a whole and the canal system within the colony supports this idea.

If a *Renilla* is anesthetized with magnesium sulphate and the peduncle is cut transversely, this body can be seen to consist of a stiff-walled tube containing, as has long been known (Müller, '64; Verrill, '66-'69; Kölliker, '72; Eisen, '76), two canals, one (the inferior) about twice the cross-section of the other. These canals are separated by a thin firm membrane, the transverse septum. If the larger cavity is injected with sea-water containing some indifferent coloring matter in solution, such as methylene blue, the colored fluid passes freely into the cavities of the

rachis and flows out with equal freedom from the mouths of the autozooids over the whole superior surface. If a similar injection is made into the smaller cavity, the colored fluid flows out of only one orifice. This is near the middle of the superior face of the rachis, and at the end of an axial band of somewhat smooth tissue that leads from near the root of the peduncle over the rachis to the region of its center. This orifice was first identified by Müller ('64, p. 354), who described it as the general inlet for the whole canal system of *Renilla*. Kölliker ('72) suspected it to be the mouth of the axial zooid, but Wilson's studies ('84) on the embryology of *Renilla* showed it to be a much enlarged

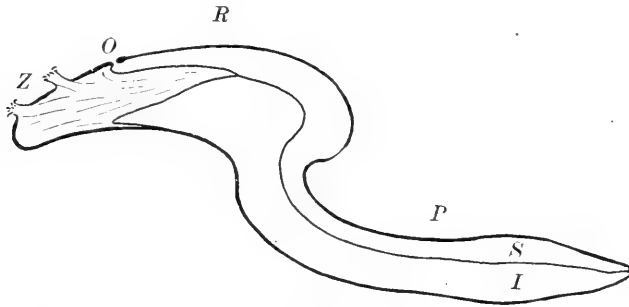

Fig. 1 Diagram of a median section of the rachis (*R*) and the peduncle (*P*) of *Renilla*, showing the orifice (*O*) into the superior canal (*S*), which, near the distal end of the peduncle, connects through the transverse septum with the inferior canal (*I*). This in turn communicates with the bases of the zooids (*Z*), whose mouths are open to the exterior.

siphonozooid. It was believed by Wilson ('84, p. 725) to be an exhalent orifice, the other siphonozooids serving as means of entrance for the water. If the connection of this orifice with the smaller cavity in the peduncle is dissected out, it is found to be a well-defined tube, extending from the external opening over the superior face of the rachis, where its course is marked by the band of smooth tissue already referred to, to the peduncle, down whose whole length it can be followed as the superior canal of that structure. The inferior canal in *Renilla* can also be shown to extend from the end of the peduncle through the length of that structure and into the inferior portion of the rachis, where it

breaks up into small cavernous spaces that pass over ultimately into the central cavities of the autozooids and thus communicate through the mouths of these individuals with the exterior.

In the rachis and the proximal part of the peduncle the two systems of canals, the superior and the inferior, are completely distinct and fluids injected into one system never find their way naturally into the other. This is not true of the distal part of the peduncle. Here an injection driven distally into one canal flows out freely from the other, showing that the two canals have ready means of communication. The passage from one canal to the other seems to be dependent upon one or more pores in the transverse septum. I found no evidence of a terminal pore connecting the interior of the peduncle of *Renilla* with the outer sea-water as described originally by Müller ('64, p. 354) and more recently for other pennatulids by Musgrave ('09).

From this description of the anatomical relations of the canals and other cavities in the body of *Renilla* and from the observed activities of this pennatulid, it is clear that the peduncle is a highly differentiated structure connected with the inflation of the colony. In *Renilla* the peduncle is not used so generally for burrowing as in many other pennatulids, nor is there reason to suppose that it is especially concerned with locomotion. The fact that a specialized orifice (fig. 1, *O*) on the superior surface of the rachis (*R*) in *Renilla* leads directly into the superior canal (*S*), which near the distal end of the peduncle (*P*) communicates with the inferior canal (*I*) and this in turn opens out through the mouths of the autozooids (*Z*), is sufficient when taken in connection with the peristalsis of the peduncle to suggest that this is the system primarily concerned with the inflation of the colony and consequently with its internal currents. In what direction these currents set through the system, however, has never been accurately determined. Agassiz ('50, p. 209) believed that the water entered and left *Renilla* through the mouths of its autozooids. Müller ('64, p. 354) stated that the water entered through the large central siphonozooid first identified by him. Wilson ('84, p. 725) regarded this opening as the outlet for the system, the water entering through the other siphono-

zoöids; thus a direction the reverse of that implied by Müller was suggested. Possibly the current may take either direction, depending upon circumstances. These are questions, however, that must be tested out on living material. The point to be emphasized here is that, though the autozoöids are extremely independent in their individual activities, they may be unified in a measure in their actions by the single organ for inflation, the rhythmically contracting peduncle, which thus serves the colony as a whole.

Although the autozoöids of *Renilla* exhibit great independence in activity and give evidence of only a slight unifying principle that is almost purely mechanical, there is another feature in the activities of this pennatulid that exhibits for the colony a much more fundamental form of unity. This is its phosphorescence. This peculiarity of *Renilla* was long ago observed by Agassiz ('50, p. 209), and in consequence of the brightness of the light produced by this form it has commonly been listed among the highly phosphorescent animals (Mangold, '10-14, p. 250). Its phosphorescence is characteristic of the night. If a living specimen during the day is carried into a dark room and stimulated, it will show no phosphorescence. If it is stimulated at night by being prodded with a blunt implement or by the application of a faradic current, waves of light will be seen to run over the superior surface of its rachis. That the phosphorescence is developed in the dark can be seen by keeping *Renilla* away from the light during daytime. Such an animal, after having been put in the dark, will show no trace of phosphorescence for some time. After an hour or two, depending upon the individual, a few phosphorescent points will appear on stimulation, and in from two to three hours waves of phosphorescence will course over the whole colony at each stimulus much as they do at night. This condition may be maintained so long as the animal is kept in the dark. It is lost in a quarter to half an hour after the animal is returned to the light. In this respect *Renilla* is like the ctenophore *Mnemiopsis*, whose phosphorescence, as shown by Peters ('05), develops in the dark, but is inhibited in the light.

The phosphorescence of *Renilla* is limited to the superior surface of the rachis, and when this surface is scrutinized closely under a hand lens, it is found that the phosphorescence is not a property of the whole surface, but appears only in certain almost microscopic white granulations. These occur around the openings in the common flesh through which the autozooids emerge and particularly on the siphonozooids. When these small white granules are touched with a fine needle-point, they can be seen to shine for a considerable time with a bright blue-green light. This individual activity is easily excited, but it is not the characteristic form of luminous response. If an area on the superior surface of the rachis is vigorously stimulated mechanically or by a faradic current, waves of phosphorescence sweep from this area as a center over the whole of the superior face of the rachis. These waves succeed one another at such a rapid rate that the whole superior surface seems to be covered with a rippling glow emanating from the region of stimulation. After the application of the stimulus the luminous response quickly subsides.

The general luminosity just described may be excited from any point on the superior surface of the rachis. When the edge of the rachis is stimulated, waves semicircular in form emanate in rapid succession from the stimulated spot. When a central position is chosen for stimulation, the waves pass out as ever enlarging circles concentric about the point stimulated. A close scrutiny of each wave shows that it is not due to a general phosphorescence of the whole surface, but is the result of successive glowings of the white granulations already mentioned. It is difficult to understand how these successive activities are induced unless it is assumed that the luminous points are all controlled by a nerve-net whose form of transmission is reflected in the outward moving circles of light. Since individual granules may be made to glow brightly and persistently, it is plain that the light of one granule does not automatically excite the next and so on thus resulting in a wave of luminosity. The whole phenomenon presents much more the appearance of a field of minute luminous organs innervated by a nerve-net of an unpolarized

type and, therefore, capable of transmitting in its own plane from any point as a center radially in all directions. But, however transmission may be explained, the luminous response of *Renilla* belongs to that category of reactions that involves the organization of *Renilla* as a whole and, though the transmission is obviously of a diffuse character, the luminous response is much more indicative of colonial unity than, for instance, the action of the autozooids is.

The relations pointed out in this paper are not without a certain morphological interest. The unit of structure of such a colony as that of *Renilla* is quite obviously the zooid. Each zooid is made up of cells combined into tissue and these into organs. Thus each zooid exhibits a series of graded relations that are also characteristic of any metazoan individual. It has long been recognized that most protozoans are unicellular and hence cannot be said in any proper sense to have tissues or organs, for these are always formed by combinations of cells. It is obvious, however, that the single protozoan cell often has special parts that perform particular functions in precisely the same way that the organs of metazoans do. As these parts cannot be properly designated as organs, they have been termed by some organellae. If it is inappropriate to speak of organs in protozoans because this term should be restricted to the multicellular parts of the metazoan individual, it is also inappropriate to use it in reference to a structure in a metazoan colony, even though it may there perform a special function. Thus while it is quite appropriate to designate the tentacle of a zooid in *Renilla* as an organ, for it is a multicellular functional unit in a single individual, it is not appropriate to speak of the peduncle of *Renilla* as an organ, for this is a structure that serves the whole colony of individuals. Such structures stand above ordinary organs as organs stand above organellae. They might, therefore, be called superorgans. In *Renilla* they are represented not only by the peduncle as a structure concerned with the inflation of the colony as a whole, but by the nerve-net that controls colonial luminosity. Superorgans give a unity to a colony that is often unexpressed in the individuals of which it is composed.

BIBLIOGRAPHY

- AGASSIZ, L. 1850 On the structure of the Halcyonoid Polypi. *Proceed. Amer. Assoc. Adv. Sci.*, vol. 3, pp. 207-213.
- EISEN, G. 1876. Beitrag till Kännedomen om Pennatulidsläktet *Renilla* Lamk. *Kongl. Svenska Vet.-Akad. Handlingar*, ny följd, bd. 30, pp. 1-15, taf. 1-3.
- KÖLLIKER, A. 1872 Anatomisch-systematische Beschreibung der Alcyonarien. *Abhandl. Senckenberg. naturf. Gesell.*, Bd. 8, S. 85-275, Taf. 18-24
- MANGOLD, E. 1910-1914 Die Produktion von Licht. *Winterstein, Handb. vergl. Physiol.*, Bd. 3, Hälfte 2, S. 225-392.
- MÜLLER, F. 1864 Ein Wort über die Gattung *Herklotsia* J. E. Gray. *Arch. Naturgesch.*, Jahrg. 30. Bd. 1, S. 352-358.
- MÜSGRAVE, E. M. 1909 Experimental observations on the organs of circulation and the powers of locomotion in pennatulids. *Quart. Jour. Micr. Sci.*, new ser., vol. 54, pp. 443-481, pls. 26-27.
- PETERS, A. W. 1905 Phosphorescence in ctenophores. *Jour. Exp. Zoöl.*, vol. 2, pp. 103-116.
- VERRILL, A. E. 1866-1869 Revision of the Polypi of the eastern coast of the United States. *Mem. Boston Soc. Nat. Hist.*, vol. 1, pp. 1-45, pl. 1.
- WILSON, E. B. 1884 The development of *Renilla*. *Philos. Trans. Roy. Soc. London*, vol. 174, pp. 723-815, pls. 52-67.

Resumido por la autora, Mary B. Stark.

Un tumor hereditario.

El presente trabajo es un estudio de un tumor ligado con el sexo, el cual aparece tan solo en la mitad de las larvas que han de producir machos, en la mosca de los frutos, *Drosophila*, causando la muerte de dichos machos. Se ocupa de esta materia bajo los siguientes epígrafe : 1). Desarrollo del tumor a expensas de una suspensión de sus células. Estas suspensiones se inyectaron en moscas adultas y en gusanos de la harina (*Tenebrio*), en ambos de los cuales tuvieron lugar crecimientos anormales que eventualmente causaron la muerte de la mosca o del gusano. Los tumores se mantuvieron vivos en una gota pendiente de la solución de Locke y presentaron desarrollo ulterior. 2). El tumor no se debe a un microorganismo. Todos los medios de cultivo de uso corriente en los laboratorios fueron inoculados con suspensión de células del tumor e incubados bajo condiciones aerobias y anaerobias sin que se produjese crecimiento alguno. Las moscas fueron criadas en medios estériles, bajo condiciones de absoluta esterilidad, pero los tumores continuaron desarrollándose lo mismo que antes. 3.) Desarrollo del tumor. El tumor se desarrolla en elementos embrionarios destinados a producir los órganos del adulto durante el estado de ninfa. Su desarrollo se inicia con una excesiva producción de melanina la cual, a su vez, aumenta la proliferación celular. La melanina existe normalmente en las células ganglionares y estas células están en relación con algunos de los rudimentos embrionarios por medio de fibras ganglionadas. 4.) Presencia de metastasis. Las metastasis se presentan normalmente en las larvas con tumores. El trabajo está ilustrado con doce figuras en láminas, que representan diversos estados de desarrollo del tumor en los diversos rudimentos embrionarios.

AN HEREDITARY TUMOR

MARY B. STARK

From The New York Medical College and Hospital for Women

TWELVE FIGURES (THREE PLATES)

A report has already been made of the injection of tumor-cell suspension of *Drosophila* into normal larvae (Jour. of Canc. Res., July, 1918). Although nearly one-half of these larvae survived the operation and were active for at least twelve hours, they eventually died without completing metamorphosis. Death may have been due to the toxic effects of the cell suspension or may have been due to infection. The larvae from which tumors were removed and the larvae into which the cell suspension was injected had been washed repeatedly in sterile water. This would not, however, be sufficient to rid the larvae of all bacteria, and some may have entered the body cavity with the pipette, in which case infection could easily result.

An attempt has been made to transplant the tumor into the adult fly. Sixty flies have been injected with a sterile tumor-cell suspension. A large percentage of these flies survived the operation and lived from twenty-four to thirty-six hours. Only 10 per cent, however, continued to live. The great mortality is again probably due to infection, brought on by contamination. It is almost impossible to produce a clean surface on the fly for inoculation as the least moisture on the body of the fly will entangle the wings and legs and cause the fly to become stuck to the side of the container or to the food. I tried cutting off the wings to prevent this, but these flies did not survive any better than the others. Two of the six flies that continued to live developed a dark spot within the place of inoculation. These flies were fixed, sectioned, and stained. On microscopic examination, the spot in each fly was found to be an abnormal growth. In one fly the growth was found near the surface just

below the place of inoculation and in the other fly it was deep in the thorax, between the muscles, and spreading into one of the muscles. Both growths were deeply pigmented and looked very much like old tumors of the larvae, where the cells have become so crowded with pigment that the cell outlines are entirely lost. Figure 1 shows a section through the center of the tumor. Near the periphery of the growth may be noticed cells that are not so densely pigmented. These cells resemble those of the tumor originally injected and evidently must have developed from the injected tumor cells. That the tumors could be kept alive and could even increase in size in a medium outside the body of the fly larva was ascertained in the spring of 1916, when very young tumors were removed from larvae and placed in a hanging drop of sterile Locke's solution, sealing the coverslip with vaselin. In this condition the tumors were kept alive for several days, during which time a perceptible increase in size was noticed, also a change from a light tumor to a dark mature tumor by the increase in the amount of pigment. If only a portion of the tumor was placed in the hanging drop there was an irregular spreading of the cells as growth continued.

The mortality due to the operation was considerably decreased by repeating the last experiment under absolutely aseptic conditions. The tumors of larvae bred on sterile media in Erlenmeyer flasks, and the flies operated upon were also reared on sterile media. Table 1 gives the results of this experiment.

One hundred and eighty-two flies were operated upon. Of these, seventy-three died from the effect of the ether. The forty flies that died within twenty-four hours were never very active and probably died from the effects of the operation. The remaining sixty-nine flies recovered from the operation and were very active and normal in their behavior until just before death, when they became sluggish and inactive. Of these, twenty-nine died within forty-eight hours, thirteen within three days, six within four days, and twenty after one week. Of the flies that recovered from the effects of the ether, 36.69 per cent died from the operation and 63.30 per cent died from the effects of the tumor suspension.

One fly developed a tumor visible to the naked eye. Several of the flies that died were fixed and prepared for microscopic examination. In two of these were found abnormal tissues.

As a control, sterile Locke's solution was injected into one hundred flies free from bacteria. Of these, thirty died from the

TABLE 1

DATE	NUMBER INOCULATED	NUMBER DEAD FROM ETHER	NUMBER DEAD FROM OPERATION	NUMBER DEAD IN 48 HOURS	NUMBER DEAD IN 3 DAYS	NUMBER DEAD IN 4 DAYS	NUMBER DEAD AFTER 1 WEEK	TOTAL NUMBER DEAD FROM OPERATION	TOTAL NUMBER DEAD FROM TUMOR SUSPENSION	OFFSPRING PRODUCED	NUMBER THAT DID NOT DIE
	December 12, 1917	10	4	4	1				4	1	Yes
January 10, 1918	10	5	4	1				4	1		
January 11, 1918	10	3	3	4				3	4		
February 1, 1918	10	0	4	2	4			4	6		
February 15, 1918	10	4	4	2				4	2		
March 23, 1918	10	2	4	3	1			4	4		
May 15, 1918	10	3	4	1			2	4	3	Yes	
May 16, 1918	15	14					1		1	Yes	
May 17, 1918	8	5				3			3		
May 17, 1918	4	3				1			1		
May 18, 1918	11	4		6			1		7		
May 18, 1918	11	2		5	1		3		9		
May 20, 1918	6	2	2				2	2	2	Yes	
May 20, 1918	10	6	1				3	1	3	Yes	
May 21, 1918	13	5			6		2		8		
May 21, 1918	10	4	4		1		1	4	2		
May 22, 1918	11	2	1	4			4	1	8	Yes	
May 25, 1918	13	5	5			2	1	5	3		
	182	73	40	29	13	6	20	40	68		1

effects of the ether, twenty-eight from the operation, while forty-two recovered and continued to live.

Since the injected tumor cells developed in the adult fly and since tumors could be kept alive in Locke's solution and show growth in the same, there is evidence that the tumor cells when placed in suitable media will grow outside the body of the larva.

It is possible that the death of all the larvae into which the suspension was injected may be partly due to the toxic effects of the tumor cells injected and partly due to the effects of tumors developed from the suspension. The larvae did not live sufficiently long to allow the growth of tumors large enough to be seen with the naked eye, but some development must have taken place. The adult tissues of the fly are more resistant than those of the larvae and are not so much affected by the toxic products of the tumor-cell suspension. The flies continue to live sufficiently long to allow the development of a tumor from the injected tumor cells. Death occurred sooner or later, however, and it is evidently due to the development of a tumor from the injected cell suspension.

MEAL-WORM INOCULATION

Hoping to increase the percentage of tumors developed from tumor-cell suspension, it occurred to me to inject the suspension into larger insects. The meal worm was tried, since it is easily obtained and lives as a larva two years, a period more than long enough for the development of a tumor.

The tumor-cell suspension was prepared as before. The meal worms were washed in alcohol and kept in sterile Petri dishes until the wounds healed. The inoculation was normally made between the seventh and eighth pleurites. Two sets of controls were used: one Locke's solution and the other normal-cell suspension in Locke's solution. Two weeks after the inoculation, I noticed in many of the worms that had received the tumor-cell suspension the appearance of small black spots. These spots were often near the place of inoculation, but were also found in other regions of the body. Some of these worms were killed and the regions with spots were fixed, sectioned, and stained. Microscopic examination revealed the fact that they were abnormal growths. A section through the growth, as in figure 2, shows the center to be made up of a necrotic area surrounded by a new growth of the connective-tissue cells of the meal worm. All the growths examined were similar in structure. It looks as

if there had been an abnormal growth, stimulated probably by the injected substance, in which degeneration has occurred, brought on by the new growth of the meal worm.

At first I did not notice any spots in the controls, but later they appeared in as great numbers in the worms that had received the normal-cell suspension as in those receiving the tumor-cell suspension.

Table 2 gives the number of meal worms injected with tumor-cell suspension, normal-cell suspension, and Locke's solution respectively, and the number of new growths developed. Since these abnormal growths occurred in the controls as well as in the worms receiving the tumor-cell suspension, it is evident that they are not all due to the injected tumor cells, but rather to an infection. The growths resemble very much the tubercles described by Adami. I tested the suspension for sterility after this and isolated many of the ordinary bacteria. Of these I injected fifteen-hour broth cultures of *Staphylococcus* and also *B. subtilis* into meal worms. The worms receiving the *Staphylococci* died within twenty-four hours. Those receiving *B. subtilis* continued to live and eventually developed growths like those already described. Since this inoculation was done under absolutely aseptic conditions—the broth having been sterile to all organisms excepting *B. subtilis*, the pipette sterile, and the place of inoculation on the worm kept moist with 85 per cent alcohol for ten minutes—it is evident that the growth is due to an infection brought on by *B. subtilis*.

I have repeated the experiment of injecting tumor-cell suspension into meal worms under absolutely aseptic conditions, that is, sterilizing the fly larvae in 85 per cent alcohol, leaving them in ten minutes, washing the meal worms more carefully, and sterilizing the Locke's solution after each time used. The suspension was tested each time for sterility, and if found not sterile, the worms having received the injection were discarded. Results are shown in table 3. No tumors developed in the meal worms receiving the Locke's solution and normal-cell suspension. Of those that received the tumor-cell suspension, two developed tumors and died. Seven other worms that died

TABLE 2

NUMBER INOCULATED	DEAD WITHIN 24 HOURS	NUMBER DEAD WITHIN 48 HOURS	NUMBER DEAD WITHIN 7 DAYS	NUMBER DEAD WITHIN 4 WEEKS	NUMBER WITH SPOTS	NUMBER WITH SPOTS DEAD	NUMBER NORMAL	NUMBER DEAD FROM OPERATION	NUMBER DEAD FROM TUMORS
-------------------	----------------------	-----------------------------	---------------------------	----------------------------	-------------------	------------------------	---------------	----------------------------	-------------------------

a. Locke's solution

3	1		1	1	0			1	2
7	1	1		1	5	1		2	1
6		1			3		2	1	
5	1				3	1	1	1	1
5					2		3		
26	3	2	1	2	13	2	6	5	4

b. Normal cell suspension

10	9			1	1	1		9	1
8	2	3	2	1	1	1		5	3
18	11	3	2	2	2	2		14	4

c. Tumor-cell suspension

4					3	1	1		1
10	1				8		1	1	
10					9	5	1		5
10	2				6	3	2	2	3
10	6	3	1					9	1
5		1	3		1			1	3
6	1				3		2	1	
7					6		1		
10	8		2					8	2
10	7			1			2	7	1
5	1				2		2	1	
87	26	4	6	1	38	9	12	30	16

	PERCENTAGE DEAD FROM OPERATION	PERCENTAGE DEAD FROM TUMORS
(a)	19.22	15.53
(b)	77.77	22.22
(c)	34.48	18.16

TABLE 3

NUMBER INOCULATED	NUMBER DEAD WITHIN 24 HOURS	NUMBER DEAD WITHIN 48 HOURS	NUMBER DEAD WITHIN 7 DAYS	NUMBER DEAD WITHIN 4 WEEKS	NUMBER WITH SPOTS	NUMBER WITH SPOTS DEAD	NUMBER NORMAL	NUMBER DEAD FROM OPERATION	NUMBER DEAD FROM TUMORS
-------------------	-----------------------------	-----------------------------	---------------------------	----------------------------	-------------------	------------------------	---------------	----------------------------	-------------------------

a. Locke's solution

5		3			0		5		
10					0		7	3	
2	1				0		1	1	
10	1		2		0		7	3	
27	2	3	2		0		20	7	

b. Normal-cell solution

3	2				0		1	2	
3	3				0			3	
4		2			0		2	2	
6	3				0		3	3	
16	8	2			0		6	10	

c. Tumor-cell solution

3	2						1	2	
7	1			1			5	1	1
10				2	2	2	6		2
10	3			2			5	3	2
10				4			6		4
40	6			9	2	2	23	6	9

	PERCENTAGE DEAD FROM OPERATION	PERCENTAGE DEAD FROM TUMORS
(a)	25.92	0.
(b)	62.5	0.
(c).....	15	22.5

nearly four weeks after the operation must have died from the effects of the tumor-cell suspension. The tumors, if any had developed, were too small to be seen through the thick exoskeleton of the meal worm. All these worms had been dead too long for microscopical examination, and it cannot be said definitely that tumors had developed in the last seven worms mentioned. The meal worms seem more resistant to the inoculation of the tumor-cell suspension, since 57.5 per cent of the worms inoculated remained normal. It is to be expected that the tumor cells cannot be transplanted successfully into all insects. Erwin F. Smith has had the same experience with his crown galls. Some plants, he found, are too resistant for the development of the gall when cells of the same are transplanted into them. (Johns Hopkins Hospital Bull., Vol. 28, 1917.)

THE TUMOR NOT DUE TO AN INFECTION

Since the tumor of *Drosophila* is hereditary—occurring exactly in one-half of the males in every generation—it does not seem probable that it is due to an infection. However, susceptibility to an infection may be hereditary. In that case the infection is possible only in the presence of the microorganism to which susceptibility is hereditary and the tumor could develop only in the presence of the specific microorganism. To determine whether the tumor is due to an infection or not, I made an attempt to isolate a specific organism. I sterilized larvae with tumors, removed the tumors, exercising all aseptic precautions, and ground them into pieces in some Locke's solution. All the ordinary laboratory media were inoculated with this cell suspension and incubated under both aerobic and anaerobic conditions. Twice I got a growth of *B. subtilis*, otherwise no growth whatever. *B. subtilis* is a saprophyte commonly found in tumors and is probably not the cause of this tumor. Before preparing special media for the specific organisms that might be the cause of the tumor, it occurred to me to cultivate the flies in which the tumor occurs under aseptic conditions. Eggs were picked and sterilized in 85 per cent alcohol for ten minutes. They were then transferred to sterile media in Erlenmeyer

flasks. The culture media which proved most satisfactory was the banana—yeast-agar method, based on the work of several investigators. The formula used was that recommended by Baumberger (*Science*, '17). The media consisted of one cake of yeast dissolved in 50 cc. of water added to one-half dozen mashed bananas, mixing thoroughly and allowing it to ferment for twenty-four hours. This was pressed through a cloth and the resulting liquid heated with 1.5 grams agar-agar per 100 cc. and poured into Erlenmeyer flasks, plugged and sterilized in an Arnold sterilizer three successive days. Thirty sterile eggs were placed in each of four flasks. Larvae with tumors appeared in all the flasks. Larvae from each flask were removed with a sterile platinum loop and placed in plain broth—sugar broth—and allowed to crawl over slant agar. On two of the slant agar and in one dextrose broth I got a pure culture of yeast, but sterile otherwise as regards bacteria. The yeast is necessarily present, since it is the chief food of the larvae. At regular intervals the medium in the Erlenmeyer flasks was tested for its sterility and was in every case found free from bacteria. When the flies emerged from their pupa cases they were passed into other flasks with fresh, sterile media. Some were passed into slant agar tubes and allowed to walk over the agar. These tubes were incubated, but no growth occurred except a pure culture of yeast on one agar slant. From the eggs laid by the sterile flies larvae hatched which developed tumors. These larvae were tested for sterility as before and were found free from bacteria. Since the tumor is developed in larvae bred in absolutely sterile conditions, it is quite evident that it is not due to an infection, taking for granted that an absolutely sterile condition means a condition not only free from the ordinary bacteria of contamination, but also ultramicroscopic organisms.

It is known that in certain diseases the infection is due to the presence of microorganisms within the eggs, the eggs becoming contaminated from the mother before enclosed in the outer shell. To determine whether the egg is the source of infection in the case of this hereditary tumor, hundreds of eggs laid upon sterile media by flies free from bacteria were picked and ground up in

sterile Locke's solution. All the ordinary laboratory media were inoculated by this suspension and incubated under both aerobic and anaerobic conditions. No growth appeared. The sterile egg suspension was also mixed with the sterile media upon which stocks of flies without tumors were reared. The larvae that fed upon this food contaminated with the egg suspension developed normally.

The suspension was also injected into adult flies. The flies that survived the operation continued to live and to produce normally. The egg is evidently not the source of infection.

DEVELOPMENT OF THE TUMOR

Tumors have been found to occur in various regions of the body of the larva. Whether it occurs more often in any particular region has not yet been definitely determined. Sections of larvae show, however, that the tumor occurs in embryonic tissues destined to build up the adult organs during the pupa stage. These tissues are spoken of as imaginal disks and imaginal rudiments.

In the dorsal region of the thoracic segments of the larva there are six groups of embryonic cells or imaginal rudiments in which the tumor may take its origin. Figure 3 shows a tumor developing in the two anterior rudiments. Figure 4 shows the tumor developing in the posterior rudiment. In the early stages of the development of the tumor the cells of the imaginal rudiment begin to deposit pigment. As development goes on, there is a tendency for the pigment cells to be pushed toward the periphery by the rapidly proliferating cells of the rudiment and there become deposited in laminated layers, as shown in figure 3. Figure 4 shows the entire rudiment encapsulated by the pigmented, flattened, peripheral cells and entirely separated from the other rudiments. The laminated layers of flattened cells may again be surrounded by proliferating cells, as shown in figure 4.

The tumor may also develop in the ganglion of the proventriculus. This ganglion consists of a number of large cells very

loosely connected with one another. Granules of brown pigment are normally present in these cells. The ganglion forms a crutch over the anterior portion of the proventriculus, giving off ganglionated nerves to it and the chyle stomach, also on each side to the salivary glands, terminating in ganglionated plexuses in the wall of the gland. A dorsoventral section of the ganglion, (fig. 5), shows an early stage in the development of the tumor. There is an increased number of cells as compared with the number of cells present in the ganglion of normal larvae. There is also an increase in the amount of pigment. Figure 9 shows a later stage in development, where the cells have become compact with pigment.

Very often, when the proventriculus ganglion becomes affected, the cells of the salivary glands become loaded with pigment, as shown in figure 7. Sometimes only one gland becomes affected (as shown in fig. 5, *Jour. Canc. Res.*), where the left gland is entirely permeated by pigment and the entire gland seems hard and, in places, very much shriveled. In the *Jour. Canc. Res.*, July, 1918, figure 2 shows the ends of the two glands affected.

In the anterior end of the salivary glands are the imaginal cells of the adult salivary glands. These cells have also been found affected as have the imaginal cells of the proventriculus and also those of the chyle stomach. The oesophageal ganglion has in two cases been found increased in size and abnormally loaded with pigment, and in these cases the infection has spread to the imaginal cells of the oesophagus.

The tumor found so often in the posterior end of the larva takes its origin in a group of embryonic cells closely associated with the nerve cells of the pericardial plexus, found on the margin of the pericardial septum. The nerve cells are large, bipolar cells with large vesicular nuclei and distinct nuclei. They are loaded with brown granular pigment in the normal larvae. Figure 8 shows the initial stage in the production of pigment in a group of cells underneath the pericardial septum. Figure 6 shows a great increase in the number of cells and a tendency to push the pigment cells toward the periphery. Figure 1 from the report in the *Jour. Canc. Res.*, July, 1918, is a section of a matured tumor developed in this region.

In the spring of 1916 an interesting mutation arose in the form of a pigmented bar on the ventral surface of the last abdominal segment of some of the larvae with tumors, as shown in figure 10. Microscopic examination of a cross-section through the bar revealed the fact that the pigment was deposited in the large hypodermal cells of this segment, as shown in figure 11. The bar was always perfectly shaped, as shown in figure 10, and appeared only in larvae with tumors (fig. 12). An attempt has been made to separate this mutation from the stock, but this attempt has as yet not been successful.

The tumor wherever developed is characterized by the presence of pigment, which increases excessively in amount with the proliferation of the tumor cells. Pigment is normally present in ganglion cells of the fly larva and, since the tumor usually develops in cells closely associated with pigmented ganglion cells, it may be possible that the pigment is derived from the ganglion cells. The excessive production of pigment is probably due to imperfect metabolism. Adami says: "It may well be that the extraordinary deposit of melanin in melanotic tumors, far from being a progressive acquirement, indicates a deficiency in the disintegrative mechanism of the cell, whereby the normal, final stage of colorless chromogen formation or of protein disintegration is not reached." May not the imperfect metabolism which is the cause of the excessive production of pigment also be the chemical stimulant productive of abnormal cell proliferation?

METASTASES

Mention has already been made of the presence of more than one tumor in a larva. As many as fifteen have been observed in some larvae. Most of these tumors were very small, however. The smallest tumors are often found lodged within the dorsal aorta. It may be that cells from the primary tumor have been carried by the blood into the dorsal aorta where they develop into secondary tumors or metastases. In a number of larvae, tumors have been observed in all the regions described above at the same time. In other larvae, the large primary tumor may

be one of these regions and the smaller tumors are merely secondary tumors developed from cells derived from the primary tumor and carried by the blood to another region of the body.

The so-called secondary tumors are made up of cells similar in character to those of the primary tumor. When the primary tumor is large and irregular in shape, portions of it can easily be broken off by pressing and manipulating the tumor in the body cavity and can be pushed through the body cavity, away from the large tumor. Metastases, thus artificially produced, have, after an interval of a day or two, shown increase in size. It is not improbable that the metastases are normally formed by pressure against the tumor as the larva bores through the food and thus breaks away small portions of the tumor which are carried by the blood to other regions of the body for lodgment and further development.

Irregularities in the mitotic figures of rapidly growing tumors have been noted. Investigation of these is being continued and a report on them will be reserved for another paper.

SUMMARY

1. Cell suspension from an hereditary tumor in the fly *Drosophila* was injected into adult flies. Abnormal growths occurred in some of the flies and caused their death.

2. Tumors were kept alive and showed further development in hanging drops of Locke's solution.

3. Tumor-cell suspension was injected into meal worms, but the resistance of some of them was too great to allow the development of many tumors. Only a small percentage died and only two of these had tumors visible to the naked eye.

4. All ordinary laboratory media were inoculated with tumor-cell suspension and incubated under aerobic and anaerobic conditions. No growths occurred.

5. The flies were bred on sterile media under absolutely sterile conditions, but the tumor continued to develop as before and is evidently not due to a microorganism.

6. The tumor develops in embryonic rudiments, destined to develop the adult organs during the pupa stage.

7. Development of tumor is initiated by excessive production of melanin.

8. Melanin occurs normally in ganglion cells, and these cells are related to some of the embryonic rudiments by ganglionated fibres.

9. Metastases occur normally in many of the larvae with tumors.

10. A mutation occurred in certain flies of such a kind that pigment appeared in the hypodermal cells of the ventral surface of the last segment forming a pigmented bar. It occurred only in larvae that had tumors. So far the character has not been separated from the stock with hereditary tumor.

PLATES

PLATE 1

EXPLANATION OF FIGURES

All figures were drawn with the aid of a camera lucida, using a 4 mm. objective and ocular no. 4 with tube length of 165 mm. except figure 9 for which ocular no. 6 was used.

- 1 A section through the center of a tumor developed in a fly after inoculation with tumor-cell suspension.
- 2 A section through the center of a tumor developed in a meal worm after inoculation with tumor-cell suspension.
- 3 A section through the dorsal imaginal rudiments showing tumor developing in the two anterior rudiments.
- 4 Same, with the tumor fully developed in posterior rudiment.

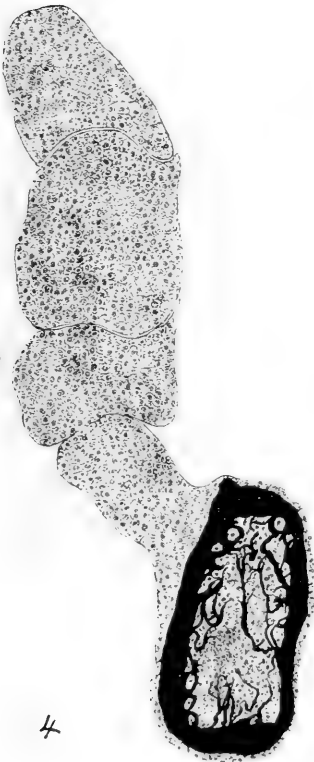
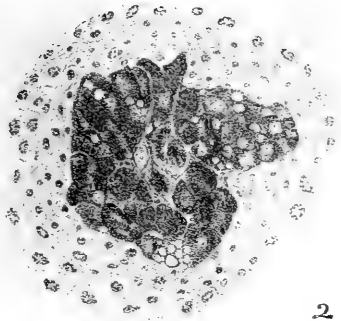
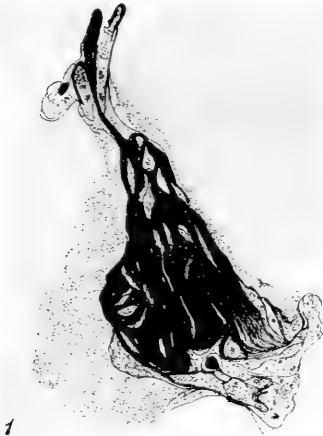

PLATE 2

EXPLANATION OF FIGURES

- 5 An early stage in the development of a tumor in the proventriculus ganglion located between the brain and the proventriculus.
- 6 An early stage in the development of the abdominal tumor showing increase in the number of cells and a tendency to push the pigment cells toward the periphery.
- 7 Cells of the salivary glands loaded with pigment.
- 8 Initial stage in the production of pigment in a group of cells underneath the pericardial septum.

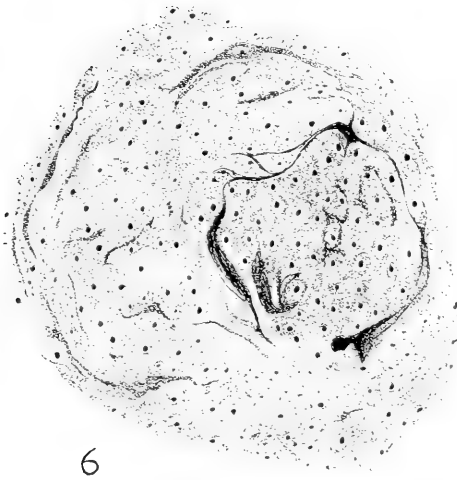
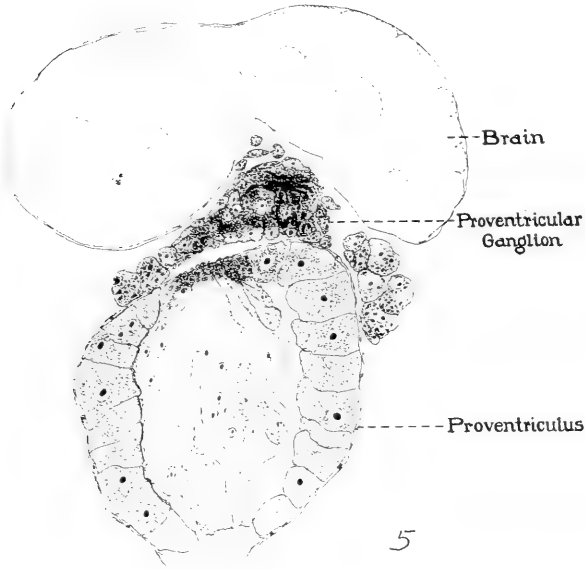
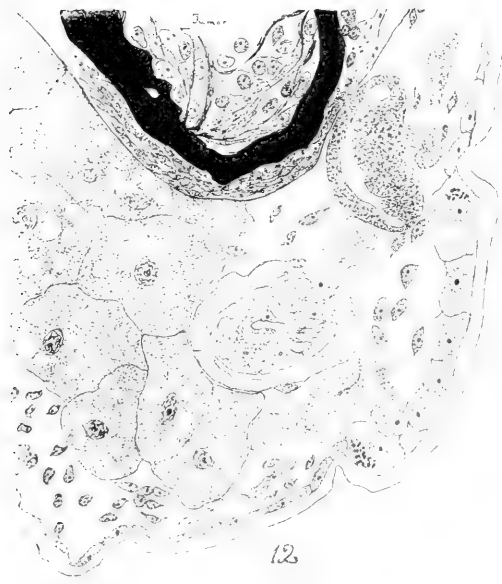
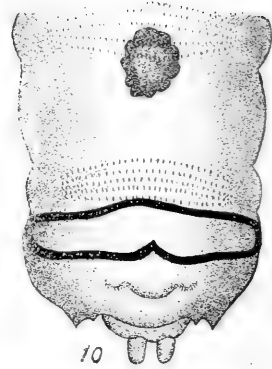

PLATE 3

EXPLANATION OF FIGURES

- 9 A natural tumor in proventriculus ganglion.
- 10 Pigmented bar on the ventral surface of the last abdominal segment of a larva with a tumor.
- 11 Section through same, showing pigment in hypodermal cells.
- 12 Same, showing relation to the other tissues and the tumor.





INDEX

<p>ABBOTT, CHARLES HARLAN. Reactions of land isopods to light..... 193</p> <p>Acclimatization as a factor affecting the upper thermal death points of organisms..... 427</p> <p>Adrenin on the pigment migration in the melanophores of the skin and in the pigment cells of the retina of the frog. The effect of..... 391</p> <p>Anabiosis of the earthworm..... 57</p> <p>Association and color discrimination in mudminnows and sticklebacks..... 443</p> <p>Assortive mating in a nudibranch <i>Chromodoris zebra</i> Heilprin..... 247</p>	<p>Excretory toxins. The reaction of <i>Selachii</i> to injections to various non-toxic solutions and suspensions (including vital dyes), and to..... 101</p>
<p>BIGNEY, ANDREW JOHNSON. The effect of adrenin on the pigment migration in the melanophores of the skin and in the pigment cells of the retina of the frog..... 391</p>	<p>FLUCTUATIONS in a recessive Mendelian character and selection..... 157</p> <p>Foot in some mollusks. On the use of the... 359</p> <p>Frog larvæ. Studies on the relation of iodine to the thyroid. II. Comparison of the thyroid glands of iodine-fed and normal... 417</p> <p>— The effect of adrenin on the pigment migration in the melanophores of the skin and in the pigment cells of the retina of the..... 391</p>
<p>CALKINS, GARY N. <i>Uroleptus mobilis</i>, Engelm. I. History of the nuclei during division and conjugation..... 293</p> <p>Cells of the retina of the frog. The effect of adrenin on the pigment migration in the melanophores of the skin and in the pigment..... 391</p> <p>Character and selection. Fluctuations in a recessive Mendelian..... 157</p> <p><i>Chromodoris zebra</i> Heilprin. Assortive mating in a nudibranch..... 247</p> <p>COLLINS, H. H. Studies of normal moults and of artificially induced regeneration of pelage in <i>Peromyscus</i>..... 73</p> <p>Color discrimination in mudminnows and sticklebacks. Association and..... 443</p> <p>Comparison of the thyroid glands of iodine-fed and normal frog larvæ. Studies on the relation of iodine to the thyroid. II..... 417</p> <p>Conjugation. <i>Uroleptus mobilis</i>, Engelm. I. History of the nuclei during division and..... 293</p> <p>Corneal epithelium. Demonstration of epithelial movement by the use of vital staining, with observations on phagocytosis in the..... 37</p> <p>CROZIER, W. J. Assortive mating in a nudibranch <i>Chromodoris zebra</i> Heilprin..... 247</p> <p>— On the use of the foot in some mollusks..... 359</p>	<p>GLANDS of iodine-fed and normal frog larvæ. Studies on the relation of iodine to the thyroid. II. Comparison of the thyroid..... 417</p> <p>HEREDITARY tumor. An..... 507</p> <p>HOSKINS, E. R., AND HOSKINS, M. M. The reaction of <i>Selachii</i> to injections of various non-toxic solutions and suspensions (including vital dyes), and to excretory toxins..... 101</p> <p>—, M. M., HOSKINS, E. R., AND. The reaction of <i>Selachii</i> to injections of various non-toxic solutions and suspensions (including vital dyes), and to excretory toxins..... 101</p> <p>INBREEDING. III. The effects of inbreeding, with selection, on the sex ratio of the albino rat. Studies on..... 1</p> <p>Injections of various non-toxic solutions and suspensions (including vital dyes), and to excretory toxins. The reaction of <i>Selachii</i> to..... 101</p> <p>Iodine-fed and normal frog larvæ. Studies on the relation of iodine to the thyroid. II. Comparison of the thyroid glands of..... 417</p> <p>— to the thyroid. I. The effects of feeding iodine to normal and thyroidectomized tadpoles. Studies on the relation of..... 397</p> <p>— to the thyroid. II. Comparison of the thyroid glands of iodine-fed and normal frog larvæ. Studies on the relation of..... 417</p> <p>Isopods to light. Reactions of land..... 193</p>
<p>DEATH points of organisms. Acclimatization as a factor affecting the upper thermal..... 427</p> <p>Development in mice. Observations on the relation between suckling and the rate of embryonic..... 49</p> <p>Discrimination in mudminnows and sticklebacks. Association and color..... 443</p> <p>Division and conjugation. <i>Uroleptus mobilis</i>, Engelm. I. History of the nuclei during..... 293</p> <p>(Dyes), and to excretory toxins. The reaction of <i>Selachii</i> to injections of various non-toxic solutions and suspensions (including vital..... 101</p>	<p>JACOBS, M. H. Acclimatization as a factor affecting the upper thermal death points of organisms..... 427</p> <p>KING, HELEN DEAN. Studies on inbreeding, with selection, on the sex ratio of the albino rat..... 1</p> <p>KIRKHAM, WILLIAM B. Observations on the relation between suckling and the rate of embryonic development in mice..... 49</p>
<p>EARTHWORM. Anabiosis of the..... 57</p> <p>Embryonic development in mice. Observations on the relation between suckling and the rate of..... 49</p> <p>Engelm. I. History of the nuclei during division and conjugation. <i>Uroleptus mobilis</i>..... 293</p> <p>Epithelial movement by the use of vital staining, with observations on phagocytosis in the corneal epithelium. Demonstration of..... 37</p>	<p>LARVAE. Studies on the relation of iodine to the thyroid. II. Comparison of the thyroid glands of iodine-fed and normal frog..... 417</p> <p>Light in the colonial forms, <i>Volvox globator</i> and <i>Pandorina morum</i>. Reversion in the sense of orientation to..... 367</p> <p>— Reactions of land isopods to..... 193</p>
<p>MATING in a nudibranch <i>Chromodoris zebra</i> Heilprin. Assortive..... 247</p>	<p>MAST, S. O. Reversion in the sense of orientation to light in the colonial forms, <i>Volvox globator</i> and <i>Pandorina morum</i>..... 367</p> <p>Mating in a nudibranch <i>Chromodoris zebra</i> Heilprin. Assortive..... 247</p>

- MATSUMOTO, SHINICHI. Demonstration of epithelial movement by the use of vital staining, with observations on phagocytosis in the corneal epithelium..... 37
- Melanophores of the skin and in the pigment cells of the retina of the frog. The effect of adrenin on the pigment migration in the..... 391
- Mendelian character and selection. Fluctuations in a recessive..... 157
- Mice. Observations on the relation between suckling and the rate of embryonic development in..... 49
- Migration in the melanophores of the skin and in the pigment cells of the retina of the frog. The effect of adrenin on the pigment..... 391
- Mobilis, Engelm. I. History of the nuclei during division and conjugation. Uroleptus..... 293
- Mollusks. On the use of the foot in some..... 359
- Moult and of artificially induced regeneration of pelage in *Peromyscus*. Studies of normal..... 73
- Mudminnows and sticklebacks. Association and color discrimination in..... 443
- NUCLEI during division and conjugation. Uroleptus mobilis, Engelm. I. History of the..... 293
- Nudibranch Chromodoris zebra Heilprin. Assortive mating in a..... 247
- ORGANISMS. Acclimatization as a factor affecting the upper thermal death points of..... 427
- Organization of Renilla. The..... 499
- Orientation to light in the colonial forms. *Volvox globator* and *Pandorina morum*. Reversion in the sense of..... 367
- PANDORINA morum. Reversion in the sense of orientation to light in the colonial forms, *Volvox globator* and..... 367
- PARKER, G. H. The organization of Renilla. Pelage in *Peromyscus*. Studies of normal moult and of artificially induced regeneration of..... 73
- Peromyscus*. Studies of normal moult and of artificially induced regeneration of pelage in..... 73
- Phagocytosis in the corneal epithelium. Demonstration of epithelial movement by the use of vital staining, with observations on..... 37
- Pigment migration in the melanophores of the skin and in the pigment cells of the retina of the frog. The effect of adrenin on the..... 391
- RAT. Studies on inbreeding. III. The effects of inbreeding, with selection, on the sex ratio of the albino..... 1
- Reaction of Selachii to injections of various non-toxic solutions and suspensions (including vital dyes), and to excretory toxins. The..... 101
- of land isopods to light..... 193
- Regeneration of pelage in *Peromyscus*. Studies of normal moult and of artificially induced..... 73
- Relation of iodine to the thyroid. I. The effects of feeding iodine to normal and thyroidectomized tadpoles. Studies on the..... 397
- II. Comparison of the thyroid glands of iodine-fed and normal frog larvae. Studies on the..... 417
- Renilla. The organization of..... 499
- Retina of the frog. The effect of adrenin on the pigment migration in the melanophores of the skin and in the pigment cells of the..... 391
- Reversion in the sense of orientation to light in the colonial forms, *Volvox globator* and *Pandorina morum*..... 367
- ROBERTS, ELMER. Fluctuations in a recessive Mendelian character and selection... 157
- SCHMIDT, PETER. Anabiosis of the earthworm..... 57
- Selachii to injections of various non-toxic solutions and suspensions (including vital dyes), and to excretory toxins. The reaction of..... 101
- Selection. Fluctuations in a recessive Mendelian character and..... 157
- , on the sex ratio of the albino rat. Studies on inbreeding. III. The effects of inbreeding, with..... 1
- Sex ratio of the albino rat. Studies on inbreeding. III. The effects of inbreeding, with selection, on the..... 1
- Skin and in the pigment cells of the retina of the frog. The effect of adrenin on the pigment migration in the melanophores of the..... 391
- Staining with observations on phagocytosis in the corneal epithelium. Demonstration of epithelial movement by the use of vital..... 37
- STARK, MARY B. An hereditary tumor..... 507
- Sticklebacks. Association and color discrimination in mudminnows and..... 443
- Suckling and the rate of embryonic development in mice. Observations on the relation between..... 49
- SWINGLE, W. W. Studies on the relation of iodine to the thyroid. I. The effects of feeding iodine to normal and thyroidectomized tadpoles..... 397
- Studies on the relation of iodine to the thyroid. II. Comparison of the thyroid glands of iodine-fed and normal frog larvae..... 417
- TADPOLES. Studies on the relation of iodine to the thyroid. I. The effects of feeding iodine to normal and thyroidectomized..... 397
- Thyroid. I. The effects of feeding iodine to normal and thyroidectomized tadpoles. Studies on the relation of iodine to the..... 397
- II. Comparison of the thyroid glands of iodine-fed and normal frog larvae. Studies on the relation of iodine to the..... 417
- Thyroidectomized tadpoles. Studies on the relation of iodine to the thyroid. I. The effects of feeding iodine to normal and..... 397
- Toxins. The reaction of Selachii to injections of various non-toxic solutions and suspensions (including vital dyes), and to excretory..... 101
- Tumor. An hereditary..... 507
- UROLEPTUS mobilis, Engelm. I. History of the nuclei during division and conjugation..... 293
- VITAL dyes), and to excretory toxins. The reaction of Selachii to injections of various non-toxic solutions and suspensions (including..... 101
- staining, with observations on phagocytosis in the corneal epithelium. Demonstration of epithelial movement by the use of..... 37
- Volvox globator* and *Pandorina morum*. Reversion in the sense of orientation to light in the colonial forms..... 367
- WHITE, GERTRUDE MAREAN. Association and color discrimination in mudminnows and sticklebacks..... 443
- ZEBRA Heilprin. Assortive mating in a nudibranch Chromodoris..... 247



1911
1912
1913

1914
1915
1916



QL
1
J68

v.27
cop.2
Biological
& Medical
Serials

The Journal of experimental
zoology

1918-19

PLEASE DO NOT REMOVE
CARDS OR SLIPS FROM THIS POCKET

UNIVERSITY OF TORONTO LIBRARY

