



THE JOURNAL  
OF  
EXPERIMENTAL ZOÖLOGY

EDITED BY

WILLIAM E. CASTLE  
Harvard University

EDWIN G. CONKLIN  
Princeton University

CHARLES B. DAVENPORT  
Carnegie Institution

HERBERT S. JENNINGS  
Johns Hopkins University

FRANK R. LILLIE  
University of Chicago

JACQUES LOEB  
The Rockefeller Institute

EDMUND B. WILSON  
Columbia University

THOMAS H. MORGAN  
Columbia University

GEORGE H. PARKER  
Harvard University

RAYMOND PEARL  
Johns Hopkins University

and

ROSS G. HARRISON, Yale University  
Managing Editor

VOLUME 31  
JULY—NOVEMBER, 1920

THE WISTAR INSTITUTE OF ANATOMY AND BIOLOGY  
PHILADELPHIA, PA.





# CONTENTS

## No. 1. JULY

MATHILDE M. LANGE. On the regeneration and finer structure of the arms of the cephalopods. Thirty-nine figures (eight plates).....	1
W. H. TALIAFERRO. Reactions to light in <i>Planaria maculata</i> , with special reference to the function and structure of the eyes. Eighteen figures..	59
S. R. DETWILER. Experiments on the transplantation of limbs in <i>Amblystoma</i> . The formation of nerve plexuses and the function of the limbs. Twenty-two figures.....	117

## No. 2. AUGUST

M. F. GUYER AND E. A. SMITH. Studies on cytolysins. II. Transmission of induced eye defects. Seven figures and four plates.....	171
GEORGE H. BISHOP. Fertilization in the honey-bee. I. The male sexual organs: their histological structure and physiological functioning. Three text figures and three plates.....	225
GEORGE H. BISHOP. Fertilization in the honey-bee. II. Disposal of the sexual fluids in the organs of the female. Two text figures.....	267
GARY N. CALKINS. <i>Uroleptus mobilis</i> Engelm. III. A study in vitality. One chart and two diagrams.....	287

## No. 3. OCTOBER

C. C. LITTLE. Factors influencing the growth of a transplantable tumor in mice. Two diagrams and one figure.....	307
EDWARD F. ADOLPH. Egg-laying reactions in the pomace fly, <i>Drosophila</i> ...	327
G. H. PARKER. Activities of colonial animals. I. Circulation of water in <i>Renilla</i> . One text figure and one plate (four figures).....	343

## No. 4. NOVEMBER

J. M. D. OLMSTED. The results of cutting the seventh cranial nerve in <i>Amiurus nebulosus</i> (Lesueur). Four plates (twenty-six figures).....	369
GUSTAF FR. GÖTHLIN. Experimental studies on primary inhibition of the ciliary movement in <i>Beroë cucumis</i> .....	403
H. J. MULLER. Further changes in the white-eye series of <i>Drosophila</i> and their bearing on the manner of occurrence of mutation. Three figures.	443
G. H. PARKER. Activities of colonial animals. II. Neuromuscular movements and phosphorescence in <i>Renilla</i> . Twelve text figures and one plate (eight figures).....	475



THE JOURNAL OF EXPERIMENTAL ZOOLOGY, VOL. 31, NO. 1  
JUNE, 1920

Resumen por la autora, Mathilde M. Lange.  
Nueva York.

Sobre la regeneración y fina estructura de los brazos de los cefalópodos.

A. Fina estructura. El brazo consta de una sola capa epitelial, una capa de tejido conjuntivo subcutáneo y tejidos muscular y nervioso. La musculatura está dividida en tres grupos: el fascículo muscular central, que contiene varios grupos de fibras diferentes, la musculatura de las ventosas y los músculos que reúnen a ambos grupos. El sistema nervioso consta de un nervio axial colocado centralmente (a menudo comparado con la médula espinal de los vertebrados), de un grupo de ganglios relacionados con cada ventosa y de cuatro cordones nerviosos intramusculares. El nervio axial está provisto de tejido neuróglia. B. Regeneración. 1) Cambios externos: El nervio axial sobresale del brazo después de la operación. Las ventosas distales se recurvan tendiendo a cerrar la herida, permaneciendo en esta posición anormal hasta que la herida cicatriza completamente. Tan pronto como las ventosas vuelven a adquirir su posición normal el nódulo de regeneración, que es cupuliforme, aparece en la mitad externa del brazo. Este nódulo se desarrolla en una especie de apéndice flageliforme, que lleva pequeños pliegues transversos en el lado interno. Estos pliegues se transforman más tarde en ventosas. Originariamente aparecen en una sola fila, pero más tarde adoptan la posición en doble fila. Los primeros cromatóforos aparecen en la parte regenerada al cabo de unas tres semanas después de la operación. 2) Estudio histológico. La sangre no aparece en la herida inmediatamente después de la operación, sino generalmente varias horas (tres a cinco) más tarde. Forma un tejido de cicatrización que se retiene durante la vida y produce tejido conectivo. Los demás tejidos nuevos se forman a expensas de tejidos preexistentes de la misma clase. En los sarcoblastos se observaron mitosis pero no en los neuroblastos. Es posible que las células neuróglia contribuyan a la formación de nuevas células nerviosas.



# ON THE REGENERATION AND FINER STRUCTURE OF THE ARMS OF THE CEPHALOPODS

MATHILDE M. LANGE

THIRTY-NINE ILLUSTRATIONS

## CONTENTS

Introduction.....	1
Finer structure.....	3
Regeneration.....	5
1. A study of the external changes taking place during regeneration....	5
2. A histological study of regeneration.....	14
<i>a.</i> Wound healing.....	14
<i>b.</i> The muscles.....	22
<i>c.</i> The nervous system.....	26
Summary.....	32
Appendix.....	35

## INTRODUCTION

The ability of the cephalopods to renew lost parts of their arms is a fact which has been revealed to us through the discovery of several specimens whose injured tentacles were in the process of regeneration. Verrill ('82) found such cephalopods off the northeastern coast of North America and Brock ('86) reported the presence of similar ones in the Indian Ocean. Eisig and Riegenbach ('01) observed the formation of a regeneration bud on the tentacle of *Octopus de Filipi* after autotomy, and Hanks ('13) published a paper describing an octopus tentacle which at the upper end had been split into two parts, each part retaining the function of a normal arm. But all these reports lack a detailed description of the process of regeneration, no experimental investigation of this subject having been published up to the present. At the suggestion of Prof. C. Chun, I decided to make a closer study of this phenomenon. I feel indebted to the late Professor Chun for this suggestion. Unfortunately, he died just as I began my investigations. His assistant, Doctor Grimpe, kindly assisted me during the early stages of my work.

I wish to thank him for the interest he took in its progress. I also wish to express my thanks to Professor Hescheler, in whose laboratory I finished this study, and to Dr. Marie Daiber. Their valuable suggestions were of great help to me.

The specimens necessary for the work were gathered at the Zoological Station of Naples and at the Musée Océanographie at Monaco. *Octopus vulgaris*, *Eledone moschata*, and *Sepia officinalis* were the three species chiefly employed. At first I encountered some difficulty in keeping the animals. My experience taught me that non-transparent aquaria were better suited to the purpose than plain glass basins and that the water must flow into the basin slowly, as a strong current is harmful to the well-being of the animals. If the basin is large enough, it is advisable to turn the water off for a couple of hours every day. The food consisted mainly of live crabs. In case the basin is inhabited by more than one animal, it is best not simply to throw in the food, but to feed each animal singly, in order to prevent fighting, as the animals often injure their arms in this way, and such injuries are liable to retard regeneration. Animals whose lens was extirpated were narcotized in a solution which consisted of four parts of 25 per cent alcoholic chloreton, and 96 parts water (sea-water). The animal remained in this solution from three to five minutes. In order to hasten revival after operation, air was pumped into the mantel-cavity and pressed out again. This proved quite a stimulant to respiration. The narcotic poison which is secreted by the gills generally gathers in the funnel. It is advisable to rid the animal of this poison by inserting a probe into the funnel.

The specimens were fixed in the following solutions: Flemming's strong mixture, Hermann's solution, a mixture of formalin, alcohol and acetic acid, and also in a mixture of mercuric chloride, alcohol and acetic acid. Several pieces were fixed in 10 per cent formalin and several in neutral formalin. If enough animals are available, it is advisable to fix an entire animal for each successive stage, but if the scarcity of animals necessitates the use of one and the same animal to produce several stages, it is imperative that regenerated ends be cut off under water. Special

attention must be paid to this, as otherwise air penetrates the tissues. The presence of air in the tissues renders their impregnation with paraffin or other media extremely difficult, and thus the microtome work very unsatisfactory. Combinations of celloidin and paraffin and also of collodium and paraffin proved the most practical substances for embedding. The pieces after being well drained in alcohol (100 per cent) were placed in a mixture of equal parts of alcohol and ether, and remained there for several hours. They were then put into a diluted solution of celloidin or collodium for 24 hours. The pieces impregnated with collodium were then left in oil of origanum for 24 hours, and the celloidin pieces were submitted to the same treatment in cedar oil. Later they were immersed in a mixture of oil of origanum plus 40° paraffin, and cedar oil plus 40° paraffin, respectively, and remained in these mixtures for twenty-four hours. Thereupon they were placed in several baths of paraffin of different degrees, and finally in 58° paraffin, in which they were embedded. The 100 per cent alcohol had hardened the tissues to such a degree that microtoming was exceedingly difficult. It was therefore necessary to employ mastic-collodium. No albuminous glycerin, only distilled water was used for mounting. The slides were further treated in the usual way. Photoxolin was not used; on the contrary, the mastic-collodium was removed by a solution of equal parts of alcohol and ether. The sections were stained on the slide with haemalaun (Mayer) haematoxylin (Heidenhain), eosin, orange G several of the specimens fixed in osmic, were stained saffranin plus emerald green. The best stains were obtained by a combination of haematoxylin (Heidenhain) plus eosin. Some specimens were stained by way of impregnation, according to the method of Bielschowsky and Maresch.

#### THE FINER STRUCTURE OF THE ARM

The anatomy of the arm of the cephalopods has often been made the object of closer study. Cuvier's publication 1817 gives quite a minute description of it. Since then a number of authors have devoted their attention to the same subject. Colo-

santi ('76) was the first to make the tentacle of the octopus the subject of a microscopical examination. The best paper published on this subject up to the present was written by Guérin ('08).

The arm of the cephalopod consists of four distinct parts: first, the skin or integument; second, the muscles; third, the nervous system, and, fourth, the vascular system.

The skin is composed of two layers, the epidermis and the dermis. The epidermis consists of a single sheet and is covered by striated cuticle. The nuclei of its cells are quite large and contain granules. The unicellular glands are more or less pear-shaped in comparison with the ordinary epithelial cells, their plasma contains fewer granules and they are much smaller. The dermis of the octopus arm consists of connective tissue, which surrounds the chief muscle bundle in equal thickness on all sides. It is permeated by many blood-vessels, by muscular and nerve strands, and also contains chromatophores and luminous organs.

The muscles of the arm can be divided into three distinct groups, viz., the central muscle bundle, the muscles of the suckers, and the muscles which serve as a connection between these two groups. The central muscle bundle consists of six longitudinal muscle strands, one transverse set of fibers, and six oblique or diagonal muscle strands. The musculature of the suckers consists principally of radiating fibers interspersed with circular muscles, the latter being more numerous in the musculature of the adhesive part than among the muscles of the sucking cavity. At the juncture of the adhesive part and the wall of the sucking cavity the circular muscles are especially well developed, forming a so-called sphincter. The connecting muscles connect the suckers with the central muscle bundle and also with the dermis (fig. 1).

Ballowotz ('93) made a closer study of the finer structure of the muscle fiber and found that it forms a narrow cylinder tapering at each end. This cylinder consists of spiral fibers and a granulated protoplasmic substance, which probably serves as a connection between the fibers and holds them together.



The nervous system of the arm is quite complicated, and is composed of three distinct parts, viz., the central or axial nerve, the group of ganglion cells situated above each sucker, and the intramuscular nerves. The complex structure of the axial nerve has given rise to much scientific discussion. Van Beneden ('90), Cheron ('66), Owsjannikow ('95), and Kowalewsky claims that the axial nerve is a part of the peripheral nervous system, whereas Colosanti ('76), Uexkull ('93), and Guerin ('08) maintain that its qualities in structure, as well as in function, are such that it would easily be compared to a central nervous system. The three components of this complex axial nerve are: 1) a layer of ganglion cells; 2) a centrally located mass of nerve fibers, and, 3) two myelin cords running along the back of the arm. The ganglion cells are surrounded and supported by glia tissue. This tissue also forms a sheath around the processes of the ganglion cells and is present in the mass of centrally located nerve fibers (fig. 3).

Each arm is provided with one main artery embedded in the connective tissue, which lies between the two myelin cords. Two large veins (*venae brachiales superficiales*) running along the external side of the arm in the dermal layer, form the two main components of the brachial venous system. Little veins from the inner side of the arm convey the blood from the vicinity of the suckers to the two large afferent vessels. The blood of the Cephalopoda is a thin liquid containing only one kind of blood-corpuscles. The latter have some similarity to the leucocytes of the vertebrates. Kollman ('08) gave a detailed description of them (fig. 4). The blood has no fibrinogen.

#### REGENERATION

##### *1. A study of the external changes taking place during regeneration*

In the introduction attention has been called to the fact that the regenerative power of the octopus arm has been revealed by the discovery of many animals having regenerated arms. The authors who have reported on such specimens have also been mentioned. The embryonic development of the arm has

up to the present not been made a subject of special study. There are several papers on the development of the Cephalopoda (Kolliker ('44), Grenacher ('74), Bobretzky ('77), Ussow ('74, '81), Viallton ('88)), but most of them treat only of the earlier stages or of the development of some particular organ, and none of them enter into a detailed account of the normal growth and development of the arm. Guérin has given a short sketch of the histological differentiation of the arm musculature, but does not mention the morphological changes which take place during the process of normal growth. A thorough and detailed report on the development of the arm has not yet been published. A. Naef's monograph on the development of the Cephalopoda (now being printed) will surely contain a detailed report on this subject.

The histological structure of the arm is the same at the base as at the distal end (with the exception of the tip, where the tissue is in an undifferentiated embryonic stage). I therefore did not pay great attention to the level of the cut or to the amount of the arm I severed from the proximal end. In the course of my experiments, however, it became apparent that the regeneration of arms cut off near the base required more time (in some cases two to three weeks passed before even the slightest sign of regeneration proper became visible).<sup>1</sup> As my stay at the Zoological station at Naples was limited, I generally amputated only about one-third of the arm (rarely half of it), as I wished to have quite a number of specimens which were already in an advanced stage of regeneration. In cutting off the distal portion, care was taken that the section plane was as vertical as possible to the longitudinal axis of the arm. I was often surprised that no visible traces of blood could be found on the wound immediately after operation. In order to be quite certain on this point, I carefully dried the tentacle with a towel before cutting and then

<sup>1</sup> At the tip the tissues of the arm are still in an embryonic stage. Distal parts of the tip probably regenerate more quickly because they do not require so much time to transform their tissue into an embryonic blastema. The proximal parts probably require more time for this process, as their tissues are more differentiated.

placed a piece of filter-paper on the wound immediately after the operation had been performed. I could not detect any moisture on the paper. This retention of the blood after amputation is in all probability associated with the ability of the arm to cast off distal portions by means of autotomy. According to Eisig and Riggenbach, *Octopus de Filipi* frequently casts off the greater portion of several tentacles in this manner. Riggenbach also mentions the ability of the octopodes to free their distally held arms by simply casting off the held portion. I also observed similar cases of autotomy of the arm of *Octopus vulgaris*, but I believe that the ability to autotomize is confined to the distal portion. I was not able to find any portion of the arm which was modified or in any way arranged for autotomy. Neither do any of the numerous publications treating of the structure of the arm mention the presence of any mechanism especially adapted to autotomy. (It is a well-known fact that many arthropods are provided with such mechanisms.) Generally four-fifths of the arm is cast off. But this is not always the case, and the distance between the base of the tentacle and the point of rupture is by no means always the same. Riggenbach mentions some cases where this distance averages about 2 cm., sometimes more, sometimes less.

Immediately after operation the external rim of the wound contracts spasmodically; this contraction is especially noticeable in the dermis. The external parts of the wound are thus covered, but the central musculature and the axial nerve remain unprotected. The axial nerve even protrudes beyond the surrounding tissues. Figure 5 shows a wound about one and a half hours after operation. The protrusion of the axial nerve is quite obvious. With the help of a magnifying glass I was able to see the myelin cords, the central nerve-fiber mass, and even the main artery quite plainly. This fact shows that this part of the wound was still without any covering whatever. Figure 6, showing a later stage (about ten hours after operation), presents quite a different picture. The dermis has contracted more closely over the wound, but has not succeeded in covering it completely. The axial nerve no longer extends beyond the

surrounding tissues and its components are no longer visible, not even with the help of a magnifying glass. The hitherto unprotected portion of the wound has been covered by a substance, the nature of which could only be ascertained by means of a histological examination. This examination disclosed the fact that this covering consisted of blood. I am not able to state the exact amount of time which expires between the operation and the bleeding. However, I was able to detect blood only on such pieces which had been fixed five or six hours or more after operation. Pieces which had been preserved previous to that time showed no traces of blood. Here is a case where the section of blood-vessels is not immediately followed by bleeding, but where the bleeding takes place a considerable time after operation.

This, I think, is a fact which deserves notice. At first I thought that the blood which might have covered the wound at an earlier stage could have been washed away or that the animal bled from four to five hours before the bleeding stopped. But both these cases seem rather improbable. In the first place, I could not detect any moisture on the filter-paper which I placed on the open wound directly after operation; secondly, the conditions in which the Octopoda live would be very harmful to them if they were subject to prolonged bleedings from wounds in the arm. Brock believes that to a certain degree some relation between the oecology of the animal and the relatively great regenerative power of the arm exists. He wrote as follows:

Ohne die sehr nützliche Eigenschaft, die Arme schnell und vollständig zu regenerieren, würden die Cephalopoden wohl schwerlich die Konkurrenz mit anderen Mitbewohnern auf dem Riff aufnehmen können, trotz der unvergleichlich reichen Jagdgründe, welche es ihnen bietet. Es ist nicht schwer zu begreifen, dass Wohnorte von der Natur eines Korallenriffes den Armen eines Cephalopoden geradezu verhängnisvoll werden müssen. So kann es nicht überraschen, bei den Octopoden der Korallenriffe so häufig verstümmelten oder in verschiedenen Stadien der Regeneration begriffenen Armen zu begegnen. Von langarmigen Arten ist es überhaupt nicht möglich gewesen, ein Exemplar mit unverletztem Arm zu erhalten.



Among the animals which were delivered to me for experimental purposes at Naples and Monaco, I also found a great many whose arms had been injured before capture, and quite a number of them showed advanced stages of regeneration. This shows plainly that the loss of an arm is by no means a rare or a dangerous occurrence. If, however, an animal, which is subject to frequent injuries on a certain part of its body, would each time bleed from five to six hours, the loss of blood would in the end probably prove fatal. The fact that the animals easily survive frequent injuries of their arms indicates the improbability of such prolonged bleedings.

It is difficult to explain the tardy appearance of blood on the wound. The only explanation I can give is the following: The minute the arm is cut off or cast off by autotomy the blood-vessels contract at the wound, later the muscles of the blood-vessels relax and allow blood to flow. The blood-corpuscles soon form a clot (agglutinate), and this clot serves as a preliminary covering for the wound.

Figure 7 which in comparison to figure 6 presents quite a different picture, exhibits a completely covered or closed wound. The time in which complete healing of a wound is achieved varies greatly. Some wounds were healed within less than twenty-four hours after operation, others showed no healing after thirty hours and were at that time only covered with a blood clot. The differences in the time necessary for the complete healing of the wound are probably caused by various factors. Generally a wound in the distal portion of the arm healed more quickly than one located in the middle or at the base. It is quite likely that the age of the animal also plays a part, for the wound healed more rapidly in a younger animal than in an older one. The season of the year may also have some influence on the progress of wound healing. In Naples, where I experimented in the spring, I found that the wound healing took less time than in Monaco, where I carried on my experiments in the fall of the year.

Figure 7 shows a perfectly smoothly healed arm stump. This smooth appearance is probably due to the wound's having been

completely covered by epithelium. That the wound was actually covered by epithelium was proved by a microscopic examination of sections made of the piece in question. Another fact worth noting in this picture is the position of the two suckers at the obtuse end of the arm. These two suckers are somewhat drawn up as if they were also helping close the wound. This abnormal position of the suckers, which I observed as a regular occurrence during the process of wound healing, pushes the section plane out of its original position (vertical to the brachial axis) toward the exterior side of the arm. The suckers continued in this abnormal position for some time—in most cases from two to three days, in some cases ten days, and some even more. The same factors which cause the difference in time necessary for wound healing probably also play a part here: viz., location of the wound (distal or proximal), age of the animal, and season of the year. During my stay at Naples an octopus which measured a total length of  $1\frac{1}{2}$  meters was placed in one of the basins of the aquarium. Before its capture the animal had lost the greater portion (about three-fourths) of one of its arms, thus placing the wound in the proximal portion of the arm. The wound was completely healed and the two distal suckers were drawn up at the end in the abnormal position mentioned above. It required a period of three weeks before these suckers were again in their normal position.

As soon as the two last distal suckers regain their normal position, the first sign of a beginning regeneration becomes visible in the shape of a little knob, lying near the external side of the arm (fig. 8). Figure 9 shows a more advanced stage, the knob has already developed into a small process. On the interior side of this process a little groove becomes noticeable. This groove is plainly seen in figure 10. The same picture also shows the formation of little transverse folds within the groove. These folds later develop into suckers. In the further course of regeneration the folds take a form similar to little warts (figs. 11 and 12). The cavity of the sucker and the adhesive part are formed later by means of invagination. The beginning of this process can already be noticed in the most proximal of the suckers shown

in figure 11. All suckers are at first formed in the shape of little transverse folds arranged in single file. Later they are rounded off to little papillae. This process of rounding off seems to start in the center and progress sideward, so that the papillae are in quite a different position from the original folds. The latter were quite centrally located, whereas the papillae or warts have a lateral position. As the folds are rounded off alternately, once to the right and once to the left, the double row of suckers characteristic of the arm of *Octopus vulgaris* is thus gradually formed. But the above is only true of the suckers, which originate in the regenerated process. Attention has already been drawn to the fact that the regenerated process is attached to the external half of the arm. The process is considerably thinner than the stump of the arm, and in comparison to it looks like a thin lash-like appendage. Therefore, a considerable portion of the obtuse end of the stump remains free. On this free end the first regenerated suckers are formed in the shape of little transverse folds, but their further development differs somewhat from the development of the suckers located in the regenerated process. While the final double-rowed arrangement of the latter is already visible at an early stage of their development, the suckers of the free end remain arranged in single file till they are a great deal further advanced, and some of them even remain so permanently. The above is very well illustrated in figures 13 and 14. The four proximal suckers are arranged in single file and already show the invagination, which eventually leads to the formation of the sucking cavity and the adhesive part. Above these four suckers are ten to eleven newly formed suckers belonging to the regenerated process. These still show the form of papillae and are not nearly as well developed as the lower four, but their position already indicates their final arrangement in two rows. Above these papillae we can detect two to three small transverse folds arranged in single file. The latter are suckers at a very early stage of development.

How does the regeneration of the arm compare with its normal development? The arm of the octopus embryo can be divided into two parts—a rather thick proximal part, provided with

three well-developed suckers (arranged in single file), and a distal part which compared to the proximal part is exceedingly thin. Naef has called this lash-like appendage a flagellum. The three suckers are arranged in single file and remain so permanently. In a more advanced stage the arm is provided with a larger number of suckers, of which the first three still are in single file, while the others are arranged in zig-zag fashion. Here we have an arrangement similar to that in figures 13 and 14. So we may safely say that the arrangement of the first newly formed suckers in the course of regeneration does not differ greatly from the arrangement of the first suckers in the course of normal development. In regenerated parts, however, only one sucker remains permanently without a partner. In some cases I have found from two to three suckers arranged in this manner. The single sucker at the base of the regenerated part was to be found in even such advanced stages of regeneration where it was difficult to distinguish between the old stump and the newly formed part. Brock believes that this single sucker only appears after the lost part has been completely regenerated. On page 592 he speaks of it as follows:

Ist die Einschnürung (an der Amputationsstelle) bereits bis auf die Furche verschwunden, und geht der regenerierte Arm schon ganz unmerklich in den Stumpf über, so verrät sich der Vorgang der Regeneration noch lange durch eine mehr oder minder breite Lücke in der Reihe der Saugnäpfe gerade an der Amputationsstelle, welche erst ganz zuletzt von einem an dieser Stelle hervorsprossenden Saugnäpf ausgefüllt wird.

Brock arrived at these conclusions through the study of several regenerated arms which he found on animals caught in the Indian Ocean. He never tried to prove his assertions by experiment. I should like to draw attention to the fact that never in the course of my investigations (and I had quite a quantity of material at my disposal) was I able to detect an interval in the row of suckers such as Brock both illustrates and describes. The sucker which Brock believes to be the last is probably identical with the single sucker at the base of the regenerated part (figs. 15 and 16). This sucker, however, is by no means the last, but

on the contrary the very first sucker to be formed in the course of regeneration. Three or four weeks after operation, the first chromatophores appear in the regenerated part. They are lighter in color than the chromatophores of the arm stump. Figures 15 and 16 show regenerated pieces in an advanced stage of development. The only differences between the stump and the regenerated part consist in the different thickness and the different coloring of the chromatophores.

The arm of *Eledone* regenerates in the same way as the arm of *Octopus vulgaris*, with the exception that the suckers remain arranged in single file; this being their normal and permanent position.

I did not study the regeneration of the arm of the Decapoda very closely. I was able to observe the complete healing of the wound and the formation of a dome-shaped regeneration knob,<sup>2</sup> but not able to follow up the development of the suckers, as the animals generally died before they reached this stage. Brock claims that the arms of the decapodes lack all ability to regenerate. As the arms of the decapodes are considerably shorter than the octopus arms, they are not subject to such frequent injuries. Nevertheless, the Decapoda are able to replace a lost arm; only the manner in which they do so differs from the way in which the octopus repairs the same damage. Doctor Naef showed me a *sepia* (at Naples) which had lost almost a whole arm. The animal had already begun to replace the lost part, but not by means of regeneration from the old stump, but by developing that rudimentary buccal arm<sup>3</sup> which was correlated to the lost arm. This arm developed from a rudiment had the same structure as a normal arm and differed from the latter only

<sup>2</sup> The regeneration knob of the *sepia* arm is centrally located, whereas the knob of the *Octopus vulgaris* is nearer the exterior side. No lash-like appendage or thin process is developed. The difference in thickness between the stump and the regenerated part is not so great. Perhaps the different arrangement and location of the myelin cords is the cause of this.

<sup>3</sup> The buccal funnel of the decapods is a set of rudimentary arms and corresponds to the inner circle of arms of the Nautilidae. The buccal funnel of the decapods possesses seven to ten rudimentary arms, which, according to Naef, are provided with two rows of suckers.

in length (it was shorter) and in its position nearer to the buccal funnel. In the further course of development this arm would probably have replaced the lost one. This case would indicate that sepia does not always renew the lost part of its arms by direct regeneration, but in some cases resorts to compensatory regulation to replace the lost organ.

## 2. *A histological study of regeneration*

The course of regeneration which takes place after injury can easily be divided into three distinct stages, viz., the healing of the wound, the degeneration of the tissues, and the renewal of the same. However, I wish to draw attention to the fact that these histological processes need not necessarily follow each other in the same order as here mentioned.

*a. Wound healing.* It is not possible to detect many changes in the wound shortly after operation. The only obvious alteration consists in a contraction of the edges of the wound, by which they form a kind of raised rim around the same. The greater part of the wound with the exception of the axial nerve is in some degree protected by this rim. The histological examination showed that the raised rim was formed by the connective tissue of the dermis, in its endeavor to contract over the wound. However, only the externally located muscles are covered by the connective tissue, while the center of the arm, comprising the axial nerve with its surrounding connective tissue layer and the inner muscles, remain unprotected. Figure 17, which shows a longitudinal section through the center of an arm one and one-half hours after operation, illustrates these conditions. Only the external portions of the wound are covered, and the axial nerve even protrudes beyond the surrounding tissues. The only alteration visible in the tissues immediately adjacent to the wound is a slight disintegration in the inner transverse muscle in the central mass of nerve fibers (neuropil) and in the ganglion layer. This subject will be considered below (pp. 22 and 27). The main brachial artery is closed. It is hard to tell whether this is a natural condition or one produced by fixing. The artery

contains some blood in its most distal portion, most of which consists chiefly of blood-corpuscles without plasma. Cuénot claims that such blood-corpuscles are degenerated. All the blood-vessels leading toward the wound contain very little blood, nor is there any trace of blood on the wound itself. I believe that up to the time at which this piece had been fixed, no bleeding had yet taken place. The reasons which led me to have this opinion have been discussed in the previous chapter (p. 8). Young stages of regeneration (such as are shown in fig. 17) are always open, no covering or closing of the wound having yet taken place.

Techow ('10) found that the wounds of the gastropods were provisionally closed by a clot which was formed by the contents of the blood-vessels. I found that the wounds of the Cephalopoda were closed in the same manner. About five or six hours after operation all blood-vessels leading to the wound are filled with blood, which after leaving the vessels spreads over the wound, thus forming a protective covering for the same. Attention has already been drawn to the fact that the blood of the Cephalopoda contains no fibrinogen (p. 5), therefore the clot which preliminarily closes the wound cannot be formed through blood coagulation, as is the case in wounds of vertebrates and arthropods. The wound can only be closed by the agglutination of the blood-corpuscles, and a histological study of the sections proved this to be the case. In agglutinating the blood-corpuscles form a kind of network (figs. 19, 20, and 21). In many other invertebrate animals the wounds are also closed by means of blood- or lymph-corpuscles. Techow ('10), Hanko ('13),<sup>4</sup> Cucagna ('15), and Nusbaum ('15) found it so for the Mollusca. Hescheler ('98), Nusbaum, and Friedländer ('95) claim that wounds of worms are closed in the same manner. Ost ('06), Friedrich ('06), and Reed ('05), who have studied the regeneration in Arthropoda, found that the wounds of these

<sup>4</sup> Hanko studied the regeneration of *Nassa mutabilis* and speaks of blood coagulation as a means of closing the wound. This is probably an erroneous statement, for, according to Kollman, the blood of the gastropodes contains no fibrinogen, therefore coagulation is not possible.

animals are also closed by the agglutination of the leucocytes, but the agglutination is accompanied by blood coagulation, as the blood of the Arthropoda contains fibrinogen. The leucocytes of the Cephalopoda do not undergo any great change during agglutination. I could not observe any formation of pseudopods such as Loeb ('09) and Geddes ('01) describe. The only alteration which I could discover in the blood-corpuseles was hyalinosis resulting from the disappearance of a great number of granules. The change wrought by hyalinosis can be plainly seen in comparing figures 4 and 19. The blood-plasm seems to disappear soon after the bleeding stops, for I could not find any trace of it on most of the sections. Were it not for a few cases such as one exhibited in figures 19 and 22, where blood plasm is still present, one could easily suspect that the plasm flows away immediately after leaving the blood-vessels. If we examine the plasm in the blood-clot closely, we can detect a difference between it and the plasm in the blood-vessels. In the first place, the plasm of the clot is not as uniform in structure as the plasm in the blood-vessels, and, secondly, it does not stain the same intense brown-red, when the combined stain of Heidenhain and eosin is employed. But in spite of these differences, it still retains the character of blood-plasm. In some sections made of pieces which had been fixed after a period of five hours after operation, I even found the plasm of the blood-clot almost identically the same in appearance as the plasm in the blood-vessels. Gradually the blood-plasm entirely disappears from the cicatricial tissue. As no signs of degeneration were visible, the plasm probably becomes absorbed, but unfortunately, I was not able to find out how this is done. After the disappearance of the blood-plasm the cicatricial tissue looks like a very close network of thin threads, in which numerous nuclei are embedded (figs. 20 and 21). The fact that these nuclei increase in numbers would indicate that they multiply. Migration of nuclei from the subjacent tissue is not likely, for the cicatricial tissue is separated from all tissues, with the exception of the musculature, by a very distinct boundary line. The muscles, however, being in a state of degeneration, which begins before



the formation of the blood-clot, cannot possibly contribute cells for the tissues covering the wound. The increase in the number of nuclei must be the result of nuclear division. In spite of careful search, I was not able to find any mitosis. The nuclei probably multiply by means of direct or amitotic division.

The cicatricial tissue which is formed by the agglutinated blood-corpuses is never cast off, but retained. The same may be said of the cicatricial tissue of the Pulmonata, Nudibranchia, and Prosobranchia. Several authors have been able to establish the same facts for worms. The wounds of the Vertebrata and the Arthropoda (with some exceptions), however, heal under a scab of coagulated blood. The scab soon degenerates and is cast off as soon as the healing has been accomplished.

In time the leucocytes, which constitute the cicatricial tissue, become more and more hyalin. The granules, which were at first equally distributed in the protoplasm, gather around the nucleus and along the cell wall and finally disappear. The cells change their shape—formerly round, they now become elongated. At the same time the nucleus also becomes elongated. At times this alteration begins in the most superficial layers of the cicatricial tissue, but the study of a greater number of sections showed that generally the most exterior cells retained their round shape longer than those below the surface, the latter becoming elongated very soon (figs. 20 and 21). These changes take place in the cicatricial tissue before it is covered by epithelium. Hescheler, Friedländer, and Rievel found similar elongated spindle-shaped cells in the cicatricial tissue of worms. Friedländer and Rievel claim that these cells are evolved from leucocytes, whereas Hescheler doubts it. What finally becomes of this cicatricial tissue? There are two points worth notice in connection with it. In the first place, I was never able to find any sign of degeneration in this tissue, and, secondly, the regenerating epithelium does not grow under or through it, but covers it. Both these facts show plainly that it is retained and not cast off. It therefore may be called a blastema, and in order to distinguish it from the second blastema, which appears later and consists of neuro- and sarco-blasts (fig. 31), I would designate

it as primary blastema. As this blastema does not degenerate, it is used to supply the material for some regenerating tissue. It is not likely that the primary blastema contributes any material for the construction of the nerves or muscles, for the nuclei of the primary and second blastema differ greatly in structure. The nuclei of the former are generally elongated and provided with several nucleoli, the nuclei of the latter are larger in size, round in shape, only have one nucleolus, and show a greater affinity for staining agents. All these differences indicate that it is quite impossible for the nerves or muscles to draw any material for their regeneration from the primary blastema. However, it is very likely that the primary blastema contributes a great part of its material to the construction of the new connective tissue, especially the dermal layer. There are two facts which further strengthen this theory. First, the similarity of the nuclear structure and, secondly, the fact that the primary blastema is dislocated by the second blastema's being pushed sideward, so that it gradually occupies the place of the dermal connective tissue. Most of the papers dealing with the subject of regeneration do not definitely state what ultimately becomes of the cicatricial tissue. This applies to the three papers heretofore written on the regeneration in Mollusca. Nusbaum and Cucagna ('15) mention the presence of connective-tissue cells in the cicatricial tissue before the same is covered with epithelium, but they do not mention the origin of these cells. Even though the literature treating of regeneration in worms is very voluminous, I was not able to find very much information on the further utilization of the cicatricial tissue. Many authors never even mention its presence. Others explain its formation, but do not say what becomes of it later. Friedländer intimates that muscle fibers might arise from the cicatricial tissue, but does not state this as an actual fact. Rievel, who believes that the cicatricial tissue (he calls it granulation tissue) has its origin in the mesoderm, claims that later it becomes mesenchymatous and finally forms the unstriated muscles. According to Hescheler, the cicatricial tissue becomes fibrous (in the course of regeneration) and arranged in layers which run parallel to the front external

contours of the body, occupying a place which would naturally be filled by the continuation of the longitudinal muscles.

As the cicatricial tissue of the animals whose blood contains fibrinogen soon becomes scabby and is cast off, it is quite natural that most of the publications on the regeneration in vertebrates and arthropods do not give any great attention to the cicatricial tissue. This applies almost without exception to all the reports on the regeneration in arthropods. Among the many authors who have studied the regeneration of vertebrates there are a few who point out that not all of the cicatricial tissue is merely a preliminary covering for the wound, but that some of it at least is utilized for some future purpose. Aufrecht ('90), Billroth, and Rindfleisch claim that the leucocytes enclosed in this tissue are the origin of connective-tissue fibers. Among the more recent reports on this subject I should like to draw attention to a paper published by Baitzell ('16). This paper treats of the processes connected with the healing of skin wounds in frogs. Baitzell points out that the blood-clot formed by the coagulation of the blood acts as a kind of connective tissue for the time being by holding the edges of the wound together. He found that the coagulated blood formed a typical fibrin net. Later on this net was changed into a fibrous tissue, consisting of separate fibers and fiber bundles. This alteration was affected in a few days' time. This change could not be traced to the activity of any other cells, as it took place before any connective-tissue cells had migrated into the blood-clot. The new tissue had the appearance of regenerating connective tissue. It soon exhibited the same reactions to staining agents as the old connective tissue, but differed from the latter in its attitude toward pancreatin, as it was digested by it. Baitzell points out that embryonic connective tissue is also digestible by pancreatic juice. The summary of all these reports shows that the theory according to which connective tissue is evolved from cicatricial tissue has already been advanced by several investigators. The blastema is separated from the subjacent tissues by a well-defined boundary line, only where it touches the musculature does this line disappear, and the tissues seem to pass into each other.

When a short distal piece is amputated, very little blood leaves the blood-vessels. In such regenerations there is little primary blastema (fig. 23).

In his study of the regeneration in Gastropoda, Techow describes processes very similar to those which I have just depicted in Cephalopoda. He found that the wound remains open without any covering whatever during the first few hours after operation. Then the blood-vessels leading to the wound become filled with cells, which later form a layer over the wound. Techow gave a detailed description of these cells, but did not classify them histologically. In my opinion, these are haemolymph cells, for it would be rather strange for the blood-vessels to be suddenly filled with a great number of cells which normally did not belong there. An appearance of strange cells in the blood-vessels would denote a pathological condition. But these cells later on form a blastemal tissue, so they cannot be pathological. These cells cannot be anything else than blood-corpuscles, and from Techow's paper we can clearly see that Gastropoda, like the Cephalopoda, do not bleed immediately after operation, but only after a period of several hours has elapsed.

During the formation of the cicatricial tissue, which acts as a preliminary covering for the wound, the epithelium which is destined to form the final covering remains inactive. It is difficult to state just how much time must elapse after operation before the regeneration of the epithelium is initiated. It varies from ten hours to two days. The causes of this fluctuation are probably the same as already mentioned on page 9. Before the epithelium begins to stretch over the wound, the basal membrane of the uninjured epithelial cells immediately adjacent to the wound draws back a little. According to Hescheler, the same thing happens before the regeneration of the epithelium in Lumbricidae. The cells from which the basal membrane has withdrawn are no longer in such close connection with the more proximal epithelial cells, and probably on that account able to alter their form. They become flat, and their nuclei, which formerly were vertical, are now in horizontal position. Figure 24 shows a picture of such horizontal nuclei. These

flat epithelial cells then proceed to crawl over the wound until the latter is entirely covered by an exceedingly thin epithelium, which seems almost no thicker than a membrane. The nuclei, however, are easily visible and the cuticle shows the characteristic striae. I could not detect any nuclear division at this stage. Here we have a case of rearrangement of old material, which is generally called morphalaxis. Cucagna and Nusbaum found that the final healing of wounds in *Nudibranchia* was accomplished in the same manner. Lang, Hescheler, and Stevens ('06) state that the same is the case in worms, but Techow and Hanko, who both worked on *Gastropoda*, claim that mitosis takes place in the epithelium while the latter spreads over the wound. The cells of the newly formed epithelium vary greatly in shape (fig. 24). Sometimes they are long, sometimes short and broad. Some of them are funnel- or pear-shaped, and others again have appendages extending into the subjacent tissue. In general the epithelial cells are larger than the cells of the adjacent tissue. The variety of form among the young epithelial cells is perhaps due to the absence of the basal membrane. The absence of such a membrane permits the direct connection of the epithelium with the subjacent embryonic tissue. This makes it possible for cells of this tissue to migrate into the epithelium in order to increase more rapidly the rather small number of its cells. But in spite of very careful search, I was not able to find a single case of such migration. Wound healing having been accomplished, the epithelial cells, which constitute the covering, undergo a change. They no longer remain flat, but become cubical, and their nuclei regain their former vertical position, at the same time growing more voluminous. At this stage the young epithelial cells begin multiplying by means of nuclear division. This activity is not confined to a certain part, but spreads all over the young epithelium. The division is so rapid that the new epithelium is soon filled with a large number of nuclei, and on the third or fourth day after operation looks like a syncytium (fig. 26 a). There are relatively a greater number of nuclei in the new epithelium than in the old. As I could not find any cases of mitosis, I am inclined to think that the increase in the

number of nuclei is due to amitotic or direct division. This opinion was confirmed by the discovery of several nuclei in different stages of amitotic division (fig. 26 b). Lang ('09, '10) found that the epithelium of the Turbellarians also regenerates by means of Amitosis. Techow, however, claims that the increase in epithelial cells of the Gastropoda is due to both mitotic and amitotic division.

At the time when this lively nuclear division of the epithelium begins, the latter is already provided with a well-developed basal membrane. It is difficult to say where this membrane has its origin. It is possible that the subjacent tissue takes an active part in its formation. The presence of a basal membrane probably prevents any epithelial cells from migrating into the subjacent tissue. At any rate, I could not find any such cases of migration. In this point the epithelium of the Cephalopoda differs greatly from the epithelium of the Gastropoda. According to Techow, the latter contributes cells to the subjacent tissue, this being made possible by the tardy appearance of the basal membrane (it took eight days before it was formed).

*b. The muscles.* Soon after operation disintegration sets in in those muscles immediately adjacent to the wound. This is due to a degeneration of muscular tissue, which comes to pass in the following manner. The sarcoplasm breaks down, the spiral fibers seem to expand or grow thicker, thereby filling the gaps left by the decaying sarcoplasm, and crowding out the granulated plasm of the core (fig. 27). In spite of this degeneration, the muscle fibers still stain deeply when eosin is employed. Later on in the course of further degeneration the colorability decreases, the axial tube disappears, and the muscle fiber loses its cylindrical shape. In the end all that is left of the muscle fiber is a clotty mass, which stains very slightly.

The nuclei of the muscle fibers do not all degenerate in the same way. In some the disintegration becomes noticeable in the chromatin, the latter massing together in little lumps, but the exterior form of the nucleus is not changed during this process, neither were there any visible signs of shrinkage. In other nuclei the shrinkage and the concentration of the chromatin seem to

take place simultaneously; at any rate, they alter their form, appearing round instead of elongated. These two processes continue until the nucleus has the appearance of a solid mass of chromatin. Then it breaks up into two, sometimes three parts, a process which has been called fragmentation (fig. 28). These nuclear fragments probably have great qualities of resistance, for they endure the whole process of degeneration, are present in its very first stage, and are still visible when the tissue has become quite necrotic. I was not able to find any phagocytic formations consisting of sarcoplasm and parts of the nucleus, such as Metchnikoff ('92) discovered in the degenerating muscles of vertebrates. Neither was I able to detect a fatty degeneration which Bordage ('14) found to be the case in the muscles of Orthoptera.

Soon after the wound has been covered by blood, corpuscles from the blood-clot migrate into the degenerated muscles and begin to dissolve and absorb the disintegrated parts. The cloddy remnants of the muscles, which up to the appearance of the blood-corpuscles, consisted of a solid mass, begin to disintegrate, and at the same time the nuclear fragments (described above) decrease in number (fig. 29). Finally so many blood-corpuscles collect in the degenerated muscle tissue that the latter appears like the primary blastema and is hardly to be distinguished from it.

The first sign of regeneration in the muscle tissues is the appearance of large cells, which have very little protoplasm and seem to consist only of a large nucleus (fig. 30). These cells first appear in that part of the blastema which occupies the place formerly filled by the degenerated muscles. These cells are most probably sarcoblasts, and like the sarcoblasts of the vertebrates originate in the old muscle tissue. It is difficult to give any exact information as to how they are formed or as to whether the whole muscle fiber or only a part (and which part) contributes the necessary material. But there can be no doubt about their actually being sarcoblasts, for their development into muscle fibers can easily be followed up in later stages. The sarcoblasts have a rounded or oval nucleus containing very fine granules

and one nucleolus. They migrate to the distal portion of the wound, and in combination with the neuroblasts form the second blastema (fig. 31). They multiply very rapidly by means of mitosis (fig. 32). About twelve to fourteen days after operation the sarcoblasts of the proximal portion of the regenerated piece begin to transform into the definitive muscle fibers. But this differentiation does not begin simultaneously in every part of the musculature. The longitudinal muscles are the first to begin this process, and in these the very first differentiation takes place in those parts which are nearest to the perimuscular connective-tissue membrane. The differentiation progresses distalward in the longitudinal muscles. The transformation of the transverse muscles into their final form probably takes more time, for they are still in the sarcoblast stage at a time when the surrounding longitudinal muscles already appear as quite well-developed muscle cells. Most likely this is due to the different intensity of growth in the different muscle fibers. The muscle fiber can only grow by means of sarcoblasts. The best proof of this assertion is the fact that at the distal end of every regenerated piece as well as of every normal arm there are no muscle cells, but only sarcoblasts. As the difference in thickness between the regenerated piece and the stump is particularly great at the juncture of these two parts, there must be an active and intense growth in breadth at this point, in order to equalize this difference in thickness. The transverse musculature will probably take an active part in this growth. Whereas in the longitudinal muscles the point of active and intense growth is always carried farther and farther away from the juncture the more the regenerated piece grows in length, the transverse muscles of this part remain in a stage of active and intense growth for a much longer time. Hence the transformation of the sarcoblasts into muscle fibers begins later in the transverse muscles than in the longitudinal muscles. That the sarcoblasts of the Cephalopoda are a product of the old muscle fibers has already been mentioned. This is a case of new formation from preexisting tissue and verifies the statement that a new tissue can only be formed by the same kind of old tissue. According



to Techow, however, this rule is not applicable to the muscles of the Gastropoda. He claims that in the course of regeneration the new muscles are also evolved from large cells (sarcoblasts), but believes that these cells are originally epithelial cells which have migrated into the subjacent tissue. There are very few reports on the histological processes connected with the muscle regeneration in Mollusca. I could only find three in all—Techow's, Hanko's, and the paper published by Cucagna and Nusbaum on the regeneration in Nudibranchia. Techow's opinion on the subject has already been given. Hanko claims that the new muscles are a product of the old, but he does not mention the presence of any sarcoblasts. He states that certain cells (Wanderzellen), whose origin he does not explain, gather around the distal and somewhat inflated end of the muscle stump. These cells form a kind of bridge between the muscle stump and epithelium, and along this bridge the new muscle fibers, which are formed by proliferations of the old, develop. According to Cucagna and Nusbaum, the new muscles are evolved from sarcocytes (sarcoblasts) formed of the sarcoplasm and nucleus of the old muscles. Schultz, Bordage ('14) and Friedrich state that the same is true of the muscles of the Arthropoda.

Barfurth ('91), Nauwerk ('90), and Fraisse ('86) found that the muscles of the vertebrates also regenerate by means of sarcoblasts.

The musculature of the suckers is formed by lateral proliferations of the central muscle bundle (fig. 33). These buds are soon separated from their seat of origin by connective tissue. The invagination of external tissue which causes the formation of the sucking cavity also indents the muscle-bud, consisting of sarcoblasts. In the course of further development the sarcoblasts are grouped around the cavity in two distinct parallel layers (fig. 34). Later these sarcoblasts develop into the radiating and circular muscles of the sucker. As in the transverse muscles, the formation of the final muscle fibers begins later in the sucker muscles than in the longitudinal muscles of the central muscle bundle.

*c. The nervous system.* Up to the present no histological study of nerve regeneration in Mollusca has been published. Techow refrained from doing so on account of technical difficulties. Hanko states that the nerves which innervate the eye of *Nassa mutabilis* regenerate, but does not state how. He refers to a paper by M. Küpfer which was in preparation when his own was published. I tried to obtain this paper, but as it has not yet been published, I was unable to see it. Nerve regeneration in worms has been studied by Lehnert, Bardeen ('04), Hescheler, Lang, Flexner ('98), Schultz, and Stevens. The two first authors claim that the new nerve fibers simply grow out of the old. Lang, Flexner, Schultz, and Stevens found that the new brain is formed by parenchym cells. The regeneration of the nervous system of vertebrates has often been made the subject of histological study. Experiments were made chiefly on the spinal cord of tritons and lizards, in some cases on the spinal cord and also on the brain of birds (pigeons) and mammals (rabbits and dogs). Dentan ('73), Eichhorst ('75), Naunyn ('74), Keresztzsegy ('92), and Hanns ('92) could not find any regeneration in the central nervous system of vertebrates. Ströbe ('94) claims that the injured spinal cord of the rabbit makes an effort to repair the damage, but that an actual regeneration does not take place. Contrary to this, Walter ('53), Cattani ('85), Brown-Sequard ('50), Müller ('64-'65), Masius ('70), and van Lair ('70), Caproso ('88), all claim that the central nervous system is able to regenerate. Tedeschi ('97) found regenerated ganglion cells and nerve fibers in the brain of mammals. There is quite some diversity of opinion on the manner in which the nerve cells multiply. Walter, Cattani, Modino ('85), Friedmann ('88), Ziegler ('95), Coen ('88), Sanarelli ('96), Marinescu ('94), and Tedeschi, all claim that the nerve cells multiply by means of mitosis. Caproso and Barfurth, on the other hand, believe that the new nerve cells are evolved from neuroblasts, which originate in the epithelium of the central canal. Mühlmann ('08, '10), who has made the structure and growth of the nerve cell an object of special study, is of the opinion that already at an early stage of its development certain

inhibiting elements appear in the nerve cell which prevent its further division. In the following I shall try to give a short histological study of nerve regeneration in the arm of *Octopus vulgaris*.

An examination of the wound with a magnifying glass immediately after operation reveals the fact that the axial nerve protrudes beyond the surrounding tissues (fig. 4). H. Müller found similar conditions in the spinal cord of a lizard whose tail had been amputated. An intense and active degeneration is initiated in the protruding part of the axial nerve. This disintegration progresses so quickly, that it is very difficult to make a thorough examination of its various stages. It begins in the layer of ganglion cells. The first signs of degeneration become visible in the nucleus. The chromatin, which in the normal nucleus is generally thickest along the periphery, moves toward the center and gathers around the nucleolus, the nuclear membrane still retaining its original form while this process is going on (fig. 35). Later on this membrane also degenerates, and the nucleus, which has in the meantime shrunk to a homogeneous little lump, lies in a kind of vacuole. Most of these nuclear remnants soon disappear, but some of them seem to be endowed with a great power of resistance, as they are still present even after a few days. I was not able to observe carefully the degeneration of the protoplasm. On the whole, I found the endoplasm resisting longer than the ectoplasm. The nuclei of the glia tissues shrink and are changed into homogeneous chromatin globules, resembling the reduced ganglion-cell nuclei, only somewhat smaller in size. The degeneration in the neuropil is at first not as marked as in the ganglia layer, and is only noticeable by a slight disintegration of the tissues. When stained with eosin, the neuropil no longer exhibits the same intense coloring as before, and the glia nuclei distributed in it have noticeably shrunk. The fibers of the myelin cords are swollen and unduly enlarged at the distal end of the stump. Sometimes they are from four to six times as voluminous as the normal fiber. The myelin, which in the normal fiber is so equally distributed as to give it a homogeneous appearance,

clots together to granules which either form a network or larger lumps of granules (fig. 36). Ströbe found that the white substance of the spinal cord of vertebrates also swells up as a result of degeneration. This fact would to a certain degree strengthen Colosanti's assertion that a kind of analogy existed between the myelin cord and the white matter. The degeneration reaches deeper into the myelin cords than into the ganglia layer and the neuropil.

About ten hours after operation a further disintegration is noticeable in the myelin cords and the neuropil, whereas the ganglion cells show hardly any further change. There is a marked increase in the number of nuclei in the neuropil as well as in the myelin cords. In the myelin cords this increase is due to the migration of blood-corpuses. The fibers of the myelin cords are torn asunder, the myelin cords thus occupying more space at the distal end than is normally the case (fig. 23). Probably the blood-corpuses also migrate into the central mass of nerve fibers, but I could not ascertain their presence there with absolute surety. The increase in the number of nuclei in the neuropil is due to the amitotic or direct division of the glia nuclei, which have entered the central nerve-fiber mass along with the processes of the nerve cells (fig. 37). About one or two days after operation a large number of cells, all provided with vesicular nuclei, appear in the neuropil and then migrate to the most distal part of the stump. Together with the sarco blasts they form the so-called second blastema (fig. 31). These cells are doubtlessly neuroblasts, for later on the ganglia are evolved from them. It is very difficult to find the origin of these neuroblasts. I am of the opinion that the glia nuclei contribute largely to their formation, for the glia nuclei are the only nuclei (besides a few nuclei of the connective tissue), which are normally embedded in the central mass of nerve fibers. But I must also draw attention to the fact that the nuclei of the neuroblasts are a little larger than the glia nuclei. The neuroblasts are very similar in structure to those ganglion cells lying nearest the neuropil, which have been described as nude nerve nuclei. Perhaps these cells having been

stimulated to division by the operation, have multiplied and migrated into the central nerve-fiber mass. Some neuroblasts also originate in the layer of ganglion cells. It is hard to tell whether they are evolved from the glia or produced by the nerve cells. If the latter is the case, we may safely say that only the small ganglia, the so-called nude nerve nuclei, take part in the production of neuroblasts. These small ganglia are probably in a very early stage of differentiation. Therefore they are more like the neuroblasts than the medium-sized or larger ganglia. But in spite of their similarity, I would not say that the small ganglia and the neuroblasts are identical. I was never able to discover any mitosis in the small ganglia, whereas the neuroblasts exhibited many cases of karyokinesis. The large and medium-sized ganglia do not participate in the production of neuroblasts. Neither a division nor a reduction of the protoplasm (a process which would bring them in closer relation with the neuroblasts) takes place. It is quite probable that both the glia and the small nerve cells produce the neuroblasts. The neuroblasts are very similar to the sarcoblasts, which makes it difficult to tell them apart (fig. 31).

Fine fibers of the myelin cords grow into the second blastema, thus separating the neuroblasts from the sarcoblasts of the externally located muscle bundle. The myelin cords do not change their appearance very much during regeneration. They do not undergo such a radical change as the rest of the tissues. Their alteration, due to degeneration, has already been mentioned (p. 27), and the only change caused by regeneration was an increase in the number of nuclei of the sustentacular tissue. In consequence of this remarkable behavior, they are more easily and rapidly recognized in the regenerated piece than any of the other parts, with the exception of the epithelium, the main artery, and the two *venae superficiales*. The myelin cords grow into the regenerated piece, not in the form of blastema cells of any kind, but as a well-differentiated tissue. Many authors have put forth the theory that regeneration is in a large degree dependent on the presence of nerves. The fact that the myelin cords, which serve as a connection between the brain

and the axial nerve, grow so quickly and appear as differentiated myelin fibers in the most distal portion of the regenerated piece, while all the surrounding tissues are still in blastemal stage, is a strong argument in favor of this theory. On the inner side of the myelin cords the neuroblasts form the same regular rows as the ganglion cells in the normal arm. Eleven days after operation this regular arrangement and also the tissues separating these rows were visible. The first sign of the new central mass of nerve fibers also appears at the same time. The myelin cords probably produce the first fibers of the new neuropil, for the young nerve cells do not at this time exhibit any processes. Only later are the neuroblasts turned into ganglion cells by forming protoplasm and fibers. As the differentiation of the ganglia progresses, the neuropil naturally gains in size. Three weeks after operation the axial nerve is well developed in all of its three components (fig. 38). Among the ganglia the small cells, the so-called nude nerve nuclei, predominate. But there are also quite a number of medium-sized nerve cells present, whereas large ganglia are still missing. The latter probably appear very late, for I was unable to find any, even in regenerated pieces, which were already in quite an advanced stage. The young neuropil contains relatively many nuclei, which, however, decrease in numbers as development goes on. The greater part of the regenerated piece is occupied by the axial nerve, the rest of the tissues being confined to a relatively small space. The same conditions prevail in the embryonic arm. In the normal arm the axial nerve constitutes a fourth part of the whole.<sup>5</sup>

Unfortunately, I was not able to observe the formation of the sucker ganglia and the four nerve cords embedded in the muscles. The sucker ganglia probably appear very late in the regenerated piece, for I was not able to find a single one. I believe their formation is only initiated after the nerves which connect the axial nerves with the sucker ganglia and also innervate the suckers have grown out from the axial nerve. It is

<sup>5</sup> I should like to draw attention to the publications of Brynes and Fritzsche. Both of them studied regeneration in water newt (*Triton*) extremities and found that cartilage is evolved from blastema directly opposite of the growing nerve.

possible that the ganglia arise in the embryonic connective tissue under the influence of the growing nerve. In a piece which had been fixed three or four days after operation and which was just on the point of beginning regeneration, I was able to observe fine fibers of the peripheral nerves, which originated in the uninjured part of the axial nerve, but innervated one of the amputated suckers growing into the primary blastema. At the distal end of one of these fine fibers I could detect some cells which showed a marked similarity to the nerve cells (fig. 39).<sup>5</sup>

The subcutaneous connective tissue is most probably evolved from the primary blastema. At first, however, the latter is separated from the subjacent connective tissue by a sharp boundary line, which later on disappears. Unfortunately, I am not able to give any detailed account of the regeneration of the vascular system. I heard that Minervini had studied this process, but I was not able to find his publication. Authors who have studied the regeneration of the vascular system in other animals claim that the new blood-vessels are formed by a proliferation of the endothelium of the old blood-vessels. I was not able to detect any proliferation of endothelium in the regenerating arm of the Cephalopoda. The main artery and the veins grow rapidly and are visible in the most distal portion of the regenerated piece. In such a stage as is exhibited in figure 8 the blood-vessels form a kind of plexus which is well filled with blood.

I did not make the regeneration of the epithelial glands and the chromatophores the subject of any closer study. Chun has published a very detailed account of the development of the chromatophores.

#### SUMMARY

The most important morphological changes which occur during the regeneration of the arm of the Cephalopoda (*Octopus vulgaris*) are the following:

1. *Wound healing.* After operation the edges of the wound curl inward. The axial nerve protrudes beyond the other tissues. Bleeding does not take place immediately after operation, but

after a period of several hours (five to six). The wound is then completely overspread with blood which serves as a preliminary covering for the same. After bleeding, the protrusion of the axial nerve disappears. The last two suckers at the obtuse end of the arm are abnormally drawn up, as if they also participated in the preliminary closing of the wound. The final wound healing by epithelium occurs in some animals within the first twenty-four hours after operation; in most cases, however, it takes from thirty-six to forty-eight hours.

2. *Change of form.* The distal suckers which were drawn up regain their normal position. The first visible sign of regeneration appears in the shape of a little knob near the external side of the arm. The knob develops into a little lash-like appendage, which appears like a thin rod in comparison to the arm stump.

3. *Formation of the suckers.* The newly formed suckers must be divided into two groups, those that are formed as suckers of the regenerated piece proper and those formed at the obtuse end of the arm stump. All suckers first appear in the form of little transverse folds. Later on they are rounded off to little papillae. The newly formed suckers at the obtuse end of the arm are arranged in single file. They remain in a single row during the greater part of their development. On the other hand, the suckers of the regenerated piece exhibit the final double-rowed arrangement at a very early stage of their development. The sucker cavity and the adhesive part are both formed by invagination. At the base of the regenerated piece, one or two suckers (sometimes three) always remain in single file.

4. *The chromatophores.* The first new chromatophores appear about three to four weeks after operation. They are smaller and of a lighter shade than the normal chromatophores.

The histological study led to the following results:

1. *Wound healing.* The wound is at first unprotected (five to six hours). Then a preliminary covering, consisting chiefly of a clot of agglutinated blood-corpuscles, is formed. From this blood-clot a primary blastema is gradually evolved, the blood-plasm becoming less and less, and the agglutinated blood-corpuscles forming a fine network. The epithelium remains



inactive for the first few hours after operation. Later on the epithelium cells at the edge of the wound grow flat, the nuclei which up to that time were vertical change their position, becoming parallel to the edge of the wound. The flat cells creep over the wound from all sides, till the latter is completely covered by a very thin tessellated epithelium, provided with a cuticle. The tessellated epithelium gradually becomes cubical and later on cylindrical.

2. *The musculature.* Disintegration begins in the musculature soon after operation. The sarcoplasm degenerates. The spiral fibers expand, thus filling the gaps left by the sarcoplasm, and at the same time narrowing the central duct and crowding out the granulated substance of the core. The result of this degeneration is a cloddy mass, which shows less affinity to staining agents than the normal muscle fiber. The nuclei become homogeneous globules of chromatin, and break up into two or three pieces (fragmentation). The degenerated muscles are partly dissolved or absorbed by blood-corpuscles which migrate into the disintegrated tissue. The muscles regenerate by means of sarcoblasts. The sarcoblast possesses quite a large nucleus, which is provided with one nucleolus. The sarcoblasts later migrate to the distal part of the stump, and in combination with the neuroblasts form the second blastema. They multiply by means of indirect or mitotic division. The sarcoblasts of the external longitudinal muscles are the first to exhibit muscle fibers. In the transverse muscles fibers appear at a much later date. The muscles of the suckers are evolved from lateral proliferations of the sarcoblasts of the central muscle-fiber bundle.

3. *The nervous system.* The first sign of disintegration of the axial nerve is found in the layer of ganglion cells. The ectoplasm of these cells degenerates and the nucleus shrinks, the chromatin gathering around the nucleolus. The nuclei of the neuroglia undergo the same change. The fibers of the myelin cords expand and often grow five times the size of the normal tissue. The only signs of degeneration visible in the neuropil are the shrinking of the neuroglia nuclei embedded there and a decrease of its

affinity to staining agents. Later the neuropil becomes vacuolized and the neuroglia nuclei increase in numbers. Blood-corpuses penetrate the degenerated portions of the myelin cords, but disappear again. The differentiated nerve cells do not multiply by division, but by means of neuroblasts, which originate in the central mass of nerve fibers as well as in the layer of ganglia. Probably both neuroglia tissue and ganglia contribute to the formation of the neuroblasts. The myelin cords do not pass through a blastema stage. They grow as a well differentiated tissue, and are easily discerned in the regenerated piece. Together with the epithelium and the blood-vessels, they are the first tissues which can be distinguished, all the remaining tissues still being in a blastematous stage.

4. *The connective tissue.* The first elements which later on go to construct the new connective tissue are probably evolved from the primary blastema, a product of the agglutinated blood-corpuses.

The general results of this study may easily be expressed in the following two sentences:

1. All new tissues with the exception of the dermal connective tissue are produced by the preexisting tissues of the same kind.

2. *Sepia* occasionally replaces a lost arm by means of compensatory regulation (development of the correlated buccal arm to replace a lost one).

## APPENDIX

In the introduction mention was made of the extirpation of the lens. As, however, not many animals survived this operation for any length of time, there was not enough material at my disposal to enable me to give any kind of detailed account of the regeneration of this organ. After extirpation of the lens the injured eye lost its ability to perceive light. A few animals, however, survived the operation and lived for over ten weeks after it had been performed. On these animals I noticed that the injured eye had regained its sensitiveness to light after a period of about eight weeks. This fact was ascertained in the following manner. It is well known that the circular pad of skin which surrounds the visible parts of the eye acts as a lid. If the eye is suddenly exposed to light, this pseudolid shuts. If I exposed an eye to the light whose lens had been extirpated a few days previously, then the pseudolid did not close. Ten weeks after operation, however, the same eye showed the characteristic contraction of the pseudolid when suddenly exposed to light. Some animals even survive the loss of a whole eye. While at Naples I one day received a *sepiola* (from Doctor Naef), which had completely lost its one eye. The wound was healed, but I could not detect any signs of regeneration. Perhaps the animal had been injured just a few days before its capture.

## LITERATURE CITED

- AUFRECHT, E. 1890 Ueber die Genese des Bindegewebes nebst einigen Bemerkungen über die Neubildung quergestreifter Muskelfasern und die Heilung per primam intensionem. *Virchows Arch.*, Bd. 44.
- BAITSELL, G. A. 1916 The origin and structure of a fibrous tissue formed in wound healing. *Anat. Rec.*, vol. 10.
- v. BALLOWITZ, E. 1893 Ueber den feineren Bau der Muskelsubstanz. Erstens die Muskelfaser der Cephalopoden. *Arch. f. mikr. Anat.*, Bd. 39, S. 592-309.
- BARDEEN, CH. R. 1904 *American Journal of Physiology*, vol. 5.
- BARFURTH, D. 1891 Zur Regeneration der Gewebe. *Arch. f. mikr. Anat.*, Bd. 37, S. 406-492.  
Regeneration u. Involution. Merkel u. Bonnet, *Ergebnisse der Anatomie*.
- BAUER, V. 1909 Einführung in die Physiologie der Cephalopoden. *Mitt. d. zool. Stat. zu Neapel*, Bd. 19, S. 149-268.
- VAN BENEDEEN, P. J. 1898 Mémoire sur l'Argonaute (nouveaux mém. de l'Acad. Roy. de sc. de Bruxelles, 1898.
- BILLROTH, TH. Zitiert nach Marchand.
- BOBRETZKY, N. 1877 Untersuchungen über die Entw. der Cephalopoden *Nachr. v. d. k. Gesell. d. Kunde d. Natur. Antrop. u. Ethnogr. Moskau.* Bd. 24.
- BORDAGE, ED. 1914 Phénomènes histolytiques observés pendant la régénération des appendices chez certains Orthoptères. *C. R. Acad. de Sc. Paris*, T. 161, p. 125.
- BROCK, J. 1886 Indische Cephalopoden. *Zoolog. Jahrb.*, Bd. 2, S. 591-593.
- BROWN-SEQUARD 1850 Régénération des Tissus de la moelle épinière. *Gaz. méd.*, 1850, p. 250.
- BRYNES, E. F. 1899 On the regeneration of limbs in frogs after the extirpation of limb rudiments. *Anat. Anz.*, Bd. 15.
- CAPRASO, E. Sulla rigenerazione de midollo spinale della coda dei Tritoni. *Ziegler's Beiträge*, Bd. 5.
- CATANNI, FRL. S. 1885 Sulla Fisiologia del gran Simpatico. *Gazz. degli Osp.*
- CHÉRON, J. 1866 Recherches pour servir à l'histoire du système nerveux des Cephalopodes dibranchieux. *Ann. Sc.*, T. 5. (5ème série), p. 1-122.
- CHUN, C. Ueber die Natur und die Entwicklung der Chromatophoren bei den Cephalopoden. *Verh. d. deutsch.-zoolog. Ges.*, 12. Vers. S. 162-182.
- COEN, P. E. 1888 Ueber die Heilung von Stichwunden des Gehirns. *Ziegler's Beiträge*, Bd. 2.
- COLOSANTI, J. 1876 Anatomische und physiologische Untersuchungen über die Arme der Cephalopoden. *Reichert u. Dubois-Reymond's Arch. f. Anat.*
- CONHEIM 1869 Ueber das Verhalten der fixen Bindegewebskörperchen bei Entzündungen. *Virchows Arch.*, Bd. 45, S. 333.
- CUCAGNA, G., UND NUSBAUM, J. 1915 Regeneration bei Nudibranchien. *Arch. f. Ent. Mech.*, Bd. 41, S. 558-579.

- CUÉNOT, L. 1891 Étude sur le sang et les glandes lymphatiques. Arch. de zool. expériment., T. 9, 2ème série, p. 13-90 et p. 593-670.
- CUVIER, J. 1817 Mémoire pour servir à l'Histoire et à l'Anatomie des Mollusques, p. 1-54 (Paris-Déterville).
- DENTAN, P. 1873 Quelques recherches sur la Régénération fonctionnelle et anatomique de la moelle épinière. Berne.
- DOMINICI, M. 1911 Experimenteller Beitrag zum Studium der Regeneration der peripheren Nerven. Berliner klin. Wochenschrift, Jahrb. 48.
- EBERSBACH, A. 1915 Zur Anatomie von Cirroteuthis Umbellata Fischer und Stauroteuthis sp. Zeitschr. f. wiss. Zool., Bd. 93, Heft 3.
- EICHHORST, H. 1875 Ueber die Entwicklung des menschl. Rückenmarkes u. seiner Formelemente, Virchows Archiv., Bd. 64, S. 425.
- EISIG, H. Biologische Studien. Kosmos 12.
- FAUSSEK, V. Ueber die sogenannten 'Weissen Körper,' sowie über die embryonale Entwicklung desselben, der Cerebral ganglien u. des Knorpels bei Cephalopoden. Acad. Imp. Sc. St. Petersburg. 7ème Série, T. 41, n. 9.
- FERNANDEZ, MIG. 1907 Zur Histologie des Tentacles von Nautilus pompilius. Zeitschr. f. wiss. Zool., Bd. 88.
- FLEXNER, S. 1898 The regeneration of the nervous system of Planaria torva (maculata) and the anatomy of the double-headed forms. Jour. Morph., vol. 14.
- FRAISSE, P. 1886 Die Regeneration von Geweben und Organen bei den Wirbeltieren. Biolog. Zentralbl.
- FREDÉRICQ, L. Recherches sur la physiologie du poulpe commun. Arch. de zool. expér., T. 7.
- FRIEDLÄNDER, B. 1895 Ueber die Regeneration herausgeschnittener Teile des Zentralnervensystems von Regenwürmern. Zeitschr. f. wiss. Zool., Bd. 60.
- FRIEDMANN 1888 Ueber progressive Veränderungen der Ganglienzelle bei Entzündungen u. Nervenkrankheiten. Arch. f. Psych., Bd. 13, S. 244.
- FRIEDRICH, P. 1906 Regeneration der Beine und Autotomie bei Spinnen. Arch. f. Ent.-Mech., Bd. 20.
- FRICTSCH, C. 1910 Regenerationsvorgänge des Gliedmassenskelettes der Amphibien. Zoolog. Jahrb. Abt. f. allg. Zool., Bd. 30, Heft 3.
- GARIAEFF, WL. 1901 Histologie des Nervensystems der Cephalopoden. Zeitschr. f. wiss. Zool., Bd. 92, S. 149-186.
- GEDDES, P. On coalescence of amoeboid cells into plasmodia and on the so-called coagulation of invertebrate fluids. Proc. of Royal Soc. London, vol. 30.
- GRENACHER, H. 1874 Zur Entwicklungsgeschichte der Cephalopoden. Zeitschr. f. wiss. Zool., Bd. 24, S. 419-498.
- GRIMPE, G. 1913 Das Blutgefäßsystem der Dibranchiaten Cephalopoden. Teil I, Octopoda. Zeitschr. f. wiss. Zool., Bd. 104, Heft 4, S. 531-631.
- GUÉRIN, J. 1908 Contribution à l'Étude des systèmes cutané, musculaire et nerveux de l'appareil tentaculaire des Cephalopodes. Arch. de Zool. experim. T. 8, 4ème série, p. 1-178.

- HANKO, B. 1913 Ueber das Regenerationsvermögen und die Regeneration verschiedener Organe von *Nassa mutabilis* (L.), Arch. f. Ent-Mech., Bd. 38, Heft 3.  
1913 Ueber einen gespaltenen Arm von *Octopus vulgaris*. Ibid., Bd. 37, S. 217-222.
- HANNS, DR. 1892 Ueber Degenerations- u. Regenerationsvorgänge im Rückenmark des Hundes nach Durchschneidung. Ziegler's Beiträge, Bd. 12, S. 33.
- HESCHELER, K. 1897 Ueber Regenerationsvorgänge bei Lumbriciden. Jenische Zeitschrift. Bd. 30.  
1898 Ueber Regenerationsvorgänge bei Lumbriciden. II. Teil. Jena, Gustav Fischer.
- HILLIG, R. 1912 Das Nervensystem von *Sepia officinalis* L. Zeitschr. f. wiss. Zool., Bd. 101, S. 736-806.
- JAKUBSKI, A. W. 1915 Studien über das Gliedgewebe der Molusken. II. Teil, Cephalopoden. Zeitschr. f. wiss. Zool., Bd. 112, S. 48-68.
- KERESZTSEGY, J. 1892 Ueber Degenerations- u. Regenerationsvorgänge im Rückenmark des Hundes nach Durchschneidung. Ziegler's Beiträge, Bd. 12.
- KLINZ, J. 1914 Experimentelle Schwanzregeneration bei Bilchen, Myoxidae. Arch. f. Ent.-Mech., Bd. 40, S. 344-368.
- KÖLLIKER, A. 1844 Entwickl. Geschichte der Cephalopoden. Meyer u. Zeller, Zürich.
- KOLLMANN, M. 1908 Recherches sur les Leucocytes. Ann. Sc. nat., 9ème série, T. 8.
- KORSCHOLT, E. 1907 Regeneration und Transplantation. Jena. Festschrift für Leuckart. Entwicklungsgeschichte der Cephalopoden.
- LANG, P. 1909 Ueber Regeneration bei Planarien. Arch. f. mikr. Anat., Bd. 79, S. 361-424.  
1910 Experimentelle und histologische Studien an Tubellarien. Ibid., Bd. 82.
- LOEB, LEO 1908 Vergleichende Untersuchungen über die Thrombose. Virchows Arch., Bd. 185, S. 160.  
1909 Blutgerinnung bei Wirbellosen. Biochem. Zeitschr., Bd. 24, S. 478-495.
- MARINESCU 1894 Sur la régénération des centres nerveux. Compte rendu de la soc. de Biolog., 17 Mai.
- MARCHAND, J. 1901 Prozesse der Wundverheilung. Deutsche Chirurgie, Bd. 16.
- MASIUS U. VAN LAIR 1870 Bullet. de l'Acad. roy. de Belgique, T. 21.
- METSCHNIKOFF, E. 1892 La phagocytose musculaire. Ann. de l'Institut Pasteur, T. 6, p. 1-12.
- MODINO, C. 1885 Giornale della R. Acad. di Torino, Gennaio-Febr.
- MORENO, J. 1907 La candés ganglienas en los tentaculos de Cephalopodi. Rev. real. Acad. de Cienzas exactas bisy. nat. de Madrid, T. 5.
- MORGAN-MOSKOWSKI 1907 Regeneration. Leipzig.
- MÜHLMANN, M. 1811 Studien über den Bau und das Wachstum der Nervenzelle. Arch. f. mikr. Anat., Bd. 77.

- MÜHLMANN, M. 1912 Mikrochemische Untersuchungen an der wachsenden Nervenzelle. *Ibid.*, Bd. 79.
- MÜLLER, J. 1864-1865 Regeneration der Wirbelsäule und des Rückenmarks bei Tritonen und Eidechsen. *Abhandl. d. Senkenberg. nat. Ges.*, Bd. 5.
- NAEF, A. Cephalopoda. *Handwörterb. d. Naturwiss.*, Bd. 2. Teutologische Notizen. *Zoolog. Anz.*, Bd. 40.
- NAUNYN, BERNH. 1874 Ueber Regeneration u. Veränderungen im Rückenmark nach streckenweiser totaler Zerstörung derselben. *Arch. f. exper. Pathol. u. Pharmat.*, Bd. 2.
- NUSBAUM, J. Vergleichende Regenerationsstudien. *Zeitschr. f. wiss. Zool.*, Bd. 79.
- OST, J. 1906 Zur Kenntnis der Regeneration der Extremitäten bei den Arthropoden. *Arch. f. Ent.-Mech.*, Bd. 22, S. 289-325.
- OWSJANNIKOW, P. Ueber das central Nervensystem und das Gehörorgan der Cephalopoden. *Mem. Ac. St. Petersb.*
- PFEFFERKORN, A. 1915 Das Nervensystem der Octopoden. *Zeitschr. f. wiss. Zool.*, Bd. 114, Heft 3.
- REED, M. A. 1905 The regeneration of the first leg of the crayfish. *Arch. f. Ent. Mech.*, Bd. 18.
- REICHENSPERGER, A. 1912 Beiträge zur Histologie und zum Verlauf der Regeneration bei Crinoiden. *Zeitschr. f. wiss. Zool.*, Bd. 101, S. 1-69.
- RIEVEL, H. 1896 Die Regeneration des Vorderdarmes und Enddarmes bei einigen Aneliden. *Zeitschr. f. wiss. Zoolog.*, Bd. 62, S. 289-341.
- RIGGENBACH, E. 1901 Beobachtungen über Selbstverstümmelung. *Zool. Anzeiger*, Bd. 24, S. 587-593.
- 1902 Die Selbstverstümmelung der Tiere. *Anat. Hefte*, II. Abt.
- RINDFLEISCH, ED. Zitiert nach Marchand.
- SANARELLI 1896 I processi riparativi nel cervello e nel cervelletto. *R. acad. dei Lincei*.
- SCHULTZ, E. Ueber die Regeneration der Spinnenfüsse. *Trudy Petersburg. Obs. Estesvoip.*, Bd. 29.
- STEVENS, N. M. 1909 A histological study of regeneration in *Planaria simplicissima*, *P. maculata*, and *Pl. morgani*. *Arch. f. Ent.-Mech.*, Bd. 24.
- 1907 Notes on regeneration in *Planaria lugubris*. *Ibid.*, Bd. 13.
- STROEBE, H. 1894 Experimentelle Untersuchungen über die degenerativen und reparativen Vorgänge bei der Heilung von Verletzungen des Rückenmarks, nebst Bemerkungen zur Histogenese der sekundären Degeneration in Rückenmark. *Zieglers Beiträge*, Bd. 15.
- TECHOW, G. 1910 Zur Regeneration des Weichkörpers bei den Gattropoden. *Arch. f. Ent.-Mech.*, Bd. 31.
- TEDESCHI, A. 1897 Anatomisch-experimenteller Beitrag zum Studium der Regeneration des Gewebes des Zentralnervensystems. *Beitr. z. Anat. u. path.*, Bd. 21, S. 43-72.
- THULIN, J. Beitrag zur Frage der Muskeldegeneration. *Arch. f. mikr. Anat.*, Bd. 79, S. 208-230.
- UEXKÜLL, F. VON 1893 Physiologische Untersuchungen an *Eledone moschata*. II. Die Reflexe der Arme. *Zeitschr. f. Biolog.*, Bd. 30.

- USSOW, M. 1894 Zoologisch-embryologische Untersuchungen. Die Kopffüßler. Arch. f. Nat. Gesch., Bd. 40, S. 329.  
1881 Die Entwicklung der Cephalopoden. Arch. de Biol., T. 2, F. 4.
- VERILL, A. 1892 Cephalopodes of N. E. America. Transact. of Connecticut Acad., vol. 5, p. 260.
- VILALLETON, L. 1888 Recherches sur les premières phases du développement de la seiche 1888. Ann. de Sc. nat., 7ème série zool., T. 6.
- WALTER 1853 De regeneratione ganglionum. Diss. inaug. Bonnae.
- WEIGL, R. 1910 Ueber den Golgi-Kopschen Apparat in der Ganglienzelle der Cephalopoden. Anzeig. d. akad. d. Wiss. zu Krakau.
- ZIEGLER, E. 1895 Lehrbuch der path. Anatomie, Bd. 2, S. 354.



## PLATES

## PLATE 1

### DESCRIPTION OF FIGURES

1 Transverse section of an arm of *Octopus vulgaris* according to Guérin. *a*, epithelium; *b*, subcutaneous connective tissue; *c*, chromatophores; *d*, vein; *e*, dermal musculature; *f*, perimuscular connective-tissue membrane; *g*, external oblique muscle; *i*, inner oblique muscle; *j*, inner lateral longitudinal muscle; *k*, external longitudinal muscle; *l*, internal longitudinal muscle bundle; *m*, transverse musculature; *n*, perinervous connective tissue; *o*, layer of ganglia; *p*, central mass of nerve fibers (neuropil); *q*, myelin cords; *r*, brachial arteries; *s*, nerve; *t*, sucker; *u*, sucking cavity; *v*, adhesive part; *w*, sphincter.

2 Muscles according to Ballowitz. *A*, longitudinal section; *B*, transverse section; *a*, spiral fibers; *b*, core; *c*, nucleus.

3 Large nerve cell in the axial nerve of the arm of *Octopus vulgaris*. *a*, glia fiber; *b*, glia nucleus; *c*, ectoplasm; *d*, endoplasm; *e*, Nissl granules; *k*, nucleus; *k'*, nucleolus.

4 Blood-corpuscles from the brachial arteries.

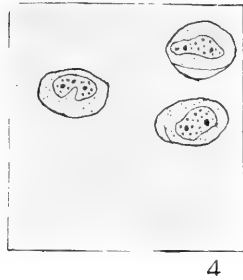
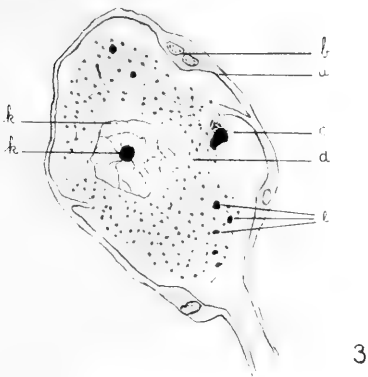
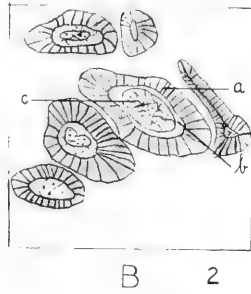
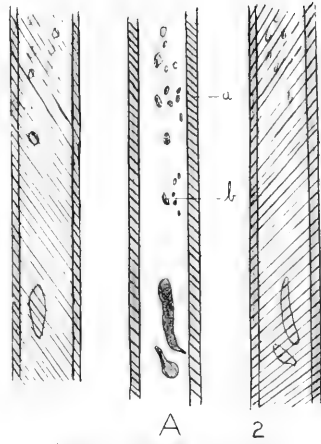
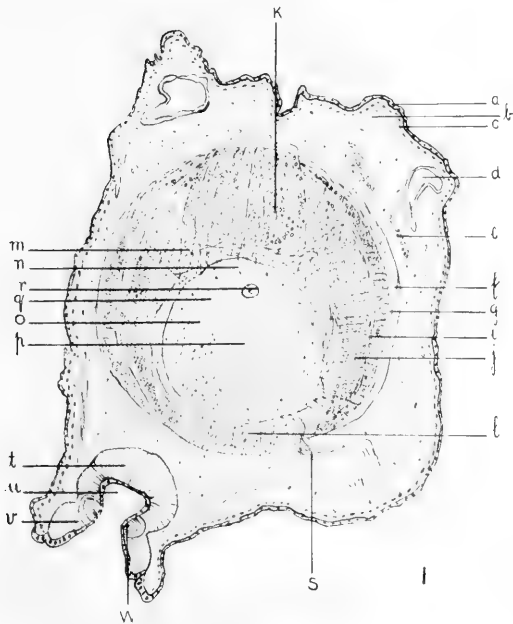

## PLATE 2

### DESCRIPTION OF FIGURES

- 5 Wound of an *Octopus vulgaris* arm one and a half hours after operation. *a*, axial nerve; *b*, myelin cords.
- 6 Wound of *Octopus vulgaris* arm ten hours after operation.
- 7 Healed wound of an *Octopus vulgaris* arm one day after operation. Distal suckers are drawn up.
- 8 Little knob first visible sign of regeneration three days after operation.



5



6



7

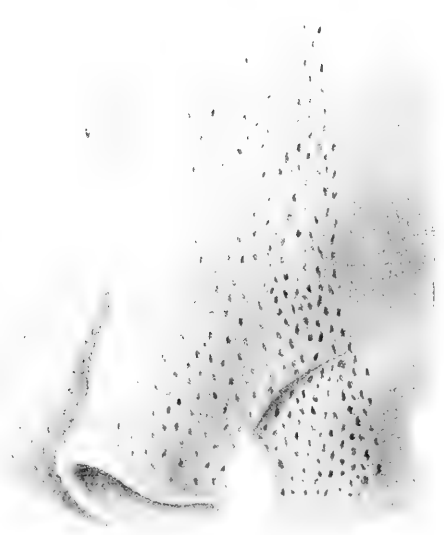

8

### PLATE 3

#### DESCRIPTION OF FIGURES

- 9 Dome-shaped knob three days after operation.
- 10 Regenerated piece eleven days after operation. Little transverse folds are suckers at a very early stage of development.
- 11 and 12 Regenerated piece three weeks after operation.



9

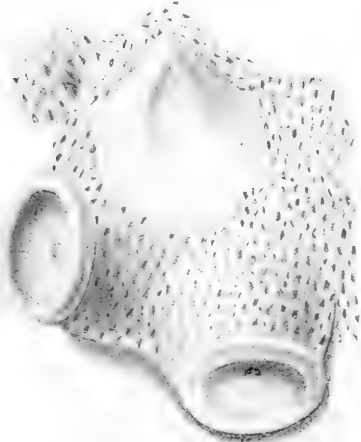

10

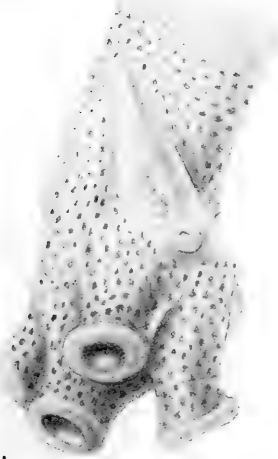

11

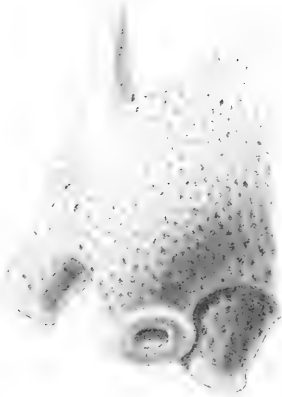

12

PLATE 4

DESCRIPTION OF FIGURES

- 13 and 14 Regenerated piece three weeks after operation.  
15 Regenerated piece of an *Octopus vulgaris* arm four weeks after operation.  
16 Regenerated piece of an *Octopus vulgaris* arm six weeks after operation.





13

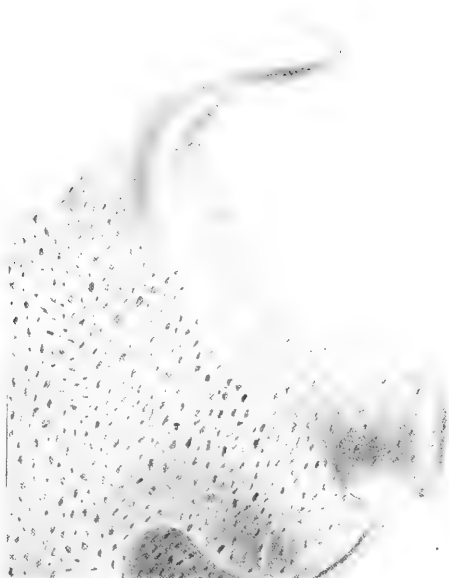

14



15

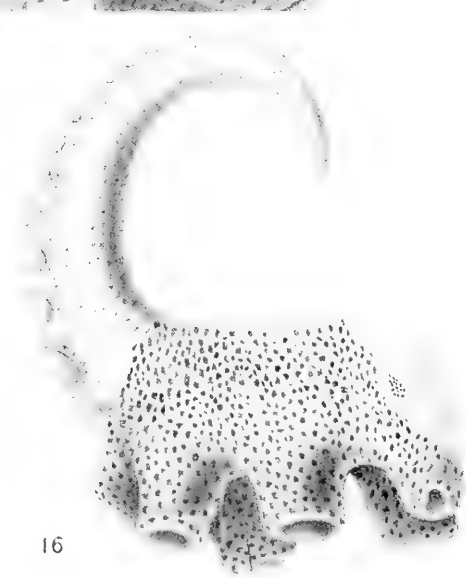

16

## PLATE 5

### DESCRIPTION OF FIGURES

17 Longitudinal section through the wound shown in figure 5 (one-half hour after operation). *a*, epithel; *b*, subcutaneous connective tissue; *c*, chromatophores; *d*, musculature; *e*, artery; *f*, myelin cord; *h*, neuropil; *i*, layer of nerve cells; *j*, sucker.

18 Open brachial artery six hours after operation.

19 Agglutinating blood-corpuseles.

20 Brachial artery closed by a clot of agglutinating blood-corpuseles.

21 Primary blastema evolved from blood-corpuseles.

22 Longitudinal section through an *Octopus vulgaris* arm ten hours after operation. Preliminary covering of the wound formed by agglutinating blood-corpuseles.

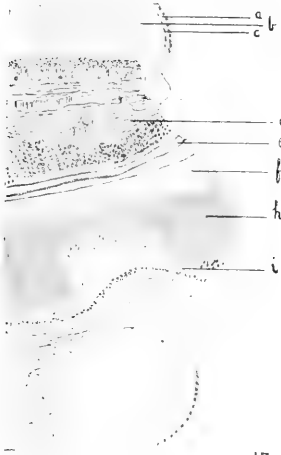

17

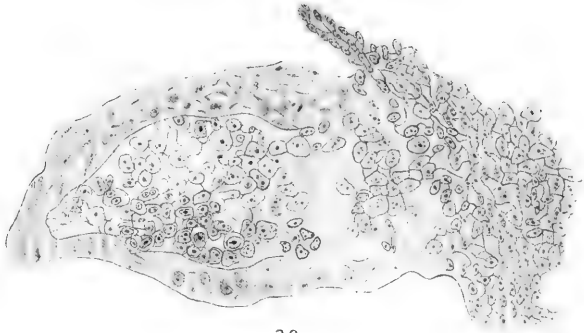

20

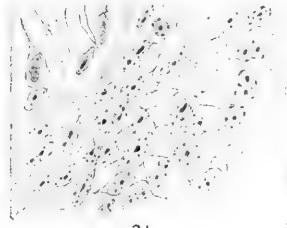

21



18

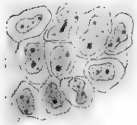

19

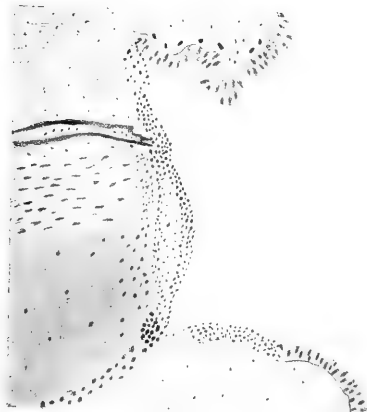

22

## PLATE 6

### DESCRIPTION OF FIGURES

- 23 Healed wound near the tip of the arm. *a*, very thin layer of primary blastema.
- 24 Octopus vulgaris arm forty-six hours after operation. Newly formed epithelium.
- 25 Octopus vulgaris arm 1 to 2 days after operation. Wound completely healed, newly formed epithelium with subjacent primary blastems.
- 26a Newly formed syncytial epithelium one day after operation.
- 26b Amitotic division of epithelial nuclei.

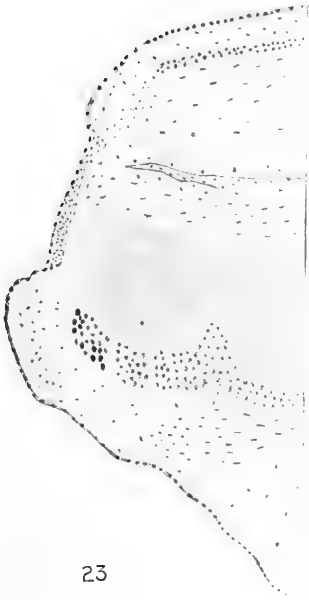

23



24



26a



26b

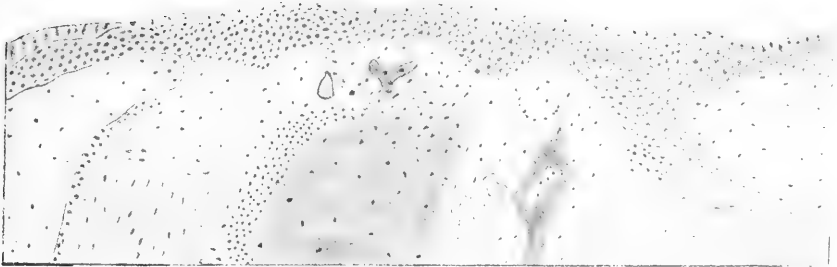

25

## PLATE 7

### DESCRIPTION OF FIGURES

- 27 Degenerating muscle fibers one and a half hours after operation.
- 28 Degenerating muscle nuclei.
- 29 Blood-corpuscles among degenerating muscle fibers and nuclear fragments ten hours after operation.
- 30 Sarcoblasts two days after operation.
- 31 Primary and second blastema.
- 32 Mitosis of sarcoblasts.
- 33 Formation of the sucker muscles eleven days after operation.
- 34 Invagination of a sucker three weeks after operation. Section made through the lowest newly formed sucker shown in figures 13 and 14.

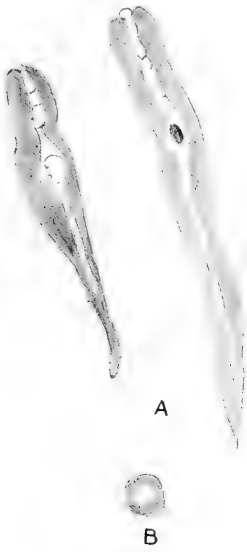

27

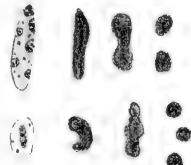

28

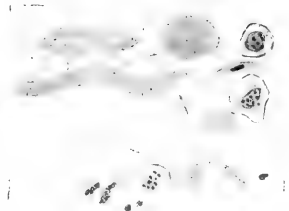

29

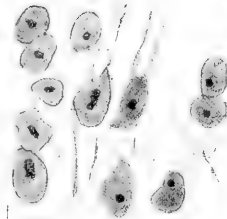

30

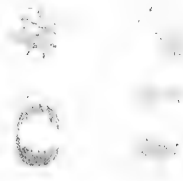

32

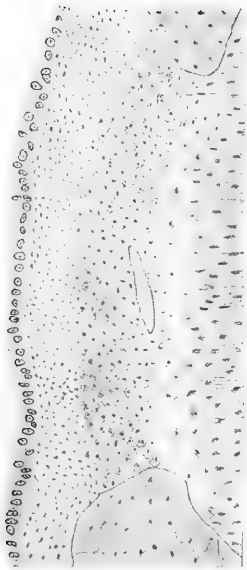

31



33

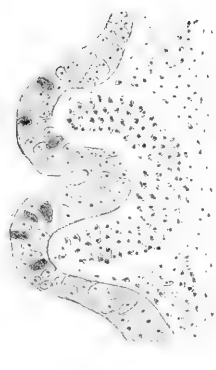

34

## PLATE 8

### DESCRIPTION OF FIGURES

35. Degenerating nerve nuclei one and a half hours after operation.
36. Inflated myelin fibers six hours after operation.
37. Increase of nuclei in the neuropil.
38. Tip of a regenerated piece three weeks after operation. Section made through piece shown in figures 13 and 14.
39. Nerve growing into the primary blastema. *a*, young nerve cell.





36

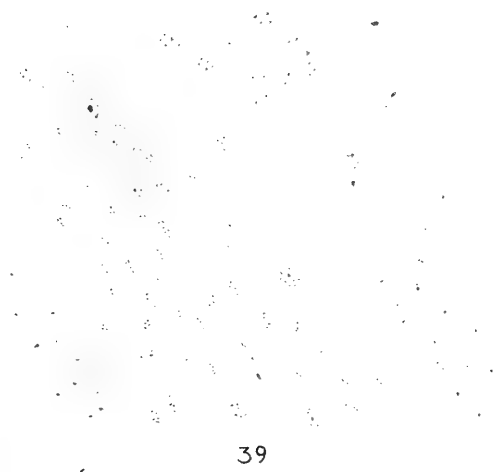
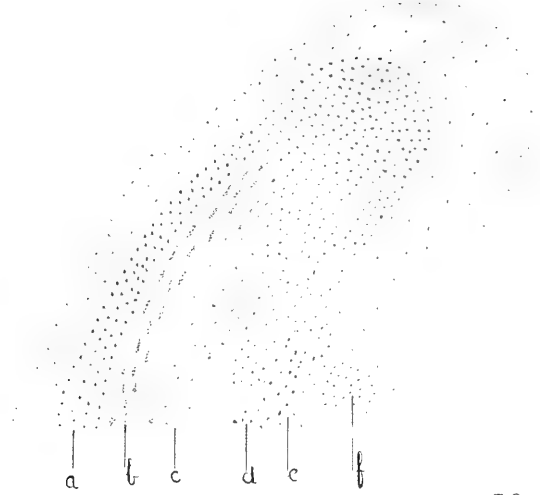

Resumen por el autor, W. H. Taliaferro.  
Universidad Johns Hopkins.

Reacciones de *Planaria maculata* a la acción de la luz, con especial mención de la función y estructura de los ojos.

1. El ojo de *Planaria maculata* consta de dos partes: las retículas y las células accesorias que forman la copa pigmentaria. 2. Los ejemplares normales son negativos a la luz y se orientan exactamente en un rayo luminoso horizontal. 3. Los ejemplares con ambos ojos extirpados son negativos a la luz, pero no se orientan. 4. Los ejemplares con un ojo extirpado no exhiben movimientos circulares. Se orientan como los ejemplares normales cuando se les ilumina el lado normal, pero no se orientan cuando la iluminación se dirige al lado "ciego," a menos que se muevan hasta recibir la luz en el ojo funcional. 5. Las reacciones de los ejemplares con un ojo normal y la mitad posterior o anterior del otro ojo extirpada se describen en el trabajo. 6. La extirpación de los ojos, a diferencia de lo que sucede al cortar el extremo anterior, no produce efecto sobre la marcha de la locomoción en la luz directiva o no directiva. 7. El ojo consta de dos regiones sensoriales localizadas; la estimulación de una e ellas causa el movimiento del animal en un sentido opuesto al ocupado por el lado que contiene el ojo, mientras que la estimulación de la otra produce el efecto opuesto. 8. Aunque el pigmento puede localizar a la estimulación fótica en cierto grado, probablemente no es el principal agente localizador de la estimulación fótica, como ha indicado Hesse. 9. La localización del estímulo luminoso está relacionada con la estructura y posición de los rabdomas. 10. Una vez que el animal se orienta en un rayo luminoso horizontal no recibe estimulación orientadora hasta que abandona el eje de orientación.

Translation by José F. Nonidez  
Cornell University Medical College, N. Y.

# REACTIONS TO LIGHT IN PLANARIA MACULATA,<sup>1</sup> WITH SPECIAL REFERENCE TO THE FUNCTION AND STRUCTURE OF THE EYES

W. H. TALIAFERRO

*Zoological Laboratory of the Johns Hopkins University*

EIGHTEEN FIGURES

## CONTENTS

Introduction.....	60
Material and methods.....	63
Structure of the eye.....	68
Orientation to light in normal specimens.....	72
Orientation to a horizontal beam of light.....	72
1. Extraneous reflexes during orientation.....	74
2. Character of turning in animals during orientation in different intensities of illumination.....	75
Function of the eyes.....	79
A. Reactions to light in specimens with both eyes removed.....	79
1. Character of reactions to light.....	81
2. Rate of locomotion.....	84
3. Discussion of experiments in relation to former investigations.....	86
B. Reactions to light in specimens with one eye removed.....	87
C. Localized sensory regions in the eye.....	93
1. Extent of localized sensory regions.....	93
2. Reactions to light in specimens with one eye and the posterior half of the other eye removed.....	98
3. Reactions to light in specimens with one eye and the anterior half of the other eye removed.....	101
D. Localization of photic stimulation.....	102
1. Mechanism of localization of photic stimulation.....	102
2. Localization of photic stimulation in relation to the structure of the eye.....	107
Nature of the stimulus during orientation.....	109
General summary.....	112
Bibliography.....	114

---

<sup>1</sup> Although there is some uncertainty as to the species of *Planaria* used in the experiments recorded in this paper, it has been designated *maculata*. This question is discussed on page 64.

## INTRODUCTION

In the extensive literature on the Turbellaria one finds rather detailed and careful studies concerning both the structure of the eyes and the reactions to light in various forms. In very little of this work, however, is there any attempt to coördinate the known histological details of the eye with the reactions to light. The chief object of the present paper is to ascertain in how far the function of the eyes in the reactions to light in *Planaria maculata* can be correlated with the histology of these organs.

One of the most important contributions to our knowledge of the turbellarian eye is Hesse's ('97) study of the structure of these organs. Hesse, working for the most part with certain triclads, found that all such eyes consist of two parts: first, the visual cells or retinulae, each of which possesses a typical nucleus and is extended distally to form a bulb-like rhabdome, and proximally to form a nerve process which enters the 'brain;' second, the pigment or accessory cells which form a more or less cup-shaped structure partially enclosing the rhabdomes or sensory area of the eye. He states that the number of retinulae, as well as of pigment cells, varies in different species from one to a large number. The triclads studied by Hesse were negative to light, and hence moved away from the source of stimulation. He maintains that this reaction is due to the fact that when an animal moves away from the light the sensory cells or rhabdomes are shaded by the pigment cup; whereas, when the specimen moves in any other direction the pigment cup does not shade all of the rhabdomes. When certain of the rhabdomes are illuminated, as in the latter case, the animal turns so as to bring the sensory region of the eye again into the shadow of the pigment cup. Hesse maintains that localization of the photic stimulus is the specific function of the pigment cup which enables the animal to direct its course away from the source of light.

In working on the eye of the rhabdocoele, *Prorhynchus applanatus*, Kepner and Taliaferro ('16) found that it consisted of one retinula associated with a unicellular pigment cup or accessory cell. Although the relation of these two elements is

exactly that found by Hesse ('97), they found that the retinula consists of three regions: 1) a lateral nucleus-bearing region which is closely applied to the 'brain' and extends as a nerve fiber into this organ; 2) a middle region which is lens-shaped and in both living and fixed material presents the structure of a highly refractive homogeneous body, and, 3) a mesial region or the true rhabdome which fills the pigment cup.

Kepner and Foshee ('17), in a further study of *Prorhynchus applanatus*, point out an interesting comparison between the three regions of the retinula in *Prorhynchus* and the retinula (rods and cones) of vertebrates. According to these authors, the nucleus-bearing region, the highly refractive region, and the rhabdome of *Prorhynchus* are analogous, if not indeed homologous with the myoid, ellipsoid, and rhabdome, respectively, in the rods and cones of the vertebrates. This comparison is especially interesting in that the retinula of both flatworms and vertebrates are of the inverted type.

Jänichen ('97) was probably the first to describe the middle region in the retinula of the turbellarian eye as a definite structure. He referred to it in *Planaria gonocephala* as the 'Zwischenstück,' but placed no emphasis upon it. Böhmig ('90) T. xxi, fig. 12) figures much the same type of structure in the rhabdocoele *Monoophorum striatum*, but does not mention it in his description. Also, in the eye of the polyclad *Pelmatoplana* as figured by Schmidt ('02) there is a body very much like the one under consideration, but it is considered by that author to be a nucleus.

No attempt will be made to review in detail the literature of the reactions of the Turbellaria to light. Such a review may be found in Walter's ('07) paper. We shall, therefore, confine ourselves to certain papers dealing with the functions of the eye. The first paper treating this specific subject is that of Loeb ('94), who maintains that decapitated specimens of *Planaria torva* react to light in precisely the same manner as normal specimens, but that the reactions are slower. He found, however, that the removal of the 'brain' and eyes of the polyclad *Thysanozoön brochii*, unlike *Planaria torva*, caused the animals to lose their responsiveness to light.

In the paper mentioned above, Hesse ('97) carried out similar experiments on *Planaria gonocephala* and obtained results which agreed with Loeb's work on *Planaria torva*, namely, that decapitated worms gave the same reactions to light as normal ones except that the reactions required more time.

Parker and Burnett ('00) made a much more comprehensive and thorough study of the same question, using more accurate methods and treating the results statistically. They used in their experiments *Planaria gonocephala*, and confirm in the main the results obtained by previous investigators both as regards the reactions of decapitated worms and the time required for such reactions.

In experiments on regeneration in *Dendrocoelum lacteum*, Lillie ('01) found, in harmony with the results obtained by Loeb in the polyclad *Thysanozoön*, that posterior headless pieces of this turbellarian do not react to light like normal specimens. He also maintains that any piece of a specimen of *Dendrocoelum lacteum* which is incapable of regeneration is, after a day or so, incapable of giving the normal responses to light.

Mast ('10), in a preliminary account of some experiments on a marine turbellarian, probably a triclad, found that these animals orient fairly precisely to a horizontal beam of light, but that they do not orient after the eyes have been removed by gouging them out with a scalpel.

From this short survey of the literature, we see that while the various descriptions of the structure of the turbellarian eye agree in all major details, the results of the work on the function of such eyes are so conflicting that it is almost impossible to draw any definite conclusions. The work of Loeb ('94) on *Planaria torva*, Hesse ('97) on *Planaria gonocephala*, and Parker and Burnett ('00) on the same form, indicates that the removal of the eyes affects the reactions to light very little except to make the reactions slower. Opposed to these results, the work of Loeb ('94) on *Thysanozoön brochii*, Lillie ('01) on *Dendrocoelum lactum*, and Mast ('10) on a marine form indicates that removal of the eyes results in the loss of the typical reactions to light. In all of this work, however, with the possible exception

of Mast, the technique employed was very crude. With this one exception the method of removing the eyes was to remove the entire head. The results of the present paper make it very doubtful if conclusions regarding the functions of the eyes can be drawn from the study of decapitated specimens.

The plan of the present paper is, first, to make a careful histological and cytological study of the eye in *Planaria maculata* and, second, with this anatomical background, to ascertain, by much more precise technique than used previously, the part played by the eyes in the reactions to light. This necessitated a study of the normal reactions to light. Similarly it led to a study of the mechanics of orientation to light in specimens which had one or both eyes removed and of specimens having one eye and a portion of the other eye removed. It also led to a study of the function of the pigment.

It gives me great pleasure to acknowledge my indebtedness to Prof. S. O. Mast, under whom the work was done, and to Prof. W. A. Kepner, of the University of Virginia, who, besides following the work with great interest, tendered many helpful suggestions and criticisms. Much valuable assistance was also received from Miss M. L. Dinwiddie, of the University of Virginia. The author is indebted to Dr. S. R. Detwiler, of Yale University, for the photographs in figure 7 and to Miss B. E. Stocking for the drawing in figure 13.

#### MATERIALS AND METHODS

All of the experimental work in this paper was done on a planarian found in abundance in an abandoned ice-pond near the University of Virginia. Collections were made by bringing roots, leaves, and debris from the margin of the pond and placing them in large aquaria filled with tap water. In such aquaria specimens begin to rise to the top in a few hours. They can then readily be removed with a section lifter. Although most of the experiments were performed on animals which had been freshly collected, it was found that they could be reared in the laboratory by keeping them in fresh spring water and feeding about once a week with finely teased *Tubifex*.

The planarian referred to above belongs to the genus *Planaria*, but as to the species there is some question, owing to the fact that the reproductive organs were not observed and that in these organs are found the chief characteristics which at present determine the species. Specimens have been collected from the same locality, at irregular intervals, by Professor Kepner for nine years and by the author for five years. In spite of these repeated attempts, no sexually mature animals have been obtained. Moreover, specimens have been reared in the laboratory and kept under almost constant observation for nearly two years. During this period the animals reproduced solely by asexual fission.

In an earlier report of this work ('17) the planarian under consideration was considered a new species. At the present time, however, the writer is of the opinion that it is so closely related to *Planaria maculata* Leidy, that it may be considered a variety of this species. In shape, size, general color, and normal fission, it agrees very well with the description given by Woodward ('97) Curtis ('02), and Bardeen ('01) for *Planaria maculata*. In color it is, however, very much more variable than *maculata*, judging from the descriptions, of this species, extending from an almost gray through brown to almost black. There are also other respects in regard to which the specimens under consideration do not agree with the descriptions of *Planaria maculata*. Most prominent among these is the structure of the enteron. The descriptions indicate that the enteron of *Planaria maculata* has many anastomosing diverticula. In the planarian used in these experiments there are relatively few, certainly far fewer than are shown in the figures of Curtis ('02). There is also a marked difference in the reactions. The planarians used in this work oriented to light very much more precisely than did specimens which agree more closely with the description of *Planaria maculata* obtained from other localities.

In operating, three methods for quieting the worms were found useful; viz., lowering the temperature with a salt-and-ice mixture, adding a few crystals of chlorotone to the water, and treating the animals with carbon dioxide. Of these three methods, the



last was used with the greatest success. A specimen to be operated on was placed under a binocular in a flat dish containing a layer of paraffin on the bottom. All of the water was then drawn from the specimen with a small pipette and the animal quickly covered with carbonated water from a siphon bottle ordinarily used in making carbonated drinks. In twenty to thirty seconds the animal thus treated usually becomes motionless. The carbonated water was then drawn off and the specimen operated on. As soon as the operation was complete, the planarian was removed and placed in a numbered aquarium filled with fresh spring water, where it was kept for observation. The practice of drawing off all of the water just before operating is essential, as it causes a secretion of mucus which holds the animal fairly fast to the substratum. This mucus adheres more strongly to paraffin than to such substances as glass.

The operations made consist largely of removing eyes, making incisions, and cutting off various parts of the body. The instrument used in making these operations consisted of a fine knife made by breaking a diagonal piece from a Gillette safety-razor blade. This was then placed in a wooden handle and carefully ground on the back to a fine point. With careful manipulation one can run such a knife under the eye of a planarian and remove it without appreciably disturbing any of the surrounding tissue. Parts of an eye can even be removed without destroying the capacity to function of the remainder of the organ.

In making delicate operations upon planarians it was soon recognized that there was no way of accurately estimating the injury from the operation in the living specimen. For this reason each animal, after being experimented upon, was carefully fixed and sectioned to ascertain the extent of the injury to the various organs. In this as well as in the general histological work several fixing fluids were used, such as Flemming's stronger solution, Bouin's fluid, Worcester's fluid, and various corrosive-sublimate mixtures. In practically all cases, however, the best results were obtained with a chromo-aceto-formalin mixture used by Kepner and Taliaferro ('16) in working with *Rhabdocoeles*. One very desirable characteristic of this fluid is that it kills so

rapidly that no anesthetic is necessary to obtain animals fixed free from contortions. In the general histological work iron haematoxylin with Bordeaux red, and Mallory's connective-tissue stain were used. For ascertaining the amount of injury due to the operations, by far the most useful was Mallory's connective-tissue stain. For general purposes this stain was used almost exclusively.

The apparatus used for observing the orientation of animals in a horizontal beam of light was essentially like that used by Mast ('11) and a number of other investigators (fig. 1). The apparatus was so constructed that two horizontal beams of light intersected at right angles in the aquarium in which the observations were made. Either beam could be eliminated and the one eliminated could be changed almost instantly by means of a double-throw switch (fig. 1, *K*). Each beam of light was produced by a 125-watt gas-filled lamp (fig. 1, *L*) which was housed in a well-ventilated, light-tight box and properly screened. Each of these boxes was placed on a graduated track along which they could be moved. The distance of the light source and hence the intensity of illumination could thus be varied at will. Each beam of light after leaving the aperture in its box was passed through distilled water (25 mm.) to remove the heat-waves, and was then so screened as to permit practically nothing but parallel rays to strike the animals (fig. 1). The heat-waves were of course further absorbed by passing through the water of the aquarium in which the animals were placed. The stand on which the aquarium rested was of the same height as a microscope stage, so that in carefully observing the path of an animal a microscope with a camera-lucida attachment could be substituted for the stand. When a microscope with a camera lucida was used, a small drawing-board was placed beside the microscope (fig. 1, *C.*), and illuminated by a small light which was so secured that no light could strike the animals under observation. In tracing the paths of specimens with a microscope and camera lucida, it was found advisable to use very low magnifications. The use of very low objectives ( $\frac{1}{2}$  inch) and eyepieces not only permitted the observation of specimens over a greater range, but it also

obviated the necessity of providing any vertical illumination for the microscope, the horizontal beam of light used in the experiment being quite sufficient. Had it been necessary to use verti-

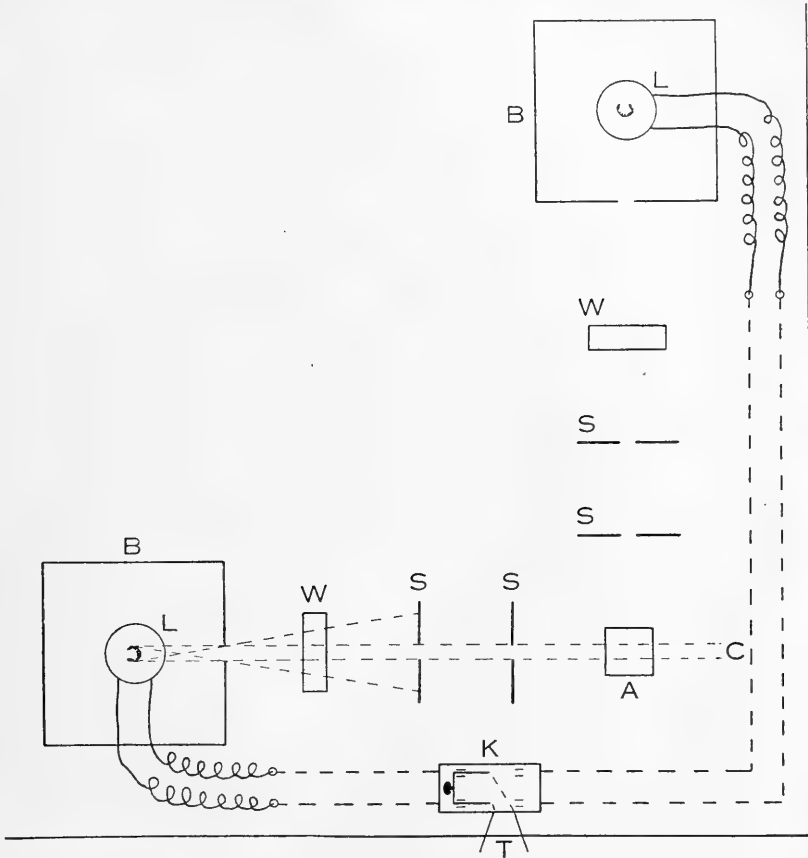

Fig. 1 Diagram of apparatus for observing reactions of *Planaria* to a horizontal beam of light. A, aquarium; B, lamp boxes which can be moved toward and away from the aquarium; C, position of drawing-board when camera-lucida is used; K, double-throw, double-pole knife switch; L, 125-Watt gas-filled lamp; S, screen; T, wires to wall tap; W, distilled water.

cal illumination, it might have introduced an extraneous factor in these experiments.

The aquaria in which the animals were observed were rectangular. They were made of plate glass and Kotinsky cement.

The use of such aquaria is essential, as it is practically impossible to control the path of the rays of light after being refracted by the irregular curved sides of the ordinary aquarium. All observations were made in a dark room and, as far as possible, all apparatus was painted dull black so as not to reflect light.

The apparatus used for measuring the rate of movement in specimens was essentially like that of Walter ('07, p. 55). The animals were placed in an aquarium which was held a few inches above a table by means of a burette stand and clamp. A pantograph was then so arranged that the style on the tracing arm was directed upward and could be moved beneath the aquarium. Care was always taken not to allow the tracing style to come in contact with the aquarium, as the consequent jarring causes a disturbance in the reactions of the specimens. A pencil in the remaining arm of the pantograph was directed downward and placed in contact with a sheet of paper on the table. By means of the style, a given worm could be followed and the path recorded. All such paths were made at a magnification of two diameters to facilitate measuring. After the path of a specimen was recorded for a definite number of minutes it was measured with a chartometer. In this way the character as well as the length of the path was ascertained.

#### STRUCTURE OF THE EYE

According to all of the recent descriptions of the structure of the turbellarian eye, it contains two regions—a pigment-cup formed by the pigment or accessory cells and a sensory region composed of visual cells or retinulae. As has been previously stated, a careful study of the retinula has shown in at least one form, *Prorhynchus applanatus*, that it is composed of three regions—the nucleus-bearing portion, a central highly refractive lens-shaped portion, and the true sensory portion or rhabdome. These three regions bear a striking resemblance to the three regions of the rods and cones in the vertebrate eye, i.e., the myoid, ellipsoid, and rhabdome, respectively. The comparison is of especial interest in that the retinulae in both groups of animals

are of the inverted type and, hence, the arrangement of the three regions in relation to the entrance of the stimulating light is the same.

The eyes of *Planaria maculata* appear as two small conspicuous dark spots on the anterior, dorsal surface of the animal near the median line. Each eye lies directly over, and near the anterior margin of a dorsal ganglion. The pigmented regions constitute the pigment-cups. The opening of each pigment-cup is directed laterally, anteriorly, and slightly dorsally. It is formed by a single layer of pigment or accessory cells (fig. 2, *A*). By referring to figure 2, it may be seen that the pigment of the pigment-cup is in the form of granules and that these are represented as being concentrated at the inner surface of the accessory cells. It has, however, been repeatedly observed that these granules of pigment are concentrated at the inner surface of the pigment cell only after the animal has been exposed to long-continued illumination and that in darkness they tend to become scattered through the entire cell.

The cavity of the pigment-cup is filled with the distal end of numerous retinulae (fig. 2, *R*). The number of these retinulae in any given eye has not been precisely ascertained, but it is approximately two hundred. Each retinula consists of three regions—a rhabdome, a central highly refractive region, and a nucleus-bearing portion (fig. 3, *C*). The rhabdome and central region constitute the portion of the retinula surrounded by the pigment cup. The nucleus-bearing portion is in reality a nerve-like fiber which extends from the central region of the rhabdome through the opening of the pigment cup to the 'brain.' Some distance from the cup there is an enlargement in the fiber which contains the nucleus.

The three regions of the retinula are differentiated very distinctly in material stained with Mallory's connective-tissue stain. The rhabdome, which is situated next to the wall of the pigment cup, shows numerous radiating striae (fig. 2, *S*). The striae all radiate from the central region, which is a clear, more or less spherical body. This region (fig. 2, *m*) stains bright orange, while the rest of the retinulae, with the exception of the nucleus,

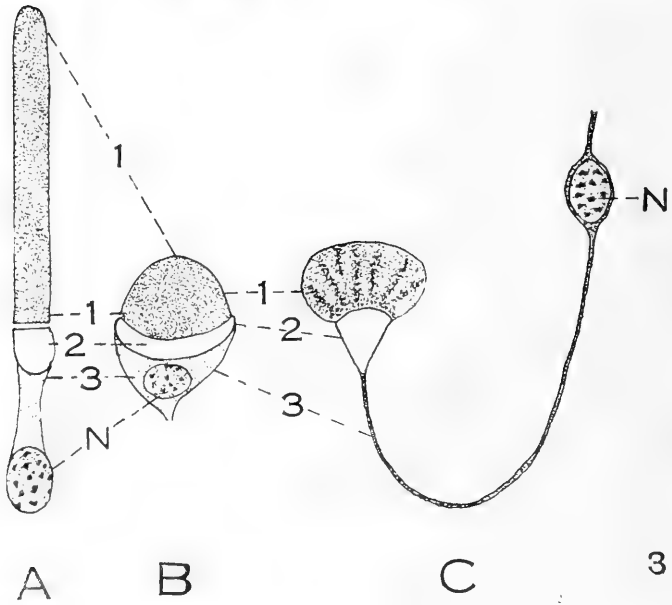
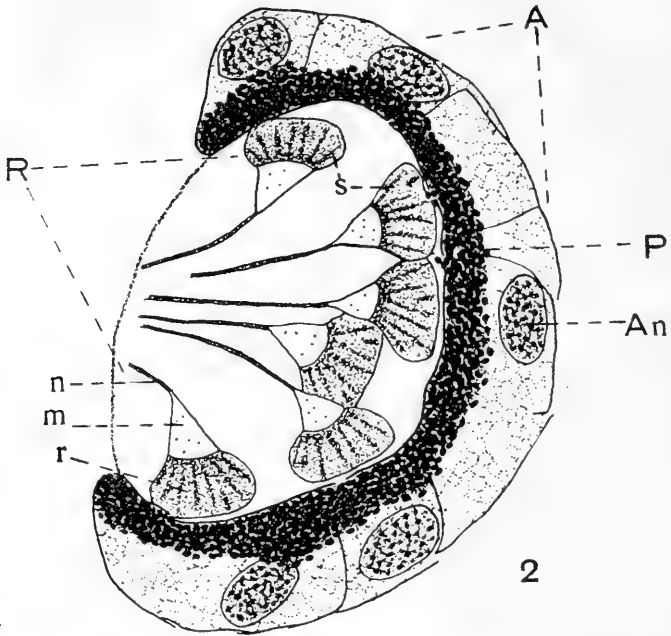

stains blue. In fixed material this region is optically the densest portion of the retinula. No special structure can be distinguished in the third or nucleus-bearing region except the nucleus. This is large and approximately spherical (fig. 3, *C, N*). Its general appearance, as well as its staining reactions, indicates that it is a modified nerve element.

All of the fibers of the nucleus-bearing region issue from the pigment-cup at the anteriolateral margin of the opening. The position of these fibers was later found of great importance as any injury to the anterior part of the eye destroys the function of the entire organ by destroying them.

From this description it is evident that the retinula in *Planaria maculata* is very much like the retinula in *Prorhynchus applanatus* and the regions found in it are similar to the rhabdome, ellipsoid, and myoid of the vertebrate rods and cones, just as Kepner and Foshee ('17) maintain for *Prorhynchus applanatus* (fig. 3). A similar differentiation has been described by Kepner and Lawrence ('18) in the retinula of *Polycystis goettei*.

The discovery of this analogy or, possibly, homology of the parts of the retinula of the rhabdocoele eye with the parts of the vertebrate eye is very significant, for it strongly supports the contention of some observers that the simple chordate eyes of *Branchiostoma* are homologous with the flatworm eyes. It is, however, questionable whether organs of two groups of animals as far removed as are the Platyhelminthes and chordates can be homologized.

Fig. 2 Camera-lucida drawing of a transverse section of the eye of *Planaria maculata*.  $\times 1500$ . *A*, accessory cells; *An*, nucleus of accessory cell; *P*, pigment-cup containing visual cells or retinulae, some of which have been omitted; *R*, retinulae; *r*, rhabdome; *s*, striae in the rhabdome; *m*, middle region of the retinula; *n*, portion of the nucleus-bearing region of the retinula (the nucleus as well as the greater part of this region lie outside of the pigment-cup and are not shown in the drawing).

Fig. 3 Diagram representing analogous structures in the retinulae of vertebrates and flatworms. *A*, retinula (rod) of frog (after Kepner and Foshee, '17, from Arey, '16); *B*, retinula of *Prorhynchus applanatus* (after Kepner and Foshee, '17); *C*, retinula of *Planaria maculata*. Line 1 indicates the rhabdomes of the three retinulae; line 2 connects the ellipsoid of the frog with the analogous parts of the retinulae of *Prorhynchus* and *Planaria*; line 3, the myoid; *N*, nuclei.

## ORIENTATION TO LIGHT IN NORMAL SPECIMENS

With the exception of a few forms like *Bdelloura*, all of the species of triclads whose reactions to light have been studied are negative. The earlier investigators, Loeb ('93, '94), Hesse ('97), Parker and Barnett ('00), maintained that the species worked on do not orient to the direction of the rays of light to any marked degree, but simply tend to come to rest in the areas of least intensity. Later investigators, however, Walter ('07) and Mast ('10), found evidence of fairly precise orientation.

*Orientation to a horizontal beam of light*

*Planaria maculata* moves over the substratum with an even, gliding motion. During this process the anterior tip of the head as well as the cephalic lobes are considerably elevated above the rest of the body. There is no continual pronounced side-to-side movement of the anterior end. A given specimen may, however, at irregular intervals raise the anterior end and wave it from side to side, but this reaction usually continues only for a brief interval, after which the animal resumes its normal gliding course. This 'waving' reaction is what Walter ('07, p. 49) has termed 'wig-wagging movements.' He considers 'wigwagging movements' as attempts "on the part of the worm to become adjusted to the stimuli acting upon it." Another movement of this general character which I have designated as the 'twisting reflex' will be taken up later.

A specimen which is illuminated by light from a single source moves fairly directly away from the source. If, after such a specimen has become oriented in a horizontal beam of light, it is illuminated laterally by a sudden change in the direction of the rays through 90°, it usually turns directly away from the source of light, without preliminary trial movements, as indicated in figures 4 and 5. By referring to figure 4, which is a camera-lucida drawing, it will be seen that, in this experiment, the direction of the rays was changed five times and that the planarian turned directly from the light each time without trial movements. Approximately ninety camera-lucida drawings representing the



effect of changes in the direction of illumination and the reactions of planaria were made. All of these are essentially the same as the one reproduced in figure 4. Moreover, the process of orientation was observed on many other occasions and it was found

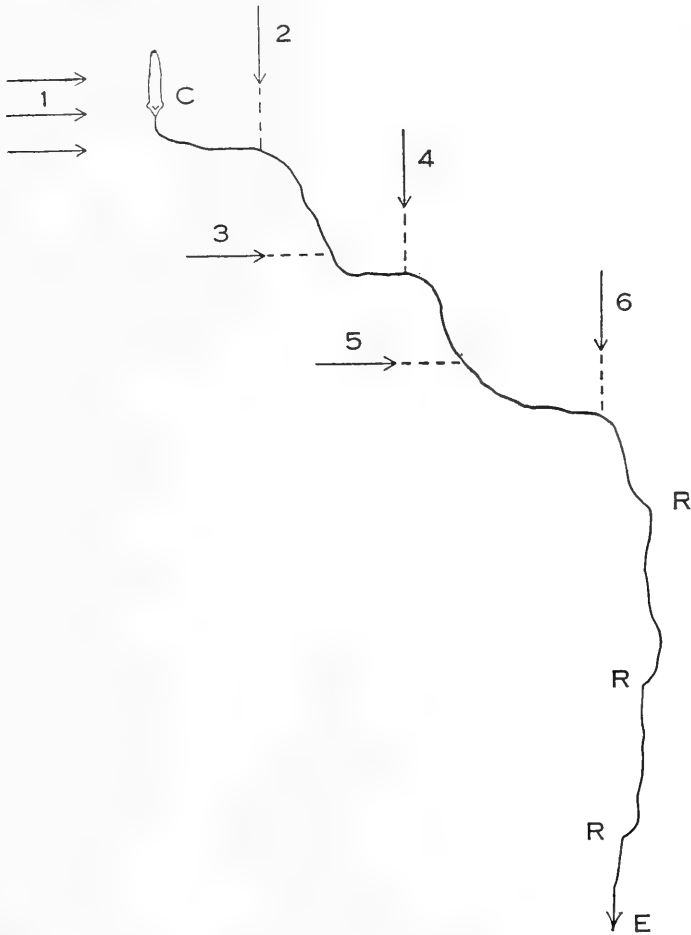

Fig. 4 Camera-lucida drawing of the path of a Planarian, showing the relation between changes in the direction of illumination and the direction of locomotion. *C-E*, path of specimen; *R*, point at which wandering reflex took place. Arrows *1 to 6* indicate successive directions of rays of light. *Dotted lines* extending from the arrows *2 to 6* indicate the position of the planarian on its path when the direction of the rays was changed.

that the planaria practically always turned directly from the light without trial movements.

1. *Extraneous reflexes during orientation.* After a given specimen is oriented and is proceeding away from the source of illumination there are a number of different motor activities that can be noted. Two of these, although they do not seem to play any

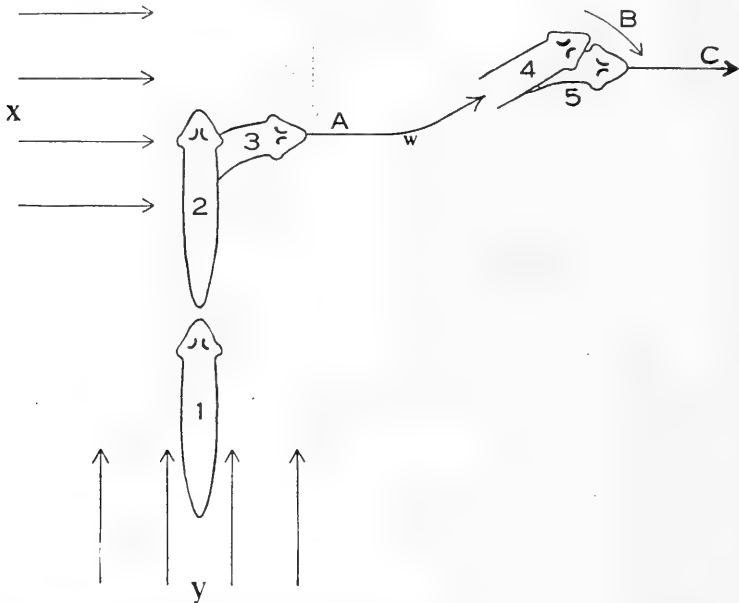

Fig. 5 Diagram representing orientation to light in normal specimens and 'wandering reflex.' The arrows *x* and *y* indicate the direction of the rays of light. *A*, *B*, and *C*, indicate path of specimen. 1, 2, 3, 4, and 5, successive positions of specimen; *w*, point of beginning of 'wandering reflex.' When specimen reached position 2 the light *y* was intercepted and light *x* turned on.

significant part in the normal process of orientation, will be described here because they later become of great interest in other reactions to light. The first of these I have designated the 'wandering reflex.' After an animal is oriented, it takes a fairly straight course for a certain distance (1 to 4 cm.), then it begins to wander toward the right or left. If the animal in this wandering turns far enough to allow the rays of light to enter the pig-

ment-cup of the eye, it suddenly reorients and again proceeds directly from the source of stimulation as represented in figure 4, *R*. In referring to this figure one might ask why this 'wandering reflex' with the subsequent reorientation occurred only after the direction of the rays was changed at 6 and not after the preceding changes. The answer to this lies in the fact that after the preceding changes in the direction of the rays the animal was not allowed to proceed far enough, for, as previously stated, the animal always proceeds a certain distance before the wandering commences. In practically all of the numerous records made of the orientation to light in *Planaria maculata* this wandering reaction and reorientation occurred one or more times.

The wandering of specimens from the path of orientation and the subsequent reorientation as soon as the animal turns enough to let the light rays enter the pigment-cup suggests strongly that once an animal is oriented it receives no orienting stimulation unless it leaves the path of orientation. This will be considered in detail in another section.

The second type of reaction alluded to above has been designated the 'twisting reflex.' Whenever a planarian is proceeding from a source of light, it pauses at irregular intervals and twists the anterior end so that the ventral surface tends to be directed upward. Under strong illumination this response is exhibited at intervals of approximately 3 to 4 cm.

It is interesting to note that decapitated specimens never give the twisting reflex. When the anterior ends of such specimens are allowed to regenerate, this reflex is not exhibited until after the anterior end is almost fully developed. From a study of the sections of such animals, considerable evidence was obtained indicating that it is necessary for the regeneration of the 'brain' to be practically complete before the twisting reflex occurs.

Neither the twisting reflex nor the wandering reflex apparently plays any significant part in the normal process of orientation, but, as we shall see later, both play a paramount rôle in the orientation of forms with one eye removed.

2. *Character of turning in animals during orientation in different intensities of illumination.* In the description of the orientation

of normal animals to a horizontal beam of light, it was noted that animals usually turn directly away from the light without any preliminary trial movements. This is certainly true in the majority of cases. A study of orientation in different intensities of illumination, however, reveals, among other things, that a given specimen may even turn first toward the light and then away from it.

If the lateral illumination is of a very low intensity, the animal orients by describing a rather broad arc of a circle with barely any perceptible bending of the body. If the intensity is somewhat higher, the animal does not describe this arc, but turns its head directly away from the source of stimulation, making a rather sharp angle in the contour of its body just posterior to the cephalic lobes. As the light intensity is increased, the animal still bends its head away, but the angle, i.e., the point of bending, becomes situated more and more posteriorly until it reaches the region of the pharynx. When the animal bends its body in the region of the pharynx, as it does only under the influence of very intense light, a peculiar reaction takes place. The specimen raises the anterior half of the body and violently turns it, first toward the light, then in the opposite direction until it faces directly away from the light, after which the head is lowered and the animal proceeds as usual. The reaction of turning the head first toward the light and then away under the influence of strong stimulation will be taken up later.

In studying the relation between the character of turning during orientation and the intensity of the light, no attempt was made to measure accurately the illumination because of the great individual variation and the great variation in the same specimen at different times. Then, too, in working continuously with a given animal, it becomes more and more indifferent to stimulation by light. The following detailed description will illustrate the character of the results obtained in all of the numerous observations made.

On September 7, 1916, a specimen tested two hours after collecting described a rather broad arc of a circle in orienting in an illumination of 52 meter-candles (fig. 6, A). When the

specimen was then illuminated laterally with stronger light, viz., 75 meter-candles, the animal bent its body in the region just posterior to the cephalic lobes, thus turning the anterior end sharply away from the light. The point of bending occurred somewhat farther back (fig. 6, *B*) when the animal was subjected to a lateral illumination of 208 m.c. When the lateral illumi-

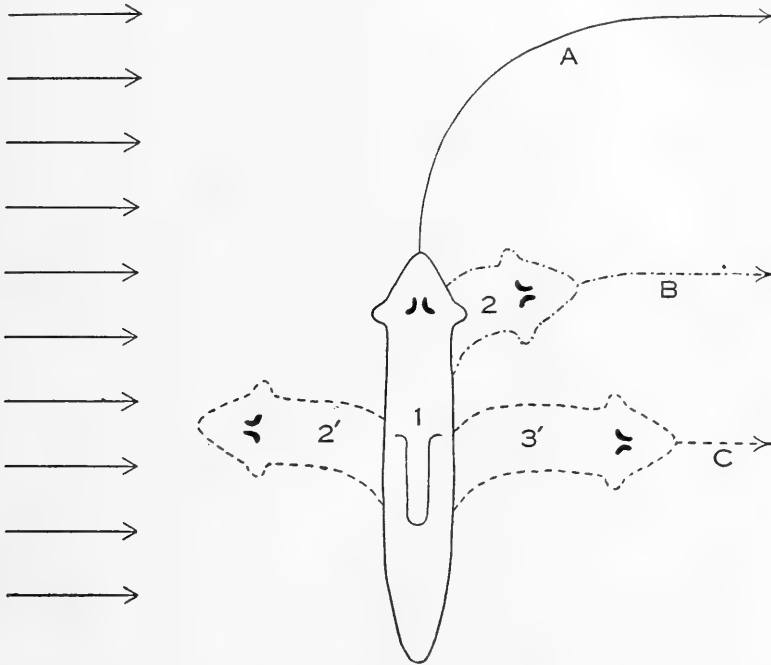

Fig. 6 Diagram representing orientation of planarians in different illuminations. Arrows indicate the direction of light. *A*, path of specimen in 52 meter-candles; *B*, path of specimen in 208 m.c.; *1*, *2*, successive positions of specimen; *C*, path in 3328 m.c., *1*, *2'*, *3'*, successive positions of specimen.

nation was increased to 3328 m.c., the bending occurred in the region of the pharynx, but first toward and then away from the light, and the reactions were very violent (fig. 6, *C*).

These observations on the character of turning in specimens under the influence of increasing intensities of light are interesting when considered in relation to the nature of the nerve impulse from the eye to the musculature which causes the bending. When

a planarian bends its body in a lateral direction, this can be conceived to take place either by a lengthening of the side toward the light or by a contraction of the side opposite the light, or possibly both. If the animal bends by lengthening one side, this is probably due to a contraction of the dorsoventral muscles of that side. This contraction would tend to flatten the body in a given region and hence elongate its contour. On the other hand, a contraction of one side would most likely be due to a contraction of the longitudinal muscles of that side. Pearl ('03) is of the opinion that in planaria while turning away from mechanical stimulation, this turning is due to a contraction of the dorsoventral muscles and, in consequence, to an elongation of the side away from the bending. In numerous experiments along this line, the author has been unable to satisfy himself as to which is true in orientation to light. The nerve fibers leading from the eye of a planarian must be connected indirectly with a rather complex system of muscles along either or both sides of the animal. In an animal under comparatively weak stimulation, the nerve impulse most likely is transmitted to a rather localized region of the musculature, viz., to a region near the cephalic lobes. The fact that the point of bending gradually moves posteriorly as the stimulation increases strongly suggests that in such cases there is a greater and greater spread of the nerve impulse along the musculature of a given side as each successive increase in the stimulation takes place. This assumption of course, would not explain the reaction of bending first toward and then away from the light under the influence of very intense illumination. It is likely that the latter involves a different neuromotor mechanism, possibly analogous to protopathic stimulation in the vertebrate eye. In the human eye, for example, an intense illumination often involves a protopathic sensation entirely aside from the usual sensation of light. In this case the protopathic sensation involves a different mechanism than the usual sensation of light; it may, in fact, be invoked in a totally blind person (Sherrington, '98, page 967).

The reaction of bending the anterior end first toward and then away from the light is very similar to that described by

Pearl ('03, p. 580) as a result of continued strong mechanical stimulation. He believes that "It indicates the effect of the organism as a whole on its reflexes." Boring ('12) has observed similar reactions in *Planaria torva* after continued directive illumination. He (p. 241) believes that—

It is quite conceivable that the abrupt reversal of directions for brief periods, the 'wild jumps,' are forms of a compensatory movement, which acts as a relief, not for the continued stimulation, but for the continued movement away from the stimulus. . . . It is quite possible that these muscles (i.e., the ones which steer the animal to one side) after the continued contraction involved in prolonged movement to one side, become cramped, and there follows what is probably a natural physiological coördination, when the muscles on the other side contract suddenly and strongly, stretching the fatigued muscles.

Both of the investigators quoted above observed the bending of the animal first toward and then away from the stimulated side only after long-continued stimulation. While this reaction certainly does follow long-continued stimulation, I am not certain, judging from the results of numerous observations, that it is necessarily preceded by continued stimulation. When an animal is very strongly illuminated this reaction will follow immediately even though the animal has been previously subjected to very little photic stimulation. Such reactions unquestionably occur in earthworms and fly larvae immediately after stimulation. It is hoped that this matter can be taken up later in more detail. It would raise some interesting questions if short strong stimulation produced the same effect as long-continued weak stimulation.

#### FUNCTION OF THE EYES

##### *A. Reactions to light in specimens with both eyes removed*

The majority of investigators who have worked on the question of the function of the eyes in planarians have reached the conclusion that these organs play very little part in the character of the responses to light. Thus, as previously stated, Loeb ('94), Hesse ('97), and Parker and Burnett ('00) maintain that decapitated planarians react essentially the same as normal specimens, but that all reactions require considerably more time.

In experiments on decapitated and normal *Planaria torva*, Parker and Burnett concluded (p. 385):

Planarians without eyes react to the directive influence of light in much the same way as those with eyes, in that they have a tendency to turn away from the course when directed toward the source of light and to keep in it when directed away from the source, though with less precision and often to less extent than planarians with eyes.

Planarians with eyes move more rapidly (1.12 mm. to 1.04 mm. per sec.) than those without eyes (0.89 to 0.82 mm. per sec.) and those moving away from the light (1.12 mm. and 0.89 mm. per sec.) than those moving toward it (1.04 mm. and 0.82 mm. per sec.)

Opposed to these results we find that Lillie ('01) maintains that posterior headless pieces of *Dendrocoelum lacteum* do not exhibit the usual responses to light. Also, Mast ('10) maintains that an undetermined marine turbellarian with the eyes removed fails to orient to a horizontal beam of light, while normal specimens orient fairly precisely.

The present experiments on the reactions of specimens with both eyes removed were designed to answer two questions: 1. Does removal of the eyes affect the character of the responses to light? 2. Does removal of the eyes affect the rate of locomotion?

The animals used in these experiments were anesthetized and their eyes cut out in the manner described in the section on methods. After each animal was operated on, it was allowed approximately twenty-four hours to recuperate. If, after this time, the animal showed any distortion about the head it was discarded. Then, as a further check, each animal was, after the experiment, fixed, sectioned, and stained. These sections were carefully examined, and the records of any animal were discarded if the sections contained any trace of the eye which was removed or if there was any deep cut into the 'brain.'

By using this technique it is surprising how neatly a small organ like the eye can be removed. In successful operations, the only noticeable difference from normal specimens besides the absence of the eyes is a slight dislocation of the pigment of the body surface in this region (fig. 7). In some cases even this cannot be detected. The sections, in the majority of cases, revealed the fact that the 'brain' had not been cut at all in the



removal of the eyes. Throughout this series of experiments it was found essential never to use specimens which showed any distortion of the head. Such distortions are often followed by abnormal motor activities.

1. *Character of reactions to light.* Specimens with both eyes removed move about essentially like normal specimens. They exhibit the twisting reflex (p. 75) and occasional 'wigwagging movements' (p. 72) just as do normal specimens. When observed in non-directive light, no difference can be observed between them and normal specimens in either the rate or nature

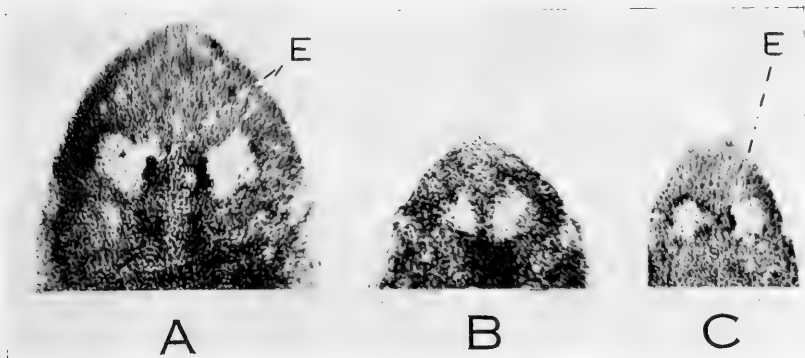

Fig. 7 Photographs from unretouched negatives of normal and operated specimens. All magnified 30 diameters. *A*, normal specimen; *E*, eyes; *B*, specimen with both eyes removed; *C*, specimen with left eye removed; *E*, eye. Note the lack of distortion in those specimens which have been operated on.

of locomotion. This is in marked contrast to the behavior in decapitated worms.

Although no difference can be detected between the reactions of normal specimens and specimens with both eyes removed when in non-directive light, this is not the case when observed in directive light. Specimens with both eyes removed do not orient to a horizontal beam of light as do normal specimens. This is well illustrated in the following detailed description of one of the twenty experiments made, the results of which are essentially the same,

The specimen used in this experiment was first tested in a horizontal beam of light in which it was found to orient very precisely. The animal was then anesthetized with  $\text{CO}_2$  and both eyes removed. Twenty-four hours after the operation, the animal was again tested and its movements traced with a camera lucida. This tracing is reproduced in figure 8. At the beginning of the experiment, the animal was laterally illuminated and it proceeded for a short distance at right angles to the rays of light and then turned directly toward the light. Movement in this direction continued for only a short distance, when it turned again and proceeded in a diagonal path away from the light. This path soon led out of the beam of light into the shadow. Twice as the animal attempted to proceed from the shadow back into the light it hesitated, and after a sort of 'avoiding reaction' proceeded back into the shadow (fig. 8, 1 and 2). The third time it came to the margin between the light and the shadow it passed into the light without any perceptible reaction. The direction of the light was now changed through an angle of  $90^\circ$  (fig. 8, P). The animal described a very irregular course away from the second light source. While proceeding away from this source it again moved from the illuminated region into the shadow and vice versa on two separate occasions, with no apparent reaction (fig. 8, 3 and 4.). After these observations were made, the animal was fixed, sectioned, and stained. A study of these sections revealed that the eyes had been entirely removed and that there was no apparent injury to the 'brain' or other organs.

If, now, the reactions of this specimen in a horizontal beam of light are compared with those of normal specimens in similar illumination, it becomes evident that orientation is dependent upon the eyes. This conclusion is, moreover, strongly supported by the fact that blind specimens again orient precisely after the eyes regenerate.

Although the eyes are clearly functional in orientation, the evidence at hand indicates that there is in eyeless specimens at times some indication of a slight orientation to the rays of light. The question then arises as to what factors are involved in the slight tendency toward orientation in these specimens. The an-

swer to this, I think, lies in the fact that, while the posterior end of the animal is sensitive to light, the anterior end, exclusive of the eyes, is more so.

In regard to the anterior end, regardless of the eyes, being more sensitive to light than the posterior, Walter ('07, p.123) says:

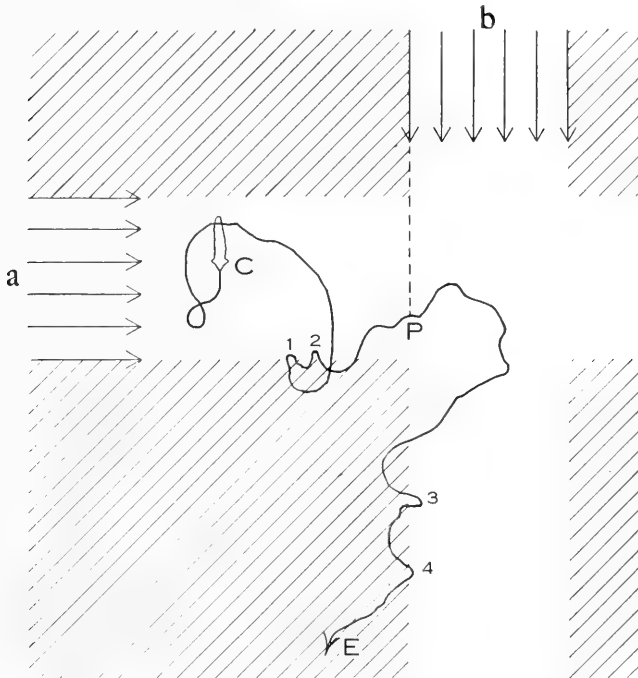

Fig. 8 Camera-lucida tracing of the path in a horizontal beam of light of a specimen with both eyes removed. Arrows *a* and *b* indicate the direction of the rays of light. *C-E*, path of animal. When the animal reached the point *P*, light *a* was turned off and light *b* was turned on. At points 1 and 2 the animal gave a kind of 'avoiding reaction.' This did not occur at 3 and 4.

Again, when a small beam of sunlight passing through a pinhole in an opaque screen was directed locally to different parts of a gliding *Planaria maculata*, it was found that tropic response would occur in case one side of the anterior end was illuminated, and that it was not necessary for the eye itself to be included in the illuminated area to obtain such responses. However, when the middle of the body or the posterior end was similarly stimulated the worm could not be made to turn.

As it is very improbable that the anterior end of a planarian can be illuminated without allowing a certain amount of light to enter the eyes, Walter's experiments were repeated, using, however, specimens the eyes of which had been carefully cut out, and a horizontal beam of light instead of the localized point as in the above experiments. It was found that if a beam of light was thrown laterally on the anterior end of such a worm, it turned away from the source of light in the majority of cases. It is important to notice, however, that this turning was not nearly so definite or precise as in the case of animals with eyes. A given specimen very often turned toward the light, swerving all the way around and thus proceeded away from the source of stimulation. The turning of such eyeless specimens was much more indefinite if the entire animal was illuminated instead of the anterior end.

As the anterior end is more sensitive to light than the posterior, the animal would most likely maintain a position in regard to the light source such that the posterior end would shade the more sensitive anterior end. Such a position would tend to keep the animal directed away from the light and would explain the slight tendency to orientation observed in such specimens. It must not be supposed, however, that all of the reactions of specimens without eyes can be ascribed to this differential sensitivity of the anterior and posterior regions because a decapitated worm still proceeds, in general, away from the light. Although this is true, a decapitated worm does not show the slight tendency toward orientation such as is found in animals with both eyes removed.

2. *Rate of locomotion.* As pointed out above, no difference in the rate of locomotion can be observed under ordinary conditions between normal specimens and those which have had both eyes removed. In order to test this accurately, however, the following experiments were devised, using both directive and non-directive illumination. The non-directive illumination was furnished by placing a 125-watt gas-filled lamp 30 c.m. above a circular aquarium in which the animals were moving. The directive light was furnished by the same apparatus used to test

the reactions of specimens in a horizontal beam of light. In both cases the rate of locomotion was determined by means of a pantograph previously described in the section on methods.

Ten normal specimens were placed in a dark room for twenty-four hours and then their rate of locomotion both in directive and non-directive illumination was ascertained. Throughout the experiment the animals were kept in the dark when not being observed, so as to keep the preliminary light environment as nearly constant as possible. After the rate of locomotion for the ten normal specimens had been ascertained, both eyes were

TABLE 1

*The effect on the rate of locomotion of removing only the eyes as compared with the effect of removing the entire anterior end*

	AVERAGE RATE OF LOCOMOTION IN MILLIMETERS PER SECOND		NUMBER OF TRIALS
	Directive light	Non-directive light	
Ten normal specimens.....	1.18	1.11	40
The same with both eyes removed:			
1) Two hours after removal of eyes.....		1.25	39
2) Twenty-four hours after removal of eyes.....	1.10	1.08	55
The same with anterior end removed:			
Twenty-four hours after operation.....	0.62	0.71	45

removed from each specimen and, after twenty-four hours, their rates of locomotion were again measured. In the case of non-directive illumination, the rate of locomotion was also obtained two hours after the removal of the eyes. Then, in order to see if the removal of the anterior end had the same effect as removing only the eyes, the same specimens were decapitated, and after twenty-four hours their rates of locomotion were again ascertained.

The results of these experiments are tabulated in table 1. This table shows that, in directive illumination, the average rate of locomotion for the ten normal specimens was 1.18 mm. per second; that after the eyes were removed, the rate in the same

specimens in the same illumination was 1.10 mm. per second; and that, after the removal of the anterior end, the rate was only 0.62 mm. per second. The table also shows that essentially the same results were obtained in the case of non-directive illumination. It shows, moreover, that in specimens tested two hours after the removal of the eyes the rate of locomotion actually increased. This is, no doubt, due to the mechanical stimulation of removing the eyes which has not yet had time to wear off, for, in normal specimens, shortly after small incisions are made in the dorsal surface, the rate of locomotion is similarly increased.

These results show that the rate of locomotion is not appreciably affected by the removal of the eyes, whereas it is greatly affected by the removal of the anterior end, and they indicate very clearly that the photoreceptors which receive the orienting stimulus are not the ones which control the rate of locomotion. It has been shown by Walter ('07, p. 57) that, in general, planarians move faster in higher intensities than in lower. The photoreceptors involved in this increase of the rate of locomotion under increased intensity of illumination as well as in the experiments just described are other than the eyes—very probably the general body surface.

3. *Discussion of experiments in relation to former investigations.* The results of the preceding experiments are in accord with those of Lillie ('01) and Mast ('10) in regard to the character of the response to light, but are at variance with the results of Loeb ('94), Hesse ('97), and Parker and Burnett ('00) both in regard to the nature of the responses and the rate of locomotion. The question immediately arises as to what causes the disparity between these results and those of the latter investigators.

In regard to the nature of the response in specimens with both eyes removed, the answer probably can be found in the fact that the species used by the former investigators did not normally orient with any great degree of precision to the directive influence of light. There is no doubt that many planarians do not orient to light, and, of course, one would not expect to find any great change brought about by the removal of the eyes, if the eyes did not function in the normal animal.

In regard to the rate of locomotion in specimens with both eyes removed, the disparity between the results of this paper and those of the former investigators undoubtedly lies in the fact that they drew conclusions regarding the effect of removing the eyes from the behavior of decapitated specimens. From the results given in this paper, it is evident that such conclusions are not valid, because removal of the anterior end itself, regardless of the eyes, has a profound effect on the rate of locomotion. If the entire ventral surface of a planarian is functional as an organ of locomotion, a very simple explanation of the decrease of the rate in decapitated worms suggests itself. Removal of the anterior end would remove a part of the organ of locomotion and hence would undoubtedly decrease the rate of movement. It is very improbable, however, that this can explain such a great decrease. The general effect of the operation and possibly the loss of the 'brain' act upon the general physiological tone of the animal, causing locomotion, among other physiological activities, to be retarded.

*B. Reactions to light in specimens with one eye removed*

In regard to the reactions of planarians with one eye removed, Mast ('10, p. 132), in a paper already referred to, makes the following statement:

Planaria with one eye removed, either by gouging it out or by cutting off one side of the anterior end obliquely, turn continuously from the wounded side for some time, evidently owing to the stimulation of the wound, since after this is healed they tend to turn in the opposite direction. After regeneration is nearly complete they orient practically as accurately as normal specimens.

Unfortunately, from the standpoint of the present investigation, no note was made of just how far the eye itself was allowed to regenerate in such specimens before accurate orientation to light was observed.

The present experiments were designed to ascertain how accurately specimens with one eye orient to the directive stimulation of light and to find out, if possible, the mechanism of this orientation.

In these experiments, exactly the same technique was employed and the same precautions were observed as in the experiments of the preceding sections. The animals were anesthetized with CO<sub>2</sub> and one eye removed with a fine knife, as has been described (fig. 7). After the removal of an eye, the animals were given eight to twenty-four hours to recover from the operation. At this point any specimen which showed any distortion of the head or any loss of the bilateral symmetry of the contour of the anterior end was discarded. It is to be noted that in removing one eye there is more tendency to disturb the bilaterally symmetrical contour of the anterior end than in the case where both eyes are removed. Any disturbance of the contour of the head is often followed by abnormal locomotor disturbances. After each experiment, the animals were fixed, sectioned, and stained as in the preceding section. Again, the records of all animals in which there was any injury to the 'brain' or incomplete removal of the eye were discarded.

When observed in non-directive light, specimens with one eye removed travel about, apparently, in every respect like normal individuals. In neither directive nor non-directive light is there any evidence of sluggishness, circus movements, or other abnormal motor activities. The absence of circus movements is in marked contrast to the results of Mast ('10, p. 132).

In studying the process of orientation in specimens with one eye removed, the paths of twenty-nine individuals were traced by means of a camera lucida. All of these tracings are essentially like the one reproduced in figure 9. This tracing was made from observations on a specimen twenty-four hours after the right eye had been removed. Just prior to the removal of the eye the specimen oriented accurately when illuminated laterally on either side. The tracing shows that after the removal of the eye the animal oriented immediately and precisely like normal specimens whenever the direction of the rays of light was changed so as to illuminate the normal side (fig. 9, *N*); but when the 'blind' side was illuminated, it did not react immediately nor did it orient like normal specimens. In two cases when the 'blind' side was illuminated, viz., after light 1 and 3 were turned



on (fig. 9, 1 and 3,  $W'$ ), the animal proceeded for a certain distance at right angles to the rays of light until a wandering reflex caused the animal to turn far enough toward the light to allow the rays of light to enter the remaining eye. After this occurred the animal oriented accurately by describing a small circular path away from the light. In another case when the 'blind'

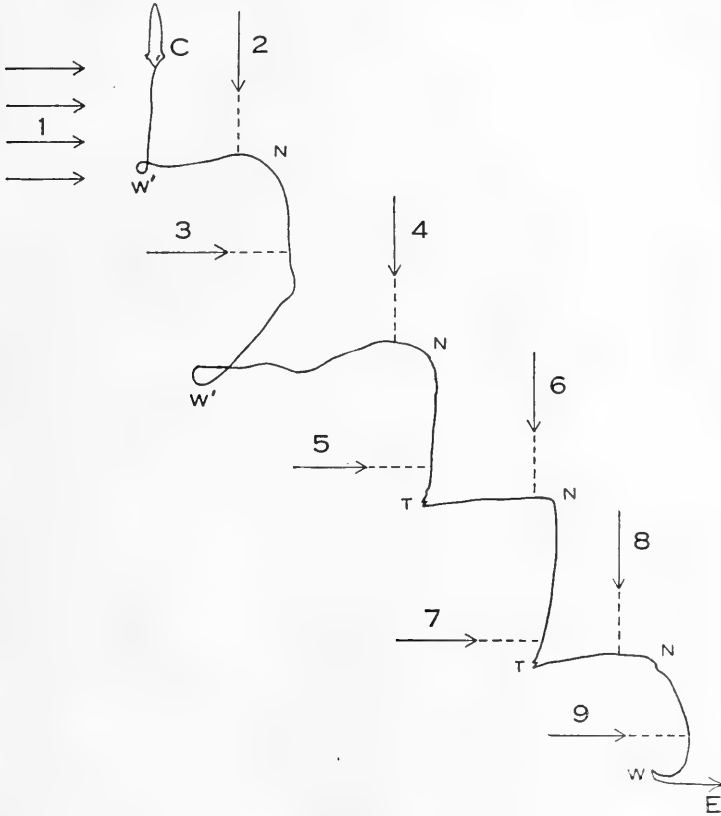

Fig. 9 Camera-lucida drawing of path of specimen with the right eye removed in a horizontal beam of light. Arrows 1 to 9 indicate successive directions of the rays of light.  $C-E$ , path of specimen;  $N$ , direct orientation following illumination of the left, i.e., normal side;  $T$ , orientation by means of the twisting reflex following illumination of the right, i.e., 'blind' side;  $w$ , orientation by means of the wandering reflex following illumination of the 'blind' side;  $w'$ , orientation by means of 'wandering reflex' modified by a greater rapidity in the movement of the animal.

side was illuminated, viz., after light 9 was turned on, the animal, in consequence of a wandering reflex, turned toward the light; but, in this case, instead of describing a circular path away from the light, the animal oriented by turning toward the side containing the eye (fig. 9, 9 and *W*). The rate of movement seem to determine which of these two reactions follows when such specimens orient by means of the wandering reflex. This will be taken up later in greater detail. In the two remaining cases in which the animal was illuminated on the 'blind' side, viz., after lights 5 and 7 were turned on, the animal proceeded at right angles to the light until it gave the twisting reflex (fig. 9, 5 and 7, *T*). During this reaction the anterior end was twisted and directed toward the light in such a manner that the light entered the remaining eye. In consequence of this, the animal oriented accurately by turning directly away from the light.

The above observations clearly indicate that when a specimen is illuminated on the 'blind' side, it does not orient until it moves in such a manner as to allow the light to enter the remaining eye. When this occurs the specimen orients quickly and accurately. The mechanism of orientation in such a specimen can best be explained by means of diagrams (fig. 10). If, as the animal is illuminated on the 'blind' side and is proceeding at right angles to the rays of light (fig. 10, *A, 1*), it gives a wandering reflex toward the 'blind' side (fig. 10, *A, 2*) to such an extent that the rays of light enter the posterior region of the pigment-cup, the animal turns sharply (fig. 10, *A, 3* and *4*) toward the normal side instead of away from it as it ordinarily does. In rapidly moving specimens this reaction is often modified. If the animal is moving rapidly, it is often carried around so far that the light strikes the rhabdomes of the center of the fundus of the pigment-cup apparently before it has had time to react to the illumination of the rhabdomes of the posterior edge of the cup. If this happens, the animal turns away from the stimulated side instead of toward it as in the former case. In other words, it continues to turn toward the 'blind' side until it is oriented. This reaction results in a small circle in the path (fig. 10, *A, 2, 3'—5'*). A third method of orienting to the rays of light, when the animal

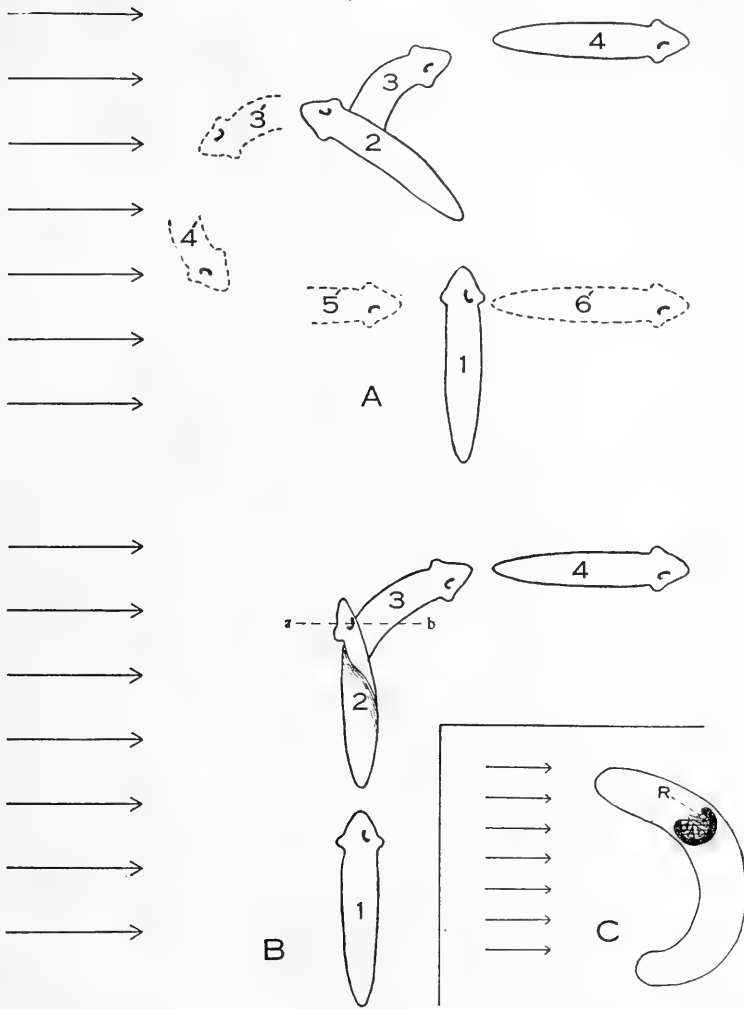

Fig. 10 Diagrams illustrating process of orientation in specimens with left eye removed, when illuminated laterally from the left, i.e., the 'blind' side. The arrows indicate the direction of the rays of light. *A*, orientation by means of 'wandering reflex;' 1, 2, 3, and 4, successive positions of animal; 1', 2', 3', 4', 5', and 6', successive positions of the animal if it is moving rapidly; *B*, orientation by means of 'twisting reflex;' 1 to 4, successive positions of specimen. Insert *C* represents a diagrammatic cross-section of specimen in *B* through the plane *a-b*; R, position of rhabdomes which are illuminated in such reactions.

is illuminated from the 'blind' side, is by means of the twisting reflex. When an animal, moving at right angles to the direction of the rays of light, gives the twisting reflex it very often bends the side containing the remaining eye so far toward the light that the rhabdomes lying along the ventral surface of the pigment-cup are stimulated. (fig. 10, *B* and insert *C*). If this takes place, the animal sharply orients by turning toward the stimulated or normal side (fig. 10, *B*, 1—4).

The results presented above show that specimens with one eye orient normally when the side containing the eye is illuminated; but that when the 'blind' side is illuminated, there is no true orientation unless the animal moves in such a manner as to allow the rays of light to illuminate some of the rhabdomes of the eye of the normal side.

The most interesting feature in regard to the process of orientation in such specimens is that when they are illuminated on the 'blind' side they very often turn toward the side containing the eye. Since turning is due to stimulation of the eye, such specimens turn toward the eye which is stimulated instead of from it as ordinarily occurs in normal orientation. In them, also, stimulation seems limited to certain portions of the eye and this seems to indicate that the direction of turning depends upon the localization of the stimulus within the eye. From a structural standpoint it indicates that the rhabdomes of each eye are arranged in two (or more) definitely localized sensory regions—the stimulation of one region resulting in the animal's turning away from the side containing the eye and the stimulation of the other resulting in a turning in the opposite direction. If there are such regions in the eye can these regions be accurately outlined? This problem will be taken up in the next section.

As has been pointed out above, Mast ('10, p. 132) found that *Planaria* with one eye removed by gouging it out or by cutting off the anterior end obliquely move continuously from the wounded side, and that, later during the process of regeneration, they have a tendency, when stimulated by light, to move toward the side containing the newly regenerated tissue. In our experiments we did not obtain reactions of this sort. Mast maintains

that the first tendency to move away from the wounded side is probably due to the stimulation of the wound. The absence of any movements of this nature in specimens used in the present work is most likely due to the fact that no great amount of damage was done to the surrounding tissues in removing the eye. Later, during the process of regeneration, the tendency of the animals in Mast's experiments to move away from the side containing the newly regenerated tissue showed, according to him, that this newly formed tissue was more sensitive to light than the old. The absence of this tendency in the present experiments may again be due to the small amount of injury to the animal during the removal of the eye, and consequently, the lack of any large amount of regenerating tissue.

### *C. Localized sensory regions in the eye*

1. *Extent of localized sensory regions.* The experiments of the preceding section demonstrate that two opposite reactions may follow from the illumination of different regions of the same eye. The experiments in this section were designed to outline as accurately as possible these regions of the eye.

It will be remembered that the eye of *Planaria maculata* consists of a number of sensory rhabdomes enclosed by an opaque pigment-cup: Because of this opaque pigment-cup, the entire eye may be illuminated and yet only a portion of the rhabdomes will receive this illumination. The area containing the illuminated rhabdomes in any case can be fairly precisely ascertained, provided the structure of the eye is known and parallel rays of light are used.

The apparatus used in these experiments was constructed as follows: A 125-watt gas-filled lamp was blackened except for a small circular area 5 mm. in diameter. A tube about 5 cm. in diameter and 45 cm. in length was attached to the lamp over the circular area. At equal intervals along the length of the tube, three diaphragms containing circular openings 5 mm. in diam. were placed. The beam of light thus produced consisted largely of parallel rays and was large enough to cover an entire eye. The tube with the lamp attached could be shifted to throw a beam of light in any direction desired.

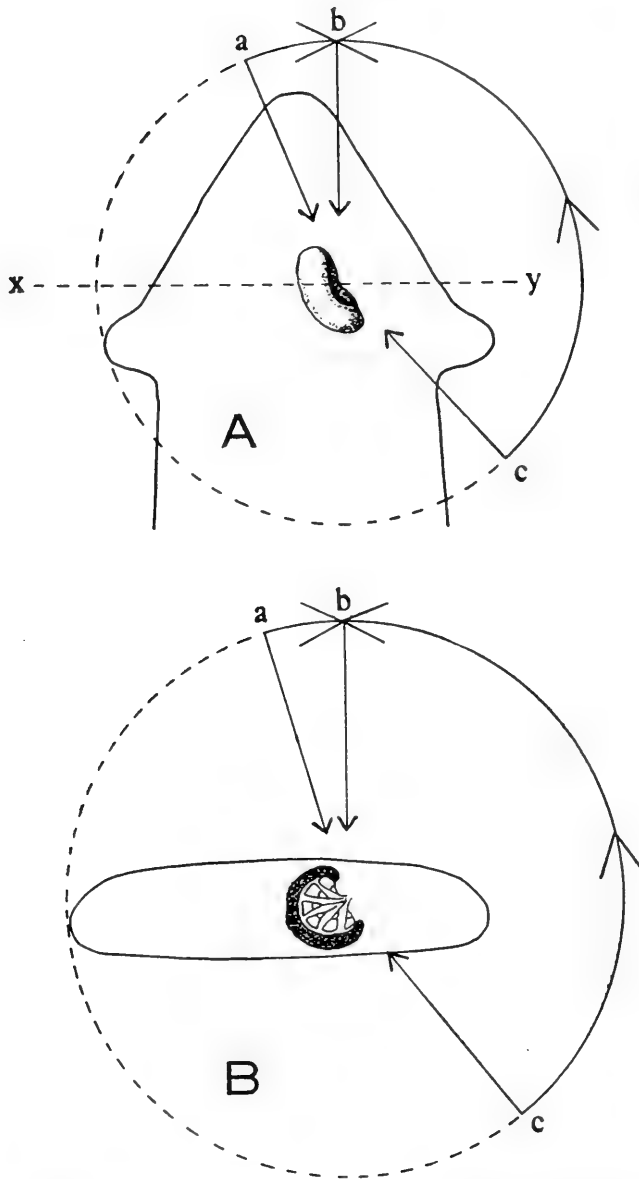

Fig. 11 Diagram representing the direction of the turning when a specimen with left eye removed is illuminated from different directions. *A*, dorsal view of specimen illuminated from different points in the frontal plane; *B*, specimen il-

In order not to confuse the reactions resulting from the illumination of one eye with those following from the illumination of two eyes, all animals used in these experiments had one eye removed. The same specimens were used as in the preceding section.

Let us consider first the reaction of a specimen with the left eye removed when the eye is illuminated from different angles in the horizontal plane of the animal.

If the beam of light comes from a point directly in front of the animal, it turns the anterior end to the right, i.e., toward the normal or stimulated side (fig. 11, *A, b*). The same reaction follows if the source of light is shifted slightly to the left of the median line (fig. 11, *A, a*). As, soon however, as the light is shifted far enough to the left of the median line as to place the pigment-cup between the source of illumination and the sensory rhabdomes, no reaction follows (fig. 11, *a-b*). When the rays of light illuminate the eye from any point to the right of the median line, the animal turns in an opposite direction, i.e., it turns away from the normal or stimulated side (fig. 11, *b-c*). Here, just as with the previous case, as soon as the source of illumination is carried far enough to place the pigment-cup between it and the rhabdomes no reactions follow.

The same type of response is obtained when the specimen is illuminated from various points in the transverse vertical plane of the eye. If the rays of light illuminate the animal from a point directly above the eye, the specimen reacts by turning toward the normal or stimulated side (fig. 11, *B, b*). If the source of illumination is shifted to the left of the vertical line the animal responds in the same manner (fig. 11, *a-b*). If, however, the rays of light illuminate the animal from any point to the right of the vertical line, the specimen responds by turning away from the normal or stimulated side (fig. 11, *B, b-c*). As in the previous

luminated from different points in the transverse, vertical plane of the eye. Section taken along  $x-y$  of *A*. If the light enters the eye from any point between the arrows *a-b*, the specimen turns toward the normal side. If the light enters the eye from any point between the arrows *b-c*, the specimen turns away from the normal side. No reaction follows if the eye is illuminated from any point along the broken line *a-c*.

case, whenever the light is so placed that the pigment-cup shades all of the rhabdomes, no reaction follows (fig. 11, *B*, *a-c*).

Let us now consider precisely which rhabdomes are illuminated under the various conditions mentioned above. It will be remembered that when *Planaria* is illuminated from directly in front, or directly above, or to the left of these points, it turns away from the side containing the eye, i.e., to the left. Now,

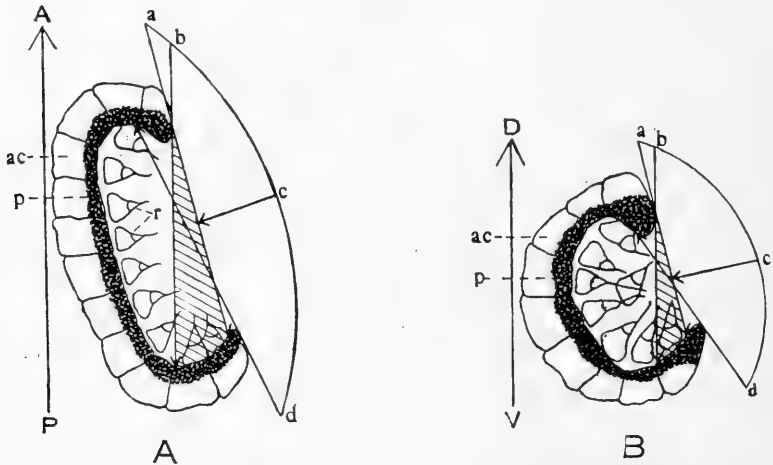

Fig. 12 Diagrams made from camera-lucida drawings representing the rhabdomes which are illuminated when light enters the eye from various directions. *A*, eye seen in frontal section; *B*, eye seen in transverse section; *A-P*, longitudinal axis of animal; *D-V* dorsoventral line; *ac*, accessory cells forming pigment-cup; *p*, pigment-cup; *r*, rhabdomes. Light entering the eye from any point between *a-b* illuminates only the rhabdomes in the area which is cross-hatched. Light entering the eye from any point between *c-d* illuminates only certain rhabdomes of the unshaded regions. Light from any point between *b-c* may illuminate rhabdomes of both the shaded and unshaded regions.

when light enters the right eye from a point directly in front of the eye, or slightly to the left of this point, the only rhabdomes which are illuminated are those lying along the outer, posterior edge (fig. 12, *A*, *a-b*). The remaining rhabdomes are shaded by the anterior edge of the pigment-cup. In the same manner, when light enters the eye from a point directly above the eye, or slightly to the left of this point, the only rhabdomes illuminated are those placed along the outer ventral edge of the pigment-



cup (fig. 12, *B*, *a-b*). The remaining rhabdomes, in this case, are shaded by the dorsal edge of the pigment-cup. We may consequently conclude that illumination of the rhabdomes lying along the outer posterior edge and the outer ventral edge of the eye-cup is followed by turning toward the side bearing the eye. Which rhabdomes, then, are illuminated when the animal turns away from the side containing the eye?

In an animal with the left eye removed this follows as a result of illuminating the specimen laterally from any point to the right of the sagittal plane of the eye. Now, when light enters the eye from any point in the horizontal plane to the right of the median line, various rhabdomes lying along the center and anterior edge of the pigment-cup may be illuminated (fig. 12, *A*, *b-d*). In the same manner, light which enters the eye from some point in the transverse vertical plane of the eye but to the right of the point directly above, always illuminates some of the rhabdomes lying along the center of the dorsal margin of the pigment-cup (fig. 12, *B*, *b-d*). These results indicate that illumination of the rhabdomes of the center and anterior and vertical edges of the pigment-cup is followed by the animal's turning away from the side containing the eye. The region which causes the animal to turn away from the side containing the eye cannot, however be outlined as definitely as that which causes it to turn in the opposite direction, because in some cases light entering the eye may illuminate certain rhabdomes of both regions. Thus, by referring to figure 12, it will be seen that light entering the eye between the points *b* and *c*, although it causes the animal to turn away from the side containing the eye, illuminates certain rhabdomes of both regions.

The observations recorded above indicate that illumination of the rhabdomes lying along the ventral and posterior edge of the pigment-cup is followed by the animal's turning toward the side containing the eye, while illumination of the remaining rhabdomes, i.e., those of the center and anterior edge, is followed by the animal's turning in the opposite direction (fig. 13). Further evidence that this conception of localized sensory regions in the eye is a correct one will be taken up in the next section.

2. *Reactions to light in specimens with one eye and the posterior half of the other eye removed.* In the preceding section it was concluded that there are two localized sensory regions in the eye. If this is true, the animal should lose the reaction which

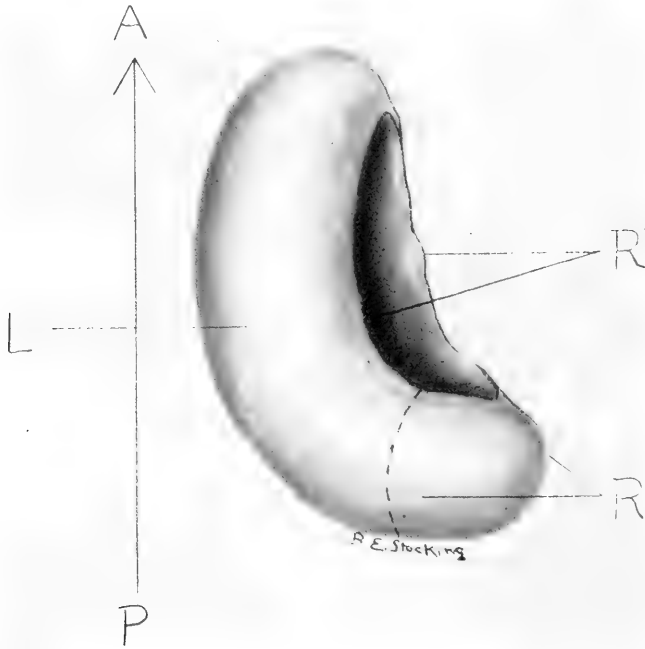

Fig. 13 Drawing representing the shape of the pigment-cup of the right eye and indicating the location of the localized sensory regions. Arrow indicates longitudinal axis; *A*, anterior; *P*, posterior. Illumination of those rhabdomes which lie in the posterior part of the eye, *R*, or on the ventral lip, *R'*, results in the animal's turning toward the side containing the eye, viz., the right. Illumination of the rhabdomes which lie in any other part of the pigment cup, *L*, results in the animal's turning in the opposite direction, viz., away from the side containing the eye or the left.

is supposed to result from the stimulation of either of these regions if it is removed. It was found, by very careful manipulation, that the posterior half of an eye could be removed leaving the anterior half uninjured—or at least, functional. After such operations each animal was allowed approximately twenty-four

hours to recover. After each experiment the specimen was fixed and sectioned. In the majority of cases reconstructions were made of the portion of the eye that remained in the animal. As would be expected from the delicate nature of these operations, a great number of animals were discarded because of some injury, either to the portion of the eye which remained in the animal or to the surrounding tissues. In order to complete eight successful experiments, approximately fifty animals were operated on.

As previously stated, an animal with one eye removed when illuminated directly from in front or slightly from the blind side turns toward the stimulated side. It was concluded that this reaction is due to the stimulation of the rhabdomes covering the posterior-median section of the eye-cup. Now, if this conclusion is correct, the removal of the posterior region of the eye-cup should cause the animal to lose this reaction when illuminated from directly in front.

The reactions of eight individuals with the left eye and the posterior half of the right eye removed were studied when illuminated with a horizontal beam coming from directly in front. In all of these the reactions were essentially as follows: The animal generally moved from 1 to 5 mm. directly toward the light at a greatly retarded rate, then it began to wander either to the right or left (fig. 14, *A*). Observations indicate that such specimens turned toward the side containing the eye as often as from it. If the animal turned toward the side possessing part of an eye (in this case the right side), it eventually proceeded in an irregular course away from the light (fig. 14, *D*). There was never any evidence of orientation. If, however, the animal turned toward the 'blind' side (in this case the left side), the animal exhibited no marked reaction until the rays of light illuminated the eye laterally. When this took place the specimen oriented by turning directly from the light until it was fairly accurately oriented (fig. 14, *B*). It then proceeded in a fairly direct course until a 'wandering reflex' carried it out of the path of orientation.

If the reactions of such an animal are compared with those of a specimen possessing the entire right eye, we see at once that there is a marked contrast. If the latter is illuminated from

directly in front, it turns sharply to the right, i.e., toward the normal side. If, however, the posterior region of the right eye is removed, the animal no longer shows this reaction following such illumination. Instead, such specimens proceed in general

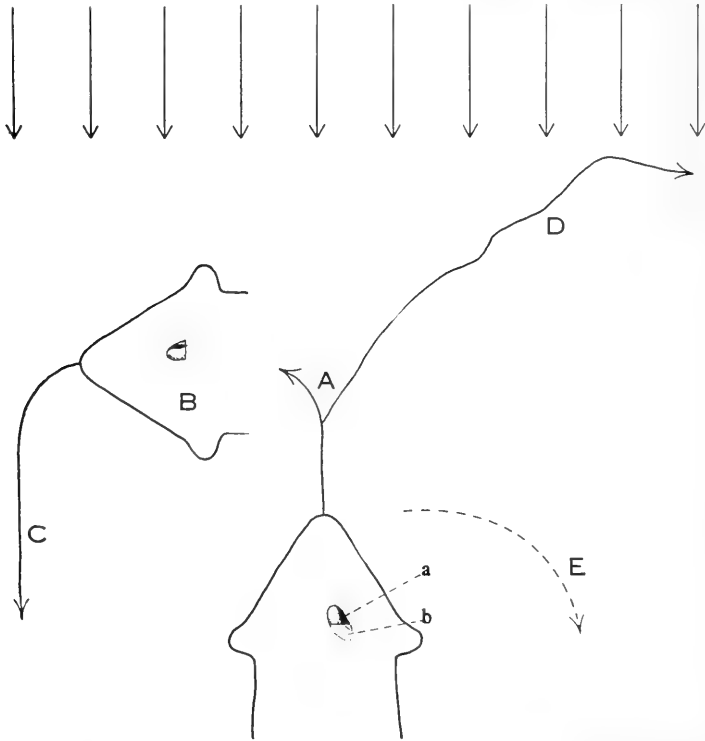

Fig. 14 Diagram representing reactions of a specimen, possessing only the anterior half of the right eye, to a horizontal beam of light coming from directly in front. Arrows, beam of light; *a*, portion of eye remaining; *b*, portion of eye removed. If specimen turns to the left at *A* and assumes position *B*, it orients by following the path *C*. If, however, it turns to the right, it follows an indefinite path, as, for example, *D*. *E* represents the path the specimen would have followed had it possessed the entire right eye.

for a short distance directly toward the light, and then turn either to the right or left. In other words, when observed under the effect of illumination from directly in front of the animal, removal of the posterior portion of the eye causes the animal to lose the reaction which ordinarily follows the illumination of this region.

These results lend very strong support to the conclusions reached in the section dealing with the localization of sensory regions in the eye. In fact, they practically prove the conclusions in regard to one region of the eye.

As an argument against the conclusions set forth above, it might be asked if the removal of the posterior region of the eye has not injured the remainder of the organ to such an extent that we are really dealing with an animal that has no eyes at all. In answer to this question it can be said, 1) the sections of such animals reveal no indication of any injury to the remaining rhabdomes and, 2) the remainder of the rhabdomes are still functional. By referring to the description of the reactions of such animals, it is very evident that the last statement is correct, for it will be remembered that if the animal wanders away from the side containing part of the eye, it sharply and accurately orients as soon as the light illuminates the eye from a lateral position. The only plausible explanation of this is that the reaction follows from an illumination of the rhabdomes in the center of the pigment-cup, or, in other words, that removing the posterior portion of the eye did not injure the capacity of the remainder to function.

3. *Reactions to light in specimens with one eye and the anterior half of the other eye removed.* The attempt was made to carry out experiments similar to those described in the preceding section, using, however, specimens possessing only the posterior half of one eye instead of the anterior half.

All specimens with one eye and the anterior half of the other (remaining eye) removed react precisely as do specimens with both eyes removed. Under no circumstances is illumination of the part of the eye remaining in the animal followed by orientation as was the case in the animals with the posterior half of the eye removed. The results, at first, seemed rather puzzling, but it can be seen by referring to the section on the structure of the eye that the nerve processes from all of the rhabdomes leave the eye from the anterior edge, and histological examination showed that all of these were cut in removing the anterior half. Removal of the posterior half of the eye, on the other hand, did not injure these fibers.

*D. Localization of photic stimulation*

Considerable evidence has been noted indicating that the rhabdomes of the eye of *Planaria maculata* are arranged in two localized sensory regions. If this be actually true, it is obvious that there must be some localizing device whereby light from one direction will stimulate one of these regions and yet not stimulate the other. Otherwise, a general illumination of the eye would result in the stimulation of all the rhabdomes, some of which cause the animal to turn in one direction and others in an opposite direction.

1. *Mechanism of localization of photic stimulation.* In a paper referred to several times in the preceding pages, Hesse ('97) advances the theory, without experimental evidence, that the pigment of the turbellarian eye acts as a localizer of photic stimulation. This he illustrates very clearly by means of a series of diagrams reproduced in figure 15.

He maintains that although light can enter the pigment-cup from different angles, it illuminates different portions of the interior from each angle. As he points out, in forms in which there is only one retinula, this would simply result in the illumination of different parts of the same retinula. In forms, however, whose eyes contain numerous retinulae, this mechanism would result in the illumination of different sets of retinulae.

Many of the results presented in the preceding pages are in harmony with Hesse's interesting theory which contains the most valuable suggestion yet made concerning the function of the pigment in flatworm eyes. Some of the results obtained in our work are, however, not in harmony with this theory.

The experiments which we have described dealing with the reactions to light in forms with one eye and the posterior part of the other removed bear directly on the question as to whether or not the pigment acts as a localizer of photic stimulation as Hesse maintains. It will be remembered that such forms when illuminated laterally on the side containing the anterior part of the eye turn directly away from the light and proceed in a more or less direct path, as is the case with normal specimens and specimens with one eye (fig. 14, B).

The turning in all of these cases follows the illumination of the rhabdomes lying in the center of the pigment-cup (fig. 16, *A* and *C*, *x*). After specimens with normal eyes, either one or two, are oriented, the rhabdomes, owing to the shadow cast by the pigment-cup, are no longer illuminated (fig. 16, *B*). But in specimens with the posterior portion of the eyes removed, the

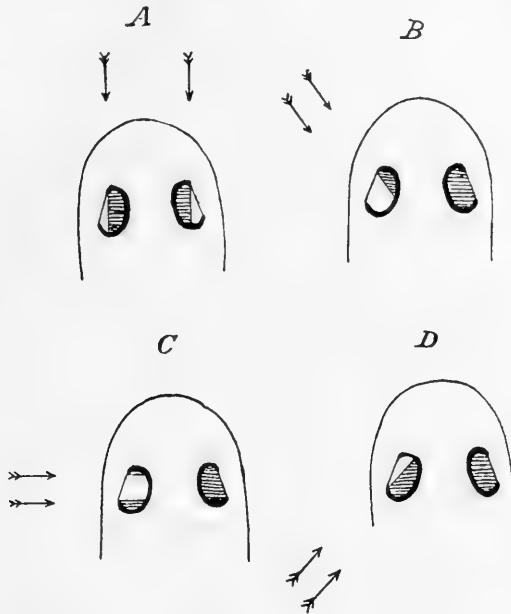

Fig. 15 Different illumination of the planarian eye with light coming from different directions. The optic cups (pigment-cups) are drawn too large in proportion to the head. The arrows indicate the direction of the light; the portions of the interior of the cup which are not illuminated are shaded (after Hesse, '97, p. 575).

rhabdomes are quite as fully exposed to the light after they are oriented as when they are laterally illuminated (fig. 16, *C* and *D*).

The results indicate very plainly that stimulation follows the illumination of the rhabdomes of the center of the pigment-cup only when the light strikes the rhabdomes from a lateral direction, not when it strikes them from behind, as it does in the oriented specimens with the posterior portion of the eyes removed. This seems to show that it is not necessary for the pigment to act as

a localizer of photic stimulation as maintained by Hesse. The localizing mechanism appears to be contained in some manner in the rhabdomes themselves.

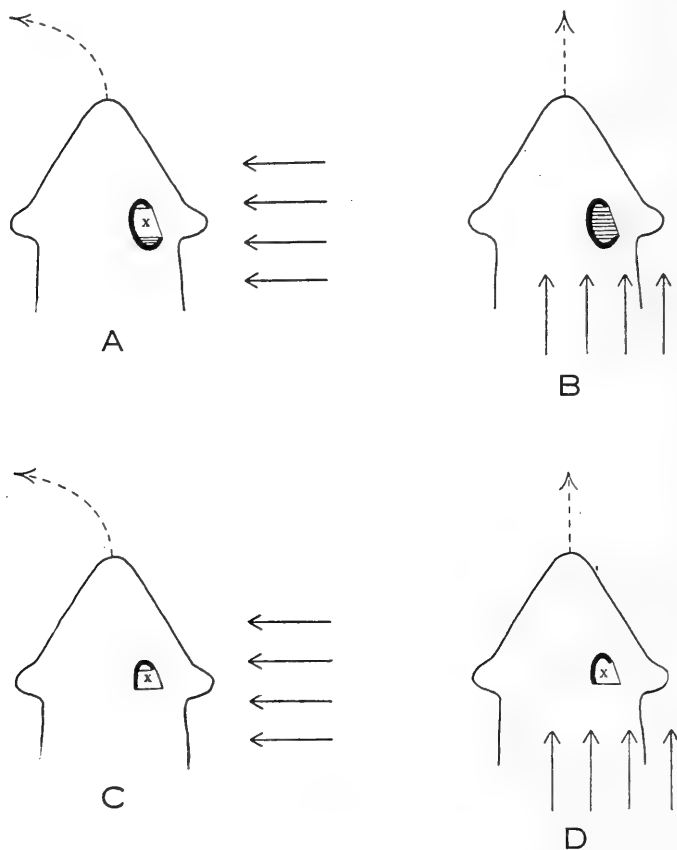

Fig. 16 Illumination of eye with light coming from different directions. *A* and *B*, animal possessing entire right eye; *C* and *D*, animal possessing anterior half of right eye. Arrows indicate the direction of rays of light; broken lines indicate path of specimen; *x*, position of rhabdomes which are illuminated. Animal *D* proceeds directly away from the light although the same rhabdomes are being illuminated as in *C* when it turned sharply to the left.

The idea suggested itself to the author that the above conclusion might not be valid because of the possibility that in removing the posterior half of the eye the pigment might be



carried by the knife and spread over the posterior surface, and that this might make an effective light screen just as in the case of the normal animal. Histological examination of such specimens showed this idea to be erroneous. A few granules are always displaced in making an incision, but these are very much scattered and obstruct the passage of light very little, if at all. Again, the body of the animal might act as a shading mechanism. This, however, was shown not to be true as the same results can be obtained when the source of illumination is lifted slightly above the horizontal plane, in which case the light does not pass through any more of the tissue of the animal's body than in normal lateral illumination. We are consequently forced to accept the conclusion that light entering the eye from behind does not stimulate the rhabdomes as it does when it enters from the side. That is, that light striking certain rhabdomes from the direction indicated by the arrow *a* (fig. 17) is followed by a definite turning of the animal, whereas no such turning results when light strikes the same rhabdomes from the direction indicated by the arrow *b*. None of the experimental work has offered any explanation of this phenomenon. The structure of the retinula and its relation to the pigment-cup, however, offer two possible explanations.

In the living condition in *Prorhynchus applanatus*, according to Kepner and Taliaferro ('16), the middle region of the retinula or the region which corresponds to the ellipsoid of the vertebrates is the most refractive portion of the retinula. The same holds true for *Planaria maculata* after fixation. This region, because of its position, contour, and refractive index, must have some effect on the rays of light as they pass down the longitudinal axis of the retinula to strike the rhabdome (fig. 17, *a*). It occurs to one that possibly this region serves as a crude lens to concentrate the rays of light upon the sensitive rhabdome and that photic stimulation depends upon this. If this is true, photic stimulation could not be set up in a given rhabdome unless the light struck the rhabdome approximately parallel to its longitudinal axis. Not only would the light have to strike the rhabdome approximately parallel with its longitudinal axis, but it

would have to pass through the retinula in a distal direction. Otherwise the light would not be affected by the middle region.

If the above suggestion is correct, the pigment would play no part in the localization of photic stimulation in the individual retinulae. We might, however, conceive that the middle region has no effect on photic stimulation, but that the rhabdome is itself so constructed that only light passing along its longitudinal

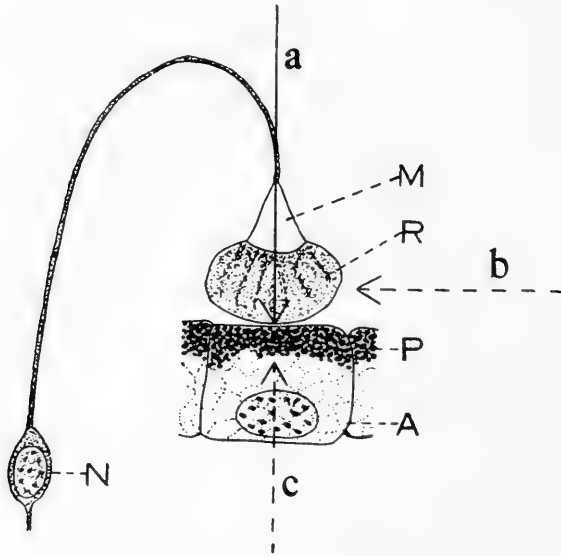

Fig. 17 Diagram representing the relation between structure and photic stimulation in the individual retinula. *A*, one of the accessory cells which form the pigment-cup; *M*, middle region of the retinula; *N*, nucleus of retinula; *R*, sensory rhabdome. Light striking the rhabdome parallel to the axis *a* results in stimulation. Light from the direction *b* or *c* does not result in stimulation.

axis sets up stimulation. If this is true, light from either direction as long as it is parallel to the longitudinal axis might cause stimulation. The pigment, then, might serve to localize photic stimulation in that it would prevent light passing through the rhabdome in a proximal direction and allow light from the opposite direction to strike the rhabdome. Thus, in figure 17, the pigment is so placed that light along the arrow *c* cannot strike the rhabdome. While this suggestion ascribes a certain limited localizing function

to the pigment, it is evident that it does not ascribe to the pigment the entire function of the localization of photic stimulation as is done by Hesse ('97).

2. *Localization of photic stimulation in relation to the structure of the eye.* If we are correct in the assumption that light must penetrate a given rhabdome along its longitudinal axis in order to stimulate it, then the structure of the eye should be such that whenever light enters it, under normal conditions, the longitudinal axes of some of the illuminated rhabdomes will be parallel to the stimulating rays of light. Let us consider this problem.

The best way to describe the relation of the axis of the light rays entering the eye to the axes of the rhabdomes is to consider the actual condition of affairs when the eye is illuminated from each of several different directions. This is represented in figure 18. By referring to this figure the following may be seen: Light which strikes the eye from directly in front of the animal illuminates those rhabdomes which lie on the outer posterior margin of the pigment-cup, and the longitudinal axes of all of these rhabdomes are directed approximately parallel to the rays of light (fig. 18, *A, a, 8* and *9*). The same holds true for light entering the eye from an oblique posterior direction (fig. 18, *B, d, 1*), and, approximately, for lateral illumination (fig. 18, *A, b, 2-6*). When the light comes obliquely from in front of the animal, however, the light rays strike certain rhabdomes parallel with their longitudinal axes (fig. 18, *B, c, 7*) and other rhabdomes at various angles to their longitudinal axes (fig. 18, *B, c, 5, 6, 8, 9*).

The same is true for the rhabdomes when the light enters the eye from different points in the transverse vertical plane. Light which enters the eye from directly above (fig. 18, *C, a, 8*) and obliquely below (fig. 18, *D, d, 1*) strikes all of the rhabdomes in both cases parallel to their longitudinal axes. Light from obliquely above (fig. 18, *D, c, 4-8*) and, to a less extent, light from the side (fig. 18, *C, b, 2-4*) passes along the longitudinal axis of certain rhabdomes and not of others.

This seems to indicate that the structure of the eye is such that if light from any given direction enters the eye, it illuminates

the rhabdomes confined to a definite area; that, in such areas, there is always a large proportion of the rhabdomes which have their longitudinal axes parallel with the rays of light; and that, in a number of cases, the longitudinal axes of all of the rhabdomes in the illuminated area are nearly parallel with the rays of light.

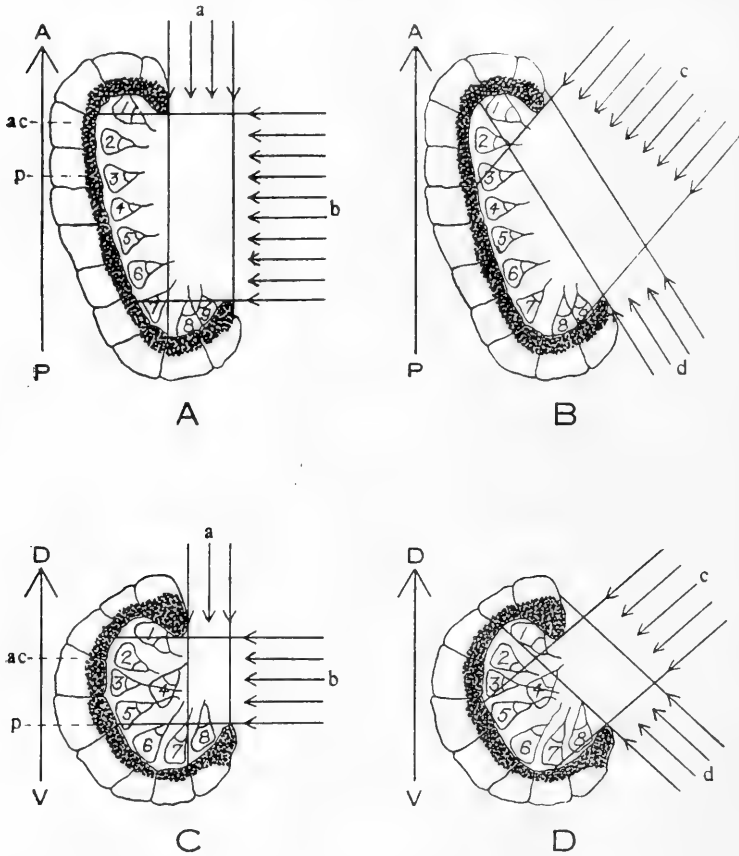

Fig. 18 Diagram representing the relation of the axis of photic stimulation to the axes of the various rhabdomes when the eye is illuminated from different directions. The diagrams are made from camera-lucida drawings of sections. A and B, frontal sections of the eye; C and D, transverse sections of the eye; A-P, antero-posterior line; D-V, dorsoventral line; a, b, c, d, arrows indicating the different beams of light; ac, accessory cells; p, pigment-cup; 1-9, rhabdomes.

These observations strongly support the assumption that if light strikes a rhabdome parallel with its longitudinal axis stimulation results; whereas, if light does not strike a rhabdome along this axis stimulation does not follow. This will explain why it is not necessary for the pigment-cup to act as a localizer of photic stimulation. The latter is localized not by the pigment-cup, but by the position of the longitudinal axes of the various rhabdomes.

#### NATURE OF THE STIMULUS DURING ORIENTATION

At the present time there are two chief theories advanced to account for the orientation of organisms to light—the continuous-action theory and the change-of-intensity theory. The literature bearing on these two theories is so extensive that we shall limit the present review to a very brief outline.

Loeb, who is the chief upholder of the continuous-action theory, maintains that an organism orients to light because of unequal chemical changes induced by the light in symmetrically placed photoreceptors; that effects of these chemical changes are transmitted eventually to the locomotor organs, thus producing unequal 'tension or energy production' in the musculature of the two sides, and that this results in a turning of the organism. According to him, after the organism has become oriented, the light produces equal chemical changes in the photoreceptors and the organism proceeds directly toward or away from the light owing to continuous and equal action of the light on symmetrically located photoreceptors.

In reference to his theory, he says ('16, pp. 258–259):

The reader will perceive that according to the writer's theory two agencies are to be considered in these reactions: first, the symmetrical arrangement of the photosensitive and the contractile organs, and, second, the relative masses of the photo-chemical reaction products produced in both retinae or photosensitive organs at the same time. If a positively heliotropic animal is struck by light from one side, the effect on tension or energy production of muscles connected with the eye will be such that an automatic turning of the head and the whole animal towards the source of light takes place; as soon as both eyes are illuminated equally the photochemical reaction velocity will be the

same in both eyes, the symmetrical muscles of the body will work equally, and the animal will continue to move in this direction. In the case of the negatively heliotropic animal the picture is the same except that if only one eye is illuminated the muscles connected with this eye will work less energetically

Loeb holds, moreover, that the orienting stimulus in organisms, both animals and plants, is dependent upon the actual amount of stimulating energy received by the photoreceptors in accord with the Bunsen-Roscoe law.

Opposed to the continuous-action theory, is the change-of-intensity theory, supported chiefly by the works of Jennings and Mast. According to this theory, the orienting stimulus is not dependent upon the actual amount of energy received by the photoreceptors, but to time-rate-of-change of the stimulating energy. Once an organism is oriented to light, it is supposed to receive no orienting stimulus until it leaves the path or axis of orientation.

The great body of evidence, especially in the unicellular forms, tends to favor the change-of-intensity theory. Mast has discussed this evidence fully in *Light and the Behavior of Organisms* ('11) and in numerous recent papers (Mast, '16). In certain seedlings, however, Blaauw ('08), Fröschel ('08), Arisz ('11), and Clark ('13) have demonstrated that within certain limits orientation to light is dependent upon the actual amount of energy received. This is in accord with the continuous-action theory. Likewise, Mast ('11, p. 163) and Loeb and Ewald ('14) have come to practically the same conclusion in regard to the orientation of the sessile polyp *Eudendrium*.

The chief questions that are at issue between these two theories are: 1) Does stimulation during orientation depend upon the continuous action of light or to time-rate of change in the intensity? 2) Does the same stimulus that causes orientation continue to act after orientation? 3) Is it essential that the photoreceptors which receive the orienting stimulus be placed symmetrically?

While this work was not taken up with any especial reference to these questions, some of the observations bear directly upon them. In regard to the first question, while some of the evidence favors the change-of-intensity theory, there is no direct evidence

that stimulation during orientation is due necessarily to either the actual amount of energy received or to the time-rate of change in intensity. In regard to the second and third questions, however, we can draw definite conclusions.

In the first place, as has been noted (p. 74), when an animal is proceeding away from the source of illumination, it tends to wander to the right or left (wandering reflex). When the animal has thus turned its head laterally to the extent that the rays of light enter the mouth of the pigment cup, it re-orient. This behavior strongly suggests that once the animal is oriented it receives no orienting stimulation until it leaves the path of orientation. In the second place, it was shown above (p. 95), under the experiments designed to map the regions of the eye, that no stimulation is received (or more exactly no reaction follows) as long as the pigment-cup is between the source of illumination and the rhabdomes. Now, an examination of the relative positions of the eyes shows very clearly that once an animal is oriented and is proceeding away from the light, no light can strike the rhabdomes unless it does pass through the pigment. From these observations we must conclude that when a planarian is moving away from the light the pigment-cup effectively shades the sensory portion of the eye. Therefore, as there is no continuous illumination of the sensory organs involved in orientation, there can be no continuous stimulation of these organs.

The fact that specimens with one eye removed orient accurately to light (fig. 9) shows clearly that the symmetrical arrangement of the two eyes is not essential for orientation. The extent of turning is probably reflexly determined by the portion of the eye stimulated and is independent of the duration of the stimulation.

It may, therefore, be concluded that, while our evidence is not conclusive in regard to the nature of the stimulus, orientation in *Planaria maculata* is not in accord with the 'continuous-action' theory as defined by Loeb.

## GENERAL SUMMARY

1. The eye of *Planaria maculata* is a typical turbellarian eye, consisting of two types of cells—the accessory cells forming the pigment-cup and the sensory cells or retinulae.
2. Each retinula consists of three regions—the nucleus-bearing region, the middle region, and the rhabdome, which show a striking resemblance to the three regions of the vertebrate retinula, viz., the myoid, the ellipsoid, and the rhabdome.
3. *Planaria maculata* is negative to light and orients accurately to a horizontal beam of light.
4. Orientation is, under certain conditions, direct; the animals may turn directly away from the source of light without preliminary trial movements. Trial movements are, however, at times functional in the process of orientation.
5. The location of the bending of the body, when the head is turned away from the light, depends upon the intensity of the light—the higher the intensity of illumination, the more posteriorly the point of bending is located. It is, however, never located farther back than the pharynx.
6. If the intensity is high enough (or possibly continued long enough) to cause the bending to take place in the region of the pharynx, the animal no longer bends directly away from the light, but first toward and then away.
7. During the reactions of animals to a horizontal beam of light, two marked motor reflexes occur, viz., the twisting reflex and the wandering reflex. These reflexes are defined on pages 74 and 75.
8. Specimens with both eyes removed do not orient in directive illumination as do normal specimens. They move, however, in general, away from the light.
9. Removal of both eyes does not appreciably affect the rate of locomotion in either directive or non-directive illumination.
10. Removal of the anterior end, on the contrary, greatly retards the rate of locomotion in both directive and non-directive illumination.
11. Specimens with one eye removed show no indication of circus movements or other abnormal motor activities.



12. Specimens with one eye removed orient accurately to light, when illuminated on the normal side, by turning directly away from the source of light.

13. Such specimens do not orient to light when illuminated on the 'blind' side unless the head is moved so that light enters the remaining eye. If, however, the head is moved so that light enters the remaining eye (wandering and twisting reflex), accurate orientation may follow.

14. The rhabdomes in the eye are arranged in two localized sensory regions; illumination of the rhabdomes of the posterior and ventral edge of the pigment-cup is followed by the animal's turning toward the side containing the eye, while illumination of the remaining rhabdomes is followed by the animal's turning in the opposite direction.

15. Specimens possessing only the anterior portion of one eye, when illuminated from in front, do not turn sharply toward the side containing the eye, as do specimens possessing one entire eye. The loss of this reaction in such specimens is probably due to the loss of the rhabdomes situated on the posterior margin of the pigment-cup.

16. Removal of the posterior portion of the eye does not impair the capacity of the remainder of the eye to function in a normal manner.

17. Specimens possessing only the posterior portion of one eye react to light as do specimens with both eyes removed. Histological examination of such specimens shows, however, that removal of the anterior portion of the eye severs the connection between the remaining rhabdomes and the 'brain.'

18. The observed reactions in *Planaria* can be explained without assuming that the pigment-cup acts as a localizer of photic stimulation as suggested by Hesse ('97). It is possible, however, that the pigment has a limited localizing function in the individual retinula.

19. Light must strike a given rhabdome parallel with its longitudinal axis in order to cause stimulation of the rhabdome. Thus the position of the longitudinal axis of the rhabdomes results in a localization of photic stimulation.

20. It is possible to explain this localization of photic stimulation in the individual retinula: 1) by supposing that the highly refractive middle region of the retinula acts as a crude lens to concentrate the rays of light on the rhabdome; or 2) by assuming a certain structure of the rhabdomes coupled with the shading action of the pigment-cup. This last assumption ascribes a limited localizing function to the pigment, but it does not ascribe to the pigment the entire function of the localization of photic stimulation as is done by Hesse (page 106).

21. Correlated with the assumption that light must penetrate a given rhabdome parallel with its longitudinal axis in order to cause stimulation, we find that light in entering the pigment-cup from any given direction illuminates the rhabdomes confined to a definite area and that a large proportion of the rhabdomes in such areas always have their longitudinal axes directed parallel to the stimulating rays of light and, in the case of light from certain directions, all of the rhabdomes which are illuminated have their longitudinal axes so directed.

22. Once an animal is oriented in a horizontal beam of light, it receives no orienting stimulation until it leaves the path or axis of orientation.

23. Orientation to light is not necessarily dependent upon the symmetrical arrangement of the photoreceptors.

#### BIBLIOGRAPHY

- AREY, L. B. 1916 Changes in the rod-visual cells of the frog due to the action of light. *Jour. Comp. Neur.* vol. 26, pp. 429-442.
- ARISZ, W. H. 1911 On the connection between stimulus and effect in phototropic curvatures of seedlings of *Avena sativa*. *Kon. Ak. Wet. Amsterdam. Proc.*, pp. 1022-1031.
- BARDEEN, C. R. 1901 On the physiology of the *Planaria maculata* with especial reference to the phenomena of regeneration. *Am. Jour. Physiol.*, vol. 5, pp. 1-55.
- BLAAUW, A. H. 1908 The intensity of light and the length of illumination in the phototropic curvature in seedlings of *Arvena sativa*. *Kon. Ak. Wet. Amsterdam. Proc.*
- BÖHMIG, L. 1890 Untersuchungen über rhabdocöle Turbellarien. II. *Plagiostomia* and *Cylindrostomia* Graff. *Zeit. f. wiss. Zool.*, Bd. 51, S. 167-479.
- BORING, E. G. 1912 Note on the negative reaction under light adaptation in the planarian. *Jour. Animal Behav.*, vol. 2, pp. 229-248.

- CLARK, O. L. 1913 Über negativen Phototropismus bei *Avena sativa*. Botan. Zeitschr., Bd. 5, S. 737-770.
- CURTIS, W. C. 1902 The life history, the normal fission and the reproductive organs of *Planaria maculata*. Proc. Boston Soc. Nat. Hist., vol. 30, pp. 515-559.
- FRÖSCHEL, P. 1908 Untersuchungen über die heliotropische Präsentationszeit. Sitz.-Ber. math.-naturw. Kl. Akad. Wiss., Wien, Bd. 117, Abt. 1, S. 235-256.
- HESSE, R. 1897 Untersuchungen über die Organe der Lichtempfindung bei niederen Thieren. II. Die Augen der Plathelminthen, insonderheit der tricladen Turbellarien. Zeit. f. wiss. Zool., Bd. 62, S. 527-582.
- JÄNICHEN, E. 1896 Beiträge zur Kenntnis des Turbellarienauges. Zeit. f. wiss. Zool., Bd. 62, S. 250-288.
- KEPNER, W. A., AND FOSHEE, A. M. 1917 Effects of light and darkness on the eye of *Prorhynchus applanatus* Kennel. Jour. Exp. Zool., vol. 23, pp. 519-531.
- KEPNER, W. A., AND LAWRENCE, J. S. 1918 The eye of *Polycystis goettiei* (Bresslau). Jour. Exp. Zool., vol. 30, pp. 465-473.
- KEPNER, W. A., AND TALIAFERRO, W. H. 1916 Organs of special sense of *Prorhynchus applanatus* Kennel. Jour. Morph., vol. 27, pp. 163-177.
- LEIDY, J. 1847 Descriptions für die heliotropische Erscheinung bei Tieren. Sci. (Phila.), vol. 3, pp. 251-252.
- LILLIE, F. R. 1901 Notes on regeneration and regulation in planarians. Am. Jour. Physiol., vol. 6, pp. 129-141.
- LOEB, J. 1893 Über künstliche Umwandlung positiv heliotropischer Thiere in negativ heliotropische und umgekehrt. Arch. f. d. ges. Physiol., Bd. 54, S. 81-107.
- 1894 Beiträge zur Gehirnphysiologie der Würmer. Arch. f. d. ges. Physiol., Bd. 56, S. 247-269.
- 1916 The organism as a whole. New York, x + 379 pp.
- LOEB, J., AND EWALD, W. F. 1914 Über die Gültigkeit des Bunsen-Roscoe'schen Gesetzes für die heliotropische Erscheinung bei Tieren. Zentbl. f. Physiol., Bd. 27, S. 1165-1168.
- MAST, S. O. 1910 Preliminary report on reactions to light in marine Turbellaria. Carnegie Instit. Year Book, vol. 9, pp. 131-133.
- 1911 Light and the behavior of organisms. New York, xi + 410 pp.
- 1916 The process of orientation in the colonial organism, *Gonium pectorale*, and a study of the structure and function of the eyespot. Jour. Exp. Zool., vol. 20, pp. 1-17.
- PARKER, G. H., AND BURNETT, F. L. 1900 The reactions of planarians, with and without eyes, to light. Am. Jour. Physiol., vol. 4, pp. 373-385.
- PEARL, R. 1903 The movements and reactions of fresh-water planarians: A study of animal behaviour. Quart. Jour. Micro. Sci., vol. 46, pp. 509-714.
- SCHMIDT, A. T. 1902 Zur Kenntnis der Tricladenaugen und der Anatomie von *Polycladus gayi*. Zeit. f. wiss. Zool., Bd. 72, S. 545-564.
- SHERRINGTON, C. S. 1898 Cutaneous sensations. Text-book of physiology edited by E. A. Schäfer, vol. 2, pp. 920-1001.

- TALIAFERRO, W. H. 1917 Orientation to light in *Planaria* n. sp. and the function of the eyes. *Anat. Rec.*, vol. 11, pp. 524-526.
- WALTER, H. E. 1907 The reactions of planarians to light. *Jour. Exp. Zool.*, vol. 5, pp. 35-162.
- WOODWORTH, W. McM. 1897 Contributions to the morphology of the Turbellaria. II. On some Turbellaria from Illinois. *Bull. Mus. Comp. Zool. Harvard Coll.*, vol. 31, pp. 1-16.



Resumen por el autor, S. R. Detwiler.  
Laboratorios Zoológico y Anatómico, Escuela de Medicina,  
Universidad Yale.

Experimentos sobre la transplatación de los miembros en  
Amblystoma.

La formación de plexos nerviosos y la función de los miembros.

El miembro anterior de Amblystoma transplataado en una parte del cuerpo situada en uno de los segmentos comprendidos entre el primero y el séptimo de estos, a partir de la posición normal del órgano, presenta un decrecimiento normal en su capacidad para funcionar a medida que se transplanta mas lejos de su posición normal. El cambio de posición del miembro en un cierto número de segmentos no implica un cambio correspondiente en la posición de la inervación segmentaria de su plexo, existiendo por consiguiente, una marcada tendencia en los miembros transplataados a recibir inervación del nivel normal del miembro, en la médula espinal. Los miembros implantados tan posteriormente que es imposible que reciban inervación desde el nivel correspondiente de la médula obtienen la mayor parte de su inervación de los segmentos situados delante de ellos, en vez de recibirla de los segmentos correspondientes a la nueva posición de dichos miembros. El decrecimiento gradual de la función en los miembros transplataados en un sitio cada vez mas lejano del punto en que aparecen normalmente parece estar directamente relacionado con la inervación segmentaria, siendo mas perfecta la función cuando la inervación se deriva del nivel normal del miembro en la médula. Esta pérdida gradual de función se atribuye a conexiones centrales defectuosas mas bien que a una disminución en la inervación efectiva periférica. Los resultados de los experimentos indican que el miembro transplataado ejerce una influencia que guía a los nervios segmentarios que contribuyen a su inervación. La reacción hacia esta influencia parece ser mayor en los nervios procedentes del nivel normal del miembro en la médula, puesto que estos nervios se alargan mas para ponerse en conexión con el miembro que los procedentes de los segmentos posteriores al nivel del miembro.

## EXPERIMENTS ON THE TRANSPLANTATION OF LIMBS IN AMBLYSTOMA

THE FORMATION OF NERVE PLEXUSES AND THE FUNCTION OF THE  
LIMBS

S. R. DETWILER

*Osborn Zoological Laboratory and the Anatomical Laboratory, School of Medicine,  
Yale University*

TWENTY-TWO FIGURES

### INTRODUCTION

The transplantation of limbs constitutes an experimental method which has been applied to the solution of a number of fundamental questions concerning the development of the peripheral nervous system. Without doubt the most important applications of this method were made in connection with the question of the genesis of the nerve fiber in the work of Braus ('04 and '05), Banchi ('06), Gemelli ('06), and Harrison ('07).

Aside from their bearing upon the specific problem of the genesis of the nerve fiber, the transplantation experiments with the exception of those of Banchi showed in general that if a limb bud is transplanted to an abnormal (heterotopic) position it will acquire a system of nerves which are connected with that part of the central nervous system of the host corresponding to the position occupied by the implanted limb rudiment.

Although Braus ('05) claimed that aneurogenic limb buds (those taken from nerveless larvae) did not acquire nervous connection with the host, Harrison's experiments showed that aneurogenic as well as euneurogenic limb buds (those taken from normal larvae) became supplied with peripheral nerves. That such nerves were partially functional was shown by slight voluntary movements of the limbs as well as by movements in response to electrical stimulation.

Apparently in all these cases the function of the limb was greatly restricted, and in no case cited was there any adaptive or coördinated movements. Harrison ('07, p. 256), in describing his first experiment, says in regard to the function of an aneurogenic limb, "No attempts were made to stimulate electrically, but spontaneous movements, though slight, were unmistakable."

Both Braus and Harrison observed that, regardless of the segmental nerve contribution, the architecture of the intrinsic nerve distribution is exactly the same as that in a normal limb. This is not an unusual phenomenon, for we know that in both normal and transplanted limbs, nerves reach the limb when it is still in the blastema stage. The union of the nerve with the differentiating limb system is made very early, so that in either case the final plan of nerve distribution is patterned according to skeletal-muscular differentiation and growth, probably in accordance with Naussbaum's law: that the course of the nerve within the muscle is an index of the direction in which the muscle has grown.

The experiments to which reference has thus far been made were carried out on the anuran embryo, *Bombinator* being used by Braus, *Bufo vulgaris* by Banchi and Gemelli, and *Rana sylvatica* and *Bufo lentiginosus* by Harrison. In the majority of cases the limb buds were transplanted at a stage when the peripheral nerves were in part or completely developed. Accordingly, when the wound in the host was made for the reception of the transplant, the terminal branches of the nerves of that region were severed and the implanted limb rudiment was placed in close apposition to the cut ends. Although these nerves so disturbed were originally intended to innervate other muscles, it was found that they would readily grow into the implanted embryonic rudiment and innervate the differentiating limb muscles as do the nerves in the normal situation. This fact would indicate that there is no specificity of a given motor neurone for any particular muscle fiber, so that the ultimate distribution and connection of the nerve fiber cannot be an intrinsic factor of the neurone.



This leaves open the question of whether or not the limb rudiment, either in the normal or the heterotopic position, exerts any directive influence upon the segmental contribution of the spinal nerves or upon the final path taken by them in the innervation of the limb. The possibility of the limb's exerting any such influence on the developing peripheral nerves could hardly be adequately tested by transplanting limb buds to larvae in which the peripheral nerve paths have already been formed, such as in the experiments hitherto described. As we have seen, limb buds in these cases are placed in the direct pathway of a number of already formed spinal nerves, the peripheral ends of which are severed in preparing the wound, and it is expected that these nerves should continue their growth into the rudiment so placed.

Evidence as to whether or not the limb rudiment does exert any influence on the segmental contribution and on the path of the spinal nerves entering into the formation of the nerve plexus ought to be obtained by transplanting limb rudiments in embryos at a period before the spinal nerves have begun to develop. Then, any possible influence on the part of the end organ can exert itself on the nerve fibers at a time when initial outgrowth takes place. In the Urodele, *Amblystoma punctatum*, the anterior limb rudiment can readily be transplanted at such a period. In the present paper, which contains a description of a series of both autoplasmic and homoplasmic transplantations on this form, certain findings are set forth which strongly suggest such an influence on the part of the limb.

Another very important question on which the experimental results contained in this paper throw some light deals with the part played by functional activity of the limb on the differentiation of neuroblasts.

The general problem of the effect of functional activity of an end organ on the differentiation of neuroblasts is one which has been tested but little by the experimental method, and the results of different investigations as they stand to-day are not entirely compatible.

The method of attacking this problem up to the present time has consisted in extirpating the end organ at a period either before or shortly after the peripheral nerves have begun to develop and of observing the effect of its absence on that part of the central nervous system ordinarily supplying it with nerve components.

Braus ('06) extirpated the forelimb buds of *Bombinator* at a period prior to the outgrowth of the brachial plexus, with a view of determining the effect of the absence of the limb on the ventral horn region of the spinal cord corresponding to the limb level. It was found, from a study of larvae preserved ten days after the operation, that the brachial nerves had grown out to the limbless area and that they were as well formed as those on the uninjured side. No reduction in size or number of the ventral horn cells could be detected. Observations, however, on operated larvae which were kept alive until just before metamorphosis showed that not only was the brachial plexus on the limbless side diminished in size when compared with its counterpart, but that, in addition, there was a distinct reduction in the size of the ventral horn area ordinarily supplying the limb. As a corollary to the general developmental theory of Roux ('85), Braus concluded that the development of the 'central nervous system,' is readily divisible into two periods: the first, in which growth and differentiation are independent of functional activity, and, the second, in which further differentiation and growth continue only when under the influence of functional activity.

Miss Shorey ('09), who performed a series of extirpation experiments on the limb buds of the chick and the amphibian embryos, came to the rather sweeping conclusion from her findings that no neuroblasts are self-differentiating and that all are alike dependent for differentiation on stimulation from end organs or from the products of the activities of end organs.

Although the experiments of Harrison ('10) left no doubt that the initial differentiation of the nerve fiber is a factor predetermined within the neuroblasts, they did not attempt to give any definite information on the part played by functional activity on the later differentiation of neuroblasts.

It was suggested by Doctor Harrison that the best way of testing the influence of functional activity on the differentiation of neuroblasts would consist not solely of removing the end organ and noting the effects of its absence, but rather of transplanting the end organ so that it might function in a new environment. In this way not only could the effects of removal be noted, but still better, the effect of continued function of the transplanted end organ on that part of the central nervous system from which its innervation is derived.

Accordingly, experiments were begun with this problem in mind, and while positive evidence has been attained from these experiments to show that the functional activity of the transplanted limb will initiate a hyperplasia of the sensory neurones contributing innervation to the limb, the results of this phase of the experiments are taken up in a separate publication (Detwiler, '20). The present paper will consider questions mainly concerned in the formation of nerve plexuses and the function of the limbs.

I wish to express here my thanks to Doctor Harrison for his suggestions and criticisms.

#### ANATOMICAL

Even though a transplanted limb may be well innervated by spinal nerves of the host, it is obvious that the degree of function of the limb is conditioned by still other factors. Structural deficiencies of the shoulder-girdle or deficiencies in the shoulder musculature would greatly restrict its function, even though the limb were copiously supplied with nerves and the structures within it were perfectly developed.

Although the developmental intimacy of the shoulder-girdle and limb led Wiedersheim ('92) to conclude that the shoulder-girdle can develop only when under the formative influence of the free extremity, the lack of interdependence of these two systems has been shown experimentally (Braus, '09, and Detwiler, '18). It has also been shown (Braus, *op. cit.*, Harrison, '18, and Detwiler, *op. cit.*) that in the transplantation of a typical

limb bud, only a portion of the girdle rudiment is included. From his experiments on *Bombinator*, Braus ('09) claimed that from this fraction of the rudiment a complete girdle of reduced size is developed, and he concluded that the shoulder-girdle rudiment, like that of the limb, constitutes an equipotential restitution system. Experiments hitherto reported (Detwiler, op. cit.) have shown that this rudiment in *Amblystoma punctatum* constitutes a mosaic and is incapable of qualitative restitution. When transplanted, only such components of the girdle develop as are represented in the corresponding portions of the implanted rudiment. Such girdles, however, although qualitatively incomplete, may become topographically complete by a process of hyperplasia which compensates for qualitative deficiencies. This is well illustrated in cases where in the absence of the suprascapular rudiment the dorsal zone of the girdle becomes practically completed by hyperplastic development of the intact portion. The above is not always the case, however, and inasmuch as there is considerable variability in the degree of development of the shoulder-girdle in the heterotopic position, restricted function of the limb may be a result of marked deficiencies in the girdle.

Intimately associated with the development of the shoulder-girdle is the development of the shoulder muscles. These, however, may develop and differentiate independently of one another so that with a well-developed girdle there may be muscular deficiencies.

The lack of interdependence of muscle and skeletal differentiation has previously been shown. Braus ('06 a) showed this to be true in the development of the pectoral fin of the *Elasmo-branch* embryo. Personal observations on the development of the shoulder-girdle of *Amblystoma* have shown that in the absence of skeletal differentiation, shoulder muscles may develop. It is obvious, therefore, that restricted function may result from muscular deficiencies in addition to those of the girdle.

Even though skeletal and muscular differentiation may be complete, restricted function of the limb might be due to the failure of certain of the individual muscles to receive innervation, so that this offers a third factor conditioning the degree of function.

With the above possibilities in mind it became necessary, for proper interpretation of the results, to make a study of the normal anatomy and the normal conditions of innervation. The brief description which is herewith presented is based upon a study of a series of cross-sections ( $10\mu$ ) of a specimen preserved seventy days after the closure of the medullary folds. This has been augmented by a dissection of the shoulder region of an adult specimen.

### *A. Shoulder-girdle*

A description of the cartilaginous girdle as found in a larva twenty days after the closure of the neural folds has previously been given (Detwiler, '18, p. 501, and fig. 23). The conditions found in a larva of seventy days do not show fundamental alterations in general topography. The suprascapula has extended its growth somewhat more dorsal and has lengthened out in an anteroposterior direction so as to form a flat plate of cartilage. The procoracoid has expanded in an anteroventral direction and the coracoid has undergone a ventral expansion so as to overlap its counterpart in the midventral line. The scapula has undergone partial ossification and that portion of the procoracoid which enters into the formation of the glenoid cavity, although still cartilaginous, is about to undergo ossification. This is suggested by the greatly enlarged cartilage lacunae in that region. The adult shoulder-girdle is illustrated in figure 1. The entire scapula, together with those portions of the procoracoid and the coracoid which enter into the formation of the glenoid fossa, have become ossified. The greater part of the procoracoid and coracoid and also the entire suprascapula remain cartilaginous throughout life.

### *B. Shoulder muscles*

So far as could be ascertained, no description of the shoulder muscle of *Amblystoma* appears in the literature. The musculature, however, so far as has been studied, closely resembles that of *Salamandra*, a European tailed Amphibian described

by Fürbringer ('73). In referring to the musculature, Fürbringer's nomenclature will be employed.

The shoulder muscles may be separated into two groups, viz., the trunk muscles or those of myotomic derivation and the so-called limb muscles or those of somatopleural origin. The former group contains the following: *m. cucullaris* (trapezius: Mivart), *m. serratus magnus* (*serratus magnus anticus*), *m. levator scapulae*, and the *m. pectori-scapularis internus*. None of these muscles derive their innervation from nerves entering into the formation of the brachial plexus.

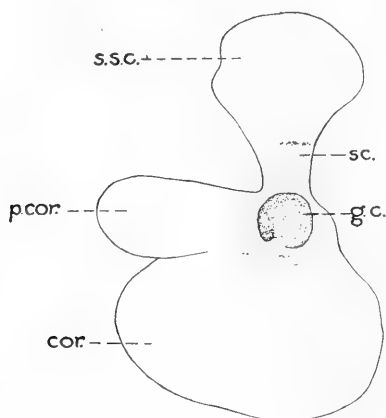

Fig. 1 Outline drawing of the normal shoulder girdle of an adult specimen of *Amblystoma*. Stippled area represents bony portion.  $\times 3\frac{1}{3}$ . *s.sc.*, supra-scapula; *sc.*, scapula; *p.cor.*, procoracoid; *cor.*, coracoid; *g.c.*, glenoid cavity.

The second group contains the following: *m. supracoracoideus*, *m. procoraco-humeralis*, *m. dorsalis scapulae* (*deltoid*: Mivart; *infraspinatus*, *deltoideus* and *teres minor*: Humphrey), *m. pectoralis* (*pectoralis major* and *minor*), *m. subcoraco-scapularis* (*subscapular*: Mivart), *m. latissimus dorsi*, *m. coraco-brachialis brevis*, *m. coraco-brachialis longus*, *m. anconaeus scapularis medialis*. This last muscle is undoubtedly the homologue of the long or scapular head of the *triceps brachii* of man. All of the muscles in the second group receive their innervation from branches of the brachial plexus.

Since the rudiments of the muscles in the first group never become implanted along with the limb rudiment in a typical transplantation, it will not be necessary to consider the normal anatomy of these muscles. However, the rudiments of the muscles of the second group are involved in the transplantation, and for this reason a brief description of these muscles as they occur in their normal situation becomes necessary.

1. *M. supracoracoideus*. This is a broad, flat, fan-shaped muscle which takes its origin from the entire external surface of the coracoid with the exception of the medial and posterior margins. Its fibers converge to be inserted on the proximal part of the processus lateralis humeri.

Innervation: n. supracoracoideus (fig. 2, *n. sp. cor.*), a branch of the third spinal nerve.

2. *M. procoraco-humeralis*. This is a somewhat longer and narrower muscle than the m. supracoracoideus. Its fibers take origin from the external surface of the procoracoid with the exception of the distal anteromedial and anterolateral margins. The fibers converge proximally and become inserted on the processus lateralis humeri between the insertion of the m. supracoracoideus and the m. dorsalis scapulae.

Innervation: through a branch of the third spinal nerve (fig. 2, *n. p. cor.*).

3. *M. dorsalis scapulae*. This is a somewhat thicker muscle than the m. supracoracoideus and the m. procoraco-humeralis and takes origin from the entire external surface of the cartilaginous suprascapula with the exception of the dorsal, anterior, and posterior margins, the latter two of which serve for respective insertions of the m. levator scapulae and a portion of the m. serratus magnus. The muscle passes down over the external surface of the scapula, crosses over the tendon of the m. latissimus dorsi, and inserts by means of a flat tendon on the processus lateralis humeri, medial to the insertion of the m. procoraco-humeralis.

Innervation: by several short branches from the third spinal nerve (fig. 2, *n. ds. c.*).

4. *M. pectoralis*. This constitutes a triangular-shaped muscle taking origin from the aponeurosis between it and the *m. obliquus externus abdominis*, the *linea alba*, and from a cartilaginous sternum. Its fibers converge into a short tendon which inserts on the distal part of the *processus lateralis humeri*.

Innervation: *n. pectoralis*, a branch of the common trunk formed by the union of the fourth and fifth spinal nerves (fig. 2, *n. pc.*).

5. *M. subcoraco-scapularis*. This is a short, thick muscle which takes origin from the medial side of the contiguous portions of the scapula and the *procoracoid*. The fibers pass out across the inner aspect of the shoulder joint and insert on the medial surface of the proximal part of the humerus.

Innervation: *n. subscapularis*, a branch of the third spinal nerve (fig. 2, *n. sb. sc.*).

6. *M. latissimus dorsi*. This is a broad triangular muscle which arises from an aponeurosis between it and the longitudinal dorsal trunk muscles. The fibers converge into a long tendon, a part of which unites with the tendon of origin of the *m. anconaeus scapularis medialis*; the remainder passes across the lateral aspect of the shoulder capsule and inserts on the proximal dorso-lateral surface of the humerus close to the *processus lateralis humeri*.

Innervation: *n. latissimus dorsi*, a branch of the fourth spinal nerve (fig. 2, *n. lt. dor.*).

7. *M. coraco-brachialis brevis*. This is a short, rather thick muscle which takes origin from the posterior margin and from the outer surface of the posterior part of the coracoid, internal to the *m. supracoracoideus*. The muscle passes to the medio-ventral surface of the humerus and inserts on its proximal two-fifths and under cover of the fibers of the *m. brachialis inferior* (*m. biceps brachii*).

Innervation: by the *n. coraco-brachialis*, a branch of the fourth and fifth spinal nerves (fig. 2, *n. cor. br.*).

8. *M. coraco-brachialis longus*. This is a long, rather thick muscle which takes origin from the internal posterior margin of the coracoid close to the glenoid cavity. It passes out along the



ventral surface of the humerus, ventral to the m. anconaeus scapularis medialis and medial to the m. brachialis inferior. It inserts on the ventral surface of the distal two-fifths of the humerus.

Innervation: by the n. coraco-brachialis (fig. 2, *n. cor. br.*).

9. *M. anconaeus scapularis medialis.* This muscle takes origin by means of a long, flat tendon from the glenoid margin of the scapula and from the capsule of the shoulder joint. A portion unites with the tendon of the m. latissimus dorsi; the remainder passes out on the dorsomedial surface of the humerus, between the m. coraco-brachialis and the m. anconaeus humeralis lateralis with which it finally unites. It inserts in common with the m. anconaeus humeralis lateralis and the m. anconaeus humeralis medialis on the olecranon process of the ulna.

Innervation: through the n. brachialis longus superior.

According to Fürbringer some of the deep posterior fibers of the m. supracoracoideus in *Salamandra* leave this muscle, join the fibers of the m. brachialis inferior and insert with it on the proximal part of the radius and ulna. This muscle he calls the m. coraco-radialis proprius. A similar structure in *Amblystoma* could not be identified either in the larval or in the adult individual.

### *C. The brachial plexus*

In the so-called tail-bud stage, the period of development in which the experiments reported in this paper were carried out, the position and extent of the anterior limb rudiment, as has already been shown by Harrison ('15), constitutes a slightly thickened region of somatopleural mesoderm lying just ventral to the pronephros and extending from the anterior border of the third somite to the posterior border of the fifth. The normal anterior limb is supplied by a plexus composed of the third, fourth, and fifth spinal nerves (fig. 2). The outgrowing nerves above enumerated, effecting connection with the limb rudiment at a period when it occupies its maximum extent (anterior border of the third somite to the posterior border of the fifth) become converged into a plexus as a result of concentration of the rudi-

ment into the definitive limb bud which centers ventral to the fourth myotome. Such convergence having taken place, a typical normal plexus as illustrated in figure 2 would be produced.

It has long since been pointed out, especially by Fürbringer ('79), that the nerve plexus from which a limb is supplied might, in two cases, have a different segmental origin and yet the intrinsic nerves arising from the plexus might be distributed in the same manner in each.

From his own transplantation experiments, Harrison ('07) showed that there are two main factors involved in the development of the innervation of a limb: first, the position and extent

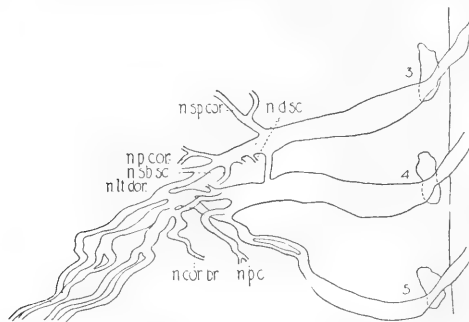

Fig. 2 Graphic reconstruction of the normal left brachial plexus of case AS4<sub>26</sub> (fig. 13), preserved sixty-eight days after the operation.  $\times 20$ . *n.sp.cor.*, nerve to musc. supracoracoideus; *n.p.cor.*, nerve to musc. procoracohumeralis; *n.d.sc.*, nerve to musc. dorsalis scapulae; *n.pc.*, nerve to musc. pectoralis; *n.sb.sc.*, nerve to musc. subcoraco scapularis; *n.cor.br.*, nerve to musc. coraco-brachialis; *n.lt.dor.*, nerve to musc. latissimus dorsi.

of the extremity at the time of origin which determines the source of the nerve supply, and, secondly, the mode of segregation and growth of the individual structures of the limb which governs the intrinsic distribution of its nerves.

As the result of a study of the normal plexus formation, in addition to the observations of Harrison, the evidence at hand tends to show that the position and extent of the limb rudiment serves as an index of the number of spinal nerves supplying the extremity, the number corresponding with that of the segments occupied by the limb rudiment at the period when initial connection is made. This, then, would not only readily account

for differences in the number of spinal segments which contribute nerves to the limbs in different species, but it would also account for slight variations in the segmental contribution to the limb plexus in a given species—a condition which, as has been referred to above, has long since been observed.

If the extent of the limb rudiment were the only factor to account for this latter phenomenon, then the limb rudiment, if displaced the distance of several segments, should so effect the nerve contribution that the new plexus would come from segments corresponding to the position occupied by the displaced limb rudiment. The results of the experiments reported in this paper indicate that, in addition to the position and extent of the limb rudiment, still other factors govern the innervation of limbs when developed from rudiments lying beyond the confines of the orthotopic position.



Fig. 3 Camera-lucida drawing of an embryo of *Amblystoma* in the tail-bud stage. The circle situated ventral to the pronephros (*pn*) indicates the position of the limb rudiment.  $\times 15$ .

#### EXPERIMENTAL

The experiments were carried out upon embryos in the tail-bud stage (fig. 3). The extent of the limb rudiment at this period has been described above. The technique employed in embryonic limb transplantation is so well known through the papers of Harrison, Braus, and others that no special description is here required. All of the experiments were made upon the anterior limb rudiment. The majority consisted of transplanting the right anterior limb rudiment to an abnormal (heterotopic) position on the same side of the body from which it was

taken, and at distances ranging from one to seven segments posterior to the normal situation. These experiments constitute the autoplasmic transplantations.

In other experiments the normal anterior limb was left intact and additional right anterior limb rudiments from other embryos were implanted respectively the distance of three, four, and five segments posterior to the normal intact limb rudiment of the host. These latter experiments constitute the homoplasmic transplantations.

The larvae were preserved in sublimate-acetic fixing fluid at intervals from thirty to eighty days after the operation, the majority being under observation for about sixty days. A study of the animals was made from transverse sections cut  $10\mu$  in thickness and stained with Ehrlich's haematoxylin and erythrosin.

#### *A. Autoplasmic transplantations*

*Series AS1.* In this series of experiments the limb rudiment was excised and reimplanted the distance of one body segment posterior to its normal position so that the rudiment, instead of centering ventral to the fourth somite as it does in the normal condition, now centers ventral to the fifth somite (fig. 4). The results of this series of experiments are presented in table 1, series AS1. By examination of this table it is seen that 95 per cent of limb rudiments so placed developed into normal limbs, there being only one case in twenty positive experiments in which the rudiment developed into a reduplicated appendage.

The criteria used in establishing the category 'normal limbs' were based purely upon superficial conditions, the limb being classed as 'normal' only when a brachium, antibrachium, and a manus with the proper number of digits were developed.

It is also seen (table 1) that 95 per cent of the limbs so transplanted functioned perfectly, the movements being adaptive and well coordinated with those of the opposite intact limb.

The criteria employed in establishing the category 'perfect function' were: 1) movements of the arm on the shoulder, viz., flexion, extension, abduction, adduction, rotation, and circum-

duction; 2) flexion and extension of the forearm; 3) flexion and extension of the carpus, and, 4) movements of the digits. When the transplanted limb showed inability to carry out all of these movements such as occur in the normal intact limb, it was placed in the category, 'function impaired' (table 1).

The functional behavior of the transplanted limbs in all series was closely observed and recorded, these observations being

TABLE 1

- A. Showing the results of transplanting the right anterior limb rudiment a given number of segments (AS1, AS2, AS3, etc.) posterior to its normal position
- B. Showing the results of transplanting an additional anterior limb rudiment to an embryo in which the normal limb rudiments have been left intact. HS3, HS4 and HS5 indicate the successive number of segments the additional limb rudiment was implanted posterior to the normal right anterior limb of the host

SERIES	OPERA-TIONS	POSITIVE EXPERI-MENTS	NORMAL LIMBS		REDUPLI-CATIONS		FUNCTIONAL LIMBS		NO FUNCTION		FUNCTION IMPAIRED		FUNCTION PERFECT	
			Cases	Per cent	Cases	Per cent	Cases	Per cent	Cases	Per cent	Cases	Per cent	Cases	Per cent
			A											
AS1	25	20	19	95.0	1	5.0	20	100.0	0	0	1	5.0	19	95.0
AS2	21	18	17	94.5	1	5.5	17	100.0	0	0	3	16.7	15	83.3
AS3	24	17	13	76.5	4	23.5	15	88.2	2	11.8	4	23.5	11	64.7
AS4	34	29	18	67.0	11	33.0	23	79.3	6	20.7	11	37.9	12	41.4
AS5	35	30	11	36.7	19	63.3	20	66.7	10	33.3	16	53.3	4	13.4
AS6	35	29	22	75.9	7	24.1	15	51.7	14	48.3	15	51.7	0	0
B														
HS3	10	9	2	22.2	7	77.8	9	100.0	0	0	6	66.7	3	33.3
HS4	30	21	8	38.1	13	61.9	11	52.4	10	47.6	11	52.4	0	0
HS5	30	25	11	44.0	14	56.0	13	52.0	12	48.0	13	52.0	0	0

frequently made from a period when normal limb reflexes first began to appear until preservation of the animal. The method employed in studying the limb reflexes consisted in the temporary transfer of the animal from the individual aquarium (battery jar) in which it was reared, to a small receptacle, such as a watch-glass. In this way the animal could be brought under direct observation either through the use of a binocular microscope or

a dissecting microscope. The general behavior of the limbs in response to externally applied stimuli could thus be carefully studied. The most successful method of studying the behavior of the limbs in response to applied tactile stimulation consisted in inhibiting total swimming movements which so characteristically dominate the action system at this period, by placing the animal in very shallow water. By so doing, swimming movements could be performed only with considerable difficulty, resulting thereby in an increased effort on the part of the animal to progress solely by means of its limbs.

The first appearance of reflexes in the transplanted limbs of series ASI did not appear until about two days after the first appearance of those in the normal intact limb, which were first noticed about fourteen days after the operation. This slight delay is probably an index of the period required for reorganization and readjustment of the limb rudiment subsequent to its reimplantation.

The time after the operation when the normal limb reflexes first appear cannot adequately be stated in terms of days, owing to the fact that the various factors which determine the rate of growth were not entirely controlled. In general, however, it can be stated that normal limb reflexes begin at a period when the third digit makes its first appearance. At this time the yolk is almost, if not entirely, absorbed and the larva begins to feed. A description of the normal development of the external features of the limb up to this period has been given by Harrison ('18, page 417).

Of the series ASI, case 12, preserved sixty-four days after the operation, was sectioned and studied. The transplanted limb is innervated by a plexus composed of the normal segmental nerve components (table 2) and the intrinsic nerve distribution within the limb is practically identical with that in the normal limb. No shoulder muscles of the group which typically develop in the heterotopic position (table 3) were lacking and all received peripheral innervation. The shoulder-girdle was somewhat atypical. The coracoid was rather short, the procoracoid and scapula were abnormally thick and the more dorsal portion of

the girdle was continuous with the original suprascapula which had developed in situ from the unremoved suprascapula rudiment when the limb was transplanted.

It has previously been shown that the operation employed in extirpating the limb leaves in the embryo portions of the rudi-

TABLE 2

*Showing the segmental nerve contribution of the right anterior limb when implanted successively a number of segments (1 to 7) posterior to its normal position*

SERIES	CASES	POSITION OF LIMB. NUMBER OF SEGMENTS POSTERIOR TO NORMAL	SEGMENTAL NERVE CONTRIBUTION								
			3	4	5	6	7	8	9	10	11
Normal.....	1	0	3	4	5						
AS1.....	12	1	3	4	5						
AS2.....	5	2	3	4	5						
	12	2	3	4	5						
AS3.....	9	3		4	5	6					
	18	3		4	5	6					
AS4.....	12	4		4	5	6	7				
	27	4				6	7	8			
	26	4			5	6	7				
	30	4			5	6	7				
AS5.....	25	5			5	6	7	8	9		
	27	5				6	7	8	9		
	23	5					7	8	9		
	30	5				6	7	8	9		
	26	5					7	8	9		
AS6.....	29	6						8	9	10	
	5	6							9	10	
AS7.....	5	7								10	11

ments of the suprascapula, the coracoid and occasionally the procoracoid (Harrison, '18, and Detwiler, '18), so that the shoulder-girdle which develops in the heterotopic position does so from the more central portion of the rudiment which is included with that of the limb in a typical bud transplantation.

*Series AS2.* In this series of experiments the limb rudiment was excised and reimplanted the distance of two segments posterior to the normal position, so that the rudiment which originally extended from the anterior border of the third myotome to the posterior border of the fifth, now occupies a region from the anterior border of the fifth myotome to the posterior border of the seventh; and this rudiment, subsequent to its convergence into the definitive limb bud, centers ventral to the sixth myotome instead of the fourth, as in the normal situation (fig. 5). The denuded area underneath the third and fourth somites was covered by ectoderm taken from another individual.

In eighteen positive experiments of this series there occurred only one in which a reduplicated appendage developed. The remainder gave rise to normal limbs (table 1). The results of the study of the behavior of these limbs showed that, although all were capable of movements, 16 per cent showed restricted movements. The remainder functioned normally (table 1 and fig. 9).

Two individual cases of this series, viz., AS2<sub>5</sub> and AS2<sub>12</sub> (preserved, respectively, fifty-six and fifty-two days after the operation, were sectioned and studied. The heterotopic limbs in both cases were found to receive the normal segmental nerve contribution, the plexus in each case being derived from the third, fourth, and fifth nerves (table 2). Such being the case, it is highly probable that all of the series AS1 were likewise innervated by the third, fourth, and fifth nerves, such as was found in case AS1<sub>12</sub> (table 2).

An examination of the shoulder musculature in cases AS2<sub>5</sub> and AS2<sub>12</sub> showed that here, too, all of the muscles which typically differentiate in the heterotopic position were developed (table 3), and that all were supplied with peripheral nerves. The structures within the limbs showed essentially a normal arrangement and the nerves a normal intrinsic distribution. The shoulder-girdles showed no defects other than a short suprascapula and a poorly developed procoracoid in case AS2<sub>12</sub> (table 4).

Whether all of the heterotopic limbs of this series received the normal segmental nerve contribution cannot be definitely stated.



If so, the 16 per cent which exhibited impaired function is most likely a result of structural deficiencies in the girdle and shoulder muscles or is due to defective peripheral innervation.

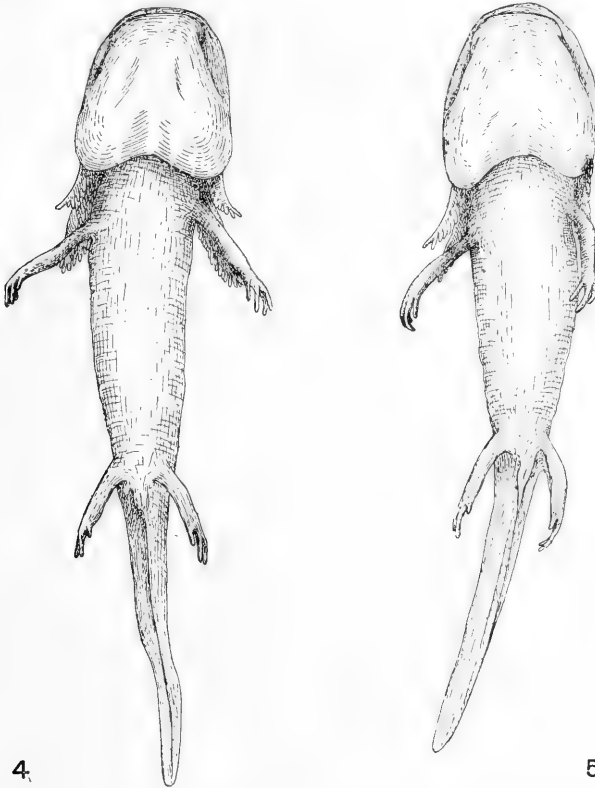

Fig. 4 Outline drawing of case AS1<sub>12</sub>. Right anterior limb excised and reimplanted the distance of one segment posterior to the normal position. Animal preserved sixty-four days after the operation.  $\times 5$ .

Fig. 5 Outline drawing of individual AS2<sub>12</sub>. Right anterior limb transplanted the distance of two segments posterior to the normal position. Animal preserved fifty-two days after the operation.  $\times 5$ .

The period at which the limb reflexes began to appear in the heterotopic limbs of this series was no more delayed when compared with the normal intact limb than in the series AS1—the reflexes first appearing in the normal limb about fourteen days

TABLE 3

*Enumerating the shoulder muscles which developed with the transplanted limb, and the presence or absence of their respective nerve supply*

INDIVIDUAL CASES	MUSCLES										M. pectoralis	
	M. procoraco-numeralis	M. subcoraco-scapularis	M. supra-coracoideus	M. dorsalis scapulae	M. latissimus dorsi	M. anconaeus scapularis medialis	M. coraco-brachialis brevis	M. coraco-brachialis longus				
AS1 <sub>12</sub>	Present +	Present +	Present +	Present +	Present +	Present +	Present +	Present +	Present +	Present +	Present +	Present +
AS2 <sub>12</sub>	Present +	Present +	Present +	Present +	Present +	Present +	Present +	Present +	Present +	Present +	Present +	Present +
AS3 <sub>9</sub>	Present +	Present +	Present +	Present +	Present +	Present +	Present +	Present +	Present +	Present +	Present +	Present +
AS3 <sub>18</sub>	Present +	Present +	Present +	Present +	Present +	Present +	Present +	Present +	Present +	Present +	Present +	Present +
AS4 <sub>26</sub>	Present +	Present +	Present +	Present +	Present +	Present +	Present +	Present +	Present +	Present +	Present +	Present +
AS4 <sub>27</sub>	Present -	(Small) +	Present +	(Abnormal) -	Present +	Present +	(Short) -	Present +	Present +	Present +	(Very short) +	(Very short) +
AS5 <sub>23</sub>	Present +	(Small) +	Present +	(Abnormal) +	Present +	Present +	(Short) -	Present +	Present +	Present +	Present +	Present +
AS5 <sub>25</sub>	Present +	(Small) +	Present +	(Very small) +	Present +	Present +	(Short) +	Present +	Present +	Present +	Present +	Present +
AS5 <sub>26</sub>	Present +	(Small) +	Present -	(Very small) -	Present -	Present -	(Short) -	Present -	Present -	Present -	Present -	Present -
AS5 <sub>27</sub>	(Short) -	(Small) +	Present -	(Very small) -	Present +	Present +	(Short) +	Present +	Present +	Present +	Present +	Present +
AS6 <sub>29</sub>	(Short) +	(Small) +	Present +	(Very small) +	Present +	Present +	(Short) +	Present +	Present +	Present +	Present +	Present +

1 + indicates that the muscle is innervated; - indicates that the muscle lacks innervation.

after the operation, those in the heterotopic limbs appearing about two days later. This would indicate that the period of delay in this series has no correlation with the length of time required for the nerves to grow back to the heterotopic limb. As was the case in series AS1, the delay probably represents the time required for reorganization of the rudiment subsequent to its reimplantation.

*Series AS3.* Reimplanting the limb rudiment the distance of three segments posterior to the original position results in

TABLE 4

*Showing the development of the different components of the shoulder-girdle when implanted successively a number of segments (1 to 6) posterior to the normal position*

CASES	THE SHOULDER-GIRDLE			
	Suprascapula	Scapula	Procoracoid	Coracoid
AS1 <sub>12</sub> .....	Normal	Thick	Abbreviated	Short
AS2 <sub>12</sub> .....	Short	Normal	Very short	Normal
AS3 <sub>9</sub> .....	Short	Normal	Short	Short
AS3 <sub>18</sub> .....	Very short	Normal	Very small	Normal
AS4 <sub>26</sub> .....	Short and thick	Normal	Small	Normal
AS4 <sub>27</sub> .....	Short and thick	Normal	Small	Very short
AS5 <sub>23</sub> .....	Short	Normal	Well developed	Short
AS5 <sub>26</sub> .....	Short	Normal	Short and thick	Normal
AS5 <sub>27</sub> .....	Short	Normal	Absent	Normal
AS6 <sub>5</sub> .....	Short	Normal	Very small	Short
AS6 <sub>29</sub> .....	Short and thick	Normal	Very small	Well developed

a decreased number of cases with normal limbs, there being only thirteen such cases in seventeen positive experiments (table 1). A study of the functional behavior of limbs so transplanted shows also a decreased percentage of cases in which coördinated movements of the limbs could be perfectly carried out. Although 88 per cent of the limbs were capable of movements, only 64 per cent functioned perfectly, 23 per cent exhibiting impaired function, and 11 per cent being entirely incapable of movements (table 1 and fig. 7).

An examination of serial sections of cases 9 and 18 (table 2), preserved, respectively, sixty-four and sixty-six days after the operation, showed that in both cases the innervation was derived from plexuses formed by the fourth, fifth, and sixth spinal nerves (table 2). Although the limbs of this series were displaced posteriorly the distance of three segments, the segmental nerves contributing to the plexus were displaced by only one segment, so that the bulk of the innervation was derived from segments situated anterior to those corresponding to the position occupied by the transplanted limb.

All of the shoulder muscles in case AS3<sub>9</sub> were found to be present (table 3), the coraco-brachialis muscle, however, being very short. All of the shoulder muscles were supplied with nerves. The shoulder-girdle was well formed except for a short suprascapula and a curtailed development of the coracoid (table 4), the latter being a condition responsible for the brevity of the m. coraco-brachialis.

In case AS3<sub>18</sub>, muscular differentiation was also qualitatively complete, although the m. dorsalis scapulae and the m. procoracohumeralis were quite short, due to an imperfect development of those parts of the girdle giving origin to these muscles, viz., the suprascapula and procoracoid. The remaining parts of the shoulder-girdle were typically developed (table 4).

The m. latissimus dorsi received no nerve supply, resulting in an inability to the animal to draw the arm dorsoposteriorly. Defective innervation also of the m. triceps brachii resulted in partial extensor paralysis of the forearm. Other than these defects, peripheral innervation was complete.

In general, initial reflexes in the transplanted limbs of this series did not appear quite as early, when compared with the normal, as did those in the series AS1 and AS2, the period extending from two to ten days after the first appearance of reflexes in the normal limb, although the number of cases in which there was only slight delay exceeded those in which the delay was greater.

*Series AS4.* Transplanting the limb the distance of four segments posterior to its original position, so that the limb

rudiment centers ventral to the eighth somite, results in still greater decrease in the number of cases with normal limbs, and a corresponding increase in the number of cases in which reduplication of the rudiment occurred (table 1 a, series AS4). Seventy-nine per cent of limbs so transplanted became functional, although only 41 per cent exhibited perfect movements, the function of the remaining 38 per cent being impaired in one way or another (table 1 a, series AS4 and fig. 8).

The transplanted rudiments of this series, although placed ventral to the seventh, eighth, and ninth somites, became innervated by plexuses derived mainly from segments situated anterior to those corresponding to the position occupied by the limb rudiment, as was found to be the case in the series already described. The segmental nerve supply, although preëminently coming from the fourth, fifth, and sixth segments, exhibits some variation, as is shown in table 2. In case AS4<sub>12</sub> (fig. 14) the rudiment developed into a reduplicated appendage, the anterior disharmonic member of which became fully differentiated and functional, while the posterior harmonic member developed into a structurally deficient and atrophic appendage. As a consequence of reduplication, the anterior member, being nearer the original limb level than the posterior, was found to receive practically all of the nerve supply, which was contributed by the fourth, fifth, sixth, and seventh segments of the cord (table 2, case AS4<sub>12</sub>).

The anterior (disharmonic) member in this case did not begin to develop until eighteen days after the operation. At this period it began as a small knob-like growth on the radial side of the base of the harmonic limb, which up to this period had developed normally. The reduplicating bud developed with marked rapidity, and eleven days later it had differentiated into a normal appendage and had become functional. From this time on it rapidly improved in growth and function, while the posterior harmonic limb underwent gradual atrophy. The relative size of the two limbs at sixty-four days after the operation is shown in figure 14.

Reduplication of the limb rudiment was not accompanied by a reduplication of the shoulder-girdle, there being only one girdle, which, however, was reversed and in which there occurred two glenoid cavities, one for each member of the reduplication.

Braus ('09) claimed from his experiments on Bombinator that when reduplicating limbs arose from a single transplant, there occurred a corresponding reduplication of the shoulder-girdle—observations on which he partly based his conclusions that the shoulder-girdle, like the limb, constitutes an equipotential system. From the case (AS<sub>4</sub><sub>12</sub>) under consideration as well as from cases previously reported (Detwiler, '18), it can be said that reduplication of the limb in *Amblystoma* is not accompanied by reduplication of the shoulder-girdle.

The shoulder muscles to the anterior disharmonic limb in case AS<sub>4</sub><sub>12</sub> were normally developed and were well supplied with nerves, while the shoulder muscles to the harmonic limb showed marked deficiencies and no muscular differentiation whatsoever had taken place in the arm. No nerves could be traced to the limb.

Case AS<sub>4</sub><sub>26</sub>. In this specimen (fig. 13), preserved sixty-eight days after the operation, the transplanted limb was innervated by a plexus of nerves coming from the fifth, sixth, and seventh segments of the cord (table 2 and fig. 10). Limb reflexes in this case began about six days later than did those in the normal intact limb of the left side, although perfect coördinated function was not attained until fifteen days later. The shoulder musculature was typically developed (table 3) except for a rather short m. procoraco-humeralis, the result of an imperfect development of the coracoid.

The shoulder muscles were well supplied with peripheral nerves, as were also the muscles of the limb itself. Figure 2 represents a graphic reconstruction of the left normal brachial plexus of case AS<sub>4</sub><sub>26</sub>. Figure 10 is a reconstruction of the plexus supplying innervation to the transplanted limb which was centered ventral to the eighth myotome. The tendency for transplanted limbs to be innervated by nerves coming from segments of the cord situated anterior to the limb itself is well illustrated in this figure.

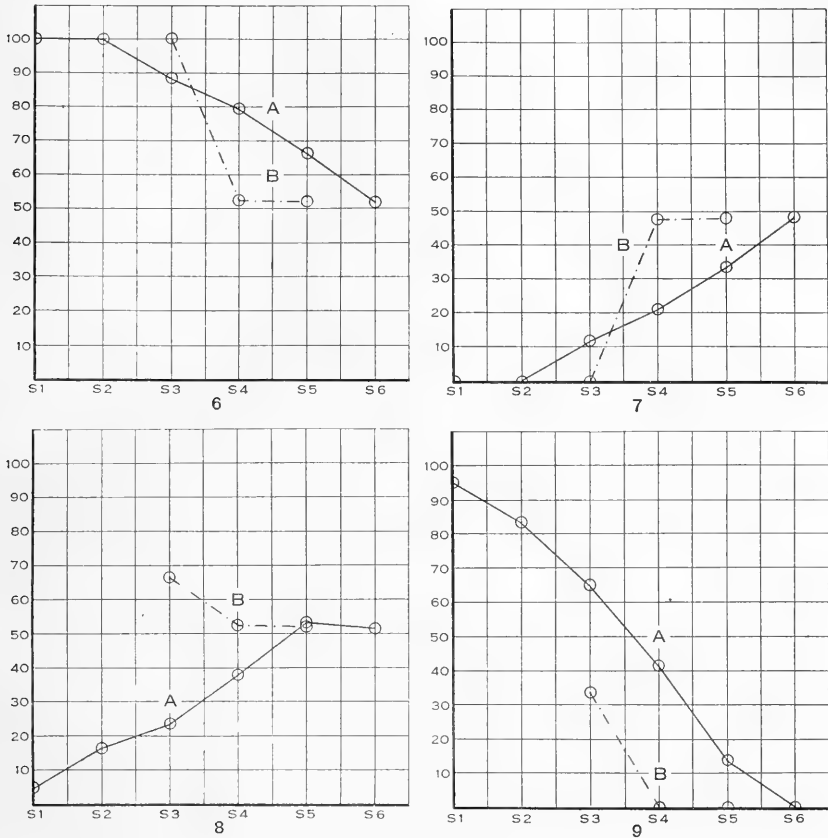

Fig. 6 A graph showing the relative percentage of functional limbs developed from transplanting the anterior limb rudiment a successive number of body segments (S1, S2, S3, etc.) posterior to the normal position (curve A); and from transplanting an additional anterior limb rudiment successively three, four, and five segments (S3, S4, S5) posterior to the normal anterior intact limb of the host (curve B).

Fig. 7 Graph showing the relative percentage of transplanted limbs developed with total loss of function. Conditions as in figure 6.

Fig. 8 Graph showing the relative percentage of transplanted limbs developed with impaired function. Conditions as in figure 6.

Fig. 9 Graph showing the relative percentages of transplanted limbs with perfect function. Condition as in figure 6.

The shoulder-girdle was quite typically developed for the heterotopic position, its only defect being a slightly reduced procoracoid and a short, thick suprascapula (table 4).

Reflexes in the majority of the transplanted limbs of this series began at different periods ranging from fifteen to twenty-six days after the operation, the majority of the limbs beginning to function about the eighteenth or nineteenth day; in other words, about four or five days after the first appearance of reflexes in the normal limb.

*Series AS5.* When the limb buds were transplanted the distance of five segments posterior to the normal position so that they centered ventral to the ninth somite, 63 per cent developed reduplicated appendages, there being only eleven cases in thirty positive experiments which developed into normal limbs (table 1 a, series AS5). The limbs of this series showed a still greater decrease in function than did those of the series AS4. Although there were twenty cases in thirty which could be classed in the category of functional limbs, only four cases functioned perfectly (table 1 a). Of this series of experiments five cases were sectioned and studied. The segmental nerve contribution to a number of cases of this series is shown in table 2. Although some variability in the segmental contribution is noticeable, it is also seen that, as in the series previously described, the bulk of the innervation comes from segments of the cord situated anterior to the position of the limb itself. The limb, although centering ventral to the ninth segment and extending over into the region of the eighth and tenth segments, receives no innervation from the latter segments of the cord.

Of the individuals sectioned, case AS5<sub>25</sub> (figs. 16 and 17) was the only one which exhibited perfect function. It is also found by an examination of table 2 that this was the only case of those sectioned which received innervation from the fifth segment, which, as has hitherto been shown, belongs to the normal limb level. Figure 11 represents a graphic reconstruction of the nerve plexus supplying the transplanted limb. Although the limb receives innervation from five segments, the bulk of the nerve fibers come from the fifth, sixth, and seventh segments of the cord.



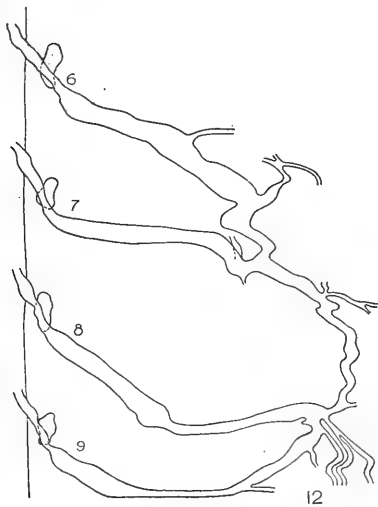
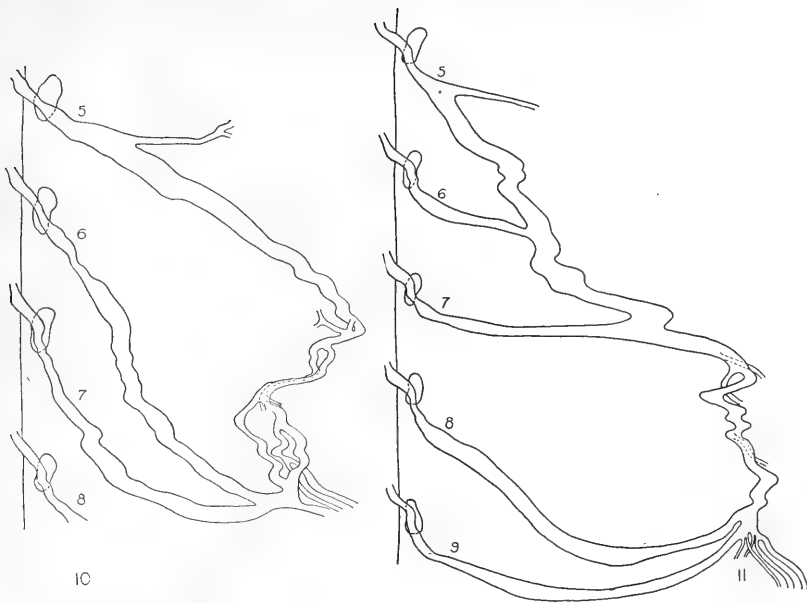

Fig. 10 Graphic reconstruction of the right brachial plexus of case AS<sub>426</sub>, showing the segmental nerve supply to the right anterior limb transplanted the distance of four segments posterior to the normal position. Animal preserved sixty-eight days after the operation.  $\times 20$ .

Fig. 11 Graphic reconstruction showing the segmental nerve supply to the right anterior limb of case AS<sub>525</sub>, the limb being transplanted the distance of five segments posterior to the normal position. Animal preserved sixty-four days after the operation.  $\times 20$ .

Fig. 12 Graphic reconstruction of the segmental nerve supply to the right anterior limb of case AS<sub>527</sub>, the limb transplanted the distance of five segments posterior to its normal position. Animal preserved sixty-five days after the operation.  $\times 20$ .

A study of the shoulder region of this individual showed that the shoulder muscles were well developed (table 3). Peripheral innervation to these muscles was also found to be complete. The shoulder-girdle was almost typical. The procoracoid, however, was poorly developed. The procoracoid is frequently considerably reduced in size or entirely lacking in the transplanted girdle. Experiments hitherto reported (Harrison, '18, and Detwiler, '18) have shown that, when the limb rudiment is transplanted, the procoracoid rudiment may be entirely excluded so that its entire development takes place in the old situation.

Since the girdle lacks the power of qualitative restitution (Detwiler, '18), variations, therefore, in its size and completeness are the results of a greater or less amount of the respective rudiments having been included in the transplant, added to, perhaps, certain mechanical factors governing its shape as it develops in different heterotopic positions.

In the remaining cases sectioned shoulder-muscle differentiation was on the whole as complete as in case AS5<sub>25</sub>, although the peripheral innervation was less perfect, a fact that would partly account for the restricted function which these cases exhibited (table 3).

Case AS5<sub>27</sub> (fig. 15), though exhibiting fair movements of the forearm, was very defective in shoulder movements. Although four segmental nerves contributed to the innervation of the transplanted limb (fig. 12), the shoulder muscles were poorly innervated, even though all had undergone complete differentiation, the following muscles being without nerve supply: m. procoraco-humeralis, m. supracoracoideus, m. dorsalis scapulae, m. coraco-brachialis longus, and the m. pectoralis (table 3).

The shoulder-girdle also exhibited some imperfections, the suprascapula being short and the procoracoid being entirely wanting (table 4). In such a case, incomplete or restricted function of the shoulder is clearly a result of defective peripheral innervation to its muscles.

Case AS5<sub>26</sub> showed a distinctly poor nerve supply to both shoulder and limb, both of which had undergone complete

muscular differentiation, in addition to a typically developed shoulder-girdle.

In general, however, the defective function of limbs in this position cannot be regarded as a result of factors already considered, but it is conditioned by other factors, which will be considered later. The completeness of function is in no way correlated with the time in days after the operation when reflexes first begin to appear. For example, in case AS5<sub>25</sub> limb reflexes began twenty-two days after the operation, while in some other cases with impaired function reflexes began as early as seventeen days after the operation.

*Series AS6.* Limbs transplanted six segments posterior to the normal position so that they centered ventral to the tenth somite were so far removed from the normal situation that there were no cases which functioned perfectly. Although 51 per cent were capable of some movement, in all cases the movements were greatly restricted (table 1 and fig. 8). Case AS6<sub>29</sub> of this series (fig. 20) was the only one in which were observed movements coördinated with those of the opposite intact limb, yet these movements were very restricted, especially movements of the arm on the shoulder. The segmental nerve contribution to the limb is shown in table 2.

In case AS6<sub>29</sub> all of the shoulder muscles were differentiated and all but three received peripheral innervation from a plexus composed of the eighth, ninth, and tenth segments of the cord. An examination of table 2 shows that peripheral innervation in this case was as complete as in limbs of the series AS5. The shoulder-girdle also was quite well developed and showed no more defects than in those not so distantly removed from the normal situation.

It has hitherto been observed (table 1) that there occurred a general increase in the number of reduplications as the limbs became transplanted farther and farther away from the normal situation. This, however, was not the case with series AS6, in which only 24 per cent developed reduplication, which is in marked contrast with the 63 per cent which reduplicated in series AS5. The small number of reduplicated appendages of the

series AS6 is a very striking and unlooked-for phenomenon, and since all of the factors underlying reduplications are not as yet understood, the decrease in this series is not explicable. In a great many cases the anterior or disharmonic member of the reduplication became more functional than the posterior or harmonic member, which probably is accounted for by the fact that it was closer to the source of the nerve supply and received the bulk of innervation. The fact that the disharmonic members of the reduplicated appendages frequently functioned more perfectly than the harmonic members would indicate that reduplication in itself can, in no wise, be adaptive. The non-adaptiveness is illustrated by such a case as AS4<sub>26</sub>, in which the posterior member of the reduplication underwent almost complete atrophy, while the anterior member functioned quite perfectly, even though disharmonic (fig. 14). These general observations would well agree with those of Harrison ('17), viz., that when innervation and vascularization are sufficient, a functional condition may arise which is independent of the harmony of the combination.

Although in the autoplasic experiments there occurred a gradual increase in the number of reduplications as the limbs became transplanted farther and farther away from the normal situation, the reverse was found to be the case in the homoplasic operations; i.e., those in which an additional limb was transplanted a given number of segments posterior to the normal intact limb (table 1b). All of these reduplicated appendages functioned very imperfectly.

With the present knowledge of the factors underlying reduplications, the results obtained from these experiments are not entirely explicable. It would, therefore, be premature to attempt to discuss the results other than to state as has above been pointed out: that there is no evidence to indicate that reduplication is in any way adaptive.

A few experiments were made in which the limbs were transplanted the distance of seven segments posterior to the normal position. Inasmuch as very imperfect movement was observed in limbs of the series AS6, it appeared highly probable that

limbs still farther removed from the normal region should exhibit little if any movements. Such was found to be true, since in twelve experiments so performed there occurred only one (case AS7<sub>5</sub>) in which any motion was observed and this consisted of a slight flexion of the carpus. This individual was sectioned and studied. The limb was found to be innervated from the tenth and eleventh segments of the cord (table 2). The shoulder-muscle innervation was quite defective. The number of cases of this series being small, they have not been included in the table.

*Résumé of autoplasmic experiments.* Viewing the autoplasmic experiments as a whole, we find that as the limbs become transplanted more and more remote from the normal situation there occurs a corresponding decrease in their ability to function until a position is reached (series AS6) in which all limb movements are very imperfect, there being no cases with perfect adaptive function. This gradual decrease, in so far as movements of the shoulder are concerned, is unquestionably determined by a gradual decrease in the peripheral innervation; yet, the decrease in the function of the forearm, wrist, and hand is not based upon defective limb innervation. Further, the gradual loss of coordination as the limbs are farther and farther removed from the normal site must be conditioned by factors other than its peripheral innervation. These factors, which are thought to be most important in conditioning the function of the limbs in the various positions, will be more fully discussed later on.

*B. Homoplastic transplantations with normal limb intact*

The homoplastic experiments consisted in transplanting an additional anterior limb rudiment a given number of segments posterior to the normal intact limb, the respective series being designated as HS3, HS4, and HS5.

The results of these experiments when compared with those of the autoplasmic experiments furnish additional evidence which explains more fully the factors underlying the function of transplanted limbs.

As has already been pointed out, the normal anterior limb rudiment occupies a region extending from the anterior border

of the third somite to the posterior border of the fifth, centering ventral to the fourth somite. In the series HS3 the additional rudiment centered ventral to the seventh somite and its anterior border was contiguous with the posterior border of the normal intact limb rudiment. In these experiments the two limb buds always began independent growth; but in seven cases out of nine positive experiments, the posterior rudiment sooner or later reduplicated so that its anterior or disharmonic member fused with the normal limb to form a fused double limb. The posterior (harmonic) member which remained as a free limb functioned in all cases, but there was only one case, however, in which it functioned perfectly. Both of the two cases in which a single limb developed exhibited normal function. The results of this series of experiments are seen in table 1 b.

*Series HS4.* In this series of experiments, the additional anterior limb centered ventral to the eighth somite, so that the anterior margin of the transplanted limb bud was separated from the intact bud by the distance of one segment. In twenty-one positive experiments only eight developed normal limbs, the remainder forming reduplicated appendages. All of the reduplications functioned very imperfectly, as did also seven of the single limbs. In no case did function consist of more than slight flexion and extension of the forearm; yet in others motion was entirely restricted to twitchings of the hand.

The complete absence of cases with perfect function is in striking contrast with the 41 per cent which exhibited perfect function of the autoplasic series AS4, in which case the anterior limbs were transplanted to the same relative position (compare table 1 a, series AS4, with table 1 b, series HS4).

*Series HS5.* In the series HS5 the transplanted limb centered ventral to the ninth segment. The results of these experiments are seen in table 1 b. In twenty-five positive experiments eleven developed normal limbs, eight of which showed very imperfect function. Of the fourteen cases which reduplicated, only five exhibited any function. This consisted mostly of slight twitchings in the hand and in several cases slight movements of the forearm. The same was also true of the normal limbs.

By comparing series HS4 with series HS5 (table 1b), it is noticed that limbs of the latter series exhibited no better function than did those of the former series. The superior function of the limbs in the series HS3 to that in the aforementioned series is explicable on the grounds of the close proximity of the transplanted limb with the normal limb, which resulted in the additional limb's receiving some nerve supply from the normal plexus.

No cases of the series HS4 were sectioned. However, those of series HS5 which were sectioned showed that the main nerve supply came from segments corresponding to the position occupied by the transplanted limb; e.g., in case HS5<sub>12</sub> (fig. 22), which centered ventral to the eighth and ninth segments, the innervation was derived from these same segments of the cord. This observation is in accord with those made by Braus ('04, '05) and Harrison ('07) on anuran embryos, viz., that when the normal limbs are left intact the transplanted limb becomes innervated from that region of the cord corresponding to the position of the implanted limb rudiment.

No experiments were made to test the function of additional limbs transplanted the distance of six segments posterior to the normal intact limb. From the results obtained in the series HS4 and HS5 it appeared improbable that they should function to as great an extent as did those of the series above mentioned. Viewing these experiments as a whole, therefore, we see that the limbs functioned much more imperfectly than did the autoplasmic limbs transplanted to the same relative positions, and also that their innervation was derived from segments of the cord corresponding to the position of the implanted limb rudiment rather than from segments situated anterior to the position occupied by the limb. The significance of these points will be considered more fully in the discussion.

### *Regeneration*

Although the position and extent of the limb mesoderm can be quite accurately located by means of certain landmarks, it

is not always possible to remove the entire rudiment in a typical limb extirpation. Owing to its equipotentiality, certain unrecovered cells then may be sufficient in number to regenerate the appendage after the bulk of the rudiment has been removed. This regeneration has been shown to be greater in wounds which have not been covered (Harrison, '15). In the series AS1, in which the limb rudiment was removed the distance of only one segment posterior to the normal position, the wounds were not covered, the denuded area being so small that it could not easily be covered. From the anterior border of these uncovered wounds there occurred twelve cases in twenty-five which showed signs of regeneration. These consisted of small nodules of cells which began to project from the body about four days after the operation. These regenerating nodules, however, were very close to the transplanted rudiment, being separated only by the distance of one segment. They gradually decreased in size, however, until the eighth day after the operation they entirely disappeared and in no case did regeneration occur.

In the series AS2, where the limb rudiment was removed the distance of two segments, only five of the wounds were uncovered. Here ten cases in twenty-one began to regenerate the limb from small nodules of cells at the anterior border of the wound, as in the series AS1. These nodules of regenerating cells also began to appear on the surface of the body about four days after the operation. Some of these nodules began to increase in size, so that on the fifth and sixth days regeneration appeared very probable; however, they soon began to decrease in size, and by the eleventh day all signs of regeneration had entirely disappeared. Although the initial regenerating nodules in this series were about as large as those in the series AS1, their total disappearance did not occur until three days after total disappearance of those in the series AS1.

In the series AS3, in which the limbs were removed by the distance of three segments, the wounds were cleaned and covered. In twenty-three experiments there occurred ten cases in which regenerating nodules appeared. Some of these subsided about the fifth and sixth days, while others had developed so that by



the tenth or eleventh day they were almost as large as the transplanted rudiment. They then began to undergo reduction in size, but did not finally disappear until eighteen to twenty days after the operation.

All regenerating nodules of cells which appeared in the series AS4 and AS5 completely regenerated into a normal appendage at the original site.

It is readily seen, therefore, from these observations that there is an inhibitory influence of the transplanted limb upon the unremoved portion of the rudiment which attempts to regenerate, so that the more remote the transplanted limb bud becomes, the longer the time required for total disappearance of the regenerating nodule of cells. Since no sections of these cell nodules were made and since it could not be ascertained from external observations, it was impossible to say whether the regenerating cells were actually drawn over into the transplanted limb bud or whether, lacking the necessary stimulus for growth, they underwent atrophy and were resorbed. However, no matter what influence the limb bud exerts on these regenerating nodules, it is no longer manifested when the transplanted bud is removed the distance of four segments, for in the series AS4 and AS5 when regenerating nodules of cells appeared they always completely regenerated an appendage.

#### DISCUSSION

When the anterior limb of *Amblystoma punctatum* is excised and reimplanted to the same embryo at distances ranging from one to seven segments posterior to the normal position (autoplastic transplantation), corresponding decrease in the function of such limbs occurs as they are implanted more and more remote from the normal situation. A position is finally reached (six segments posterior to the normal) in which all limbs exhibit imperfect function, there being no cases with perfect adaptive movements (table 1 a and fig. 9). This gradual decrease in the function of the limbs seems to be directly correlated with the segmental nerve supply (table 2), the function of the limbs

being more perfect when innervated from the limb level of the cord.

It has hitherto been stated that in the tail-bud stage, the period of development in which the experiments were carried out, the anterior limb rudiment constitutes a region of somatopleural mesoderm extending from the anterior border of the third somite to the posterior border of the fifth. The normal anterior limb is supplied by a plexus composed of the third, fourth, and fifth spinal nerves (fig. 2). These nerves, effecting connection with the limb rudiment at a period when it occupies its maximum extent (anterior border of third somite to posterior border of fifth), become converged into a plexus as a result of concentration of the rudiment into the definitive limb bud which centers under the fourth myotome. Such convergence having taken place, a typical normal plexus as illustrated in figure 2 would be produced. In the normal position, the number of segments occupied by the limb rudiment apparently serves as an index of the number of segments which will contribute nerves to the appendage.

The results of homoplastic experiments carried out by Braus ('05) and Harrison ('07), as have already been pointed out, show that transplanted limbs also received innervation from segments corresponding to the extent and position of the rudiment. In the majority of their experiments, all of which were carried out on anuran embryos, the nerve paths were in part or totally laid down at the period when the rudiment was transplanted. In preparing the wound for the reception of the transplant, the peripheral ends of the nerves were severed and the rudiment placed in the direct pathway of the cut ends, which were found to continue their growth into the rudiment so placed. Any influence which the limb might have on the segmental nerve contribution and the direction of the nerve paths could not be adequately tested by these experiments; since, in order to do so, the rudiment would have to be transplanted at a period before initial outgrowth of the nerves begins. The results of the autoplasmic limb experiments in *Amblystoma* show that other factors, in addition to the position and extent of the limb rudiment,

govern the innervation of the limbs, when transplanted at a period before initial outgrowth of the nerves begins.

Were this not so, then the limb rudiment, if displaced the distance of several segments should so effect the nerve contribution that the plexus ought to come from segments corresponding to the position occupied by the displaced limb rudiment. That is, by shifting the position of the limb bud the distance of two segments so that it lies ventral to the fifth, sixth, and seventh somites, there should be a corresponding change in the segmental nerve contribution so that the limb plexus should be derived from the fifth, sixth, and seventh nerves. However, in an examination of table 2 the strong tendency for the limb to receive innervation from the limb level is quite evident. In fact, it requires a shifting of the limb rudiment the distance of three segments (series AS3, table 2) before a change in the segmental nerve contribution can be at all effected. The results of these experiments strongly suggest that the transplanted limb bud exerts a guiding influence on the segmental nerve supply and determines the paths taken by the spinal nerves effecting its innervation. The results also tend to show that the positive reaction toward this influence is greater in the nerves developing from the normal limb level of the cord. Especially is this true of the fourth and fifth nerves, both of which were found to elongate in a posterolateral direction a greater distance to effect innervation than did the third nerve or those developing from segments of the cord posterior to the limb level. The remarkable posterior elongation of the nerves to innervate transplanted limbs is well illustrated in figures 10, 11, and 12. Figure 11 shows the segmental contribution to the plexus supplying the limb which was transplanted so as to center ventral to the eighth, ninth, and tenth somites. We find that this limb receives a considerable amount of its nerve supply from the fifth segment of the cord. The question arises: why should these nerves situated such a great distance anterior to the limb effect limb innervation? It is found that the nerves of the limb level do not grow out to the limbless area as they do upon simple extirpation of the limb, but almost immediately after their exit from the

vertebral foramina they begin to elongate posteriorly and in the general direction of the transplanted limb. It could easily be assumed that these nerves, not finding a sufficient number of muscles to accommodate the sum total of their fibers as they grow posteriorly, would so continue to grow until the limb muscles were reached and total connections were made. However, in the absence of any directing influence of the transplanted limb on these nerves, there is no apparent reason to expect that they should enter the limb. Further, why should not the outgrowing nerves corresponding to the segments occupied by the transplanted limb effect its sole innervation? For example, if a limb is transplanted so that its position corresponds to the eighth, ninth, and tenth segments, the outgrowing nerves corresponding to these same segments are closer to the limb rudiment than are those coming from segments of the cord situated anterior to the limb, yet those nerves situated anterior to the position of the displaced rudiment are the ones which contribute the main bulk of the nerve supply. Only by recognizing the presence of a guiding influence and a positive reaction of the nerves toward it, can the nerve supply to transplanted limbs be adequately explained at present. By the use of such an hypothesis we can explain why the nerves of the normal limb level, especially the fourth and fifth, will grow a longer distance posteriorly to effect limb innervation than those from more posterior segments. Such an explanation can only be made by assuming that the positivity toward this influence is greater at this level of the cord. The facts as shown in table 2 would seem to agree with such an assumption, for this table shows that the farther away from the normal level the limbs are transplanted, the less the tendency to be innervated from segments situated anterior to the position of the limb rudiment and the greater the tendency to be innervated by segments corresponding to the position occupied by the limb. The presence of such an influence as seems to be exerted by the autoplasmic limbs may be an expression of a mechanism whereby the anterior limbs, when set back a number of segments, can function coördinately with the opposite intact limb, for we have already seen that limbs transplanted poste-

riorly cannot function to any degree unless they receive innervation from the limb level or from segments of the cord just posterior to the limb level.

It thus seems likely that the influence bringing about the posterior elongation of the nerves from the limb level, in addition to certain probable conditions existing within the central nervous system (which will be discussed later on), provide a mechanism whereby the transplanted limbs may, within limits, perform functionally adaptive movements. One cannot help but be impressed with the fact that the peculiar posterior elongation of the nerves to the transplanted limb, as is shown in figures 10 and 11, is not the result of mere accident or the result of a non-directive agent. Especially is this true in those cases where the nerves, after having grown out posterolaterally to the body wall, will turn their course in a ventral direction and wind their way through a mass of muscle tissue to meet a limb more ventrally situated.

Although further experiments are necessary to prove or disprove definitely that the transplanted limb does so exert an influence on the outgrowing nerves as to determine the segmental nerve supply and the paths taken by them in the innervation of the limb, this hypothesis appears at the present time to be the one which most nearly fits the facts.

A brief explanation of the factors conditioning the function of the transplanted limbs has already been published (Detwiler, '19), but it will be necessary to discuss this point again.

It has previously been shown (table 2 and fig. 9) that as the transplanted limbs receive less and less innervation from the normal limb level of the cord, there occurs a corresponding decrease in the ability of the limbs to exhibit movements coördinated with those of the opposite intact limb, so that a position is finally reached (six segments posterior to the normal) in which the limbs receive no segmental contribution anterior to the eighth segment of the cord and show nothing more than greatly impaired movements in response to tactile stimulation. This gradual decrease in the function of the limbs as they become implanted more and more remote from the normal limb region, depends

upon a number of factors outside the structure of the limb itself. Limbs transplanted only a short distance from the normal situation have been found, in general, to grow slightly larger than those removed farther away; however, the degree of structural deficiency within the limb itself is not strictly proportional to the distance from its normal position. The limb being an equipotential system, it is to be expected that complete structural differentiation, exclusive of vascularization and innervation, should not be effected by location.

All limbs classed in the category 'normal limbs,' which was based on purely topographic completeness, were also found to be for the most part structurally complete. Hence, it is seen that the gradual loss of function in limbs more remotely removed is in no wise the result of structural deficiencies. The gradual decrease, therefore, in the function of limbs as they become implanted more and more remote from the normal limb region suggests the following possible factors conditioning the degree of function: *a*) structural deficiencies in the shoulder-girdle; *b*) deficiencies in the shoulder musculature; *c*) the failure of certain shoulder muscles to receive innervation, and, *d*) the absence of proper central neurone connections.

In a typical limb-bud transplantation the major portion of the shoulder-girdle rudiment is included. Since it is difficult to excise and transplant always exactly the same region of mesoderm and since the girdle rudiment in *Amblystoma* constitutes a mosaic (Detwiler, '18), there is considerable variation in the degree of its development in the heterotopic position. Yet its development, in general, is no less complete in cases where the limb has been removed a considerable distance from the normal situation than in those where it has been removed only a short distance. An examination of table 4 shows that the heterotopic girdles exhibit no specific deficiencies which can be correlated with the distance they have been transplanted from the normal situation. Hence, the gradual loss of function which the limbs exhibit as they are farther and farther removed cannot be the result of corresponding shoulder-girdle deficiencies. It is found, however, that girdles developing close to the normal

situation are likely to be somewhat larger than those developing more posteriorly, a condition very likely due to the fact that in the former position there is more room for development. With the development of larger girdles, of course, there would be a corresponding development of larger muscles which would permit of slightly greater shoulder movements than in the more posterior positions where the shoulder-girdle is not quite so large; but the difference in the degree of function of the limbs could not be a result of this factor alone, for girdles developing the distance of four segments posterior to the normal position are no larger than those developing six segments posterior to it, yet the difference in the degree of function of the limbs in these two positions is considerable, as is shown in table 1 a.

Another factor, which must be considered when dealing with function, is the differentiation of the shoulder muscles, since movements of the limbs cannot be perfectly performed unless shoulder-muscle differentiation is complete. A study of the cross-section anatomy of the shoulder region of the transplanted limbs shows that shoulder-muscle differentiation is no less complete in cases where the limbs are removed considerable distances than in those where they are only slightly removed from the normal situation. An examination of table 3 shows that no cases were found in which there was complete absence of any of the shoulder muscles that typically develop in the heterotopic position. So, in limbs transplanted considerable distances away from the normal position and which exhibit practically no function, a skeletomuscular mechanism exists adequate for all movements of the arm on the shoulder; hence, it is necessary to look elsewhere for the factors governing function of the limbs.

This brings up the third factor, that of peripheral efferent innervation to both limb and shoulder muscles, deficiencies in which would readily account for restricted movements. The result of this study shows that the peripheral innervation to shoulder and limb is somewhat less complete quantitatively when transplanted to the more posterior positions than in cases where the transplanted limb receives segmental nerves from all or only a portion of the normal limb level of the cord, and to a

certain degree somewhat less developed qualitatively as is seen by an examination of table 3. This would naturally account for considerable deficiencies of movement, yet by an examination of individual cases it is found that the degree of motion is not directly correlated with the number of muscles innervated, nor with the number of segments contributing nerve fibers. For example, case AS4<sub>27</sub> with only four of the nine muscles innervated showed a considerable degree of shoulder movement. In case AS5<sub>27</sub> with an equal number of muscles innervated (table 3), there was practically no shoulder movement. The same was true in case AS5<sub>26</sub>.

Further evidence which shows that the completeness of shoulder movement is not entirely dependent upon the number of muscles innervated is afforded by an examination of homoplastic limbs transplanted the distance of four and five segments posterior to the normal intact limb of the host. For example, in case HS5<sub>12</sub> (fig. 22) all of the shoulder muscles received nerve fibers, yet practically no function was observed.

That the degree of function of the limbs cannot be a result of the number of segments supplying nerves to the brachial plexus is also shown by the fact that the function of the limbs is more complete in some cases where only three segmental nerves contribute to the plexus than in others where four nerves are involved, even though the number of shoulder muscles innervated in both cases is the same. Of course, the number of segmental nerves contributing to the brachial plexus is not as important as the actual number of nerve fibers entering the shoulder muscles and the limb. However, it is practically impossible to count the number of nerve fibers in a given segmental nerve, since in larvae of the age studied the fibers are non-myelinated and cannot be counted with any degree of accuracy. Although the segmental nerves contributing to the innervation of the transplanted limb were larger than their counterparts which do not supply a corresponding end organ, the increase in size was found to be the result of a hyperplasia of the peripheral afferent neurones, there being no positive evidence that the functional activity of the transplanted limb had brought about any definite hyperplasia of the somatic motor neurones.



The increase in the number of sensory neurones was determined by counting the number of cell bodies in the spinal ganglia. Attempts to count the anterior horn cells were not successful, inasmuch as the anterior horn areas are not well differentiated at the age in which the larvae were studied and no accurate differentiation could be made between the anterior horn cells and the non-nervous cells (spongioblasts). The question dealing specifically with the effect of continued function of the limb upon the development of peripheral neurones, both afferent and efferent, will be discussed more fully in a later publication. However, from a complete survey of the peripheral innervation, both from the standpoint of the number of muscles innervated and the amount of nerve contribution, it is highly improbable that the defective peripheral innervation can account for the great degree of imperfect movements that are exhibited by limbs in the series AS5 and AS6.

The remaining factor, therefore, viz., defective connections within the central nervous system, appears to be the only one which will adequately account for the marked deficiency of function in limbs transplanted so far posteriorly as to be beyond the point where they will receive peripheral innervation from all or only a portion of the normal limb level of the cord.

Although in normal larvae of this age the most obvious motor responses to various types of peripheral stimulation consists of total swimming reactions, under certain controlled conditions motor responses may be almost entirely limited to coördinated movements of the limb. Such responses may be carried out perfectly by the transplanted limbs when their peripheral innervation is derived from the normal limb level of the cord, but the ability to exhibit movements coördinated with those of the opposite intact limb decreases markedly when their peripheral innervation is derived from segments well beyond the normal limb level (series AS6).

As has been shown by Herrick ('14), we have here a central nervous architecture by means of which peripheral sensory stimuli pass through more or less localized ascending sensory tracts from the cord to the medulla (tractus spinobulbaris), to the mid-

brain (tractus spinotectalis), and to the thalamus (tractus spinothalamicus). These stimuli may become finally discharged into the somatic motor centers of the spinal cord by means of descending tracts such as the tractus thalamobulbaris, tractus tectobulbaris, the fasciculus longitudinalis medialis, and the tractus bulbospinalis. According to Herrick (*op. cit.*), the cell bodies of the tractus bulbospinalis lie in the general motor tegmentum of the medulla and their axones are directed ventrally into the ventral funiculi of the same and opposite sides. It is highly probable that a certain number of these fibers normally develop only as far as the third, fourth, and fifth segments of the cord for specific discharge into the normal appendicular somatic motor centers. The fact that transplanted limbs, which receive peripheral innervation from these levels, do exhibit movements coördinated with the opposite intact limb strongly suggests such a condition. The behavior of limbs innervated mainly from the sixth, seventh, and eighth segments of the cord (series AS5) suggests that these descending neurones, which normally end in the limb level, may be induced to continue their growth an additional segment or two in order to meet the functional demands imposed upon them by the transplanted limb. Their incapacity for further functional regulation is suggested by the loss of coördinated function and the greatly impaired movements such as are exhibited by limbs of the series AS6 (table 1 a)—probably none of which receive peripheral innervation from segments of the cord anterior to the eighth (table 2).

The increase in the number of cases with total loss of function as the limbs are implanted more and more posteriorly (table 1 a and fig. 7) would also suggest that, in addition to an inadequate supply of descending neurones, there probably occurs a corresponding increase deficiency in the connections of purely intraspinal correlation neurones.

Additional homoplastic limbs transplanted respectively three, four, and five segments posterior to the normal intact limb of the host (table 1 b), never attain the completeness of function attained by autoplastic limbs transplanted to the same relative positions. Such limbs may be well supplied with peripheral

nerves derived from segments of the cord posterior to the normal limb level, so that the restricted function which they do exhibit cannot be the result of a lack of peripheral innervation. It appears, therefore, highly probable that the greatly impaired movements which these additional limbs exhibit are conditioned by a lack of supply of central efferent neurones. As has been stated above, there are probably a certain number of these descending neurones belonging to the tractus bulbospinalis which develop only as far as the normal limb level, where they discharge into the normal appendicular somatic centers. Assuming this to be true, the greatly restricted movements of the additional limb would readily meet an explanation on this basis; for, these descending neurones being taken up by the peripheral neurones of the normal limb, the movements of the additional limbs must very likely be effected through more or less imperfectly connected intraspinal, intersegmental correlation neurones of the levels from which peripheral innervation is derived.

#### SUMMARY

1. When the anterior limb of *Amblystoma* is excised and reimplanted to the same embryo at distances ranging from one to seven segments posterior to the normal position (autoplastic transplantations), there occurs a corresponding decrease in the function of such limbs as they are implanted more and more remote from the normal situation (table 1 a).

2. Shifting the position of the limb a given number of body segments does not effect a corresponding shifting of the segmental nerve contribution to the plexus. There is a marked tendency for the transplanted limb to receive innervation from the normal limb level of the cord (table 2 and figures 10 and 11).

3. Limbs removed so far posterior to the normal situation as to receive no innervation from the normal limb level of the cord received the main bulk of their nerve supply from segments situated anterior to the transplanted limb rather than from segments corresponding to the position occupied by the limb (table 2).

4. The gradual decrease in the function of the limbs as they become implanted more and more remote from the normal limb region seems to be directly correlated with the segmental nerve supply, the function of the limbs being more perfect when innervated from the limb level of the cord.

5. Transplanted limbs receiving less and less innervation from the normal limb level of the cord show a corresponding decrease in their ability to exhibit movements coördinated with those of the intact limb of the opposite side.

6. The gradual loss of function of limbs, as they become transplanted farther and farther away from the normal situation, is attributed to increased defective connections within the central nervous system rather than to a corresponding decrease in effective peripheral innervation and structural deficiencies of the limb and the shoulder-girdle.

7. In general, as the distance between the normal position and the transplanted limb is increased, a corresponding increase occurs in the time required for initial limb reflexes to appear. Limbs in which the appearance of initial reflexes is considerably delayed are less apt to attain perfect function.

8. The number of segments occupied by the transplanted limb rudiment does not determine the number of segmental nerves contributing innervation to the limb.

9. The results of the experiments suggest that the transplanted limb rudiment exerts a guiding influence on the segmental nerve contribution and determines the path taken by the nerves effecting innervation of the limb. The positive reaction toward this influence appears to be greater in the nerves coming from the normal limb level of the cord.

10. Regardless of the segmental nerve contribution, the architecture of the nerve distribution within the transplanted limb is exactly the same as that in the normal limb. These results corroborate those of Braus ('04, '05) and Harrison ('07).

11. Gradually increasing the distance between the normal position and the transplanted limb brings about a gradual increase in the number of reduplicated appendages.

12. The non-adaptiveness of reduplication is shown by the fact that a functional condition frequently arises which is independent of the harmony of the combination. The results accord with those of Harrison.

13. Additional anterior limb rudiments transplanted a given number of segments posterior to the normal intact limb of the host (homoplastic transplantations) never attain the completeness of function attained by autoplastic limbs transplanted to the same relative position (tables 1 a and 1 b). The increased deficiency in function when compared with the autoplastic limbs is attributed to greater defective connections within the central nervous system rather than to increased defects in the peripheral innervation.

#### LITERATURE CITED

- BANCHI, H. 1906 Sullo sviluppo dei nervi periferici in maniera indipendente dal sistema nervosa centrale. *Anat. Anz.*, Bd. 28.
- BRAUS, H. 1904 Einige Ergebnisse der Transplantation von Organanlagen bei Bombinator larven. *Verhand. der Anat. Gesellschaft.* Jena, 1904.
- 1905 Experimentelle Beiträge zur Frage nach der Entwicklung peripherer Nerven. *Anat. Anz.*, Bd. 26.
- 1906 a Ist die Bildung des Skeletes von den Muskelanlagen abhängig? *Morph. Jahr.*, Bd. 35.
- 1909 Gliedmassenpflanzung und Grundfragen der Skelettbildung. I. Die Skeletanlage vor Auftreten des Vorknorpels und ihre Beziehung zu den späteren Differenzierungen. *Morph. Jahr.*, Bd. 39.
- DETWILER, S. R. 1918 Experiments on the development of the shoulder-girdle and the anterior limb of *Amblystoma punctatum*. *Jour. Exp. Zoöl.*, vol., 25.
- 1919 The effect of transplanting limbs upon the formation of nerve plexuses and the development of peripheral neurones. *Proc. Nat. Acad. Sci.*, vol. 5.
- 1920 On the hyperplasia of nerve centers resulting from excessive peripheral loading. *Proc. Nat. Acad. Sci.*, vol. 6.
- FÜRBRINGER, M. 1873 Zur vergleichenden Anatomie der Schultermuskeln. *Jena. Zeit.*, Bd. 7.
- 1879 Zur Lehre von den Umbildung der Nervenplexus. *Morph. Jahr.*, Bd. 5.
- GEMELLI, F. A. 1906 Ricerche sperimentali sullo sviluppo dei nervi degli arti pelvici di *Bufo vulgaris* innestati in sede anomala. *Revista di Patologia Nervosa e Mentale*, Anno 11.

- HARRISON, R. G. 1907 Experiments in transplanting limbs and their bearing upon the problem of the development of nerves. *Jour. Exp. Zoöl.*, vol. 4.  
1910 The outgrowth of the nerve fiber as a mode of protoplasmic movement. *Jour. Exp. Zoöl.*, vol. 9.  
1915 Experiments on the development of limbs in Amphibia. *Proc. Nat. Acad. Sci.*, vol. 1.  
1917 Transplantation of limbs. *Ibid.*, vol. 3.  
1918 Experiments on the development of the fore limb of *Amblystoma*, a self-differentiating equipotential system. *Jour. Exp. Zoöl.*, vol. 25.
- HERRICK, C. J. 1914 The medulla oblongata of larval *Amblystoma*. *Jour. Comp. Neur.*, vol. 3.
- NAUSSBAUM, M. 1894 Nerv und Muskel: Abhängigkeit des Muskelwachstums vom Nervenverlauf. *Verhandlungen der Anatomischen Gesellschaft. 8. Versammlung in Strassburg.*
- ROUX, W. 1893 Einleitung. *Archiv für Entwicklungsmechanik der Organismen.* Bd. 1.
- SHOREY, M. L. 1909 Effects of destruction of peripheral areas on the differentiation of neuroblasts. *Jour. Exp. Zoöl.*, vol. 7.
- WEIDERSHEIM 1889 *Das Gliedmassenskelett der Wirbelthiere mit besonderer Berücksichtigung des Schulter- und Beckengürtels bei Fischen, Amphibien und Reptilien.* Jena, 1892.

PLATES

## EXPLANATION OF PLATES

All of the figures in plates 1 and 2 are photographs of living specimens. The animals were anaesthetized by chloretone (1:3000), and photographed under water.

### PLATE 1

#### EXPLANATION OF FIGURES

13 Ventral view of case AS<sub>426</sub>, photographed fifty-two days after the operation, showing the right anterior limb implanted the distance of four segments posterior to the normal position.  $\times 2$ .

14 Dorsal view of case AS<sub>412</sub>, showing reduplication of the anterior limb which was transplanted the distance of four segments posterior to the normal position. The anterior (disharmonic) member of the reduplication has become functional. The posterior member failed to function and has undergone considerable atrophy.

15 Dorsal view of case AS<sub>527</sub>. Right anterior limb transplanted the distance of five segments posterior to the normal position. Animal preserved sixty-five days after the operation.  $\times 2\frac{1}{4}$ .

16 Dorsal view of case AS<sub>525</sub>. Right anterior limb transplanted the distance of five segments posterior to the normal position. Animal preserved sixty-three days after the operation.  $\times 2\frac{1}{2}$ .

17 Ventral view of case AS<sub>525</sub>.

18 Ventral view of case AS<sub>527</sub>.



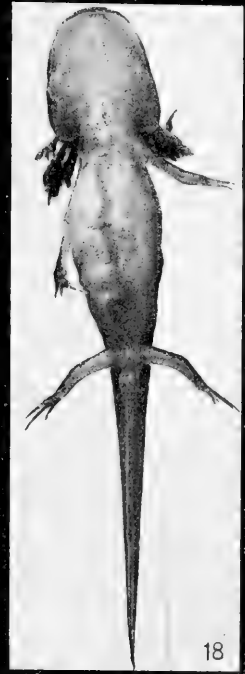

## PLATE 2

### EXPLANATION OF FIGURES

- 19 Ventral view of case AS3<sub>30</sub>. Right anterior limb transplanted the distance of three segments posterior to the normal position. Animal preserved sixty-six days after the operation. × 4.
- 20 Ventral view of case AS6<sub>29</sub>. Right anterior limb transplanted the distance of six segments posterior to the normal position. Animal preserved sixty-nine days after the operation. × 4.
- 21 Dorsal view of case HS4<sub>7</sub>. Additional anterior limb transplanted the distance of four segments posterior to the normal intact limb of the host. Animal preserved seventy-five days after the operation. × 3.
- 22 Dorsal view of case HS5<sub>12</sub>. Additional anterior limb transplanted the distance of five segments posterior to the normal intact limb of the host. Animal preserved seventy days after the operation. × 4.



22



21



20



19

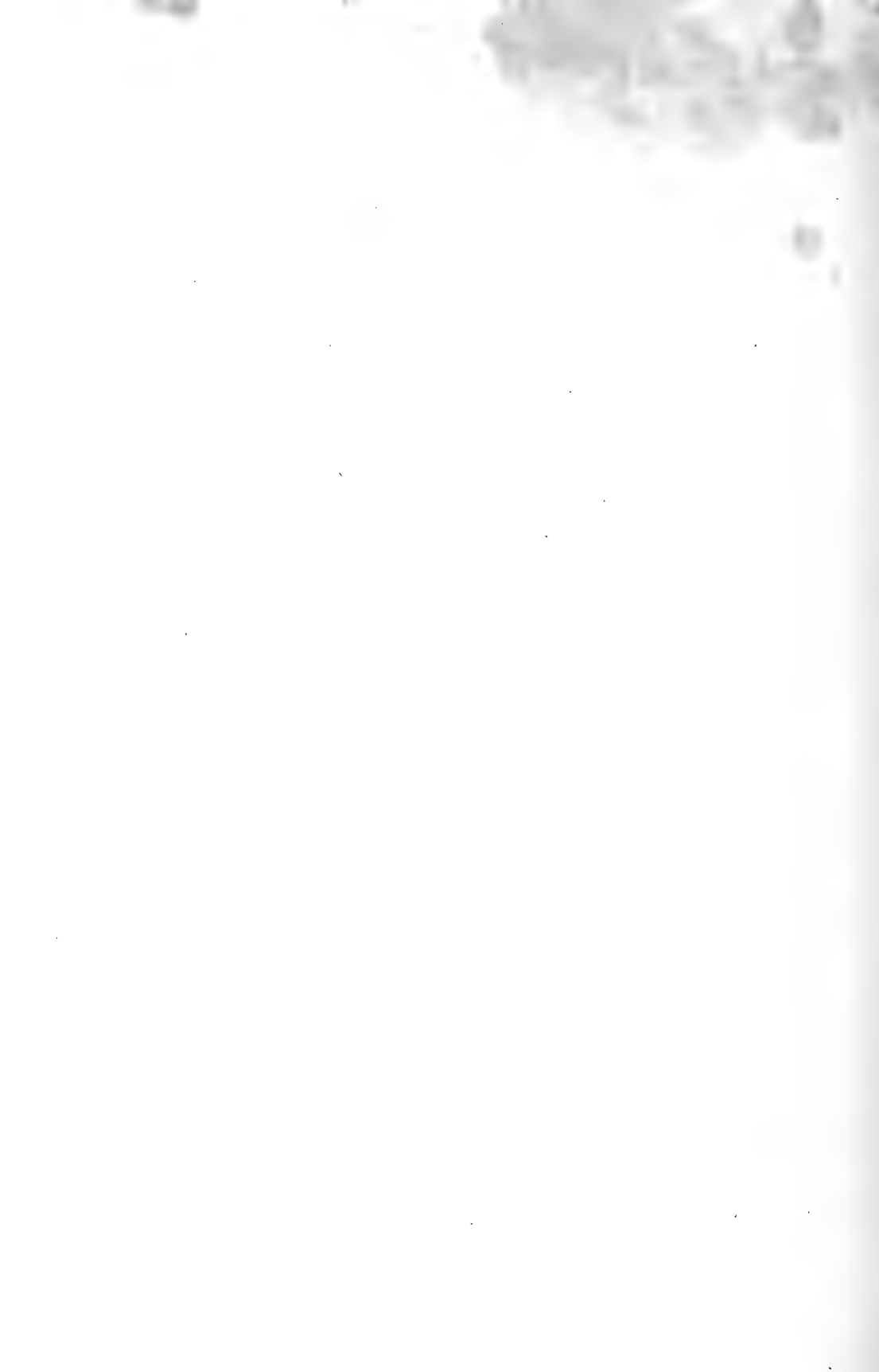



Resumen por los autores, M. F. Guyer y E. A. Smith.  
Universidad de Wisconsin.

### Estudios sobre las citolisinas

#### II. Transmisión de defectos oculares inducidos.

En los fetos uterinos de conejos de distintos troncos nan inducido los autores defectos oculares (principalmente defectos en el cristalino) mediante el suero de gallina sensibilizado para el cristalino de conejo. Aparentemente el efecto es específico, puesto que los jóvenes contenidos en conejas preñadas inyectadas consuero de gallina puro o sensibilizado para los testículos de conejo no presentan sus ojos afectados. Una vez establecido, el defecto puede transmitirse a generaciones ulteriores. Es un ejemplo de verdadera herencia (no simplemente transmisión placentaria) puesto que puede extraerse de la línea masculina.

Translation by José F. Nonidez  
Cornell University Medical College, N. Y.

## STUDIES ON CYTOLYSINS

### II. TRANSMISSION OF INDUCED EYE-DEFECTS

M. F. GUYER AND E. A. SMITH

*Zoological Laboratory, University of Wisconsin*

SEVEN FIGURES AND FOUR PLATES

#### INTRODUCTION

In a former paper (Guyer and Smith, '18) we recorded the results obtained during the year 1916-17 from experiments in which pregnant rabbits and pregnant mice were treated with fowl serum sensitized, respectively, to the crystalline lens of the rabbit and of the mouse. It was found that antenatal defects in the lenses of the young could be secured in this way. Thus, in rabbits treated during pregnancy with fowl serum sensitized to rabbit lens, some of the young showed eye defects, such as opacity of the lens and partial or, less frequently, complete liquefaction of the lens. Similar results were obtained with mice of the genus *Peromyscus*.

The present paper deals with the continuation and repetition of these experiments in rabbits, and includes an account of the transmission through successive generations of eye defects originally induced by means of lens-sensitized fowl serum. To do away with the possibility of accident or coincidence, it was obviously desirable to secure other well-established cases. This is particularly true for the genetical aspects of the experiments. Since, in our opinion, the fact of transmissibility is by far the most significant one established, in repeating the original experiment we have taken pains to secure wholly unrelated stock so that we may be sure that we are not simply perpetuating a chance inheritable defect which has sprung up by some strange coincidence just at the time of our work. To safeguard the

experiments in this respect, we have imported rabbits from other States (Minnesota, Iowa, Illinois, and Indiana) and tested them genetically before treating them with serum or crossing them with our original strain.

We have often been asked why we chose fowls and rabbits rather than some other forms for our experiments. Fowls were used as the source of the sensitized serum mainly because of the ease with which they may be kept and handled, and because they are not easily infected in surgical operations. Furthermore, it was thought that serum from an animal as far removed in relationship from the rabbit as the fowl is would perhaps yield a more powerful serum than that from a mammal. This opinion, it should be noted, is based on statements we have found in books on immunity and not on our own experience. In his book entitled 'Immunity,' for example, Citron (Garbat translation) specifies (p. 144) chickens as among the best animals adapted to supply hemolytic sera, and also remarks that "an animal produces a better hemolysin the remoter its relationship to the animal from which the erythrocytes for injection are taken."

The use of so foreign a serum as that of the fowl, however, doubtless has its disadvantages, since the poisonous, hemolytic or general, shock effects arising from the introduction of such a widely different serum into the veins of a rabbit cannot but be more severe than if serum from a more closely related form like the guinea-pig were used. The frequent severe illness and the occasional death which occurred in treated rabbits was probably in no small measure due to this factor. Nevertheless, the advantages in using fowls seemed to outweigh the disadvantages so far that we have continued to use them.

The availability of the large marginal vein in the ear for intravenous injections is one reason for the use of the rabbit in experiments such as ours. Also, a doe usually bears from five to eight young in a litter and may have several litters in one year. The young, furthermore, will begin to breed at from six to eight months of age, though this advantage of early maturity is offset somewhat by the fact that the litters of very young females usually number only three or four individuals. While these



facts all show that among mammals, rabbits are fairly favorable for breeding experiments, the fact that influenced us more than any other in choosing them is that in our experience they are physiologically well stabilized and rarely if ever in the course of ordinary breeding produce abnormal young. It is well known, for instance, that guinea-pigs of supposedly normal origin occasionally throw defective young. Sometimes it is a missing toe or toes, or perhaps there are extra toes. Again it may be some nervous defect, such as congenital palsy or epileptic-like seizures, or perhaps, though less frequently, the defect is an eye anomaly. In breeding experiments carried on with guinea-pigs in the department of genetics in the University of Wisconsin during the last few years several examples of the abnormalities just mentioned have been encountered. In rats, also, the writers have seen two cases in which one eye was smaller than the other and was otherwise imperfect.

As regards rabbits, however, we have never seen nor heard of such sporadic eye defects. The senior author has bred many rabbits for laboratory purposes and he has also conferred with a number of rabbit breeders, but has found no record of congenital eye defects. In this connection some two years ago he made special inquiry of Dr. Orren Lloyd-Jones, of Ames, Iowa, a trained geneticist, who stated that in the four hundred and some odd rabbits he had just been using in genetical problems he had observed nothing similar to the eye defects induced in our serum-treated stock. He also said that as a result of his various experiments in breeding rabbits, extending over a number of years, he had come to regard them as exceptionally stable forms. Likewise Dr. E. C. Rosenow, of the Mayo Clinic, who is constantly working with rabbits and has done so for years, after looking over our experiments told us that he had never seen such eye defects in any of his rabbits.

All testimony that we have received, therefore, coincides with our own experience that rabbits are stable forms wholly unlikely to develop eye defects unless, as in our work, these have been deliberately induced by the experimenter. We dwell upon this point because when unusual results are obtained, the first thought

is always of coincidence and chance, and at the outset it is important to realize how improbable it is that just the right chance variation would spring up at exactly the right time—that is, coincidentally with our treatments—to mislead us into believing that we had produced something that was destined to appear anyway in our different stocks of rabbits.

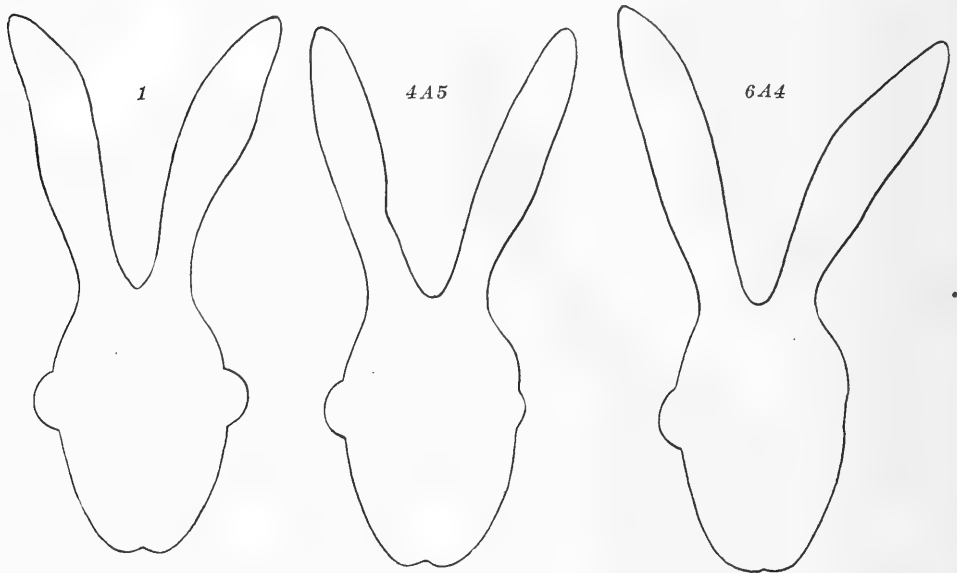

Fig. 1 Profile view of rabbits to show natural bulging of the eyeballs of a normal rabbit (1) compared with one (4A5) in which the left eyeball is reduced in size, and one (6A4) in which it has practically disappeared.

#### THE NORMAL EYE

In order to understand the eye defects that have been induced in our stock, it is necessary to know the chief characteristics of the normal eye of the rabbit and something about its development. The eyeball of the rabbit, typically large and globular, measures about 16 mm. in diameter and protrudes beyond the contour of the head (fig. 1) so far as to be conspicuous. The outer or sclerotic coat is glistening white and contains no cartilage. The iris is also white with fine transparent radiations which

extend from the outer edge toward the pupil. The lens, which is large, transparent and spherical, occupies about one-half of the posterior chamber. In albinos such as we used the blood-vessels that supply the retina give to the eye a rich red color easily seen through the pupil and iris (pl. 1, fig. 1).

In the embryo the optic vesicles, which arise as outgrowths of the ventral lateral walls of the forebrain, are well developed before the end of the ninth day. Between the tenth and fourteenth days several important changes take place. The ectoderm opposite the vesicle thickens into a disk closely connected to the outer wall of the latter. As the outer wall is folded in to form a two-layered optic cup, this disk is pulled in, eventually separating from the ectoderm as the hollow lens vesicle which lies within the optic cup. The cavity of the lens vesicle is gradually obliterated by the thickening of the inner wall and the lens increases in size by the addition of successive layers to the outside.

The process of folding is not confined to that part of the vesicle in contact with the lens. The ventral wall of the vesicle and a part of the optic stalk are pushed in, producing a cleft or choroid fissure in the bottom of the cup continuous with a groove in the stalk. A vascular loop which later becomes the central artery of the retina and its hyaloid branch enters the cup through the choroid fissure.

Some of the loose mesenchyme cells surrounding the optic cup extend around the lens to form a membrane, the posterior part of which is supplied by the hyaloid artery. The anterior surface receives branches of the anterior ciliary arteries. Thus, by the thirteenth day, the lens is relatively large and is surrounded by a membrane richly supplied with blood-vessels. This vascular membrane is an embryonic structure which serves for the nutrition of the lens during its growth. It disappears before birth.

#### THE DEFECTIVE EYES

The chief defect, common to all the eyes where there is sufficient eyeball left to permit of internal examination, centers in the lens. It is always opaque, in whole or in part, and it may be

greatly reduced in size. In some rabbits the opacity is evident without the use of the ophthalmoscope; in others, an examination with this instrument is necessary to disclose it. In several instances eyes which in all external respects appeared normal were found to have milky lenses when examined ophthalmoscopically.

The defective lenses, however, are frequently accompanied by other characteristic anomalies (pls. 1 to 4). Often the abnormal eye has a staring look because the iris does not exhibit its normal reflexes and is usually more translucent than the iris of the normal eye. The color of such an eye is peculiar; it is lavender at some angles and silvery at others (pl. 1). Apparently the absence of the normal red is due in part, at least, to the clouded lens which keeps the reflection from the retinal blood-vessels from shining through. How much, if any, the retinal blood-vessels themselves are changed is now under investigation. Occasionally the hyaloid artery persists and a fine network of blood-vessels surrounds the opaque lens. While the whole lens substance is usually clouded, in some lenses only spots are opaque.

Not only may the lens be opaque but, as already mentioned, it may also be reduced in size. In such cases the eyeball, iris, and pupil are correspondingly small. The eyeball, for example, may be only one-half, one-third, or even one-fourth normal size (pl. 1 to 4) and sunken until the eye does not extend beyond the level of the head (fig. 1). Again, the ball may be rotated downward or inward until the cornea and parts visible behind it are nearly out of sight. The extreme is reached in those eyes in which the ball collapses, leaving no trace of pupil or iris.

Accompanying these defects are frequently a cleft iris and less often, a persistent hyaloid artery, due to suppression of development. To understand these conditions one must remember that in the embryo the optic cup, instead of being a complete ring, is interrupted on the ventral side by the choroid fissure. If this fissure remains open instead of closing, as it should do normally, the anomalies just described result. Incomplete or cleft iris is known as coloboma when it occurs in man.

It is obvious that during the developmental period, especially from the tenth to fourteenth day when the optic cup is forming

and when the lens has a rich plexus of blood-vessels surrounding it, any lytic or toxic substance in the blood specific for lens material would have a good opportunity to attack it with maximal effect. For instance, such a substance could directly hinder increase in size through solution of one or more of the lens proteins. Or it is not unlikely that the sensitized fowl serum would form a precipitin with some of the lens protein. This may be the means by which the opacity of the lens is produced. A stunting of the lens would in all probability result in the production of a smaller eyeball, inasmuch as the parts are so mutually related in development.

The eye defect, once secured, does not always remain at a standstill in the affected individual, but may progress; or it may, at least, have associated with it conditions which lead to further changes in the eye. For example, individual 3A1, a male secured in one of the earliest experiments, had the lens of the left eye opaque, although the eyeball was but slightly less than normal size at the time the eyes opened some twelve days after birth. This eye not only did not keep pace in size with the other eye as the young individual grew larger, but actually retrogressed as if being acted upon by some kind of solvent. It became gradually smaller, the ball collapsed and almost disappeared. At the present time, about three years later, there is practically no trace of an eyeball (pl. 1, fig. 3A1; pl. 2). The condition indicates that a solvent effect of some kind is in operation. Such post-natal degeneration occurred in several rabbits.

#### LATER EXPERIMENT ON THE PRODUCTION OF EYE DEFECTS WITH LENS-SENSITIZED SERA

In our later experiments much the same methods of procedure were followed as in those recorded in our first study (Guyer and Smith, '18). Fowls were sensitized with rabbit lens from four to six times at intervals of approximately a week, and were then left about ten days before killing. In most experiments the original method of injecting the pulped lens intraperitoneally was followed, though in a few cases the more difficult method of injecting the material directly into the femoral vein of the fowl

was practiced. It seems worth while to call attention to this intravenous method, inasmuch as some of the most pronounced effects produced in the uterine young were secured with serum from fowls which had been thus intravenously treated and had later been further sensitized or resensitized by the intraperitoneal method.

The rabbits were generally so mated as to have the young in utero somewhere near the ten-day stage of development at the time of the first injection of fowl serum. Only albino rabbits were used, as it was thought that the unpigmented iris would be of advantage in examining the lens and the interior of the eye.

In the following detailed account of our later series of experiments, the first experiment of the new series is recorded as 'Experiment 10' in order to keep the designations the same as in our office records, and also to avoid confusion with the experiments discussed in our former paper ('18). All injections into the rabbits were intravenous unless otherwise specified. Unless the eyes were visibly defective, they were recorded as normal.

#### *Experiment 10*

In this experiment five fowls and three rabbits were used as specified in table 1. The chief purpose of the experiment was to find if lens-defects could be induced in the young of rabbits far advanced in pregnancy. Only two injections were given. It will be observed that the fetuses of two of the rabbits, numbers 13 and B, were within about nine days of birth when the first serum was introduced. Apparently the dose, 8 cc., was too large.

The evidence indicates that the young were killed in utero in all three of the mothers. Each doe became very ill, and B died two days after the second treatment. Dissection showed that she was carrying five young. Judging from their somewhat macerated condition, they had been dead some days. The other two does acted as if crippled. They did not recover from their stiffness and lethargy for several weeks. Our inference was that the young were gradually resorbed, or perhaps in the case of the one with young far advanced, aborted. The latter idea is based

on the fact that under somewhat similar circumstances we have sometimes found in the hutches of other does chunks that seemed to be placentas, although all trace of the fetuses had disappeared. Since, in one case at least, we found the doe eating this material, it is possible that other abortions have occurred and gone unrecorded because the aborted young were eaten.

TABLE 1  
*Experiment 10*  
I. Sensitization of fowls

DATE—1917	IDENTIFICATION NUMBERS OF FOWLS INJECTED	NUMBER OF RABBIT LENSES USED	NORMAL SALT SOLUTION	DOSAGE PER FOWL
			cc.	cc.
October 31	5, 10, 12, 13, 17	6	20	3
November 7	5, 10, 12, 13, 17	16	25	4
November 14	5, 10, 12, 13, 17	6	20	3
November 21	5, 10, 12, 13, 17	6	45	8
November 28	5, 10, 12, 13, 17	6	20	3
December 8	5, 10, 12, 13, 17	10	25	4

II. Treatment of rabbits

DATE OF INJECTION	IDENTIFICATION NUMBERS OF RABBITS	DAYS PREGNANT	DOSE OF SERUM	REMARKS
			cc.	
December 14	1	11	8	Mating, 1 ♀ × 2 ♂
	13	21	8	Mating, 13 ♀ × 2 ♂
	B	21	8	Mating, B ♀ × 2 ♂
December 16	1	13	9	Very ill; no young
	13	23	8	Very ill; no young
	B	23*	8	Died Dec. 18; had macerated young in uterus

It is possible also that the severity of the treatment in experiment 10 was in some measure due to a more rapid entrance of the serum into the fetus because of greater permeability of the placenta in late fetal life, though we have no direct evidence on this point. But even if this were a sufficient explanation for the result in the case of rabbit 13 and rabbit B, it would hardly account for it in rabbit 1, since she had been pregnant only eleven days when the serum was first injected.

*Experiment 11*

Four fowls and four rabbits were used as recorded in table 2. The rabbits ranged from ten to sixteen days in pregnancy when

TABLE 2  
*Experiment 11*  
I. Sensitization of fowls

DATE—1918	FOWLS INJECTED	NUMBER OF RABBIT LENSES USED	NORMAL SALT SOLUTION	DOSAGE PER FOWL
			cc.	cc.
January 16	4	10	20	4
January 21	4	10	20	4
January 28	4	6 (half-grown)	15	4
February 6	4	4 adult, 6 newborn	15	4
February 14	4	4	19	4

## II. Treatment of rabbits

DATE OF INJECTION	IDENTIFICATION NUMBERS OF RABBITS	DAYS PREGNANT	DOSE OF SERUM	REMARKS
			cc.	
February 22	22	16	5	Mating, 22 ♀ × 2 ♂
	17	10	5	Mating, 17 ♀ × 2 ♂
	C	14	5	Mating, C ♀ × 2 ♂
February 26	22	20	6	
	17	14	6	
	C	18	6	
February 28	22	22	6	
	17	16	6	
	C	20	6	
March 2	22	24	5	5 young; March 7; eyes normal
	17	18	5	
	C	22	5	5 young, March 9; some eye defect; see text
March 5	17	21	5	3 young, March 16; eyes normal
	A	13	5	
March 7	A	15	6	
March 9	A	17	6	
March 14	A	22	4	5 young, March 22; 1 with eyes normal, others chilled to death



the first injection of the sensitized serum was given. It will be observed that the dosage was considerably smaller than that given in experiment 10. On March 7th rabbit 22 bore five young, all with eyes apparently normal. Rabbit C had five young March 9th. The eyes of these young did not open as soon as those of young do normally, and when finally open the eyeballs appeared to be somewhat flattened. In three of these young the characteristic reddish color of the albino's eye was noticeably less intense. The mother died April 13th and three of the young some days later. The lenses of one of these, examined immediately after death on May 11th were found to be pasty and milky-looking. Rabbit 17 bore three young March 16th, all with normal eyes. Rabbit A gave birth to five young on March 22nd. She had not made a suitable nest for them, however, and when found next morning all were badly chilled. Although placed in an incubator, all died except one. The eyes of this survivor were found to be normal when the lids finally opened.

#### *Experiment 15*

Three fowls and two rabbits were used, As shown in table 3, no young were secured. Rabbit A after four doses of serum developed paralysis of the hind legs and died June 22nd. Rabbit 20 was obviously pregnant, but the young were killed in utero apparently by the later injections. She was ill for some time and although used in later experiments she proved infertile. We have found infertility to be a common experience following deaths of young in utero. Apparently the resorption is so prolonged that the uteri remain blocked for a long time or else changes are set up in the uteri which either obstruct them or otherwise prevent conception or placentation. In rabbits which abort their young, on the other hand, we have had little difficulty in securing young within a short time afterward. For example, rabbit 17 (tables 4 and 5) apparently aborted some of her young on January 5th, but following another mating she had five young April 5th.

*Experiment 20*

Twelve fowls and five rabbits were used as set forth in table 4. Although all of the rabbits had been observed to mate, only two of the five bore young. It was not determined whether the fail-

TABLE 3

*Experiment 15*

## I. Sensitization of fowls

DATE—1918	FOWLS INJECTED	NUMBER OF RABBIT LENSES USED	NORMAL SALT SOLUTION	DOSAGE PER FOWL
			cc.	cc.
April 20	3	6 (half-grown)	10	3.0
April 27	3	6	10	3.0
May 4	3	6	10	3.5
May 11	3	6	10	3.5
May 18	3	6	10	3.5

## II. Treatment of rabbits

DATE OF INJECTION	IDENTIFICATION NUMBERS OF RABBITS	DAYS PREGNANT	DOSE OF SERUM	REMARKS
			cc.	
May 30	20	9	5	Mating, 20 × 2
	A	?	5	Mating, A × 2
June 1	20	11	5	
	A	?	5	
June 6	20	16	5	
	A	?	5	
June 10	20	19	5	20—obviously pregnant; young died in utero
	A	?	5	A—developed paralysis of hind-legs; died, June 22

ure of nos. 11 and 20 to have young was due to lack of impregnation at mating or to death of the young in utero. After the fifth injection no. 22 became very ill, and on December 19th she was killed. Dissection showed the uteri to be filled with pus. There was no trace of young. If any had been present at first

TABLE 4  
*Experiment 20*  
 I. Sensitization of fowls

DATE—1919	FOWLS INJECTED	NUMBER OF RABBIT LENSES USED	NORMAL SALT SOLUTION	DOSAGE PER FOWL
			cc.	cc.
November 7	12	6	20	1.5
November 11	12	6	20	1.5
November 21	12	6	20	1.5
November 30	12	6	20	1.5

II. Treatment of rabbits

DATE OF INJECTION	IDENTIFICATION NUMBERS OF RABBITS	DAYS PREGNANT	DOSE OF SERUM	REMARKS	
			cc.		
December 10	11	7	6	Mating, 11 ♀ × 44 ♂	
	17	7	6	Mating, 17 ♀ × 16A2 ♂	
	20	7	6	Mating, 20 ♀ × 2 ♂	
December 12	11	9	5 + 3 (normal salt solution)		
	17	9			
	20	9			
	16A1	5	6		Mating, 16A1 ♀ × 16A2 ♂
	22	5	6		Mating, 22 ♀ × 44 ♂
December 14	11	11	5 + 3 (normal salt solution)		
	17	11			
	20	11			
	16A1	7			
	22	7			
December 17	11	14	6		
	17	14	6		
	20	14	6		
	16A1	10	6		
	22	10	6		
December 19	11	16	6		
	17	16	6		
	20	16	6		
	16A1	12	6		
	22	22	6		No. 22, ill; killed; oviducts filled with pus
December 21	11	18	6	No. 17 had 1 young and 2 placentas; see text No. 16A1 bore 4 young, January 7; eyes normal Nos. 11 and 20, no young	
	17	18	6		
	20	18	6		
	16A1	14	6		

they must have entirely disintegrated. No. 16A1 had four young January 7th, all with normal eyes apparently. In the case of no. 17 one live young and what appeared to be two good-sized placentas without any trace of young attached to them were found on the morning of January 5th. The mother was gnawing at one of the placentas, and it was possible that young had been attached to the placentas originally, but had been eaten. The single live young one was not taken care of by the mother and soon died. The doe, although a good mother on previous occasions, had plucked out none of her hair nor otherwise prepared a nest for the coming of this litter. She apparently had no milk or at least made no attempt to suckle the young one that survived, although it was very active and insistent for a few hours. It is an interesting incident that this same doe in preparing a nest for her next litter which was born April 5th, denuded herself entirely of hair as far as she could reach along her belly and sides so that she looked almost like a hairless rabbit. The nest was a huge mass of fur.

#### *Experiment 21*

Six fowls and five rabbits were used (table 5). It was thought that possibly a more active serum might be obtained if the antigen were introduced intravenously into the fowl instead of intraperitoneally. Accordingly, two of the injections of pulped lens, the second and third, were made into the femoral vein. The first and fourth were subcutaneous and the fifth was intraperitoneal. Two of the rabbits, nos. 14A5 and 14A4, bore no young. No. 18A2 aborted five young April 1st and died April 9th. No. 17 bore five young April 5th, the eyes of which were normal, at least to all outward appearances. No. 16A1 had four young April 6th. Both eyes of one of these (fig. 2) were markedly abnormal. Unfortunately, it died May 11th. The eyes of the other young in the litter appeared to be normal. No. 16A1 had been mated to a brother, 16A2. They were from a Minneapolis strain of rabbits.

TABLE 5  
*Experiment 21*

## I. Sensitization of fowls

DATE—1919	FOWLS INJECTED	NUMBER OF RABBIT LENSES USED	NORMAL SALT SOLUTION	DOSAGE PER FOWL
			cc.	
February 8	6	6	20	2.0 cc. subcutaneously
February 15	6	8	20	1.0 cc. intravenously
February 22	6	6	15	1.0 cc. intravenously
March 1	6	8	15	1.5 cc. subcutaneously
March 19	2	4	8	3.0 cc. intraperitoneally

## II. Treatment of rabbits

DATE OF INJECTION	IDENTIFICATION NUMBERS OF RABBITS	DAYS PREGNANT	DOSE OF SERUM	REMARKS
			cc.	
March 17	14A5	9	4.0	Mating, 14A5 ♀ × 44 ♂.
	18A2	13	4.0	Mating, 18A2 ♀ × 16A2 ♂
	17	13	4.0	Mating, 17 ♀ × 44 ♂
	16A1	12	4.0	Mating, 16A1 ♀ × 16A2 ♂
	14A4	9	4.0	Mating, 14A4 ♀ × 16A2 ♂
March 19	14A5	11	4.0	
	18A2	15	4.0	
	17	15	4.0	
	16A1	14	4.0	
	14A4	11	4.0	
March 21	14A5	13	3.0	
	18A2	17	3.0	
	17	17	3.0	
	16A1	16	3.0	
	16A4	13	3.0	
March 25	14A5	17	2.5	No. 16A1 bore 4 young April 6; 1
	18A2	21	2.5	had both eyes defective; it died
	17	21	2.5	May 11.
	16A1	20	2.5	No. 17 bore 5 young April 5; eyes
	14A4	17	2.5	normal
				No. 18A2 aborted 5 young April 1
				and died April 9
				Nos. 14A5 and 14A4 had no young

*Experiment 22*

Inasmuch as it was desirable to get new defective-eyed individuals from a stock wholly unrelated to the line in which we had originally produced eye defects, and since 16A1, after treatment with lens-sensitized serum, had already given us an individual with conspicuously abnormal eyes (opaque lenses and reduced size), it was determined to try her again. The fowls used were two which had been left over from the earlier experiment in which 16A1 had been used (table 5), and as they had had their

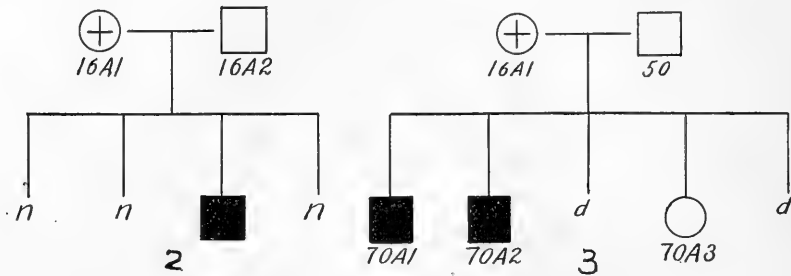

Fig. 2 Female 16A1 was mated to her brother, 16A2, shortly after which she was treated (table 5) with lens-sensitized fowl serum; one of her young, a male, had both eyes abnormal. See figure 5 for explanation of symbols.

Fig. 3 Female 16A1 was mated to male 50 and subsequently treated with lens-sensitized fowl serum (table 6); two of the resulting young, 70A1 and 70A2, each had both eyes defective. For explanation of symbols see figure 5.

last injection of pulped rabbit lens on March 26th it was thought advisable to resensitize them. They were given three additional doses of lens intraperitoneally on June 12th, 14th, and 20th, respectively (table 6). They had in the previous sensitization (table 5) been given two of the injections of lens intravenously.

Rabbit 16A1 was the daughter of a female shipped from Minneapolis and was, therefore, unrelated to our Madison stock. She was mated to no. 50, a male obtained in Chicago. On the eighth, tenth, fifteenth, and seventeenth days of pregnancy, respectively, she was injected with 4 cc. of the lens-sensitized fowl serum through the marginal vein of the ear. On July 21st five

young were born. One of these died two days later. Two of the remaining four had eyes normal in appearance and two had eyes markedly abnormal (fig. 3). One of the normal-eyed ones died when about three months old.

TABLE 6  
*Experiment 22*

I. Sensitization of fowls

DATE—1919	FOWLS REINJECTED	NUMBER OF RABBIT LENSES USED	NORMAL SALT SOLUTION	DOSAGE PER FOWL
			cc.	cc.
June 12	2	4	12	3
June 14	2	4	12	3
June 20	2	4	12	5

II. Treatment of rabbit

DATE OF INJECTION	IDENTIFICATION NUMBERS OF RABBITS	DAYS PREGNANT	DOSE OF SERUM	REMARKS
			cc.	
June 28	16A1	8	4	Five young born July 21. 1 soon died; 2 had very defective eyes; 2 had normal eyes
June 30	16A1	10	4	
July 5	16A1	15	4	16A1 ♀ was mated to 50 ♂
July 7	16A1	17	4	

CONTROLS

To determine whether eye defects induced by lens-sensitized fowl serum as just described are attributable to the specific action of the antibodies or merely to a general poisonous or asthenic effect of the fowl serum, it is obvious that careful controls must be instituted. Before the effect can be pronounced specific, it is also necessary to establish the fact that fowl serum sensitized to other tissues of the rabbit than crystalline lens will not induce the lens defects in question. To secure such controls we injected a number of pregnant does with pure (that is, unsensitized) fowl serum, and still others with fowl serum which had been sensitized to rabbit testis. The experiments follow.

*Experiments 12 and 13*

In these two experiments four rabbits were used as specified in table 7. From 4 to 6 cc. of fresh normal fowl serum was used for each injection. Rabbit no. 15 received three treatments; nos. 20 and 24 five treatments, and no. 19, eight treatments. Num-

TABLE 7  
*Experiments 12 and 13*  
Control: Treatment of rabbits with normal serum

DATE OF INJECTION—1918	IDENTIFICATION NUMBERS OF RABBITS	DAYS PREGNANT	DOSE OF SERUM	REMARKS
March 9	24	5	5.0	Mating, 24 ♀ × 2 ♂
	19	7	5.0	Mating, 19 ♀ × 2 ♂
	20	1	5.0	Mating, 20 ♀ × 2 ♂
March 12	24	8	6.0	
	19	10	6.0	
	20	4	6.0	
March 14	24	10	6.0	
	19	12	6.0	
	20	6	6.0	
March 16	24	12	6.0	
	19	14	6.0	
	20	8	6.0	
March 19	24	15	4.5	
	19	17	4.5	
	20	11	4.5	No. 20 bore 3 young April 8; eyes normal
May 4	15	11	5.0	Mating, 15 ♀ × 2 ♂
	19		5.0	
	24		5.0	Nos. 24, 19 and 15 bore no young; 24 evidently had young killed in utero
May 7	15	14	6.0	
	19		4.0	
May 11	15	18	6.0	
	19		4.0	



ber 20 bore three young, April 8th, all of which had normal eyes. The other three does became very ill and bore no young. No. 24, at least, had every evidence of having had the young killed in utero in a relatively advanced stage of development. As hap-

TABLE 8  
*Experiment 14*

Control: Treatment of rabbits with normal serum

DATE OF INJECTION—1918	IDENTIFICATION NUMBERS OF RABBITS	DAYS PREGNANT	DOSE OF SERUM	REMARKS
May 21	19	3	5	Mating, 19 ♀ × 2 ♂
	17	11	5	Mating, 17 ♀ × 2 ♂
	22	8	5	Mating, 22 ♀ × 2 ♂
	13	10	5	Mating, 13 ♀ × 2 ♂
May 25	19	7	3 + 2 (normal salt)	
	17	15		
	22	12		
	13	14		
May 29	19	11	5	
	17	19	5	
	22	16	5	
	13	18	5	
June 1	19	13	5	
	17	21	5	
	22	18	5	
	13	20	5	
June 6	19	18	4	All apparently aborted or resorbed young
	17	26	4	
	22	23	4	No. 13 had hind legs paralyzed for a time
	13	25	4	

pens under such circumstances, although later mated repeatedly she remained infertile.

*Experiment 14*

Four rabbits were used and five treatments with fresh normal fowl serum were given (table 8). Each rabbit apparently aborted

or resorbed her young. No. 13 had her hind legs paralyzed for some weeks, but ultimately recovered.

### *Experiment 16*

A single doe was used in this experiment (table 9). From the ninth to the twentieth days of pregnancy, inclusive, she was given six injections of fresh normal fowl serum. Two of the doses consisted of 5 cc. each; four of them of 6 cc. each. On August 22nd she bore five young, all with normal eyes.

TABLE 9

*Experiment 16*

Control: Treatment of rabbits with normal serum

DATE OF IN- JECTION—1918	IDENTIFICATION NUMBER OF RABBIT	DAYS PREGNANT	DOSE OF SERUM	REMARKS
			cc.	
July 31	22	9	6	Mating, 22 ♀ × 2 ♂
August 2	22	11	5	
August 4	22	13	5	
August 7	22	16	6	
August 8	22	17	6	August 22, 5 young born; eyes normal
August 11	22	20	6	

*Experiment 17*

Two rabbits were used and each dose of fresh normal fowl serum measured 5 cc. No young were secured (table 10).

*Experiment 18*

Three rabbits were used (table 11). Inasmuch as all three became ill after the first injection of 6 cc. of fresh normal serum, the second and third doses were reduced to 5 cc. diluted with 3 cc. of normal saline solution. The remaining doses were each 6 cc. of undiluted serum. Nos. 24 and 15 proved infertile. No. 20 bore four young October 12th, all with normal eyes.

TABLE 10  
Experiment 17

Control: Treatment of rabbits with normal serum

DATE OF INJECTION—1918	IDENTIFICATION NUMBERS OF RABBITS	DAYS PREGNANT	DOSE OF SERUM	REMARKS
August 6	13	?	cc. 5	Mating, 13 ♀ × 2 ♂ Mating, 19 ♀ × 2 ♂
	19	11	5	
August 8	13	?	5	
	19	13	5	
August 10	13	?	5	
	19	15	5	
August 12	19	17	5	
August 15	19	20	5	No young born

TABLE 11  
Experiment 18

Control: Treatment of rabbits with normal serum

DATE OF INJECTION—1918	IDENTIFICATION NUMBERS OF RABBITS	DAYS PREGNANT	DOSE OF SERUM	REMARKS
September 19	15	10	cc. 6	Mating, 15 ♀ × 44 ♂ Mating, 20 ♀ × 2 ♂ Mating, 24 ♀ × 44 ♂
	20	9	6	
	24	7	6	
September 21	15	12	5 + 3 (normal salt)	
	20	11	5 + 3 (normal salt)	
	24	9	5 + 3 (normal salt)	
September 23	15	14	5 + 3 (normal salt)	
	20	13	5 + 3 (normal salt)	
	24	11	5 + 3 (normal salt)	
September 26	15	17	6	
	20	16	6	
	24	14	6	
September 27	15	18	6	Nos 24 and 15 bore no young
	20	17	6	
	24	15	6	
September 30	20	20	6	October 12, no. 20 had 4 young; eyes normal
	24	18	6	

*Experiment 19*

Inasmuch as only one rabbit was used and no young were born, the experiment (table 12) is not significant beyond helping to complete our record and also to demonstrate some of the difficulties and discouragements which attend this kind of work.

*Experiment 23*

With this experiment (table 13) the use of fowl serum sensitized to rabbit testis was begun. Four fowls and four rabbits were used. The fowls were given four injections of pulped testis

TABLE 12

*Experiment 19*

Control: Treatment of rabbit with normal serum

DATE OF INJECTION— 1918	IDENTIFI- CATION NUMBER OF RABBIT	DAYS PREGNANT	DOSE OF SERUM	REMARKS
September 26	13	9	cc. 6	Mating, 13 ♀ × 44 ♂
September 28	13	11	5 + 3 (normal salt)	
October 1	13	13	5 + 3 (normal salt)	No young
October 2	13	14	6	

at intervals of about a week. To prepare the injection mass the testes of two adult rabbits were pulped by grinding in a mortar, normal saline solution being poured in from time to time until a total of 18 cc. had been added. The mass was then pressed through two layers of cheese-cloth to strain out the larger particles which would occlude the cannula of the syringe. Unlike lens emulsions, such emulsions of testis are always tinged more or less with blood. This would lead one to expect a more severe hemolytic reaction from antiserum produced from such emulsions than from normal serum or fowl serum sensitized to such relatively bloodless tissues as the lens or the humors of the eye. Whether, in fact, an increased intravenous hemolysis occurred in the rabbits treated with serum sensitized to testis we did not

TABLE 13  
*Experiment 23*

## I. Sensitization of fowls to testis of rabbit

DATE—1919	FOWLS IN- JECTED	MATERIAL USED	NORMAL SALT SOLUTION	DOSAGE PER FOWL
			cc.	cc.
June 7	4	Testes of two adults	18	4
June 14	4	Testes of two adults	18	4
June 20	4	Testes of two adults	18	4
June 26	4	Testes of two adults	18	4

## II. Treatment of rabbits with serum sensitized to testis

DATE OF INJECTION—1919	IDENTIFI- CATION NUMBERS OF RABBITS	DAYS PREGNANT	DOSE OF SERUM	REMARKS
			cc.	
July 5	17	8	6	Mating, 17 ♀ × 44 ♂
	34	6	6	Mating, 34 ♀ × 44 ♂
	35	7	6	Mating, 35 ♀ × 50 ♂
	33	7	6	Mating, 33 ♀ × 50 ♂
July 7	17	10	5 + 3 (normal salt)	
	34	8	5 + 3 (normal salt)	
	35	9	5 + 3 (normal salt)	
	33	9	5 + 3 (normal salt)	
July 9	17	12	5 + 3 (normal salt)	
	34	10	5 + 3 (normal salt)	
	35	11	5 + 3 (normal salt)	
	33	11	5 + 3 (normal salt)	
July <sub>1</sub> 12	17	15	6	No. 17 had 7 young July 26; eyes normal
	34	13	6	No. 34 had 8 young July 29;
	35	14	6	one died; eyes of all normal
	33	14	6	
July <sub>1</sub> 14	17	17	6	No. 35 had 7 young July 28;
	34	15	6	one died; eyes of all normal
	35	16	6	
	33	16	6	No. 33 had 6 young July 28; eyes normal
July 17	17	20	6	
	34	18	6	
	35	19	6	
	33	19	6	

determine, as the matter seemed to have little or no direct bearing upon the experiments in hand, but it is a fact that the rabbits showed more symptoms of illness after injection with such serum than with the serum used in earlier experiments, and in one instance, in a later set of controls, one rabbit died in convulsions about four hours after being injected. On the other hand, more of the does finally bore young than in any other set of experiments.

The details of dosage, number of injections, dates, etc., are set forth in table 13. A total of twenty-eight young were obtained from the four does under treatment. Two of the young died before their eyes were open, leaving twenty-six to be examined for eye defects. The entire twenty-six were found to have normal eyes.

#### *Experiment 24*

Three fowls and four rabbits were used as shown in table 14. The fowls were each given 5 cc. of an emulsion of pulped rabbit testis in normal saline solution on five different occasions at intervals of about a week. Three of the rabbits received five injections of the testis-sensitized serum, one of them only four. The latter, no. 16A1, died in convulsions about four hours after the fourth injection, having been pregnant twenty days. An autopsy showed that she was carrying eight young. No. 17 bore seven young, all normal-eyed; no. 36, three young, all normal-eyed. No. 37 bore three young, but as she had made no nest and did not care for them in any way, they died. Thus the experiment yielded ten young which survived, all with normal eyes.

#### IS THE REACTION SPECIFIC?

Before entering upon the question of specificity, it seems advisable to say a word further about the nature of the defects. In our opinion, practically all of the eye defects obtained, both in the immediate young of treated mothers and in subsequent generations, are of such a nature that they may reasonably be interpreted as due primarily to suppressed or abnormal development.

TABLE 14

*Experiment 24*

## I. Sensitization of fowls to testis of rabbit

DATE—1919	FOWLS INJECTED	MATERIAL USED	NORMAL SALT SOLUTION	DOSAGE PER FOWL
			cc.	cc.
September 16	3	Testes of two adults	12	4
September 23	3	Testes of two adults	12	4
October 1	3	Testes of two adults	12	4
October 9	3	Testes of two adults	12	4
October 16	3	Testes of two adults	12	4

## II. Treatment of rabbits with serum sensitized to testis

DATE OF INJECTION—1919	IDENTIFICATION NUMBERS OF RABBITS	DAYS PREGNANT	DOSE OF SERUM	REMARKS
			cc.	
October 28	17	13	4.0	Mating, 17 ♀ × 16A2 ♂
	16A1	13	4.0	Mating, 16A1 ♀ × 23A2 ♂
	36	13	4.0	Mating, 36 ♀ × 23A1 ♂
	37	10	4.0	Mating, 37 ♀ × 16A2 ♂
October 30	17	15	4.0	
	16A1	15	4.0	
	36	15	4.0	
	37	12	4.0	
November 1	17	17	5.0	
	16A1	17	5.0	
	36	17	5.0	
	37	14	5.0	
November 4	17	20	3.0	16A1 died in convulsions 4 hours after 4th injection; 8 uterine young
	16A1	20	3.0	
	36	20	3.0	
	37	17	3.0	
November 6	17	22	2.5	17 bore 7 normal young, November 15; 36 bore 3 normal young; November 15; 37 bore 3 young, November 19, which died next day
	36	22	2.5	
	37	19	2.5	

of the crystalline lens. Inasmuch as the lens is relatively large in the eye of the rabbit, it seems legitimate to infer that the small size of the affected eyes, recorded in a number of cases, is due primarily to total or partial inhibition of growth of the lens. And since in its origin the lens is concerned so intimately, both mechanically and probably also chemically, with changes in the optic cup, it is not unreasonable to attribute such malformations as open choroid fissure resulting in cleft iris (coloboma), irregularities in distribution of retinal blood-vessels and of blood-vessels of the eyeball, abnormal postures of the eyeball, and flattening of the eyeball, as likewise due primarily to initial abnormalities in the lens. The occasional persistence of the hyaloid artery obviously points to an arrest of development of the whole lens apparatus at a well-recognized stage of its formation, since this artery together with a plexus of blood-vessels which invests the lens, though normal structures at one period of lens development, should atrophy and disappear once it is constructed.

One other fact should be mentioned, namely, that in pulping and injecting the lenses, undoubtedly small amounts of the aqueous and of the vitreous humors were carried over also since no special effort was made to eliminate every trace of them. It is probable, therefore, that the sensitized fowl sera included to some extent antibodies for these humors. This opens up the possibility that they, too, may have played some part in the eye deformations, although we have had no visible evidence that such was the case. The one central phenomenon in all the eye defects is the opacity of the lens—sometimes homogeneous, sometimes pebbly, sometimes flaky in appearance—together with its diminution in size.

The first thought that occurs to the embryologist, of course, is that perhaps the abnormal condition is due to just a general poisonous or inhibitive effect of a foreign serum upon the developing fetus or upon a specially sensitive part of it, the eye. From the well-known work of Stockard ('09, '14) and others, the eye, at its inception at least, is known to be particularly susceptible to deleterious chemical influences. In the present instance, however, if the effect is a general one, then it should be as readily



obtained through the use of unsensitized fowl serum or of fowl serum sensitized to other rabbit tissues than crystalline lens, as by means of fowl serum containing rabbit lens antibodies.

But when our experiments with fowl serum sensitized to rabbit crystalline lens are compared with our controls, it will be noted that eye defect appeared only in the young of mothers injected with the serum sensitized to rabbit lens. Leaving out of account the uterine dead, aborted young, and young which died

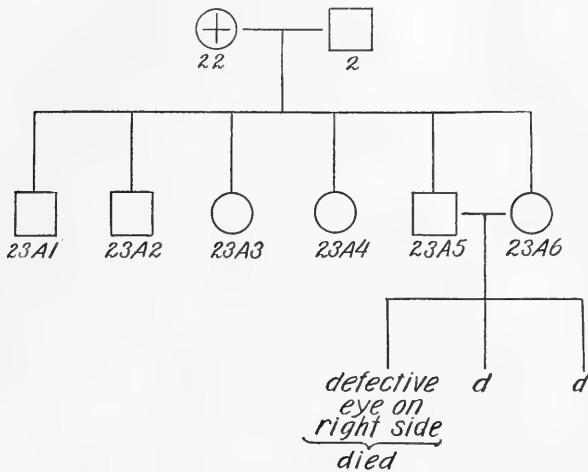

Fig. 4 Female 22, after mating with male 2, was treated with lens-sensitized fowl serum; all of the resulting young (23A series) were normal. When 23A5 and 23A6 were bred together, however, an individual with a defective right eye was born. See figure 5 for explanation of symbols.

before the eyelids separated, but counting the young obtained in the experiments recorded in our earlier paper ('18), 61 young were obtained from mothers treated during pregnancy with lens-sensitized serum. Of these, 4 had conspicuously defective eyes and 5 others had eyes sufficiently different from normal eyes to be recorded as abnormal, and therefore probably due to the effects of the sensitized serum. In one instance, although the immediate young of a mother treated with lens-sensitized serum seemed unaffected, they begot one young one with a defective right eye (fig. 4). From mothers treated with pure fowl serum

12 living young were obtained, and from others treated with serum sensitized to rabbit testis, 36 were secured, or a total of 48 young which survived long enough to show the condition of their eyes. In not a single one of these 48 controls was there evidence of eye defect. As far as our experiments go, therefore, the interpretation is that the effect of the lens-sensitized serum is specific.

As to why the lenses of the mothers into which the lens-sensitized serum was originally injected were not attacked, we have no further explanation to offer than the suggestion in our earlier paper that the lack of circulation of blood through the lenses of adults prevents the sensitized serum from reaching them in sufficient quantity to produce visible change. In the fetus the condition is very different. There, after the tenth day of development, the lens capsule is highly vascular, receiving blood from a specially developed branch (hyaloid artery) of the retinal artery. This hyaloid artery, together with its plexus of blood-vessels surrounding the lens, normally disappears shortly before birth.

#### PLACENTAL PENETRATION

Yet another problem that requires attention is that of how the lens antibodies penetrate the placenta. From the study of F. R. Lillie ('17) on the free-martin, it appears that in the case of two-sexed twins in cattle if the sex hormones of the male circulate in the female, the latter is transformed into a sterile free-martin. This happens only when secondary fusions of the chorions of the two individuals occurs, permitting direct anastomosis of the fetal circulation so that the blood of each may flow through the veins of the other. By implication therefore, without this direct connection of blood-vessels the sex hormones of the male would presumably not reach the blood of the female fetus. It seems reasonable to suppose that as regards penetration of the placenta, sex hormones and ordinary antibodies or cytolytins would come in the same category. This may or may not be true. But it is possible that under normal conditions small quantities of sex hormones from the male do reach the blood of the female in the

case of two-sexed twins, but that they are there neutralized by appropriate antibodies generated in the female fetus, and that it is only when the latter is overwhelmed by blood from the male through direct continuity of the blood-vessels that the antibodies are insufficient to accomplish neutralization. The condition known to exist in the blood of pregnant mothers for neutralizing, or better perhaps digesting, any placental fragments which may escape into the maternal blood-stream renders this hypothesis less far fetched than at first sight it might appear to be.

However this may be, the situation as described by Lillie has suggested to the authors the necessity of knowing more about the manner in which such substances as antibodies get through the placenta from mother to young. The junior author is already engaged in researches looking toward a solution of this problem.

Whatever the means, it is obvious that, in general, antibodies can penetrate the placenta, since it is well known that induced immunity to various forms of bacterial infection are transmitted through the placenta to the uterine young. Also it has been shown that such a foreign substance as madder when fed to pregnant mothers will pass through the placenta and color the bones of the fetal young. It is well established, moreover, that certain pathogenic agents may traverse the placenta and produce ante-natal infections.

In our experiments, that all the young were not invaded, or that they were unequally invaded, or that being invaded some were more resistant than others to the influence of the antibodies, is evident from the fact that a very substantial majority of the total number of young obtained showed no specific effect of the treatments. It is not impossible that in the struggles of the mothers, slight breaking down of the walls of the placental blood-vessels occurred in some cases, permitting some direct flow of the maternal blood into the fetus. And it may be that only such fetuses got a sufficient amount of the lens antibodies to have their own lenses affected. But whatever the means, the important fact is that penetration was accomplished in some way, with the result that defective-eyed offspring were occasionally produced.

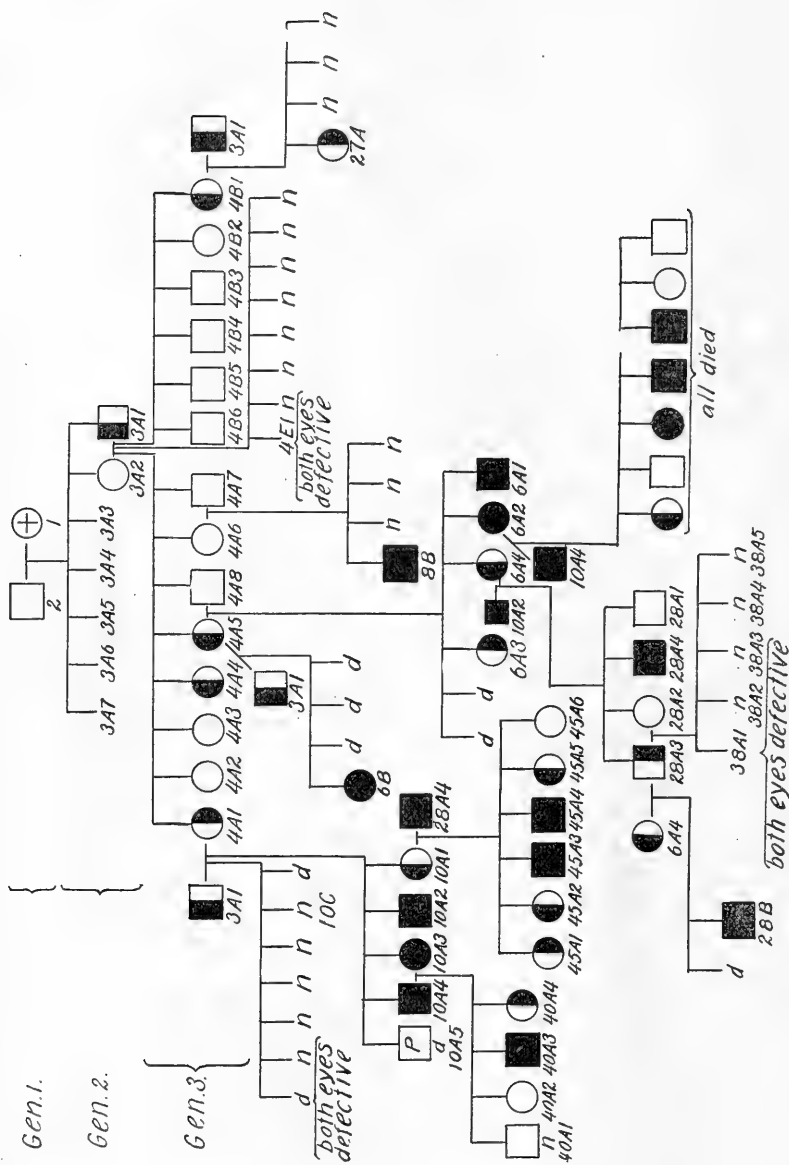

Fig. 5 Chart showing the pedigree of some of the fifth and sixth generation defective-eyed individuals. Note all of the matings of the individuals represented in the chart are shown. The circle with the + sign in its center indicates the female which was treated with the lens-sensitized fowl serum. Squares indicate males; circles, females; all black symbol, both eyes defective; right half black, right eye defective; left half black, left eye defective; d, died; n, normal; P, paralyzed.

## TRANSMISSION OF THE DEFECTS THROUGH BREEDING

Perhaps the most interesting and important result of our experiments is the establishment of the fact that the defects, once secured, may be transmitted to subsequent generations through breeding. So far, we have succeeded in passing the condition to the sixth generation, and there seems to be no reason why it will not go on indefinitely, since the imperfection tends to become worse in succeeding generations and also to occur in a proportionally greater number of the young.

At present we have thirty-seven living individuals with markedly abnormal eyes. Many more could have been secured if all the defective-eyed animals had been mated as frequently as possible. Up to the present, however, our chief aim has been to pass the defect through as many successive generations as possible.

As an example of increased intensity of the defect in later generations, the case of a male (3A1, fig. 5; pls. 1 and 2) with a bad left eye may be cited. Many of his grandchildren had both eyes abnormal, culminating in two which never opened their eyes. Subsequent dissection of the latter showed that minute eyeballs were present under the closed lids. This progressive intensification of the defect was to be expected, perhaps, up to a certain limit, since close inbreeding was practiced.

A glance at figure 5 shows that sometimes one, sometimes the other, and not infrequently both eyes were affected. This irregular unilateral and bilateral transmission recalls the somewhat similar genetical histories of such deformities as polydactyly and brachydactyly.

Little effort has been made so far to find out just what genetical factors are involved in the transmission of the defect. The abnormal condition has in general the characteristics of a Mendelian recessive. When defective-eyed males or females are bred to normal-eyed individuals from other stock, for instance, only normal-eyed progeny result in the ensuing generation. But the defect may be made to reappear in subsequent generations if appropriate matings are made. A good example of this is found

in the male-line experiments shown in figures 6 and 7. Again, two apparently normal-eyed individuals from the defective line have had bad-eyed offspring. But on the other hand, two

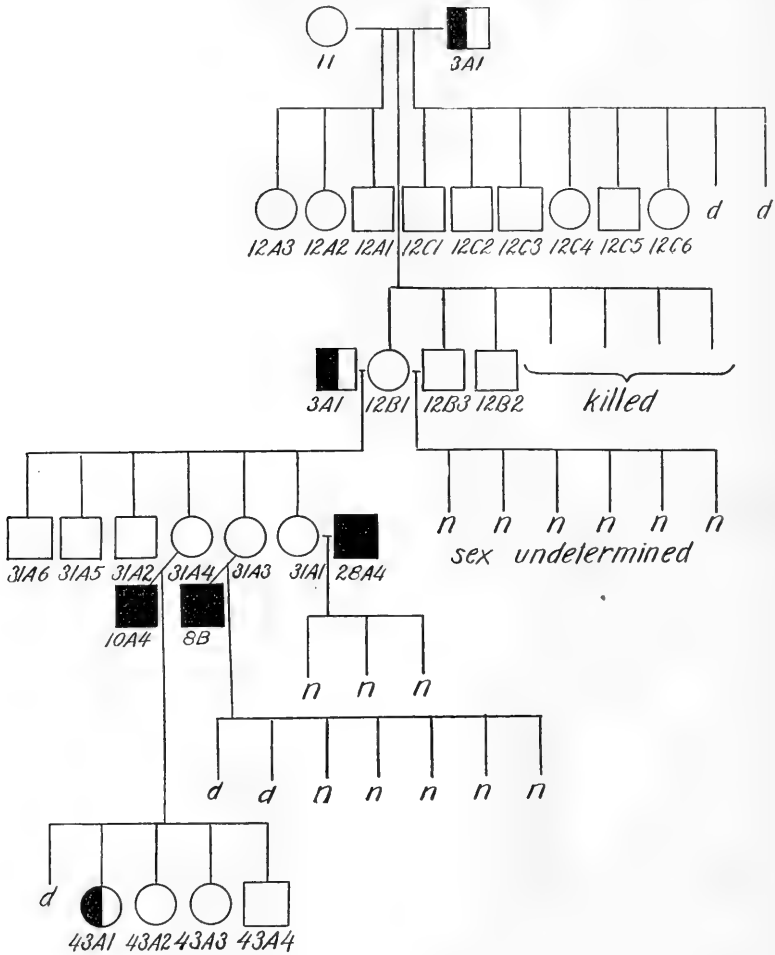

Fig. 6 Inheritance of the defect through the male line. Symbols same as in figure 5.

defective-eyed individuals (fig. 5) may have what appear to be normal-eyed young, so that on a strictly Mendelian interpretation we should have to suppose that heterozygotes sometimes

show the defects or, in other words, that normality is not always dominant. Such 'reversed' dominance, however, is by no means unknown in the annals of Mendelism. We are entering upon a series of matings to clear up this and other doubtful points connected with the exact mode of inheritance.

For starting our investigation into the inheritance of the defect, the offspring of a female designated in our pedigree charts as no. 1 and a male, no. 2, were selected (fig. 5). This pair had already yielded a normal litter of five before they were used in the serum work. After being mated to no. 2, November 30, 1916,

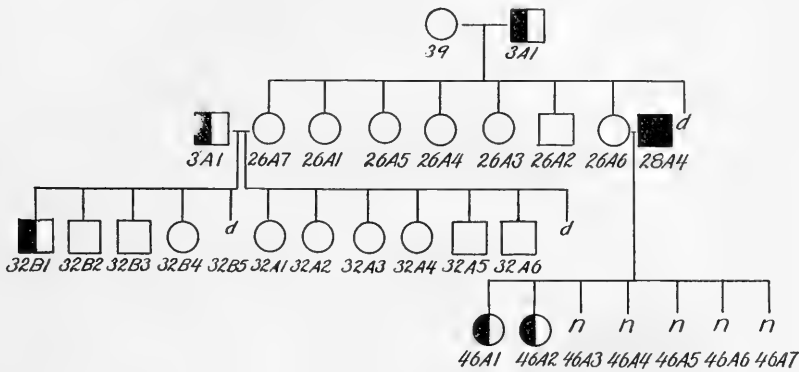

Fig. 7 Inheritance of the defect through the male line. Symbols same as in figure 5.

the female had been injected with fowl serum sensitized with rabbit lens. The details of this sensitization and the schedule of injections are given in our 1918 paper, page 73, table 2, in which this same female is designated as rabbit B. In the ensuing litter, born December 30, was a male with a markedly defective left eye which in time almost entirely disappeared. In order to find out whether or not this defect could be transmitted to the next generation, this male, numbered 3A1, was mated to his sister 3A2, whose eyes were normal as far as could be ascertained from an external examination (fig. 5). The offspring, known as the 4A series, born November, 1917, showed surprising results, for three females from the litter of eight young had abnormal eyes. In

two (4A4, 4A5) the defect was on the left side as it had been in the father, while in the third (4A1) it was the right eye that showed the abnormality. In the right eye of 4A1 the iris, almost transparent, was interrupted below (coloboma) and did not expand or contract (pl. 1, 4A1). The eye as a whole was smaller than the left eye. The lens likewise was smaller and was opaque, causing the peculiar silvery hue already described. These same defects appeared in the left eye of 4A4 and of 4A5 (pl. 1, 4A5). Another litter (fig. 5), 4B series, from the same parentage was born March 14, 1918. One female, 4B1, had a left eye like her father with no trace of iris or pupil (pl. 1, 4B1). The eyeball was so small and collapsed that the condition of the lens could not be determined. The eyes of the remaining five (four males and one female) were normal in size and appearance.

The female, 3A2, was next bred to a male from normal stock, and on July 26, 1918, gave birth to six normal-eyed young, the 4C series. When bred to another normal male, she again, on December 24, 1918, produced six young in which the eyes showed no abnormalities (4D series). Finally she was again mated to her brother 3A1, and on May 5, 1919, brought forth eight young. One in this litter, known as 4E1, had both eyes defective, but it died before the sex was determined.

It will be noted that each of the three separate times 3A1 and 3A2 were bred together some young with abnormal eyes were obtained. In all, from this pair, a total of twenty-two offspring were secured. Of these, seventeen had eyes which appeared to be normal and five had eyes which were defective. This is about as near to the 3:1 Mendelian ratio, obtained through the breeding of two heterozygotes, as can be approximated in twenty-two individuals. The female parent, however, showed no evidence of eye defect. When she was bred into normal strains the immediate young were always normal-eyed. We have not as yet tried to extract the defect from her normal-eyed progeny. It may be mentioned in this connection, although the details are not discussed till later, that the male of this pair, 3A1, was repeatedly bred into normal strains and always yielded normal-eyed young, but we have extracted the defect again from this



line, both by mating back to 3A1 and by mating to another defective-eyed male (figs. 6 and 7).

To return to the 4A series, some of the females of which had meanwhile been bred back to 3A1 or to their brothers. On April 26, 1918, 4A5 (left eye defective) produced six young sired by 4A8, a normal-eyed brother (fig. 5). Two died immediately. Of the remaining four (6A series) three were females; 6A2 (pl. 1) had coloboma and opaque lenses in both eyes; 6A3 had coloboma in the right eye only and the lens had an opaque rim; in 6A4 (pl. 1) the left eye was much smaller with the eyeball rotated toward the front leaving only a small part of the pupil visible through which an opaque lens could be seen. In 6A1, (pl. 1), the male, each eye had coloboma and an opaque lens.

Next, 4A5 was bred back to her father 3A1. From this mating four young were born December 28, 1918. In this litter (fig. 5) one female, 6B (pl. 4), had a right eye about one-fourth normal size and the iris, incomplete toward the corner, did not expand or contract; the lens was clouded. The left eye had a normal pupillary reflex, but the iris was more translucent than normal and the margin of the lens was milky. The eyes of the other three were apparently normal.

Another female, 4A1 (pl. 1), when mated to 3A1 (fig. 5) gave birth to five young June 21, 1918. Of this litter, 10A1 (pl. 1), a female, had coloboma and an opaque lens in the left eye, while the right eye outwardly normal contained a slight flaw in the lens; 10A2 (pl. 1), a male, had the left eye similar to 10A1 except for a larger pupil, and the right eye very small and peculiar in color; 10A3 (pl. 1), a female, had both eyes small with irises incomplete and lenses clouded; 10A4 (pl. 1), a male, had eyes like 10A3 until he was half grown, but later the left eye collapsed so that no detail could be made out in it; 10A5, a male, with eyes apparently normal had the hind legs completely paralyzed and died on August 19, 1918. However, it should be noted that the eyes of 10A5 were never examined with the ophthalmoscope and such examination has revealed cloudy or flawed lenses in some eyes which outwardly appeared normal.

Next, 4A1, was bred to her brother 4A8 (this mating not shown in fig. 5) and her progeny of six born December 27, 1918, were all normal. Lastly, she was mated again to 3A1, and on July 17, 1919, brought forth seven young, the 10C series. One died immediately. Of the six remaining, five with normal eyes lived and one with both eyes defective died.

To continue the history of the 4A series, 4A2, a normal-eyed female, was first bred to 4A7 (eyes normal) and gave birth to five normal young on May 7, 1918. Then she was mated to 4A8 (eyes normal), and on December 11, 1918, produced five young which were likewise normal. After being bred to 4A7 on June 3, 1919, she aborted one young. None of these matings are shown in the chart (fig. 5).

Another normal-eyed female, 4A6, when mated to 3A1, had a litter of eight normal young on June 9, 1918. However, when she was mated to her brother 4A7, a normal-eyed male, one male, 8B, from the litter of five born December 27, 1918, had the left eye normal in color and structure but small and a right eye with a translucent iris and cloudy lens (fig. 5). A female, 4A4, with a defective left eye also was mated to 3A1 and gave birth to eight normal young on June 10, 1918. Previously (April 4, 1918) she had also borne two normal-eyed young, although they had been fathered by 6A1, a male with both eyes defective.

The defective-eyed offspring from the 4A series consists of eleven individuals: males 6A1, 10A4, 10A2, and 8B; females 6A2, 6A3, 6A4, 6B, 10A1, and 10A3; 10C with sex undetermined.

Passing now to the 4B series, one female, 4B1 (fig. 5) with the left eye collapsed was mated to 3A1 and produced four young on December 12, 1918. In one female, 27A, the right eye was exceedingly small, while the cornea and lens were both opaque.

Only one of the 4E series had defective eyes and it died before it was old enough to leave progeny. Altogether, then, twelve defective-eyed rabbits were produced in the fourth generation; four males, one with sex undetermined, and seven females. In two females, four males, and the one in which the sex was undetermined, both eyes were affected, while in two females the left eye was abnormal and in three females, the right eye.

Offspring from the fourth generation are chiefly from matings between the 10A and 6A series, hence each series cannot be considered separately. The female 6A2 in which both eyes were defective was mated to 10A4 (both eyes abnormal), and on April 5, 1919, bore seven young, all of which died between July 20 and July 28, 1919. However, four of the lot had eye defects (fig. 5). One female had a bad left eye and two males and one female had both eyes defective. Of the males one never opened his eyes, but a postmortem held after his death on May 7th revealed small eyeballs under the shut lids. A female, 6A3, with an abnormal right eye was bred to 6A1, a male with both eyes defective, and the three individuals born May 31st were all normal (not shown in the chart). Another female, 6A4, (fig. 5) with the left eye affected was first bred to 10A2, a male with both eyes defective. Of the four young born January 22, 1919, one male 28A3 had a small right eye in which the lens was milky. Another male 28A4 had a left eye normal in size, iris and color, but the lens was clouded; the right eye was one-third normal size, had a cleft iris, cloudy lens, and persistent hyaloid artery. A female, 28A2, was normal-eyed in appearance, although one lens had a streak across it.

The male, 28A3, was mated to his mother (6A4, left eye defective) and one, 28B, of the two young born July 8, 1919, had a collapsed eyeball on the left side with only a slight indication of iris and pupil; the right eye was small and the lens contained opaque spots (fig. 5). A female, 10A3, with both eyes abnormal after being mated to 10A4, similarly affected, brought forth four young, the 40A series, May 31, 1919. Two of these had normal eyes; one female had a right eye affected and one male had both eyes affected (fig. 5).

When bred to 28A4, (pl. 4) 10A1 (left eye defective) gave birth to seven young on October 26, 1919. These, known as the 45A series (fig. 5), contained five with bad eyes, as follows: a female with left eye normal in size and general appearance, but with an opaque lens; a female with a partially opaque lens and coloboma in the right eye; a female with a smaller left eye in which the iris was incomplete and the lens opaque; a male with both

eyes about one-half normal size, both having coloboma and clouded lenses; a male with left eye of normal size, though rotated forward and containing an opaque lens and an incomplete iris, and with right eye abnormally small and containing defective iris and lens.

The fifth generation, then, included fourteen individuals in which the eyes were defective: one female and seven males with both eyes abnormal, three females and one male with the right eye defective, and two females with the left eye affected.

Some progeny of the sixth generation have been secured (fig. 5) and the defect is still present. For instance, 28A2, classed as normal, although she had a streak across one lens, when mated to 28A3 (right eye defective), brought forth five young on August 12, 1919, the 38A series, one of which had both eyes defective.

Other young of the sixth generation will be secured and the matings carried farther. This is a slow process for, in our experience, not more than three generations can be obtained in two years. The rabbits usually breed when six to eight months of age, although several have been ten to twelve months old before having their first litter.

In all of the matings described in detail so far, the female has been from the defective stock. The objection might be raised, therefore, that in each new generation we were not getting instances of true inheritance, but merely a placental transmission of antibodies or kindred substances from the blood-stream of the mother. While it would be difficult indeed to explain how such antibodies could remain undiminished in successive generations, nevertheless the situation clearly called for the establishment of the descent of the defect through the male line before it could be pronounced unequivocally an example of inheritance. Manifestly, if the defect appeared among the descendants of a male with abnormal eyes and a female from unrelated and untreated stock, then we could be sure that it was conveyed through the germ cell of the male alone.

In order to test this point, the male, 3A1, was bred to a normal female, no. 11, obtained from Fort Wayne, Indiana (fig. 6). On March 6, 1918, she produced a litter of three, the 12A series, all of

which had normal eyes. A litter of seven from the same female, sired by 3A1 was born next, and they likewise were normal-eyed (series 12B). Still another lot of eight, the 12C series, were born of the same parentage, and they, too, were normal-eyed. However, on the supposition that the defect acted as a recessive in the presence of normal eyes, the results were what would be expected.

Next, 12B1, a female, was selected for further tests. She was first mated to her brother, 12B3, and the six young born January 2, 1919, all had normal eyes (fig. 6). If 12B1 were heterozygous for the defect, as it was reasonable to suppose, young with abnormal eyes should be obtained more readily by mating her with 3A1. This was done, but six normal-eyed young, the 31A series, were born April 6, 1919 (fig. 6). Another litter of seven normal-eyed young, the 41A series, was born October 6, 1919. Thus far no defective-eyed individuals had appeared.

Next, the females of the 31A series were bred to males having both eyes defective (fig. 6). On October 19, 1919, 31A4, bred to 10A4, gave birth to five young, the 43A series. One died two days later and of the remaining four, one female has a small left eye with cleft iris (coloboma) and opaque lens. No. 31A3, mated to 8B, produced a litter of seven on November 3, 1919. The five that lived have normal eyes. The other female, 31A1, bred to 28A4, bore three normal-eyed young November 5, 1919.

The male, 3A1, was also bred to normal female 39 from a new stock secured in Minneapolis (fig. 7). She gave birth to a litter of eight young on July 26, 1918. One of this litter died September 7. The seven remaining, called series 26A, consisted of six females and one male, all with normal eyes (fig. 7). Later, 26A7, was mated to 3A1 and produced five young, the 32B series, on October 5, 1919. One died the next day, one of the remaining four, a male 32B1, has the left eye smaller than the right, the eyeball slightly rotated toward the front, the iris interrupted ventrally, and the lens opaque.

The female, 26A3, was bred to 10A4 (both eyes defective) on October 22, 1919. All of the eight young brought forth November 22nd were normal-eyed. On October 22, 26A1 was bred to

3A1, and the six young born November 23rd had normal eyes. On October 22nd, 26A6 was mated to 28A4 (both eyes defective) and gave birth to seven young, on November 24, 1919. In this litter one female had a left eye smaller than the right and the lid so covered it that details could not be made out. Another female had a small left eye with an opaque lens (fig. 7).

Thus four individuals have been secured, so far, with defective eyes that came through the male line. It seems needless to say that the normal females used had first been tested with other males and the progeny remained normal through the several generations obtained. Since the defect in question passes down through the male line as well as through the female line, it is clearly a case of true inheritance.

One other result merits attention here. To a female, 22, treated with chicken serum sensitized to rabbit lens, a litter of six, series 23A, was born on March 7, 1918. None of the individuals showed any eye abnormality, but they were kept until mature, whereupon 23A6 was bred to 23A5, her brother (fig. 4). On December 11, 1919, she had three young, two of which died immediately. The remaining one never opened the eye on the right side, although it lived until January 2, 1919. Dissection showed the eyeball to be considerably smaller than that of the open eye. Next, 23A3 was mated to 23A2; the five young born January 3rd all had normal eyes. Another litter of five from the same parentage born on May 22, 1919, were likewise normal. Also, 23A4 was mated to 23A5, and the six young born January 23rd, 1919, were normal. One male from this litter fathered another litter of five born to 23A4, July 19, 1919, all normal.

Before closing the section on inheritance, it seems desirable to call attention again to the facts brought forward on pages 171 and 173 regarding the safeguards employed to eliminate the possibility of the defect's being originally a mere chance variation in a single stock. To these facts should be added the further one that scores of young have been obtained by the same males from the sisters of the females treated with sensitized serum and no kind of eye defect has ever appeared, although the intensive breeding practiced certainly gave every recessive factor a chance

for expression. Moreover, the serum-treated females themselves which had yielded young with abnormal eyes were repeatedly bred to the same males after the serum treatments were stopped, yet, although many young were born, they never produced any more individuals with defective eyes. Inasmuch as the litters obtained in later experiments from a stock unrelated to our main strain contain individuals with imperfect eyes (fig. 3), we are at present engaged in establishing new defective lines.

#### CONCLUSIONS

After going through the literature of serology, the outstanding impression in the minds of the authors is the superabundance of theories which prevail and the scarcity of unambiguous facts. The field is an extremely intricate one and the pitfalls are many, not the least of which is the drawing of conclusions from the use of too few animals. For the literature certainly shows that even in the same species of animal there may be marked individual differences in serological behavior.

In view of the confusion and uncertainty of interpretation which prevails in this field, the authors do not feel it incumbent upon them to attempt to supply a fully perfected theory which shall account for all the details of just what is taking place in the interior of the soma or the germ of the fetuses borne by the specially treated mothers. The thing that interests them most is that a certain effect *has* been produced; and, what is of greater importance, that once established, the condition may be transmitted from generation to generation. In view of the fact that the defects have been carried into the sixth generation by breeding, without any subsequent treatments with the sensitized sera, and, above all, since the modifications have been extracted through the male line, thus eliminating all possibility of the condition in later generations having been due merely to placental transmission from the blood of affected mothers, we feel that the evidence establishes a clear-cut case of inheritance of a specific modification produced by extrinsic factors.

It is not entirely clear as to whether the result should be reckoned primarily as an example of the inheritance of a somatic

modification—that is, a change produced in the lens of the uterine young which in turn has induced a change in the lens-producing constituents in the germ cells of these young—or as simultaneous changes in the eyes and in the germ cells of the young. In either case the inference is that there is some constitutional identity between the substance of the mature organ in question and its material antecedents in the germ.

Against the first supposition is the fact that in one case, at least, a defective-eyed individual was produced from a father and mother, each of which had eyes that appeared normal, though these parents were in utero at the time their own mother was treated with lens-sensitized serum. In this instance it would seem that changes had been induced in the eye factors in the germ cells of one or both of these uterine young, although their own eyes had remained unaffected. It is possible, of course, that changes—for example, liquefaction without opacity—had occurred in their eyes, but had been undetected by the observers. Again, in some instances defective-eyed young have been secured from one defective-eyed parent and one apparently normal-eyed parent, where the latter came of defective-eyed stock, or was in utero when the mother was being treated with serum containing lens antibodies, whereas the same defective-eyed parent bred to rabbits of normal ancestry yielded young with normal eyes only. In such cases it would seem that the apparently normal parent had had changes made in its germ cells by the sensitized serum, even though these had not been manifested in its own eyes. Lastly, the fact that among the progeny from two normal-eyed individuals of the defective line young with abnormal eyes may appear (fig. 5), after the manner of an extracted Mendelian recessive, indicates that whatever its origin the abnormality becomes a germinal constituent which no longer requires expression in the immediate parental body to call it forth.

On the other hand, if the lens antibodies acted directly on the germ cells of the fetal young, then one would have every reason to expect that they would also act directly on the germ cells of the mothers originally treated with the antilens serum; but there is no evidence that such is true. Nearly every female



which survived the injections of the lens-sensitized serum was bred again, usually of the same male, and several of them were bred repeatedly, yet not a trace of eye defect was observable in their progeny.

It is a noteworthy fact that once the defects were established, without any subsequent treatments they became more and more pronounced in successive generations. In some of the fifth- and sixth-generation forms, for example, there was more of a tendency for both eyes to be affected than in earlier generations, and also an increased tendency for the eyeballs of the imperfect eyes to be very small—almost to the vanishing point. It would seem, therefore, that some cumulative influence was at work. As already pointed out, this might be due, in some measure at least, to the fact—if it is a fact—that a number of constitutional factors or modifying factors are concerned in the inheritance of the defects and that these have been accumulated by the intensive breeding practiced. However, there would seem to be a limit to this considerably short of complete disappearance of the eye.

The other alternative is, possibly, that the degenerating eyes are themselves directly or indirectly originating antibodies or other chemical substances in the blood-serum of their bearers which in turn affect the germ-cells. From the fact that such antibodies as isolysins can be established, it does not seem improbable that changed conditions in tissues would induce the formation of antibodies in an animal's own body. These once established, should be as effective in modifying germinal factors as corresponding antibodies introduced into the fetus through the placenta of the mother.

If this second alternative is true, then there opens up a wide field of possibilities as to the influence of the various parts of a body on the antecedents of such parts in the germ cells borne by that body. For such a condition would afford a ready means of modifying germinal factors by changes in the correlative organs of the parent, the blood serum of any organism with blood being the medium through which the influence is conveyed from the parental organ to the germ. As long as there is little change in the

somatic element, its germinal correlative would doubtless remain relatively constant, but with any pronounced change in the soma such as might give rise to the formation of antibodies or kindred substances in the blood serum—for example, degenerative changes in such an organ as the eye—a corresponding change might be induced in the germ. This hypothesis would seem to be of special value in accounting for progressive degenerative changes in successive generations as in the formation of vestigial organs.

That this conception of changes in the blood serum being occasioned by changed conditions in the tissues is not fanciful is evident when we recall that exactly such a condition arises during pregnancy. The Abderhalden ('13) serodiagnosis of pregnancy is based on the fact that a proteolytic ferment capable of splitting placental material into simpler substances appears in the blood serum of pregnant women. It arises, according to Abderhalden, as the result of the invasion of the maternal circulation by syncytial cells or their products derived from the newly forming placenta.

Ever since the discovery of the existence of such special internal secretions as hormones and chalones doubtless every biologist has thought of the possibility and many have expressed the idea that such substances might be concerned in some way in transmitting the results of somatic modifications to the germ, although, to our knowledge, no one has yet supplied a plausible explanation of how somatogenic are converted into blastogenic modifications by such means. We feel that our results may throw some light upon the possible existence of such a mechanism, though we do not intend to enter into this aspect of our subject at the present time. We may, however, discuss the question in greater detail in a subsequent paper.

As matters now stand, we do not feel impelled to insist on either interpretation of the mode of inheritance, still less are we inclined to undertake any categorical exposition of the serological detail. We are more interested in presenting the facts that our experiments have revealed.

## LITERATURE CITED

- ABDERHALDEN, EMIL 1913 *Abwehrfermente des tierischen Organismus*, 3d ed.
- CITRON, JULIUS 1914 *Immunity* (translated by A. L. Garbat). P. Blakiston's Sons & Co
- GUYER, M. F., AND SMITH, E. A. 1918 Studies on cytolysins: I. Some prenatal effects of lens antibodies. *Jour. Exp. Zoöl.*, vol. 26, no. 1, May.
- LILLIE, FRANK R. 1917 The Free Martin: a study of the action of sex hormones in the foetal life of cattle. *Jour. Exp. Zoöl.*, vol. 23, no. 2, July.
- STOCKARD, CHARLES R. 1909 The artificial production of cyclopiian monsters. *Jour. Exp. Zoöl.*, vol. 6.
- 1914 The artificial production of eye abnormalities in the chick embryo. *Anat. Rec.*, vol. 8.

## PLATE 1

### EXPLANATION OF FIGURES

Various types of the defective eyes described in the text compared with a pair of normal eyes (1). The numerals refer to the pedigree number of the individual in our records and in the chart shown in text figure 5. The eyes are drawn approximately to scale; those of the 10A series are from individual which were not yet mature. The bluish or silvery cast of many of the abnormal eyes is not due to pigment, but to opacity of the lens, coupled in some instances, probably, with deficiency of the retinal blood-vessels.

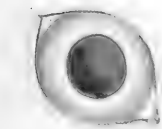

1

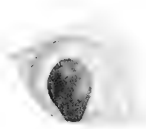
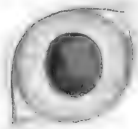

6A2

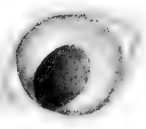

3A1

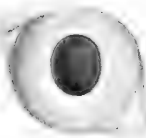
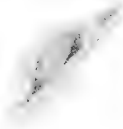

6A4

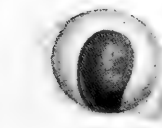
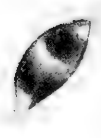

4A1

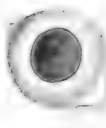
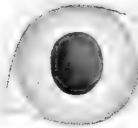

10A1

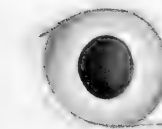
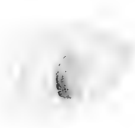

4A5

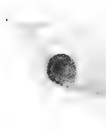
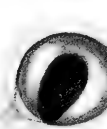

10A2

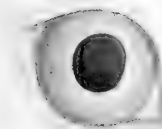
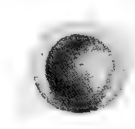

4B1

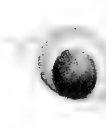

10A3

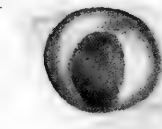
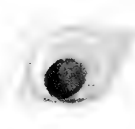

6A1

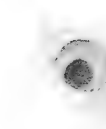
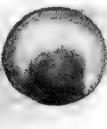

10A4



PLATE 2

EXPLANATION OF FIGURES

Showing right (top picture) and left eyes of individuals 3A1 (text-figure 5).  
The right eyeball is normal, the left has practically disappeared.



### PLATE 3

#### EXPLANATION OF FIGURES

Showing the left (top picture) and right eyes of individual 2SA4(text figure 5). The left eye is slightly smaller than normal size; its iris is complete and is functional; the lens, however, is so opaque as to be seen easily without the aid of an ophthalmoscope. The right eye, noticeably reduced in size, has an opaque lens and a cleft iris.



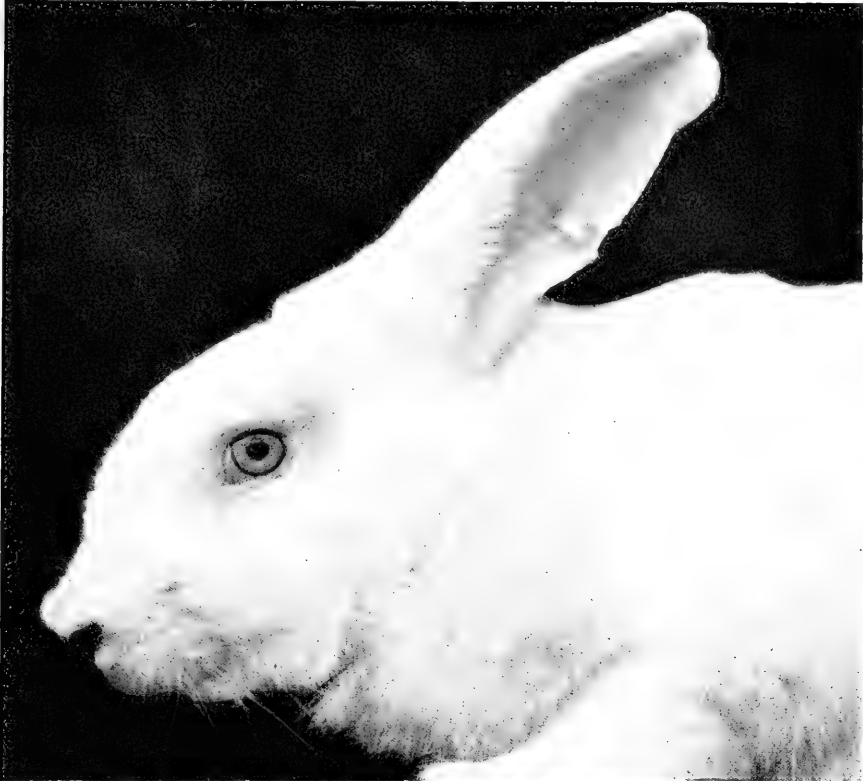

## PLATE 4

### EXPLANATION OF FIGURES

Showing the right eye of female 6B (text figure 5). It is markedly reduced in size (compare with the normal eye of 3A1, pl. 2) and is otherwise defective. In the lower picture the lids are being separated to show the iris which is incomplete below.

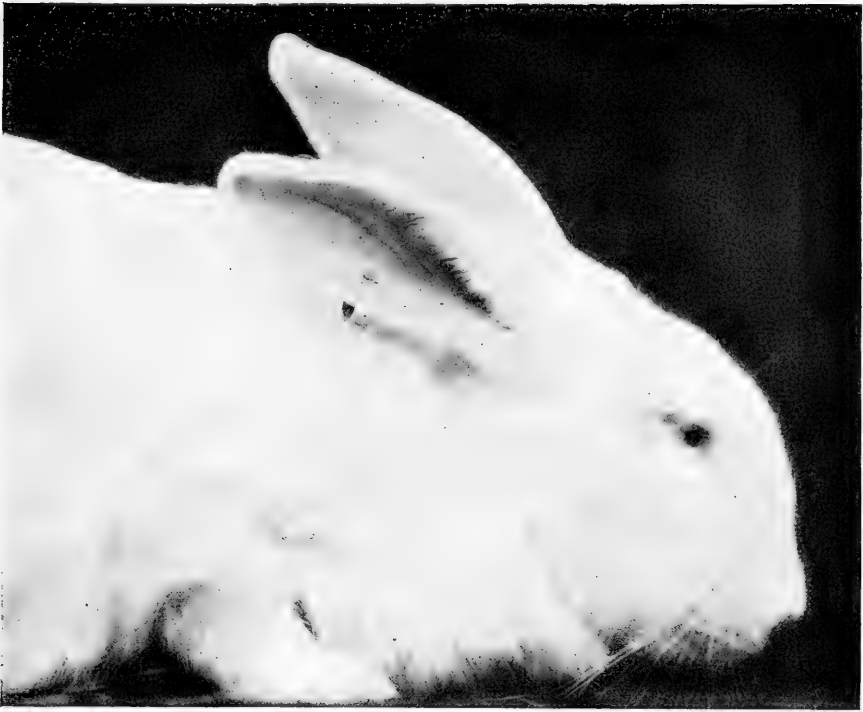

Resumen por el autor, George H. Bishop.  
Universidad de Wisconsin.

### La fecundación en la abeja.

#### I. Los órganos sexuales masculinos, su estructura histológica y funcionamiento.

Los cambios que tienen lugar en la estructura histológica del aparato sexual mesodérmico en el zángano recién salido del huevo, indican que los zánganos jóvenes no pueden fecundar a las reinas a causa del estado no maduro de dichos órganos sexuales durante un periodo de nueve días por lo menos. Los espermatozoides y el mucus permanecen en la vesícula seminal y el reservorio glandular mucoso, respectivamente, hasta el momento de la eyaculación. Los espermatozoides se insertan por sus cabezas en la pared de la vesícula seminal, cuya área superficial aumenta a causa de la formación de surcos y pliegues alternados que se disponen en espiral alrededor de su cavidad. La cavidad del conducto eyaculador ectodérmico, que se forma por invaginación del extremo anterior del pene, no se abre en la de la porción mesodérmica del aparato hasta que su extremo ciego quitinoso revienta al pasar los fluidos espermáticos. La musculatura de la base de la glándula mucosa está dispuesta de tal modo que su contracción bajo la acción del estímulo eyaculador separa esta región basal del reservorio mucoso distal, permitiendo el paso de los espermatozoides procedentes de la vesícula seminal a través de la base de la glándula y desde aquí al exterior por el conducto eyaculador. Durante la relajación que sigue a la primera contracción espasmódica, el mucus sigue al esperma, a causa de la presión ejercida por la contracción abdominal, de tal modo que obliga a penetrar a todo el esperma en los órganos femeninos. Después se coagula en contacto con el aire, cuando el pene se desprende del zángano. Varios estímulos artificiales causan una eyaculación normal en apariencia, y los más seguros son la inyección de un ácido débil en el tórax y la decapitación durante la huida. La estructura de los órganos, naturaleza de los líquidos, y funcionamiento del aparato bajo la influencia de estímulos artificiales indican un papel diferente de los espermatozoides y mucus durante la copulación.

## FERTILIZATION IN THE HONEY-BEE

### I. THE MALE SEXUAL ORGANS: THEIR HISTOLOGICAL STRUCTURE AND PHYSIOLOGICAL FUNCTIONING

GEO. H. BISHOP

*Zoological Laboratories of the University of Wisconsin*

THREE TEXT FIGURES AND THREE PLATES

#### CONTENTS

Introduction . . . . .	225
Historical . . . . .	227
Description of male organs . . . . .	228
Present investigation . . . . .	233
A. Histology and anatomy . . . . .	234
1. Glandular epithelium . . . . .	234
2. Muscle layers . . . . .	239
3. Ejaculatory duct . . . . .	245
B. Physiology . . . . .	246
1. Secretions . . . . .	246
2. Correlation between age and functioning . . . . .	249
3. Manipulation of drones . . . . .	250
Conclusions . . . . .	256
Summary . . . . .	257

#### INTRODUCTORY

The reproductive mechanism of the male honey-bee has been so often and so variously studied that one feels called upon to state at once the occasion for its further investigation.

The following study developed out of a series of unsuccessful attempts at the artificial fertilization of queen bees. Through a number of seasons this had been attempted by the methods which have been described by others as well as with newly devised apparatus. Two general classes of attempts were made. In the first, queen and drone were held in juxtaposition and the extrusion of the drone's organ brought about by pressure on the abdomen. In the second class of experiments, the seminal fluid of the drone was dissected out and injected with a pipette into

the organs of the queen. From the first experiments (juxtaposition of queen and drone) it became more and more evident that extrusion of the drone's organ caused by artificial means did not necessarily, nor generally, duplicate the natural act of copulation, even when it seemed to do so. For the second (injection) experiments, it became necessary to know both what the character and functions of the components of the male spermatic fluid were and what disposal was made of them during and after the normal act of copulation. Finally, copulation in the bee has been witnessed so rarely and can be observed directly with such difficulty that a study of the structure and functioning of the reproductive organs is the most hopeful avenue of approach to the problem of fertilization in the honey-bee. Thus, while the anatomy of these organs has been worked over repeatedly, the physiological and functional aspect of fertilization in the bee has received inadequate attention.

To obtain the further data, regarding the functioning of the drone's organs, which seem a prerequisite to success in artificial matings, and to investigate the physiology and the mechanics of fertilization in the bee, work has been conducted along the following lines:

Histological and anatomical study of the drone organs and their respective secretions, by means of dissections, paraffin sections, and stained whole mounts and hemisections, mounted in balsam.

Manipulation of drones to cause extrusion of the penis, with ejaculation of the spermatic fluid; in the attempt to produce artificially a complete physiological duplication of the results of normal copulation.

The histological work was commenced in 1915 under Prof. Trevor Kincaid at the University of the State of Washington, after several years of independent and unsystematic attempts to induce controlled copulation between queens and drones by mechanical stimuli and technique. It was continued during the next two years in the zoological laboratories of the University of Wisconsin. Doctor Marshall of that laboratory has given particularly valuable help, not only by way of advice, but by assisting in those operations that required the attention of more

than one person. Preparation for publication has been delayed by absence occasioned by the war.

#### HISTORICAL

Three papers<sup>1,2,3</sup> deal specifically with the development and histology of the drone sexual apparatus, and a larger number treat more or less comprehensively the gross anatomy, especially of the copulatory organ itself. The work of Bresslau<sup>4</sup> on the spermatheca of the queen and the accompanying mechanism has been checked by Zander<sup>5</sup> in a general account of the development of the organs in both male and female forms. Mating flights have been but rarely observed, and only incidentally, by bee-keepers, etc., and reported in their professional journals.<sup>6, 7</sup> Mating experiments have been reported frequently, but the very few cases of artificial or controlled matings reported as successful have not been sufficiently checked. There seems in this work to have been little attempt to take into consideration more than the superficial morphology with which the anatomical studies referred to have made us familiar.<sup>8</sup>

<sup>1</sup> Koschevnikov, G. Zur Anatomie der männlichen Geschlechtsorgane der Honigbiene. Zool. Anzeiger, Bd. 14, 1891.

<sup>2</sup> Michaelis, Geo. Bau und Entwicklung des männlichen Begattungsapparat der Honigbiene. Zeit. für wiss. Zool., Bd. 67, 1900.

<sup>3</sup> Snodgrass, R. E. Anatomy of the honey-bee. U. S. Dept. of Agriculture, Bureau of Entomology, Technical Series 18, 1910.

<sup>4</sup> Bresslau, Ernst. Der Samenblasengang der Bienenkönigin. Zool. Anzeiger, Bd. 29, 1905.

<sup>5</sup> Zander, Enoch. Die Ausbildung des Geschlechts bei der Honigbiene, Zeit. der angewandten Entomologie, Bd. 3, 1916.

<sup>6</sup> Shuck, S. A. Note in American Bee Journal, 1882, p. 789.

<sup>7</sup> Pratt, E. A. Note in A B C and X Y Z of bee culture. A. I. Root Co.

<sup>8</sup> Shafer, Geo. D. A study of the factors which govern mating in the honey-bee. Michigan Agr. College Exp. Sta., Div. of Entomology, Technical Bulletin 34, 1917.

This bulletin furnishes an exception to the above statement. Concerned primarily with artificial fertilization experiments, it describes the superficial appearance of the queen's organs (oviducts) after normal copulation and of the drone's organs after extrusion of the penis has been brought about by pressure; there is also speculation on the nature of the stimulus that causes extrusion of the drone's organ in natural and in artificial conditions. He includes as well a valuable bibliography of experiments on artificial and controlled matings of drone and queen bees.

A detailed consideration of this literature, even of that part of it which deals specifically with the organ of copulation, will not be undertaken here. The morphology of the organs and the complex adaptations for mating have been adequately described, and in general there is no serious disagreement as to the position of the insects or the relation of their organs in copulation. However, the physiology of the process has been almost entirely ignored. The functioning of the 'mucous gland' has received little more than speculative attention; the disposal of the sperm in the queen's organs has scarcely aroused curiosity, and the intricacies of functioning of the internal sexual organs of the drone seem to have escaped notice for the most part. The present paper is rather an attempt to supplement the morphological data with physiological, than to controvert the facts established. The papers above cited are therefore not of immediate bearing on the work under consideration, other than as a point of departure. For a detailed description of the anatomy of the sexual apparatus the reader may be referred to any of the more recent papers (as Snodgrass). A brief and general summary will suffice to present the anatomical picture necessary to an understanding of the work which follows.

#### DESCRIPTION OF THE MALE ORGANS

The mating flight of the queen bee takes place at least five days after the emergence of the imago, and probably ten or more days after the emergence of the drone. The rapidly flying insects meet in the air, the drones in pursuit. According to the reports of eye witnesses and to the evidence from examination of the drone organ left in the queen's vagina after copulation, they clasp face to face and drop at once to the ground. The drone is stunned and soon dies. The queen twists the drone organ in two, by flying or crawling in a circle around the drone, retaining the portion broken off. This gradually dries up, and is pulled away by the bees in the hive some hours after the queen has returned thither.



The penis of the drone (text fig. 1, *a*) is elaborately adapted to this manner of mating. It is a hollow tube, ectodermal in origin, non-muscular, growing by invagination from the ninth segment of the abdomen. Three main functional regions can be identified; the penis tube proper (*a*), the enlarged bulb at its anterior end (*b*), and the ejaculatory duct (*c*), leading from the bulb to the mesodermal sexual organs. The penis tube, proximal to the external opening, is of relatively large diameter;

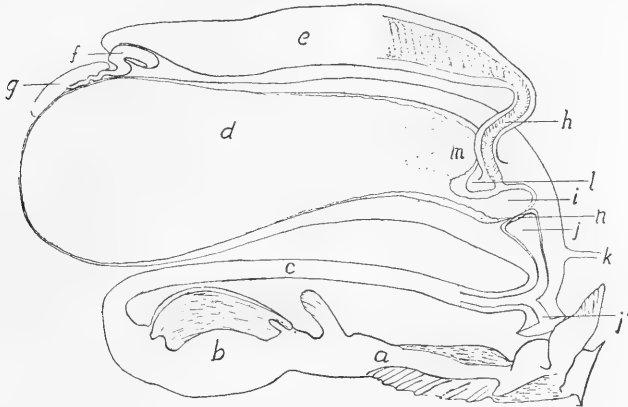

Text fig. 1 Diagram of one half of drone sexual apparatus, viewed from the medial side, showing the unpaired penis and ejaculatory duct, and the right members of the paired mucous glands, seminal vesicles, and testes of a mature drone. Internal anatomy of base of gland and vesicle shown as in optical section. The parts have been slightly displaced in mounting on the slide, in order to view them all in the horizontal plane; i.e., the anterior portion of the ejaculatory duct lies normally between the two glands, not below one of them; the tip of the other gland, joining the one figured at *j'*, extends dorsally at about right angles to this one, and not in the horizontal plane with it, and the vas deferens at *h* bends around the base of the gland so as to bring the seminal vesicle lateral to the gland rather than dorsal. *a*, penis proper; *b*, bulb of penis; *c*, ejaculatory duct; *d*, body of gland; *e*, seminal vesicle; *f*, vas deferens; *g*, testis; *h*, lower vas deferens leading to basal transverse pocket of gland, *i*, to which is applied the base of the cone-shaped end of the ejaculatory duct, *j*; *k*, slender muscle attaching the gland to the posterior abdominal wall; *l*, valve of muscle covered with glandular epithelium, which guards and partially surrounds the orifice of the vas deferens and partially divides the lumen of the gland proper from the basal pocket into which opens the vas deferens, and which upon contraction of the gland's musculature divides these regions completely; *m*, that portion of the gland's lumen which pushes out into the angle of the gland dorsal to the opening of the vas deferens; *n*, blind end of the ejaculatory duct.

it has a fairly stiff but elastic chitinized wall, and bears a series of complexly modified plates, bristles, and protrusions which appear to facilitate its entrance into, and secure its retention within, the vagina of the female. The medial portion, the bulb, is merely an enlarged and rounded part of this tube; it is on either side partially enclosed by a lateral shell-like plate, formed by the chitinous thickening of the wall of the bulb. This bulb tapers off into the third portion, the ejaculatory duct, a thin-walled, elastic, narrow-lumened tube leading to the seminal vesicles and the accessory glands (text fig. 1, *d* and *e*).

In copulation, this apparatus is everted from the drone's body into the vagina of the female. Since the penis itself has no muscles attached, its eversion is due to pressure from the muscular contraction of the abdominal walls. Starting at the region proximal to the genital aperture, the penis is gradually forced out from within, as one might force out a glove finger that had been turned inside out in stripping off, by blowing into the wrist of the glove. The eversion extends, according to Zander,<sup>5</sup> back to the median bulb, which, acting as a spermatophore, is kept from everting by its two lateral plates above mentioned (text fig. 2, *B*). Schafer<sup>8</sup> finds that the bulb also everts and concludes that it does not act as a spermatophore, but that its size merely enables these lateral plates, whose definite function is to hold the penis within the queen's organs, to turn inside out and lodge in their appropriate position like the gates of a canal lock (text fig. 2, *C*). The entrance of the ejaculatory duct into the bulb, according to this scheme, is thus brought through the everted bulb, and becomes the end of the everted penis. Either condition (*B* or *C*) may be produced artificially by greater or less pressure applied to the drone's abdomen.

The mesodermal portion of the sexual apparatus (text fig. 1, *d-h*) consists of three elements: 1) Paired testes, at the time of emergence of the imago, occupy a large part of the dorsal portion of the abdominal cavity; they undergo gradual diminution as the sperms are discharged, until at maturity only small triangular remnants remain (text fig. 1, *g*). 2) Passing posteriorly from

each of these, leads a vas deferens, proximal to the testis sharply coiled (*f*), and distally expanded into a seminal vesicle (*e*). 3) Distal (posterior) to the vesicle again, the vas deferens curves sharply (*h*) to enter the third element, the accessory gland (*d*). This organ extends anteriorly to a region slightly beyond the testis, the rudiment of which in the mature drone is usually applied dorsally to the tip of the gland (text fig. 1, *g*).

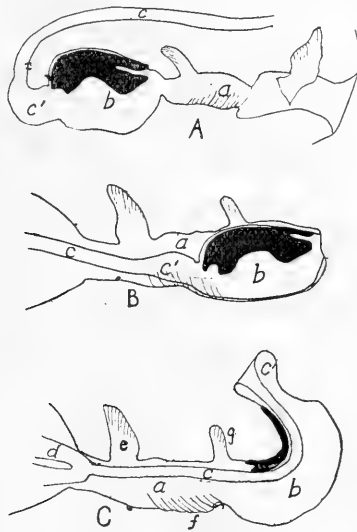

Text fig. 2 Diagrams of drone's organs, showing un-everted, partially everted, and completely everted relationships of the various portions, in A, B, and C, respectively. *a*, posterior or proximal tubular portion of the penis with modifications for facilitating copulation, *e*, *f*, *g*; *b*, bulb portion of penis, with lateral chitinous plates shown in black; *c'*, proximal end of ejaculatory duct *c*, expanded where it joins the bulb of the penis; *d*, the mucous glands. For further explanations see text.

In development, each vas deferens grows back from the testis sheath until it meets, ventrally, a cup-like invagination of the ninth segment of the abdomen which is to form the penis and the ejaculatory duct. The vas deferens fundament then curves back on itself to form a hook like the letter J, later, becoming a U. The recurved tip of the J forms the mucous gland; the stem the seminal vesicle. A branch of the ejaculatory duct penetrates

the lower portion of the U, at the base of the gland, thus uniting the ectodermal and mesodermal parts. Zander notes that the lumen of the ejaculatory duct does not become continuous with that of the gland until the contained fluids burst through the thin partition at the time of emptying of the secretions (see diagrams, pl. 1, and pl. 3, figs. 7-10). ("Die Berührungstelle, an der beide Kanalsysteme [of duct and gland], anscheinend bis zur Samenentleerung blind aneinander stossen," etc.) He leads one to infer that at the maturity of the drone (text fig. 2, *A, b*) the bulb of the penis, acting as a spermatophore, receives this secretion. Shafer, without noting this partition, infers that the sperms remain in the vesicle or the base of the gland until copulation, and do not pass into the penis bulb, but at the time of copulation are carried through the bulb in the ejaculatory duct (text fig. 2, *C*).

The accessory or mucous gland (text fig. 1, *d*, and pl. 1), developing from the blind recurved end of the vas deferens fundament, enlarges into a gourd-shaped body, lined with columnar glandular epithelium and enclosed by three muscle layers. These layers are an external longitudinal, a medial circular, and an inner layer which consists of three longitudinal bundles of fibers, extending from the base of the gland more than half way to its tip. The musculature is heaviest at the base, i.e., around the entrance of the ejaculatory duct, and attenuates toward the distal end. The whole is enveloped by a thin structureless membrane well supplied with tracheae. As the gland's lumen becomes filled with the secreted mucus, its distal end assumes a bulbous contour. The three muscle tracts of the inner layer cause an infolding of the glandular lining of the organ into three corresponding ridges, giving a cross-section of the lumen the shape of a clover leaf (pl. 1, fig. 3).

The seminal vesicle (text fig. 1, *e*, and pl. 1, *e*), like the gland, is lined with glandular epithelium, here thrown into ridges (Koschevnikov, "in Ringwalzen eingereiht"). There are two muscle layers surrounding it, an outer longitudinal and an inner circular layer. These correspond to the outer two of the three layers of muscle of the mucous gland. A membranous envelope

covers the vesicle; this is continuous with the envelope of the gland on one side and of the testis on the other. Sperms, passing into the vesicle, tend to arrange themselves radially in its lumen, their heads attached to the wall, their free filaments toward the center (pl. 2, figs. 5, 5b). The testes, which mature their sperm some days before the emergence of the drone, and at this time occupy most of the abdominal cavity, rapidly degenerate thereafter; in old drones they are noticeable only as small greenish-yellow remnants applied dorsally to the accessory glands.

#### PRESENT INVESTIGATION

Attempts to obtain motile sperms from drones, by dissection or otherwise, demonstrate that they are not available in all drones. This fact has been variously interpreted. McLain<sup>9</sup> inferred that there were three classes of drones. One class yielded no spermatic fluid when extrusion of the penis was brought about by compressing the abdomen. A second class yielded only mucus from the accessory gland. A third yielded a seminal fluid containing sperm. Shafer,<sup>8</sup> in discussing McLain's work, agrees with him that the food which drones receive at mating time is important as a stimulant to the copulatory impulse. The writer sought to correlate the observed facts of McLain with the known fact that young drones (younger than an age variously stated to be from ten to twenty-one days) will not mate with queens. Drones of different ages were selected for study, ranging from pupae whose eyes were just becoming pigmented to mature insects three weeks after emergence. These stages are designated in the present paper by the letters A to H (table, p. 252).

The fact became immediately apparent that a definite and complicated histological development and growth of the organs, rather than a special food stimulant, was involved in the difference of functioning observed. This development takes place

<sup>9</sup> McLain. Description of experiments on artificial insemination of queen bees, in report of the entomologist, on Experiments in Apiculture, U. S. Commissioner of Agriculture's Report for 1885.

after the drone is of superficially mature appearance, and continues to the fifth day of imaginal life at least though the drone is probably not functional until later (table, p. 252) The contents of the organs, their mode of responding to such stimuli as cause extrusion of the penis, and the motility of the sperm are all correlated specifically with the age of the drone. The age can be determined by superficial examination of the degree of degeneration of the testis. This undergoes a gradual shrinkage, and changes from a creamy-yellow color and bean-like shape, of 5 mm. length, to greenish-yellow color, flat triangular shape, and 1.5 mm. length. This change in the testis is a convenient measure of the histological development, size, and maturity of the other organs.

#### *A. Histology and anatomy of male organs*

The vas deferens, seminal vesicle, and mucous gland are derived from a common fundament; when mature they are histologically similar; they perform their functions of secretion and contraction in essentially the same manner. A detailed description of the histological elements and of their physiological characteristics may apply, therefore, to all the parts derived from this fundament taken together.

The two histological elements chiefly concerned here are the columnar cells of the glandular epithelium which forms the continuous wall of the lumen of these organs and the muscle layers that continuously envelop them. Concerning the glandular cells, the important considerations are the manner and nature of their secretion and the qualities of the product; concerning the muscle layers, their arrangement and the effect of their contraction upon the contents of the organs at different stages of development.

1. *The glandular epithelium.* The glandular cells (pl. 2, figs. 5a, 6a) are extremely long and narrow, twenty or thirty times as long as thick, with oval nuclei, one to each cell, scattered through the basal half of the cell layer. The nuclei are so large relatively to the diameter of the cells that the oval form may be assigned to compression by the cell walls. Their scattered

arrangement seems to be due to the fact that the nuclei bulge the walls slightly outward, and force nuclei of adjacent cells alternately upward and downward. The chromatin of the nuclei is mostly in three to five granules, the rest faintly scattering through the clear plasma. The chromatin stains more densely while secretion is taking place, and shrinks and takes the stain less densely when it ceases, but its disposition in the nucleus does not appear to alter. The cytoplasm is very finely granular (after fixation), slightly more densely staining around the nuclei, especially when the cells are functionally active after growth is complete. The distal ends of the cells contain larger and denser staining granules that give, in (cross-) section of the epithelium, the appearance of a dense granular band (pl. 2, figs. 5a, and 6a).

The cells of the glandular epithelium are modified according to the region of the lumen which they line. The cells lining the vas deferens between testis and seminal vesicle (text fig. 1, *f*) and those between the vesicle and the mucous gland (*h*) are more cubical than columnar. Here the nuclei are placed more evenly side by side and have a more rounded outline, but the characteristic structure and mode of secretion of the cells is identical. The cells of the seminal vesicle are about a half shorter than those of the gland, their nuclei are smaller and similarly disposed.

Secretion takes place by strangulation, with dissolution of the cell substance (pl. 2, figs. 5 and 6 b). The dense granular area at the tip of the cell widens, the granules increase in size, in refractiveness, and in density of staining, and finally vacuoles may appear among them. The end of the cell rounds up into a globule of secretion, which sloughs off into the lumen of the organ. This process is most pronounced in the gland, where the secretion retains its coarse granular character. These granules are transformed to highly refractive globules of somewhat larger size, as if by absorption of some of the fluid; the mass of the secretion at the same time becomes more viscous. In the seminal vesicle the granules are smaller and soon dissolve to a pale plasma (pl. 2, figs. 5 and 5 b). In the narrow portions of the vas deferens, at either end of the vesicle, neither the granu-

lation nor the strangulation are apparent. This is possibly owing to the slowness of secretion and the small degree of dissolution of these short cells. In the distal region of the vas deferens adjacent to the gland, the lumen does not always, as elsewhere, become clearly defined, but may remain loosely stopped with a network of strands and membranes which appear to be remnants of the walls of cells that filled this space (pl. 3, fig. 10, and text fig. 1, *h*). These cells become shortened inside their former membranes, to form a thin epithelium against the muscular layer enclosing the vas deferens. The cytoplasm is dense, the nuclei shrunken. The picture closely resembles the final appearance of the basal portion of the gland into which this portion of the vas deferens serves to conduct the sperm (pl. 3, fig. 10).

As the drone approaches sexual maturity, this process of secretion and reduction of the glandular epithelium commences in the tightly coiled epididymis-like portion of the vas deferens leading from the testis (text fig. 1, *f*). It progresses from the tips of the cells back to the bases (pl. 2, figs. 5, 5 a, 5 b), and in the vas deferens as a whole, from the testis posteriorly through the seminal vesicle. Shortly after the stage at which the cells lining the seminal vesicle start secreting, the cells lining the mucous gland commence to break down into secretion in the anterior end of the gland. The change progresses posteriorly again. Thus the cavities of these organs are enlarged through dissolution of their walls. This occurs earliest anteriorly, affecting last the posterior regions where the contents of both organs are to be evacuated into the ejaculatory duct (text fig. 1, *h* and *i*).

When this process has reached an advanced stage, it leaves the walls of the organs characteristically sculptured. In the gland (pl. 1, figs. *C*, *D*, *E*) the cells entirely disappear anteriorly, leaving a very thin membranous bulb-like sac which expands with mucous secretion. Posteriorly, the cell nuclei recede toward the basal region of the cells, the chromatin shrinks, the cytoplasm becomes heavily vacuolated, and the ends of the cells protrude into the gland's lumen in fringed and ragged patches (pl. 3, fig. 10, *m*). Vacuolization at the bases of the cells often appears to push whole areas of the cells out into the lumen, leaving their



bases attached to the muscle layer by attenuated remnants of the cell walls. There is evidence that the cells tend to break down unevenly; during the early stages this leaves elevated circular ridges running around the long axis of the gland; but these are neither regular nor do they persist except in vague outlines in the final stages.<sup>1</sup>

In the vas deferens and seminal vesicle the effect is more elaborate (pl. 1, figs. C, D, E, *e* and pl. 2 figs. 5 and 5 b). Commencing at the anterior end of the vas deferens the cells break down unevenly and in such a manner as to leave the surface of the epithelium in very definite ridges. This is much more clearly defined and regular here than in the gland. This condition is described in the mature insect by Koschevnikov as "in Ringwalzen eingereiht"; but a close inspection of a cleared whole mount or hemisection reveals an arrangement as of a spiral screw with four successive threads. There are about seventy turns, each 'thread' making fifteen to twenty turns of the spiral, though occasionally one ridge ends and is replaced by a new one. As will appear later the function is apparently to increase the surface for attachment of the spermatozoa. The nuclei of the epithelial cells arrange themselves, not parallel to the basal membrane of the epithelium, but in a layer following the folded surface (fig. 5 b). The nuclei retain appearances of activity and do not show shrunken chromatin and clear plasma as do the remnants of cells in the epithelium of the gland.

The commencement of this secretory and erosive process in the vas deferens overlaps the period of spermiogenesis in the testis. As the lumen enlarges it becomes filled with fluid. The sperms pass into it and through it into the seminal vesicle; here as the sperms descend the cells also break down into a secretion. This process in the seminal vesicle serves three purposes: provides a medium for the spermatozoa by dissolution of the glandular elements, renders the rather firm glandular wall flexible and capable of considerable distention, and allows the enclosing muscles to act easily at the time of ejaculation of sperm.

The sperms, still grouped in bundles as they left the cysts of the testicular tubules, attach themselves by the heads to the

ribbed surface of the vesicle, and the tails project into the lumen. When spermiogenesis is complete and all the sperms have become attached, a cross-section of the organ (fig. 5 b) shows, inside the muscular ring, first a ring of nuclei following the contour of the inner surfaces of the spiral ridges, then a distinct line of sperm heads at the surface of the epithelium, and finally the remainder of the lumen almost filled with the sperm filaments radially arranged, extending outward from a narrow central space. The spermatozoa even after attachment show a grouping into bundles.

Region of the ejaculatory duct. The development of the ejaculatory duct and its junction with the mucous gland-vas deferens fundament has been referred to above. The relation of the three parts, mucous gland (*i*), proximal part of vas deferens leading from the seminal vesicle (*h*), and the ejaculatory duct (*j*), requires a more detailed description (text fig. 1 and pls. 1 and 3).

The paired mucous glands lie parallel in the posteroventral region of the abdomen; the bulbous ends containing the mucous accumulation point anteriorly. The basal portion of each gland, with which both vas deferens and ejaculatory duct connect, bends at an angle of about 45° in the medioventral direction (text fig. 1). The tips of the two glands meet medially. The ejaculatory duct divides as it enters the junction of the two glands, and a branch penetrates the wall of each.

The vas deferens (*h*) makes a sharp curve from the seminal vesicle and enters the gland on the medial side, dorsal to the entrance of the ejaculatory duct (*j*). Around and particularly above the entrance of the vas deferens, the muscular wall of the gland is greatly thickened, and projects into the gland's cavity as a lip or valve guarding the entrance of the vas deferens (*l*). This valve partially cuts off from the body of the gland anterior to it the basal portion of the gland's cavity (*i*) into which lead both ejaculatory duct and vas deferens. It thus divides the cavity of the gland into two regions at the bend of the gland described above. One region of the gland's lumen becomes distally an elongated sac containing mucus, lying parallel to the

main axis of the abdomen. Its posterior margin is the valve projecting from the dorsomedial side of the lumen. Below this valve, the second region consists of a small flat pocket lying across the base of the gland (text fig. 1 and pl. 1, *v*). Into this pocket and from the valve's posterior surface opens the vas deferens (*h*). Applied ventrally to this pocket is the expanded end of the corresponding branch of the ejaculatory duct (*j*). This flattens out into the base of a cone, whose wall does not break through into the gland's lumen, although the gland's wall is penetrated by the blind end of this duct (pl. 3, figs. 9 and 10).

The relation of the parts therefore admits of the following hypothesis as to its functioning. If the flat pocket is collapsed, the edge of the valve is pressed close against the opposite side of the gland's lumen, shutting off completely the whole basal region of the gland from the sac full of mucus (pl. 1, fig. E, and pl. 3, fig. 10). The mouth of the vas deferens is applied at the same time exactly over the flattened blind end of the ejaculatory duct. If this be burst through, the result is a passageway through this system of organs extending through the vas deferens, seminal vesicle, lower vas deferens to the basal region of the gland, and out through the ejaculatory duct. It extends past the body of the gland as if the latter's content were not to be discharged with the content of the seminal vesicle; although in development the gland and vas deferens form a continuous tube, a tube whose lumen is closed off from the lumen of the ejaculatory duct by a membrane of chitin over the blind end of the latter. A consideration of the musculature of the region further points to this manner of functioning.

2. *The muscle layers.* The ejaculatory duct has no muscles in its wall; it is a single-layered tube of ectodermal origin invaginated from the hypodermis and chitinized on the inside. The vas deferens, seminal vesicle, and gland have two muscle layers, outer longitudinal and an inner circular layer, forming a continuous envelope over the whole of these organs. Running from the base of the gland half or more its length distally, a third or inmost muscular layer, consisting of three separate tracts of fibers, has been described (pl. 1, figs. 1 to 4, *x*, *y*, *z*). A closer analysis of

the course of these fibers indicates that they do not comprise a distinct third layer, but that they consist of a modification or distortion in the arrangement of certain bundles of the inner or circular layer in this region, and that this rearrangement is the method by which the otherwise simple musculature of the gland's base is adapted to an involved and complicated manner of functioning. The change, during development, in the relationships of the gland to the vas deferens and seminal vesicle on the one hand and to the ejaculatory duct on the other gives a clue to the origin of this 'third layer.'

Recalling that the vas deferens grows posteriorly from the testis sheath as a J- and finally a U-shaped fundament, one arm of which forms the mucous gland, the musculature may be described more carefully. It consists of a relatively heavy circular layer of fibers which is not distinctly separable into fascicles, lying next to the glandular epithelium, and a relatively thin longitudinal layer collected into distinct fascicles, between which a connective-tissue network allows for distention of the organ (pl. 2, figs. 5 and 5 b). There are about thirty-five of these fascicles in a cross-section of the vesicle; in the gland they are not so distinct and the fibers are arranged in a less specific manner. Both layers are thinner over the narrow portions of the vas deferens adjoining either end of the seminal vesicle, and both taper off over the distal portion of the gland into a very thin and elastic connective-tissue membrane.

It is at the base of the gland, where the musculature is heaviest and whence originate the three bundles of fibers comprising the inmost muscle layer of the gland, that the ejaculatory duct becomes adjoined to the mesodermal portion of the sexual apparatus. Only in the light of the significance of this junction can the elaborate conformation of this musculature be adequately interpreted.

We may picture at the bend of the U-shaped gland-vesicle fundament one branch of the ejaculatory duct penetrating this muscle mass to reach the lumen of its respective gland. At this place the wall of the gland protrudes to meet the duct. This protruded portion becomes the basal end of the gland (text.

figs. 1 and 3, *i*). One arm of the U, representing the gland (*d*), increases in size, while the other, that representing the vas deferens (*h*) remains relatively small. The result is, first, that the vas deferens becomes a fine duct leading into the massive gland and, second, that as the gland protrudes toward the ejac-

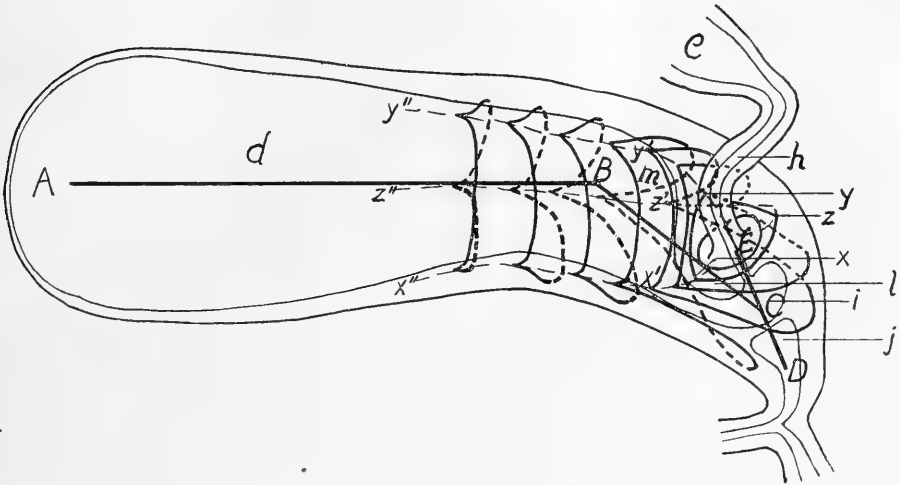

Text fig. 3 Diagram to explain the derivation of the third or internal muscle layer of the mucous gland. Lettering as for text figure 1, with addition of the following: *A-B-C-E*, original direction of the lumen of the gland-vesicle fundament in development; *A-B-C-D*, direction of lumen in mature gland, whose base has enveloped the blind end of the ejaculatory duct *j*; *XYZ*, path of the circular muscle fibers around the end of the vas deferens in the wall of the gland; *X''Y''Z''*, fibers around the body of the gland; *X'Y'Z'*, fibers distorted out of the circumferential position by the protrusion of the gland's base to meet the end of the ejaculatory duct at *i*, and by the second protrusion into the elbow of the gland, *m*; *X-X''*, *Y-Y''*, *Z-Z''*, three inner longitudinal muscle tracts derived from fibers of the circular layer by change in shape of the gland's base at *i* and *m*. See text for further explanations, also text figure 1.

ulatory duct to form a definite basal pocket (*i*), the entrance of the vas deferens into the gland is left distal to and at one side of this secondarily formed basal region; that is, it comes to enter not at the end of the gland, but at some distance up its side. From a U shape, the lumen of the two organs, mucous gland and

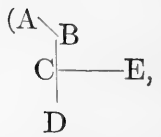
vas deferens, takes the form of a square-root sign 

text fig. 3), in which the perpendicular stem represents the gland, the horizontal arm the vas deferens, and the portion of the perpendicular below the arm, the protrusion which meets the ejaculatory duct.

This change in shape distorts the course of the fibers of the longitudinal and circular muscle layers. Their original course along and around the U-shaped axis of the original fundament is modified in conformity with the change from this axis to that of the mature gland. Where the base of the gland protrudes to meet the ejaculatory duct, the muscle layers are carried out in its wall and greatly thickened, investing the end of the duct and the base of the gland with a heavy and complexly arranged musculature (pl. 1 and pl. 3, fig. 10). Fibers of the outer longitudinal layer still pass longitudinally as before on one side, the dorsal and medial, as far as the vas deferens, and on the other side, the ventral, down to the basal tip of the gland whence leads the ejaculatory duct. From here they pass anteriorly again on the dorsal side to the vas deferens. On the lateral aspects of the base of the gland, the fibers of this layer must pass across in a transverse direction to reach the vas deferens. The fibers of the circular layer are correspondingly distorted. This layer still encircles the gland above the entrance of the vas deferens (text fig. 3,  $x''$ ,  $y''$ ,  $z''$ ) and encircles the end of the vas deferens itself ( $x$ ,  $y$ ,  $z$ ) at its juncture with the gland. But below the region of the vas deferens entrance, these circular fibers, whose fundamental course may be considered to have been in concentric rings about the end of the vas deferens, are distorted by the base of the gland having protruded toward the ejaculatory duct ( $x'$ ,  $y'$ ,  $z'$ ). They extend toward the base of the gland in the same general direction as the longitudinal fibers of the same region, but criss-crossing them diagonally (pl. 3, fig. 10).

The fibers forming the valve that partially closes off the anterior from the basal or posterior portion of the gland (*l*) may be derived from a thickening of the circular layer around the end of the vas deferens. To form the valve these fibers protrude into the lumen of the gland anterior to the vas deferens and furnish posterior to it additional material for thickening the muscle mass about the end of the ejaculatory duct.

Contraction of the muscles encircling this region would close off the basal pocket in the gland by compressing the valve (*l*) against the opposite wall; contraction of the muscles extending along the base of the gland would collapse the flat pocket (*i*) cut off by this valve. In this manner the aperture of the vas deferens would be forced against the blind end of the ejaculatory duct, as the anatomical relations of these parts, previously described, indicates to be possible (p. 239; pl. 1, E, and pl. 3, fig. 10).

One more modification of the shape of the gland requires explanation. The vas deferens enters the mature gland on the median side; just anterior to its entrance the gland bends at an angle of  $45^\circ$  to meet the ejaculatory duct, so that its basal tip points ventrally and medially toward the tip of the other gland (text figs. 1 and 3). Thus the tips of the two glands come to point toward each other; in fact, are joined superficially. Anterior and dorsal to the entrance of the vas deferens and to the valve, the lateral portion of the gland's lumen protrudes out to form the elbow or bend (text fig. 1, *m*). This valve, which guards the aperture of the vas deferens, forms the posterior boundary of the protruded portion, and the muscle fibers of the gland's wall are carried out around the lumen (text fig. 3, *y'-z'*). This protrusion of the gland's wall thus causes a distortion of the muscle layers somewhat in the same manner as does the protrusion toward the end of the ejaculatory duct on the ventral side.

A cross-section of the gland just at this angle would show as a result of these changes a tripolar arrangement (pl. 1, figs. 1 and 2). At one pole is the entrance to the vas deferens (*h*), at a second, the base of the gland envelops the end of the ejac-

ulatory duct (*j*), and at a third, the lumen of the gland swells out into the gland's elbow (*m*). In text figure 1 these regions may be identified between *x* and *y*, *x* and *z*, and *y* and *z*, respectively.

The three tracts of the inner 'third layer' may then be derived as follows (pl. 1, figs. 1 to 4, *x*, *y*, and *z*, and text fig. 3,  $x''-x$ ,  $y''-y$ , and  $z''-z$ ):

*x*. Fibers of the inner circular layer originating along the median side of the gland, from a region anterior to the opening of the vas deferens, and from the muscle mass in the valve guarding it, pass on the medial side of the gland toward its base, here penetrated by the ejaculatory duct ( $x''-x$ ).

*y*. Fibers from the same region, but passing dorsal to the vas deferens, extend posteriorly around the protruding elbow of the gland ( $y''-y$ ).

*z*. Both sets of fibers pass anteriorly on the opposite side of the gland's base, between the ejaculatory duct and the gland's elbow, to the region on the gland opposite to the end of the vas deferens ( $z''-z$ ).

The anatomical findings suggest and bear out this derivation for these three muscle tracts, except that the muscles extend anteriorly further along the side of the gland than the mass of the circular fibers from which they are believed to have been derived. This may be considered a functional modification to afford that insertion of the fibers on the sides of the gland which would enable them to operate most effectively.

Along these three tracts and extending for about the same distance, the glandular epithelium is elevated into the lumen of the gland in such a manner as to give its cross-section a trilobed shape (pl. 1, fig. 3). One channel so caused (between two adjacent tracts) extends distally from the expanded elbow of the gland; along the lateral aspect, between *y* and *z*; a second, along the medial side from the valve anterior to the opening of the vas deferens, between *x* and *y*, and a third, between *x* and *z* distal to the end of the ejaculatory duct and passing opposite to the valve, is continuous ventromedially with the basal transverse pocket of the gland which receives vas deferens and ejaculatory duct. Distally all three merge into the uniformly rounded bulbous sac in which the gland ends.



3. *The ejaculatory duct.* The ejaculatory duct and the glandular lining of the basal portion of the gland with which it connects remain to be described (pl. 3, figs. 7 to 10). The blind end of the duct penetrates the gland's muscular coat; here it expands into a cone whose base becomes applied, as described before, to that aspect of the gland's basal region which is directly opposite the opening of the vas deferens. The hypodermal cells forming this cone become elongated around its base from cubical to a distinctly columnar form. The base of the cone becomes heavily chitinized, especially that part lying over the cells which are most elongated (pl. 3, fig. 9). At the center of the base the cells are shorter, and here the chitin is laid down in two layers over a very small area (pl. 3, figs. 7 to 10, *n*). Between these two layers is a small mass of material staining more densely (with iron-alum-haematoxylin) than the chitin, which later disappears or else shrinks greatly, leaving the two layers separated by a space. The layer toward the lumen of the gland is considerably thinner than the other (pl. 3, fig. 10, *n*); both together they form a weakened area in the base of the cone which may be likened to a drum.

The columnar cells of the base of the cone now recede laterally and decrease in length, finally leaving this double chitinized drum alone to close the end of the duct (pl. 3, figs. 9 and 10). At the same time the glandular layer of the mucous gland breaks down as described heretofore, and these gland cells over the center of the chitinized drum also withdraw laterally. This leaves the chitin drum exposed to the lumen of the gland, but unperforated, in which condition it can be demonstrated at all stages investigated, provided methods are used in killing which do not distort the organs to such an extent that the drum is burst. This fact, together with evidence to be submitted, indicates that both sperms and mucus remain in the seminal vesicle and gland, respectively, not only until maturity, but even until copulation.

*B. Physiology*

1. *The secretions.* The content of the mucous gland is elaborated first in the distal end, and tends to collect there throughout the process of elaboration; the thinning of the glandular wall allows of considerable distention of this distal end to its characteristic bulbous shape, and nutriment is evidently absorbed actively by the organ, for it increases in size until the stage F (nine days). The secretion changes in character from fluid to viscous, and acquires increasingly the property of immediately coagulating to a tough, cheesy or doughy mass. This happens on contact with air, water, Ringer's solution, alcohol, lymph from the drone's abdomen, or any bland reagent in which an attempt was made to mix or dissolve it. It shrinks markedly in fixation and dehydration, and, especially when taken from an old drone or from the exposed organ removed from the female after copulation, it becomes so hard as to nick the microtome knife. It is slightly alkaline in reaction.

Spermatic fluid removed from the seminal vesicle consists of very little lymph-like fluid densely packed with sperms. This is so dense that it will barely drop from a needle. The sperms being attached to the vesicle wall, it takes an appreciable time for them to loosen when the vesicle is freshly torn under a microscope. Up to the stage E (five days) they have to be squeezed loose; in later stages the stimulus of breaking open the vesicle causes them to release themselves readily, until at stage G (twelve days) they pour forth from the slightest cut of the vesicle in a writhing mass. Up to stage D or E the sperms, except for a very gentle beating of the filaments, are inactive when released. From this stage until apparent maturity (nine to twelve days) their activity when released increases, as well as the readiness with which they are expressed from the vesicle. It is concluded that in the vesicle the sperms are at all times at rest or nearly so, for if the vesicle is abruptly torn under the microscope the sperms attached along the torn edge appear quiescent for a moment. Also the spermatic fluid remains in the seminal vesicle until the time of copulation, not as Shafer suggests partly in the

base of the gland, nor as Zander leads one to infer, in the bulb of the penis (this acting as a spermatophore). Inspection of the drone's abdomen, opened without fixing the organs, gives some appearance of support to these views, for then, due to disturbance in dissecting, the sperms are frequently found in the base of the gland or even in the penis bulb.

The spermatic fluid, in contrast to the mucus of the gland, mixes readily with any bland aqueous medium, salt, sugar, or lymph solution, but any dilution seems to decrease the activity of the sperms for a long time, though without necessarily killing them. Sperms on a slide under a cover-glass in salt solution were not killed by two hours' contact with ice, and fertile females have been frozen to  $-2^{\circ}\text{C}$ . for fifteen minutes without rendering subsequently laid eggs infertile.<sup>10</sup> The spermatic fluid and the glandular secretion are miscible in the penis before exposure to the air, and the sperms are intensely activated by the secretion of the gland. Particles of the vesicular wall stimulate them similarly. Whether this action is mechanical, as giving the heads of the sperms a firm hold for the exertions of their filaments (they collect around droplets of the secretion) or whether the action is chemical, as a stimulant, is not apparent. Contact with the mucus will not activate sperms that are too young to release themselves from the vesicular wall, and in the oviduct of the queen after copulation the sperms separate out of the mass of mucus and enter the seminal receptacle alone. The evidence seems to point, therefore, to the stimulus being a mechanical one, especially since sperms are activated by the mechanical act of being torn loose from the wall of the vesicle.

The seminal vesicle when filled with spermatic fluid assumes a distinct yellow color, as contrasted with the pure white of the mucous gland. This contrast of color is noticeable whenever the transparent organs of the drone or queen are filled with these secretions. For instance, in freshly dissected drones the yellow

<sup>10</sup> Dzierzon has stated that queens can be rendered infertile, and hence 'drone layers,' in this way; but though the statement is widely quoted, the writer has not found a single other recorded instance of its being done, experimentally or otherwise; he was unable to produce the expected result by any temperature, either prolonged or extreme, from the effects of which queens would recover.

spermatid fluid can be seen passing through the base of the gland and the lumen of the ejaculatory duct, and the contents of these organs can be distinguished by the color. When the two fluids are loosely mixed in the bulb of the penis, the areas of yellow and white can be distinguished, and if the drone is stimulated to complete extrusion of the organ, with ejaculation, a rough determination can be made by color as well as by consistency as to whether sperm or mucus has been emitted. When a queen has been newly fertilized, the penis attached in her organs can often be seen to be distended with clear white mucus, while the oviducts are distinctly yellow when dissected out. This is found to be due to the fact that after copulation the sperms collect in a layer next the wall of the oviduct and conceal a central core of mucus.

Sperms when densely crowded exhibit a tendency to lie parallel in masses, the filaments beating in unison, giving a characteristic undulatory appearance. This grouping approximates their arrangement when attached to the walls of the vesicle (pl. 2, fig. 5 b). Free on the slide, the masses of sperms arrange themselves in whorls or undulating bands; after copulation a cross-section of the oviduct of a queen shows a wavy band next the oviduct wall, and in the spermatheca of a fertile queen the sperms again arrange themselves in whorls, with the densely staining heads massed and the lighter staining filaments extending parallel. When diluted on a slide or mixed (in the oviduct) with mucus, or when, in a newly fertilized queen, only a few sperms have entered the spermatheca, the arrangement is scattering and indiscriminate.

As for functions consistent with these characteristic qualities and behavior of mucous and sperm, respectively, actual results of copulation afford the final data. To anticipate a forthcoming paper dealing with this subject in detail, the sperms are received into the spermatheca of the female before the mucus is disposed of, and the latter is dissolved gradually from the distended oviducts of the queen bee into which both sperm and mucus are injected at copulation. The penis with which the female returns from the mating flight is distended with mucus alone, which has so hardened on contact with the air as to effectually stop and seal off the torn end of the organ. Having followed

the sperm through the penis in ejaculation, the mucus has forced all the residual sperm out of the penis, so that whatever material is not injected into the female organs, and is thus to be lost when the penis is dropped, will not be the physiologically more valuable spermatic fluid.

2. *Correlation of age with functioning.* With the foregoing facts in mind, we may follow the differences in the response of the sexual mechanism, at different stages of development, to artificial or natural stimuli. In a young drone (up to four or five days) the chitinous blind end of the ejaculatory duct is still reenforced with layers of glandular and hypodermal cells; the walls of both mucous gland and seminal vesicle are stiffened with unresolved glandular epithelium; the sperms are either still in the testis tubules or are firmly attached to the vesicular wall, and are incapable of the activity which later characterizes them, and it is doubtful whether the valve which eventually occludes the gland's lumen is in the early life of the drone capable of doing so, for since the lining of the basal portion of the gland is the last to be resolved into secretion, this valve is still stiffened by a heavy glandular coat. The result of stimulating drones less than four or five days old is either no secretion at all when the organ is extruded or a secretion composed entirely or in large part of mucus, or if sperms are present, the glandular wall of the vesicle has pulled away with them, and the sperms are inert or vibrate their filaments but feebly.

After the fifth or sixth day the reaction is markedly different. The reinforcing cells over the end of the ejaculatory duct have withdrawn; the mucus is more viscous; the sperms release themselves more and more readily from the vesicle and are extremely active; the glandular walls of the organs are thin and pliable, and the sperm content of the vesicle is discharged through the ejaculatory duct ahead of the mucous content of the accessory gland. The whole reaction of the drone is also more violent and spasmodic. These conditions, while virtually established, as stated, at five or six days of age, seem to become accentuated up to the age of nine or ten days, although the morphological and histological changes after the sixth day are slight and although

the variation in the physiological reactions concerned makes it difficult to measure accurately the degree of the response.<sup>11</sup> The following table will summarize the data correlating age of the drone with the histological and physiological findings.

3. *Manipulation of drones.* If a drone's abdomen is pinched sharply between thumb and forefinger, the pressure will generally cause partial or complete extrusion of the copulatory organ. The penis tube may evert throughout its length, as described heretofore, everting the two lateral chitinized plates that enclose its bulb, and also drawing the ejaculatory duct through the everted bulb (text fig. 2, *C*); in this case whatever fluid is expressed forms a drop at the end of the penis. Extrusion may stop, however, before this bulb has turned inside out (text fig. 2, *B*). The fluid will then remain for the most part in the bulb of the penis (*b*) and in the elastic and expanded end of the adjoining ejaculatory duct (*c*). There may be little or no spermatid fluid expressed, or the fluid may consist entirely of mucus, or it may consist of both mucus and sperm, rarely of sperm alone.

Selecting drones all of which were known to be old enough to function in normal copulation, experiments were undertaken to find what controlled the normal protrusion of the organ and the normal ejaculation of the secretions.

It was found almost impossible at first to dissect these drones without disturbance of the sexual apparatus. Drones held in the hand, without mechanical pressure being applied by the fingers, will often extrude the penis with a sort of explosive contraction of the abdomen. Even when extrusion does not occur, the mucous glands of dissected mature drones will generally be found to have burst at the expanded distal end, or else sperm and mucus will have been forced into the base of the gland, ejaculatory duct, or penis. If the drone's head is amputated a disturbance invariably occurs; frequently this goes as far as

<sup>11</sup> Whether functional maturity and ability to effectually inseminate queens is attained at the time of apparent histological and physiological maturity of the organs and secretions described, is a matter which only mating experiments can determine. Mr. F. W. L. Sladen, apiarist of the Canadian Department of Agriculture, informs me that queens mated to drones under two weeks of age produced a large percentage of infertile eggs. (See his forthcoming report for data.)

complete extrusion of the penis with ejaculation of spermatic fluid. Removing the abdomen from the thorax before dissecting lessens the effect; reducing the temperature also renders old drones less irritable (but young ones, three days old, more so). Slow injection of all fixatives containing acid causes contraction of gland and vesicle, with bursting of the gland or extrusion of contents through the ejaculatory duct.

More satisfactory results with Bouin's fluid finally led to the use of picric acid for killing, and the best results were obtained by injecting cold saturated aqueous picric acid solution through a fine-drawn pipette into the side of the thorax just beneath the wing, forcing the fluid in very slowly until the abdomen became slightly distended. This seemed to be effective partly through inhibiting the stimulation of the sex organs by the ganglia in the thorax, since indications of stimulation by these ganglia were observed before the irritant that was being injected could have reached the abdomen. Chloroform, ether, and cyanide were not satisfactory as anaesthetics to prevent distortion.

By rapidly opening a freshly cut-off abdomen under the low power of a binocular, the parts may occasionally be exposed quickly enough to allow of observation of the activity of the organs. The abdominal pressure that might force the penis to extrude is in this case eliminated by opening the abdomen, so that muscular contraction of the walls of gland and vesicle is the effective agent of the activity that follows. The typical observation under these conditions is twofold. First, a peculiar twitching contraction of the base of the mucous gland tends to straighten out the angle or elbow of this gland (pl. 1, fig. E), and often, by forcing the contents toward the distal end, bursts this through and releases the mucus in the abdominal cavity. Second the yellow spermatic fluid can be seen passing through the transparent vas deferens, base of the mucous gland, and down the ejaculatory duct to the penis. Mucus and sperm are thus separated, and microscopical examination of the organs killed immediately in this condition (pl. 3, fig. 10) shows that in the base of the gland the mouth of the vas deferens has been forced against the blind end of the ejaculatory duct. Generally the

*Correlation between the age of drone and the stage of development and the functioning of the organs of sex*

STAGE	AGE	SPERMATOGENESIS	SEMINAL VESICLE	ACCESSORY GLAND	EJACULATORY DUCT	RESPONSE TO STIMULI CAUSING EXTRUSION OF PENIS
A	4 days before emerging. Eyes lightly pigmented	Testes 5 mm. fill abdomen. Last stages spermatogenesis. First spermiogenesis	Secretion commences in vas deferens. Cells of ves. granular	Very little secretion distally. Length, 2½-3 mm.	Branch has penetrated gland, chitin thin and colorless	
		2 days before emergence. Eyes dark, body chitin low yellow	Spermiogenesis, sperms descend to upper part of seminal ves.	Distal cells stratigulate, secretion granular. Length, 3 mm.	Blind end of duct thickens, two chitin layers separate	No appreciable secretions. Penis will not extrude on stimulating until just before emergence
C	Drone emerges	Spermiogenesis finished. Sperms half way down seminal vesicle. Attach to walls	Most of surface ridged, deeper at upper end. Granules of secretion dissolve	Cells of distal half active. Length, 3½ mm.	Cells of end of duct begin to withdraw laterally. Chitin thickens	Drone will respond to strong stimuli by extrusion of organ, but usually only part way, and without ejaculation of secretion
		3 days old	Vesicle full. Some sperms still free, most attached. Testis, 3 mm.	Distally wall is very thin, and gland cells resolved completely there. Bulbous contour. Length, 4½ mm.	End of duct exposed to glandular epithelium of gland	Drone responds more readily than at stage C, but with no secretion, or with the ejaculation of mucus alone. Organ may be fully extruded if stimulus is violent and drone warm
D						



E	5 days old	Few free sperms. Testis turning greenish in color, 2 mm.	Glandular wall thin and deeply ribbed. Vesicle full sized	Basal region receding. Cells over ejac. duct recede. Apparent functional maturity. Length, 5-5½ mm.	Apparently mature	Organ may be caused to extrude with ejaculation of mucus and sperms. Latter are often not very active
F	9 days old	Same condition. Green tint more pronounced	Seminal vesicle, no change. Cells of vas deferens to gland vacuolated, lumen opened wider	Still slight secretion. No change in size	No change	Organ extruded more readily with characteristic explosive violence, and with ejaculation of sperms first, followed by mucus. Sperm active
G	12 days old	Testis 1½ mm. Same condition as above	No change	No change distinguishable	No change	Apparatus apparently mature after ninth day, though reaction seems to be more violent and more easily produced up to the 12th day. After that no change was detectable with methods used
H	21 days old	No change	No change	No change	No change	

chitinous drum will have been burst through; the valve guarding the entrance of the vas deferens will be pressed against the opposite side of the gland's lumen so as to occlude the latter, and the mucous content will often have burst through the anterior end of the gland's wall. If the organs are not killed at once, the musculature relaxes, and the gland assumes a somewhat more normal contour.

When the drone is opened more deliberately, especially after the injection of an acidified fixative or after stimuli that cause partial extrusion of the penis, the picture is different. The spermatic fluid will have passed down as before through the base of the gland and ejaculatory duct into the bulb of the penis (text figs. 1, *b*, and 2, *A* or *B*, *b*), but the mucous content of the gland will in this case have followed it down. The two are still unmixed. The sperm is invariably collected at the lower end, as if it had come down first, and the mucus lies behind it. From this it is concluded that after the first spasmodic contraction of the gland and vesicle that expresses the spermatic fluid through the gland's base, and shuts off the outlet of the mucus through the same channel, the muscles then relax enough to open the lumen again, and the mucus follows the sperm into the penis. The bursting of the end of the gland is in this case prevented by the increased and compensating pressure of the abdominal contraction, since the muscles of the abdomen contract in coordination with the sexual apparatus.

Very rarely, by careful opening of the drone, the gland does not burst upon contraction, and after relaxation its mucous content can be seen to follow the sperm down as has been inferred to be the normal manner.

With this manner of action in mind, various methods of stimulating the drones were tried, to find by what method could be brought about the most complete ejaculation of both mucus and sperm, together with complete extrusion of the penis, in the order above stated. The following treatments tested on mature drones are set down in order of increasing effectiveness in producing the desired effect.

1. Bouin's fluid, cold, or picric acid solution injected through the thorax caused no disturbance of the organs with careful handling. Cooling in general reduced irritability.

2. Slow pressure on the sides of the abdomen, especially if the drone was cold, often caused bursting of the abdomen between the sclerites, sometimes extrusion of the penis without ejaculation of fluid.

3. Allowing the drones to fly toward a bright window or artificial light and warming them to 40°C. often made pressure on the abdomen effective in causing ejaculation, but not always was the ejaculation complete.

4. Weak acid or fixative containing acid injected into the thorax, and especially into the abdomen, caused very violent contraction of the organs, but often killed the tissues without complete ejaculation of the fluids. Injection of these acidified reagents into the abdomen through the thorax caused ejaculation most frequently.

5. Sudden and slight pressure applied with the fingers to the sides of the abdomen of a warm excited drone generally caused a violent extrusion of the penis with complete ejaculation of both sperm and mucus. This was accompanied by an intense contraction of the muscles of the abdomen. This reaction of the drone was in close conformity with the result to be expected from anatomical considerations. The pressure is to be interpreted distinctly as a stimulus, and need by no means be sufficiently great to forcibly express the penis without a very pronounced reaction from the drone itself.

6. The most complete and most uniform results were obtained by holding a drone by the head, allowing him to use his wings as in flight until he was intensely excited, and the abdomen became distended as in rapid flight; the head was then deliberately pulled from the thorax. The drone reacted with what is believed to be substantially a normal orgasm as far as concerns the state of the organs of sex. It is inferred that the violent stimulus of decapitation under these conditions in some way duplicated the stimulus of sexual excitement, as far as the sexual mechanism is concerned.

Under this treatment, the penis everts throughout its whole length, including the bulb at its end (text fig. 2, *C*); the expanded end of the ejaculatory duct is brought through the bulb to form a cup-shaped disk at the extremity of the penis (fig. 2, *C, c'*), and from the central perforation of this cup (the ejaculatory duct) proceeds first a drop of yellow sperm, then a white mass of viscous mucus. The emptied and distorted sexual organs (mucous glands and seminal vesicles) are often forced into the base of the extruded penis by the violent contraction of the abdominal walls (text fig. 2, *C, d*). The drone is paralyzed or stunned, but sometimes recovers enough to crawl about feebly, and may live for several hours.

#### CONCLUSION

It may be seen, therefore, that several lines of evidence point consistently to one specific manner of functioning of the sexual mechanism of the drone. First, the anatomical arrangement of the parts is such that the seminal vesicle is in more direct communication with the ejaculatory duct than is the mucous gland, and this connection is of such a nature as to suggest definitely a separate discharge, and therefore a distinctive separation of function, for sperm and mucus (p. 239 and pl. 1, *E*). Second, the arrangement of the musculature is such that its contraction brings about exactly that arrangement of ducts and apertures which will discharge first sperm, and then mucus, into and through the basal pocket of the gland and thence into the ejaculatory duct and penis (p. 243 text fig. 3, and pl. 3, fig. 10). Third, the physiological behavior of sperm and mucus is so characteristically different as to suggest a difference of function and disposal (pp. 246 to 247). Fourth, by actual observation, a disposal of sperm and mucus, entirely consistent with the anatomical and physiological findings, is induced by stimuli that may be considered closely to simulate, or even actually to duplicate, those stimuli that cause the normal reactions of the sexual organs. Under suitable conditions, the action of these organs, and the passage of the secretions through them in the expected order, may be observed under the microscope (p. 250). Finally,

as will be shown in a subsequent paper, these secretions dispose themselves in the organs of the female at the time of copulation, and are disposed of by the female's reproductive mechanism after copulation, in a manner not only entirely consistent with the interpretation given above, but in an order that seems to preclude any interpretation which deviates materially from one herein set forth (p. 248).

#### SUMMARY

1. The drone is not sexually mature at the time of emergence of the imago, but undergoes a further growth period of at least nine to twelve days. The progress of this development is described in this paper for the sexual organs.

2. The sperm and the mucous of the accessory gland change both in character and in behavior as the process of development goes on, as does also the mode of functioning of the organs which elaborate and contain them.

3. Sperm and mucus each remain in their respective receptacles until copulation, and do not mingle before that time.

4. The partition closing these organs off from the ejaculatory duct, consisting of the chitinous lining of the blind end of that duct, does not break through until copulation. Then the secretions burst through it as they are forced out of their receptacles by contraction of the muscular walls of these organs.

5. The musculature of the whole base of the gland is so arranged as to cause, on violent contraction, the shutting off of the distal portion of the gland from the proximal by a muscular valve. The mucous content is thus closed off from its outlet through the ejaculatory duct; at the same time sperm is allowed to pass through the vas deferens and basal portion of the gland into the ejaculatory duct. This spermatic fluid is thus the first to be ejaculated.

6. The mucous content of the gland, upon relaxation of the muscles of the base of the gland, is then free to pass after the sperm, and forces all the sperm out of the organs. It also apparently forms a plug by coagulating on exposure to the air (e.g., when the penis is torn from the drone at the time of copulation).

7. The bulb and elastic end of the ejaculatory duct do not act as a spermatophore, although after copulation, and while still attached to the queen, they may serve to hold what mucus may not have been fully expressed into the oviducts.

8. The drone's organs may be inspected in an undistorted state only by the most careful manipulation, as they are easily stimulated to contraction and expulsion of their contents. This contraction may be watched in a freshly opened drone. It is inhibited by injection of picric-acid solution into the thorax and thence into the abdomen. It is stimulated by injection of acids or of fixatives containing acids. The use of acidulated fixatives may be responsible for erroneous views that have been put forward as to the normal quiescent condition of these organs.

9. A response apparently duplicating the results of the normal act of copulation may be produced with considerable certainty by various means, as enumerated.

PLATES

## PLATE 1

### EXPLANATION OF FIGURES

C, D, E, and H Stages of development of the sexual organs of the drone (table in text, p. 252). Camera-lucida drawings of whole mounts, to show, in optical section, changes in size and conformation of the sex organs from emergence of the imago until sexual maturity.  $\times 18$ .

Black shading, muscular envelope; lines and dots, glandular epithelium; broken lines, spermatozoa; dots, mucous secretion; cross-hatching, hypodermis of ejaculatory duct; lines, chitinous lining of same. *c*, ejaculatory duct; *d*, body of gland; *e*, seminal vesicle; *f*, vas deferens from testis; *h*, vas deferens leading from vesicle to gland; *i*, basal region of gland; *j*, cone-shaped end of ejaculatory duct, applied to *i*; *k*, slender muscle attaching gland to posterior abdominal wall; *l*, muscular valve guarding vas deferens orifice, and partially separating *d* from *i*; *m*, region of lumen of gland extending out into elbow of gland; *n*, chitinous drum over end of ejaculatory duct.

Legend on figure D applies alike to all. Numbered lines on C and E locate cross-section drawings of subsequent figures (q.v.).

C Drone at time of emergence. Secretion has just commenced in distal portions of gland and vesicle.

D Drone three days old. The bulbous expansion of distal portion of gland as a mucous reservoir is noticeable, and the spiral serration of the vesicular wall has extended throughout the organ.

E Drone five days old. Organs almost mature. Sperm attached to walls of vesicle, wall of gland largely resolved into mucus, chitinous end of ejaculatory duct attenuated.

The fixative has stimulated the basal musculature of the gland to slight contraction, without, however, discharging the content of either gland or vesicle. The transverse pocket, *i*, into which open vas deferens, *h*, and ejaculatory duct, *j*, is closed off from the distal reservoir of secretion, *d*, by the valve, *l*, and the ends of the vas deferens and ejaculatory duct are brought almost into apposition (compare pl. 3, fig. 10).

H Drone twenty-one days old, basal portion of gland and seminal vesicle. Later stages than five days show but slight further modification. The basal portion of the gland here is not distorted, as in E, but shows normal resting relationships of the parts. Even at this age the contents of the organs have not been discharged into the bulb of the copulatory organ.

1 to 4 Successive cross-sections of accessory mucous gland and seminal vesicle of drone at stage A, four days before emergence.  $\times 24$ . Located on figure C, by lines numbered 1 to 4, respectively. Legend same as for figure D, with addition of *X*, *Y*, *Z*, regions of three inner muscle tracts.

1 Section through branched end of ejaculatory duct, and the basal portions of the two mucous glands.

2 Section through gland just above entrance of the vas deferens. Between the area representing the section of the distal portion of the gland's lumen, *m*, and that representing the basal portion, *i*, the black band, *l*, represents the edge of the muscular valve which, on contraction of the basal musculature of the gland, closes off the basal portion from the distal mucous reservoir (figs. C and E).

3 Section at middle of gland. Between *X* and *Y*, *Y* and *Z*, and *Z* and *X*, may be seen in cross-section the three channels into which the gland's lumen is modeled by the three muscle tracts, *X*, *Y*, and *Z*.

4 Section of the gland just anterior to the end of the seminal vesicle, through the region of the testis in the abdomen.



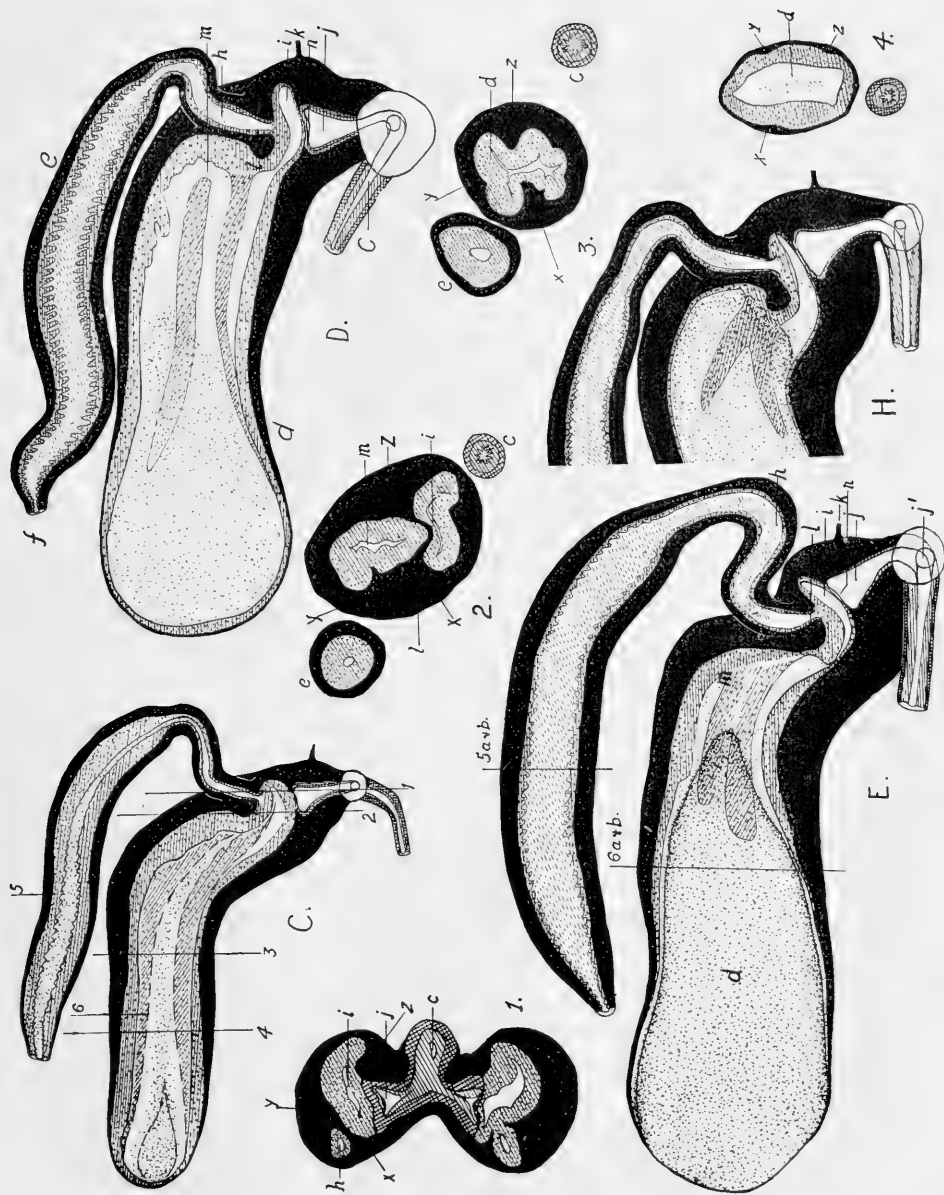

## PLATE 2

### EXPLANATION OF FIGURES

Camera-lucida drawings of cross-sections of gland and vesicle, located by lines numbered 5 and 6 on figure C, and 5a and 6a on figure E, plate 1. All 10 $\mu$  thick.

5 Cross-section of seminal vesicle, stage C  $\times$  135. *e*, loose membranous connective-tissue envelope of vesicle; *l.m.*, longitudinal muscle layer; *c.m.*, circular muscle layer; *g*, globules of secretion from the glandular cells, not yet resolved to a homogeneous fluid; *a*, *b*, *c*, *d*, sections of the four successive spiral ridges into which the wall of the vesicle is sculptured by uneven erosion of the glandular lining.

5a Enlarged view of epithelial cells of same. Cross-section of portion of seminal vesicle, glandular epithelium, stage A.  $\times$  340. Secretion has not commenced, but the granular band across the ends of the cells and the denser areas around the nuclei indicate the inception of the process.

5b Cross-section of wall of seminal vesicle, glandular epithelium, stage E.  $\times$  340. Sperms arranged radially, heads attached to cells of the epithelium. Centrally a narrow lumen contains loose sperms in bundles just descended from the testis. The granular secretion of figure 5 has here resolved to a clear plasma, densely packed with sperms.

6a Cross-section of glandular epithelium of gland, stage A, before secretion has commenced.  $\times$  340.

6b Same as above, stage E, late stage of secretion.  $\times$  340. A mass of secretion, *s*, lies in the gland's lumen, globules of secretion, *a*, are strangulating off from the distal ends of the cells, which thereby decrease in length, cells heavily vacuolated at *v*.

FERTILIZATION IN THE HONEY-BEE  
 GEO. H. BISHOP

PLATE 2



5a.

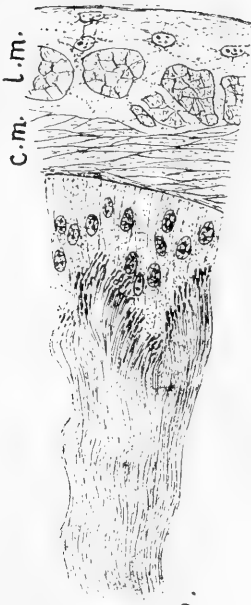

5b.

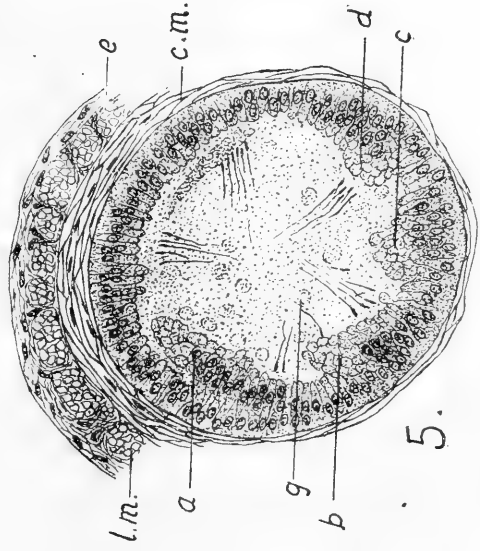

5.

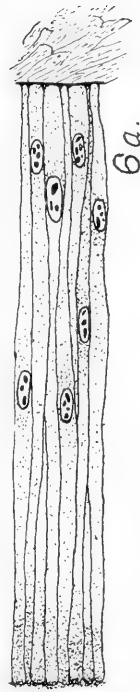

6a.

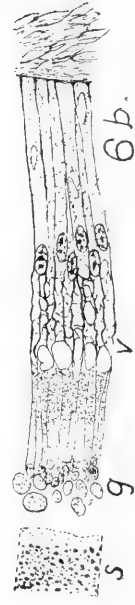

6b.

## PLATE 3

### EXPLANATION OF FIGURES

7 Diagrammatic cross-section through end of ejaculatory duct and base of gland. Stage C.  $\times 37$ . Black, muscle; lines and dots, glandular epithelium; cross hatching, epithelium of ejaculatory duct; lines, chitinous lining of same. *h*, vas deferens; *j*, end of ejaculatory duct; *c*, section of middle portion of ejaculatory duct passing anteriorly along the gland; *i*, basal pocket of gland; *l*, valve partially dividing this from the distal portion *m*. (Compare text fig. 1.)

8 *a-g*. Serial sections of base of gland, to show the formation of the double chitinous partition over the end of the ejaculatory duct. Stage B.  $\times 37$ . 10 $\mu$ . Lettering as on figure 7. Dotted lines in *a* show area included in *b-f*. Figure *g* is that of a section through center of the end of the duct.

9. Higher magnification of the condition shown in figure 8*g*, but at later stage of development, C.  $\times 180$ . 8 $\mu$ . Lettering as on figure 7.

10 Section through lower part of vas deferens and base of gland, at a slight angle from the sagittal plane. Stage H.  $\times 37$ . 10 $\mu$ . Lettering as on figure 7.

The organ here figured, from a drone twenty-one days old, has contracted because of the injection of the fixative, so as to bring the vas deferens orifice and the end of the ejaculatory duct in apposition (at *n*), and force the valve *l*, against the opposite side of the gland's lumen, dividing this (*d*) from the basal pocket, *i*. The distal end of the gland (not figured) has burst, releasing the mucus into the abdomen. The seminal vesicle has not contracted, so that the drum of chitin, *n*, over the end of the ejaculatory duct, *j*, is left intact.

This condition of the basal portion of the gland therefore apparently duplicates the condition, during copulation, momentarily obtaining before ejaculation takes place. Spermatic fluid alone could enter the ejaculatory duct from the vas deferens, the mucus being retained in the distal reservoir of the gland by the closing off of the basal region of the gland.

An idea of the complexity of the musculature of the gland's base may be obtained from the figure, though the angle at which the section has been cut makes it difficult to trace the several layers distinctly.

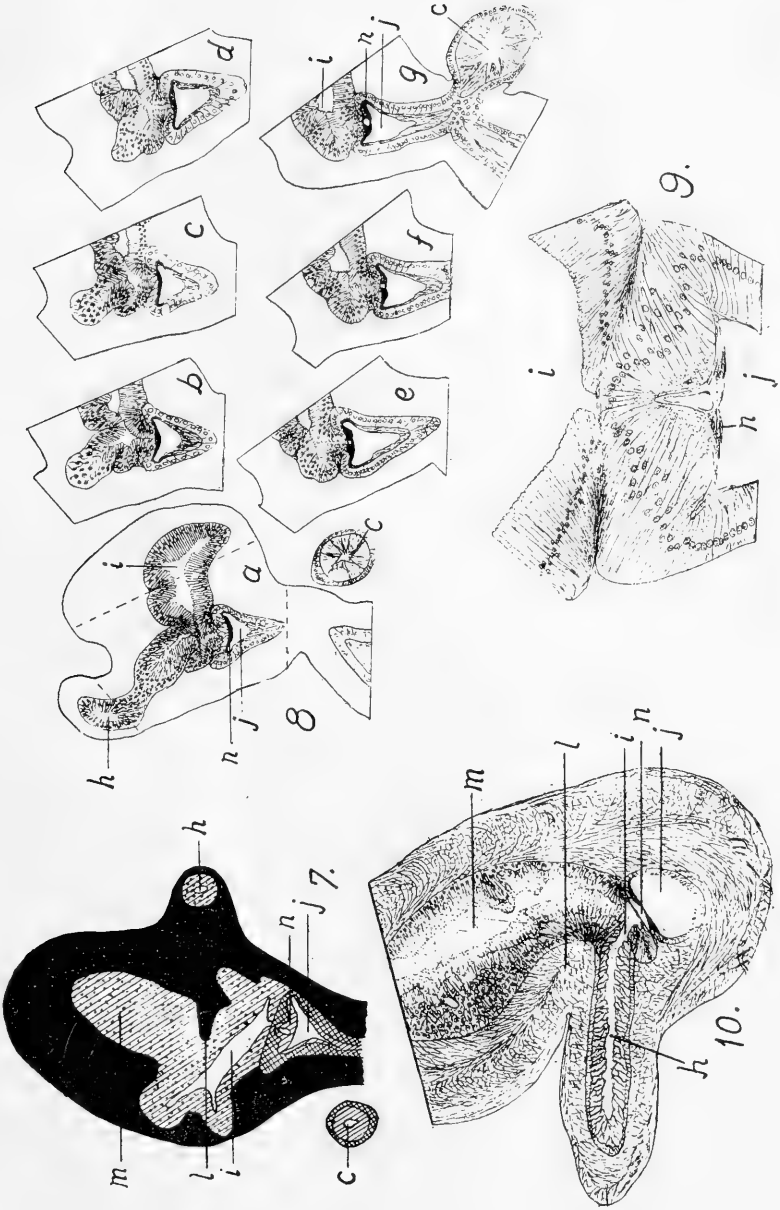

Resumen por el autor, George H. Bishop.  
Universidad de Wisconsin.

## La fecundación en la abeja.

### II. El uso de los fluidos sexuales en los órganos de la hembra.

El proceso copulatorio de la abeja tiene lugar al aire libre y su naturaleza debe inferirse, por consiguiente, del exámen de los insectos antes y después del apareamiento. La configuración del tracto vaginal en la reina es tal que el pene del zángano solo puede penetrar ligeramente en el orificio, quedando el bulbo del pene, de gran tamaño, en el vestibulo génito-anal, en posición caudal a la de la vagina propiamente dicha. Las "pneumopófisis" del órgano del zángano sirven aparentemente no como órganos de retención, sino para abrir el orificio vaginal para la inserción del pene, inflando los divertículos de la bolsa a cada lado de la vagina. Los espermatozoides entran primero en los órganos y llenan los oviductos pares, penetrando después el mucus, mas viscoso, para formar un núcleo central, llenando la vagina caudalmente donde se endurece para formar un tapón vaginal cerca del orificio. El órgano del zángano puede desprenderse de la vagina de la reina al cabo de unas dos horas. Los espermatozoides y el mucus se mezclan solo parcialmente, tendiendo a separarse los primeros hacia las paredes de los oviductos y a pasar caudalmente, aparentemente por quimiotaxis, al conducto de la espermateca que se abre en la vagina. El mucus se absorbe por los oviductos mas lentamente. La mayor parte de los espermatozoides han entrado en la espermateca al cabo de unas seis horas después de la cópula, mientras que parte del mucus puede permanecer en los oviductos durante dieciocho horas. Los espermatozoides y el mucus se disponen de este modo separadamente en los órganos de la reina, de un modo ya anticipado por el examen de la estructura y funcionamiento de los órganos del zángano (descritos en un trabajo anterior).

## FERTILIZATION IN THE HONEY-BEE

### II. DISPOSAL OF THE SEXUAL FLUIDS IN THE ORGANS OF THE FEMALE

G. H. BISHOP

*Zoological Laboratories of the University of Wisconsin*

TWO TEXT FIGURES

#### CONTENTS

Introduction.....	267
Historical.....	268
Anatomy of sexual apparatus.....	269
Description of fertilized queens.....	278
Summary and conclusions.....	282

#### INTRODUCTORY

In the paper preceding this (Fertilization in the Honey-bee, I) has been described the sexual mechanism of the drone bee and its physiological functioning in copulation. As a check to this work, a series of dissections and microscopic examinations has been made of queen bees which had flown from the hive and been mated under entirely normal conditions. Eight virgin females were watched and their time of mating recorded, and were subsequently examined to determine the behavior and the disposal of the sexual secretions of the drone in and after copulation.

These queens were killed for examination at specific intervals of time after their mating, and examined either fresh or after preparation for histological study, as conditions appeared to render desirable. The time data were obtained in the following manner. The virgins were introduced into strong nuclei of young bees, and these nuclei were inspected every half-hour during the warm bright part of the day, beginning in each case when the virgins were four days old. The bees showed little effects of handling, and the fact that queens were mated from

such nuclei repeatedly, promptly at the normal age, and at the usual time of day for mating flights (11 A.M. to 2 or 3 P.M.) indicates that for the purposes of the experiment such frequent handling did not interfere materially with the results. At each inspection the queen was actually located by observation or else searched for at fifteen-minute intervals until found or until satisfactorily demonstrated to be lost. In this way a queen found with the drone's organ attached was known to have returned from a mating flight within the past half-hour if she had been observed at the last regular inspection, or within forty-five minutes if she had been missing then, etc. The small number of queens available makes too precise an interpretation of the resultant data inadvisable, but the general agreement of the results from the respective queens allows of certain reliable and definite conclusions.

The queens were treated as follows:

Two queens, A and B, killed immediately on return to hive; one was dissected fresh and one preserved for histological study.

Two queens, C and D, killed one to one and a half hours after mating, one dissected fresh and one preserved for histological examination.

One queen, E, killed two to two and a half hours after mating. Dissected.

One queen, F, killed four to four and a half hours after mating. Preserved for histological examination.

One queen, G, killed six to six and a half hours after mating. Dissected at once.

One queen, H, killed eighteen hours after mating. Preserved for histological examination.

#### HISTORICAL

There has been little reported in the literature on actual results of fertilization of the queen bee. The work of Bresslau,<sup>1</sup> checked by Zander,<sup>2</sup> appears satisfactory as an anatomical

<sup>1</sup>Bresslau. Die Samenblasengang der Bienenkönigin. Zool. Anzeiger, Bd. 29, 1905.

<sup>2</sup>Zander. Die Ausbildung des Geschlechts bei der Honigbiene. Zeit. der angewandte Entomologie, Bd. 3, 1916.



picture of the mechanism by which the queen fertilizes the egg. The fact has been noted elsewhere, however,<sup>3</sup> that this anatomical study of the queen's organs does not elucidate by what manner the sperms get into the spermatheca of the queen after fertilization. There is no explanation recorded of the reception of the spermatic fluid into the female organs, except a remark by Shafer,<sup>4</sup> that the queen's vagina, and 'in one queen' (of four available for study), the oviducts were distended with fluid after copulation. No other statement bearing directly on this subject has been found.

#### ANATOMY OF THE FEMALE SEXUAL APPARATUS

Before passing to the consideration of these fertilized queens, the configuration of the female genital tract merits consideration.

In figure 1, A, is shown diagrammatically the dorsal aspect of the sexual organs of the virgin queen. This is the view which shows most of the gross anatomy and the one conventionally presented. This aspect, however, demonstrates most inadequately several structural details and relationships which are significant in fertilization. Figure 1, B, is a diagram of the sexual apparatus in profile, showing particularly the configuration of the lumen of the tract. This is partially figured (in the region of the 'sperm pump' leading to the spermatheca) in Bresslau's work on the seminal receptacle and sperm pump<sup>1</sup> but the significance of the more general relationships is not there brought out.

The queen and drone, in copulation, meet face to face while in rapid flight. The drone's copulatory organ (fig. 2, A), by an explosive contraction of the abdominal muscles, is everted from the body of the drone (fig. 2, B or C) into the copulatory bursa of the queen, and there it lodges. The queen twists off the drone's organ and returns to the hive with the end of it attached in the vagina.

The complex morphology of the penis is usually interpreted as facilitating this penetration of the drone's organ as it everts

<sup>3</sup> Snodgrass. Anatomy of the honey-bee. U. S. Dept. of Agr. Bur. Entomol. Tech., Series 18.

<sup>4</sup> Shafer. A study of the factors which govern mating in the honey-bee. Mich. Agr. Col. Exp. Sta. Tech., Bul. 34, 1917.

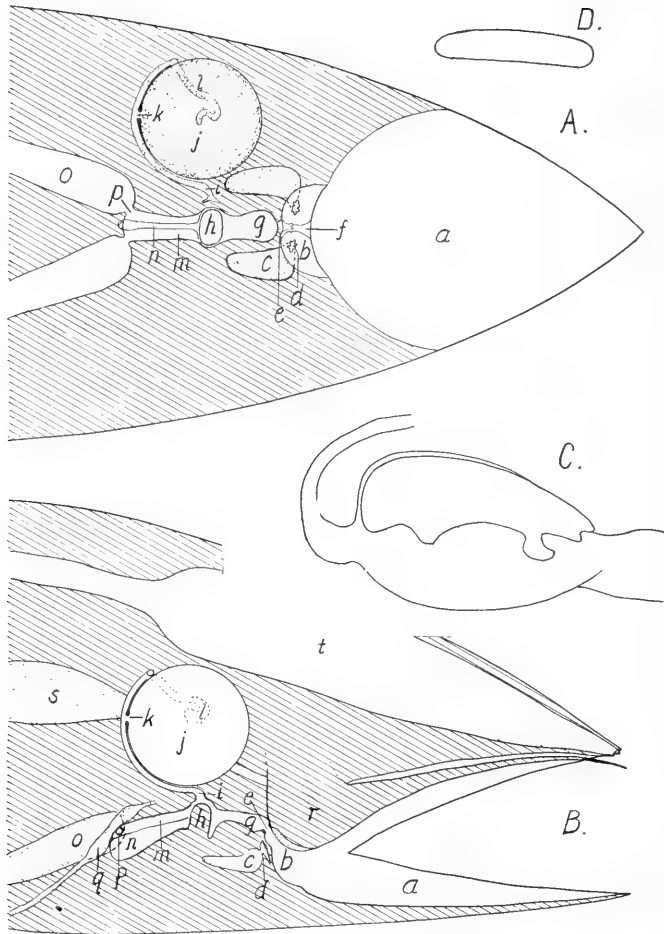

Fig. 1 Dorsal (A) and lateral (B) views of female genital tract of bee, with part of male organ (C) drawn to the same scale. *a*, ventral floor of genito-anal vestibule; *b*, bursa copulatrix; *c*, bursal pouch; *d*, aperture of pouch; *e*, vaginal tongue; *f*, medial ridge of ventral floor of bursa; *g*, posterior region of vagina; *h*, tongue-like organ situated in medial region of vagina; *i*, duct to spermatheca, or 'sperm pump'; *j*, spermatheca; *k*, its opening from the sperm duct; *l*, glandular continuation of sperm duct; *m*, posterior region of vagina; *n*, fossa in floor of same; *o*, oviduct; *p*, aperture from oviduct to vagina; *q*, ganglion straddling end of vagina; *r*, base of sting; *s*, poison sac of sting; *t*, rectum. All drawings free-hand, but drawn proportional to measurements of camera-lucida projections of cross-sections, longitudinal sections, and whole mounts of the organs represented.

A. Dorsal aspect, diagrammatical optical section of female genital tract. The spermatheca is shown rolled over to one side of its normal position immediately dorsal to the anterior portion of the vagina, and therefore presents a lateral view. Drawn as if everything dorsal to the genital tract were dissected away, and the lumen of this laid open.

B. Lateral aspect, profile of genital tract, drawn as above.

C. Uneverted bulb of penis and adjoining regions. Comparison of the size of this organ with the dimensions of the female genital tract casts some doubt upon the assumption that this organ everts into the vaginal tract, *g*. The only part comparable in size to this region is the extreme tip of the everted organ (fig. 2, C, *c'*), formed by the eversion of the ejaculatory duct beyond the penis bulb; while the bulb itself would scarcely be completely contained in the much larger bursa.

D. Egg drawn to same scale as genital tract.

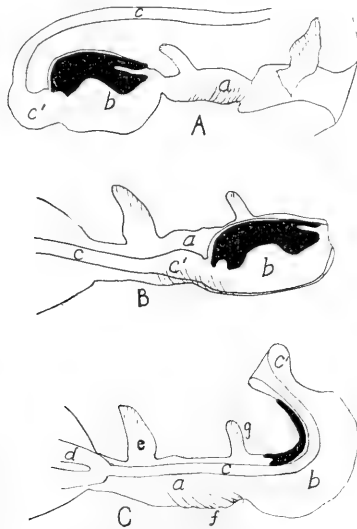

Fig. 2 Diagrams of drone's organs, showing uneverted, partially everted and completely everted relationships of the various portions, in A, B, and C respectively. *a*, posterior or proximal tubular portion of the penis with modifications for facilitating copulation, *e*, *f*, *g*; *b*, bulb portion of the penis with lateral chitinous plates shown in black; *c'*, proximal end of ejaculatory duct *c*, expanded where it joins the bulb of the penis; *d*, the mucous glands. For further explanations see text.

into the vagina of the queen, and its retention within it when everted. Certain conformations of the penis have been described with considerable ingenuity and in great detail as 'fitting,' or formed so as to lodge in, corresponding regions of the bursa or vagina, as the eversion of the copulatory organ proceeded. The impossibility of observing copulation, which takes place high in the air, makes such inferences the best evidence available as to the manner of coitus.

While the detailed description of this correspondence between the anatomy of queen and drone is irrelevant to the object of this paper, and has been described by other writers, a brief analysis of the process of coition is necessary to the interpretation of some of the data. Two points discussed in recent literature seem to have been inadequately treated. The functioning of the pneumophyses (fig. 2, C, *e*) has not been satisfactorily analyzed, and the extent of the eversion of the copulatory organ—whether this takes place up to the bulb of the penis (fig. 2, B) or whether the bulb also everts (fig. 2, C)—is open to question; as is also the distance to which it enters the vagina of the queen.

In figure 1, C, is drawn, uneverted, the bulb of the penis of the drone to the same scale as that of the queen's organs in figure 1, B, and from the same lateral aspect. It may be observed (fig. 2) that as the penis extrudes from the male genital aperture the first portion to evert, after the short proximal tubular section, will be the pneumophyses (*e*). If queen and drone are in position for coitus (tip of drone's abdomen inserted between the anal plates of the female) these pneumophyses presumably evert into the paired bursal pouches opening from the copulatory bursa by slits on either side of and below the vaginal orifice (fig. 1, A and B, *b*). The hypothesis is hardly tenable, however, though it has been presented, that their function is to hold the organ momentarily in the queen's bursa while further eversion of the organ takes place. In the first place, their eversion coincides with a violent contortion of the drone's abdomen (when protrusion of the organ is artificially induced, and presumably in the natural act), which would render any holding function for such soft and pliant organs not only relatively insignificant, but

superfluous. In the second place, their size is so great that their complete expansion into the pockets designed to receive them would force the insects apart rather than hold them together. Thirdly, the next section of the penis which shows definite adaptation for resisting withdrawal (fig. 2, C, *a, f, g*) is so far from the pneumophyses that these will be forced back from the bursal pouches before the other section everts. Upon careful inspection of the queen's anatomy, especially of the profile of the genital tract, another function for these pneumophyses becomes apparent, namely, to open the orifice of the vagina at copulation, as described hereafter.

The female genital tract has not been adequately described. Regions in the genital tract may be distinguished as follows (fig. 1, A and B): 1) a genito-anal vestibule (*a*), the space between dorsal and ventral genito-anal plates, enclosing the shaft of the sting and receiving the outlet of the rectum, or anus; 2) the copulatory bursa (*b*), lying ventral and anterior to the base of the sting and extending forward on either side into the bursal pouches (*c*), and which is divided from the vestibule by a slight ridge in the floor of the tract (*f*), and 3) the vagina proper, or unpaired oviduct, of which three regions may be distinguished, the posterior (*g*), flattened dorsoventrally and lying just anterior to the base of the sting, divided off from the bursa by a very definite constriction (*e*); medially, a slight enlargement of the lumen enclosing a tongue-like organ (*h*), and opening dorsally into the duct to the spermatheca (*i*), and anteriorly, a region with a T-shaped cross-section (*n, m*), into which open on either side the oviducts (*o*).

The configuration of this tract will be described in more detail. Reference to the figure (fig. 1, A and B) will demonstrate the relation of the copulatory bursa to the base of the sting. The floor of the genito-anal space (*a*) is formed by a heavily chitinized membrane attached at the lateral margins to the ventral terminal sclerite, the anterior margin being free from this sclerite and separated from it by a space. From this margin, which is curved convexly to the anterior, extends a thinner and less heavily chitinized membrane, to form the ventral wall of the bursa.

From the line of division of these two areas, marking the outer limits of the bursa proper, the ventral wall of the bursa, in the closed condition of the parts, envelops closely and lies in contact with the base of the sting (*r*); posterior to this line the tract opens out into a considerable cavity, enclosing the shaft of the sting and the tip of the rectum. The base of the sting fitting the bursa is slightly bilobed; that is, its two halves are separated by a flattened furrow, which runs up around the anterior surface of the sting's base, and forms the posterior and dorsal wall of the bursa. The anterior and ventral wall of the bursa (the membrane above mentioned) is correspondingly sculptured into two cup-shaped areas (*b*) symmetrically disposed on either side a median ridge (*f*), which ridge extends from the midpoint of the posterior margin of the bursa to the vaginal orifice, and fits the furrow along the sting's base. From either cup-shaped half of the bursa opens anteriorly a bursal pouch (*c*), by a slit with crenelated margins (*d*). The bursal region of the tract slants dorsally and anteriorly, and narrows laterally to the vaginal orifice (*e*).

Of this orifice, the lower margin is the most prominent, and consists of a V-shaped lip, the lower point of which is continuous with the median elevation of the ventral bursal wall (fig. 1, A). The dorsal margin of the orifice, a lesser elevation, lies in the groove of the sting's base aforementioned, and comprises but a slight distortion of the smooth dorsal wall of the tract.

The remainder of the sexual tract, the vagina proper, may be described here, since no complete description has been noted in the literature, although its elaborate sculpturing appears to be more concerned with oviposition than with copulation.

Just anterior to the vaginal opening, the first region of the tract (*g*) widens out considerably and extends horizontally forward for a short distance without significant modification. The next region (*h*) gives rise dorsally, from a cone-shaped prominence, to the duct and sperm pump (*i*) (described fully by Bresslau) leading to the spermatheca. Ventrally a tongue-shaped lobe extending from the ventral floor of this region fits, in the collapsed state of the organs, into the cone-shaped protrusion at the mouth

of the duct, and occludes the lumen in this region. To it the function has been assigned by Adam of holding the egg against the mouth of the duct when fertilization is to be accomplished. A space posterior to this tongue allows for its depression on passage of the egg.

Beyond this region and anterior to it, the vagina shows a curious modification. The main tract extends forward (*m*), slanting a little ventrally, as a passage with a deeply folded wall, broad in the transverse direction, flattened dorsoventrally. From the anterior angles of this rectangular passageway lead the oviducts (*o*), by lateral passages that open from the outer sides of the vagina into the medial aspects of the posterior ends of the oviducts (at *p*). Along the midventral line of this portion of the vagina runs a narrow slit, or fossa (*n*), deepening toward the anterior end, and extending slightly beyond the apertures of the oviducts, to terminate as a short blind pocket just under the ganglion (*g*), which straddles the end of the vagina and the crotch of the oviducts. The whole region is enveloped by a heavy muscle mass, the finer anatomy of which has not been analyzed.

In the first or ascending region of the vaginal tract (*g*) the dorsal and ventral walls of the vagina are apposed, and a cross section shows as a horizontal slit. The walls of the medial portion (*h*) are deeply folded and wrinkled, and a cross-section approaches a horizontal oval with wrinkled margins. Anteriorly to the ventral tongue the horizontal wall is apposed to a ledge on either side of the deep fossa (*n*), while the walls of this fossa are apposed laterally. The cross-section of this region therefore shows as a T.

In copulation the arrangement of the bursal structure facilitates the penetration of the drone organ. When the genital aperture is opened, by depressing the ventral anal plate, and the sting is slightly withdrawn, the bursa may be readily observed. This condition is also obtained by holding the female between the fingers or by etherizing her, when the anal plates gape open.

The orifice of the vagina remains tightly closed. If the membranous floor of the genito-anal vestibule is depressed further, however, the median ridge of the bursa is pulled ventrally, and the V-shaped lower lip of the vaginal opening is drawn away from the base of the sting. The inflation of the bursal pouches, by the eversion into them of the drone's pneumophyses, and especially by the withdrawal of the pneumophyses as the eversion of the rest of the organ proceeds, would pull the whole ventral wall of the bursa ventrally, and the median ridge would draw the lower vaginal margin away from the upper, thus opening the vaginal orifice to the drone's organ. The function of the pneumophyses thus appears to be performed upon their withdrawal from, as well as by their eversion into the bursal pouches. This would allow the tubular portion of the drone organ which precedes the bulb (fig. 2, *a*) to penetrate the vagina, thus allowing connection even though the bulb itself should not succeed in everting.

That this relatively massive bulb enters the vaginal orifice at all is doubtful. In the first place, its size relative to the dimensions of the vagina (fig. 1, B and C) seems to render this impossible, even though one allows for considerable elasticity in the walls of this region. But other evidence also renders this improbable. As the penis extrudes, the ventral side being longer than the dorsal, the organ bends dorsally. This is especially noticeable at the tip, the dorsal curvature of which is occasioned by the eversion of the bend by which the bulb of the penis (fig. 2, C) tapers into the ejaculatory duct (at *c'*). This recurved tip will fit neatly into the upward bending copulatory bursa and vagina. If this condition obtains in copulation, the bulb of the penis with its chitinous plates obviously does not enter the vaginal orifice at all, but merely forces the tapering end of the ejaculatory duct (*c'*) within the orifice. Further evidence that this is the true state of affairs is obtained from the appearance of queens that return from the mating flight with the drone organ attached. Often, I believe generally, the brown chitinous plates of the bulb can be seen just within or partly extruding from between the anal plates; although the bursa is so large that if they lodged, even partly, within the vagina, they must be com-



pletely hidden from the outside. Under these conditions these chitinous plates could not act, as Shafer infers,<sup>4</sup> as a means of holding the organ in the vagina, nor would they serve to prevent the escape of seminal fluid when the queen had freed herself from the drone. This fluid, unless otherwise prevented, could return by the route by which it entered, through the ejaculatory duct; for the same fullness of the bulb wall opposite these plates which allows them to evert (emphasized by Shafer) would allow the ejaculatory duct to extend back through the bulb without being compressed by them. In a former paper (p. 267) prevention of the escape of spermiatic fluid has been ascribed to the immediate coagulation of the mucus from the accessory gland upon exposure to the air.

Assuming this explanation to be correct, the second point in question, the extent of the eversion of the drone's copulatory organ, resolves itself into the following: granting that the usual process results in complete eversion of the bulb and end of the ejaculatory duct (fig. 2, C), is it possible for a queen to be fertilized by a drone whose organ has not been extruded so far (fig. 2, B)? Of the eight queens to be described, three still carried the drone organ when killed, and of these three, in two the bulb was fully everted. In one, however, it was apparently not. One of the oviducts of this queen was normally distended with sperm and mucus, the other was slightly distended, and the bulb of the penis retained a mass of secretion sufficient to distend the lesser one as fully as the other. How this queen retained the organ securely enough to twist it off from the drone, or even how the connection was made at all, it is difficult to say; unless one assumes, as described elsewhere, that the section of the penis tube immediately preceding the bulb (fig. 2, *a*) failed to turn inside out, and held in the vagina as the end of the ejaculatory duct is assumed to do in complete eversion. This might result if the force of the sexual act were insufficient to cause the eversion of the bulb, which if it took place would cause the withdrawal of this section of the tube from the orifice of the vagina. One assumes in this case that the everting end of the penis (*a*) enters the vagina as the pneumophyses open it; and then withdraws

again normally as the bulb everts, since the bulb itself would not enter the orifice. The presence of this bulb in the bursa would operate, by depressing the ventral floor, in the same manner as the pneumophyses do; that is, the vaginal orifice would be widely opened, and the dorsally recurving end of the ejaculatory duct could enter it. More evidence is needed on this phase of the matter.

The distance to which the drone organ enters the vagina may be judged from a consideration of the relative sizes of the respective parts. In figure 1, A and B, are drawn in outline the dorsal view and the profile of the female genital tract, and in figure 1, C, the lateral view of the end of the everted drone organ. The vagina can undoubtedly be expanded to a larger dimension than its relaxed state would show, but it is hardly possible that the large bulb with its heavy chitinized plates could be made to enter the vaginal orifice, to say nothing of turning inside out as it entered. It seems certain, therefore, that the eversion of this part takes place in the outer space comprising the bursa copulatrix and the region posterior to it (the genito-anal vestibule). The curved end of the ejaculatory duct is probably normally the only part of the drone organ to remain in the vagina proper, though, as stated, the section of the penis preceding the bulb in eversion probably lodges there momentarily. The bulb would then lie between the dorsal and ventral genito-anal plates, and its size is such as would cause the pronounced gaping of the queen's last segment, and which would leave the tips of the brown chitinized plates on the dorsal side of the bulb to protrude visibly from the genital aperture, as may usually be observed in newly mated queens.

#### DESCRIPTION OF FERTILIZED QUEENS

Of the eight queens the fertilization of which was successful and the time of mating recorded, four were fixed and sectioned for histological study and four were dissected in the fresh condition. The following data describe the gross appearance of the oviducts, vagina, spermatheca, and, when present, the penis of the drone, with which the queen habitually returns to the hive,

and in those sectioned, the histological appearance and the disposal in the female organs of the male sexual products.

A (not over one-half hour mated). In this queen, on opening the abdomen, both oviducts and the anterior end of the vagina were widely distended with fluid, which appeared through the thin walls of the parts in this fresh specimen to be of the yellow color characteristic of sperm rather than white like mucus. On opening the oviducts under the microscope, clear active sperm flowed from the anterior end of each, followed by a mixture of sperm and mucus, which was not coagulated until it came into contact with the air. The vagina contained chiefly mucus. There were no sperms in the spermatheca. The drone's penis attached in the bursa copulatrix had been fully everted, so that the end of the ejaculatory duct had been carried through the everted bulb and formed the end of the organ in its extruded condition (fig. 2, C). There was a little mucus in the end of the ejaculatory duct lying within the bulb of the penis.

B (not over one-half hour mated). One oviduct of this queen was widely distended, the other slightly. Sections showed mucus and sperm both present. The sperms were scattering in the mucus, but by far the greater number of them were found to be in clumps or masses surrounded by mucus, and especially outside the mucous mass altogether and next the oviduct wall. Here they clumped in masses so dense that a  $10\ \mu$  section was almost impervious to light, because of the dark-staining heads. The filaments lay side by side in wavy bands perpendicular to the oviduct wall, in much the same way as the sperm are arranged in the seminal vesicle of the drone. In the anterior portion of the vagina where the oviducts enter it, and whence the duct leads off to the spermatheca, the sperms were very densely collected, especially on the dorsal side of the vagina. Masses of pure sperm without mucus occurred in the folds of the vaginal wall in the vicinity of the duct opening. The duct itself in cross-section showed sperm masses, but no mucus that could be distinguished. The spermatheca showed a faint sprinkling of sperms in a clear transparent non-staining medium—a medium which gave exactly the same appearance as the content of the spermatheca of the virgin queen.

The penis attached to this queen was distended with white mucus to a point slightly beyond the tips of the queen's last segments. It was fixed with the queen; then dissected out, and an attempt made to section it. But either the fixative used (Gilson's) or else exposure to the air had so hardened the mucous content as to nick the microtome knife and destroy most of the significant sections. Several points could be made out: first, that the mass contained mucus and few, if any, sperm; second the bulb of the penis was not everted (fig. 2, B) (though the organ was firmly attached to the queen), and, third, the mucus was contained in the bulb of the penis and in the enlarged end of the ejaculatory duct adjoining it. The sheath of the penis surrounding the uneverted bulb was torn from the bulb in removing the organ, exposing the bulb and ejaculatory duct. In this case, therefore, these parts served analogously to a spermatophore, except that the contained fluid was mucus without sperm, all the sperms having apparently been forced on into the queen's oviducts.

C (mated not over one and one-half hours). This queen was inspected at once. Both oviducts were distended with sperm and mucus, still uncoagulated (until exposure), and the spermatheca contained many sperms in a clear medium. The penis attached in the vagina was shrunken considerably and had apparently been extruded completely with eversion of the bulb, as in extrusions produced experimentally (previous paper, p. 250). It contained but a small amount of mucus, no sperms, and it was torn off close behind the bulb.

D (same time as C). This queen had already lost the drone organ. Histological sections showed in general the same conditions as obtained in B, but both oviducts were distended, and yellow in the fresh condition as before. Sperms had scattered somewhat through the mucous mass, but were mostly still unmixed with the mucus, and most of them were gathered along the oviduct walls, especially dorsally. The mucus appeared less densely staining and showed evidence of solution along the edges of the mass, except that in the posterior region of the vagina the mucus stained intensely, as mucus does which has been

hardened or coagulated by exposure. Near the duct leading to the spermatheca, which was dorsal to this densely staining region, were clusters of clear sperm as in B, and the spermatheca itself was quite densely populated with sperms in a clear plasma. They were perhaps twice as abundant as in the case of B.

E (mated not over two and one-half hours). This queen's organs were dissected out in a fresh condition, and showed essentially the same condition as case C, as far as inspection without sectioning could show. Both oviducts contained sperm and mucus, the sperm exuding first when the oviducts were opened. The penis had been detached. The spermatheca contained numerous sperms in a clear fluid.

F (mated not over four and one-half hours). Sectioned for histological study. Both oviducts were considerably distended, the penis had been detached. The vagina contained only a little mucus at the posterior end, which stained very densely, and a few sperms were visible at the edges of this mass even posterior to the aperture of the spermathecal duct. One oviduct had received mostly sperms with little mucus, the other showed the characteristic picture of a central core of mucus surrounded by a dense layer of free sperms, not so numerous, however, as in specimens killed earlier. There seemed to be not many more sperms scattered through the mucus than in earlier cases, but there were fewer areas of clear sperms within the mucous mass, as if in this case the sperms had had time to work out toward the oviduct walls. The mucus appeared to be less densely granular, stained less densely than other cases described (except in the vagina as noted), and was probably beginning to dissolve.

The spermatheca was densely crowded with sperms, for the first time in these cases presenting the characteristic picture of the laying or fertilized queen's spermatheca in the numbers present, and exhibiting the characteristic tendency to gather into wavy masses or whorls with heads together and filaments parallel.

G (not over six and one-half hours). Queen was dissected fresh. The oviducts were equally but not greatly distended, and on opening them, what fluid was present consisted of few sperms and considerable mucus with sperms scattered homogene-

ously but sparsely through it. This mucus was distinctly more fluid than in earlier queens or than that obtained from drones. The spermatheca when punctured on a slide poured forth seething masses of sperms, with no sign of mucus in the fluid that contained them. The penis of the drone was not present.

H (not over eighteen hours). The oviducts of this queen were but slightly distended. Sections showed a light-staining and but slightly granular mucous mass in the oviducts, not more than one-fourth the volume of that in newly mated queens, with sperms so scattering that they were found only with considerable difficulty. The vagina was empty, except for a few sperms in the folds of the dorsal wall near the aperture of the duct to the spermatheca. The spermatheca burst in fixation (either through osmosis or handling), and most of the content escaped, but what remained showed dense clumps of sperms. At this rate, it is estimated that the oviducts would have become empty in about twenty-four hours from the time of mating.

#### SUMMARY AND CONCLUSIONS

These observations may be summarized in the following account:

The result of copulation in the bee is not immediate filling of the final sperm reservoir, the seminal receptacle of the queen, but the sexual secretions of the drone are received temporarily in the vagina and oviducts. The two components, spermatheca fluid from the seminal vesicles and mucus from the accessory glands of the drone, are not intimately mixed in copulation, nor do they later mix homogeneously in the queen's organs. The white viscous mucus is found as a white central core in (typically) each oviduct (in one case most of the mucus was in one oviduct, most of the sperm in the other) surrounded by the less viscous spermatheca fluid; as if the oviduct, partially distended with the spermatheca fluid which had first entered, then received the more viscous mucus as a rod-shaped column through the center of its lumen. The vagina is filled with mucus alone, indicating that pure mucus was the last to be injected at copulation. The end of the copulatory organ brought back by the queen after

mating also contains pure mucus. In the oviducts the sperms tend to separate out from the mucus, to gather along the walls of the oviducts, and in the folds of the chitinous wall in the region of the aperture of the 'sperm pump' leading to the spermatheca; and they alone, without the mucus, enter the spermatheca.<sup>5</sup> The mucus disappears gradually from the oviducts. It is probably absorbed.

The bulk of the sperms have entered the spermatheca within four and one-half hours after copulation; practically all of them may enter within six and one-half hours. Their manner of getting there has not been determined, though their progress is not altogether passive, and is possibly guided by a chemotaxis. The mucus is absorbed more slowly, being still present in small amounts (in one case cited) at eighteen hours after mating. One of its functions is evidently mechanical, to follow the spermatic fluid through the organs of drone and queen, forcing all of this fluid well up into the oviducts, where it will be retained even though some loss of content of the vagina might follow the tearing of the penis from the drone. Another function is apparently to seal off, by almost instantaneous coagulation on contact with air, the torn end of the copulatory organ, and thus prevent backflow of secretion upon rupture of this part (as coagulation of blood prevents loss from a wound in higher animals). Concerning its physiological function in the queen, if it has any, these data give no information, though the obvious inference is that it may be a stimulus to the ovaries.<sup>6</sup>

<sup>5</sup> The cavity of the spermatheca is far too small to contain the mucus or any considerable part of it (fig. 1, B and C) that is injected into the queen's oviducts at the time of fertilization; nor is any trace of it found there, nor in the duct leading to it, nor in the vagina immediately adjacent to the duct. The sperms alone are so densely packed into the spermatheca as to preclude the presence of any great amount of material of any kind as a medium for them; and in the virgin queen the spermatheca is well distended with a fluid of its own into which the sperms pass after the queen's mating.

<sup>6</sup> In one case of artificial fertilization, reported by Jäger and Howard (Artificial fertilization of queen bees. *Science*, N.S., vol. 40, p. 720, 1915) to have resulted in a short period of fertile egg production, injection of the drone's secretions with a pipette is understood to have been responsible for what degree of insemination was obtained. As to whether this was due to the injection of

The results of these observations, furthermore, bear out in certain details the conclusions of a former paper on the functioning of the sexual apparatus of the drone. They corroborate the thesis that the two secretions of the drone which make up the sexual fluid—the spermatic fluid of the vesicles and the mucus of the glands—have a separate function and are not mixed prior to copulation, and that the mucus acts as a plug to prevent backflow of fluids, by coagulating in the torn end of the penis. The mucus does not form an essential part of the spermatic fluid in the sense in which the mucous secretions of some other animals do. It forms neither a vehicle for their transfer from male to female, nor a nutrient fluid, nor, probably, does it provide an important stimulus to their activation (since they separate from it, and pass toward the sperm duct evidently under some other stimulus).

Finally, from the two series of observations (that of the former paper and this) may be derived a more complete account of the mechanics of fertilization in the bee than has been proposed heretofore. The stages of this process may be summarized as follows:

1. *Coition.* The insects meet and clasp face to face; the female on being grasped allows the tip of the male's abdomen to enter the genito-anal vestibule; the drone, by explosive contraction of the abdominal walls everts the organ into the female genital tract. The pneumophyses first dart into the bursa pouches, and by their expansion depress the ventral floor of the bursa, and thus pull open the vaginal orifice. As the next region of the penis, the median tubular portion with its modifications, proceeds to unfold, the pneumophyses are forced back and withdrawn, opening the vagina as they retract to the widest possible extent, and probably allowing this tubular section to enter the

pure spermatic fluid, however, or to the injection of both sperms and mucus, and how long after copulation egg-laying commenced, their preliminary note did not state. Virgin queens will often lay drone eggs if for some reason (defective wings, etc.) they are unable to mate, but only after a prolonged period. Queens usually lay within two or three days after fertilization, conditions being favorable, and sometimes after as short a period as thirty-six hours.



orifice temporarily. If the contraction of the drone's abdomen is violent enough to cause the eversion of the bulb, the medial tubular section must be withdrawn, for the bulb itself is too large to be able to enter the vagina. Its size, however, serves to keep this orifice open until the final portion, the tapering end of the ejaculatory duct adjoining the bulb, everts through the bulb and enters the vagina.

2. *Ejaculation.* With the insects in connection, the drone's seminal vesicles and accessory glands contract by spasmodic alternate twitchings of the circular and longitudinal muscles enveloping them (see former paper). In the gland the musculature is so arranged about its base that the contraction of either set of muscles or of both of them serves to occlude the gland's lumen, and prevent outflow of the mucous content through the ejaculatory duct. At the same time this contraction forces the mouth of the vas deferens from the seminal vesicle close against the chitinous membrane which covers the blind end of the ejaculatory duct penetrating the gland's base. This is burst through, and the sperms from the vesicle are the first to be ejaculated. Upon relaxation of the first spasmodic contraction of the musculature of the gland's base, the lumen of the gland is again allowed to open, and the mucus in the distal reservoir region of the gland flows through the basal region and into the ejaculatory duct, following the sperm. In this manner all the sperms are forced over into the queen's organs.

3. *Separation.* If eversion of the drone's organ has been only partial (fig. 2, B), the uneverted bulb may be distended with mucus, but the sperm will have been forced on into the vagina. If eversion was complete (fig. 2, C), the bulb will still be distended by reason of its stiff chitinous structure. In either case it remains attached to the queen, lying in the genito-anal vestibule and bursa between the sting (dorsal) and the ventral floor of the passage. The queen breaks this organ off from the drone, usually close behind the bulb, by crawling or flying in a circle around him, and returns with it to the hive. The character of the mucous content is such that it coagulates immediately on contact with the air, thus preventing backflow of the sexual fluids through

the torn end of the penis. The organ gradually dries and shrinks when it becomes dislodged or is pulled away by the bees in the hive within a few hours.

4. *Disposal in organs of queen.* The secretions distend the oviducts and vagina, the former with an outer layer of almost pure sperm, and an inner core of almost pure mucus, the latter with mucus alone. The sperms appear to separate out of the mucus and pass by way of the sperm duct to the spermatheca by their own activity, leaving the mucus to be absorbed from the oviducts.



Abstracted by Gary N. Calkins, author.  
Columbia University, New York.

*Uroleptus mobilis* Engelm.

### III. A study in vitality.

In the second of these studies (Jour. Exp. Zool., vol. 29, no. 2) it was shown that *Uroleptus mobilis* after conjugation has an initial optimum vitality which gradually diminishes with age until the protoplasm finally dies from the exhaustion of metabolic activities. In the present paper an analysis of seventeen series, all representing the same original protoplasm, shows that the differences between them in the matter of vitality are due to the age of the parents at the time of conjugation or, rather, to differences in vitality at different periods of the life-history. All series with an extremely low vitality come from parents which were in the period of old age at the time of conjugation; all series with high vitality, on the other hand, come from parents in the period of youth at the time of conjugation. Continued in-breeding has not as yet shown any deleterious effect on the vitality of the protoplasm under observation. There is some evidence that congenital weakness due to old-age conjugation is inherited by the later offsprings.

## UROLEPTUS MOBILIS ENGELM.

### III. A STUDY IN VITALITY

GARY N. CALKINS

ONE CHART AND TWO DIAGRAMS

In the second of these studies (Calkins, '19, *Uroleptus mobilis*. II. Renewal of Vitality through Conjugation, *Jour. Exper. Zoöl.*, vol. 29, no. 2) it was demonstrated that the protoplasm represented by a single individual ex-conjugant undergoes a progressive decrease in vitality with continued age and division, and ultimately dies from what Maupas without hesitation designated old age. It was also shown that individuals derived from this protoplasm, if allowed to conjugate at any time during the life-cycle of the series, will regain their lost vitality and repeat the cycle. Up to the present time nineteen different series have thus completed full life-cycles and have died from exhausted vitality, while fourteen other series, descendants of the same protoplasm, are now under culture. Seventeen of these exhausted series started as ex-conjugants and two from cysts. Environmental conditions have been maintained as nearly constant as possible and the same standardized culture medium has been used throughout. The daily records for each series have been averaged for ten-day periods, and the latter averaged for sixty-day periods, thus giving a basis for comparison of vitality at different periods of the same cycle.

During the ordinary routine of recording and transferring from day to day it was quite apparent that differences in vitality between different series were characteristic. Some series were strong and vigorous, while others were decidedly weak; such differences, however, are not always indicated by the division rates or by the curves based upon them, and the records must be further analyzed to bring them out. In some cases, on the

other hand, the differences are so well marked that they may be seen at a glance. Chart 1 shows the full life-cycles of eighteen series and the history to date (January 24, 1920) of four series now living. Each of the eighteen curves represents the vitality, as measured by the division rate, of a single series from its start as an ex-conjugant until death from exhausted vitality. Each series is composed of five lines of individuals, each line comprising one of the first five individuals formed from the ex-conjugant and its progeny by division. Each curve represents the average division rate of all five lines of a series for periods of sixty days and each curve shows the time of origin of filial series, if there were any. The data on which the curves are based are obtained by averaging the daily division rates of all five lines for ten-day periods. These ten-day averages are then averaged for periods of sixty days and the results are plotted. The first record of a curve represents the average division rate for the first six ten-day periods; the second record represents the average division rate for sixty days beginning with the second ten-day period; the third record represents the division rate for sixty days beginning with the third ten-day period, and so on for the complete life-cycle. Obviously there are as many sixty-day records as there are ten-day periods less five and the last five are filled out on the assumption that the division rate was zero.

It is quite obvious from diagram 1 that extreme differences in vitality are manifested by some of the series. Thus the Q series was a weakling as compared with any of the others, and the R series and *a* series were relatively weak as compared with most of the others, while the W series has shown a low grade of vitality from the start. The strong series, on the other hand, are indicated by the number of ten-day periods which lie above the line marking the rate of ten divisions in ten days. The curves, however, afford very poor evidence of the difference in relative vitality of the different series, and for this the data must be more carefully analyzed.

These differences in vitality may be due either to, 1) chance variations in different ex-conjugants; or, 2) to old-age weakness of parents at the time of conjugation; or, 3) to accumulating

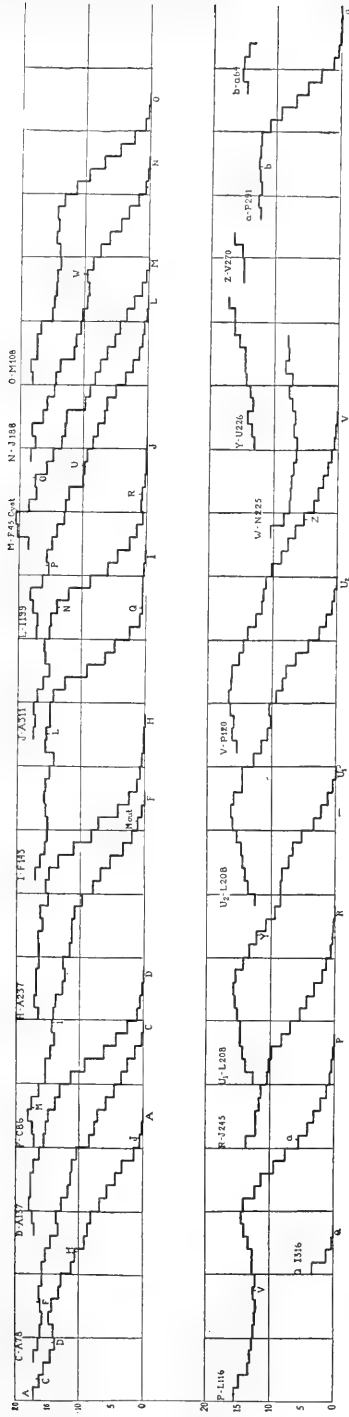

Chart 1

weakness owing to constant and close in-breeding. The first of these alternatives may be disregarded until the other two have been eliminated as possible causes.

#### THE EFFECT OF PARENT'S AGE ON VITALITY OF OFFSPRING

In analyzing the data which I hope will throw light on this problem, it is necessary first to define the terms 'young' and 'old' and to establish some standard whereby the relative vitality of different series may be measured. Such definitions must be based upon a purely arbitrary division between youth and age and are useful only for purposes of comparison. The element of time is less important than the metabolic activity as measured by the division rate, but both are necessary. Using the ordinate which marks the rate of ten divisions in ten days as the arbitrary dividing line between youth and age in a series, I would define the period of youth as that part of the entire life-cycle of a series during which the division rate averages more than ten divisions in ten days for sixty-day periods, and the period of old age as that part of the life-cycle during which the division rate is less than ten divisions in ten days and which ends in natural death. Such phases of youth and age may be measured in terms of time or activity; if the former, by the number of days; if the latter, by the number of generations; while the vitality of the two phases may be indicated by the division rate obtained by dividing the number of generations by the number of days. Statistical data for all of the series are given in table 1.

According to the arbitrary division line between youth and age as adopted above, the period of youth in *Uroleptus* varies from 188 days and 272 generations for the F series, to 69 days and 96 generations for the R series, while the Q series had no youth at all, but seems to have been 'born old.' The average for the sixteen series was 139 days and 214 generations; the A, C, F, I, O, P, U<sub>2</sub>, and V series were above the average and the D, H, J, L, N, R, U<sub>1</sub> and *a* were below.

The period of age varied from 127 days and 82 generations for the C series, to 40 days and 14 generations for the O series, while the average for the sixteen series was 94 days and 65 generations.



TABLE 1  
Youth, age, and vitality. All series

	SERIES														Average				
	A	C	D	F	H	I	J	L	N	O	P	Q	R	U <sub>1</sub>		U <sub>2</sub>	V	a	
Division rate life.	11.7	11.8	12.4	12.3	10.9	13.4	12.8	13.0	11.2	13.6	11.4	6.6	9.7	12.8	11.8	12.0	10.7		
Age, days.....	267	294	215	257	245	240	197	210	230	197	287	35	185	236	255	265	148		
Number of divisions.....	313	349	271	317	268	322	253	273	257	268	327	23	180	285	301	317	159		
Youth																			
Number of days.....	175	167	124	188	134	157	115	124	117	157	177		69	129	159	150	77	139	
Number of divisions...	246	267	201	272	213	264	195	211	183	254	257		96	190	230	238	102	214	
Division rate.	14.0	15.9	16.1	14.4	15.8	16.8	16.9	17.0	15.8	16.1	14.5		13.9	14.7	14.4	15.8	13.2	15.4	
Age																			
Days.....	92	127	91	69	111	83	82	86	113	40	110		116	107	96	115	71	94	
Number of divisions...	67	82	70	45	55	58	58	62	74	14	70		84	95	71	79	57	65	
Rate.....	7.28	6.46	7.70	6.52	4.95	6.98	7.07	7.21	6.55	3.50	6.36		7.24	8.87	7.40	6.87	8.03	6.8	

The C, H, N, P, R, U<sub>1</sub>, U<sub>2</sub>, and V series had a more extended period of age than the average, and series A, C, D, N, P, R, U<sub>1</sub>, U<sub>2</sub>, and V had more than the average number of divisions during the same period. Series in which the periods of both youth and age were longer than the average in number of days were C, P, U<sub>2</sub>, and V, while series having more than the average length of youth and less than the average length of the old-age period were A, F, I, and O, both groups indicating a high potential of vitality. Series which were below the average in length of the period of youth and above the average in the duration of the period of age were H, N, R, and U<sub>1</sub>, while series falling below the average both in youth and age were D, J, L, and *a*. These two groups of series thus had a relatively low potential of vitality.

These statistics, together with the curves of the division rates, are indubitable evidence of differences in vitality between the various series. It is difficult, however, to measure these differences and to determine which of any two or more series is weaker in vitality. The division rates for unit periods of time are useful in comparing vitality at different periods of the same life-cycle, but are practically valueless in determining relative vitality of different series because the two factors, time and number of divisions, are variables. Thus, if one series lives for 200 days and divides 300 times, its division rate for the entire period would be fifteen divisions per ten days, while another series which lives only 150 days and divides only 225 times would have exactly the same division rate. The vitality, however, would not be the same in the two series, since the length of the two spans of life would be left out of consideration. The division rate represents the intensity of metabolic activity; the number of generations combines the element of time and the element of metabolic activity, and the number of days of life represents what may be termed the endurance of the protoplasm. For purposes of comparison between different series, it is necessary to take into consideration all of these factors, which include: 1) the total number of days of life; 2) the total number of generations; 3) the number of days comprising the period of youth, and, 4) the number of divisions during the period of youth. A table suitable for com-

puting the relative vitality of series which have completed their life-cycles as well as for future series when the data are available, can be made only on the basis of common factors of age in days and in number of generations. A table of constants from 0 to 350 is adopted here as the basis for computing the relative vitality of any series which has completed its life-cycle. On such a table, under the appropriate headings, the data for a given series are entered opposite the nearest numbers. The sum of the four numbers thus indicated gives the vitality index for the series, and this may be expressed on a percentage basis by dividing by an assumed constant, which, on the basis of results obtained thus far, represents a perfect vitality. Thus, an ideal life-cycle, from first to last division, extends through 300 days and through 350 generations by division. An ideal period of youth is 175 days long and includes 275 generations. The sum of these four (1100) gives the constant index or numerical expression of vitality, of an ideal life-cycle.

Table 2 includes the data for all series which have completed their life-cycles.

On the basis of the vitality index obtained from the above table and expressed in percentages of the ideal total, we have the following order in relative vitality of the series to date: C 97.7 per cent, P 95 per cent, F 94.1 per cent, A 90.9 per cent, I 89 per cent, V 88.1 per cent, U<sub>2</sub> 85.9 per cent, O 79.5 per cent, H 78.6 per cent, U<sub>1</sub> 76.3 per cent, L 74.5 per cent, D 73.6 per cent, N 71.3 per cent, J 69 per cent, R 48.1 per cent, *a* 44 per cent, and Q 5.4 per cent.

With such a key to the relative vitality of different series, it is not difficult to ascertain the effects of parents' age on vitality of the offspring. The statistical data are given in table 3.

Series with relative vitality lower than 70 per cent may safely be regarded as weak. Such are the J, R, *a*, and Q series. They all agree in coming from parents in the old-age period. Thus the J series came from A when the latter was 250 days and 311 generations old. The weakness of the parent protoplasm is indicated by the fact that it lived only seventeen days and divided only twice after the J series was started by conjugation.

TABLE 2  
For computing relative vitality of series

CON- STANTS	ENTIRE LIFE		PERIOD YOUTH		CONSTANTS	ENTIRE LIFE		PERIOD YOUTH	
	Days	Divi- sions	Days	Divi- sions		Days	Divi- sions	Days	Divi- sions
0			Q	Q	180		R		
5					185	R			N
10					190			F	U <sub>1</sub>
15					195	J O			J
20					200				D
25		Q			205				
30					210	L			L
35	Q				215	D			H
40					220				
45					225				
50					230	N			U <sub>2</sub>
55					235	U <sub>1</sub>			
60					240	I			V
65					245	H			A
70			R		250				
75			a		255	F U <sub>2</sub>	J N		O P
80					260				
85					265	A V			C I
90					270		D H O		F
95				R	275		L		
100				a	280				
105					285	P	U <sub>1</sub>		
110					290				
115			J N		295	C			
120					300		U <sub>2</sub>		
125			D L		305				
130			U <sub>1</sub>		310				
135			H		315		A V		
140					320		F I		
145					325				
150	a		V		330		P		
155			I O		335				
160		a	U <sub>2</sub>		340				
165			C		345				
170					350		C		
175			A P						

The R series came from this weak J series when the latter was 160 days and 245 generations old, and with only thirty-seven days more to live. The *a* series came from the P series when the latter was 210 days and 291 generations old, and the Q series came from I when the latter was 200 days and 316 generations old.

TABLE 3  
*Vitality of offspring and age of parents*

STATISTICS OF OFFSPRING					STATISTICS OF PARENTS										
1	2	3	4		5	6	7	8		9	10			11	12
Series	Relative vitality	Initial division rate <sup>1</sup>	Rejuvenescence		Percent-ages <sup>3</sup>	Series	Relative vitality	Age at time of offspring		Days	Divisions	Vitality after offspring			
			Amount <sup>2</sup>	Percent-ages <sup>3</sup>				Days	Divisions			Days	Divisions	Division rate	
	<i>per cent</i>				<i>per cent</i>		<i>per cent</i>								
C	97.7	13.6	1.7	12.1	A	90.9	70	78	197	235	11.9				
P	95.0	12.5	1.3	7.6	L	74.5	70	116	140	157	11.2				
F	94.1	13.4	2.6	16.3	C	97.7	50	86	244	263	10.8				
A	90.9	Parent unknown. Wild				?									
I	89.0	16.2	5.1	35.4	F	94.1	100	143	156	174	11.1				
V	88.1	13.8	3.3	22.8	P	95.0	90	120	197	207	10.5				
U <sub>2</sub>	85.9	13.8	4.5	26.5	L	74.5	140	208	70	65	9.3				
O	79.5	15.5	4.5	?	M	A cyst	60	108	136	150	11.0				
H	78.6	16.7	8.9	63.6	A	90.9	170	237	97	76	7.8				
U <sub>1</sub>	76.3	13.9	4.6	27.0	L	74.5	140	208	70	65	9.3				
L	74.5	16.3	2.6	15.5	I	89.0	120	199	90	123	13.7				
D	73.6	14.3	2.2	15.7	A	90.9	100	137	167	176	12.1				
N	71.3	16.6	7.6	45.0	J	69.0	120	188	77	65	9.0				
J	69.0	17.4	16.3	116.4	A	90.9	250	311	17	2	1.1				
R	48.1	14.8	12.7	75.1	J	69.0	160	245	37	8	2.1				
<i>a</i>	44.0	12.4	7.8	53.1	P	95.0	210	291	77	36	4.6				
Q	5.4	6.7	5.2	30.9	I	89.0	200	316	40	6	1.5				

<sup>1</sup> Division rate per ten-day periods from start of offspring to last division of parents.

<sup>2</sup> Average number of divisions in ten days in excess of parents' division rate. Difference between columns 3 and 12.

<sup>3</sup> Percentage increase as compared with the division rate of parents during their period of youth. Cf. table 1. For example, the increase in vitality of the C series amounted to 12.1 per cent of the division rate of the period of youth of the parent A series.

The low vitality of the J series cannot be due to congenital weakness of the parent A whose relative vitality was 90.9 per cent. Other filial series from this same parent were all more vigorous, the C series with relative vitality of 97.7 per cent, H series 78.6 per cent, and D series 73.6 per cent, all of which came from the parent A series in its period of youth.

The R series came from the congenitally weak J series, but the inherited weakness was enhanced by the advanced age of the J series when R was started. The N series with a relative vitality of 71.3 per cent came from the same parent J series when it was only forty days younger, and the combined effects of inherited weakness and age of parents was evident in its own vitality. A W series, from N 225, is now living and has lived for 229 days without conjugating and with an average division rate of only 9.7 divisions in ten days. The low vitality of the *a* series, which was next to the weakest that I have cultivated, was probably not due to congenital weakness, for the same parent gave rise to the V series with a relative vitality of 88.1 per cent. But the V series came off during the period of youth while *a* came off during the period of age.

The Q series, finally, came from the I series when the latter was 200 days and 316 generations old. The same parent with a relative vitality of 89 per cent gave rise to the L series with vitality of 74.5 per cent.

With the exception of the N and the R series, both of which came from the J series during an advanced age, there is no weak ancestor in the heritage of these weak series. The J series came directly from A, the first ancestor of the cultures. The *a* series came from P (95 per cent); P from L (74.5 per cent); L from I (89 per cent); I from F (94.1 per cent); F from C (97.7 per cent), and C from A (90.9 per cent). The Q series from I has the same early and strong ancestry.

There is evidence, therefore, that these series with extremely low relative vitality owe their weakness to the nearly exhausted vitality of their parents. Yet, low as their vitality was, they all, nevertheless, showed the characteristic rejuvenating effect of conjugation as shown in table 3, columns 4 and 5.

Contrasting these extremely weak series with the markedly strong ones, such as series C (97.7 per cent), P (95 per cent), I (89 per cent), F (94.1 per cent), and V (88.1 per cent) (the parentage of A was unknown), we find that all came from young parents in the prime of metabolic activity. The parents of both C and P were 70 days old; of F, 50 days old; of V, 90 days old, and of I, 100 days old. There is strong evidence, therefore, that the vigor of these series was due to conjugation of relatively young parents.

The remaining series, U<sub>1</sub>, U<sub>2</sub>, O, H, L, and D, with intermediate relative vitality, came, as a rule, from parents of middle age. The two U series came from the same epidemic of conjugation which occurred in the L series when the latter was 140 days and 208 generations old. The O series, with relative vitality of 79.5 per cent, came from the M series when the latter was 60 days and 108 generations old. It was started, therefore, during the period of youth of its parents M and should have had a higher relative vitality. Its parents, however, came from a cyst instead of from conjugation, and this may have had something to do with its low relative vitality. The H and D series are interesting in that both came from the same ancestor A series. The D series was started when the parent protoplasm was 70 days and 100 generations younger than when the H series was started, yet its relative vitality (73.6 per cent) was less than that of the H series (78.6 per cent). Its average division rate for the entire life, however, was higher (D 12.4 divisions per ten days, H 10.9), and higher also for the period of youth (D 16.1, H 15.8) and higher also for the period of age (D 7.7, H 4.9), showing that the metabolic activities of the D series were more virile than were those of the H series. Its weakness was due to its low endurance, for it lived only 215 days, while the H series lived 245 days. This may have been due to chance variation resulting from amphimixis. Unfortunately, ex-conjugants were not taken either from D or H.

The L series, finally, with its low relative vitality of 74.5 per cent, came from the I series while the latter was in the period of youth, or 120 days and 199 generations old. Its protoplasm

divided, on the average, thirteen times in ten days throughout the entire life-cycle, and seventeen times in ten days during its period of youth. Its metabolic activities, therefore, were high, but it also lacked in endurance, living only 210 days. Its offspring, the P series, had the same virility in metabolic activity, but it was combined with endurance which gave the P series its high relative vitality of 95 per cent. It is quite probable, therefore, that the relatively low vitality of the L series was due to other causes than age of the parents at the time of conjugation.

Returning once more to the extremely weak series, it remains to be seen whether their weakness was due to congenital causes or to environmental influences. It must be emphasized, however, that environmental conditions have been maintained as nearly as possible the same for all series, and exactly the same for series under culture at the same time, so too much stress must not be placed on the factor of environment. The Q series, for example, had an average division rate of only 6.6 divisions per ten days of its thirty-five days of life, while its initial division rate was only 6.7 and its amount of rejuvenescence only 5.2 (cf. table 3). Its parent, the I series continued to live after the Q series had died, even though it was 316 generations old when the Q series was started. The I series was thus extremely old at this time and had the characteristic weakness of old age, yet it showed no effect of possible adverse environmental factors which might have been responsible for the weakness and early death of its progeny, the Q series. Furthermore, the Q series divided for the first time on January 23, 1919, and the P series divided for the first time on January 15th. The two series thus were carried on at the same time and were subject to the same environmental influences, yet the Q series divided in all only 23 times while the P series divided 327 times. The weakness of the Q series cannot be attributed to adverse environmental causes.

The protoplasm of the *a* series also was consistently weak throughout. Its division rate for the entire life-cycle was 10.7 divisions per ten-day periods and only 13.2 divisions during its period of youth. It divided only 159 times in 148 days and its



period of youth was only half as long as the average for all series (cf. table 1). Its first division occurred on August 13, 1919, and its last on January 8, 1920. Other series living during these five months and subject to the same environmental factors were series U<sub>1</sub>, U<sub>2</sub>, V, W, Y, Z, and all of the X series (regeneration experiments). The Y series started on August 1st and is still living; the W series started on May 31, 1919, and is still living; the Z series and seven experimental X series with controls, started in September and October and all are living; the U<sub>1</sub>, U<sub>2</sub>, and V series divided for the last times on November 15th, December 3rd, and January 2nd, and all died a natural death after 285, 301, and 317 generations, respectively. Environmental factors, had they been responsible for the weakness of the *a* series, should have shown some effects on these other contemporaneous series, but as no ill effects were shown by them we must conclude that the low vitality of the *a* series was not due to environmental causes.

Analyzing the R series and the J series in the same way, we find that environmental factors were not responsible for their low vitality. The R series lived from January 23 to July 27, 1919, a period during which the L, O, P, U<sub>1</sub>, U<sub>2</sub>, V, W, and some of the X series were under cultivation and showed no ill effects of adverse environmental conditions. The J series divided for the first time on August 20, 1918, and for the last time on March 5, 1919; during this period the F, H, I, L, M, N, O, and P series were also under cultivation without showing any effects of adverse external conditions.

Since the low vitality of the weak series cannot be attributed to adverse external conditions; since all weak series agree in respect to one condition, viz., extreme old age at the time of the parents' conjugation; and since all series with high relative vitality agree in coming from parents whose protoplasm was comparatively young, we must conclude that weakness of the parental protoplasm, whether due to age or to congenital causes, is the primary cause of the low vitality of the offspring. The effect on offspring of congenital weakness of parents is not clearly shown by any of the above series, although indications of it

are shown by the R and N series. More complete evidence will be forthcoming when the data for certain series now under cultivation are complete. Thus the *b* series, derived from *a* in its sixty-fourth generation, the first few periods of which are shown on diagram 1, has been continuously weak despite its origin from parental protoplasm during the period of youth.\*

#### CONTINUED IN-BREEDING AND VITALITY

One of the conditions of successful conjugation, as given by Maupas in 1889, is diverse ancestry of the conjugating individuals. In this connection he stated:<sup>1</sup>

Il nous reste encore à dire quelques mots de la troisième condition organique: la fécondation croisée. Les expériences, sur lesquelles je me suis basé pour formuler cette loi, sont au nombre de plusieurs centaines parfaitement concordantes, mais ne portent que sur les quatre espèces suivantes: la *Leucophrys patula*, l'*Onychodromus grandis*, la *Stylonichia pustulata* et le *Loxophyllum fasciola*. On n'a qu'à relire les chapitres qui leur sont consacrés et on y trouvera le détail de ces expériences. Tant que ces infusoires ont été apte à contracter des unions fécondes, ils ne se sont jamais conjugués qu'entre individus mélangés appartenant à des cycles distincts. Sur les nombreuses préparations d'individus proches parents et non mélangés, le jeune auquel je les soumettais s'est toujours terminé, ou bien par l'enkystement, ou bien par la mort par inanition. Ce ne fut que plus tard, lorsque la dégénérescence senile eut commencé à attaquer mes cultures, que je vis apparaître des syzygies, sur ces préparations de proches parents. Mais toutes ces dernières conjugaisons aboutirent à la mort des ex-conjugués qui, après s'être desunis, ne réussirent pas à continuer leur évolution et à se reorganiser. Ces accouplements sont donc des phénomènes pathologiques causés par la dégénérescence senile. Cette fécondation croisée répond-elle à une nécessité générale et absolue chez tous les ciliés? Je ne voudrais pas l'affirmer. Il faudrait pour cela avoir expérimenté sur un beaucoup plus grand nombre d'espèces. Il n'en est pas moins constant que nous pouvons affirmer, chez les ciliés, l'existence de cette loi du croisement des éléments fécondateurs d'origine distinctes, dont les effets et l'importance ont été si bien étudiés par les botanistes.

With the exception of the weak progeny derived from parents of advanced age the results obtained by Maupas with

\* Note added July 21. The *b* series died after 114 days and 156 divisions, showing a relative vitality of only 43.6 per cent.

<sup>1</sup> E. Maupas. Le rajeunissement karyogamique chez les ciliés. Arch. d. Zool. exp. e génér. II, T. VII, pp. 410-411.

the species named are certainly not confirmed by my results with *Uroleptus mobilis*. Up to the present time I have successfully cultivated thirty-three series, seventeen of which have died a natural death, while sixteen are living in various phases of vitality. Every one of these series was derived from the conjugation of two closely related individuals, and all came from the protoplasm of one single cell, the first individual of the A series, which was isolated as an ex-conjugant on November 16, 1917. In-breeding, therefore, has been close and continuous, and we have data to determine whether or not this has been a cause of deterioration in protoplasmic vitality of the later series. Adopting the relative vitalities of the seventeen series

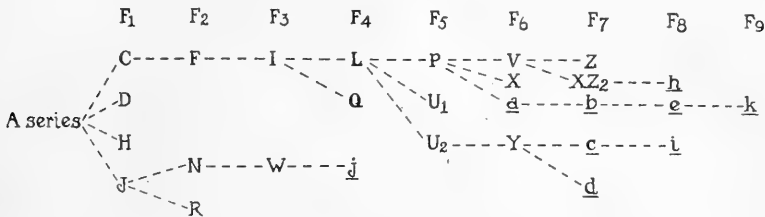

Diagram 1

given in table 3 as a vitality index, we may compare the later series with the earlier ones, following the different lines one by one. Diagram 1 gives a graphic representation of the filial series to the ninth generation.

The two branch lines from the parent A differed widely in fecundity; conjugation epidemics were frequent in all representatives of the branch starting with the C series, but very infrequent in representatives of the other branch. In most cases of the latter set, conjugations occurred for the first time late in the life-cycle, so that all representatives of this branch came from relatively old parents. The W series, for example, from N 225 on May 31, 1919, gave no successful conjugation test for 230 days, or not until it was 255 generations old, when the *j* series was started. The calendar sequence of the origin of the different series is given in diagram 2.



the P series, in which the relative vitality was 95 per cent. The other representatives of this fifth filial generation, the  $U_1$  and  $U_2$  series, fell off to 76.3 per cent and 85.9 per cent, respectively, but this lower vitality may be accounted for by the fact that the parent L series was 208 generations old and in the period of old age when the two U series were started; while the high vitality of the P series from the same parent L, when younger, is evidence that the lower vitality of the U series was not due to in-breeding. The sixth filial generation included the V, X, *a*, and Y series. The relative vitality of the V series was 88.1 per cent and of the *a* series 44 per cent. The decrease shown by the V series is not significant and probably was due to chance variation (cf. the two branches of the U series), while the marked decrease of the *a* series has already been traced to the extreme old age of the parents at the time of conjugation. The X and Y series are still living and their relative vitalities cannot be computed, but that their vitality is high is indicated by the fact that the X series has already lived and divided longer than any previous series (over 300 days), while the Y series is 212 days old and is still maintaining a high division rate.

The other branch from the A series, beginning with the J series, has had a continuous record of old-age conjugations so that only four filial generations have been produced in the same time during which the other branch produced nine filial generations. The J series came from the A series when its parents were 250 days and 311 divisions old at the time of conjugation; the N series came from J when the latter was 120 days and 188 divisions old; the R series from J when the latter was 160 days and 245 divisions old, and the W series came from N when the latter was 130 days and 225 divisions old. The W series, in spite of its weak ancestry, has shown a remarkable vitality, especially in the factor of endurance, for it has already lived 270 division days, or longer than any other series with the exception of C, P, and X. The metabolic activity, as measured by the average division rate of 9.7 divisions in ten days, has been conspicuously low. Conjugations did not occur in this series until it was 261 days and 255 divisions old. What vitality its filial *k* series will have remains to be seen.

On the whole, there is no evidence that continued in-breeding and under the same cultural conditions for more than two years had had any deleterious effect on vitality of the protoplasm under observation. The cyclical exhaustion of vitality is continuously offset by renewal through conjugation, and the extent of this renewal depends upon the age at which the parents conjugate. The optimum of vitality is apparently assured by conjugation of parents during their period of youth, and the relative strength of this optimum varies with the congenital vitality of the parental protoplasm.

#### SUMMARY

From the results described in the second of these Studies (Calkins, *Uroleptus mobilis*. II. J. Exp. Zoöl., vol. 29, no. 2) and on a priori grounds, we might expect that, apart from slight variations of a casual nature, all series derived from conjugation would have practically the same vitality since all are representatives of the same protoplasm and all began their life-cycles as ex-conjugants from closely related parents.

This a priori expectation has not been realized, however, and striking variations in vitality between the seventeen series of *Uroleptus mobilis* which have completed their life-cycles and variations which cannot be interpreted as casual have been obtained. Some series have run as high as 97.7 per cent, 95 per cent, and 94.1 per cent of an ideal perfect vitality (series C, P, and F), while others have been as low as 5.4 per cent, 44 per cent, and 48.1 per cent (series Q, a and R).

It has been shown previously that all series of *Uroleptus mobilis* begin life after conjugation with an initial optimum vitality which gradually and inevitably diminishes until the protoplasm finally dies with unmistakable evidence of the exhaustion of metabolic activities. In the present paper it is shown that the striking variations in vitality of different series are due to the age, and therefore to the relative vitality of the protoplasm of the parent cells at the time of conjugation. All series with extremely low vitality agree in coming from parents which were in the period of old age at the time of conjugation, while all series with

extremely high vitality agree in derivation from parents which were in the period of youth at the time of conjugation.

Continued in-breeding has not, as yet, shown any deleterious effect on the vitality of the protoplasm under observation. There is some evidence that congenital weakness of an  $F_1$  generation due to old-age conjugations of the parents is inherited by the offspring in the  $F_2$  generation.

Columbia University,  
March 10, 1920.





THE JOURNAL OF EXPERIMENTAL ZOOLOGY, VOL. 31, NO. 3  
OCTOBER, 1920

Resumen por el autor, Clarence C. Little,  
Institucion Carnegie de Washington,  
Cold Spring Harbor, New York.

### Factores que influyen en el crecimiento de un tumor transplatable del ratón.

Un sarcoma J. W. B., que se originó en un tronco de ratones danzantes japoneses cruzados entre si muy próximamente, crece en 100 p. c. de los casos cuando animales de esta raza se inoculan con pedazos pequeños de tumor. El crecimiento es continuo y progresivo. Animales de dos troncos ordinarios presentan un crecimiento continuo y progresivo de implantaciones del tumor en menos de un medio por ciento de los animales inoculados. Los hibridos  $F_1$  desarrollan el tumor lo mismo que los ratones japoneses puros. En experimentos previos los  $F_2$  hibridos presentaron una tendencia a la susceptibilidad heredada y dependiente de la presencia simultánea de varios factores mendelianos. Los animales producidos por el cruzamiento de  $F_1$  con individuos del tronco ordinario no susceptible deben dar lugar a una cierta proporción de animales susceptibles. El estudio de los animales de la raza no danzante inoculados a los 2, 4, 6, 8, 10, 12, 14, 16, 18 y 20 o mas dias de edad, indica que los ratones mas jóvenes son mas susceptibles de un modo significativo al crecimiento temporal del tumor que los ratones mas viejos. Las hembras de los grupos mas viejos son menos susceptibles que los machos o hembras de los grupos mas jóvenes. Inoculación de los individuos del cruzamiento de los hijos con los padres indica que los ratones mas viejos son mas susceptibles y las hembras aun mas que los machos. Los resultados en apariencia contradictorios pueden reconciliarse en una sola hipótesis. Muchas hembras de los grupos de mayor edad alcanzan la madurez sexual durante el periodo de observación. La madurez sexual implica la diferenciación avanzada de tejidos, que a su vez implica oportunidad para que los factores hereditarios se expresen por completo; por esta causa los ratones de la raza no susceptible eliminan las implantaciones del tumor, mientras que los del cruzamiento con los padres desarrollan el tumor porque presentan los factores geneticos para la susceptibilidad, heredados del abuelo de raza raponesa.

## FACTORS INFLUENCING THE GROWTH OF A TRANS- PLANTABLE TUMOR IN MICE

C. C. LITTLE

*Carnegie Institution of Washington, Cold Spring Harbor, New York*

TWO DIAGRAMS AND ONE FIGURE

This paper has for its object the analysis of certain of the factors underlying susceptibility and non-susceptibility of mice to implants of a sarcoma (J. W. B.) of the Japanese waltzing mouse.

An effort has already been made and is still being continued to determine the number and nature of the genetic factors underlying the successful growth of the tumor. Such experiments will be reported on in a future paper. In the meanwhile, however, the effects of age and sex upon the growth of the tumor have been studied in certain races of mice and form the subject-matter of this communication.

### MATERIALS

*a. Tumor.* The tumor used is a sarcoma (J. W. B.) described by Tyzzer ('15), which originated in a closely inbred strain of Japanese waltzing mice. When a bit of the tumor is implanted subcutaneously in mice of this race, growth of the implant is continuous, resulting eventually in a large subcutaneous tumor and death of the animal. By means of such implants, this tumor has been propagated within this race for seven years, or for over forty implant generations.

*b. Mice.* The 675 mice used were of two races: 1) Common non-waltzing animals of (*a*) albino and dilute brown (*dbr*) stocks, and, 2) hybrids produced by crossing these common races with Japanese waltzing mice and then back-crossing the first generation hybrids with the common non-waltzing parent



## TECHNIQUE

*a. Inoculation*

The technique of inoculation is that which has long been employed by Tyzzer and is extremely simple. The tumor, having been excised, is placed in a sterile Petri dish. A bit of it is then cut off with a clean pair of sharp curved scissors, placed on the lip of a trochar, and is pushed into the neck of the trochar by the blunt plunger. The mouse is then held firmly and the trochar pushed forward under its outer skin to the region of the right axilla where the bit of tumor is deposited; the trochar is then removed and sterilized and the process repeated for another mouse. No ether is necessary, for the mouse appears scarcely to feel the inoculation and no bleeding occurs. In mice younger than eight or ten days a slight modification of method is necessary.

In these animals a small incision about 1 mm. long is made in a position approximately above the right kidney, care being taken to avoid cutting the peritoneum. A fine, blunt wire or the point of a pair of blunt forceps is then run forward under the outer skin to make a pathway for the tumor implant; the implant itself, cut as before from the tumor mass, is placed at the mouth of the incision and is pushed gently forward under the skin by the forceps or blunt wire. By lifting the skin in the region of the incision, it is found possible to draw in the implant by suction and in this way place it in a position where it is easier to push it forward to the region of the right axilla. In some cases the incision needs no further treatment, and in others where the skin has become slightly stretched or torn in the process, a single drop of flexible collodion applied after the implant is pushed forward, will serve to provide an air-tight and antiseptic method of closing the wound.

It is also necessary to work rapidly with younger mice in order that they may not lose their body warmth and become inactive and repugnant to the adult mice when they are replaced in the pen. It is further advisable to hold them for one-half or three-quarters of a minute wrapped in cotton bedding taken from their own nest, before they are replaced after in-

oculation. In this way they present no unfamiliar odors to the old mice and are therefore accepted by them in a majority of cases without further investigation. If these precautions are omitted, one finds not infrequently that the old mice in the pen, not recognizing the returned young one, will neglect it or will bite and perhaps devour it.

*b. Observation and record*

Beginning with a date two weeks after inoculation, weekly observations are made upon all inoculated mice. The mice are examined individually by palpation, and the presence or absence of a mass noted. Each mouse is given a serial number, and is in this way kept distinct from all others. If a mass is present, it is described, and if it is larger than a pinhead a sketch is made of it on the record sheet of the mouse.

Thus weekly observations are made in the case of all animals up to and including the sixth week after inoculation. From that time on, observations are made upon only those animals showing a mass. In this way a diagrammatic representation is obtained of the gradual growth of the tumor as well as a record of its diminution and eventual disappearance, should this take place. The absolute size of the mass cannot, of course, be very accurately determined. The observer estimates it as carefully as possible and represents it by an outline upon the record sheet of the mouse. An effort to diminish the influence of the personal equation has throughout been made by utilizing only a small number of trained observers who frequently compare their impressions as to the size of the mass recorded, and in this way reach a fairly accurate estimate. It is doubtful whether efforts to make these observations more accurate would be of real value since the variation in the amount of hair and thickness of skin in individual mice would undoubtedly to some extent influence the measurable size of the mass, even were measurements taken with calipers.

Furthermore, the nature of the mass itself, including, as it often does, large areas which are cystic and collapsible upon

puncture, while in other cases lacking these almost entirely, makes the actual size a very variable matter and not too accurate a measure of true growth. Undoubtedly, histological preparations showing the number and extent of mitotic figures in a microscopic field of a given area would be one of the best methods of recording actual growth. This, however, is not practical. Sample records of mice showing various reactions toward the tumor implants are given below.

It does not seem necessary to reproduce the records in detail for all the mice observed, though these have been preserved and will be presented in a later publication.

Mice were inoculated in ten age groups: two, four, six, eight, ten, twelve, fourteen, sixteen, eighteen, and twenty or over

Sample of Records  
Actual Mice - Selected Cases - (N) Series.

NO. OF MOUSE	AGE	SEX	2 Weeks	3 Weeks	4 Weeks	5 Weeks	6 Weeks
132	12	♀	Tiny Mass ●	Small Mass ●	Small Mass ●	Mass ●	Negative
160	6	♀	Pinhead	Small Mass ●	Negative	Negative	Negative
513	4	♀	Small Mass ●	Pinhead	Negative † Dead	—————	—————
517	4	♂	Negative	Negative	Negative	Negative	Negative

days, respectively. In calculating the amount of growth observed, a single observation is the unit employed. Thus in the sample records given above, mouse 132 has six observations, four of which show some growth of the implanted tumor. In this particular mouse the percentage of growth is 80.0.

On the other hand, mouse 513, which died between the fourth and fifth week after inoculation, has only three observations and therefore contributes only this number to the total number recorded. By employing this method, it is possible to calculate the percentage of observations of all mice in one age class or at any one observation period, which show growth of the tumor. It further provides a standard by which both the common stocks and the back-cross generation can be compared.

## EXPERIMENTAL

Table 1 shows the observations taken on albino stock mice. In this and in subsequent tabulations, the sign *plus* stands for records showing a mass, and the sign *minus* stands for records showing no growth. It will be seen that the grand total of observations is 233 plus to 1862 minus. In other words, 11.12 per cent  $\pm 0.46$  of the observations show growth of the tumor.

Table 2 shows a similar treatment of the back-cross generation in which a total of 170 plus to 799 minus have been obtained.

TABLE 1  
Common stock (*N*)

AGE	2 WEEKS		3 WEEKS		4 WEEKS		5 WEEKS		6 WEEKS		TOTAL		% +
	+	-	+	-	+	-	+	-	+	-	+	-	
20.	1	40	1	40	3	37	3	24	1	21	9	162	5.3
18	12	24	4	32	4	29	0	32	0	24	20	141	12.4
16	5	29	3	31	3	31	3	26	2	28	16	145	9.9
14	12	54	8	57	9	56	5	55	2	58	36	280	11.4
12	5	51	5	36	5	51	3	51	1	37	19	226	8.1
10	9	29	5	23	6	31	2	27	0	20	22	130	11.5
8	7	15	3	19	3	19	2	14	2	14	17	81	17.3
6	7	58	14	50	5	57	4	47	4	47	34	259	15.0
4	12	62	10	62	5	65	4	66	3	66	34	321	9.8
2	5	29	7	21	5	22	5	22	4	23	26	117	18.1
	75	391	60	371	48	398	31	364	19	338	233	1862	11.12 $\pm 0.46$

This is a percentage of  $17.54 \pm 0.83$  showing tumor growth. As the tables show, these totals lump all ages and all observations on both sexes. It will be seen that the difference between the series is 6.7 times its probable error and is therefore certainly significant. Since there is such a difference and since we know that in all probability the back-cross generation animals possess hereditary factors favoring tumor growth which are absent from the albino stock it will be of interest to analyze the data further in an attempt to locate more accurately certain of these factors and to determine, if possible, something of their physiological nature.



Figure 1 shows the percentage of observations showing growth for both races on successive observation weeks, all ages and both sexes combined. It will be noticed that the curves for the two races are very different in shape—that of the albino race (N)—(broken line) goes steadily down from these cond to the sixth weeks, and if the chart had been continued, the base line would have been approximated in a short time. On the other hand, the curve of the back-cross race (B.C.) (solid line) goes downward for the second and third weeks, but then strikes a level at close to 13 per cent and remains there. This level represents roughly

TABLE 2  
*Back-cross stock (BC)*

AGE	2 WEEKS		3 WEEKS		4 WEEKS		5 WEEKS		6 WEEKS		TOTAL		% +
	+	-	+	-	+	-	+	-	+	-	+	-	
20	19	46	19	44	12	50	11	50	9	52	70	242	22.4
18	2	7	0	9	0	9	0	9	0	9	2	43	4.4
16	4	5	4	4	4	5	4	5	3	6	19	25	43.1
12	3	11	4	10	1	12	1	12	1	12	10	57	14.9
10	6	30	2	34	2	33	2	33	3	32	15	162	8.5
8	5	20	2	24	1	25	2	24	2	24	12	117	9.3
6	4	5	3	6	1	8	2	7	2	7	12	33	26.6
4	5	10	3	12	2	13	2	13	2	13	14	61	18.6
2	6	11	4	11	1	14	2	12	3	11	16	59	21.3
	54	145	41	154	24	169	26	165	25	166	170	799	17.54±0.83

the proportion of mice which are going to show continued growth of the tumor. It indicates further that by the time that the race finds a more or less constant level at roughly 13 per cent, the genetic make-up of the individuals has become relatively fixed and the factors favoring tumor growth introduced by the Japanese waltzing race have exerted their influence. Table 3 shows in tabular form the data upon which figure one is constructed.

Table 4 includes the percentage of observations showing growth—divided according to the age of mice at inoculation, in four-day groupings. The common race (N) shows a slightly

higher percentage of growth among observations on the relatively younger mice. The back-cross generation (B.C.) shows the opposite relationships. The small numbers of observations in the fourteen- to sixteen-day classes in the B.C. series vitiate somewhat the value of the percentage of 43.1 obtained there.

If, however, the data in table 4 are divided into two general age groups comprising the upper and lower halves, from twenty

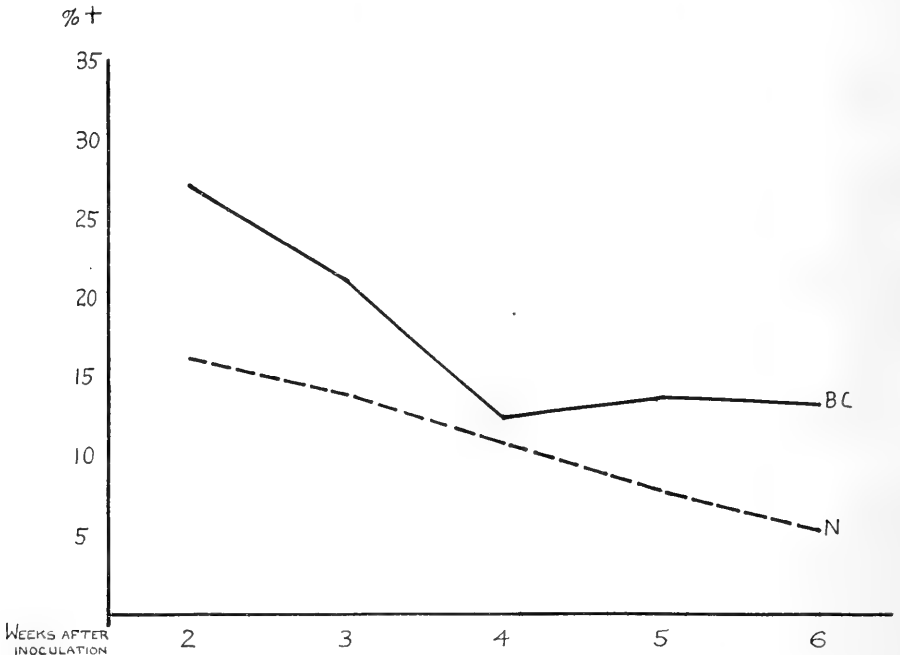

Chart 1

plus to twelve and from ten to two days, respectively, we shall find a fair basis for comparison and some most interesting facts. For example, in the common stock the lower age group averages  $12.87 \pm 0.6$  per cent observations showing growth, while the higher group shows  $9.49 \pm 0.6$  per cent. The difference between them is  $3.38 \pm 0.85$ , or about four times its probable error. There is then in the common (N) series apparently a real difference due to, or correlated with, age at inoculation.

TABLE 3

WEEKS	COMMON			BACK-CROSS		
	+	-	% +	+	-	% +
2.....	75	391	16.1	54	145	27.1
3.....	60	371	13.9	41	154	21.0
4.....	48	398	10.7	24	169	12.4
5.....	31	364	7.8	26	165	13.6
6.....	19	338	5.3	25	166	13.1
	233	1862	11.12±0.46	170	799	17.54±0.83

Difference 6.42±0.95

6.7 × P.E.

TABLE 4

AGE	COMMON			BACK-CROSS		
	+	-	% +	+	-	% +
2-4.....	60	438	12.0	30	120	20.0
6-8.....	51	340	13.0	24	150	13.8
10-12.....	41	356	10.3	25	219	10.3
14-16.....	52	425	10.9	19	25	43.1
18-20.....	29	303	8.7	72	285	20.2
	233	1862		170	799	

TABLE 5

AGE	COMMON			BACK-CROSS		
	+	-	% +	+	-	% +
2-10.....	133	908	12.87±0.6	69	432	13.77±1.05
12-20.....	100	954	9.49±0.6	101	367	21.58±1.28
	Diff. 3.38±0.85 about 4 × the P.E.			Diff. 7.81±1.65 4.6 × P.E.		

In the back-cross (B.C.) series, a very interesting distinction is found. The lower age group shows a percentage of  $13.77 \pm 1.05$ , being thus not significantly different from the lower age group of the (N) series. The upper age group, however, is very dif-

ferent and shows a great increase in the percentage of observations showing growth. Its percentage of  $21.58 \pm 1.28$  differs from the lower group by  $7.81 \pm 1.65$  and is 4.6 times its probable error.

We have then to explain a decrease of percentage in observations showing growth in the common stock (N) series in the higher age group as compared with the lower, and directly the opposite result in the (B.C.) series, where the higher age group shows a significant increase in percentage of observations showing growth.

TABLE 6<sup>1</sup>

AGE	COMMON ♂'s			
	+	-	% +	
2-10.....	76	408	15.70±1.64	} Diff. 5.40±2.03 2.6 × P.E.
12-20.....	44	383	10.30±1.20	
COMMON ♀'s				
2-10.....	80	331	19.46±1.31	} Diff. 10.7±1.51 7 × P.E.
12-20.....	48	463	9.39±0.87	

<sup>1</sup> In this table and in table 7 certain recent experiments are included, the results of which became known after the values of the previous tables had been calculated. Inasmuch as they merely confirm the previous findings and include only very small numbers, it did not appear worth while to include them in the curves until another tabulation was made.

We have seen that the distinctions between the higher and lower age groups exist when the sexes are lumped together. The next obvious step is to see whether a sex difference exists. Tables 6 and 7 bear on this point.

Table 6 shows the upper and lower age groups of males and females within the common (N) series.

It will be seen that there is no significant difference in the total percentage of growth between males and females when all ages are lumped. In fact, the two percentages of 13.17 and 13.88, respectively, are close enough to be striking. The same holds in the case of males when the upper and lower age groups are

contrasted. The upper group shows  $10.30 \pm 1.20$  per cent of growth, while the lower group shows  $15.70 \pm 1.64$  per cent. The difference is 2.6 times its probable error and, while considerable, cannot be regarded as significant.

The females, however, show a significant distinction between the two age groups. The upper age group has a growth percentage of  $9.39 \pm 0.87$ , and the lower group one of  $19.46 \pm 1.31$ . The difference between them is  $10.7 \pm 1.51$ , or seven times its probable error. There is, then, clear evidence that the females are distinctly more tolerant to the growth of the tumor when they are inoculated at an extremely early age than when they are inoculated a little later on. The significance of this fact will be discussed later.

TABLE 7

AGE	BACK-CROSS ♂'s			
	+	-	% +	
2-10.....	36	212	$14.51 \pm 1.51$	} Diff. $0.87 \pm 2.16$ $0.4 \times$ P.E.
12-20.....	38	209	$15.38 \pm 1.55$	
BACK-CROSS ♀'s				
2-10.....	33	231	$12.12 \pm 1.76$	} Diff. $13.62 \pm 2.71$ $5 \times$ P.E.
12-20.....	52	150	$25.74 \pm 2.07$	

In the (B.C.) series, the males show approximately the same amount of records showing growth as do the males of the (N) series. The actual figures are  $14.94 \pm 1.09$  as compared with 13.17 in the (N) series. The contrast between the age groups is even less marked than in series (N). The percentage in the higher group is  $15.38 \pm 1.55$ , and in the lower group  $14.51 \pm 1.51$ . There is, then, no difference between the age groups as regards the percentage of observations showing tumor growth. The females are, however, again strikingly different and, what is even more interesting, show a departure from one another and from the males in quite the opposite direction from that taken by the females of the (N) series. Thus the lower age group of the (B.C.) series females shows a percentage of  $12.12 \pm 1.76$ , a value

not greatly different from the percentage found in all male lines and in the total percentages of females in the (N) series. Instead of showing a falling off of growth as in the (N) series, the females of the (B.C.) series comprising the upper age group give a percentage of  $25.74 \pm 2.07$ . This group differs from the lower group of the same series by  $13.62 \pm 2.71$ , a difference of five times its probable error.

To sum up for discussion the main facts made apparent by the experiments, it may be stated that:

1. In the common-stock mice of series (N), there is a steady decrease in the percentage of observations showing growth on successive weeks after inoculation. In the back-cross hybrids of series (B.C.), the percentage falls during the second, third, and fourth weeks after inoculation, but comes to a resting point at about 13 per cent for the fifth and sixth weeks.

2. In series (N), the percentage of growth in males and in females of all ages grouped is extremely close, 13.17 and 13.88, respectively. The males show no significant difference between upper and lower age groups. The females show in the lower group a percentage of 19.46 and in the upper group 9.39. The difference between these groups is seven times its probable error.

3. In series (B.C.), there is no significant difference between the total percentages for males and for females. The two age groups for males are also very similar in growth percentage. The females, however, show a great increase of growth in the upper age group, 25.74 as compared with 12.12. This difference is five times its probable error.

#### DISCUSSION

The common stock used in series (N) was one in which we should expect that few if any of the animals inoculated would show a steady progressive growth of the Japanese mouse tumor. Upon testing, it had been shown repeatedly that this race was not like the Japanese waltzing mouse in size, color, vigor, or indeed in any visible characters. It is not therefore surprising to find a negligible occurrence of permanent growth and a small amount

of temporary growth diminishing on the successive weeks of observation and finally disappearing altogether.

If we suppose that in this race temporary growth of the Japanese waltzing mouse tumor was possible in certain of the very young mice until an intolerance toward it was developed by the normal maturing and differentiation of the tissues of the non-susceptible stock animal, a working hypothesis is provided.

We know from the work of Murphy and others that embryonic tissue provides a suitable growth medium for tissue of even widely divergent forms. The idea suggested is that such embryonic tissue provides a medium favorable to such growth. It seems, however, that tolerant is a more accurate description than favorable. The relatively undifferentiated characterless embryonic tissue is not possessed of sufficient biological individuality to discriminate against and set up unfavorable reactions toward the implant of foreign tissue. Not until it reaches a sufficiently advanced stage of differentiation do we find an unfavorable reaction initiated resulting in the final elimination of the implant.

If such an explanation is correct and applicable to the case of mice, we should expect to find, as we do, the younger and relatively less differentiated mice more tolerant of the foreign implants, and therefore showing a higher percentage of growth than do the mice which are older and more differentiated at inoculation. In this connection the difference between the sexes is of great interest. It is a well-known fact that female mice normally come to sexual maturity at an earlier age than do their litter brothers. It follows, therefore, since sexual maturity implies differentiation, that the female mice would reach earlier than the males a degree of individuality, which would enable them to discriminate more strongly against the foreign tissue. This is shown in the striking decrease in the percentage of growth in the females of the older age group as compared with those of the younger age group. These animals have, in all probability, attained a sufficient degree of development of individuality to recognize the tumor implant as a foreign body and to therefore

eliminate it. The reaction of these mice is a clear case of what Loeb has recently considered under his study of the inheritance of the 'individuality differential.' This matter will be referred to later in more detail, but for the present it is interesting to note that the individuality differential of the tumor implants are the same, since they are all derived from what was the same piece of tissue. The study of the behavior of these implants has, therefore, a distinct advantage over Loeb's method of implanting a piece of tissue from various individuals into other individuals and of studying the resulting reactions. In Loeb's case it is obvious that there are two variables: 1) The individuality differential of the animal giving the implant, and, 2) the individuality differential of the host. Since these in turn are themselves the composites of the activity of a dual structure, namely, the fertilized egg, it follows that the possibilities for confusion due to complexity of their organization are manifold. In this respect, the use of a biological constant such as the tumor J.W.B. has a great advantage. Coming as it does from a remarkably homogeneous race of animals, it represents a tissue in which the individuality differentials contributed by its maternal and paternal ancestors are approximately, if not entirely equal. The result is a relatively great uniformity of response whenever known genetic material of a relatively homogeneous nature is used as the host stock.

Even within the Japanese waltzing race itself, the wonderfully uniform nature of the individuals is shown by the unfailing growth of the J.W.B. tumor in animals of this race. This can mean only that within this race types of implantation which would normally be as widely distinct as homiogenetic are to all intents and purposes autoplasmic in their reaction.

It follows, then, that when the tumor J.W.B. is used for implantation that much simpler conditions are realized than those that exist in Loeb's material. Much of the indefiniteness which surrounds his hypothesis of syngenetic, homiogenetic, and heterogenetic transplantation and the resulting classes of toxins, vanishes, because the test of the individuality differential is reduced to the simple question of its treatment of a biologically constant implant.



The writer, in collaboration with Tyzzer ('16), has tested the behavior of another tumor—a carcinoma of the Japanese waltzing mouse (J.W.A.). Here the successful growth of tumor implants was found to depend upon a complex of some twelve or fourteen independently Mendelizing factors introduced by the Japanese race. The presence of all these factors as a complex even in a single dose is enough to give a favorable reaction to the tumor implant, resulting in its continued growth. In the gametogenesis of animals possessing the complex in a single dose, the factors forming the complex for susceptibility are distributed according to the random segregation of the Mendelian principles. Whenever a gamete is formed with any one of the factors of the complex missing, it does not produce a susceptible individual unless it meets in fertilization another gamete in which the missing member of the complex is carried.

The idea advanced by Loeb, then, namely, that intermediate results are obtained, in the progeny of animals with different individuality differentials, is probably due to the fact that not only his implants, but his host stock were variables. It would be nearer the truth to say that most individuals in gametogenesis form gametes differing considerably from each other in the genetic factors underlying the individuality differential which they carry. When a new zygote is formed, its individuality differential as a host is dual. It has the power of supporting growth of any tissue which in its zygotic formula carries in a double dose either of the identical factor complexes which the gametes contributed by each of its parents carried in a single dose.

For example, let us suppose that the factor complex underlying the individuality differential contributed by the sperm of the male parent of individual X was factors  $A^m B^m C^m$  and by the egg of its female parent  $A^f B^f C^f$ . Individual X is of the formula  $A^m A^f B^m B^f C^m C^f$ . It could support the growth of tissues of formulae  $A^m A^m B^m B^m C^m C^m$  or  $A^f A^f B^f B^f C^f C^f$  or  $A^m A^f B^m B^f C^m C^f$ , the latter being an individual identical with itself as regards the factors under consideration.

The critical point is that the host can utilize as its individuality differential either a combination of both the factor complexes

contributed by the gametes which formed it, or these complexes separately. The implant, on the other hand, is always treated as a combination of the factor complexes which it possesses, and has a single individuality differential which is the result of such a combination of complexes.

The bearing of these matters upon the results with the tumor J.W.B. in the series here reported upon is found in the fact that the data given for the common race (N) shows that some of the factors contributing to the individuality differentials of the females are developed more clearly and begin to function with the onset of sexual maturity and its accompanying differentiation. Embryonic tissue or the tissue of the new-born may be supposed to have an individuality differential which is less clearly and distinctly defined, and which is simpler than that of the tissue of older animals. It discriminates less actively, therefore, against the individuality differential of the bit of implanted tumor tissue. As age increases, the discrimination becomes more active and more clearly defined, and finally the implant is eliminated.

The distinctness of this difference in tolerance between upper and lower age groups within the female sex suggests that the activity of the ovary is intimately concerned with the assumption of the full development and activity of the individuality differential. It may therefore follow that a form of sex limitation is involved in the activity of certain of the hereditary factors under consideration. The transmission of these factors through the male as in the case of other sex limited characters is certain.<sup>2</sup>

The (B.C.) series tabulated according to sex in table 7 gives distinct evidence of a new type of situation. The same principles of individuality differentials hold, but are somewhat modified by the presence within the race of the genetic factors possessed by Japanese waltzing mice. When those factors necessary to support continued growth of an implant of the J. W. B. tumor are present, a susceptible animal results. The ratio of these to non-susceptible animals does not need to be treated in

<sup>2</sup> Care should be taken not to confuse this with sex-linkage, of which no sign exists.

this paper. Their presence, however, would mean a certain number of mice which showed growths in all of the observations taken, in addition to those animals which were merely showing temporary growth. The curve in figure 1 coming to a constant level at about 13 per cent shows the presence of such susceptible animals.

The interesting fact shown by table 2 is that the mice which were twenty or more days old at inoculation show a much higher percentage of growth than do albinos of the same age. The number of eighteen- and of sixteen-day mice are small, but if they are lumped together in order to get more reliable numbers it is found that their growth percentage is also higher than the corresponding classes of common mice; being 23.5 as against 11.2.

The result is seen in table 5, where the lower age group of the (B.C.) generation has a growth percentage of  $13.77 \pm 1.05$ —a result practically the same as the  $12.87 \pm 0.6$  per cent of the similar age group of common mice. The higher age group of the (B.C.) generation, however, has a growth percentage of  $21.58 \pm 1.28$  and differs from the lower group of the same generation by 4.6 times the probable error and from the higher age group of the common (N) series by more than eight times the probable error.

It is obvious that there are here some new conditions not found in the (N) series. The factors of the Japanese mouse complex carried by certain animals of the (B.C.) generation furnish the explanation. Producing by their united action permanent progressive growth of the tumor, certain of the factors of the J.W. complex, even when separated, must in some cases exert a favorable and active influence upon the temporary growth of the tumor. This influence will not be felt until they become active agents in the individuality complex of the animal possessing them. Just as the female mice of the higher age group of the non-susceptible (N) series common mice developed with the oncoming of sexual maturity, their individuality differential of unfavorable characters resulting in elimination of the implant, so the females of the higher age group of the (B.C.) generation may be expected at a similar point to develop in an active condition certain

of the Japanese mouse factors they possess, thus favoring at least temporary growth of the tumor implant.

If this is the correct explanation, the difference between upper and lower age groups in the (B.C.) generation should be more marked in females than in males. Furthermore, the females should show a distinctly higher percentage of growth in the upper age group than in the lower. Table 7 shows this to be actually the case. The upper group females show  $25.74 \pm 2.07$  per cent growth, while the lower group females show  $12.12 \pm 1.76$ . The difference is five times its probable error. The males, on the other hand, show no significant difference between upper and lower groups and a total growth percentage of  $14.94 \pm 1.09$ .

Leaving the genetic analysis of the difference between the Japanese factor complex and that of the common non-waltzing mice to be treated in another communication, now in press, we may on the basis of the data given here conclude that:

1. Animals of a race non-susceptible to inoculation with bits of a sarcoma (J.W.B.) derived from a closely inbred race of Japanese waltzing mice, show temporary growth of the tumor in  $11.12 \pm 0.46$  per cent of the 2095 observations made.

2. The percentage of observations showing growth decreases steadily on successive weeks (second to sixth, inclusive) after inoculation (fig. 1).

3. Mice of this race inoculated at from two to ten days old show a higher growth percentage than those inoculated at from twelve to twenty days old or over. The percentages are  $12.87 \pm 0.6$  and  $9.49 \pm 0.6$ , respectively. The difference between the two age groups is about four times its probable error.

4. The difference observed between these age groups is chiefly confined to the female sex. The difference between males of the upper and lower groups is less than three times its probable error. The difference between females of the upper and lower groups is seven times its probable error—the percentages in the females being  $9.39 \pm 0.87$  and  $19.46 \pm 1.31$ , respectively.

5. Animals of a back-cross generation, some of which should possess the factor complex characterizing the susceptible Japanese waltzing mice and others of which should possess certain

of the factors of this complex encouraging temporary growth, have given a growth percentage of  $17.54 \pm 0.83$  in 969 observations. This differs from the 11.12 per cent of the non-susceptible common race (N) by 6.7 times the probable error.

6. The percentage of growth in the back-cross (B.C.) race decreases for the second and third weeks after inoculation, but reaches and holds a level at about 13 per cent, where it remains during the fourth, fifth, and sixth weeks.

7. Mice of this race when inoculated at from two to ten days old show a lower percentage of growth than mice from twelve to twenty plus days old. The difference is 4.6 times its probable error and the percentage  $13.77 \pm 1.05$  and  $21.58 \pm 1.28$ , respectively.

8. The difference between the age groups is chiefly confined to the female sex. The difference between males of the upper and lower groups is less than its probable error. The difference between females of the upper and lower group is five times its probable error, the percentages being  $25.74 \pm 2.07$  and  $12.12 \pm 1.76$ , respectively.

9. Females of the upper age group in both series are, during the later periods of observation, at an age when sexual maturity is attained. Sexual maturity by the awakening activity of the ovary means further differentiation and further development of individuality of the tissue. Such assumption of individuality leads to elimination of the tumor in non-susceptible animals [series (N)] and to encouragement of its growth in animals inheriting all or part of the factors which are contributed by, and which characterize susceptible animals of the Japanese waltzing race in which the tumor originated.

10. The factors underlying susceptibility to the implanted tumor J.W.B. are inherited units introduced into the back-cross (B.C.) generation by the Japanese waltzing grandparent through the  $F_1$  hybrid parent.

11. Certain of these factors, therefore, find their active expression as favorable agents in supporting growth of the tumor implants in female animals, at the onset of sexual maturity. This means that any attempt to analyze the biological nature of

individuality on the basis of tissue implants of any sort, such as that made by Loeb, must take careful account of the age and sex of individuals as well as of the particular tissue used and of the genetic factors involved in the races and individuals used.

In conclusion, I wish to acknowledge my indebtedness to my assistants, the Misses Johnson, Jones, and Newman for their interest and accuracy in completing with me the tedious work of observing and recording the mice.

#### LITERATURE CITED

- LITTLE, C. C., AND TYZZER, E. E. 1916 *Jour. Med. Research*, vol. 33, p. 393.  
LOEB, L. 1920 *Am. Nat.*, vol. 54, p. 45.  
1920 *Am. Nat.*, vol. 54, p. 55.  
MURPHY, J. B. 1912 *Jour. A. M. A.*, vol. 59, p. 874.  
1913 *Jour. Exp. Med.*, vol. 17, p. 482.  
TYZZER, E. E. 1915 *Jour. Med. Research*, vol. 32, p. 331.  
TYZZER, E. E., AND LITTLE, C. C. 1916 *Jour. Cancer Research*, vol. 1, p. 387.



Resumen por el autor, E. F. Adolph,  
Universidad Harvard.

Reacciones de la puesta de los huevos en la mosca de los frutos,  
*Drosophila*.

Para averiguar si los estímulos químicos y mecánicos pueden influir en el mecanismo de la puesta de los huevos en las moscas, las hembras se colocaron en distintos medios o se las permitió escoger entre diversos medios. Los factores externos estudiados fueron; la humedad, textura del substratum, sabores, olores y combinaciones de estos últimos. Las moscas respondieron a estos diversos estímulos individuales, pero no tan rápidamente como en los complejos ambientes naturales, como indica el número de huevos puestos cada día. Las combinaciones más eficientes, tales como el olor del acetato etílico y la textura húmeda de la gelatina de agar, produjeron una puesta que alcanzó el 90 por ciento del número de huevos puestos en el medio ordinario de banana fermentada. Las sustancias olorosas más efectivas fueron: los ésteres orgánicos simples, aldehidos, ácidos y alcoholes; pero las moscas no responden rápidamente a estos estímulos sin la presencia de humedad. La humedad sola no es un estímulo, pero es un factor indispensable. Los sentidos que perciben estos estímulos no fueron estudiados específicamente. La luz y la visión no juegan papel importante en la respuesta a la reacción. Los factores internos estudiados fueron la edad, fecundidad, actividad locomotriz, periodicidad y hábitos de asociación. Entre estos factores y el número de huevos puestos no se pudo encontrar ninguna correlación definida.

Translation by José F. Nonidez  
Cornell Medical College, New York



## EGG-LAYING REACTIONS IN THE POMACE FLY, *DROSOPHILA*<sup>1</sup>

EDWARD F. ADOLPH

### INTRODUCTION

When and where animals lay their eggs, a problem which has been studied under field conditions by many observers, demand analysis through experiment into terms of response to sensory stimuli. The process is more complicated than some other responses, and has been supposed to involve an element of foresight not usually attributed to many other activities.

Marine invertebrates in general extrude their eggs regardless of immediate surroundings; when the eggs are mature they are shed. Among insects there are many grades of behavior as regards egg-laying, from the indiscriminate distribution by silkworm moths to the preparatory building and provisioning of nests by wasps.

Among Diptera each species has fairly distinctive habits. The Hawaiian melon fly (*Bactrocera*), studied by Back and Pemberton ('14), lays eggs just beneath the surface of fruit, flower, or stem of pumpkins and squash, depositing many eggs in one day, but only on one day in every six or eight. The Mediterranean fruit fly (*Ceratitis*), studied by the same authors in Hawaii ('15 a), laboriously bores through the thick skins of citrous fruits, and lays a few eggs nearly every day for many weeks. The house fly (*Musca domestica* L.) lays its eggs in large numbers wherever moist fecal or other decaying animal material is present (Hewitt, '08), while the blow fly (*Calliphora*) lays wherever carrion or the odor of decaying meat is found (Lowne, '90).

<sup>1</sup> Contributions from the Zoölogical Laboratory of the Museum of Comparative Zoölogy at Harvard College, no. 322.

It is of interest to know whether flies will respond readily to single stimuli rather than to definite complexes of the environment. The problem, as presented by *Drosophila*, was suggested by Dr. G. H. Parker, who constantly guided the course of the work and aided in its details. The experiments were carried on during the year 1915-16 in the Zoölogical Laboratory of Harvard College.

#### EXPERIMENTS

*Drosophila melanogaster* Meigen, commonly known as the little fruit fly or pomace fly, has been used extensively in experimental work. The flies used in the present experiments were from a heterogeneous laboratory stock to which wild and stray individuals had access. They breed readily in culture bottles containing banana fermented with yeast, while in the field they lay their eggs upon a variety of overripe fruits unprotected by skins (Lutz, '14), and on decomposing garbage (Evans, '16). The only conclusion which can be drawn from the literature is that the fruit flies oviposit on fruit and vegetable material which is undergoing acid fermentation.

It has been commonly observed that flies which do not find their regular and accustomed conditions for egg-laying shed a few eggs at random. There are essentially two sets of factors in the process of oviposition: 1) the environmental set, which will release the ovipositing mechanism, and, 2) the previous formation and growth of the eggs. Obviously, the external factors cannot call forth a response until the internal processes have gone to completion.

#### *A. External factors*

Experiments were carried out by exposing female flies to various simple conditions of environment, allowing them a day or two in which to deposit eggs, and then counting the number of eggs laid. *Drosophila* begins to lay its eggs about twenty-four hours after emergence from the pupa, and in general the productivity does not depend upon the fertility, although the unfertilized eggs do not develop. The eggs are elongate and white,

just visible to the naked eye. The work of others justifies the assumption that, on the average, the internal conditions are fulfilled equally well in all flies reared upon ordinary cultures of fermenting banana.

The interpretation of results depends upon an understanding of the productivity of the female *Drosophila* under favorable conditions. According to Lutz ('14), a normal female produces 100 to 300 eggs in a lifetime, the average length of life being 30 days. This gives an average of 6.7 eggs per day for a single female fly. The eggs are laid regularly rather than periodically, just as in the case of the Mediterranean fruit fly (Back and Pemberton, '15 b), where the average is 4.5 eggs per day. In *Drosophila* the present experiments show an average of 3.3 eggs per day for each female fly when allowed to oviposit upon the banana pulp which furnishes nourishment to the fly. In one case a fly laid 33 eggs in a single day. Upon the best media Guyénot ('13, VII) obtained 20 to 25 eggs per day regularly from fertile female fruit flies.

The numerical results have been correlated by averaging the results from similar experiments, weighting the averages according to the number of flies involved and the number of days that the tests lasted. Since the number of trials made with each stimulus differed, the averages are only roughly comparable. The more successful stimuli were used more frequently.

*I. Selective conditions.* In preliminary trials the female flies were allowed to select situations for egg-laying from among eight or ten varieties, which were available at one time. This was done by placing a series of stimulating substances in small glass vials with narrow entrances (similar to those described by Barrows '07) as traps within a large glass cage. The traps were placed parallel in such a manner that to enter them the flies moved away from the windows, in opposition to their positive phototropic impulses. The flies to be used were liberated from the breeding jars into an empty jar, where they were etherized. Females were then selected under anesthesia, usually 100, and transferred to the cage by means of a brush. A dish of water within the cage kept the atmosphere moist.

Two distinct reactions were required in these trials: 1) approach to a distant attraction, and, 2) extrusion of eggs.

1. Controls. The simplest environments that could be presented for the competitive attraction of the flies were glass vials without moisture, odor, or other contents. No flies entered such traps. But when absorbent cotton saturated with water was placed in the vials a few eggs were laid, averaging 0.005 per day per fly, as shown in table 1.

2. Taste. Materials were chosen which, while having no odor, had taste which might be sensed through contact, using the human senses as an arbitrary means of judging the properties of substances. These were all used in water solutions, usually of 1 to 10 per cent. No responses were obtained which surpassed those toward water alone, the only stimulating solutions of those tested being oxalic acid and citric acid (table 1).

3. Odor. The substances possessing odor that were used were chiefly the simple organic acids, alcohols, and esters. Solutions of these were absorbed in cotton within the traps, and contact with the solutions prevented by partitions of perforated blotting-paper. No moist surfaces were accessible to the flies. The flies responded in small measure to acetic acid, ethyl acetate and alcohol, amyl alcohol, and amyl valerianate (table 1).

4. Taste and odor. A large variety of odorous substances were used in a manner similar to that of the last experiment, except that the female flies were allowed to come in contact with the solutions after they had approached the traps. The majority of the organic compounds tried called forth small amounts of egg-laying, as shown in table 1.

Summary. From these experiments it is evident that moisture alone is conducive to egg-laying in very small amounts, that taste plays no definite rôle in initiating the response, while odor is a slight stimulus, especially when the odorous solution may be approached and touched. Moreover, the flies are readily attracted toward odorous substances, and in agreement with Barrows ('07) the most attractive of these proved to be acetic acid and ethyl alcohol.

TABLE I  
*Selective experiments*

KIND OF STIMULUS	STIMULATING SUBSTANCE	AVERAGE NO. EGGS PER DAY PER FLY IN CAGE	AVERAGE NO. EGGS PER DAY PER FLY IN TRAPS	TOTAL NO. EGGS	TOTAL NO. FLIES IN CAGE	TOTAL NO. FLIES IN TRAPS	NO. TRAPS
1. Moisture . . . . .	water	0.005	0.3	5	351	5	5
2. Taste . . . . .	oxalic acid	0.003	0.7	2	200	1	2
	citric acid	0.008	0.2	3	100	4	1
3. Odor . . . . .	acetic acid	0.20	2.0	20	50	5	1
	ethyl acetate + alcohol	0.07	1.5	6	50	2	1
	amyl alcohol	0.03	1.5	3	50	1	1
4. Taste + odor . . . . .	amyl valerianate	0.07	0.8	6	50	4	1
	acetic acid	0.58	1.9	15	13	4	1
	ethyl alcohol	0.47	2.7	216	151	27	9
	butyl alcohol	0.17	8.3	50	100	2	1
	formaldehyde	0.17	0.62	50	100	27	1
	acetaldehyde	0.05	0.10	14	100	46	1
	methyl alcohol	0.04	0.33	8	113	12	2
	ethyl acetate	0.02	1.1	9	100	2	1
	ethyl oxalate	0.02	0.15	5	100	11	1
	ammonia	0.02	0.25	3	100	6	1
	propionic acid	0.01	0.14	3	100	7	1
	formic acid	0.01	0.10	2	100	7	1
	ethyl sulfate	0.01	0.08	3	100	12	1
	propyl acetate	0.005	0.10	2	100	5	1
	butyric acid	0.003	0.33	1	100	1	1
amyl alcohol	0.002	0.03	1	200	11	2	

The following stimulating substances called forth no responses:

1. Dry glass, filter-paper, cotton.
2. Sucrose, glucose, glycerin; hydrochloric acid, nitric acid, osmic acid, succinic acid, tartaric acid.
3. Ethyl alcohol, ethyl acetate, butyl alcohol.
4. Acetone, amyl nitrite, amyl valerianate, ethyl ether, ethylene alcohol, isoamyl acetate, turpentine, valerianic acid.

*II. Constant conditions.* In these experiments etherized flies were placed within glass bottles or vials, which were closed by perforated filter-paper caps or by loose cotton plugs. The number of female flies in a single container varied from 1 to 100. The bottles were exposed to the atmosphere of the laboratory room.

1. Controls. The simplest conditions obtainable gave a slight amount of egg-laying. When the flies were penned in dry glass containers, they laid an average of 0.05 egg per day. When moisture was added by saturating cotton with distilled water, a higher average, 0.18, was obtained, as shown in table 2.

TABLE 2  
*Non-selective experiments*

KIND OF STIMULUS	STIMULATING SUBSTANCE	AVERAGE NO. EGGS PER DAY PER FLY	TOTAL NO. EGGS	TOTAL NO. FLIES	NO. CAGES
1. Moisture . . . . .	none (glass)	0.05	49	605	54
	water	0.18	48	200	12
2. Texture . . . . .	boiled agar	0.77	209	274	33
	boiled starch	0.26	13	25	5
	amphibian jelly	0.17	1	6	2
3. Taste . . . . .	glucose	0.20	19	32	4
	sodium chloride	0.08	2	8	1
4. Odor . . . . .	acetic acid + alcohol	0.06	12	200	3
	formic acid	0.04	13	70	7
	acetic acid	0.02	3	50	10
	butyl alcohol	0.006	1	80	8
	fermenting banana	0.005	2	130	26
	ethyl ether	0.21	5	8	1
5. Taste + odor . . . . .	ethyl alcohol	0.16	45	106	17
	acetic acid	0.10	25	50	10
	chloroform	0.08	2	8	1
	methyl alcohol	0.05	20	100	10

The following stimulating substances called forth no responses:

1. Dry starch, bismuth subnitrate, zinc stearate.
2. Boiled gelatin, chalk + wet cotton, wet clay, wet bismuth subnitrate.
3. Sucrose, glycerin.
4. Ethyl sulfate, ethyl oxalate, isoamyl acetate, amyl valerianate, allyl alcohol, amyl alcohol, isoamyl alcohol, tertiary amyl alcohol, propyl alcohol, isobutyl alcohol, tertiary butyl alcohol.
5. Acetic acid + alcohol, petroleum.

TABLE 2—Continued  
*Non-selective experiments*

KIND OF STIMULUS	CONTACT STIMULUS	ODOROUS STIMULUS	AVERAGE NO. EGGS PER DAY PER FLY	TOTAL NO. EGGS	TOTAL NO. FLIES	NO. CAGES
6. Texture + odor	water	ferm. banana	0.21	12	53	9
	water	acetic acid	0.20	2	5	1
	wet clay	ferm. banana	0.35	21	30	3
	wet clay	acetic acid	0.42	5	6	6
	boiled starch	ferm. banana	0.55	11	4	4
	boiled starch	acetic acid	0.25	3	6	6
	boiled starch	acetic acid + alcohol	0.87	7	8	8
	boiled agar	ferm. banana	2.9	377	136	31
	boiled agar	ethyl acetate	2.7	142	52	16
	boiled agar	formaldehyde	2.7	216	80	8
	boiled agar	ethyl alcohol	2.6	158	60	24
	boiled agar	methyl alcohol	2.0	181	92	20
	boiled agar	acetic acid	1.6	252	155	66
	boiled agar	acetaldehyde	1.6	63	40	4
	boiled agar	fresh banana	1.5	88	60	6
	boiled agar	amyl alcohol	1.3	106	80	8
	boiled agar	formic acid	1.2	99	80	8
	boiled agar	isoamyl acetate	1.2	48	40	4
	boiled agar	valerianic acid	1.2	46	40	4
	boiled agar	butyl alcohol	1.1	91	80	8
	boiled agar	propyl alcohol	1.1	44	40	4
	boiled agar	ammonia	0.9	42	48	12
	boiled agar	propionic acid	0.8	30	40	4
boiled agar	amyl valerianate	0.6	23	40	4	
boiled agar	acetic acid + alcohol	0.4	98	208	27	
7. Texture + taste + odor	fermenting banana		3.3	1961	355	17
	fresh banana		1.6	128	80	8
	juice of fermenting banana		0.3	19	15	3
	solution of suerose + acetic acid + alcohol		0.3	1	3	3

The following stimulating substances called forth no responses:

Odor of fermenting banana: wet glue, wet gelatin + glycerin, wet cotton + chalk, wet cotton + borax, wet cotton + raw starch, plasticene wax.

Odor of acetic acid: sodium silicate, vaselin.

Odor of acetic acid + alcohol: water, wet clay.

Odor of formaldehyde: boiled starch.

2. Texture. The pulpy consistency of overripe fruit was imitated more or less closely by other substances. The flies responded fairly well to solidified agar and water, and less freely to boiled starch and to the gelatinous material which envelops the eggs of amphibians (table 2).

3. Taste. Solutions of non-odorous substances were absorbed in cotton and placed in vials with the flies, where free contact was allowed. In the presence of glucose and sodium chloride a few eggs were laid (table 2).

4. Odor. Flies subjected to the influence of odorous substances in solution were prevented from contact with the solutions by partitions of cheesecloth, or of perforated blotting-paper, or filter-paper. No moisture was within reach of the flies. The flies responded to a small extent to solutions of acetic acid plus alcohol, formic acid, acetic acid, butyl alcohol, and fermenting banana (table 2).

5. Taste and odor. Without intervening partitions, slightly larger responses were given to odorous substances in solution (table 2).

6. Texture and odor. Moist surfaces of various kinds and inaccessible odorous substances were presented at one time, and these combinations constituted a large number of experiments. The surfaces to which the flies responded were, as shown in table 2, water, clay and water, boiled starch paste, and agar jelly. The odorous substances accompanying these varied the magnitude of the results.

7. Texture, taste, and odor. Finally all the experimental stimuli were allowed to influence the flies at one time. The few substances tried all called forth responses; they were fermenting banana and fresh banana (table 2).

*Summary.* From these experiments it is evident that stimuli may be roughly evaluated according to their ability to induce egg-laying. This may be represented as in table 3.

*Other observations.* The concentration of the odorous substances was found to have no influence upon the response, except where the concentration of a toxic substance was great enough to kill the flies, as ethyl acetate did. When stimulating



substances were diluted many times, no concentration was found low enough to fail to call forth responses, very faint odors having full stimulating value. Thus, flies laid eggs readily in contact with 0.0001 per cent formic acid solution and 0.0003 per cent ethyl alcohol.

Light had no influence upon the response. Experiments with successful stimuli were carried out in the dark, in artificial electric light, in diffuse daylight, and in direct sunlight. Sight plays no part in finding a suitable locality for the deposition of eggs.

TABLE 3

*Summary of non-selective experiments*

KIND OF STIMULUS	SUBSTANCES WHICH CALLED FORTH THE LARGEST RESPONSE	AVERAGE NO. EGGS PER DAY PER FLY
No stimulus . . . . .	dry glass	0.05
Odor . . . . .	acetic acid + alcohol	0.06
Moisture . . . . .	water	0.18
Taste . . . . .	glucose + water	0.20
Odor + taste . . . . .	ethyl ether	0.21
Texture . . . . .	boiled agar	0.77
Texture + odor . . . . .	boiled agar + ethyl alcohol	2.7
Texture + taste + odor . . . . .	fermenting banana	3.3

No observations were made of the acidity and alkalinity of the media upon which the flies laid their eggs. According to Morgan ('15), cultures of fermenting banana become alkaline after ten or twelve days when the flies are breeding upon them. He says "on alkaline food the flies usually refused to lay eggs." The banana media used in the present experiments never became as old as this. Agar is well known to be uniformly alkaline, usually sufficiently so to give a pink color with phenolphthalein (Fellers, '16), yet copious responses were obtained with this medium.

The effect of temperature conditions was not studied, but its general influence is indicated below.

*B. Internal factors*

Experiments with small numbers of flies were undertaken in order to see what prerequisites were necessary for response to appropriate environmental conditions.

1. *Age.* Female flies begin laying eggs about forty-eight hours after emergence from the pupa (Lutz, '14), the time of reaching sexual maturity depending upon the temperature. A large number of experiments were tried with flies of known ages up to twenty-one days. No response was given on the first day, but responses occurred on the second day of adult life, and uniformly throughout the other days. Age therefore has no influence after sexual maturity is reached.

2. *Fertility.* Eggs are produced by flies which have not copulated, but, according to Guyénot ('13, VI), these eggs do not develop. This author ('13, VII) says that mating is a stimulus to egg-laying, with the result that eggs are laid so soon after copulation that they have not been fertilized. This is a clear case of stimulation. No data were obtained by me upon this point, except that two or three females known to be sterile laid no eggs in the first four days after emergence, which supports Guyénot's statement that egg-laying is delayed three to thirteen days by failure to mate.

3. *General activity.* Light is known to be an activating stimulus as well as a directive one in locomotor responses of *Drosophila* (Carpenter, '05). Casual observations indicate that odors and high temperatures are also such kinetic influences, and there may be many more. This energizing is sometimes of a generalized nature, so that all activities are increased by it. Thus Loeb and Northrop ('16) find that the length of the life stages has a temperature coefficient comparable to kinetic activity in chemical reactions. No data are available as to whether the rate of egg-laying is proportional to the speed of other bodily movements.

4. *Nutritive condition.* Guyénot ('13, IV, '13, VI) states that females which have been reared upon a medium poor in nutriment, such as sterile potato, form considerably fewer eggs than

those reared on a completely adequate medium such as yeast. He considers this reduction to depend upon the amount and quality of food.

5. *Periodicities.* Back and Pemberton ('14) find that the melon fly, at intervals of about a week, lays numerous eggs in one day. In *Drosophila* no observations were made upon individual flies throughout a lifetime. There is a distinct tendency, however, for an individual fly to lay several eggs within a few minutes. How often such spasms occur under uniformly stimulating conditions is unknown, but there is certainly no daily or weekly periodicity among different individuals.

6. *Gregariousness.* No difference was found in the responses of flies confined singly or in groups of varying numbers. The presence of male flies had no effect.

7. *Inbreeding.* Castle and his co-workers ('06) and Moenkhaus ('11) show conclusively that no measurable change in the productivity is caused by the continuous mating of offspring of the same parents for many generations. Indeed, the inbreeding standardizes the wide divergence in productivity between different races taken in nature according to the latter author.

8. *Anesthesia.* In the majority of experiments the flies were etherized before being placed under the experimental conditions. Occasionally a single egg was extruded during the excessive activity just preceding the anesthesia. Sturtevant ('15) notes that such an extrusion often occurs at death. Many experiments were performed in which the flies were not etherized or handled in any way. No difference in the responses then could be noted.

*Summary.* The production of eggs within the body of the female fly therefore depends upon such factors as nutrition and vivacity, while their extrusion may be favored by such events as copulation and spasmodic activity of the ovipositing organs.

#### DISCUSSION

The egg-laying response in *Drosophila* may be considered diagrammatically as being caused by a succession of stimuli. The prerequisites are adequate nutrition and sexual maturity, at least. The eggs, having been produced within the body of the

female, are not deposited without the presence of certain sensory qualities, such as touch, smell, and taste. No single quality produces a response at all comparable to the amount of egg-laying in nature; but combinations of moisture, texture, and odor call forth egg-laying of the same magnitude as that under optimum natural conditions. Egg-laying in its nature is a complete response ('all or none'); that is, partial stimulation cannot be measured. A single potent factor in the chain may never lead to the extrusion of eggs. The mechanism is comparable to that of mating, which Sturtevant ('15) describes thus: "Sex recognition at a distance is by smell, but the actual process of copulation depends upon the sense of touch."

The stimuli which produce the egg-laying response are not specific ones for this reaction. Many of the same ones lead the flies to food materials, and Barrows ('07) considers the latter the underlying factor in the tropic response to odorous substances. The odorous substances found to be most attractive in his experiments are also those which produce the largest amount of egg-laying when accompanying conditions are favorable.

The attractiveness of organic compounds is often very specific, as illustrated by the work of Howlett ('15) on the odor responses of several species of melon flies (*Bactrocera*). The males of one species gather with great haste and accuracy to isoeugenol, those of a second species to methyleugenol, those of a third species to both compounds equally. These compounds are found in oil of citronella.

It is well known that the substances attractive to *Drosophila* commonly occur in fruits. Ethyl alcohol is the largest product of yeast fermentation, and acetic acid of bacterial fermentation, which follows yeast fermentation. Amyl acetate has been actually identified in bananas (Kleber, '12), and it is the characteristic ester of pears as well. Grapes are characterized by the presence of ethyl formate. It must be understood that wherever the esters occur, smaller amounts of the corresponding acid and alcohol are present. Many of the acids are not odorous, but all are stimulating to the human sense of taste. Malic acid is the only important acid in bananas (Bigelow and Dunbar, '17),

while succinic and tartaric acids are common in grapes. Sucrose and glucose, which were found stimulating in the present experiments, are known to occur in bananas (Bailey, '06).

Recent studies on the life-cycle of *Drosophila* have revealed the fact that these flies depend in some measure upon the presence of living yeast for their well-being. Guyénot ('07) was the first to recognize this, and only by using dead and autolyzed yeast has he succeeded in rearing *Drosophila* on a sterile medium. Baumberger ('19) has reviewed the literature upon the rôle of yeast, and considers that its relation to *Drosophila* is a loose symbiosis. The influence of this relation upon egg-laying was not studied in these experiments, since the importance of yeast in the life of this fly was not recognized at the time of my experiments. It is evident from the work of Loeb ('15) that yeast induces egg-laying, for he found that the flies laid their eggs readily on filter paper saturated with a solution of sugar and inorganic salts.

#### *Egg-laying responses of other flies*

Because of its economic importance, the house fly has received some attention from experimental workers. The older casual observations have been reviewed by Hewitt ('08), the common conclusion being that the flies prefer horse manure over all things for egg-laying, but will lay upon the excrement of other animals, and upon meat, milk, and other animal and vegetable materials which are undergoing decay. This decay is of course always characterized by the presence of microorganisms.

Richardson ('16) found that the odor of ammonia was the best stimulus for egg-laying in the house fly, but that the response was not complete unless a mass, such as horse manure, was present. Acidified manure, moistened chaff, sawdust, cotton, or filter-paper were not nearly so conducive to egg-laying even with the odor of ammonia near by. A few substances, such as butyric acid and valerianic acid, slightly augmented the efficacy of the ammonia odor.

Similar experiments by Evans ('16) showed that the house fly usually lays eggs only in manure less than one day old, which has the highest ammonia content. He found that the larvae were unable to develop in neutral or acid manure—just the reverse of the acid condition favorable for growth in the fruit fly.

Howlett ('15) has shown that *Sarcophaga* will lay its eggs upon scatol and that *Stomoxys* will lay upon valerianic acid.

#### CONCLUSIONS

1. Single stimuli do not call forth any considerable amount of egg-laying in the female *Drosophila*. When odors and textures are properly combined, the fly may lay nearly as many eggs as when natural conditions prevail. The presence of moisture characterizes all conducive complexes. The most stimulating substances are known to occur in the natural food material of the fly.

2. A slight amount of egg-laying takes place under the simplest conditions that can be presented. The only internal factor of importance is the attainment of sexual maturity. Mating, nutritive condition, and internal periodicities seem to have some influence upon the production of eggs.

3. The rôle of odorous substances as stimuli in egg-laying has been studied quantitatively in detail and the relative values of various substances as stimuli have been compared.

#### BIBLIOGRAPHY

- BACK, E. A., AND PEMBERTON, C. E. 1914 The life history of the melon fly. *Jour. Agr. Res.*, vol. 3, pp. 269-274.  
1915 a Susceptibility of citrous fruits to the attack of the Mediterranean fruit fly. *Jour. Agr. Res.*, vol. 3, pp. 311-330.  
1915 b Life history of the Mediterranean fruit fly from the standpoint of parasite introduction. *Jour. Agr. Res.*, vol. 3, pp. 363-374.
- BAILEY, E. M. 1906 Studies on the banana. *Jour. Biol. Chem.*, vol. 1, pp. 355-361.
- BARROWS, W. M. 1907 The reactions of the pomace fly, *Drosophila ampelophila* Loew, to odorous substances. *Jour. Exp. Zoöl.*, vol. 4, pp. 515-537.
- BAUMBERGER, J. P. 1919 A nutritional study of insects, with special reference to microorganisms and their substrata. *Jour. Exp. Zoöl.*, vol. 28, pp. 1-81.
- BIGELOW, W. D., AND DUNBAR, P. B. 1917 The acid contents of fruits. *Jour. Indus. Engin. Chem.*, vol. 9, pp. 762-764.

- CARPENTER, F. W. 1905 The reactions of the pomace fly (*Drosophila ampelophila* Loew) to light, gravity, and mechanical stimulation. *Amer. Nat.*, vol. 39, pp. 157-171.
- CASTLE, W. E., CARPENTER, F. W., CLARK, A. H., MAST, S. O., AND BARROWS, W. M. 1906 The effects of inbreeding, cross-breeding, and selection upon the fertility and variability of *Drosophila*. *Proc. Amer. Acad. Arts and Sci.*, vol. 41, pp. 731-786.
- EVANS, A. T. 1916 Some observations on the breeding habits of the common house-fly (*Musca domestica* L.). *Jour. Econ. Entom.*, vol. 9, pp. 354-362.
- FELLERS, C. R. 1916 The analysis, purification and some chemical properties of agar agar. *Jour. Indus. Engin. Chem.*, vol. 8, pp. 1128-1133.
- GUYÉNOT, E. 1907 L'appareil digestif et la digestion de quelques larves de mouches. *Bull. sci. France et Belgique*, T. 41, pp. 353-370.
- 1913 Études biologiques sur une mouche, *Drosophila ampelophila* Löw. *C. r. soc. biol. Paris*, T. 74:
- I. Possibilité de vie aseptique pour l'individu et la lignée, pp. 97-99.
- IV. Nutrition des larves et fécondité, pp. 270-272.
- VI. Résorption des spermatozoïdes et avortement des oeufs, pp. 389-391.
- VII. La déterminisme de la ponte, pp. 443-445.
- HEWITT, C. G. 1908 The structure, development, and bionomics of the house-fly, *Musca domestica*, Linn. Part II. The breeding habits, development, and the anatomy of the larva. *Quart. Jour. Micr. Sci.*, vol. 52, pp. 495-545.
- HOWLETT, F. M. 1915 The chemical reactions of fruit-flies. *Bull. Entom. Res.*, vol. 6, pp. 297-306.
- KLEBER, C. 1912 The occurrence of amyl acetate in bananas. *American Perfumer*, vol. 7, pp. 235-236.
- LOEB, J. 1915 The simplest constituents required for growth and the completion of the life cycle in an insect (*Drosophila*). *Science*, vol. 41, pp. 169-170.
- LOEB, J., AND NORTHROP, J. H. 1916 Is there a temperature coefficient for the duration of life? *Proc. Nat. Acad. Sci.*, vol. 2, pp. 456-457.
- LOWNE, B. T. 1890 *The blowfly*, 2 vols.
- LUTZ, F. E. 1914 Biological notes concerning *Drosophila ampelophila*. *Jour. N. Y. Entom. Soc.*, vol. 22, pp. 134-138.
- MOENKHAUS, W. J. 1911 The effects of inbreeding and selection on the fertility, vigor and sex ratio of *Drosophila ampelophila*. *Jour. Morph.*, vol. 22, pp. 123-154.
- MORGAN, T. H. 1915 The rôle of the environment in the realization of a sex-linked Mendelian character in *Drosophila*. *Amer. Nat.*, vol. 49, pp. 385-429.
- RICHARDSON, C. H. 1916 A chemotropic response of the house fly (*Musca domestica* L.). *Science*, vol. 43, pp. 613-616.
- STURTEVANT, A. H. 1915 Experiments on sex recognition and the problem of sexual selection in *Drosophila*. *Jour. Animal Behav.*, vol. 5, pp. 351-366.

Resumen por el autor, G. H. Parker,  
Universidad Harvard.

## Actividades de los animales coloniales.

### I. Circulación del agua en Renilla.

Renilla amethystina se contrae enterrándose en la arena, en su habitat natural, cuando baja la marea y se extiende saliendo de la arena cuando la marea sube. Al contraerse su volumen puede disminuir en un 88 por ciento a consecuencia de la expulsión del agua. El agua del mar entra en Renilla por los sifonozoides laterales y probablemente también en pequeñas cantidades por los autozoides, que indudablemente sirven para la entrada del alimento. No penetra por el sifonozoide axial o por el poro terminal del pedúnculo. El agua sale del cuerpo de Renilla por el sifonozoide axial, que la expulsa normalmente de vez en cuando. A gran presión el agua puede salir también por los sifonozoides laterales, los autozoides y aun por el poro terminal del pedúnculo. Dentro del cuerpo, el agua que entra por los sifonozoides laterales se acumula en el canal inferior del raquis y pasa desde este al canal superior por medio de orificios muy pequeños situados en el septum peduncular y de este modo menos directamente pero con mas libertad al sifonozoide axial. El agua entra en la colonia por la acción probablemente ciliar de los sifonozoides laterales y es expulsada por la contracción muscular general.

Translation by José F. Nonidez  
Cornell Medical College, New York



## ACTIVITIES OF COLONIAL ANIMALS

### I. CIRCULATION OF WATER IN RENILLA<sup>1</sup>

G. H. PARKER

ONE TEXT FIGURE AND ONE PLATE (FOUR FIGURES)

#### INTRODUCTION

Although much attention has been devoted in the last few decades to the movements, reactions, and other activities of single individual animals among the coelenterates, such, for instance, as the sea-anemones and the jelly-fishes, very little effort has been directed toward the study of colonial forms, like the corals and the hydroids. At present it is quite impossible to state with any degree of certainty how, from the standpoint of functional interdependence, the individual zoöids in such a colony are related to the colony as a whole. For the solution of a question of this kind a well-circumscribed aggregate of large zoöids is needed. Such a condition is to be met with in the sea-pen, *Renilla*. The zoöids in this genus are relatively large, and the whole colony, though anchored in the sand, can be removed without damage and readily subjected to experimental study.

This genus, though restricted to the warmer seas, is distributed very widely within such limits. One of its largest species is *Renilla amethystina* Verrill, a form very abundant in the shallow waters about San Diego, California. This species was chosen for experimental investigation, and all the material used in this work was collected near the outlet of False Bay in the vicinity of La Jolla, California. I am under obligations to Dr. W. E. Ritter, Director of the Scripps Institution for Biological Research at La Jolla, for the opportunity of carrying out this work, and I am indebted to the staff of that institution, especially to the collector,

<sup>1</sup> Contributions from the Zoölogical Laboratory of the Museum of Comparative Zoölogy at Harvard College, no. 323.

Mr. P. S. Barnhart, for much help given me while I was working there.

*Renilla amethystina* was described originally by Verrill ('64 a, p. 29), and the group to which it belongs was subsequently monographed by Kölliker ('72). A detailed account of the structure and habits of *Renilla amethystina* was published by Eisen in 1876, and the development of the closely allied species, *Renilla reniformis*, was investigated with great fullness by Wilson ('83). Musgrave's experimental studies on living sea-pens appeared in 1909. Ten years later I published a brief account of the organization of *Renilla amethystina* based upon the study of the few specimens of this species available at La Jolla in 1916. In a measure this communication is a preliminary to the present investigations, which were carried out on much more abundant material in 1919 and which I shall present in two papers, the first dealing with the circulation of water in the colony and the means of expansion and contraction.

#### GENERAL HABITS OF RENILLA

The majority of sea-pens are elongated colonial organisms, one portion of whose axis, the stalk or peduncle, anchors the colony in the mud or sand of the sea bottom, while the other portion, the rachis, is held above the sea bed and carries the polyps. *Renilla* is peculiar in that its peduncle is a relatively soft, fleshy structure without an axial skeleton, and its rachis is spread out laterally at right angles to the axis of its peduncle. When in its natural position the peduncle of *Renilla* is sunk vertically in the sand on the surface of which the rachis rests horizontally. The rachis is a kidney-shaped or heart-shaped structure whose indentation marks the region at which the peduncle is attached. The lower surface of the rachis, that next the sand, is devoid of polyps, all of which are limited to the upper surface. In consequence of comparison with other sea-pens, some confusion exists in the various accounts as to the proper designations to be used for the two surfaces of the rachis of *Renilla*. In the older terminology for the sea-pens, that surface which carried the zooids was called ventral, the opposite one dorsal. Accordingly, in *Renilla* the

upper surface as the colony rests on the sand would be ventral, the lower dorsal, a perversion that recent writers have been disinclined to follow. To avoid confusion in this respect, I shall, therefore, not use the terms dorsal and ventral, but I shall call the surface of the *Renilla* rachis that is uppermost in the resting position and that carries the zoöids superior and the opposite one inferior.

*Renilla amethystina* is commonly found in sand banks between high and low tide. When such a bank that has been covered for some time with a foot or so of water is closely examined, many of the heart-shaped colonies of this species will be discovered fully expanded and spread out upon the surface of the sand (fig. 1). In *Renilla amethystina* the maximum diameter of the colony may reach 8.5 cm. and the largest zoöids may rise from the surface of the rachis to the height of 5 or 6 mm. Notwithstanding the fact that *Renilla* is so bright a purple as to justify the popular name of sea-pansy, the colony in its resting position is so commonly covered with a thin layer of sand as to make it easily overlooked. This peculiarity is enhanced by the fact that the zoöids, which are almost always well above the level of the sand, are transparent or at most slightly grayish in tint.

As the tide recedes *Renilla* contracts and withdraws gradually into the sand so that with the disappearance of the last of the water the animal leaves a mark on the sand not unlike that of a miniature horseshoe (fig. 2). These marks serve as sure indications to the collector of the presence of *Renilla*. They are quickly obliterated by the returning tide, whereupon *Renilla* reexpands to assume the form already described. These tidal responses were observed as early as 1864 by Fritz Müller.

The expansion and contraction of *Renilla* is accomplished, as might be expected, by taking in and discharging sea-water. Louis Agassiz ('50, p. 208) long ago observed that an expanded *Renilla reniformis* might thus temporarily have a diameter double that of its contracted state, and the same seems to be true of *Renilla amethystina*. A specimen of this species (fig. 3), whose rachis when fully expanded had a diameter of 6.5 cm. was made to contract completely (fig. 4), after which its diameter was found

to measure 3.2 cm. Before contraction its volume was 27 cc. and after contraction this had been reduced to 3.2 cc. through the discharge of 23.8 cc. of water—a reduction of over 88 per cent of its volume. This very considerable change of form and volume was early observed by Müller ('64, p. 353), who pointed out its importance in specific descriptions in this genus. The complete contraction of a fully expanded *Renilla* may be accomplished under special stimulation in a minute or so. Its expansion, which necessitates that it shall refill itself with water, requires at least half an hour.

Under natural conditions probably the majority of *Renillas* expand and contract as already indicated with the flowing and ebbing of the tide. Specimens kept in sand-filled aquaria in the laboratory, however, even though continually under water, will at times contract, bury themselves in the sand, and remain thus hidden for considerable periods. In one instance a *Renilla* retreated under the sand and remained quiescently there for three and a half days, whereupon it was dug out and placed in seawater. It then inflated itself and acted in other respects entirely normally. It is therefore possible for *Renilla* to remain contracted and quiescent for considerable periods, though this is probably not often the case under natural conditions.

#### INCURRENT AND EXCURRENT APERTURES

By what apertures water enters and leaves the body of *Renilla* is by no means certain. Even the number of kinds of openings in the body of this animal is still in dispute. At most four sets of such apertures have been distinguished. There are, first, the autozooids, or ordinary polyps, generally scattered over the superior surface of the rachis. Each of these zooids is provided with a mouth, which Agassiz ('50, p. 209) regarded as the chief means of entrance and exit of water for the colony as a whole. Next there are found among the autozooids and imbedded in small masses of whitish materials groups of pores each one of which represents the mouth of a lateral siphonozooid. These siphonozooids were originally described by Verrill ('64 b, p. 12) as rudimentary individuals. According to Wilson ('83, p. 725),

they are the chief inlets for *Renilla*, but Musgrave ('09, p. 472) regards them both as inhalent and exhalent apertures. The third kind of opening is a well-defined pore, the axial siphonozooid. This lies on the superior surface of the rachis near its center and at the end of a smooth tract of integument that starts from the root of the peduncle. This pore was first recorded by Müller (64, p. 354), who regarded it as the chief inlet and outlet for water in *Renilla*. Wilson ('83, p. 725), on the other hand, designated it as the exhalent zooid for the colony. It probably corresponds to the group of four pores in the axis of the dorsal face of the rachis of *Pennatula* mentioned by Musgrave ('09, p. 454). Finally, there remains the problematic terminal pore supposed to be present at the distal end of the peduncle and regarded by various investigators as an inlet or an outlet aperture. These four classes of openings may now be considered in the order named.

#### *The autozooids*

The true polyps or autozooids of *Renilla*, as already stated, are disposed upon a somewhat irregular radial plan over the superior surface of the rachis of this animal. Near the center of the rachis they are relatively large and, when fully expanded, they may measure as much as 6 mm. in height. Toward the outer edge of the rachis they become smaller and more numerous.

Each autozooid carries at its distal end eight pinnate tentacles surrounding an elongated slit-like mouth. One autozooid lies in the axis of the rachis and opposite the peduncle from the axial siphonozooid. This autozooid, as has been shown by Wilson ('83) represents the original polyp produced from the egg, from which the remaining polyps of the colony have been formed by budding. The axis of the mouth of this autozooid agrees in direction with that of the colony as a whole. Those of the mouths of the other autozooids are in a similar manner in line with appropriate lateral axes. Marshall ('83, p. 140) showed that in the lateral autozooids of the sea-pens the angle of the mouth that was turned away from the chief colonial axis, the abaxial angle, leads into a ciliated groove, the sulcus or siphonoglyph,

whose cilia lash inward and might therefore be expected to carry water into the colony. In a corresponding fashion the axial angle of the mouth leads to a pair of mesenteric filaments whose cilia beat outward. Thus the autozooids are so organized that they might well serve as a means for the entrance and exit of water for the colony as a whole, as originally maintained by Agassiz ('50, p. 209) for *Renilla* and as has recently been claimed by Musgrave ('09, p. 472) for sea-pens in general.

To what extent the autozooids of *Renilla* can serve the colony for the entrance and escape of water may be inferred from the following observations and tests. Wilson ('83, p. 728) noticed that in *Renilla reniformis* the eggs and sperm were discharged through the mouths of the autozooids. The same is true of *Renilla amethystina*. In the early part of August, 1919, many females of this species were found to be spawning. From time to time an egg was seen to rise through the oesophagus of an autozooid and to shoot from its mouth into the surrounding sea-water. The time required for the passage of the egg through the length of the zooid and for its discharge to the exterior was about fifteen seconds. As the egg first came into sight at the base of the zooid it was spherical in form and its upward motion was relatively slow. After it had passed the middle of the zooid, its rate quickened and it became elongated in form, its long axis corresponding to that of the zooids. It emerged from the mouth as though forced out under pressure, suggesting a sphincter-like action for the distal half of the zooid. The whole operation gave the impression of a process under the control of cilia which were less effective in the proximal than in the distal half of the zooid, where the egg appeared to be under some pressure very likely of a muscular origin. The cilia most probably concerned in this operation are those of the mesenteric filaments, which, as already stated, are believed to beat toward the exterior.

In a similar way feces were seen from time to time to be discharged from the mouths of the autozooids. If a fairly thick mixture of carmine and sea-water or of india ink and sea-water is injected into the central spaces of the colony, in about an hour thereafter long, thin, vermiculate lines of red or black material,

in accordance with the injection used, were slowly discharged from the mouths of many of the autozoöids.

If a strong solution of methylen blue in sea-water is injected into an expanded *Renilla*, in a very few minutes the colored fluid may be seen in one or more of the eight mesenteric chambers of the autozoöids and even in the tentacles connected with these chambers, and in a very short time the solution may be discharged as a blue cloud from the mouths of these zoöids. These several lines of observation make it perfectly clear that the autozoöids of *Renilla* may discharge from the colony to the exterior both solids and fluids.

In a similar way inward movements may be demonstrated in these zoöids. If a very small piece of crab meat is dropped on the mouth of an expanded autozoöid, the tentacles quickly close over it and it is passed into the oesophagus. The distal half of the zoöid then contracts slowly but vigorously like a sphincter, and the bit of meat passes very gradually through the proximal half of the zoöid till, in about five minutes after it was placed on the lips, it disappears in the depths of the animal. After this disappearance the zoöid gradually elongates and assumes its normal proportions. The operation in this instance, like that in the discharge of eggs, feces, etc., appears to depend upon ciliary action, but whether in *Renilla*, as in the sea-anemones, the movement is due to a reversal of the usual outward stroke of the cilia in the region of the lips or whether the food is swept in by the normal action of the cilia of the sulcus could not be ascertained. In any event the autozoöid of *Renilla* can carry solid material inward as well as outward through its oesophagus.

If the distal end of an autozoöid of *Renilla* is flooded with carmine or methylen blue in sea-water, it should be easy to see whether inhalent or exhalent currents are normally present. As a matter of fact, all tests of this kind failed to demonstrate under ordinary circumstances any currents either outward or inward at the mouth of the autozoöid. If under such circumstances the distal end of a zoöid is quickly cut off by a single stroke of a pair of fine scissors, a momentary outward gush of water takes place, during which the beheaded polyp contracts. Presently it re-

expands with its distal wounded end fully distended and closed as by a puckering string,—further evidence of the sphincter-like action of the distal half of the zoöid. All these operations occur in such a way that it is clear that the fluid inside the colony is ordinarily under a slight continuous pressure. Nevertheless, both methylen blue and carmine gave under ordinary conditions not the least evidence of water currents emerging from the mouths of the autozoöids or entering them, and I am forced to conclude that while the autozoöids of *Renilla* are effective means of introducing solid materials into the colony and of discharging like substance from it, they play no important part in the exchange of sea-water whereby the colony as a whole expands or contracts. Under considerable and unusual pressure they may aid somewhat in the discharge of water, but even in this respect they are certainly insignificant in their action as compared with other structures to be considered presently. So far as sea-water is concerned, they are, in my opinion, neither the chief inlets or outlets of the colony (Agassiz, '50, p. 209) nor even subordinate ones (Musgrave, '09, p. 472).

#### *The lateral siphonozoöids*

Scattered irregularly among the autozoöids of *Renilla* are groups of small whitish bodies, the lateral siphonozoöids, first clearly recognized by Verrill ('64 b, p. 12). Each group consists of a variable number of pores, the lips of which exhibit, as a rule, eight lobes, thus indicating that each pore represents a single zoöid. Not infrequently pores are met with whose size and structure suggest that they may be aborted autozoöids, but even in the extremes of these cases the whole body has a greater resemblance to a siphonozoöid than to an autozoöid, and since actual transitional forms between the two kinds have never been found, it is probable that in *Renilla* the two classes, the autozoöids and the siphonozoöids, are entirely distinct.

Each siphonozoöid pore is surrounded by a ring of whitish substance, in color and texture like that at the base of the autozoöids, and the whole group of siphonozoöids is set in a field of



yellowish crystalline material. If finely divided carmine in sea-water is flooded over the surface of an expanded *Renilla*, sooner or later much of it will be found to have collected at the pores of siphonozooids. And if such a preparation is closely watched under a hand lens, very small pieces of carmine will often be seen darting into the siphonozooid pores. If a piece of the superior surface of the rachis is separated from the rest of the colony by a cut approximately parallel to that surface, and if the spaces connected with the siphonozooids and exposed on its under face are closely watched, small carmine particles are seen to shoot out from these spaces and into the surrounding sea-water. As such preparations show, the siphonozooids ordinarily conduct water from the exterior to the interior and such currents are generated within the siphonozooid itself. The currents are without doubt the results of ciliary action.

Not infrequently siphonozooids will be found in which no currents can be demonstrated. If these are watched for a time, currents will sooner or later be seen in them, the whole condition recalling strikingly that of the lateral pores of sponges whose currents, though produced by the flagellated cells, are controlled by the sphincters or other like devices which close and open these pores. In my opinion, the siphonozooid currents in *Renilla* are controlled by some such device.

If methylen blue in sea-water is injected under pressure into the internal spaces of a living *Renilla*, small amounts of this fluid will be seen oozing from a few of the siphonozooids. If the peduncle of a *Renilla* is cut open and a vertical glass tube tied securely into the cut, the end of the tube and the animal being under sea-water, it will be found that a pressure of some 5 or 6 cm. of water is necessary to drive a methylen-blue solution through the siphonozooid pores to the exterior. This pressure may be taken, therefore, as the pressure necessary to counteract that by which the siphonozooid currents are produced. The escape of methylen-blue solution thus brought about at the siphonozooids is never very general and never large in amount. It indicates that the siphonozooid pores are not provided with any effective valve-like parts whereby the currents are limited in

direction and that, while the currents naturally set in through the siphonozooids with great freedom, they take the opposite course, only under considerable stress as though they were working against the natural mechanism of the pore. A close and often repeated inspection of the siphonozooids of *Renilla* when in a normal resting state failed to elicit the least evidence of natural currents running through these apertures in an outward direction. No carmine particles were ever seen wafted outwardly from these zooids and methylen-blue solutions were never observed to be swept away from them. Excepting under an internal pressure of 5 or more cm. of water, I have never seen anything emerge from the siphonozooid pores. This condition is probably associated with the fact, long ago pointed out by Wilson ('84, p. 18), that in *Renilla* the siphonozooids are devoid of dorsal mesenteric filaments and hence produce no outward currents, their single ciliated organ being a siphonoglyph, by which water is carried inward. In many pennatulids the siphonozooids possess dorsal mesenteric filaments (Lightbown, '18) as well as siphonoglyphs, and may therefore exhibit exhalent as well as inhalent activities. This condition probably explains the difference between my observations and those of Musgrave ('09, p. 455), who found in the siphonozooids of *Pennatula* good evidence for excurrent as well as incurrent action, whereas in *Renilla* I found no trace of excurrents whatever. My observations completely confirm Wilson's statement ('83, p. 725) that the siphonozooids of *Renilla* are the chief inhalent apertures for the colony.

*The axial siphonozooid.*

This large zooid in the chief axis of the *Renilla* colony and near the center of its rachis was shown Müller ('64, p. 345) by his little daughter, who saw a jet of water spurt out of it when she picked up a living *Renilla* from the sea. This observation can be confirmed by anyone to whom living material is available. On taking up an inflated specimen, contraction at once occurs and water is discharged in the form of a fine jet from the axial siphonozooid. The same form of discharge can be observed in animals

under water. If an inflated *Renilla* in a basin of sea-water is touched slightly or the whole basin jarred, contraction begins, the membranous edges of the axial siphonozoöid withdraw, leaving the aperture freely open, through which emerges a jet of water strong enough to ruffle the surface of that in the basin. If a number of expanded *Renillas* are watched in a shallow aquarium, one or other of them will be seen to contract from time to time—an operation that is invariably accompanied by the opening of the pore of the axial siphonozoöid and the free discharge of water through it.

The internal pressure necessary to bring about the opening of this pore may be tested in the following way: if a vertical glass tube be tied securely into the superior canal of the peduncle of a submerged *Renilla*—a canal that leads directly to the inner end of the axial siphonozoöid—and the tube be filled with a solution of methylen blue in sea-water, it can be shown that the axial pore will not open till the internal pressure has reached 20 to 25 cm. of water. Since this canal communicates not only with the axial pore, but also with the pores of the lateral siphonozoöids, this experiment is always accompanied with the oozing of the methylen-blue solution at these pores, but even under the high pressure used this is never profuse, and it is very probable that the recorded pressures of from 20 to 25 cm. of water represent the real pressures necessary to open the axial pore. It is thus clear that a much higher pressure is needed to open this pore than to reverse the currents of the lateral siphonozoöids, but it is also clear, since the volume of the colony does not begin to show an appreciable diminution till the axial pore is opened, that the lateral siphonozoöids are of no great significance in discharging water from the colony as a whole. This conclusion is supported by the observation that when a *Renilla* begins to contract, methylen-blue solutions or carmine discharged over the superior face of its rachis give no evidence of outward currents from the pores of the lateral siphonozoöids or from the mouths of the autozoöid. If, under such circumstances, water does escape through these apertures, it must be very small in amount.

Repeated tests with carmine and with methylen blue of the axial siphonozoid in resting Renillas failed invariably to give any evidence of inward currents, and the same was true of individuals that were in process of inflation. I, therefore, cannot agree with Müller ('64, p. 354) in regarding this aperture as an inlet, though I fully concur in his opinion that it is an outlet, and from the abundance and freedom of its discharge I believe Wilson ('83, p. 725) to be correct in regarding it as the chief exhalent aperture of Renilla.

*The terminal pore of the peduncle*

The question of the presence of a terminal pore at the distal end of the peduncle of the sea-pen has been a matter of much dispute. The historical aspect of this subject has been well summarized by Musgrave ('09, p. 443). To some of the older naturalists, who regarded the sea-pens as single animals, the terminal pore of the peduncle appeared to be the mouth of the animal. To others its very existence was doubted. Müller ('64, p. 357) claimed that there was a pore at the tip of the peduncle of Renilla, and a similar condition was reported by Schultze ('64, p. 360) for Pennatula. Kölliker ('72, p. 86) was unable to confirm these findings on alcoholic material, but in fresh specimens of Renilla amethystina Eisen ('76, p. 13) demonstrated a terminal pore by pressing the fluid contents of the peduncle till they spurted from the tip of that structure. Musgrave ('09, p. 452) has given very conclusive evidence for the presence of a group of pores about the distal end of the peduncle of Pennatula. These pores, she believes ('09, p. 457), may serve both as inhalent and exhalent apertures. Thus the later evidence very generally favors the view that the sea-pens, including Renilla, possess terminal pores on the peduncle.

My own experience agrees very fully with that of Eisen. Although I have picked up many hundreds of inflated Renillas and have many times seen the jet of water issue from the axial siphonozoïd, I have never once seen under such circumstances water spurt from the tip of the peduncle—a condition that led me in the beginning to doubt the existence of a terminal pore.

Only when the peduncle is pinched between the fingers does a fine jet of water issue from its tip. Hence it is necessary to consider whether this aperture is due to artificial rupture or is a natural one and, if it is such, whether it is an exhalent or inhalent aperture.

To determine whether or not a natural pore exists at the tip of the peduncle of *Renilla*, the following tests were made. In ten fresh, vigorous animals the peduncle was pinched between the fingers till a jet of water appeared and the exact point of issuance was then noted. In six instances the jet issued with great regularity at the very tip of the peduncle. In two of the ten specimens two jets appeared one at the tip and the other on the side of the peduncle, but near the tip. In the remaining two the jets were from the side. In all instances the lateral jets were less regular than the terminal ones, as though the lateral jets issued through small ruptures and the terminal ones through a natural pore.

Peduncles from ten fresh animals were then cut off and put in sea-water to which was added some magnesium sulphate. After three hours these peduncles were attached at their cut ends one by one to the tip of a vertical glass tube which was made to dip under the surface of a bowl full of sea-water. Sea-water colored with methylen blue was then run into the tube till it issued through the peduncle. In six instances it emerged through the exact tip of the peduncle in a very thin well-defined stream and when the column of colored water in the tube showed a height of from 12 to 15 cm. In the four remaining peduncles it emerged as an irregular stream in each case from the side of the given peduncle.

Normal peduncles, unanesthetized with magnesium sulphate, were then tried in the same way. In the most resistant of these the colored water flowed from the tip of the peduncle when the fluid in the tube reached the height of 115 cm. and continued to flow till it fell to 40 cm., when the opening closed. In the least resistant the flow began at 80 cm. of water pressure and was checked at 20 cm. These observations, like those based on the position of emergence of the jets, favor the view that in *Renilla* there is a natural terminal pore on the peduncle.

Although it may be possible that there are individual differences in *Renilla* and that some specimens possess terminal peduncle pores and others do not, it seems to me more probable that such pores are characteristically present and that they open normally only under considerable internal pressure such as is represented by a column of sea-water approximately a meter in height—a pressure that may at times rupture the wall of the peduncle laterally rather than force open the pore.

Aside from the discharge of sea-water under unusual pressure, I have never seen any evidence that the terminal pore of the peduncle is an exhalent aperture. In all experiments with *Renilla* in which carmine or methylen blue have been used I have never observed anything that led me to suppose that water was being discharged from this pore. When a fully inflated peduncle on a living *Renilla* is quickly and completely ligated about midway its length and it is thus left distended and still attached to the colony, it will retain its inflated condition unchanged for hours, though when a small hole is made in it by the prick of a pin it collapses at once. I therefore believe it improbable that the terminal pore of the peduncle serves as an exit for water except under very unusual pressure.

The opinion that it is an inhalent aperture is still more problematical. I have repeated on *Renilla* Musgrave's experiment ('09, p. 456) on *Pteroides* in which the peduncle of this animal was immersed in a colored fluid. A deeply colored solution of methylen blue in sea-water was prepared and four narrow-necked flasks were filled with it. Into the neck of each flask the peduncle of a *Renilla* was inserted the rachis of the animal resting on the edges of the mouth of the flask. Each flask with its contained fluid and *Renilla* was then cautiously sunk in a vessel of sea-water so as to cause as little mingling of the methylen-blue solution and the sea-water as possible. After the preparations had been standing ten hours the *Renillas* were removed, rinsed gently, and their peduncles examined. The outer surfaces of these parts were stained deep blue, but, contrary to the results obtained by Musgrave on *Pteroides*, no blue fluid or blue staining could be found inside the peduncles, showing that the terminal pore had not served as an inlet.

Six specimens of *Renilla* were allowed to discharge their contained water, and their peduncles were firmly ligated at about midlength. Thus the distal half of the peduncle, though still connected with the rest of the colony by its wall, had its communication with the colony by its canals cut off. These specimens were then returned to sea-water to determine whether the distal portions of the peduncles could refill themselves. After twelve hours they were as unfilled as at the beginning of the experiment. After twenty-four hours two of the six had filled, but on cutting these from the colony in the region just proximal to that at which they were tied, they quickly emptied themselves by discharging their fluid contents at the cut end, showing that in these two instances the ligatures had failed to hold. In the four empty peduncles no such looseness was observable. This experiment was repeated on another set of ten animals and with similar results. For some time none of the peduncles filled, but after thirty hours three of them were found distended, and in all of these the ligatures had loosened. Apparently the peduncle, which is a highly muscular tube, is extremely difficult to ligate under water and by its continued activity eventually slightly loosens ligatures that under ordinary circumstances would have held.

The results of the experiments in ligating peduncles and in sinking them into colored fluid, in both of which the peduncles failed to fill themselves from the outside, lead to the conclusion that the terminal pore of that structure is not to be regarded as an inlet for sea-water. This conclusion accords with the fact that a *Renilla* immediately after its peduncle has been firmly ligated will fill itself with sea-water long before the ligature could have worked loose even to a small degree. Although I am convinced that the peduncle of *Renilla* possesses a terminal pore, I do not believe that it possesses inhalent and exhalent functions such as have been found by Musgrave ('09, p. 471) for the corresponding openings in other sea-pens. In *Renilla*, so far as I can judge, the terminal pore is at best an outlet opening serviceable only under excessive pressure.

*Summary*

From what has been stated in the preceding sections it appears that in a normally quiescent *Renilla* sea-water is entering the colony almost exclusively through the pores of the lateral siphonozooids. A small amount may enter through the mouths of the autozooids, but this at most must be very insignificant. There is no reason to suppose that water enters the colony through any other openings. In a quiescent colony water from time to time passes out through the pore of the axial siphonozooid, and this is apparently the only method of exit under ordinary circumstances. Possibly an insignificant amount of water may pass out by the mouths of the autozooids. If for any reason the fluid pressure within the colony becomes high, the currents of the lateral siphonozooids may reverse and a small amount of water may escape through the pores of these zooids. If the pressure increases still more, the terminal peduncle pore may eventually open and discharge. Such, however, would probably occur only under extreme pressure. In ordinary conditions the whole inflow of water is through the lateral siphonozooids and the whole outflow through the axial siphonozooid—a view long ago clearly set forth by Wilson ('83).

## THE COURSE OF THE WATER WITHIN THE BODY OF RENILLA

The course of the water within the *Renilla* colony is dependent upon the system of canals within this animal. Agassiz ('50, p. 208) noted that both the peduncle and rachis of *Renilla* were more or less hollow and that their cavities communicated, and Verrill ('64, b, p. 12) was the first to recognize that the peduncle contained two canals each of which opened into extensive spaces in the rachis. Kölliker ('72, p. 85) showed that of these two canals one was superior in position and the other inferior and that the two communicated with each other near the distal end of the peduncle. Eisen ('76) confirmed these various statements and demonstrated further that the superior canal led directly to the pore of the axial siphonozooid. He also claimed ('76, p. 12) that in the region of the rachis the peduncle of *Renilla* possessed four



canals, two lateral ones in addition to the two characteristic of the peduncle. Wilson ('83, p. 726) corroborated all of Eisen's statements except that concerning the presence of the four canals, and showed that, although the superior canal of the peduncle communicated directly with the pore of the axial siphonozooid, it was also connected with the cavities of the polyps as was the inferior canal. Much of this freedom of internal communication was demonstrated through injection by Musgrave ('09, p. 448) in the several sea-pens investigated by her.

In *Renilla amethystina* I studied the system of internal canals chiefly by means of injections. Two types of injecting fluids were used: first, solutions such as methylen blue in sea-water and, second, finely divided solids such as india ink in sea-water. The first kind would naturally pass through very minute apertures, the second only through those of a larger size. The injecting was accomplished under the pressure of a column of water, 10 to 15 cm. of which was usually found to be sufficient to drive the fluid forward.

If the peduncle of a *Renilla* is cut off close to its attachment to the rachis and the cannula of the injection tube tied firmly into the superior canal, the inferior canal being slit open throughout most of its length, it requires only a few centimeters of pressure to drive either a methylen-blue solution or an india-ink suspension down the length of the superior canal and through the numerous apertures of the septum between the two canals into the open inferior canal.

If, now, an additional ligature is applied to such a preparation at a point about one-quarter of the length of the peduncle from its tip, thus excluding this distal quarter from participating in the flow of the injection fluid, the fluid not only fills the remainder of the superior canal, but also flows over into the inferior one. On applying a third ligature to the peduncle about midway its length, it was found that, though the superior canal filled, neither the methylen-blue solution nor the india-ink suspension passed into the inferior canal. Hence it must be concluded that the pores in the peduncular septum by which the superior canal communicates with the inferior must be limited to about the distal

half of this structure. When the cannula of the injection tube was tied into the superior canal of the distal quarter of the peduncle, the same freedom of communication between the two canals was demonstrated as when it was tied into the proximal end of the peduncle. It is, therefore, evident that the pores of the septum occur not only in the distal half of this structure, but also in its distal third and fourth quarters. They probably form a more or less continuous series in this region.

If the converse of the preceding experiments is tried, in that the injections are made into the inferior canal and the superior canal is cut open, fluid flows freely from the inferior into the superior canal, and it is fair to conclude that the pores in the septum between these canals are unprovided with valves that limit the direction in which fluid may pass. In the peduncle, then, the septum between the superior and inferior canal is impervious to injection fluids in the proximal half of its extent and freely pervious in its distal half. In this half the pores must be relatively large, for such coarse material as india ink is freely transmitted.

As Agassiz ('60, p. 208) long ago pointed out, the canals of the peduncle communicate freely with the spaces in the rachis. In all my work on the canals in the rachis of *Renilla* I have failed to find more than extensions and ramifications of the two canals of the peduncle of that sea-pen, and I am, therefore, unable to confirm Eisen's declaration ('76, p. 12) that where the peduncle joins the rachis in *Renilla* there are four canals, a number agreeing with that reported in the peduncles of many sea-pens. As I have worked upon the same species of *Renilla* that Eisen did, I suspect that in this particular his account is inaccurate.

If the peduncle of a *Renilla* is cut across about midway on its length and the injection cannula tied into the superior canal of the part which is still connected with the rachis, an india-ink injection can be made to flow through the superior canal and out at the pore of the axial siphonozooid. The injection, as a rule, will not spread further. If methylen blue is used, a much more general injection is obtained. The methylen-blue solution flows first into the intermesenteric chambers of certain autozooids,

then oozes through some of the siphonozoöid pores, then discharges from the pores of the axial siphonozoöid, as the india ink did, and finally escapes from the mouths of some of the autozoöids. The conclusion to be drawn from these results is that the superior canal connects freely and directly with the opening of the axial siphonozoöid, as was first shown by Eisen ('76) and was subsequently confirmed by Wilson ('83), and that, contrary to my former opinion ('19, p. 503), it likewise connects, though very much less freely, with the autozoöids and siphonozoöids as maintained also by Wilson ('83).

When a corresponding form of injection is carried out on the inferior canal of the peduncle, a solution of methylen blue yields exactly the same results as when it is injected into the superior canal. India ink, however, remains limited to the inferior canal and only gradually makes its way out the mouths of some of the autozoöids. It fails entirely to reach the siphonozoöids or the axial pore. It is thus shown that the inferior canal in the rachis has freer communications with the autozoöids than with the lateral or axial siphonozoöids.

That the superior and inferior canal systems communicate in the rachis is not only proved by the results given in the preceding paragraphs, but may be demonstrated more directly in the following way. If an injection cannula is tied into the inferior canal of the peduncle in such a direction as to lead into the rachis and the superior canal is cut open from the peduncle to the axial pore, a methylen-blue solution on being injected into the inferior canal almost immediately appears in the open superior canal. If this procedure is carried out with india ink, instead of methylen blue, the ink fails to appear in the superior canal. The converse experiment of injecting into the superior canal and opening the inferior one yielded corresponding results except that there was often much loss of injection fluid at the axial pore. Both these lines of experimentation show that the superior and inferior canals in the body of the rachis are in communication with each other, but by openings not so large as those by which they communicate in the peduncle.

Sufficient facts have now been brought together to allow the formation of a reasonable hypothesis as to the course of the water through the *Renilla* colony. (In a resting expanded *Renilla* water is entering the animal through the innumerable pores of its lateral siphonozooids (fig. A).) This water enters in consequence of the ciliary action of these zooids. It fills the open spaces of the rachis and from time to time escapes to the exterior by passing either directly through the minute pores of the rachis tissue into the superior canal and out of the axial pore or indirectly by passing down the inferior canal of the peduncle to its

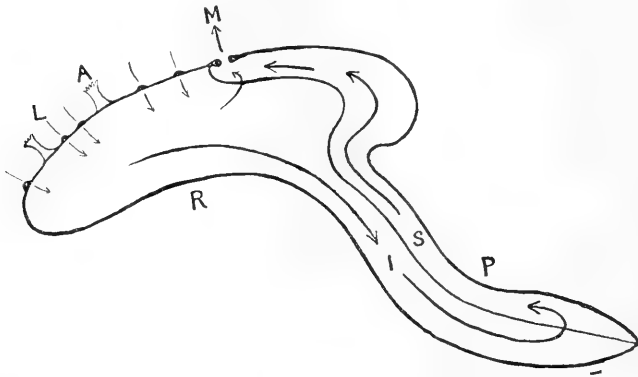

Fig. A Diagram of a median section of the rachis (*R*) of *Renilla* and of the peduncle (*P*) showing lateral siphonozooids (*L*), autozooids (*A*), inferior canal (*I*), superior canal (*S*), and pore of the median siphonozooids (*M*). The direction of the current of water in a resting individual is shown by the arrows.

distal half where it may pass freely over into the superior canal and thence to the axial pore and out. Of these two outward courses that through the peduncle is much the freer and probably the more usual one to be followed.

An indication of the relative freedom of these two courses, as well as a check on the correctness of the hypothesis just advanced, may be gathered from the following experiments. If the peduncle of a fully distended *Renilla* be tied off tightly in the region where it emerges from the rachis, the animal will contract its musculature vigorously, but its volume will remain almost

unaltered. Even the forceful opening of its axial pore, which during such an operation remains closed, will not allow the animal to discharge. This, however, can be accomplished immediately if the inferior canal in the rachis proximal to the ligature is cut open, or if the ligature is taken off, in which case, the axial pore immediately opens and the discharge takes place through this aperture. If the inflated animal as originally ligated be allowed to remain so, one of two things may happen. Usually it will very slowly contract till its volume has become extremely small or it will remain inflated and tense for a long time. Clearly, these two conditions indicate different degrees of freedom of connection between the superior and inferior canals in the rachides of different individuals. In some, and these must be few in number, there seems to be no connection between these two canals in the region of the rachis; in others these connections unquestionably exist, though at best they are far from being as free as those invariably present in the peduncle. One may therefore conclude that in a resting *Renilla* water passes from the lateral siphonozooids to the interior system, whence it proceeds in small amounts slowly through the pores in the region of the rachis to the superior canal and in large amounts through the pores of the peduncular septum to the same canal and thus out from time to time through the pore of the axial siphonozooid. Under such normal conditions, it is probable that none of the other apertures of *Renilla*, the mouths of the autozooids and the terminal peduncular pore, are concerned in any significant way with the water current.

When such a resting animal is stimulated so that its general musculature contracts and its fluid contents are put under unusual pressure, water may then escape from it not only through the pore of the axial siphonozooid, but through those of the lateral system and through the mouths of the autozooids or even through the terminal pore of the peduncle.

The scheme of water circulation that has been worked out for *Renilla* may perfectly well apply to other sea-pens. In many of these instances, however, as Musgrave ('09) has shown, their organization is much more complicated than is that of *Renilla*.

Renilla, moreover, as Lightbown ('18, p. 5) declares, is probably a specialized form, hence the detailed application of such a scheme to other forms should await experimental study.

#### SUMMARY

1. *Renilla amethystina* contracts and buries itself in the sand of its natural habitat as the tide recedes, and expands above the sand when the tide returns. In contraction its volume may be diminished 88 per cent by the discharge of sea-water.

2. Sea-water enters *Renilla* through the lateral siphonozooids and possibly in very small amounts through the autozooids, which certainly serve for the entrance of food. It does not enter through the axial siphonozooid or the terminal pore of the peduncle.

3. Sea-water leaves the body of *Renilla* through the axial siphonozooid which normally discharges from time to time. Under high pressure water may also escape through the lateral siphonozooids, the autozooids or even the terminal pore of the peduncle.

4. Within the body of *Renilla* the sea-water that enters by the lateral siphonozooids collects in the inferior canal of the rachis and passes thence either by very fine openings of the peduncular septum from the inferior canal to the superior one and thus less directly but more freely out at the axial siphonozooid, or,

5. The sea-water is drawn into the colony by the action, probably ciliary, of the lateral siphonozooids and is expelled by general muscular contraction.

## LITERATURE CITED

- AGASSIZ, L. 1850 On the structure of the Haleyonoid polypi. *Proceed. Amer. Assoc. Adv. Sci.*, vol. 3, pp. 207-213.
- EISEN, G. 1876 *Beidrag till Kännedomen om Pennatulidsläktet Renilla Lamk.* Kongl. Svenska Vet.-Akad. Handlingar, ny följd, bd. 30, pp. 1-15.
- KÖLLIKER, A. 1872 *Anatomisch-systematische Beschreibung der Alcyonarien.* Abhandl. Senckenberg. Naturf. Gesell., Bd. 8, S. 85-275.
- LIGHTBOWN, C. M. 1918 The dorsal mesenteric filaments in the siphonozooids of Pennatulacea. *Mem. Proc. Manchester Lit. Philos. Soc.*, vol. 62 (reprint, 20 pp.).
- MARSHALL, A. M. 1883 Report on the Pennatulida dredged by H. M. S. 'Triton.' *Trans. Roy. Soc. Edinburgh*, vol. 32, pp. 119-152.
- MÜLLER, F. 1864 Ein Wort über die Gattung Herklotsia J. E. Gray. *Arch. Naturg.*, Jahrg. 30, Bd. 1, S. 352-358.
- MUSGRAVE, E. M. 1909 Experimental observations on the organs of circulation and the powers of locomotion of pennatulids. *Quart. Jour. Micr. Sci.*, new ser., vol. 54, pp. 443-481.
- PARKER, G. H. 1919 The organization of Renilla. *Jour. Exp. Zool.*, vol. 27, pp. 499-507.
- SCHULTZE, M. 1864 Nachtrag zum vorstehenden Aufsätze. *Arch. Naturgesch.*, Jahrg. 30, Bd. 1, S. 359-360.
- VERRILL, A. E. 1864 a List of the polyps and corals sent by the Museum of Comparative Zoölogy to other institutions in exchange, with annotations. *Bull. Mus. Comp. Zool.*, vol. 1, pp. 29-60.  
1864 b Revision of the polypi of the eastern coast of the United States. *Mem. Boston Soc. Nat. Hist.*, vol. 1, pp. 1-45.
- WILSON, E. B. 1883 The development of Renilla. *Philos. Trans. Roy. Soc.*, London, vol. 174, pp. 723-815.  
1884 The mesenterial filaments of the Alcyonaria. *Mitth. Zool. Sta. Neapel*, Bd. 5, S. 1-27.

## PLATE 1

### EXPLANATION OF FIGURES

All figures represent *Renilla amethystina* Verrill.

- 1 An expanded colony of *Renilla* photographed in its natural position on the sand and under sea-water; seen from above.
- 2 A contracted colony photographed in its natural position on the sand after the withdrawal of the tide; seen from above.
- 3 A fully inflated colony, viewed from the inferior face.
- 4 A fully contracted colony seen from the side.



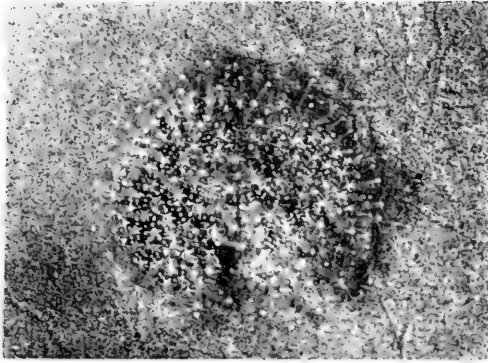

1

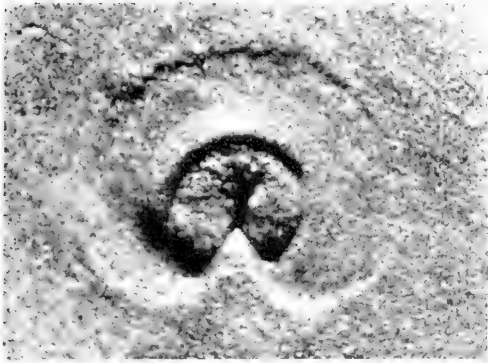

2



3



4



THE JOURNAL OF EXPERIMENTAL ZOOLOGY, VOL. 31, NO. 4  
NOVEMBER, 1920

Resumen por el autor, J. M. Olmsted.  
Universidad de Illinois.

Efectos obtenidos mediante la sección del séptimo nervio craneal  
de *Amiurus nebulosus* (Lesueur)

En el presente trabajo el autor describe los botones gustativos de las barbas del pez-gato, *Amiurus nebulosus*, así como su inervación, irrigación sanguínea, etc. Cuando se corta la rama del séptimo nervio craneal que pasa a lo largo de la barba, todos los botones gustativos de dicha barba desaparecen al cabo de unas dos semanas. Su lugar es ocupado por células epiteliales indiferentes formadas como resultado de la proliferación del epitelio germinativo. La desaparición de los botones gustativos se debe a la acción fagocítica de leucocitos procedentes de la sangre.

El autor presenta pruebas sobre la naturaleza de las numerosas células emigrantes provistas de pigmento, que no son sino leucocitos fagocíticos cargados de materiales de deshecho, que serán expulsados al exterior a través de la piel. Los botones gustativos reaparecen en la barba y se transforman en funcionales cuando la regeneración del nervio es completa, es decir, al cabo de unos cuarenta días.

El pez regenera barbas completamente nuevas, que poseen botones gustativos después de alcanzar una longitud de unos 5 mm. Si se corta una porción de la barba, el resto se regenera si el nervio no ha sido lesionado. Las barbas desprovistas de nervio no se regeneran. Hay, por consiguiente, en *Amiurus*, una relación muy íntima entre el neuroepitelio y el nervio, y también entre este último y la capacidad de regeneración.

## THE RESULTS OF CUTTING THE SEVENTH CRANIAL NERVE IN *AMIURUS NEBULOSUS* (LESUEUR)<sup>1</sup>

J. M. D. OLMSTED

FOUR PLATES (TWENTY-SIX FIGURES)

### HISTORICAL

The study of the effects of nerve cutting, such as the classic experiments of Waller ('52), proved early in the history of physiology to be one of the most fruitful methods of investigation. Vintschgau und Höningschmied ('76) found that when they severed the glossopharyngeal nerve on one side of a dog's head, the taste buds on the corresponding side of the tongue disappeared, while those on the other side remained intact. This phenomenon was later investigated more thoroughly by Vintschgau ('80). According to his results, forty-eight hours after operation the so-called 'cover cells' became swollen and filled with granules which stained light gray with osmic acid. The contour of the taste bud disappeared a few days later, and finally in place of the taste bud there came irregularly placed epithelial cells. Vintschgau thought he had evidence that the 'cover cells' metamorphosed into ordinary epithelial cells, but he was able to see only one cell actually undergoing this process. By the seventh day nearly all the taste buds had disappeared, though a few persisted for even a month after the operation. Drasch ('87) repeated this experiment with like result. Ranvier ('88) described in a foot-note in his "Traité Technique d'Histologie" the result of cutting the ninth nerve in the rabbit. Forty-eight hours following the operation profound modifications set in, which led to complete disappearance of the taste buds after forty days. But, unlike Vintschgau, he found that the sense

<sup>1</sup> Contributions from the Zoölogical Laboratory of the Museum of Comparative Zoölogy at Harvard College, no. 324.

cells actually degenerated and were completely destroyed on the spot. This, he thought, was probably brought about by the aid of the large wandering cells filled with fat globules. The protective 'cover cells' after showing signs of hypernutrition were expelled successively from the pore of the bud, the space being gradually filled with epithelial cells. Five days was sufficient for the completion of the process.

The results of these experiments in cutting the ninth nerve were seriously questioned by Baginsky ('93, '94), and indeed he expressed doubt as to the reliability of any nerve-cutting experiments. He repeated Vintschgau's operation in nine dogs, and in all of them he found that the taste buds remained unaltered even after eighty-seven days. Moreover, he stated that on the side of the tongue corresponding to the intact nerve, and even in normal dogs as well, he was able to find all the pathological changes in the taste buds which former authors had ascribed to the effect of cutting the glossopharyngeal nerve. Sandmeyer ('95) undertook to settle this disputed question. He examined eighteen hundred sections from eighteen papillae of a normal dog's tongue, and among all these he found only two furrows in which the taste buds were wanting. Nevertheless, twenty-one to twenty-seven days after cutting the ninth nerve on one side of a dog's head, he was unable to find a single taste bud on that side of the tongue. A final set of experiments by Semi Meyer ('96) completes the evidence. His description of the process is more extensive than that of the majority of the previous workers. He was able to notice changes within thirty hours after the operation, for at the foot of the bud an accumulation of epithelial cells began to obliterate the boundary of the bud. The epithelial cells then gradually pushed over into the bud so that by the seventh day the position of a bud could be told only by the oblique arrangement of a few cells which by that time showed no sharp differences from normal epithelial cells. By the twelfth day even these remains could not be seen, only ordinary epithelial cells being present throughout the entire epidermis. Because no signs of degeneration were to be observed during the whole process, he concluded that dedifferentiation had taken place.

In justification of this idea of dedifferentiation, Semi Meyer refers to the statement of Szymonowicz ('95), that the tactile corpuscles of Merkel arise through differentiation of epithelial cells brought about by the entrance of the nerve fiber. Therefore, he contends, if the presence of the nerve determines the form and function of these cells, transforming an indifferent epithelial cell into a highly differentiated sense cell, why should not dedifferentiation take place when that influence is removed? This argument rests on analogy only, though there is evidence that taste buds are differentiated from epithelial cells through the advent of the appropriate nerve (Olmsted, '20).

In none of these experiments does there seem to have been any attempt to correlate changes in the taste buds with the degenerative processes in the nerve. According to Howell ('20), degeneration of the nerve stump in the dog and most other mammals begins in a few days—four at the latest. In the dog it proceeds so rapidly that the process seems to be simultaneous throughout the whole peripheral stump. But in the frog and rabbit the degenerative changes begin at the wound and progress peripherally.

The most extensive studies of nerve degeneration have been carried out by Howell and Huber ('92) and Mott and Halliburton ('01). From the data of these investigators it will be seen that the first degenerative changes in the taste buds of dogs whose ninth nerves have been cut coincide in point of time with the initial degenerative changes in a severed nerve.

#### METHODS

Since the fish *Amiurus* possesses taste buds on its barbels and the nerves leading to them are easily accessible, this fish lends itself most readily to experiments which attempt to answer the questions raised by the work on mammals. It must be borne in mind that in this problem the conditions are somewhat different from those in mammals. We are dealing with a fish, a cold-blooded animal and a much lower form of vertebrate than a mammal. Howell ('20, p. 125) states that in the frog—a

typical cold-blooded animal—degeneration of the nerve may require from thirty to one hundred and forty days, depending upon the season of the year, although if the frog is kept at a high temperature (30°C.) degeneration may proceed as rapidly as in a mammal. Also the taste buds in *Amiurus* which are most convenient for study are not on the tongue, but in the barbels, on the outside of the body at some distance from the mouth. Finally, in all the experiments on mammals the ninth nerve has been cut, but in *Amiurus* it is the seventh nerve which leads to the barbels.

At the suggestion of Doctor Parker, Mr. A. J. Bigney tried out the operation and found that the taste buds in *Amiurus* did disappear in from ten to fourteen days. I wish especially to express my thanks to Mr. Bigney for turning the problem over to me after having gained this information.

To learn where best to cut the nerves, a preparation was made by treating a freshly severed head of *Amiurus* with 30 per cent nitric acid for several hours. The skin and superficial muscles of such a preparation can be scraped off, leaving the nerves in place. The nerves are situated very close to the surface, so that a clean shallow cut in the skin of a living fish some 2 or 3 mm. in length is sufficient to disclose them. For convenience, the pair of barbels on the dorsal surface of the head may be designated dorsal; those at the corners of the mouth, mandibular; the outer pair of the four ventral barbels, lateral, and the inner ones, ventral. The nerves to the dorsal barbels may be most favorably laid bare immediately mediad to the posterior nasal apertures. For the lateral and ventral barbels the cut is best situated 3 to 5 mm. from the base of the barbel toward the outside of the fish. The nerve having been laid bare, it can then be freed from connective tissue, etc., so that the blade of the scissors may be thrust beneath it. A clean stroke of the scissors will sever the nerve, the stumps usually drawing back under the edges of the cut. If done with care and skill, the operation is bloodless, so that the circulation in the barbel can in no way be seriously interfered with. The fish may be etherized before operating, but better results followed when no narcotic was used;



that is, there was better general condition and absolutely no mortality.

The nerves to the two dorsal and the two lateral barbels in over one hundred fishes were cut in the manner indicated, and in fifty others as much as possible of the peripheral stump was pulled out through the cut and removed. This second set of experiments was for the purpose of determining whether the mass of degenerating tissue might possibly have an effect on the time of disappearance of the taste buds—naturally, the individual branches to the buds still remained—but there was no difference in the behavior in the two sets of fish. Barbels were removed daily and prepared by various methods for histological study.

Heidenhain's ('14) special osmic-acetic-sublimate mixture, which gave him his best fixation of the dog's tongue, was only fairly successful for the taste buds of *Amiurus*, but was excellent for other structures, e.g., wandering pigment cells and nerves, chiefly on account of the presence of osmic acid. A rapid fixing agent compounded by Mr. A. W. L. Bray gave especially good preparations of the buds, though other tissues were slightly shrunken. This fluid consisted of equal parts each of absolute alcohol, formalin, and glacial acetic acid; the mixture was then saturated with corrosive sublimate and used for thirty minutes at a temperature of 50° to 60°C. But most satisfactory of all was formol-Zenker (4 to 10 cc. formalin added to Zenker's fluid without acetic acid immediately before using). Among various stains, safranin, especially after Bray's fluid and Delafield's haematoxylin counterstained with eosin, proved to be very good, but best of all was Heidenhain's iron-haematoxylin, either without counterstain or with eosin or orange G. Retzius ('12) found that Zenker's fluid followed by Heidenhain's iron-haematoxylin gave him the best results with the dog's tongue. Various silver methods were tried, the most successful being Bielschowsky's. For nerves alone osmic acid was used, both teased preparations and sections being made.

The majority of the work was done at Woods Hole, Massachusetts, where the average temperature of the water in the laboratory was about 22°C. After the operation of nerve cutting

the wound healed rapidly, the edges of the cut closing together at the end of the second day, and from that time on only a fine white line in the skin showed where the incision had been made. Corresponding changes did not occur at precisely the same time. For example, many barbels fixed on the eleventh day after operation had taste buds in perfect condition, while in others all buds had disappeared. One could, however, readily make out the stages in the process.

#### STRUCTURE OF NORMAL BARBELS AND THEIR TASTE BUDS

To appreciate the results of the experiments in nerve cutting, an understanding of the histology of the normal barbels and taste bud is essential. The following description supplements the statements of Wright ('84) and Herrick ('01). The eight barbels of *Amiurus* are practically the same in form and structure. The two large barbels at the corners of the mouth are stiffened by very heavy cartilage, which will not cut well after the ordinary paraffin treatment. The other six barbels have only a small central core of cartilage which does not seriously interfere with sectioning, and for this reason the operations involved only these six barbels. The barbels are somewhat flattened laterally, the anterior edge being slightly broader than the posterior one (fig. 16, 24). It is the epidermis of the anterior edge which bears the majority of the taste buds, for they lie closely crowded here and appear only at intervals on the other portions of the barbels. This concentration of the taste buds on the anterior edge is to be expected, since it is this portion of the barbel which touches objects as the fish sweeps along the bottom in search of food. Unicellular glands, pigment cells, wandering leucocytes, and stratified epithelium compose the major portion of the epidermis. The central core of the barbel is occupied by a rod of cartilage, a large nerve trunk, blood-vessels, muscle, and a small amount of connective tissue.

The taste buds are flush with the surface or even project beyond the level of the outer epidermal cells, especially toward the tip of the barbel, where the epidermis is relatively thin. They are never depressed, nor do they lie at the bottom of a

pit as do the three types of sense organs belonging to the acustico-lateralis system (Herrick, '01). In this respect also they differ from mammalian taste buds, which possess 'Geschmacksgrübchen and a distinct pore (Heidenhain, '14). In *Amiurus* they are pear-shaped (fig. 3), never truly spherical or oval as in the dog or rabbit. This peculiarity in shape is due to the different shapes of the cells composing the two kinds of buds. In *Amiurus* the sense cells are very much attenuated above the region containing the nucleus. The majority of mammalian sense cells, on the contrary, are much more uniformly spindle-shaped with no sudden bulge at the level of the nucleus. The basement membrane below the germinative layer of the epidermis continues beneath the bud at a short distance below the visible proximal ends of the sense cells, the intervening space being filled with fibers which form a loose network (fig. 2, *a*). In this region are occasionally to be seen one or two nuclei with only a small amount of cytoplasm around them. This is the kind of cell which Hermann ('84) called 'basal cell,' and which von Ebner ('99) and Retzius ('12) contended were simply the result of oblique cutting. Heidenhain ('14), however, claims that he does find in addition to obliquely cut cells others, indifferent epithelial cells of exactly the same nature as those in the epidermis, and these he considers may be called the true basal cells. Such cells in *Amiurus* always appear to be obliquely cut sense cells, for if one follows them through several sections one will find that they possess the prolongation characteristic of the true sense cells, and furthermore they have an amount of cytoplasm around the nucleus which is more nearly the proportion found in sense cells than in the ordinary epithelial cell. I have never observed a case of mitosis in a normal taste bud, though it is not a rare occurrence in the germinative layer of the epidermis.

In the first accounts of taste buds in the mammalian tongue, given simultaneously by Lovén ('68) and Schwalbe ('68), there were described two kinds of cells, those composing the peripheral layer of the taste bud, long, markedly cone-shaped cells, often vacuolated and with poorly staining spherical nuclei, and those occupying the central portion of the bud, smaller cells, with

large deeply staining oval nuclei. The former were termed 'Stutz' or 'Deck-zellen,' the latter, the true 'Sinneszellen.' Although it has been shown by Kolmer ('10), Retzius ('12), and Heidenhain ('14) that there is only one kind of cell present in the mammalian taste bud, the 'cover' and 'sense' cells being different stages of the same cell, the dual nature of the cells of taste buds is still maintained in the literature. There is most evidently only one kind of cell in the taste bud of *Amiurus*, i.e., the sense cell.

The individual sense cell is very long and possesses a distinct bulge, about one-fourth of the length of the cell from the proximal end, to accommodate the heavily staining oval nucleus. The distal end of the cell terminates in a single short process, which nearly always projects slightly beyond the epidermis. When stained otherwise than with Heidenhain's iron-haematoxylin, these processes appear as rounded ends of the sense cells colorless or slightly yellow, as if composed of cuticula or horny material; but with Heidenhain's iron-haematoxylin they appear much more like cytoplasm, especially when viewed under an oil-immersion lens. At the base of each peg-like prolongation is a heavily staining basal body.

The proximal end of the sense cell may terminate either in a single fiber or it may be branched, the former condition being more often seen. The presence of such fibers led Lovén and Schwalbe to infer that the sense cells of the taste buds had direct connection with the nerve fiber, a condition which has been proved to exist in olfactory cells. Ranvier ('88) even stated that he was able to demonstrate by the gold method that the 'sensory cells' (which were more deeply colored than the 'cover cells') were continuous with the nerve fibers. This was disproved by Retzius ('92) and others.

The innervation of the taste buds is well brought out in longitudinal and transverse sections of silver preparations. A branch of the main nerve of the barbel passes into the dermal papilla beneath the bud. Bielschowsky preparations proved to be superior to those made by Golgi, Cajal, or Ranson methods in showing the distribution of the nerve fibers in the bud. Fibers

pass up through the papilla in a more or less compact bundle and then spread out to form a plate-like plexus against the basement membrane immediately beneath the bud. In many sections the nerve fibers appeared to end in this plate, but careful search would nearly always reveal fibers, more often brown than black, extending up from this plate and coming to lie between the sense cells. These intrageminal fibers were never so numerous as the fibers leading up to the base of the bud, nor did they become so heavily impregnated with silver. Retzius ('92) gives several figures showing the innervation of the 'Endknospen' of various fishes. Those of the teleost *Gobius*, plate XI, figures 9, 10, represent very closely the condition in *Amiurus*. So far as could be observed, the intrageminal fibers do not enter the sense cells, but only lie between them. In mammals, nerves lose their myelin sheath as they pass into the taste bud. No special preparations of *Amiurus* were made to determine whether this is the condition in it, but the difference between the power of these intrageminal fibers to take silver and that of fibers which, from osmic-acid preparations, were known to be medullated, may be due to the absence of a myelin sheath. Arnstein ('93) describes the intrageminal fibers of the dog as surrounding and lying on the taste cells, but Kolmer ('10) claims that he has found in the hedgehog two kinds of fibrils within the cells.

The system of capillaries by which each bud receives its blood supply is especially striking. Along the wall of each dermal papilla very small vessels can be seen (figs. 1, 3), which are connected with the larger vessels running longitudinally in the barbel. These small vessels open into an extension or sinus immediately beneath the basement membrane on which the bud may be said to rest (fig. 3). The vessels along the side of the papillae are seldom of large enough diameter to contain two erythrocytes side by side, but the space just beneath the bud often contains a solid mass of them. The papilla thus consists of a peripheral layer of pigment cells, and a central core of connective tissue, through which pass nerves and blood-vessels. Most frequently there are to be found in that portion of the taste bud distal to the nuclei of the sensory cells certain cells which

have evidently made their way into the bud from an outside source. These included cells may be classified under two main types occurring in approximately equal numbers. The first is a very small cell which appears as a naked nucleus with a very pronounced nucleolus (fig. 3, *a*). This type of cell seems to be identical with the small leucocyte occurring normally in the blood. Under favorable conditions, e.g., in blood smears, in sections of blood-vessels, and in clear spaces between cells of the epidermis, one can see a small amount of faintly staining cytoplasm surrounding the nucleus. The clear area which often appears in tissue surrounding the cell is apparently due to the dissolving away of the protoplasm of the cells which are in contact with it (fig. 3, *b*). The other type of included cell is larger than the first and further distinguished from it by having a varying accumulation of brown pigment granules (fig. 2, *b*, *c*). This pigment is exactly similar to that seen in the irregularly branching chromatophores scattered throughout both epidermis and dermis (fig. 2, *d*), though in the ordinary chromatophore the granules are often so dense as to form a homogeneous black mass. The wandering pigment cells in buds fixed in fluids containing osmic acid, and stained in Heidenhain's iron-hematoxylin, nearly always contain one or more globules of varying sizes, probably of fatty material, since they are spherical, homogeneous, non-granular, and stain either a very deep blue or black (fig. 3, *c*, *d*). The cells are most irregular in shape and vary greatly in size, but they always lie in a clear area as if they had been fixed during the process of phagocytosis.

One can arrange a perfectly graded series of these included cells from the typical leucocyte to the wandering pigment cell. The first of the series is the small leucocyte consisting of almost nothing but a naked nucleus with its heavily staining nucleolus. This cell gives no evidence of phagocytizing the cells around it. Under favorable conditions a thin ring of cytoplasm can be seen surrounding the nucleus. The next step is a cell like the first except that the cytoplasm is more evident and there is most certainly the beginning of a clear area about the cell, showing that phagocytosis has begun. The third stage is the addition of

more cystoplasm, which now extends out in different directions, like pseudopodia, through the clear area. With an increase in the clear area and the addition of a few brown granules, we have the initial stage of the wandering pigment cell. This in turn is succeeded by further stages of development which occur in normal epidermis, but not in normal taste buds. More and more pigment is acquired and the cells come together and coalesce to form a huge mass of brown granules (fig. 12, *a*). The pigment in this mass is not uniformly distributed, but sometimes as many as ten denser regions may be seen. When these special accumulations of pigment are examined with very strong illumination they prove to be a condensation of granules about nuclei which still take the blue stain of the haematoxylin, though the color is more often completely masked by the brown granules. In many cases, however, the nuclei lie in areas devoid of granules and are stained normally (fig. 12, *a*). Finally these huge masses migrate to the surface (fig. 12, *a, b*), and at this time the nuclei often lose the power to take a stain, appearing merely as brown discs. These masses are probably cast off as waste matter, for they are found protruding beyond the surface and under certain conditions the granular material of which they are composed has been seen scattered along the surface of a barbel, as though caught in the mucus after having been discharged (figs. 10, 11).

I believe, therefore, that the small leucocyte and the larger pigment cell are different stages in the history of the same phagocytic cell, and that its function is to remove worn-out cells, especially sense cells, and its ultimate fate is elimination with its load of waste material from the surface of the skin.

These wandering pigment cells were probably first seen in taste buds by Vintschgau ('80), for he found in practically every bud that he examined granules of fatty material. The reason for his not discovering that they were enclosed in a special cell was probably due to his method of preparing his tissue, since he used osmic acid alone without any stain. He thought that these granules might play a part in degeneration and regeneration, though he had no proof of this. Ranvier ('88) interpreted these cells in the rabbit as lymphocytes which had migrated in from the dermis and ingested fat granules.

The cells designated as included cells are by no means confined to the taste buds; they are, in fact, much more numerous in certain other parts of the epidermis. The small lymphocytes are found in varying numbers between the cells of the germinative layer and their immediate neighbors, while the wandering pigment cells are found most abundantly in the more peripheral areas—another hint that the latter cell is the derivative of the former.

#### RESULTS OF NERVE CUTTING

The first changes observable in any of the preparations occurred on the seventh day, when longitudinal sections of barbels fixed in Heidenhain's osmic-sublimate-acetic mixture showed evidences of beginning degeneration in the nerve (fig. 5). Up to this time it had shown the structure typical of medullated nerve (fig. 4). The normal condition is well brought out in teased osmic-acid preparations, where the myelin sheaths stain heavily and the nodes of Ranvier can be seen at intervals. Now, instead of the almost unbroken parallel lines of continuous fibers and sheaths, there was somewhat of a granular appearance due to breaking of the fibers and sheaths into segments. At the same time, but becoming more prominent on the eighth day, there occurred an increase in the number of small leucocytes in the epidermis, particularly in the region next to the basement membrane (fig. 12). By the ninth day the myelin sheaths had further broken up into more or less globular fragments (fig. 6) and the number of nuclei had increased—a typical nerve-degeneration phenomenon. Up through the tenth day the taste buds always remained intact, but many eleven-day preparations showed complete absence of them. In the latter there was a decided increase in the number and size of the wandering pigment cells in the epidermis. If, however, the taste buds were still intact, a greater number of small leucocytes than normal was to be found in them. In normal taste buds as many as three leucocytes may be seen in a single bud, but this is rare, and there may be in the field only one bud with included leucocytes to four or five entirely free from them. In one thirteen-



day preparation six out of ten buds taken at random contained small leucocytes. One had four, two others three, etc., a total of thirteen for the six buds, and the majority of the leucocytes showed signs of having begun phagocytosis. In these same buds three of the included cells with pigment were counted. Two preparations of twelve-day barbels, in which the taste buds were still present, showed a special accumulation of small leucocytes in the capillaries along the sides of the papillae. Many of them, too, had escaped from the capillaries and lay in contact with the nerve. In several instances as many as ten leucocytes could be counted in the capillaries and no erythrocytes at all. This is in strong contrast to the normal condition where the number of erythrocytes is vastly greater than that of the leucocytes. In a blood smear from a normal fish there were in one field one white to two hundred red corpuscles, and in another, five white to four hundred red corpuscles. In a cross-section of a blood-vessel in a normal barbel two white to seventy red corpuscles were counted. A sudden increase in the number of leucocytes in man usually signifies that there is some abnormal process going on, one in which there is foreign material or broken-down cells to be disposed of, such as bacteria and tissue cells which have been killed by the toxic products of the bacteria. The same is evidently true in *Amiurus*, for this invasion of leucocytes is the immediate forerunner of the actual disappearance of the taste bud—the climax of the process.

This most striking stage was found in only a limited number of twelve- and thirteen-day preparations (figs. 10, 11). The part of a sense cell distal to its nucleus seems to be the first to be attacked by the phagocytic leucocytes. Buds were seen in which the clear space about a single granule-filled leucocyte was fully a third of the total volume of the bud. In others there were as many as six included cells, one specimen showing four fully developed pigment cells, and two of the small leucocytes like naked nuclei. The greater the number of sense cells eaten away, the greater was the number of globules of fatty material and granules of brown pigment within the leucocytes. Finally, the leucocytes disintegrated and the taste bud consisted merely

of a hollow shell bounded by a single layer of taste cells, open to the outside at its distal end, and having at its base scattered nuclei of the sense cells, and in its center an irregular mass of small granules and larger globules (fig. 10). In some cases this hollow shell representing the taste bud was quite empty, and the broken-down material remained clinging to the outside of the barbel a short distance away. The peripheral ring of sense cells disappeared later, but the nuclei of the taste cells remained for a longer time. While the bud is still a hollow shell, epithelial cells appear to be pressing on its sides, closing the opening through which debris of the distal ends of the sense cells passed, and preventing the still degenerating nuclei from escaping. Phagocytic leucocytes are then seen among the nuclei, and so complete is their disintegration that there can be no possibility of the transformation of the sense cells into any other kind of cell. The basement membrane beneath the bud disappears, and the space formerly filled with the more or less fibrillar ends of the taste cells, which lay between it and the nuclei, becomes continuous with the capillaries of the papilla. The capillaries extend still further into the epidermis until they reach the region formerly occupied by the nuclei of the sense cells. The degenerative process is then complete, the indifferent epithelial cells, capillaries, and wandering pigment cells now occupy the site of the taste buds. The degenerative process seems to be simultaneous throughout the whole barbel, and this appears to be true of the nerve also, for changes at the base of the barbel are not more pronounced than at the tip, and vice-versa.

The next step is well shown in tangential sections. The only indication on the surface of the barbel that taste buds were once present is either an accumulation of pigment (fig. 20, *b*), or the presence of three to five epidermal cells enclosed within concentric circles of other epidermal cells (fig. 20, *a*). In normal buds each of these whorls of epidermal cells surrounds the tips of more than a hundred sense cells. The next section into the barbel (fig. 21, *a*) shows a disc of twelve to fifteen epithelial cells, each with its characteristic round nucleus and relatively large amount of cytoplasm. In normal buds one must pass through five or

more of the 6- $\mu$  sections before coming to nuclei (figs. 17, 18). Furthermore, in the normal bud there are many more nuclei to a given area, since they are crowded together and have only a very small rim of cytoplasm about them. They also stain more heavily than the nuclei of epidermal cells (fig. 19). In the two or three sections which follow, this condition is repeated until the capillary appears in the center (fig. 22, *a*). In figure 20, *b*, the large wandering pigment cell represents the remains of a bud, and probably consists of material from the nuclei. This one pigment cell occupies as much space as the original bud, for it extends through four sections. Beneath it there is only a single layer of epidermal cells (fig. 22, *b*), for the capillary appears in the next section. The removal of degenerating material has not proceeded so far in this case as in the other.

There can be no question that in *Amiurus* the taste buds undergo a process of degeneration in which the leucocytes play the rôle of phagocytes, but out of more than a hundred slides of barbels removed from eleven to thirteen days after cutting the nerve, only five or six portray the taste buds in the actual process of degeneration, in all others the process has not yet begun or has been fully completed. One must perforce conclude that the time consumed by this process is relatively short. I believe that this is the reason why neither Vintschgau nor Meyer got any indications of degeneration in the taste buds of the dog after cutting the ninth nerve, and concluded that the taste cells dedifferentiated into epithelial cells. They did not have enough material fixed at sufficiently short intervals to insure their finding the proper stages.

Ranvier, on the contrary, was more fortunate in having chosen the rabbit for his experiment, for the rabbit is more like the cold-blooded animals in requiring a longer time than other mammals for nerve degeneration. Ranvier, therefore, happened to hit upon the process actually under way. The expulsion of the 'cover cells' from the pore of the bud, after showing signs of hypertrophy, is quite comparable to the expulsion of the granular mass of broken-down sense cells in *Amiurus*, and Ranvier's surmise that the large wandering cells were responsible is without doubt correct.

The conduct of the phagocytic leucocytes in degenerating taste buds and their presence in normal buds accompanied by a surrounding phagocytized area, is clear evidence that this is the method of ridding the normal bud of worn-out sense cells. A bud was found in a normal barbel in which the leucocyte seemed to be attacking one cell only. For some distance above and below the included cell this one particular taste cell was entirely devoid of cytoplasm, a few coarse granules, such as are usually found within a wandering pigment cell, being left in the more distal portion. The phagocyte was distinctly amoeboid in shape, as if it has been fixed in an active state. In several normal buds where the wandering cells were evidently in the act of phagocytizing the sense cells, the picture was exactly like that in one of the barbels whose nerve had been cut thirteen days. In the latter specimen, however, it was the beginning of the final destructive process, for other buds were seen in a much more advanced stage of degeneration. Figure 3 illustrates the most advanced condition in a normal bud I have ever happened upon. Generally the process goes no further than that indicated in figure 2. If phagocytosis to such a degree as shown in figure 3 was observed by Baginsky in normal dogs and on the side of the tongue corresponding to the unoperated ninth nerve, it is not surprising that he decided there was no change from the normal condition after cutting the nerve. But why the buds should have remained even in this condition for eighty-seven days in his experiment is inexplicable, that is, if the operation had been correctly performed.

In normal taste buds new sense cells most probably arise from the germinative layer of the epidermis, as they do in regenerating barbels, and not by a division of the already existing ones, since mitosis is never seen in these cells. This is a further argument against dedifferentiation, for if these cells cannot even divide to form other cells like themselves, but are destroyed when they are worn out, how much less would they be able to change back to a kind of cell which is in a more primitive condition and which possesses the possibility of differentiating back again into that same more specialized sense cell. I believe more careful and extended experiments on the dog will show the same results as

in the rabbit and fish, namely, that the taste buds undergo a process of degeneration, not dedifferentiation.

In all the fourteen-day preparations the buds had entirely disappeared, and all these preparations were characterized by the great number of mitoses in the germinative layer in the region which was originally the base of a bud. Mitosis did not occur in the cells above the germinative layer, but seemed to be confined to those cells which, in tangential sections, form a ring about the capillary (fig. 13). In some fields one could find seven or eight cases. Figure 13, *a*, *b*, shows two in a single ring. Transverse sections show that the germinative layer of the epidermis is now practically an unbroken line, and the other layers of epidermal cells are arranged more nearly in the manner of ordinary stratified epithelium, a slight disarrangement of the parallel layers occurring in those cells which formerly constituted concentric spheres about the taste bud (fig. 14). These still retain much of this configuration.

Once the taste buds have completely disappeared, there is no great change for many days. The papillae upon which the buds rested always remain, and they finally come to be the only indication of the position of the former taste buds (fig. 23). The papillae become much wider than in the normal bud (fig. 14). Capillaries are present in them and there are nearly always chromatophores. Often the chromatophores do not lie outside the capillaries against the germinative epithelium as in the normal bud, but now are in the center of the papilla, in the place where the nerve to the taste bud was formerly situated. This pigment is the only sign of the nerve which is left. The epidermis is on the fifteenth day ordinary stratified epithelium.

#### RESTORATION OF NORMAL CONDITION

Upon examining one series of longitudinal sections eighteen days after operation, in which the barbel had been cut so close to the body that a small piece of skin remained attached, it was noticed that the bit of skin contained normal taste buds, and upon closer examination a series of some ten small buds was

found extending up from the base of the barbel through a distance of not more than 2 mm. These taste buds were evidently recently regenerated, for their appearance was different from that of old buds. They were smaller, the nuclei of the sense cells stained more heavily, and the sense cells themselves were shorter and more crowded together—characteristics which belong to newly formed buds. The nerve at the base of the barbel in this region was decidedly more fibrillar and less granular than in the portions above, so that regeneration of the nerve had commenced.

A twenty-day preparation also showed well-formed taste buds at the base of the barbel. Here, too, the buds were small, compact, and heavily staining. They were found at a distance of 3 mm. from the cut end of the barbel, which in this case was not cut so close to the head as in the eighteen-day preparation just described. Regeneration had, therefore, in all probability, proceeded to a distance of 5 mm. from the true base of the barbel. At any rate, well-developed taste buds were found at a higher level on the twenty-day barbel than on the eighteen-day one. Hence regeneration is a progressive process, and probably follows (or may be simultaneous with) the regeneration of the nerve. The boundary between the region containing perfect taste buds and that with only epidermal cells could be readily made out in tangential sections. In the part containing taste buds the circles of epithelial cells enclosed numerous fine dots, the cross-sections of the 'sense hairs' (fig. 17), while in the more distal regions the circles enclosed only three to five large epidermal cells. The change between the two regions was quite abrupt. In a zone extending for a short distance above the most distal taste buds, there was active mitosis in the germinative layer at the tips of the dermal papillae, the first stage in the regeneration of taste buds at these points.

To test out the question of the return of taste buds after regeneration of the nerve, five fish were chosen at random from some sixty, each of which had had the nerves to the dorsal and lateral barbels cut. These were separated from the others, fed, and kept in good condition for two months. The second day after the operation any one of these four barbels on any fish could be

touched without eliciting any response from the fish. There was no effect whatever, if the experiment were carefully performed, whether a glass rod, a steel rod, or a piece of worm was used. If, on the contrary, the uninjured barbels on these same fish or on normal fish were treated in this manner, the fish either nibbled at the worm and rods or moved away from the rods in a perfectly normal manner. The barbels, therefore, whose nerves had been cut, were lacking in both the sensation of taste and of touch. These physiological tests were applied from time to time, but no attempt was made to stimulate any special region of the barbel, for I did not know at the time of this experiment that regeneration at the base of the barbel begins in less than three weeks and progresses toward the tip at the rate of almost a millimeter a day. Forty days after the operation the fishes behaved altogether normally, all their barbels being sensitive alike to the glass and steel rods and to the worm. To be absolutely certain, eight days more were allowed to elapse before removing and preparing the denervated barbels for histological study. Eight barbels from two fish were prepared and all of them were found to be perfectly normal as regards taste buds (fig. 16). The nerve in transverse section showed division into fascicles as in normal barbels, thus contrasting with the condition at fifteen days in figure 23. Longitudinal sections showed the characteristic fibrillar structure of normal nerve. At the end of sixty days the remaining twelve barbels were cut. All of these were found to be entirely normal. In twenty barbels, therefore, there was complete regeneration of nerves and of taste buds within two months after the cutting of the nerve. This proves that not only does degeneration of the taste buds follow degeneration of the nerve, but regeneration of the nerve is accompanied by regeneration of the taste buds, and the cycle is complete.

#### REGENERATION OF WHOLE BARBELS

It was noticed that on fish whose barbels had been completely removed, either with or without having had the nerve cut, there appeared after four weeks tiny new barbels 1 to 2 mm. in length.

When first observed they were always hooked over in the form of the letter 'J,' but after they had reached a length of 5 mm. they became straightened. The smaller of the regenerated barbels were colorless and quite transparent, and histological preparations of them showed that they had no chromatophores. By the time the regenerated dorsal barbels had reached a length of 5 mm. they had become black, and the lateral and ventral ones were dead white, the condition characteristic of the ventral surface of the fish. In the longer of the regenerated barbels taste bud were fully formed, although other structures characteristic of a mature barbel were lacking. In a cross-section was to be seen an outer layer of epidermis in which lay the taste buds, but the whole interior was filled with loose mesenchyme cells (fig. 24). There was no supporting rod of cartilage, though there might be the beginning of it in the condensation of mesenchyme cells near the center, and the nerves were not gathered into fascicles. The new barbels were very delicate, and much like bits of skin. When the fish was lifted out of the water, they lay flat against the surface of the animal and became practically invisible. In the water, however, they stood out from the head like normal barbels. The longer ones were sensitive to rods and pieces of worm, the very short ones were not.

The shorter regenerated barbels showed taste buds in various stages of development (fig. 26). The first indication that a taste bud was forming was the extension of the dermis up into the epidermis to form the characteristic papilla as at *a* in figure 26. Capillaries were present, as they are in the mature papilla, and after the disappearance of the buds as well. Next occurred a proliferation of the cells in the germinative layer at the tip of the papilla, so that there were several layers of heavily staining nuclei at this point (fig. 26, *b*). Processes from these cells were then sent out toward the surface, and the taste bud was practically complete, except that the prolongations of the sense cells were very much shorter than in the mature bud (fig. 26, *c*). In fact, the new buds were quite small and lay very close to the surface of the epidermis. Nevertheless, they were absolutely unmistakable.



## REGENERATION OF TIPS OF BARBELS WITH AND WITHOUT NERVES

Upon discovering that the barbel as a whole would regenerate, I tried the effect of removing half of this organ to see whether regeneration would take place at the injured end. If regeneration should occur on the stump of the barbel, as it was reasonable to suppose since whole new barbels regenerated when the old ones were completely removed, would the cutting of the nerve to the barbel have any effect on this regeneration? It was found both in the normal barbels and in those with nerves cut that the stumps healed over within two days. In the normal barbel eight days later a small colorless transparent prolongation could be seen extending a millimeter or so beyond the old heavily pigmented stump (fig. 15). This new end was of much smaller diameter than the old part from which it sprang, so that it resembled a small nipple. Histological examination showed that the regenerated end was exactly like a regenerating whole barbel of the same length. Taste buds did not make their appearance until after ten days (fig. 25). But the result on barbels which had had their nerves cut was totally different. On seven fish in which the nerves to the dorsal and lateral barbels had been cut two days before, the tips of each of the dorsal, lateral, and ventral barbels had been removed. Ten days later in every one of the seven fish regeneration of a nipple-like end had taken place in the two ventral barbels only, while in the two dorsal and two lateral barbels there was nothing further than a mere healing over of the wound (figs. 8, 9). This result was most striking on account of the contrast, in the same fish, between the colorless or almost white nipple on the stubs of the two normal barbels and the smooth rounded black ends of the four barbels with the nerves cut. In the latter the epidermis had closed over the wound and lay close to the stub of cartilage. This cap of epidermis possessed no indication of taste buds either old or new. The taste buds had disappeared from the whole barbel, since it was then twelve days since the nerves had been cut.

The presence of an intact nerve, therefore, determines not only the regeneration of taste buds, but also the regeneration of the whole barbel.

## CONCLUSION

Throughout all these experiments the influence of the nerve is most marked. On one hand, the degeneration of the nerve leads to the disappearance of the taste buds and is the cause of the failure of the barbel to regenerate, and on the other, regeneration of the nerve is accompanied by reappearance of the taste buds, and the presence of a normal nerve insures perfect regeneration.

To account for all these facts one may assume that there is given off by the nerves a chemical substance of the nature of a hormone, which is necessary to the existence of the taste cells and also for regeneration. One hesitates to impose another burden upon this already too heavily laden theory, but it accounts for all the phenomena as no other does. If there is given out by healthy normal nerves some definite chemical substance which is necessary for the existence of the taste cells and for regeneration, then, with a degeneration of the nerve and the lack of this substance, the taste cells must die and regeneration is impossible. Because in cold-blooded animals degeneration of the nerve is delayed for some time, the nerve is still able to send forth this substance, though connection with the central nervous system may have been lost. Morgulis ('12), after a critical survey of the literature and comparison with the results of his own experiments on ophiurans, came to the conclusion that the influence of the nervous system on regeneration is paramount. Presence of the nerve at the wound surface, according to his view is a *conditio sine qua non* for complete regeneration. It will be seen that regeneration in the barbels of *Amiurus* obeys this rule perfectly. Goldfarb ('09) found that in the earthworm and in a certain marine annelid as well ('14), complete heads would regenerate even though there might be no connection whatever between the new heads and the old nervous system. Hunt ('19) found that absence of the digestive tube did not check regeneration, but when both digestive tube and nerve were removed, he never found head structures regenerated before the nerve cord and digestive tube had grown forward toward the anterior

end. Moreover, in a few individuals, he found an abortive attempt at head regeneration of such a nature as to hint most strongly that there was a reciprocal formative relationship between these head structures and regenerating nerve cord. There are, therefore, two classes of regenerative phenomena: in one the presence of the nerve is necessary for complete regeneration, in the other it is not. The experiments on *Amiurus* point most definitely to an intimate relationship between nerve and regeneration.

#### SUMMARY

1. Taste buds in *Amiurus* are composed of one kind of cell, the sense cells, 'cover' and 'basal' cells being absent.

2. Intrageminal nerve fibers impregnated with silver by the ordinary methods appear to lie between the taste cells, not within them.

3. Evidence is given to show that the small leucocytes and larger wandering pigment cells included within the buds are different stages of the same phagocytic cell. When this cell becomes filled with waste material it is extruded from the surface of the skin.

4. Within eleven to thirteen days after cutting the branches of the seventh nerve leading to the different barbels, the taste buds on these barbels completely disappear.

5. The first evidences of degeneration of the nerve occur on the eighth day after operation, and become complete about the thirteenth day.

6. The taste buds do not dedifferentiate into epithelial cells, but degenerate, and are phagocytized by wandering leucocytes. Their places are taken by indifferent epithelial cells.

7. About the eighteenth day the nerve begins to regenerate at the base of the barbel and the taste buds again appear in this same area.

8. By the end of forty days physiological tests show complete restoration of function to the barbel, and sections show complete restoration of all structures in the barbel, i.e., nerve and taste buds.

9. New barbels regenerate where old ones are removed, and become fully equipped with taste buds by the time they have reached a length of 5 mm.

10. Stubs of normal barbels regenerate new ends with normal buds, but barbels whose nerves have been cut do not regenerate at all.

11. The presence of taste buds in a barbel is dependent on the presence of a normal nerve in the barbel, since the taste buds degenerate and disappear when the nerve degenerates and reappear when the nerve has regenerated. Likewise, the power of a barbel as a whole to regenerate a missing tip is dependent upon the presence of a normal nerve in that barbel.

12. The theory that certain chemical substances of the nature of hormones are given out by the nerves, and that such substances are necessary to the existence of taste buds and also for regeneration of the barbel as a whole, accounts for all the phenomena of degeneration and regeneration in the barbel of *Amiurus*.

#### BIBLIOGRAPHY

- ARNSTEIN, C. 1893 Die Nervenendigungen in den Schmeckbechern der Säuger. Arch. f. mikr. Anat., Bd. 41, S. 195-218.
- BAGINSKY, B. 1893 Ueber das Verhalten von Nervenendorganen nach Durchschneidung der zugehörigen Nerven. Arch. f. Anat. u. Physiol., physiol. Abth., Jahrg. 1893, S. 559-560.
- 1894 Ueber das Verhalten von Nervenendorganen nach Durchschneidung der zugehörigen Nerven. Arch. für path. Anat. u. Physiol., Bd. 137, S. 389-404.
- DRASCH, O. 1887 Untersuchungen über die Papillae foliatae et circumvallatae des Kaninchen und Feldhasen. Abhand. Sächs. Gesellsch. Wissensch., Bd. 24, S. 229-252.
- EBNER, V., VON 1899 A Koelliker's Handbuch der Gewebelehre des Menschen, Bd. 3, 402 S.
- GRÄBERG, J. 1899 Zur Kenntniss des cellulären Baues der Geschmacksknospen beim Menschen. Anat. Hefte, Arbeiten, Bd. 12, S. 337-368.
- GOLDFARB, A. J. 1909 The influence of the nervous system in regeneration. Jour. Exp. Zoöl., vol. 7, pp. 643-722.
- 1914 Regeneration in the annelid worm, *Amphinoma pacifica*, after removal of the central nervous system. Papers Tortugas Lab., Carnegie Instn., vol. 6, pp. 97-102.
- HEIDENHAIN, M. 1914 Über die Sinnesfelder und die Geschmacksknospen der Papilla foliata des Kaninchens. Beiträge zur Teilkörpertheorie III. Arch. f. mikr. Anat., Bd. 85, S. 365-479.

- HERMANN, F. 1884 Beitrag zur Entwicklungsgeschichte des Geschmacksorgans beim Kaninchen. Arch. f. mikr. Anat., Bd. 24, S. 216-229.
- HERRICK, C. J. 1901 The cranial nerves and cutaneous sense organs of the North American siluroid fishes. Jour. Comp. Neur., vol. 11, pp. 178-248.
- 1904 The organ and sense of taste in fishes. Bull. U. S. Fish. Comm. for 1902, pp. 237-272.
- HOWELL, W. H. 1920 Text-book of physiology, 7th edit., Phila., 1059 pp.
- HOWELL, W. H., AND HUBER, G. C. 1892 A physiological, histological and clinical study of the degeneration and regeneration in peripheral nerve fibers after severance of their connections with nerve centers. Jour. Physiol., vol. 13, pp. 335-406.
- HUNT, H. R. 1919 Regenerative phenomena following the removal of the digestive tube and the nerve cord of earthworms. Bull. Mus. Comp. Zoöl. Harvard Coll., vol. 62, pp. 571-581.
- KOLMER, W. 1910 Ueber Strukturen im Epithel der Sinnesorgane. Anat. Anz., Bd. 36, S. 281-209.
- LOVÉN, C. 1868 Beiträge zur Kenntniss vom Bau der Geschmackswärzchen der Zunge. Arch. f. mikr. Anat., Bd. 4, S. 96-110.
- MEYER, S. 1896 Durchschneidungsversuche am Nervus Glossopharyngeus. Arch. f. mikr. Anat., Bd. 48, S. 143-145.
- MOTT, F. W., AND HALLIBURTON, W. D. 1901 The chemistry of nerve degeneration. Phil. Trans. Roy. Soc. London, vol. 194, pp. 437-466.
- MORGULIS, S. 1912 Beiträge zur Regenerationsphysiologie. VI. Mitteilung. Über das Verhältnis des Nervensystems zur Regeneration. Arch. f. gesam. Physiol., Bd. 143, S. 501-518.
- OLMSTED, J. M. D. 1920 The nerve as a formative influence in the development of taste buds. Jour. Comp. Neurol., vol. 31, pp. 465-468.
- RANVIER, L. 1888 Traité Technique d'Histologie. Paris, 1109 pp.
- RETZIUS, G. 1892 De Nervenendigungen in dem Geschmacksorgan der Säugethiere und Amphibien. Biol. Untersuchungen, Neue Folge, Bd. 4, S. 19-32.
- 1892 Die Nervenendigungen in den Endknospen, resp. Nerven-  
hügeln der Fische und Amphibien. Biol. Untersuchungen, Neue  
Folge, Bd. 4, S. 33-36.
- 1912 Zur Kenntniss des Geschmacksorgane beim Kaninchen. Biol.  
Untersuchungen, Neue Folge, Bd. 17, S. 72-81.
- SANDMEYER, W. 1895 Ueber das Verhalten der Geschmacksknospen nach  
Durchschneidung des Nervus glossopharyngeus. Arch. f. Anat. u.  
Physiol., physiol. Abt., Jahrg. 1895, S. 268-276.
- SCHWALBE, G. 1868 Ueber die Geschmacksorgane der Säugethiere und des  
Menschen. Arch. f. mikr. Anat., Bd. 4, S. 154-187.
- SZYMONOWICZ, L. 1897 Ueber den Bau und die Entwicklung der Nervendig-  
ungen im Entenschnabel. Arch. f. mikr. Anat., Bd. 48, S. 329-358.
- SZYMONOWICZ, W. 1895 Beiträge zur Kenntniss der Nervenendigungen in  
Hautgebilden. Arch. f. mikr. Anat., Bd. 45, S. 624-654.
- VINTSCHGAU, M. VON 1880 Beobachtungen über die Veränderungen der  
Schmeckbecher nach Durchschneidung des n. Glossopharyngeus.  
Arch. f. gesam. Physiol., Bd. 23, S. 1-13.

- VINTSCHGAU, M. VON, UND HÖNIGSCHMIED, J. 1876 Nervus Glossopharyngeus und Schmeckbecher. Arch. f. gesam. Physiol., Bd. 14, S. 443-448.
- WALLER 1852 Observations sur les effets de la section des racines spinales et du nerf pneumogastrique au-dessus de son ganglion inférieur chez les Mammifères. Compt. Rend. Acad. Sci., Paris, T. 34, pp. 582-587.
- WRIGHT, R. R. 1884 On the skin and cutaneous sense organs of *Amiurus*. Proc. Canadian Inst., N. S., vol. 2, pp. 251-269.

## PLATE I

## EXPLANATION OF FIGURES

All figures are from photomicrographs of preparations from *Amiurus*. The approximate magnification of each figure is given.

- 1 Parasagittal section through normal taste bud. Nerve passes up to bud through dermal papilla at *a*; blood vessel, *b*, with erythrocytes at base of bud.  $\times 450$ .
- 2 Sagittal section through normal taste buds. Fibrillar area beneath bud at *a*. Included pigment cells with cytolyzed areas at *b*, *c*. Similar pigment cell in epidermis at *d*.  $\times 450$ .
- 3 Similar to figure 2. Small included leucocyte, *a*; larger leucocyte, *b*; early pigment cells with cytolyzed areas, *c*, *d*.  $\times 450$ .
- 4 Normal nerve.  $\times 450$ .
- 5 Peripheral end of cut nerve seven days after operation.  $\times 450$ .
- 6 Peripheral end of cut nerve nine days after operation.  $\times 450$ .
- 7 Peripheral end of cut nerve thirteen days after operation.  $\times 450$ .
- 8 Sagittal section of amputated end of denervated barbel, showing no regeneration, simply closure of wound, two weeks after operation. Taste buds have disappeared.  $\times 125$ .
- 9 Same as figure 8.  $\times 125$ .

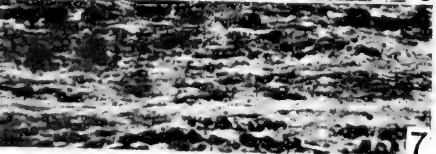
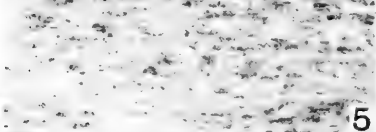
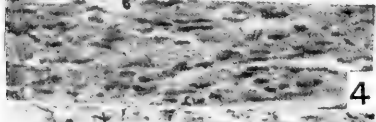
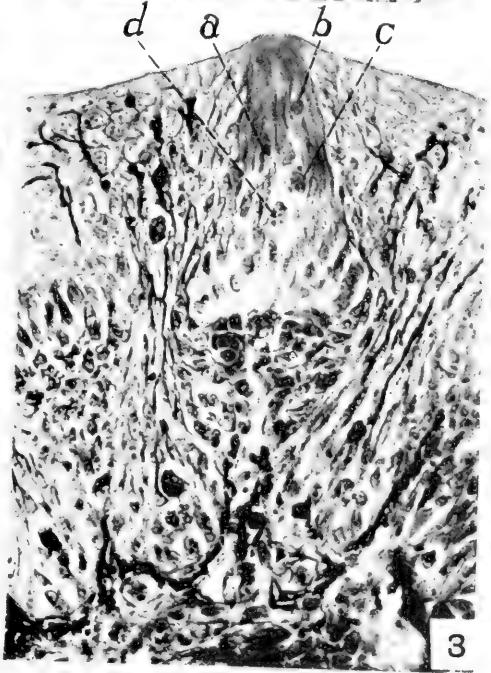
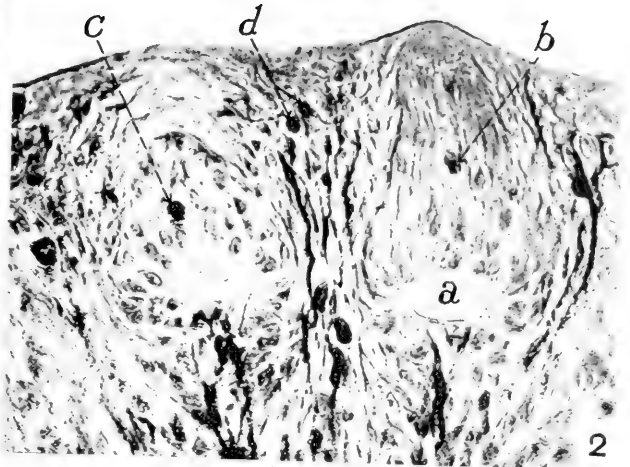
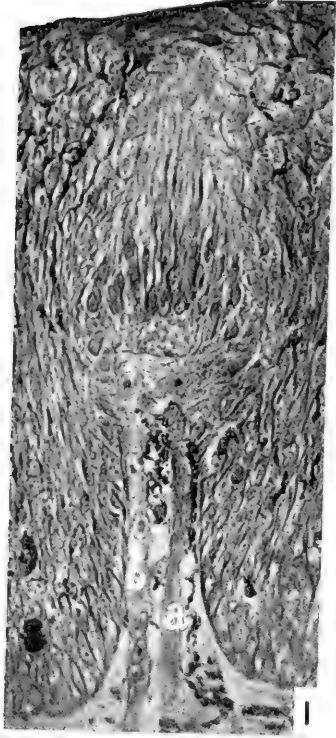

## PLATE 2

### EXPLANATION OF FIGURES

10 Sagittal section through degenerating taste bud thirteen days after operation. Only a hollow shell containing debris of degenerating material is left. Similar material lies outside the bud.  $\times 450$ .

11 Same as figure 10.  $\times 450$ .

12 Sagittal section through denervated barbel ten days after operation. Section passes through region above basement membrane of epidermis. The invasion of leucocytes is marked along the entire center of the figure. *a*, large pigment cell composed of several smaller masses, two nuclei being present. Similar pigment cell at *b*.  $\times 450$ .

13 Sagittal section through denervated barbel fourteen days after operation showing taste buds in cross-section. Sense cells entirely replaced by indifferent epithelial cells. Mitosis at *a*, *b* (compare fig. 19).  $\times 450$ .

14 Sagittal section through fully degenerated taste bud fifteen days after operation. Site occupied by indifferent epithelial cells. Large amount of pigment in dermal papilla indicates degenerated nerve.  $\times 450$ .

15 Amputated end of normal barbel from same fish as in figures 8 and 9. Regeneration extends beyond cartilage. Taste buds normal.  $\times 125$ .



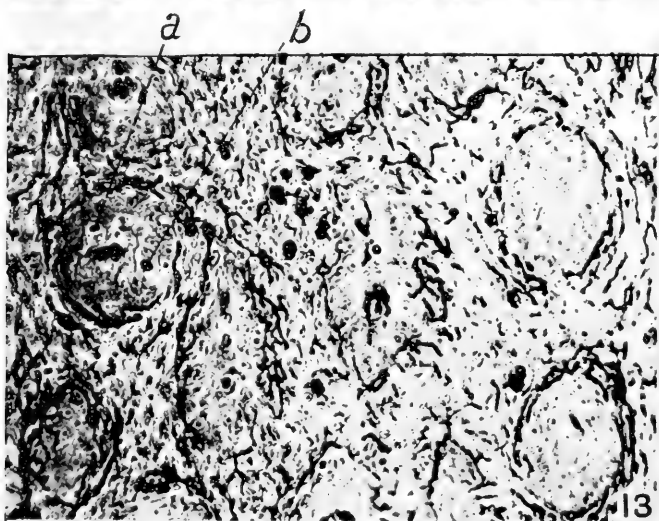
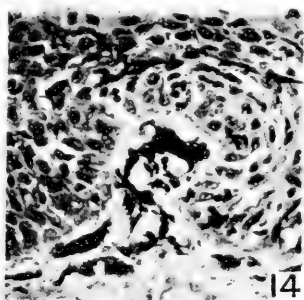
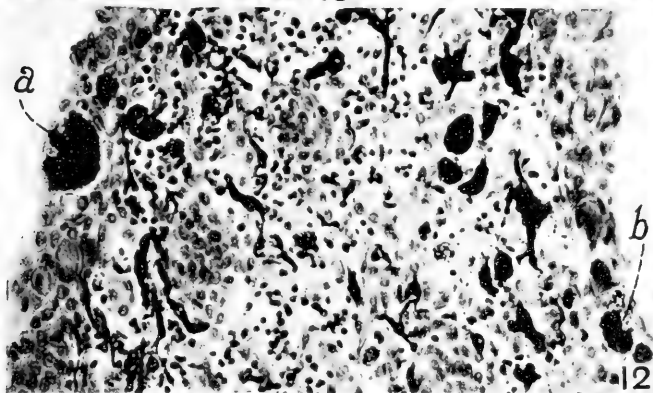
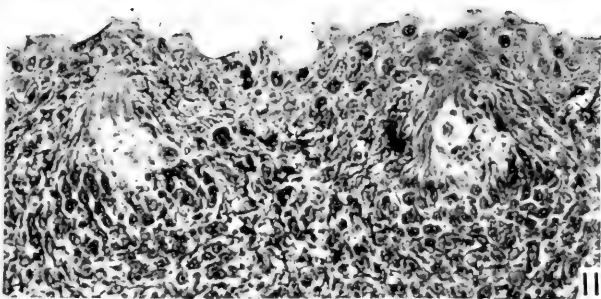
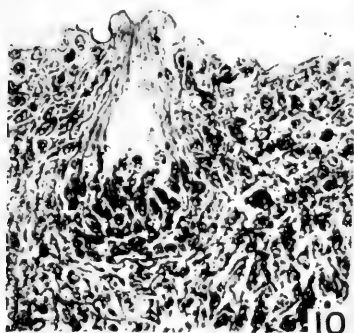

### PLATE 3

#### EXPLANATION OF FIGURES

16 Cross-section of denervated barbel sixty days after operation. Normal taste buds at *a*. Nerve at left of cartilage is in fascicles as in normal nerve.  $\times 125$ .

17 Cross-section of normal taste bud at its distal end. Over a hundred 'sense hairs' are crowded into a compact mass and are surrounded by a whorl of epidermal cells.  $\times 450$ .

18 Cross-section of normal taste bud at median level.  $\times 450$ .

19 Cross-section at normal taste bud at proximal end. Many nuclei of sense cells shown.  $\times 450$ .

20 Sagittal section through denervated barbel, showing cross-section of degenerated taste buds fifteen days after operation. *a*, aggregation of epithelial cells occupying site of former taste bud; *b*, pigment in place of taste bud.  $\times 450$ .

21 Next section to figure 20. *a*, disc of epithelial cells replacing bud; *b*, pigment replacing bud.  $\times 450$ .

22 Third section from figure 20. *a*, section through dermal papilla, capillary with erythrocyte in center; *b*, germinative layer of epidermis bounding dermal papilla.  $\times 450$ .

23 Cross-section through denervated barbel fifteen days after degeneration. Dermal papillae at *a* indicate site of former taste buds. Degenerated nerve at *b* (compare fig. 16).  $\times 200$ .

24 Cross-section through newly regenerating barbel 5 mm. in length. Taste buds at *a*.  $\times 200$ .

25 Similar to figure 15, but a later stage showing development of taste buds in regenerated area at *a*.  $\times 125$ .

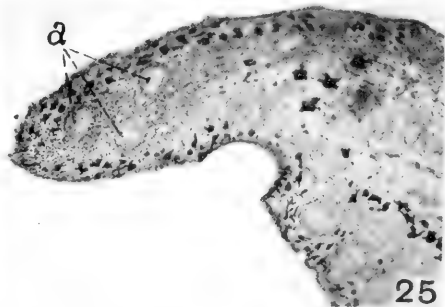
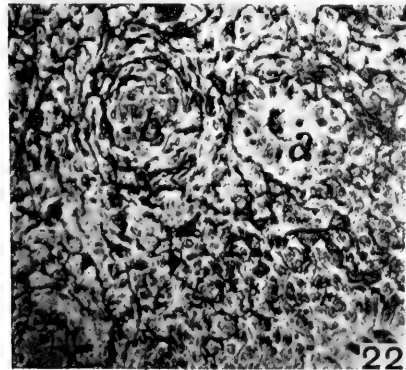
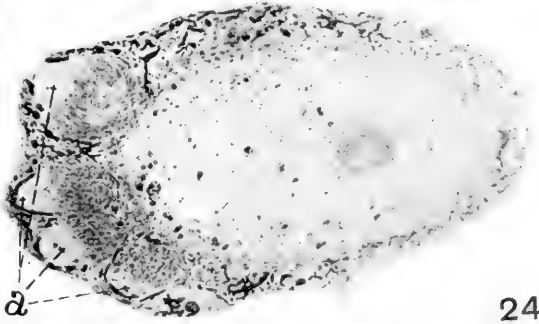
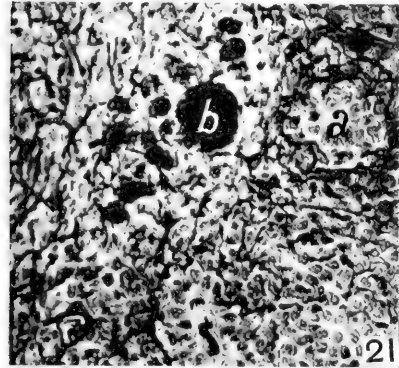
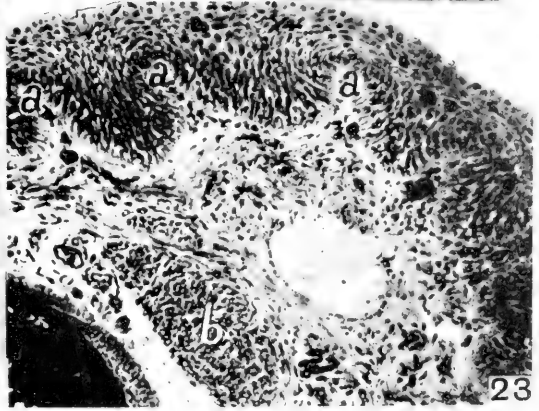
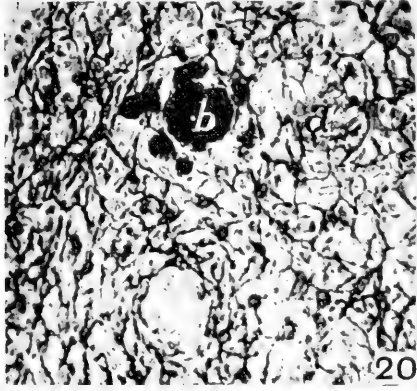
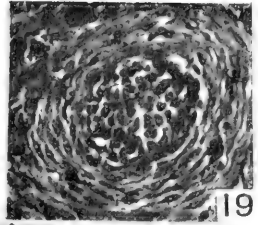
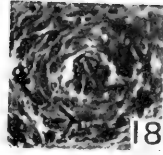
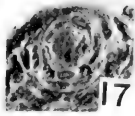

PLATE 4

EXPLANATION OF FIGURE

26 Cross-section through regenerated barbel. *a*, formation of dermal papilla; *b*, increase in cells in germinative layer at summit of dermal papilla; *c*, elongation of cells toward exterior.  $\times 200$ .



26

Resumen por G. H. Parker, por el autor, F. Göthlin.

## Estudios experimentales sobre la inhibición primaria del movimiento ciliar en *Beroë cucumis*.

Las condiciones de inhibición primaria en *Beroë cucumis*, durante la cual todas las placas natatorias son inhibidas en sus movimientos, sin retracción alguna de las filas meridianas, pueden producirse mediante estímulos mecánicos, químicos o eléctricos. El efecto inhibitorio, que tiene lugar cuando se pasa longitudinalmente al animal una corriente galvánica de 2 miliamperios de densidad por centímetro cuadrado, con el catodo situado exteriormente al polo sensorial, procede del catodo.

Ciertos venenos que afectan a los nervios, tales como el hidrato de cloral (0.2 por ciento), y la atropina (0.3 por ciento) suprimen el efecto inhibitorio primario de la corriente mencionada. En los animales así tratados, la interrupción de la corriente produce en un cierto estado, en vez de inhibición, una aceleración del movimiento ciliar, un efecto producido normalmente en *Bolina* y *Pleurobranchus* por la interrupción de una corriente semejante.

La inhibición primaria de los movimientos ciliares en *Beroë* no puede explicarse sin admitir la existencia de alguna estructura de la naturaleza de los nervios cilio-inhibidores. El mecanismo consta probablemente de receptores en la superficie del cuerpo, que transmiten los impulsos a una red nerviosa. Esta, a su vez, los transmite a los aparatos terminales que inhiben las vibraciones de las placas natatorias, probablemente mediante obstrucción de la conducción neuroide entre ellas. Este mecanismo funciona también en individuos desprovistos de estatolito, siempre que los efectos estimulantes de la operación hayan desaparecido. Existe una relación íntima entre los mecanismos inhibidores primario y secundario. Ambos usan probablemente los mismos receptores, pero el primario funciona a consecuencia de impulsos de intensidad más débil que los que llegan al mecanismo secundario.

## EXPERIMENTAL STUDIES ON PRIMARY INHIBITION OF THE CILIARY MOVEMENT IN BEROË CUCUMIS

GUSTAF FR. GÖTHLIN

*Upsala, Sweden*

### INTRODUCTION

As far as one can form an idea from the observations previously published, the leading principles of the ciliary mechanism in the meridional rows of the ctenophores seem to be as follows: The statolith apparatus of the ctenophores vibrates almost continuously; each 'balancer' communicates its vibrations to a ciliary plate belonging to it and by this means keeps up periodical ciliary waves in this plate (C. Chun). From each ciliary plate the waves are in their turn conducted to the two corresponding ciliated furrows and through these to the two rows of swimming plates that form their continuation (Chun). The conduction of the ciliary activity is 'neuroid' (Th. W. Engelmann, G. H. Parker), i.e., it has much of the character of a nervous conduction, although it proceeds through cells that belong to the superficial ectodermal layer. In the meridional row itself the mechanical act of contraction in the basal part of each swimming plate is of decisive importance for the further extension of the ciliary action in a distal direction, as the fixing of a single swimming plate appears in experiments (Eucharis, Beroë) to prevent the extension of the ciliary wave distally of the plate in question (M. Verworn), whereas cutting off the non-contractile part of one or several ciliary plates does not interrupt the conduction of the ciliary wave (Parker in the case of Mnemiopsis).

During a stay at the Zoological Station at Kristineberg in the summer of 1913 for the purpose of studying the influence of the galvanic current on the ciliary movement in the rows of the

ctenophores, I made some observations which convinced me that total inhibitions of the ciliary movement without any retraction of the rows may occur in specimens of *Beroë* under the influence of external irritation. Thus I found that closure of an electric current of sufficient strength in the longitudinal direction of a *Beroë* with the cathode at the sensory polar end of the animal is followed by a cessation of movement in all the swimming plates without the meridional rows being drawn in. For an inhibition of this sort, which affects the swimming apparatus directly without the agency of muscles, I use in this work the term 'primary inhibition,' in contradistinction to the secondary inhibition, previously described by C. F. W. Krukenberg ('80, pp. 10-11), which is the result of the drawing in of the rows owing to contraction of the radial muscles.

I also observed the occurrence of a primary inhibition due to mechanical irritation under the following circumstances. I had some specimens of *Beroë* living in glass aquaria and observed on several occasions that when an animal that was swimming along in a horizontal or almost horizontal direction collided with the wall of the aquarium the vibrations in its swimming plates stopped completely for some moments with all the signs of a primary inhibition. Subsequent inquiries in the literature showed me that the same observation had been made three years before by V. Bauer at Naples ('10, pp. 235-236).

The inhibitory effect just mentioned seemed to me not quite explicable if the ciliary movements of the animal were regulated from the statolith apparatus exclusively in the way given above, as the mechanical effect of the impact of the animal on the wall of the aquarium would, of course, if it affected the balancers, be that the latter were caused to vibrate more violently than before, and consequently the number of ciliary waves per unit of time would be increased. It seemed to me rather ('17, pp. 17-18) that both the above statements as to inhibition indicate that the swimming plates in *Beroë* are influenced by inhibitory nerves. In order to examine this question more thoroughly, I returned to Kristineberg in the summer of 1919 and carried out there the experiments that are described in this paper.



## MATERIAL AND ARRANGEMENTS FOR THE EXPERIMENTS

The form of *Beroë* that is obtainable at the west coast of Sweden is *Beroë cucumis* Fabric. According to Th. Mortensen ('12, p. 85), it is the same species as the *Boroë evata* D. Ch. that occurs in the Mediterranean.

The catches were made with a plankton trawl at the deepest part of Gullmar Fjord at a depth of 50 to 100 meters. During the month of July there were caught in this way thirty-seven *Boroë* specimens, varying between 13 and 26 mm. in length and appearing uninjured when examined macroscopically. The chief officials at the station placed them all at my disposal for my experiments. I wish to take this opportunity of thanking Prof. Hj. Theel and Dr. Hj. Östergren for this act of kindness.

The boat used for catching the animals had on board glass aquaria of about 6 liters' cubic capacity, which were filled with deep sea-water at the place where the catches were made and were kept cool with ice. The *Beroë* specimens were transferred immediately to them from the glass jar of the trawl by means of small glass bowls. During the transference the greatest care was taken, as far as circumstances allowed, to separate all the other animals that had been collected in the trawl.<sup>1</sup> Immediately on arrival the aquaria were put in a cooling safe, where the temperature was kept at 13 to 15°C. by means of ice. As a rule, daily the water in the aquaria was changed for fresh water taken from a depth of 15 to 20 meters. The experiments were carried out on the days immediately following the catch. Some of the captured animals were still alive and in good condition a fortnight after the experiments on them had been completed.

In the aquaria the animals lived mostly at the bottom. Specimens that had a specially lively ciliary motion remained there upright with their longitudinal axis vertical and their mouth pressed against the bottom of the aquarium. Individuals with a less violent ciliary motion, on the other hand, took up a horizon-

<sup>1</sup> In addition to a large number of copepods there occurred regularly specimens of *Meganyctiphanes norvegica*, usually also of *Sagitta*, and in a few cases of siphonophores, medusae (*Eutmalphes* and *Aglantha*) and the annelid *Tomopteris Helgalandica*.

tal position. They were then, as far as I could see, without exception oriented in such a way that the meridian line, which goes through the points of the two polar fields, was situated horizontally. This position, to which I shall have to return several times in my accounts of the experiments, is there called 'the usual horizontal position.' In this position the animals glided along the bottom of the aquarium. At the corners of the aquarium they remained sometimes stationary for hours in full ciliary activity. They sometimes made short excursions up to the higher layers of the liquid. On the other hand, they did not, as a rule, remain at the surface of the liquid for any length of time when they were in good condition. I only observed in two cases in my experimental animals a vertical position, described by Verwern (91, pp. 443-446, 451) as common, with the mouth facing upward toward the free surface of the liquid.

As the condition of the animals obviously deteriorated with warmth, the majority of the experiments were carried out in the aquarium room at the station, where the temperature was almost always below 20°. During the time of observation and especially when an electric current was used, the animals were kept in a cuvette with parallel walls of mirror glass. The cuvette, to which they must be transferred very cautiously, measured internally 30 mm. in width, 110 mm. in length, and 110 mm. in height. The longitudinal axis of the animal was placed in the longitudinal axis of the cuvette and the meridional rows were observed from the side with a Brückes lens mounted on a stand. The magnification was 8 times and the background was the open sky. In counting the number of ciliary waves during a certain time a stop-watch and the lens were used.

In the experiments with electric currents the electrodes consisted of two glass tubes 20 mm. in diameter, the lower ends of which were ground obliquely. The tubes were filled up at the bottom to a height of about 3 cm. with a dough made by kneading together powdered clay and sea-water. At the bottom the free surface of the clay was fastened over with a piece of chemically clean gauze. In the tube, above the layer of clay, there was a saturated solution of zinc sulphate up to a height which, when

the electrode was quite immersed, was somewhat lower than the height of the sea-water in the cuvette. The insignificant difference of hydrostatic pressure tended thus to drive the sea-water over to the zinc solution, but prevented any flow of liquid in the opposite direction. In the solution of zinc sulphate was put a zinc rod with a set-screw for the connecting wire. For each experiment a fresh clay filling was prepared and the zinc rod was rubbed clean with emery-paper.

Each of the tube electrodes was placed at a short end of the cuvette. The animals were manoeuvred exceedingly carefully with rounded glass rods so that their longitudinal axis coincided with the line of connection between the electrodes. When the cathode was outside the sensory pole, the current is called in the records 'longitudinal oro-central current.' When the direction is the opposite one, it is called 'centro-oral current.' A battery of ten Jungner accumulators was used as source of the current. By means of an element calculator it was possible to take the current from such a number of these as was necessary for the separate experiments. On a few occasions it would have been desirable to have had a stronger battery at my disposal. When in some cases a continuous alteration of the strength of the current was necessary, the rheonome of v. Fleischl was used. To measure the current a milliamperemeter was employed (Reiniger, Gebbert and Schall), on which the strength of the current could be read up to 5 milliamperes with an accuracy of  $1/20$  m. amp. and between 5 and 50 milliamperes with an accuracy of  $1/10$  m. amp. From our knowledge of the strength of the current in the circuit on a given occasion and the level of the liquid in the cuvette on the same occasion it is possible to calculate the density of the current in milliamperes per square centimeter (m. amp./cm.<sup>2</sup>) for the column of liquid between the electrodes on the same occasion.

## EXPERIMENTS AND OBSERVATIONS

1. Beroë, 23 mm. long, caught the previous day. Temperature in the cuvette 15.3°C. The animal is at the bottom of the cuvette half-way between the electrodes; ciliary action is observed in all the rows; frequency about one wave per second.

*Longitudinal oro-central current.* Closure of a current with a density of 0.92 m. amp./cm.<sup>2</sup> causes no perceptible inhibition. If, on the other hand, a current of density 1.91 m.amp./cm.<sup>2</sup> is closed, it causes total stoppage of the movements of the swimming plates.

*Longitudinal centro-oral current.* Neither a current of 1.91 m.amp./cm.<sup>2</sup> nor of 2.7 m.amp./cm.<sup>2</sup> nor of 3.55 m.amp./cm.<sup>2</sup> completely stops the ciliary movement, although the two latter cause a contraction of the aboral part of the animal, accompanied by a drawing in of the rows in the same region.

2. A Beroë specimen, 26 mm. long, caught the day before. Temperature in the cuvette 16°C. All the rows show a ciliary movement, but the frequency varies rather considerably.

*Longitudinal oro-central current.* Starting of a current 0.375 m.amp./cm.<sup>2</sup> does not inhibit in any decided way the movements of the swimming plates. A current of 0.77 m.amp./cm.<sup>2</sup>, on the other hand, produces total inhibition. The stems of the swimming plates in all the rows stop and remain in a compressed position with their apexes directed toward the oral pole. When the current is broken after about a half minute, it appears that the ciliary apparatus is still quite motionless for a few seconds after the breaking, but then resumes its regular activity.

The animal is then tested with an induction current, which is also conducted, in the longitudinal direction of the animal, through the same electrodes from a Blix cosinusinductor driven by a Jungner accumulator (1.4 volt). The frequency of the waves was calculated in one row by means of a stop-watch.

1. Frequency without any current, 15/21 sec. = 43 per min. Current of strength indicated 34, frequency 15/21 sec. = 43 per min.

2. Frequency without any current, 10/12 sec. = 50 per min. With maximal current (indicated strength 100), frequency 10/14.5 sec. = 41 per min.

3. Frequency without current, 10/8.5 sec. = 71 per min. With current of the same strength as in 2, frequency 10/12 sec. = 50 per min.

We thus see that there was no alteration with the weaker current; the stronger one, on the other hand, was followed by some, though only very slight, reduction of the frequency.

Under the influence of a stronger alternating current I have in other experiments on *Beroë* observed a contraction of the body of the animal with a drawing in of the rows and secondary inhibition of the ciliary movement.

3. *Beroë*, 23 mm. in length, transferred 5 h. 7 m. from the aquarium, where it swims about, to a cuvette containing sea-water at a temperature of 17°C. The animal takes up the usual horizontal position at the bottom of the cuvette and has a slow ciliary movement in the four lower rows, a more rapid one in the four upper ones.

The threshold for total inhibition of the ciliary motion during five seconds under the influence of a longitudinal oro-central current is determined by using an unpolarizable liquid resistance, which is regulated by an assistant, who also reads the milliamperometer.

5 h. 20 m. Inhibition threshold at 1.47 m.amp./cm.<sup>2</sup>

5 h. 24 m. Inhibition threshold at 1.60 m.amp./cm.<sup>2</sup>

5 h. 40 m. The animal is transferred to another cuvette containing sea-water with 0.1 per cent of chloral hydrate added.

5 h. 44 m. The animal has a very rapid ciliary motion and takes up a vertical position at the bottom.

5 h. 56 m. The ciliary movements have become considerably slower. On one of the most rapidly striking rows the number of the waves was found to be 30/23 sec. = 78 per min.

6 h. Electrodes are immersed. With a longitudinal oro-central current total inhibition is now first attained at 2.47 m.amp./cm.<sup>2</sup> When the current is broken, it appears that the first waves dies out at a rather short distance from the sensory

pole, but that the succeeding ones travel successively farther and farther toward the oral pole and finally throughout the whole row.

6 h. 3 m. In the animal that is weakly poisoned with chloral hydrate it is now observed that a weak current accelerates the frequency of the ciliary waves. For instance, in one row without any current there is a number of waves expressed by  $10/13$  sec. = 46 per min., but when a current of density  $0.93\text{m.amp/cm.}^2$  is closed, the waves are at least 180 per minute.

6 h. 10 m. The animal is transferred into another cuvette, which contains sea-water with 0.2 per cent of chloral hydrate added.

6 h. 54 m. On all the rows the waves are now only partial, confined to a small portion nearest to the sensory pole. One row is observed to be still sending out regular waves. The latter are not inhibited now even by suddenly injecting an oro-central current of density  $2.7\text{m.amp./cm.}^2$ , nor by leaving the density unaltered and making the direction of the current centro-oral.

4. 19/7 Beroë, 23 mm. long, takes up a vertical position in the aquarium at the surface of the liquid with the oral pole upward. The ciliary motion is lively, but varies very much in frequency. The ciliary waves are for the most part uncountable, but on one occasion on the slowest striking row the number of waves was found to be  $21/7.5$  sec. = 168 per min. A primary stoppage can be produced by touching the edges of the mouth or the polar fields, assuming that this takes place with a suitable strength.

5 h. 42 m. The animal is transferred to a cuvette containing sea-water with 0.1 per cent of chloral hydrate.

5 h. 43 m. The animal goes to the bottom of the cuvette and takes up a vertical position there with its mouth downward.

5 h. 58 m. As the animal is not more strongly affected by the concentration of poison used, it is removed to another cuvette, in which the sea-water has 0.2 per cent of chloral hydrate added to it.

5 h. 59 m. The animal now keeps at the surface. In the row that strikes most slowly the ciliary waves now have a frequency

of  $10/35$  sec. = 17 per minute. The animal's mouth begins to be more open than normally.

6 h. 4 m. The ciliary waves now die away before they have reached the oral end of the row. A number of waves do not traverse more than a quarter of the length of the row. No row is drawn in.

6 h. 8 m. The tubular electrodes are immersed. Temperature in the cuvette  $19.4^{\circ}$ .

6 h. 11 m. The ciliary activity without any current is the same as at 6 h. 4 m. When a longitudinal oro-central current is closed there is no inhibition with a density of current  $1.13$  m.amp./cm.<sup>2</sup>;

6 h. 15 m. nor with a density of  $1.47$  m.amp./cm.<sup>2</sup>.

6 h. 16 m. If the density of the current is  $2$  m.amp./cm.<sup>2</sup> the ciliary activity is accelerated.

6 h. 17 m. The same result with a density of  $2.47$  m.amp./cm.<sup>2</sup>. There is now no inhibitory reflex when the edges of the mouth are touched.

6 h. 19 m. A current of  $2.93$  m.amp./cm.<sup>2</sup> accelerates the ciliary movements, where there still are any. The animal has sunk to the bottom of the cuvette.

6 h. 23 m. A current of  $3.47$  m.amp./cm.<sup>2</sup> produces no inhibition in the rows that still strike in their aboral part. The animal is put back in the aquarium again: it is flaccid and its mouth remains wide open.

20/7. The same animal now has a normal ciliary activity and moves along the bottom of the aquarium.

5. Beroë, 14 mm. in length, stays at the bottom of the aquarium and there takes up a vertical position. If the animal is placed in a horizontal position it corrects it to a vertical one in a short while by inhibition of the ciliary movements in the lower rows. During this change of position the frequency of the upper rows seems, as far as the eye can judge, to be about the same as it is in all the rows in the vertical position.

31/7. 12 h. 44 m. The animal is transferred to a cuvette containing sea-water with 1.5 per cent of chloral hydrate. Temperature,  $16.9^{\circ}$ .

12 h. 55 m. Although the animal is becoming narcotized, it has up to the present shown "reflex correction of position."

12 h. 37 m. The ciliary movements now begin to die out before the waves have reached the oral end of the rows.

1 h. 3 m. The animal now glides into a flat horizontal position.

1 h. 9 m–1 h. 19 m. After the animal was removed in a condition of narcosis to a glass aquarium with plane walls a carefully cleaned punch, 3 mm. in diameter, was introduced into the mouth aperture. The animal is manoeuvred along to a glass wall, and then under the eyes of the experimenter the aperture of the punch is centred in relation to the statolith. When this is done the punch is pressed against the smooth glass wall so that the whole sense organ is removed. Immediately after the operation no swimming plates are striking.

1 h. 20 m. The animal is again placed in a cuvette containing sea-water without any addition.

1 h. 27 m. In one row two of the first swimming plates are removed by the operation; this row is still mostly immovable. Sporadic ciliary waves occur on all the other rows, but they are nowhere synchronous in two adjacent rows.

1 h. 31 m. The animal is transferred again to the aquarium.

7 h. 42 m. The animal rotates at one spot on the bottom of the aquarium. No regularly slower vibration can be observed in the lower rows; it is fairly often the other way about. When the lips are touched an inhibitory effect is certainly perceptible, but it seems to be limited to the rows that are nearest to the place of contact. It cannot be decided with the naked eye whether an actual condition of immobility occurs, as in this case it lasts only a fraction of a second. No 'spontaneous' total stoppage of the ciliary apparatus can be perceived. Sometimes, on the other hand, there occur, as it were, periods of wild ciliary vibration.

1/8. 11 A.M. The opening of the wound is distinctly smaller today and its edges more even than yesterday. By means of mechanical irritation of the surface of the scar a total inhibition of the ciliary activity is easily caused. Although, as a rule, the animal has a very lively ciliary movement, there occur sometimes today spontaneous stoppages of short duration without any retraction of the rows.



11 h. 28 m. Today, too, total inhibition of the ciliary activity can be produced by mechanical irritation of the edges of the mouth. At the same time there is a quite insignificant retraction of the rows, but this by itself is not sufficient to explain the stoppage.

11 h. 40 m. It is noticed that the animal raises itself once or twice into a vertical position with the sensory pole upward, a position, however, that it is unable to retain.

11 h. 45 m. A 'spontaneous' and complete stoppage of the swimming plates, lasting about  $\frac{1}{4}$  minute, was observed.

12 h. 34 m. Electrodes are immersed into the cuvette where the animal is at the bottom. It is very difficult to get the animal into the proper direction in relation to the electrodes because of its rotatory movements (caused by two adjacent rows striking both with less frequency and with less amplitude than the rest). Temperature in the cuvette, 17.0°.

12 h. 37 m. *Longitudinal oro-central current.* With a current of density 0.47 m.amp./cm.<sup>2</sup> there is no perceptible inhibition. With 0.93 m.amp./cm.<sup>2</sup> there appears a long total inhibition.

12 h. 45 m. With 0.93 m.amp./cm.<sup>2</sup> stoppage for 14 seconds except for two waves on one row.

12 h. 47 m. With 1.47 m.amp./cm.<sup>2</sup> there is total stoppage even after 30 seconds. The animal is transferred again to the aquarium.

3 h. The water in the aquarium is replaced by fresh sea-water.

5 h. 46 m. The ciliary activity is more lively and especially more continuous than in a normal animal. The animal whirls around in the aquarium and now and again knocks against the wall of the aquarium with its mouth, but no total stoppage is observed on account of this.

2/8. 6 P.M. The conditions are the same as at 5 h. 46 m. yesterday.

3/8. On an examination with a Zeiss' binocular lens of high magnifying power it was found that the defect caused by the operation had healed. Six of the ciliated furrows have no connection with each other; two, on the other hand, are connected and in the two corresponding rows the waves are synchronous. The

animal is still unable to keep itself in a vertical position for any appreciable length of time.

6. Beroë, 20 mm. long, with a normal ciliary motion swims around in the aquarium just below the surface of the water. At 4 h. 6 m. the animal is transferred to a cuvette containing sea-water to which ethyl ether has first been added in the proportion of 3 volumes to 1000, after which the mixture has been shaken up in a closed bottle. The cuvette is covered with a glass lid.

4 h. 7 m. After the transference to the cuvette the number of ciliary waves is greatly decreased. Some ciliary waves die off at a short distance from the sensory pole.

4 h. 8 m. The animal makes powerful contractions, by which a secondary inhibition is caused, which is a total one. Temperature in the cuvette, 20.3°.

4 h. 11 m. The contractions are repeated. The swimming plates are still.

4 h. 14 m. A single ciliary wave is visible in two rows.

4 h. 15 m.—4 h. 21 m. The body is contracted at intervals varying between 4 and 80 seconds. Now and then there is seen nearest to the sensory pole on some row a ciliary wave that expires after a course of a few millimeters; otherwise the ciliary plates are still.

4 h. 25 m. The contractions of the body become more and more infrequent. For long periods the rows of swimming plates are quite on the surface, but nevertheless they are still.

4 h. 28 m. Ciliary waves now begin to run regularly along a single row; frequency =  $12/20$  sec. = 36 per min.

4 h. 31 m. The animal's shape is now normal, but in spite of that, apart from the row just mentioned, one sees only sporadic movements in the smallest swimming plates nearest to the sensory pole.

4 h. 38 m. Although slight contractions of the body still occur, regular ciliary waves now extend over the whole length of three rows and over almost half the length of one row.

4 h. 42 m.—4 hr. 45 m. On the row (the uppermost one) where the waves are the most frequent  $30/40$  sec. = 45 per minute are

counted and in addition a few that die out on the way. On the lowest rows the incomplete waves are considerably greater in number than the complete ones.

4 h. 52 m. The most frequent row now shows a total of  $30/26 = 69$  waves per minute.

5 h. 10 m. At present so many rows are striking and they strike so regularly and effectively that the animal is driven forward in the cuvette. Single inverse waves issuing from the oral pole are, however, also observed.

6 h. Except for occasional slight contractions of the body, the animal seems to be in a normal condition: it has a regular ciliary motion and alters its position in the cuvette. The animal thus seems to have grown accustomed to the prevailing concentration of ether.

7. 9/7. Beroë, 20 mm. long. In the aquarium, the animal stays at the bottom, mostly in a horizontal position, the frequency of the waves being 100 to 170 per minute; the temperature is  $16^\circ$  at 5 h. 40 m.

5 h. 46 m. The animal is transferred to a cuvette containing sea-water to which has been added sulphas atropicus in the proportion of 1:1000.

5 h. 47 m. The animal has a more rapid ciliary motion than just previously; the frequency of the waves in one row is  $20/5.5$  sec. = 218 per minute. Temperature,  $17.5^\circ$ .

5 h. 51 m. The animal begins to carry out spasmodic contractions, during which it is deformed by partial drawing in of the meridional rows.

5 h. 55 m. Electrodes are immersed into the cuvette. Subsequent observations are made on closure of a longitudinal orocentral current.

5 h. 59 m. Current of density  $0.35$  m.amp./cm.<sup>2</sup>; no inhibition occurs.

6 h.-6 h. 7 m. Current of density  $1.42-2.17$  m.amp./cm.<sup>2</sup>; no primary inhibition occurs, but certainly a secondary one, caused by the animal's retraction of the rows some moments after the closure of the current. Where this retraction is not sufficiently intense the ciliary motion goes on continuously at an exceedingly rapid speed.

6 h. 8 m.—6 h. 10 m. In the absence of any interference, the ciliary motion is exceedingly frequent without driving the animal forward. The animal is transferred once more to the aquarium.

7 h. 13 m. The ciliary action is still abnormally frequent, but drives the animal forward in the aquarium. Transference to the cuvette, in which has previously been poured water from the aquarium in which the animal is kept; lowering of electrodes into the cuvette.

7 h. 18 m.—7 h. 30 m. The animal seems still to be under the influence of the atropine. At any rate there is still no primary inhibition of the ciliary motion on closure of a longitudinal oro-central current, but only secondary inhibition as a result of the contraction of the body and the accompanying retraction of the rows. The latter effect is fully developed even with a current of 1.11 m.amp./cm.<sup>2</sup>

7 h. 45 m. The animal is again transferred to the aquarium, which has in the meantime been filled with fresh deep-sea water.

10/7. 12 h. 34 m. The ciliary activity seems normal to the eye. The animal is transferred to a cuvette containing sea-water from its own aquarium and immediately swims to the bottom. Electrodes are immersed. The effect of a longitudinal oro-central current is tested.

12 h. 37 m.—12 h. 38 m. With a current of density 0.76 to 1.11 m.amp./cm.<sup>2</sup> there is inhibition of the frequency without any drawing in of the rows, but not total stoppage.

12 h. 39 m. With a current of density 1.52 m.amp./cm.<sup>2</sup> the observed row stops completely. In another row, however, there still seem to be some waves.

12 h. 41 m. With a current of density 1.92 m.amp./cm.<sup>2</sup> there is total primary inhibition in six rows, diminution of the frequency in two.

8. A Beroë, 22 mm. long, caught the day before. It was observed on several occasions that the ciliary movements of this animal showed 'spontaneous' stoppages of a few seconds' duration.

4 h. 15 m. The animal is transferred from the aquarium to a cuvette in which has been previously poured sea-water from the same aquarium. Temperature in the cuvette 17.5°C.

4 h. 17 m. In a row with mean frequency the number of waves is found to be 20/25 sec. = 48 per minute. Tube electrodes are lowered into the cuvette.

*Experiments with closure of a longitudinal oro-central current.*

4 h. 26 m. With a current of density 0.53 m.amp./cm.<sup>2</sup> there is no perceptible inhibition.

4 h. 28 m. With a current of density 1.07 m.amp./cm.<sup>2</sup> there is no perceptible inhibition.

4 h. 30 m. One row shows, when there is no current, a frequency of 20/21.5 sec. = 56 per minute. After a current of density 1.67 m.amp./cm.<sup>2</sup> has been closed no wave is seen, during an observation time of 22 seconds, in the aboral part of the row, but notwithstanding there are observed a couple of waves in the most oral part of the row.

4 h. 33 m. Without any current there is in one row a wave-frequency of 20/14 sec. = 86 per minute. After a current of density 2.33 m.amp./cm.<sup>2</sup> is closed total inhibition ensues. In the aboral part of the animal all the swimming plates are still for 50 seconds, but then occasional waves occur on a few rows.

4 h. 36 m. The animal is observed with the naked eye, while a current of the same density as before is closed. It is then observed that after a total inhibition affecting all the swimming plates for 10 seconds, while the current is kept closed, ciliary waves begin to appear after 10 seconds on one row, after 20 seconds on another and after 60 seconds on a third. These waves begin a short distance down on the row at about half-way between its aboral origin and its equatorial point. No motion is visible nearer to the sensory pole.

During the period from 4 h. 37 m. till 4 h. 48 m. it is observed that as a rule the animal shows a rapid ciliary activity but that it continues now and then to stop the ciliary movements entirely. The inhibitory apparatus is thus intact.

4 h. 49 m. The animal is transferred to another cuvette, in which to the sea-water has been added atropin sulphate in the proportion of 2:10000. Temperature in the cuvette, 18.2°C.

4 h. 50 m.—5 h. Total stoppages lasting a second or two are still observed. The animal does not show anything at all remarkable.

5 h. 1 m. The animal is removed to a cuvette containing seawater with an admixture of atropin sulphate in the proportion of 32:100,000.

5 h. 5 m. The waves are regular; on a couple of rows it was impossible to count them.

5 h. 7 m.—5 h. 17 m. The rows are generally somewhat drawn in. The animal begins to show occasional contractions of the body, especially at the sensory pole, which are accompanied by secondary stoppages of the ciliary apparatus. To mechanical irritation, even at the edges of the mouth, the animal reacts exceedingly easily with contractions of the smooth musculature.

5 h. 23 m. Electrodes having been introduced, a longitudinal oro-central current is tested. If such a current of density 2.33 m.amp./cm.<sup>2</sup> is closed the swimming plates stop and remain stationary, although the retraction of the rows is rather slight. The effect is immediate and the moment after the current is broken regular ciliary waves begin to break forth.

5 h. 35 m. The ciliary activity is now violent in most of the rows, but the animal does not move from the spot. No spontaneous total stoppages can any longer be seen. The synchronization of pairs of the rows is disturbed.

6 h. 42 m. After the rheonome has been inserted so that one is able to alter the strength of the current uniformly, it is observed that when the density of the current is slowly raised from 0 to 0.67 m.amp./cm.<sup>2</sup> no alteration is perceptible in the ciliary activity; with the increase of the current from 0.67 to 2.13 m.amp./cm.<sup>2</sup> the ciliary activity only becomes still wilder than before.

When the density of the current is still further increased no primary inhibition is observed, but with a current of density 2.67 m.amp./cm.<sup>2</sup> a contraction of the animal suddenly takes place, with secondary inhibition of the ciliary apparatus.

6 h. 50 m. The same procedure as before is repeated, with the same result, except that the contractions and secondary inhibition occur now at 2.40 m.amp./cm.<sup>2</sup>

In some experiments on *Beroë*, using cocaine (0.1 to 0.5 per cent cocain chloride), effects were observed resembling in many respects those caused by atropin. It is accordingly probable that cocaine also paralyzes the primary inhibitory apparatus of the swimming rows. In addition it strongly stimulates the smooth musculature. On account of scarcity of material of the animals it was impossible, however, to arrange as many experiments with cocaine as would have been desirable. In an experiment with chloroform (0.5 per cent) this turned out at first to stimulate both the primary and the secondary inhibitory apparatus of the swimming rows. After about 20 minutes' effect both the musculature and the ciliary rows were totally paralyzed, but the animal was still clearly transparent. On being returned to the aquarium it recovered, at least partly. The effect of chloroform resembled, although not in all details, that of ethyl ether.

A number of experiments in which specimens of *Beroë* were subjected to the effects of curarine, stovaine, and amylenhydrate did not appear to give any direct information as to the inhibitory mechanism of the rows of swimming plates and are accordingly left out of consideration here. Curarine in a concentration of 1:10,000 did not paralyze the swimming plates or their primary inhibitory apparatus, but stimulated the smooth musculature of the animal.

9. Experiments on isolated swimming plates of *Beroë*. The preparations for these experiments were obtained by shaking specimens of the animal in a test-tube with a slight amount of sea-water, so that the meridional rows were mechanically broken up into separate swimming plates. For reasons of economy, I selected for these experiments such animals as had suffered some minor injury when being caught. Two quite uninjured, though small, individuals, however, were treated in the same way: these had shown a rapid motion in the aquarium before they were shaken to fragments. But in the shaken preparations of these animals there was not found a single spontaneously active swimming plate. It must, however, be added that the preparation in question was not watched for longer than about an hour.

During my stay at Kristineberg in 1919 no ctenophores were obtained except *Beroë*. I had thus no opportunity of directly comparing the automatism of the swimming plates of *Beroë* and of other ctenophores under similar conditions. But to judge from my recollection of my visit to the same place in 1913, when I had a fairly plentiful supply of *Bolina* and *Pleurobrachia*, the automatism in mechanically isolated swimming plates is, at least in *Bolina*, considerably greater than in *Beroë*.

My experience shows that a large amount of material of *Beroë* is needed in order to find in the shaken preparations any isolated swimming plates that continue to vibrate sufficiently long to make it possible to test the effect of an electric current on their automatism and frequency. I was only able to achieve this desideratum in two experiments, one of which will shortly be described. Before doing so, however, I shall give a short account of my arrangements for studying the influence of the current on isolated swimming plates.

The material that had been obtained by shaking was transferred to and observed in a glass chamber constructed as follows. On a microscope slide a strip of wax is poured, 3 mm. high and 3 mm. wide, in the shape of a rectangle, so that it encloses a basin 37 mm. long by 18 mm. broad. At the middle of each short side a strip of wax 9 mm. long was removed and in its place there was fixed by means of Canada balsam, a strip of rattan of the same dimensions, the pores of which were directed from the outer side to the inside of the strip. Before each experiment the basin stood overnight filled with sea-water, so that all the pores were filled with this.

The microscope slide with the chamber is placed on the stage of a microscope. The clay points of two Du Bois-Reymond 'Thon-Stiefel-electrodes' are placed one at the outer side of each rattan strip. The source of the current is the same as in previous experiments. A commutator allows one to make whichever electrode is desired the cathode.

Experiment 3/8. The basin is filled to a height of approximately 2 mm. with the shaken preparation made from a *Beroë* that previously had a rapid ciliary motion. At about 6 mm.



from one of the short walls of the basin a swimming plate (no. 1) is observed striking automatically, with at least five strokes a second when there is no current. The nearest electrode is made the cathode. A current of 7 milliamperes (approximately = 19.4 m.amp./cm.<sup>2</sup>) is closed through the chamber (1 h. 41 m.). Swimming plate no. 1 continues, as far as the eye can judge, to strike with unaltered rapidity. In addition, an adjacent swimming plate (no. 2), which had formerly been still, also begins to vibrate. The current is broken.

1 h. 46 m. No ciliary element within the field of vision vibrates when there is no current. After a current of the same strength as at 1 hr. 41 m. has been kept closed for 12 seconds another swimming plate (no. 3), which was previously motionless, begins to strike. The circuit is opened.

1 h. 50 m. Conditions at start: Without any current neither no. 1, 2, nor 3 vibrate. A current of the same strength is closed. After 10 seconds no. 3, and after 3 more seconds, no. 2, begins to vibrate. No. 1 remains motionless. The current is now broken.

1 h. 54 m. Conditions at start: no. 2 and 3 are vibrating, no. 1 is still. A current of 6.5 m.amp. is closed (density approximately = 18.1 m.amp./cm.<sup>2</sup>). The two first-mentioned swimming plates continue to move with increasing intensity, but stop immediately when the current is shut off. No. 1 was still the whole time. The circuit is broken.

2 h. 29 m. Another swimming plate at a distance of only 4 mm. from one of the strips of rattan vibrates rapidly without any current. The nearest electrode was made the cathode. A current of 6.5 m.amp. (approximately = 18.1 m.amp./cm.<sup>2</sup>) produces a violent increase in the frequency of vibration, which continues until, after 10 seconds, the current is shut off.

2 h. 34 m. Another swimming plate at a distance of 4 mm. from the cathodic strip strikes spontaneously without any current. A current of 1.5 m.amp. (approximately 4.2 m.amp./cm.<sup>2</sup>) is closed. During the 10 seconds the current is kept closed the frequency of the ciliary motion in the plate in question is only accelerated.

2 h. 35 m. The same plate continues to strike rapidly without any current. A current of 0.7 m.amp. (density approximately 1.9 m.amp./cm.<sup>2</sup>) is closed, but during an observation of 10 seconds there is no inhibitory effect at all on these vibrations.

10. Experiment carried out 19/6 1913 and described in an earlier work by the author ('17, p. 535).

From a 50-mm. long Beroë, caught the same day, there is cut from a spontaneously moving row in its aboral half a piece 10 mm. long and also some of the underlying gelatinous substance. There are twenty-one swimming plates on the piece of row in question. The preparation is placed in a circular glass vessel measuring 33 mm. in diameter and 9 mm. in depth; this contains sea-water. In the extension of the piece of the row are placed the two clay points from two Du Bois-Reymond unpolarizable electrodes. The source of the current consists of dry elements: with two elements the strength of the current in the circuit is 4 milliamperes, with five elements it is 11.5 milliamperes. The direction of the current can be altered by means of a commutator.

The piece of the row that was cut out shows at first no spontaneous ciliary motion, but is affected exceedingly easily by mechanical stimulation. The least motion in the liquid causes vibration. Gradually spontaneous vibration begins to appear, with ciliary waves which have the same direction in relation to the row as they showed in the natural position. After spontaneous ciliary action had gone on for a short while the following experiments were carried out.

*With two elements.* The cathode is placed beyond the end of the row that was facing the animal's sensory pole when in the natural position. At a time when the ciliary frequency is from two to three a second, the current is closed. After a few waves the swimming plates stop, first in the half that is situated nearest to the cathode, then in the whole preparation; the circuit is then broken. After a short pause the commutator is reversed and the current closed. An inhibitory effect is then observed only in the three or four swimming plates that now lie nearest to the cathode.

*With five elements.* While the negative electrode is situated outside the end of the sensory pole of the preparation and the latter shows a comparatively rapid spontaneous ciliary vibration, the current is closed. The nine swimming plates nearest to the cathode then stop, while the twelve nearest to the anode continue to vibrate. The current is then broken.

After a short pause and after the direction of the current has been reversed, a current is sent through the preparation while the vibration still continues. Then the nine swimming plates that are now situated nearest to the cathode (i.e., plates quite different from the previous ones) stop, while the ciliary motion continues in the twelve that are nearest to the anode.

11. A *Beroë*, 18 mm. long, is investigated at a temperature of 16°. The animal keeps to the bottom of the cuvette in the usual horizontal position. While the ciliary action continues the animal glides along the bottom of the cuvette. It is observed that the ciliary activity is slower on the rows that are situated below the meridian plane through the points of the polar fields than on those that are above this plane. With the help of glass rods with round ends the animal is carefully moved into such a position that the same meridian as before remains horizontal, but that the half of the animal that previously faced downward now faces upward, and vice versa. In this position, too, i.e., after a turn of 180°, the rows that face downward have a less frequent ciliary action than those that face upwards. The animal is restored to its former position in the same way. After this is done the rows on the half of the body that is lowest show once more a slower ciliary motion.

The same observations were made on several different occasions and with several different animals.

On one occasion when a *Beroë* 24 mm. long is observed in the usual horizontal position at the bottom of the cuvette at a temperature of 16.7°; an attempt is made with a stop-watch to count the frequency in the upper and lower rows. On the lower rows thirty-nine waves in 45 seconds are reckoned (= 52 per minute); on the upper ones the number of waves cannot generally be counted with the naked eye, and in any case it is

greater than three per second ( $> 180$  per min.). On one occasion, however, the frequency sank so that it became possible to count. The frequency was then  $40/23$  sec. = 104 per min.

In the case of animals that took up a vertical position at the bottom of the aquarium with the oral pole downward and had, as far as the eye could judge, the same rapidity of ciliary motion in all the rows, it was observed that if one carefully moved them to a horizontal position they rose again into a vertical position, generally by decreasing the rapidity of the ciliary motion in the lower rows. Whether in my experiments there was also an acceleration of the frequency in the rows on the upper half of the body compared with that of the vertical position, as Verworn describes ('91, p. 448) I cannot venture to decide, as this change of position was only observed in individuals that had so rapid a ciliary motion even in the vertical position that the number of waves could not be counted with certainty with the eye and a stopwatch.

12. A *Beroë* 18 mm. long began to be observed in the aquarium at a temperature of  $14^{\circ}\text{C}$ . on the 30th of July at 10 h. 30 m. A.M. It remains at the bottom of the aquarium, has a normally rapid ciliary motion, and on some occasions shows spontaneous stoppages lasting for a few seconds. The animal is transferred to a cuvette at 10 h. 42 m.

10 h. 45 m. By touching the circumference of the animal's mouth with a smooth round glass rod a total stoppage lasting 2.5 seconds is caused without any drawing in of the rows. Temperature in the cuvette,  $15.7^{\circ}$ .

10 h. 48 m.—11 h. 38 m. As long as the animal is in the usual horizontal position the rows on the lower half of the body strike with a slower frequency than those on the upper half, no matter which half of the body is turned downward. On one occasion the animal took up such a horizontal position that the meridian through the points of the polar fields became vertical. Even in this position the ciliary activity on the lower half of the body was slower than that in the upper part.

11 h. 40 m. For the purpose of narcosis the animal was transferred into a cuvette containing sea-water with a 0.1 per cent

admixture of chloral hydrate. In this liquid the ciliary activity becomes accelerated. At 11 h. 55 m. the animal was transferred to another cuvette, in which to the sea water there is added 0.2 per cent of chloral hydrate.

12 h. All motion of the swimming plates has stopped; the animal is flaccid, its mouth wide open, and it shows no reaction to mechanical stimulation.

12 h. 2 m. The animal is brought in this narcotized condition into a glass aquarium with plane walls. Here the sensory pole of the animal is removed by an operation of the same kind as in experiment 5, but using a punch 4 mm. in diameter. After this has been done one can with a suitable adjustment see from the animal's aboral pole through a tunnel into its enteric cavity. The polar fields of the animal are situated in the piece stamped out.

12 h. 25 m. The animal is transferred into an aquarium with sea-water and no chloral hydrate.

2 h. 2 m. The swimming plates are still motionless. After the animal has been transferred to a cuvette it is established by means of a Zeiss' binocular lens that the cut has proceeded at about the termination of the ciliated furrows in the swimming rows, yet so that on a couple of rows up to four of the most aboral ciliary plates have also been removed.

4 h. 47 m. Temp. in the cuvette  $17^{\circ}$ . There is now vibration in all the rows, but besides direct waves a few inverse ones are observed proceeding from the oral pole. The synchronization of pairs of rows has ceased. In the horizontal position no reduced ciliary activity is noticeable in the rows that are for the time being lowest. When any row has a slower ciliary activity it has it in all positions, as far as this can be tested merely by observation with the eye through a lens.

7 h. 19 m. Touching the lips of the animal causes a short inhibition of the ciliary action, but this inhibition is not total; it seems to be confined to the rows that are situated nearest to the place that is stimulated.

31/7-1/8. The tunnel that existed on the 30th of July after the operation is now (31/7, 11 A.M.) found to be closed. New

tissue now constitutes the bottom of a cavity, at the edges of which the meridional rows begin with slight asymmetry in their arrangement. The animal shows a quite uninterrupted ciliary activity with a rapid frequency. During this it whirls around in the aquarium instead of moving in a more extended course, as does a normal animal. There are scarcely more than mere indications of spontaneous stoppage.

2/8. Today a few 'spontaneous' total stoppages without any retraction of the rows are observed. The animal sometimes rises into a vertical position with its sensory pole upward, but cannot maintain this position, striking over in the opposite direction. Even if one gives the animal the vertical position just mentioned, it appears to be unable to maintain it.

3/8. 2 h. 15 m. No wound cavity is now perceptible on examination with a Zeiss binocular lens; the former cavity has been quite filled up with a red-pigmented fimbriated tissue. Total inhibition of the meridional rows can now be brought about by touching the edges of the animal's mouth; it is accompanied by such a slight retraction of the rows that this cannot produce stoppage in a mechanical way. The animal still shows in the horizontal position no constant difference between the rapidity of vibration in the upper and lower rows.

#### DISCUSSION OF THE RESULTS OF THE EXPERIMENTS. THEORETICAL CONSIDERATIONS

In the preceding chapter experiments have been described which indicate that primary total stoppage of the swimming plates in *Beroë* can be produced either by mechanical, electrical or chemical stimuli. I shall first discuss in more detail the special circumstances under which each of these different stimuli showed itself to be effective.

In experiments 4 and 12 it is shown—an observation which as a matter of fact was made on many occasions with different individuals—that mechanical stimulation of the edges of the mouth and also mechanical stimulation of the polar fields caused stoppage of the swimming plates without any retraction of the rows.

The galvanic current produces primary stoppage in all the swimming plates only when it is sent through the animal in a longitudinal direction with the cathode outside the sensory pole ('longitudinal oro-central current'). In experiment 3 it was determined, by continually increasing the strength of the current, where the threshold, expressed as density of the current, lies for the galvanic inhibitory effect. In an animal 23 mm. long at a temperature of 17°C. it was found that the lowest density of current with which a total stoppage of the swimming plates lasting 5 seconds was attained lay between 1.47 and 1.60 m.amp./cm.<sup>2</sup> In a number of specimens, however, without a direct threshold determination having taken place, total inhibition appeared with a considerably lower density of current, e.g., in experiment 2 with 0.77 m.amp./cm.<sup>2</sup> in a 26-mm.-long animal at 16°C. The total inhibition that can be attained with a galvanic current of the order of magnitude just mentioned is limited in time and usually does not last more than a minute. In experiment 8 there are more exact determinations of time which show, in addition, that the inhibition may have a different duration in different rows of the same animal.

The primary inhibition when a galvanic current is transmitted originates from the cathode. This is shown in a particularly convincing way by experiment 10. In an earlier work I have put forward additional proofs of this, obtained from experiments with a transverse transmission of the current, when the anode and the cathode have been situated in the equatorial plane of the animal outside two diametrically opposite rows. In these experiments primary inhibition took place at the cathode with so weak a current that it did not exert any inhibitory effect at the anode; with a considerably stronger current, an inhibitory effect appeared at the anode, but this was secondary, due to contraction of the animal's body there.

The transmission of a longitudinal current with the cathode outside the oral pole ('centro-oral current') evokes, when the current is rather strong, an inhibition, which is, however, chiefly secondary, due to a contraction of the animal's aboral part situated nearest to the anode (experiment 1). That, however, even

with this direction of the current, effects of primary inhibition occur in the neighborhood of the cathode, I have shown earlier in animals which had been operated on so that a short equatorial part of a meridional row had been removed beforehand. If, in such a case, after the ciliary activity has returned on both halves of the row, a centro-oral current of suitable strength is transmitted through the animal, the oral half of the row stops without being drawn in ('17, exp. XI), while the aboral part continues to strike.

When a *Beroë* is put into sea-water containing 0.3 per cent of ethyl ether (experiment 6) there is a rapid and strong reduction of the frequency of vibration and a number of ciliary waves expire in their course along the meridional row. This I take to be an inhibition as a result of chemical stimulation, as I consider it at least improbable, that after an influence exerted for less than a minute by the weak solution of ether the ability to conduct, inherent in the meridional row, should have been extinguished by ether that had penetrated in. As we know beforehand about the inhibitory conditions that can be produced by mechanical means, it seems far more probable that the inhibition in the experiments with ether was caused by a 'sensible' stimulation of the surface layer of the body. As, however, in an animal without any central nervous system a stimulation can of course scarcely cause any perception, the more general expression receptor stimulation seems to be here preferable to sensible.

The primary inhibition affects the row of swimming plates itself and is not a transmitted effect from the more typical ciliary epithelium at the sensory pole. Evidence in favor of this is found in the result of experiment 10, where the cathodic inhibition appears especially distinctly in a piece of a meridional row that had been cut out together with a portion of the underlying tissue. An additional proof is found in experiment 5. In this experiment from an animal 14 mm. long there was removed by operation a circular area at the sensory pole with the statolith as center and a diameter of 3 mm. When, twenty-four hours later, the animal had barely recovered from the acute excitatory effects of the operation, it was observed that both touching the



edge of the mouth and touching the surface of the wound caused primary inhibition in the swimming plates, as well as that transmission of an oro-central current produced primary inhibition at an equally low density of current and also in other respects in the same way as in an intact animal.

When one considers the ease with which by suitable electrical stimulation one can produce a primary inhibition in a Beroë row, it seems very remarkable that I was never able to observe that a similar electrical stimulus had an inhibitory effect on an isolated, spontaneously striking, swimming plate. My experiments as to this were carried out by following through the microscope, the movements of a spontaneously vibrating ciliary plate and suddenly exposing it to the influence of a cathodic field. Such observations are described in experiment 9. Neither in this nor in other experiments where satisfactory precautions have been taken to prevent electrolytic products from reaching the preparation have I observed that a spontaneously vibrating swimming plate of a Beroë has moved more slowly or stopped under the influence of a cathodic field, but I have certainly observed that spontaneously striking swimming plates have accelerated their activity and that previously stationary plates have begun to vibrate when a cathodic field has arisen around them.

From observations on shaken preparations of Beroë it seems to me to appear that isolated swimming plates of Beroë have, as a rule, a rather small degree of automatism, especially in comparison with isolated plates of Bolina. The assumption that the automatism in the swimming plates of Beroë is relatively slight in comparison with that of other ctenophores seems also to be supported by a statement of C. F. W. Krukenberg ('80, p. 17) that "abweichend von dem Verhalten der Beroë, bei Chiaja der Ruderschlag an allen Theilstücken seinen völlig normalen Character, gleich von der Zeit ihrer Abtrennung an, bewahrt." One may also compare the result I have described in experiment 9 of shaking to fragments a Beroë in full ciliary activity with a slight quantity of sea-water with Parker's observation ('05, p. 413) on Mnemiopsis under similar conditions. He writes:

“When a Mnemiopsis is shaken in sea-water it can be broken easily into fragments and the plates attached to these pieces will continue to beat rhythmically and metachronally for from one to two days. . . . in Mnemiopsis even a single plate with a small basal piece of protoplasm will beat rhythmically for a long time.” It will probably be obvious that a low degree of automatism must be a favorable factor for inhibitory influences, since by means of it the latter have a smaller resistance to overcome. It seems to me, therefore, to be probable that there is a certain connection between the marked liability to inhibition shown by the meridional rows in *Beroë* and the slight automatism of its separate swimming plates. I have not investigated systematically whether such ctenophores as, like *Bolina*, have swimming plates with more developed automatism also have a primary inhibitory apparatus. As I have shown in an earlier work, the transmission of a longitudinal oro-central current causes in *Bolina* and *Pleurobrachia* a marked increase in the frequency of the ciliary waves, which is obviously the contrary to what is the case in *Beroë*. In *Bolina*, however, this increase is preceded by a short stoppage, limited to a fraction of a second ('17, exp. II and III). Whether this stoppage presupposes a mechanism for primary inhibition or whether there is such a mechanism at all in any other ctenophore except *Beroë*, I consider, however, to be a still unsolved problem.

A number of observations support the idea that the automatism in the separate plates in *Beroë* is not equally marked in all parts of a row, but is more marked in its aboral part, less in its oral part. Thus Th. Eimer ('73, p. 45, note 3) cites the following observation made in the case of expiring animals: “Die in der Gegend des Mundes gelegenen Plättchen sind längst todt, während die übrigen noch lustig fortschwingen.” In my experiment 3 it is seen that when an oro-central current of density 2.47 m.amp./cm.<sup>2</sup> has been transmitted for a short while through an animal slightly poisoned with chloral hydrate and during this time has maintained total inhibition, after the current is broken the first waves are limited to a short piece of the row nearest to the sensory pole, while the subsequent ones extend farther and

farther and finally over the whole row. A similar state of affairs was seen in experiment 6 under the influence of ethyl ether and was indicated by the fact that the number of waves was greater near the aboral pole than in the neighborhood of the oral pole. It is true that in my experiments 3 and 6 another possible explanation is present, namely, that the strength of the inhibitory impulse itself might be greater at the oral than at the aboral part of the row, but in the case of experiment 3 such an explanation would scarcely fit in with the fact that the inhibitory effect of the electric current proceeds from the cathode. It seems to me therefore more probable that the difference in the strength of the inhibition or the after effect of the inhibition, respectively, in different parts of the row in experiments 3 and 6 is due to the fact that the automatism of the swimming plates is more pronounced in the aboral part of the row than in its oral part.

When in experiment 10, a cathodic inhibition of the movements of the swimming plates could be shown in a piece of row cut out together with the tissue lying immediately below, but, on the other hand, no cathodic inhibition could be observed in isolated swimming plates, then there are the two following possibilities of an explanation of the primary inhibition on electrical stimulation. Either the cathodic influence extinguishes or weakens, respectively, the direct transmission in the neuroid connection that exists between each plate and the adjoining plates in the row or else the neuroid conductive path between the separate plates or the plates themselves are under the influence of a primary inhibitory apparatus which can be stimulated by an electric current.

It seems to me possible to come to a decision between these two alternatives on account of the observations made as to the primary inhibition caused by mechanical and chemical stimulation, respectively, in *Beroë*. The slight touching of the edges of the mouth which in the experiments resulted in a primary inhibition of the meridional rows can scarcely in any purely mechanical way or directly at all constitute any obstruction to transmission between the separate swimming plates in the row. Nor can

the practically immediate appearance of primary extinguishing of certain ciliary waves during their course through the rows—in the experiment with a dilute solution of ether—be possibly due to the ether having in this short time penetrated into and directly extinguished the conduction of the impulse between the swimming plates. For, if this were the case, we ought not to find in the same experiment that the waves gradually get back their full extension, although the concentration of the ether is not changed during this time.

In both cases we must have been concerned instead with a transmitted effect that was presumably produced from receptory apparatuses on the surface of the animal which have been stimulated, in one case mechanically, in the other case chemically and osmotically by the dissolved ethyl ether. In the case of the galvanic current, it is more probable that it stimulates nervous or neuroid connections between the receptory apparatuses and the meridional rows. The first impression produced by experiments 3 and 6, inasmuch as in them waves from the aboral pole proceeded to a point in the course of each row and below it expired altogether, is that the inhibitory impulse transmitted from the receptory areas to the meridional rows affects the neuroid conductive path between the plates and not the plates themselves. It seems, however, to be difficult to exclude the last-mentioned alternative altogether, as when a plate in a meridian row stops it is usual in *Beroë* that all those situated orally to it also stop. In any case, it is necessary, if the primary inhibitory effect in all the occurring cases is to be explained, that from the ectoderm and to each row of swimming plates there should proceed paths which from a physiological point of view are characterized by the fact that they transmit cilio-inhibitory impulses and whose anatomical substratum must be denoted as cilio-inhibitory nerve fibres, provided they prove to be composed of elements which, not only physiologically, but also morphologically, have the character of nerve elements. That primary total inhibition of the swimming plates can be brought about from the edges of the mouth more easily than from other places on the surface of the body seems to agree with the fact that these edges are furnished

with a specially differentiated cylindrical 'sensory epithelium' (Chun, p. 159; Hertwig, p. 22).

Additional evidence in favor of the existence of a nervous inhibitory mechanism in *Beroë* can be obtained from a number of the experiments carried out with poisons. I found that the best means for narcotising *Beroë* was chloral hydrate. A solution isotonic with the sea-water is prepared. So much of this is added to one quantity of sea-water that the proportion of chloral hydrate is 0.1 per cent and to another quantity of sea-water so much that the proportion of chloral hydrate is 0.2 per cent. In both cases the mixture is well stirred. The animal is first transferred to the 0.1 per cent solution and, in the case of small specimens of animals as in my experiments, after about twenty minutes to the 0.2 per cent solution. With this method of procedure, after quite slight symptoms of excitation, which affect the musculature to a remarkably slight extent, the chloral hydrate gradually extinguishes both the neuromuscular excitability and the ciliary activity in *Beroë*.

Experiment 4 shows that there exists a stage of incomplete chloral-hydrate narcosis, when the inhibitory effect on touching the edges of the mouth has disappeared, but the ciliary activity in the plates still continues in the aboral part of the rows. In the animal in this stage an oro-central current of density 2–2.93 m.amp./cm.<sup>2</sup>, which in an intact animal produces total inhibition, causes an acceleration of the movements of the swimming plates.

In experiment 3 it can also be observed that with the progress of the chloral-hydrate poisoning there is an increase in the threshold of the current density with which inhibition is reached. If it were a fact that the inhibitory effect of the current directly influences the stimulus-conducting connection between the swimming plates by a direct reduction of their ability of conduction, one would expect that, in an animal which is to a certain extent poisoned by chloral hydrate and where the conduction of the stimulus is already weakened because of the poisoning, a weaker current would be sufficient to produce total inhibition than under normal circumstances. When one finds that, on the contrary, a stronger current is necessary to attain total inhibition, one must

assume that the inhibitory effect is connected with a formation which has its function reduced by the poison earlier and to a greater extent than the conductive bridge between the swimming plates. From a pharmacodynamic point of view, a formation of this kind, more sensitive to poison, can scarcely be anything else but a nervous conductive path, as narcotic poisons in the lowest concentrations affect nervous elements especially.

Experiments 7 and 8 show that atropin in concentrations that are greater than 3:10,000 has a marked influence on the ciliary apparatus. This influence is complicated, however, by the fact that the atropin also elicits contractions of the animal's body with secondary inhibition of the ciliary motion. If one manages, however, to observe an atropin-poisoned animal during the intervals between these contractions (experiment 8) one finds the frequency of the ciliary motion increased. If, also, during one of these intervals, one conveys a longitudinal oro-central current of the density that totally inhibits the ciliary motion in the rows of a normal animal, the effect proves to be (experiment 8) the same as in isolated, spontaneously striking swimming plates of the animal, i.e., an increase in the frequency of vibration. This increase can be observed right up to the density of current at which the threshold for the secondary inhibitory mechanism is reached and the animal contracts convulsively.

From these observations one may conclude that atropin in the degree of concentration mentioned reduces the irritability of and probably gradually completely paralyzes the primary inhibitory mechanism which in a normal animal is so easily caused to function by a longitudinal oro-central current. It is also noteworthy with regard to atropin that the paralysis of the inhibitory mechanism under its influence is developed decidedly more slowly than the corresponding paralysis caused by chloral hydrate (experiment 8 compared with experiment 4) and that, when the animal is put back again into fresh sea-water this paralysis disappears so slowly. On account of this, one is tempted to assume that the atropin must enter into some chemical combination in the tissues in order to be effective.

R. S. Lillie ('08, pp. 200, 219) has described certain phenomena of primary inhibition in *Eucharis* and *Mnemiopsis* that do not appear when Ca salts are not present: "Slight stimulation of a row of beating plates, a detached portion of a row, or even an active individual plate, with the extremity of a glass rod, is typically followed by immediate and complete cessation of movement. After an interval activity is resumed." "This susceptibility to mechanical inhibition is dependent on the presence of calcium salts." My material of *Beroë* was not sufficiently abundant to test whether the inhibitory mechanism in *Beroë* described above also needs the presence of calcium salts if it is to function. In three specimens of *Pleurobrachia* which on different occasions during the summer of 1913 I investigated in artificial sea-water according to Forchhammer's (cf. Knudsen, p. 16) prescription, but with a total exclusion of Ca, spontaneous ciliary activity of a fairly normal character went on for about two hours. It may be mentioned in passing that the most striking effect of the absence of Ca on this animal was a paralysis of the tentacles, which ceased when the animal was put back again into complete sea-water. From the observations cited it is only shown, with regard to the main question, that if the ciliary apparatus in *Beroë* resists the absence of Ca salts as long as in *Pleurobrachia*, one ought easily to be able to carry out, by using an electric current, a test as to whether the inhibitory apparatus in *Beroë* depends for its function on the presence of Ca salts.

The proofs given in this work of a primarily cilio-inhibitory mechanism in *Beroë* which follows in several respects the physiological and pharmacodynamic laws for a nervous formation are, as is seen from the preceding, based exclusively on tests as to function. It is no part of the plan of my work to investigate whether the substratum of this inhibitory mechanism is composed of elements which also deserve the name of nerve elements. This question, however, has such a great general importance that I cannot neglect it altogether in this connection, even if I cannot contribute toward its solution anything more than what is to be obtained from the literature.

As we know, it was for a long time a matter of dispute whether a nervous system in the morphological sense existed at all in the ctenophores or not. In this connection I will only refer to the results of investigations and opinions that have been put forward in later times, more precisely from 1880, when Chun's and R. Hertwig's fundamental works on the histology of the ctenophores were published. Among later investigators the most negative position is taken up by Samassa ('92, pp. 229-230), who rejects the idea of a nervous system in ctenophores, in general, but makes an exception in the case of *Beroë* in the following words: "Das nächste (i.e., highest<sup>2</sup>) Stadium stellt *Beroë* dar; hier sind Epithelzellen der Basalpolster aus ihrem epithelialen Verbande ausgeschieden und haben sich zu Fasern umgestaltet, welche die Basalpolster untereinander verbinden. Sie besitzen physiologisch offenbar nervenähnliche Function und, da sie auch histologisch den Charakter selbständiger Nervenfasern erlangt haben, so stehe ich nicht an, sie als solche zu bezeichnen."

The presumed inhibitory nerves ought, however, to begin with receptors at the surface of the animal, probably by preference at the edge of the mouth, the polar fields, and presumably also at the meridional rows themselves, and to extend to the basal connections between the swimming plates. R. Hertwig ('80, pp. 88-91) has actually described—even in *Beroë*—tissue elements, situated subepithelially in the gelatinous substance, which he explains as nerve cells with long processes. He found endings of these processes in, among other places, the surface epithelium and in the muscle cells of the gelatinous substance.

Hertwig's communication of a subepithelial nerve net in ctenophores has been confirmed by A. Bethe in preparations obtained by vital methylene-blue coloration. Nerve fibers ending in smooth muscle fibers in the gelatinous substance of *Beroë* are also described and reproduced by K. C. Schneider ('92, p. 448). On the other hand, I have been unable to find in the literature any statement to the effect that nerve fibers could be followed through the gelatinous substance to the meridional rows. In connection with this question it is of interest, however, to note

<sup>2</sup> Added by the writer, so that the context may be understandable.



a statement of R. Hertwig to the following effect: "Die Fäden des Meridiannerven reichen so weit als die Flimmerrinnen; wo diese mit einer Verbreitung an dem ersten Ruderplättchen aufhören, finden sie ebenfalls ihr Ende . . . Nur bei Beroë ovatus schien sich mir der Faserzug auch weiter über den bezeichneten Punkt hinaus unter die Plättchenreihen zu verlängern."

There is undoubtedly an intimate connection between primary and secondary inhibition of the ciliary apparatus in Beroë. If in an intact animal one wishes to produce primary inhibition by touching the edges of the mouth, or, still more, if one wishes to produce it from the polar fields, the mechanical stimulation must be carried out delicately. If the intensity of the stimulation is the least bit overdone, secondary inhibition occurs instead. In the case of the atropin-poisoned animal it was observed (experiments 7 and 8) that certain electrical and mechanical stimulations, which in a normal animal produce primary inhibition, caused secondary inhibition instead. I imagine, therefore, that both the primary and the secondary inhibitory apparatuses make use of the same receptors, but that the inhibitory nerve endings at the neuroid conducting tissue in the row are caused to function from the net of nerves by impulses of weaker intensity or less extension than the nerve endings in the smooth muscular cells need to cause their effector organs to contract.

As Verworn has shown, there occur in Beroë conditions when the animal systematically corrects a horizontal or slanting position to a vertical position and when the change in position is connected with primary inhibition or a slowing, respectively, of the ciliary motion in certain topographically defined rows. With regard to the situation of these rows, when the animal corrects a horizontal position at the bottom, see experiment 11.

A question connected with the present subject is whether the primary nervous inhibitory mechanism in Beroë is of any importance for the regularity of these corrections of position. In this question I have by my experiments arrived at the conclusion that in certain cases it is impossible to explain away the existence of an influence of this sort, but that it is of minor importance in comparison with the regulation caused by the statolith appara-

tus. One way in which the inhibitory mechanism can contribute to the correction of position is as follows. When a Beroë keeps a horizontal position at the bottom it follows as a matter of course that a number of the swimming plates of the lower rows might be affected mechanically by their own vibrations, as they are in direct contact with the medium at the bottom—an immobilization of the plates on account of the weight of the animal can scarcely take place. It is conceivable that this mechanical stimulation has a local inhibitory effect on the ciliary motion in the corresponding rows, while the upper rows work without any inhibition, and that as a result of this the animal rises up.

I have, as a matter of fact, seen two Beroës, a few days after the removal of their statolith organs by operation (experiments 5 and 12), rise into a vertical position at the bottom of the aquarium, although the animals were quite unable to maintain this position afterward. If a vertical position is to be definitely taken up, the statolith organ is indispensable, but a temporary quasi-correction of a horizontal position is thus shown to be possible, by the cases referred to above.

There are scarcely any starting-points for an experimental investigation of the causes of the not unfrequently observed 'spontaneous' total stoppage of the meridional rows lasting for a few seconds. It is equally conceivable that these spontaneous stoppages without any retraction of the rows may arise from a momentary cessation of the vibrations of the balancers or that they are due to an invisible stimulation, brought about by chemical or osmotic action, of the receptors of the primary inhibitory apparatus.

A common ecological significance of the two mechanisms for inhibition of the ciliary motion in Beroë consists in the fact that certain external stimuli impart through the mediation of these mechanisms a compulsory and important influence on the speed and direction of the animal's movements.

Two of the principal results of the investigation have a general physiological bearing and are consequently of interest apart from the species of the animal with which they have been obtained. One is that a movement which has all the main characteristics of

a ciliary movement and is developed phylogenetically from a movement of this sort is under the influence of inhibitory nerves. These cilio-inhibitory nerves are at present only established by the manifestations of their function. With regard to their morphology, there is still very much to be decided; this is especially the case concerning the way in which they are connected with the meridional rows. The second main result is that impulses which cause inhibition in distant organs are met with already in animals that lack a central nervous system.

#### SUMMARY

1. It is shown that in *Beroë cucumis* there occur conditions when all the swimming plates are inhibited in their movements, beat more slowly, or remain stationary in a position of rest, without any muscular retraction of the meridian rows.

2. These conditions of primary inhibition can be produced by mechanical as well as chemical and electrical stimuli.

3. Especially the primary inhibition which the author has found to occur when a galvanic current of about 2 milliamperes in density per  $\text{cm}^2$  is made to pass in the longitudinal direction of the animal with the cathode outside the sensory pole is accessible to an experimental examination in different conditions of the animal. The inhibitory effect of such a current issues from the cathode.

4. Certain nerve poisons, namely, chloral hydrate (0.2 per cent) and atropin ( $>0.3$  per cent), abolish the primary inhibitory effect of a current of the kind just mentioned. In animals treated with these poisons the closure of such a current produces at a certain stage, instead of inhibition, an acceleration of the ciliary motion. It is noteworthy that an acceleration is the normal effect of closing a similar current in *Bolina* and *Pleurobrachia*.

5. The primary inhibition of the ciliary movements in *Beroë* cannot be explained without the assumption of formations which, at least from a physiological point of view, serve as cilio-inhibitory nerves. These are paralyzed by chloral hydrate and atropin, probably by cocaine as well.

6. The primary cilio-inhibitory mechanism probably consists of receptors at the surface of the body, which transfer their impulses to a net of nerves. The nerve net in its turn transmits them to end apparatuses which inhibit the vibrations of the swimming plates, probably by blocking the neuroid conduction between them. At any rate, there is present an inhibitory mechanism acting at a distance in an animal that has no central nervous system.

7. The mechanism for primary inhibition also functions in specimens whose statolith apparatuses have been removed by operation, if one only waits for the moment when the stimulatory effects of the operation have disappeared.

8. There is an intimate connection between primary and secondary (i.e., muscular) inhibitory mechanism in *Beroë*. It is probable that they both use the same receptors, but the primary mechanism can be caused to function by impulses of weaker intensity than the secondary one.

## LITERATURE

- BAUER, W. 1910 Über die anscheinend nervöse Regulierung der Flimmerbewegung bei den Rippenquallen. *Zeitschr. f. allg. Physiol.*, Bd. 10, S. 231-248.
- BETHE, A. 1895 Der subepitheliale Nervenplexus der Ctenophoren. *Biolog. Zentralbl.*, Bd. 15, S. 140-145.
- CHUN, C. 1880 Die Ctenophoren des Golfes von Neapel. *Monographie I der Fauna u. Flora des Golfes von Neapel.* Leipzig.
- EIMER, TH. 1873 Über *Beroë ovatus*. *Zoolog. Studien auf Capri I.* Leipzig. 1880 Versuche über künstliche Theilbarkeit von *Beroë ovatus*. *Arch. f. mikrosk. Anat.*, Bd. 17, S. 213-240.
- ENGELMANN, TH. W. 1879 Die Flimmerbewegung. *Hermanns Handbuch d. Physiol.*, Bd. I: 1, S. 380-408. 1887 Über die Function der Otolithen. *Zool. Anzeig.*, Bd. 10. S. 439-444.
- GÖTHLIN, G. FR. 1913 Die doppelbrechenden Eigenschaften des Nervengewebes, ihre Ursachen und ihre biologischen Konsequenzen. *Kungl. Svenska Vetenskapsakademiens Handl.*, vol. 51: 1, 92 pp. 1917 Inverkan av konstant elektrisk ström på flimmerrörelsen hos kammaneter. *Upsala Läkareförenings Förhandlingar, Ny följd*, vol. 22, pp. 522-542.
- HERTWIG, R. 1880 Über den Bau der Ctenophoren. *Jena.*
- KNUDSEN, M. 1905 *Havets Naturlaere Skrifter udgivne af Kommissionen for Havundersoegelser n: o 2/.* Koebenhavn.
- KRUKENBERG, C. F. W. 1880 Der Schlag der Schwingplättchen bei *Beroë ovatus*. *Vergleichend-physiologische Studien zu Tunis, Mentone u. Palermo, Abt. III*, S. 1-22.
- LILLIE, R. S. 1908 The rôle of calcium salts in the mechanical inhibition of the ctenophore swimming-plate. *The Americ. Journ. of Physiol.*, vol. 21, pp. 200-220.
- MORTENSEN, TH. 1912 *Ctenophora.* The Danish Ingolf-Expedition, vol. 5, pt. 2, Koebenhavn.
- NAGEL, W. 1893 Versuche zur Sinnesphysiologie von *Beroë ovata*. *Arch. f. d. ges. Physiol.*, Bd. 54, S. 165-188.
- PARKER, G. H. 1905 The movements of the swimming-plates in ctenophores with reference to the theories of ciliary metachronism. *Jour. Exp. Zoöl.*, vol. 2, pp. 407-423.
- SAMASSA, P. 1892 Zur Histologie der Ctenophoren. *Arch. f. mikrosk. Anat.*, Bd. 40, S. 157-238.
- SCHNEIDER, K. C. 1892 Einige histologische Befunde an Coelenteraten. *Jenaische Zeitschr. f. Naturwissenschaft*, Bd. 27, S. 379-454.
- VERWORN, M. 1891 Studien zur Physiologie der Flimmerbewegung. *Arch. f. d. ges. Physiol.*, Bd. 48, S. 149-180. 1891 Gleichgewicht und Otolithenorgan. *Ibid.*, Bd. 50, S. 423-472.

Resumen por el autor, H. J. Muller.  
Universidad Columbia, New York.

Nuevos cambios en la serie de ojos blancos de *Drosophila* y su importancia sobre el modo de presentarse la mutación.

En el presente trabajo, el autor da a conocer tres nuevas mutaciones del alelomorfo normal (W) del locus del ojo blanco: 1) é cru, que apareció primeramente en un solo macho; 2) marfil, encontrada por Sturtevant en nueve hijos de una misma hembra; 3) blanca, encontrada un en ojo de un macho y transmitida a la progenie. Naranja, hallada en un macho y no transmisible es probablemente un alelomorfo adicional.

Estas mutaciones, con las siete mutaciones previas de W demuestran que las desviaciones considerables de este gene son tan aptas para ocurrir como las desviaciones pequeñas, las cuales probablemente son muy poco frecuentes, y que la selección aplicada a este locus no produciría efecto acumulativo.

Los colores de los ojos producidos por estos alelomorfos en diferentes combinaciones prueban que no son simplemente variaciones en la cantidad del gene. Conforme ilustran los modos de origen de las mutaciones, estas pueden presentarse en diferentes estados del ciclo vital. El hallazgo de mutaciones que aparecen en individuos aislados, mas a menudo que en varios individuos de una familia, no indica que las mutaciones tienen lugar mas fácilmente durante la maduración o la fecundación, y se explica por la existencia de un número mayor de células en los estados tardíos del ciclo vital. El autor dá a conocer un método mediante el cual puede estimarse la influencia de la multiplicación celular sobre los números relativos de las mutaciones sencillas, múltiples y en mosaico que se están produciendo. Las pruebas obtenidas en las mutaciones en mosaico indican además que la mutación tiene lugar en uno solo de los miembros de una pareja de alelomorfos en un tiempo determinado, y que el acto que produce la mutación está excesivamente localizado.

# FURTHER CHANGES IN THE WHITE-EYE SERIES OF DROSOPHILA AND THEIR BEARING ON THE MANNER OF OCCURRENCE OF MUTATION

H. J. MULLER

*Department of Zoology, University of Texas*

THREE FIGURES

## CONTENTS

Introduction.....	443
I. Écru.....	445
A. Manner of origin, and time of occurrence of the mutation.....	445
B. Locus, and mode of reaction with other members of the W series	446
II. Ivory.....	446
A. Manner of origin.....	446
B. Its reactions with the W series of allelomorphs.....	448
C. Locus of ivory.....	448
D. Time at which the mutation occurred.....	449
III. White.....	450
A. Manner of origin.....	450
B. Genetic behavior.....	452
IV. A possible additional allelomorph.....	452
V. The mutations of W as quantitative fluctuations of the gene.....	454
VI. The stage in the life-cycle at which mutation occurs.....	459
VII. The degree of localization of the event which produces the mutation..	469
Summary.....	470
Literature cited.....	473

The locus designated as W has yielded the largest series of multiple allelomorphs so far observed in *Drosophila*. It was at this locus that the factor for white eyes ( $w$ ) was found by Morgan ('10), whence the designation W for the normal allelomorph; subsequently to this eosin ( $w^e$ ) was found at the same locus by Morgan ('12), cherry ( $w^c$ ) and buff ( $w^b$ ) by Safir ('13, '16), blood ( $w^{bl}$ ) and tinge ( $w^t$ ) by Hyde ('16), and coral ( $w^{cl}$ ) by Lancefield ('18). The case of deficiency (Notch 8) found by Mohr ('19) should also be listed here, as this included a mutation in the locus W; although flies homozygous for this mutant

factor could not be secured, on account of the lethal action of the deficiency, the dilution of eye color which it produces when in combination with the other allelomorphs of *W* shows that in its color effect it is an 'ultra-white.' Each of the mutant allelomorphs of *W* arose by a single mutation from the normal gene, excepting eosin, which arose by a mutation of the gene white, and which is therefore removed from normal by two mutations. All of the allelomorphs affect the same character, eye color, and together they form a graded series.<sup>1</sup> And, in addition to the mutations originally observed, certain of the factors—*w* and possibly *w<sup>e</sup>*—have been found to arise more than once: white having arisen several times by 'reverse mutation' from eosin and the normal red eye color once reappearing by 'reverse mutation' from white (Morgan and Bridges, '19). The locus *W* therefore represents the nearest approach yet found in the fruit-fly to the supposititious condition of factor fluctuation which most selectionists have postulated, and the findings concerning it have in fact already been made use of by Jennings ('17 a, b) as an argument in favor of such views. Four more mutations, one of which probably, and three of which certainly, belong in the same series may now be reported; one of the latter, ivory, was found by Sturtevant, whose own account of it he has kindly allowed to be incorporated in the present paper (section II); the other three mutations were found by the author. It will be of interest to examine these mutations with reference to the question of factor fluctuation raised above, and also to consider the case as a whole in its present relation to the problem of mutation in general. The data concerning each of the new mutants will be given first.

<sup>1</sup> It had been thought (and mentioned in the literature) that these mutant allelomorphs also affected body color, inasmuch as flies containing them appear lighter than red-eyed flies after being killed and 'extracted' for several days in 50 per cent alcohol. I have found, however, that decapitated red- and white-eyed flies show no such difference after treatment with alcohol. The effect is obviously due to the red-eye color of the normal flies becoming partly dissolved by the alcohol and distributed through the body of the fly; flies with lighter eyes have less color to be thus distributed.



## I. ÉCRU

A. *Manner of origin, and time of occurrence of the mutation*

This mutant gene causes the eye to be of a very light yellow color, perhaps most aptly characterized as 'écru.' This color may easily be mistaken for white if white-eyed flies are not present for comparison, but comparison readily shows that the 'écru' eyes are distinctly yellower than the white. On the other hand, they are very slightly lighter than 'tinge' and 'buff,' which were heretofore the nearest to white in the series. Écru males and females are alike in color.

Écru appeared first among the descendants of a cross of a red-eyed  $\frac{j}{j}$  ♀ by red-eyed  $\frac{S'd_a^1}{j}$  ♂ (*j*—jaunty wings, *S'*—star eye, *d\_a^1*—lethal; all these factors are in chromosome II). In a cross of this sort certain of the offspring have the same composition as their parents, and these may be used to make another cross of a type exactly like that by which they themselves were produced. Thus, flies of the same heterozygous composition may be maintained and crossed generation after generation. In the present instance this process had been carried on for about five months (in order to maintain a stock containing the lethal), and during this time no other eye color than red appeared; but suddenly, in about the tenth generation, a single male fly was found with écru-colored eyes. That this male was a product of the cross, and not due to contamination from outside, was proved by crossing it to a  $\frac{j}{j}$  ♀, when it gave the count to be expected of a male of composition  $\frac{S'd_a^1}{j}$ . The mutant itself had star eyes, owing to the dominant factor *S'*. The écru color in this cross proved to be recessive, as all of the offspring were red-eyed except one sterile écru-eyed son, produced by primary non-disjunction. In the second generation, produced by breeding together the  $\frac{j}{j}$  offspring, half of the males and none of the females were écru, and the rest were red; this proved that écru was due to a single sex-linked factor.

Since males receive all sex-linked factors from their mother, this factor must have arisen by mutation in an ovarian cell of the mother of the original *écru* male (either before or after its fertilization, but probably before its cleavage). Since none of the brothers of this male were likewise *écru* the mutant gene could not have existed in many of the egg cells of the mother, hence the mutation could not have occurred in an early oogonial stage, but probably took place in a late oogonium or in an oocyte.

*B. Locus, and mode of reaction with other members of the W series*

*Écru* males were then crossed to white-eyed females, and produced daughters intermediate in color between *écru* and white. This showed that *écru* was either an allelomorph of white, or that, when present, it caused white to be partially dominant. To decide between these two unequal possibilities, the  $F_1$  from the cross of *écru* by white were then bred together, and it was found that no red-eyed crossovers were produced; *écru* therefore lay in the same locus as white, or was completely linked to it; in other words, the two mutants were allelomorphs.

Crosses of just the same type were performed with *écru* and eosin, and with precisely similar results. The  $F_1$  females were intermediate in color between *écru* females and eosin females, and in subsequent generations no crossing over took place between the two factors. There is consequently no question that  $w^{ec}$  is a member of the W series of allelomorphs, and that it behaves like the other mutants of the series in being recessive to normal (W), and in giving intermediates when crossed with white, eosin, and, presumably, with the other mutant members of the series.

## II. IVORY<sup>2</sup>

### A. Manner of origin

In an experiment designed to fix an increased value of crossing over in a part of the second chromosome, brother-sister pair

<sup>2</sup> The results in section II were obtained by Dr. A. H. Sturtevant, and nearly all of this section was written by him.

matings were made in successive generations. Each mating was of the type  $\frac{C_{III} C_{IIIr}}{b p_r c} \sigma^7 \times b p_r c \varphi^3$  ( $b$  = black body;  $p_r$  = purple eyes;  $c$  = curved wings). More recent experiments have shown that a third chromosome mutant was present also, and was at least in part responsible for the increased crossing over referred to (Sturtevant, '17). No evidence of the presence of any mutant genes in the X chromosome of this line has been found, except in the case now to be described.

TABLE 1

DATE OF COUNT	♀ ♀, EYE COLOR RED AND PURPLE	♂♂, EYE COLOR RED AND PURPLE	♂♂, EYE COLOR IVORY	SECOND CHRO- MOSOME CHARAC- TERS OF IVORY MALES (+ = WILD TYPE)
February 3.....	20	14	4	2+; 2bc.
February 4.....	14	10	0	
February 5.....	16	19	1	1+
February 6.....	21	20	2	1+; 1bc.
February 7.....	12	12	2	1+; 1bc.
February 8.....	9	19	0	
February 10.....	14	20	0	
February 12.....	16	15	0	
February 14.....	17	3	0	
Total.....	139	132	9	5+; 4bc.

Culture 4711 was of the type just described, and represented the twenty-second generation of brother-sister matings. It gave the expected result for the black, purple, and curved characters; but also gave a few males with a very pale eye color, which has been named ivory. These appeared as shown in table 1.

The ivory males which were black and curved certainly also carried the factor for purple, just as the other black curved males did. One was shown to have it by a breeding test, and later results also indicated that ivory and ivory purple are not distinguishable. Five of the wild-type females produced by 4711 (sisters of the ivory males) were tested, but none of them gave ivory sons.

<sup>3</sup> See Sturtevant ('17) for the meaning of 'C<sub>III</sub>' and 'C<sub>IIIr</sub>.'

*B. Its reactions with the W series of allelomorphs*

The nature of the mutation was determined by testing the ivory males. When mated to white females these males produced daughters that were nearly white in color, thus indicating the gene to be an allelomorph of white. It has been found that females heterozygous for ivory and for any one of the following allelomorphs of white are intermediate in color between homozygous ivory females and females homozygous for the other

TABLE 2

CULTURE NUMBER	NON-CROSSOVERS 0		CROSSOVER 1		CROSSOVER 2		CROSSOVER 1, 2		TOTAL
	$\frac{W^1}{S_c \quad e_c}$		$\frac{e_c}{S_c \quad W^1}$		$\frac{S_c}{W^1 \quad e_c}$		$\frac{S_c}{W^1 \quad e_c}$		
4880	72	44	0	0	1	0	0		117
4881	64	71	0	0	1	0	0		139
4884	71	53	2	0	3	0	0		129
4885	57	69	3	2	2	3	0		136
4886	48	41	3	1	2	3	0		98
4887	46	30	0	2	5	2	0		85
Total.....	358	308	8	5	14	11	0		704
	666		13		25				
Percentage .....			1.8		3.6				

color: Blood, cherry, eosin, tinge, buff, éru. (Coral has not been crossed to ivory.) The color of the heterozygous ivories is not only intermediate, but varies in proportion to the intensities of color produced by the other allelomorph when the latter is homozygous; thus, for example, blood-ivory is darker than eosin-ivory, pure blood being darker than pure eosin.

It has been observed by Muller that the ivory males are on the average slightly lighter than the homozygous ivory females.

*C. Locus of ivory*

An ivory male from 4711 was mated to scute echinus females, and the daughters produced the sons shown in table 2.

Bridges' unpublished data show that the locus of scute is 0.0, and that of echinus 4.0. The above data therefore give the locus of ivory as probably a little less than 1.8, which is a sufficiently close agreement with the value 1.1 determined for the locus of white (Morgan and Bridges, '16).

*D. Time at which the mutation occurred*

The mutation that gave rise to ivory must have occurred in the mother fly of culture 4711. That the ivory males in that culture were not due to contamination is shown by the fact that they carried the expected second chromosome genes and by the fact that ivory is a gene not known to have existed before, so that there is no known source from which such contamination could have come. That the original ivory males were not due to mutation in a preceding generation is shown by their small number—9 in 141 males. Clearly the mother was not heterozygous for ivory in all her oogonia, unless the gene was linked to a lethal that killed about 130 ivory males. But the lethal view is negated by the fact that the sex-ratio was 139 ♀ : 141 ♂—clearly no sex-linked lethal was present. The mutation must, then, have occurred somewhere in the germ tract of the female of 4711.

We may further conclude that the mutation must have been soon after the separation of her germ cells from her somatic cells, as it probably affected 13 per cent of the oogonia. This percentage is deduced as follows: From any heterozygous unreduced egg the chances are even that the ivory-bearing X will pass into a polar body at reduction or will remain in the egg. Since it remained in the egg in nine cases where a Y-bearing sperm fertilized the egg, the chances are that it passed into a polar body in nine more eggs that gave rise to males. That is,  $\frac{18}{141} = 13$  per cent of the eggs that were fertilized by Y-bearing sperm probably carried an ivory gene before reduction. This percentage, corresponding nearly to the fraction  $\frac{1}{8}$ , suggests that the mutation occurred in one of the first eight germ cells. Perhaps

one (or more) egg strings was entirely heterozygous for ivory. This latter hypothesis, however, does not agree well with the fact that nine ivory sons were produced in the first five days, but none in the last seven days. The latter fact suggests that only that part of one egg-string that produced the earlier eggs was affected. In that case it becomes necessary to know the number of egg strings present in order to interpret the 13 per cent relation. This information is not available for female 4711, though it is known that the number ranges from about ten to twenty.<sup>4</sup> If only a part of one egg string was affected, then, since this part included one-eighth of the total number of eggs, it would be necessary to conclude either that the female in question had only about eight egg strings, even though she did produce 280 offspring in a laying period of nine days, or else that the egg string containing the mutant gene produced many more than its proportionate share of mature eggs during the first five days. On the other hand, it may be that a small portion of more than one egg string was affected; in that case the egg strings would be 'polygenetic.' Although the exact period where the mutation occurred cannot be determined, it is certain that it took place several cell generations after the separation of the germ cells from the somatic cells and several cell generations before the last oogonial division.

### III. WHITE

#### *A. Manner of origin*

Besides the original mutation of the normal allelomorph W to white, at least two unquestionable instances are known (and many more doubtful ones) in which white was again produced by a 'reverse mutation' of the allelomorph eosin ( $w^e$ ), which itself had been derived from the original white by mutation. A number of cases have been observed in which white has probably arisen independently from the normal gene W (Lancefield, '18), but in none of these hitherto has the identity of the new with the old white been conclusively established and the possi-

<sup>4</sup> We are indebted to Dr. C. B. Bridges for this information.

bility been at the same time quite excluded that the new white may have arisen from the old through some contamination of the food. In the following case, however, the answers to these questions admit of no doubt.

Here, as in the cases of *écru* and *ivory*, a stock heterozygous for autosomal mutant factors had been maintained for many generations by constantly repeating the same cross; in this instance the cross was of  $\frac{H'}{tt}$  males by  $\frac{tt}{tt}$  female ( $H'$  represents

the dominant factor 'hairless,' which is lethal when homozygous;  $tt$  represents the recessive 'tilted wings;' both are in chromosome III). No eye color except the normal red had ever appeared in any of the flies of this heterozygous stock, until, after several months of such crossing, a single hairless male was found which had a red left eye and a white right eye. This male was tested by mating it to tilted sisters. Half of its offspring were hairless, and the rest were tilted, showing that the mutant male had had the composition  $\frac{H'}{tt}$ , and must have been derived, without con-

tamination, from the heterozygous stock. All the offspring had both eyes red. These were then mated together in a large mass-culture and produced in the next generation females all of which had both eyes red, and males half of which had both eyes red, and the rest of which had both eyes white. The new factor for white therefore must be recessive and sex linked. Furthermore, it was evident that the factor was not one which affected only one of the eyes, but it made both the eyes white equally, provided it was contained in them. The difference between the two eyes of the mutant grandfather must therefore have been due to a difference in the factors they contained—the red eye must have contained the original normal factor and the white eye the mutant factor. Some, at least, of the germ cells—all of them, so far as the evidence went<sup>5</sup>—contained the mutant factor like that in the white eye.

<sup>5</sup> It has been found by Morgan and Bridges that in flies whose epidermal parts are mosaic (*gynandromorphic*), the gonad is not mosaic; that is, the germ cells are all genetically like one or the other of the portions of the epidermis:

The fertilized egg, accordingly, must have contained the original unmutated gene for red, and the mutation to white must have occurred later in one of the very early 'cleavage nuclei'—perhaps in the two-cell stage—in that nucleus destined to give rise to the right eye and to the germ cells. Certainly the mutation occurred later than the splitting of the chromosomes of the one-cell stage and earlier than the separation of the germ tract from the ectodermal anlage.

### *B. Genetic behavior*

The new white was proved to be identical with the original white both in locus and in mode of expression, for when the new-white males were crossed to females of the original white stock, nothing but whites, indistinguishable from those of either parent stock, were produced, either in  $F_1$ ,  $F_2$ , or subsequent generations. Had the loci of the two whites been different, some red-eyed crossovers would have been found in  $F_2$ . Moreover, the new white, when crossed to eosin, gave a 'compound' white-eosin of a type exactly like that which eosin gives on being crossed to the original white.

#### IV. A POSSIBLE ADDITIONAL ALLELOMORPH

In 1913 the author found, among the offspring of a  $\frac{w\ m}{f}$  female crossed by  $f$  male (these are all recessive sex-linked genes,  $m$  representing miniature wings and  $f$  forked bristles), a single male having both eyes of an orange color greatly resembling the darker allelomorphs (coral, blood, and cherry) of the  $W$  series. The shade was intermediate between blood and cherry. The male also had the character forked bristles, so that it must have been derived from the cross. Its wings were long (not  $m$ ).

they may be genetically like either the abnormal or the normal portion. This shows 1) that germ nuclei become divided off from epidermal nuclei only after nuclei destined for various parts of the epidermis have become separated from each other and, 2) that these germ nuclei (of both sides of the body) are all derived from just one such common epidermal-germ-nucleus, and not from two or more independently.



The mutant fly was mated to wild-type females, and proved to be fertile, but all the flies in  $F_1$ ,  $F_2$ , and subsequent generations had the normal red eye, although forked appeared in the expected proportions. It is almost certain that the eye color variation had been genetic, for environmental variations of anything like such magnitude never occur in flies with the factors for normal eye color. It is also probable that the variation had taken place in the  $W$  locus, for, of all the twenty or more different mutations for eye color in other loci, none have ever produced so marked a dilution of the eye color, whereas seven of the nine different mutant allelomorphs of  $W$  have resulted in eye color at least as light and of the same general 'quality.' (For that matter, the chances preponderate that any new and different sex-linked mutation in eye color chosen at random should lie at this locus, since more different mutations have occurred here than in all other eye-color loci of the  $X$  chromosome combined.) In this case the mutation in  $W$ —if such it were—must have occurred early in development in one of the purely somatic cells. The time of occurrence must have been later than the separation of at least one epidermal nucleus from the common epidermis-germ tract nucleus, but before the division of this epidermal nucleus had proceeded far enough to form separate nuclei destined for the two sides of the head.<sup>6</sup> Assuming that the mutation did occur in the  $W$  locus, it must have involved a change of the normal allelomorph,  $W$ , not of the white gene,  $w$ , since the breeding tests showed that the male was a non-crossover which had received the gene for red.

<sup>6</sup> Development in insects is proved by such observations on mosaics of *Drosophila* to be indeterminate to the extent that a nucleus of given lineage may enter into different portions of the epidermis. For example, in the last case, the two eyes were both derived from a single somatic cell after the latter had separated from the common epidermis-germ tract, whereas in the case of the new white the right-eye anlage separated from the common tract after the anlage for the left eye had already separated from it. The circumstance that nuclei of somewhat different lineage may thus, in different cases, enter into the formation of the same part of the body is probably to be explained by the lack of cell walls and the migration of nuclei during early development in the insect egg. It offers another illustration of the 'equivalence of nuclei.'

## V. THE MUTATIONS OF W AS QUANTITATIVE FLUCTUATIONS OF THE GENE

It is commonly imagined that genes may vary quantitatively, and that mutations often consist merely of such quantitative changes, although perhaps in a more extreme form than usual. Like most other quantitative changes, these supposed variations are often thought of as being themselves subject to a deviation caused by 'chance;' if so, the variations, when plotted with respect to number and magnitude, must form the well-known bell-shaped 'probability curve.' Enough mutations have now been observed in the gene W to determine whether or not these variations may be grouped in such a distribution.

The three genetically tested mutations reported in this paper, together with the seven previous mutations of W that were fully tested, make a total of ten. A comparison of the homozygous stocks of these mutants shows that the series of allelomorphs stands about as follows, arranging them in the order of their color from darkest to lightest: 1) red (wild type), 2) coral, 3) blood, (4) cherry, (5) ivory, (6) tinge, (7) buff, (8) écreu, (9 and 10) white, and new-white (11) deficiency ultra-white (judged by heterozygotes). The colors of 5 to 8, inclusive, are of so very nearly the same intensity that their order is somewhat uncertain, but they are of not quite the same quality. The several second mutations (like the mutations of white which produced eosin) are not included in this enumeration, which is concerned only with variations from a fixed base. It may be added, however, that eosin would come between 4 and 5 in the above series, the homozygous eosin female being like the cherry (4), the eosin male being lighter than this, but darker than the ivory male.

Of the ten certain variations of W, it is first noticeable that all were 'minus' variations—i.e., lighter than normal, in spite of the fact that 'plus' variations in eye color can and do occur in other loci. This immediately removes the curve of variation from the ordinary symmetrical bell-shaped class, and would make it an extreme case in the class of 'skew curves.' The second outstanding feature is that three of the ten mutants were of

the most extreme possible type, namely, white—the original white, the ‘new white’, and the deficiency ‘ultra-white’—while four were very nearly white—namely, ivory, tinge, buff and écreu. Of the remaining three, cherry and blood are at least as far removed in the color scale (as determined by the thickness of solutions required to imitate them) from red as they are from white. Only coral remains as a variant of moderate degree, but even it is scarcely darker than the lightest eye variations hitherto observed in other loci than W. If anything, then, there is a piling up of the curve of variation near its extreme—a phenomenon diametrically opposite to the most fundamental characteristic of all ‘probability curves.’

The relative deficiency of mutations of lesser magnitude is not due to their being less easy to observe, for most of the eye-color variations which occur in other loci, and which deviate from normal much less than does the average mutant of W, are so distinctly different from the red that their classification and separation from it in crosses is quite certain. There may of course be some variations so slight that they will often escape recognition, but all the variations observed in W are quite outside this range, and could not fail to be detected in practically every instance in which they occurred. If, then, the variations of W form a probability curve, there should, within this range which is certain of detection, be a greater number of variants found at smaller deviation values from red than at greater, instead of the reverse grouping which obtains. Although ten might ordinarily be considered a small number for a sample, this discrepancy between the expectation based on ‘chance fluctuation’ and the actual finding is so marked as to afford definite contradiction of that idea.

We must conclude that the variations in W are not distributed in magnitude like the deviations found in random sampling (Muller, '18). *On the basis of this finding, furthermore, the hypothesis becomes improbable that very small deviations in the factor W—lying on or behind the borderline of visibility—are any more frequent—if as frequent—as the occasional visible mutations which have been detected.* Finally, it is seen that selection with regard

to this one gene taken by itself would probably not be cumulative in its effect, for if extreme variants are as likely to occur as moderate ones, it is about as easy to get an extreme type directly, by one step, from the original form, as to get it by the process of piling up small variations in the gene. This should not, however, be taken to mean that where a large a group of loci or the whole germ plasm is under selection, the latter would be ineffective, for in that case, of course, a single change in one locus would rarely produce as marked an effect as could be obtained from a combination of changes in various genes. Hence we see that a misleading picture of the manner of the occurrence of variation is obtained unless the variation is analyzed into the separate gene changes of which it is composed.

Not only may we establish the fact that the magnitude of mutations in *W* are not determined according to the principle of simple sampling, but it may also be shown directly that they cannot be purely quantitative changes. For, if the eye-color differences in question depended merely upon hereditary differences in the amount of a certain kind of gene (*W*), then the males, containing only one *X* chromosome, should have only half as much of this material as the females, and their eye color should be correspondingly lighter than that of the females, for the same reason that the eye color of a female which has one gene for *écru* and one for white is lighter than the eye color of a female which has two genes for *écru*. In all but one (*ivory*) of the mutations of *W*, however, the male has the same eye color as the female,<sup>7</sup> and the differences in eye color which do occur between the different allelomorphs cannot therefore be due to purely quantitative differences between the genes.

It might perhaps be objected that such comparison between male and female is invalid on account of the other genetic differences which exist between them. But this would be tantamount to claiming that the other parts of the male complex

<sup>7</sup> *Eosin*, the mutant which arose from the factor white, is like *ivory*, and different from the other mutations of the normal allelomorph *W*, in this respect, but this is probably because of an influence of sex upon the character *eosin*, since Bridges has shown the latter to be unusually susceptible of modification by genes in loci other than that of *w*<sup>o</sup> itself.

somehow interacted upon the eye color in just such a way as to exactly counteract, in the case of six separate mutants of W, the eye-color difference that would be caused by the difference in quantity of W carried by the male and female. This would indeed be a remarkable series of circumstances, especially since it would have to be extended so as to apply not only to these mutants of W, but to practically all the mutant and normal genes known in other loci of the X chromosome, for in all these cases the male shows the same intensity of character as the corresponding homozygous female. As a matter of fact, when we come to examine those cases in which such an interaction of sex with other characters could be demonstrated—namely, the cases of non-sex-linked mutant characters—we find any kind of interaction of sex with other characters to be relatively rare, let alone that sort of very nicely adjusted interaction that would be required for the present purpose of just counterbalancing the difference in quantity of the gene in the two sexes.

It is accordingly evident that the similarity in eye color of males and homozygous females carrying some mutant of W is due to the fact that a difference of as much as 50 per cent in the gross amount of a certain kind of gene received by the fertilized egg does not ordinarily affect the manifestation of the gene.

Hence it follows also that the lighter the color of, for example, an *écru*-white heterozygote, as compared with homozygous *écru*, cannot be due to the reception by the former of a smaller total quantity of eye-color-producing gene material, but must be due to the gene for white being qualitatively different from that for *écru*, and exerting a positive influence to make the eye color lighter. Further evidence along the same line is furnished by the fact that not all the colors given by the W series are exactly alike in kind: although on the whole they form a graded series, still buff, for example (in spite of its name), gives a distinctly clearer yellow color than either tinge, which is just above it in the scale, or *écru*, which is just below it. Moreover, the eosin and ivory colors are both affected by sex, whereas none of the other factors, either above or below them in the scale, are so influenced.

Of course, when it is stated that these eye-color changes depend upon 'qualitative,' rather than 'quantitative' differences in the gene, reference is made here merely to the gene 'in gross' (if we may be pardoned such an expression); it is not denied that these qualitative changes themselves may perhaps consist in quantitative changes of some part of the gene (e.g., in the proportion of certain kinds of radicles or even molecules). But if we think of the changes as quantitative in this sense, then we must recognize that such a quantitative change of a portion of a gene, with the rest of it perhaps remaining constant, must be an entirely different thing from a quantitative change in the gene as a whole, with the neighboring genes and the rest of the chromosome remaining constant. For in the first case a marked effect is produced on development (manifested in a different eye color, for example); the new genic structure thus exerts a positive action different from that exerted by the original structure, an action which may interfere with the latter when both genes are present together, causing the intermediate condition of hybrids. In the second case, on the other hand (where the entire gene varies in amount), no perceptible difference in effect is ordinarily produced, as seen by the similarity in the expression of most sex-linked factors in male and female. This unlikeness between the results of quantitative changes in a part of a gene and in the whole gene would presumably be because the parts of a single gene have such a direct and intimate connection with each other in the reactions of morphogenesis that the quantitative relations of their parts make a great difference in development, whereas the evidence shows that separate genes usually interact in a different, less direct manner, such that their relative amounts (within  $\pm 50$  per cent at least) make little difference. Here, then, we would have a basis for defining the limits of a gene, in addition to the test of crossing over.

## VI. THE STAGE IN THE LIFE-CYCLE AT WHICH MUTATION OCCURS

The four cases described in sections I to IV illustrate very well the principle that mutation is not a phenomenon connected with the segregation division or peculiar to gametes, but may occur at any time and place during the life-cycle. Thus, the new white arose during that stage of the insect egg which corresponds to early cleavage, in a nucleus that belonged to the common germinal and somatic stocks, before the latter had separated off from each other. The mutation that produced the orange-colored eye also occurred in the very early embryo, in a cell that was purely somatic. Ivory arose at a considerably later stage, after the germ cells had separated from the somatic, and had themselves divided several times to form a number of gonidia. Écru, finally, probably occurred much later in the life-cycle, either in a very late gonial cell or in an oocyte.

Cases apparently resembling, in principle, the first two listed above are those described by Baur (?) in *Antirrhinum*. Baur found that cuttings taken from this plant at various times occasionally failed to contain a dominant factor for which the original stem had been heterozygous, and he interprets this as meaning that the dominant factor had mutated at some time during the development of the cut portion. To the present author, however, it would also seem possible that the disappearance of the heterozygous factor may have been caused by an abnormal distribution of chromosomes occurring at some cell division—either a ‘somatic segregation’ or a ‘mitotic dislocation’ such as gives rise to gynandromorphs in *Drosophila*. A test between these alternatives would be furnished if the behavior of a second heterozygous linked factor could be observed simultaneously with the first. The same alternative explanation of mitotic irregularity may also be applied to many of the other cases of clonal or asexually produced ‘mutations’ which have been reported in the literature.

Nevertheless, whatever the explanation may be for these more doubtful cases, the cases which have been worked out in *Drosophila* are by themselves sufficient to refute the doctrine that mutations are essentially phenomena of maturation and fertiliza-

tion. That this doctrine has been very widely accepted even among geneticists is indicated in the following quotations. "The current view concerning the mutations of *Oenothera* is that they take place during synapsis, and that the sexual cells are in the mutated condition before the moment of self-fertilization" (de Vries ('18), p. 405). That de Vries probably does not intend this generalization to be limited to the peculiar 'mutations' of *Oenothera*—which there is strong reason to believe are indeed phenomena of segregation—is indicated by the following casual remark several pages later (p. 414): "Assuming, as is now generally conceded, that mutations take place before fecundation . . ." In Babcock and Clausen's ('18) textbook of genetics there appears a similar general statement (p. 269) which may probably be taken as representative of the current genetic opinion: "It would seem, therefore, that factor mutations in animals occur in the germ cells shortly before or during maturation." Tower's more pronounced adherence to such a doctrine is well known.

Although it has been shown above that mutations actually do occur at various stages in the life-cycle, yet when an attempt is made to obtain a quantitative estimate of the relative frequency of mutations at the different stages, much greater difficulties are encountered. The circumstances that must be taken into consideration in any investigation dealing with this subject may now be analyzed. In order to find out the time, in the life-cycle, at which a given mutant factor originated, it is usually<sup>8</sup> necessary to know in how many members of a family the mutant factor first occurred concurrently. Ordinary recessive mutant factors, however, could not be thus detected at their first origin, since they would then be heterozygous and hidden (except under very exceptional circumstances), and so the inquiry must be limited to dominant factors and to sex-linked (dominant or recessive) factors, which are able to manifest themselves in the

<sup>8</sup> Except if the mutation is brought about by experimentally applied influences, acting at a known stage in the life-cycle, or if the individual in which the mutation occurs is visibly a mosaic, as in the case of the new white, and in the case of Baur's doubtful mosaic mutations of *Antirrhinum*.



first generation that receives them. The valid evidence in regard to the origin of such factors is rather meager, for in many instances such mutants have been found in mass cultures, in which it cannot be determined how many normal individuals belong to the family that produced the mutant; often, too, the original occurrence of the mutant cannot be checked up, on account of its having been first observed in a stock that had not been carefully examined during the preceding generation.

Let us suppose, however, that a census has actually been made which includes only those cases that are known to be valid.<sup>9</sup> Let us then assume that the data really show that in the great majority of cases the mutant factor, at its first appearance, appeared in only one member of a family. It is easy to show that this is just the result that would be expected even if mutation is equally likely to happen at any stage during development, and that it by no means indicates that the later stages of the germ tract (gametes, cytes, and late gonias) are for some reason more inclined to mutate than the early stages (gonias, primordial germ cells). For, in the first place, since there are many more cells produced during the later stages than during the earlier ones, there are many more chances that a mutation should occur in the later stages, even if mutation is no more likely to occur in one cell than in another. Secondly, unless we make the gratuitous assumption that mutations only occur during certain fixed periods in the life of the cell, which are of the same duration in all cells of an organism no matter how long the cell lives, then the fact that the cells usually exist much longer in the later stages (growth period, etc.) than in the early stages would again provide more opportunity for mutations to occur in these late stages, even though the cells at that time were not, *per se*, more mutable. Thirdly, unless approximately 100 per cent of the gonias and gametes produced from the mutated cell develop into viable individuals showing the mutant character, many of the cases in which more than one germ cell came to receive the mutant gene would be recorded as cases of single

<sup>9</sup> See the paper of Bridges ('19), which has appeared and come to my attention since the present paper was written.

mutants. As a matter of fact, the great majority of the gonial cells produced at a given time fail to develop, for in the case of the sperm it is notorious that only a minute fraction ever achieve fertilization, whereas in the case of the eggs of *Drosophila*, before the production of each oocyte the oogonium probably divides four times (multiplication period), giving rise to a cyst of sixteen cells, only one of which completes the process of maturation. But of those gametes descended from the mutant cell which do succeed in forming zygotes, only half carry the mutant factor under consideration, owing to its being sorted into half the cells at the segregation division. Of those zygotes, in turn, which come to carry the mutant factor, only the males—in the case of recessive sex-linked factors—will be able to show it; thus the cases available for the manifestation of the factor are reduced by still another 50 per cent. For these reasons, a large proportion of those mutations in gonial cells which give rise to several mutant gonidia or gametes would appear to be mutations in gametes or cytes, owing to the fact that only one gamete from the mutant gonium happened to develop and to form an individual which bore and showed the mutant gene.

In order to know just how much to allow for these three circumstances, it would be necessary to know exactly the whole cell lineage of the germ tract, including the length of time that each cell remained 'at rest' in every cell generation (or the length of time that it remained in those parts of the cell generation during which mutation may occur), as well as the number and distribution of the gametes which subsequently underwent fertilization and development into viable males. We may, however, gain a much clearer conception of how these features of the cell lineage influence the numbers in which mutants may appear among a batch of offspring, if we consider a greatly simplified diagram, roughly representing the cell-lineage of a parent individual ( $P_1$  female) and her progeny ( $F_1$ ), during those portions of their life-cycles in which the occurrence of a mutation would lead to a character variation first visible in the offspring generation ( $F_1$ ). The diagram (fig. 1) hence starts with what might be called the 'primordial germ cell' of the parent; cell

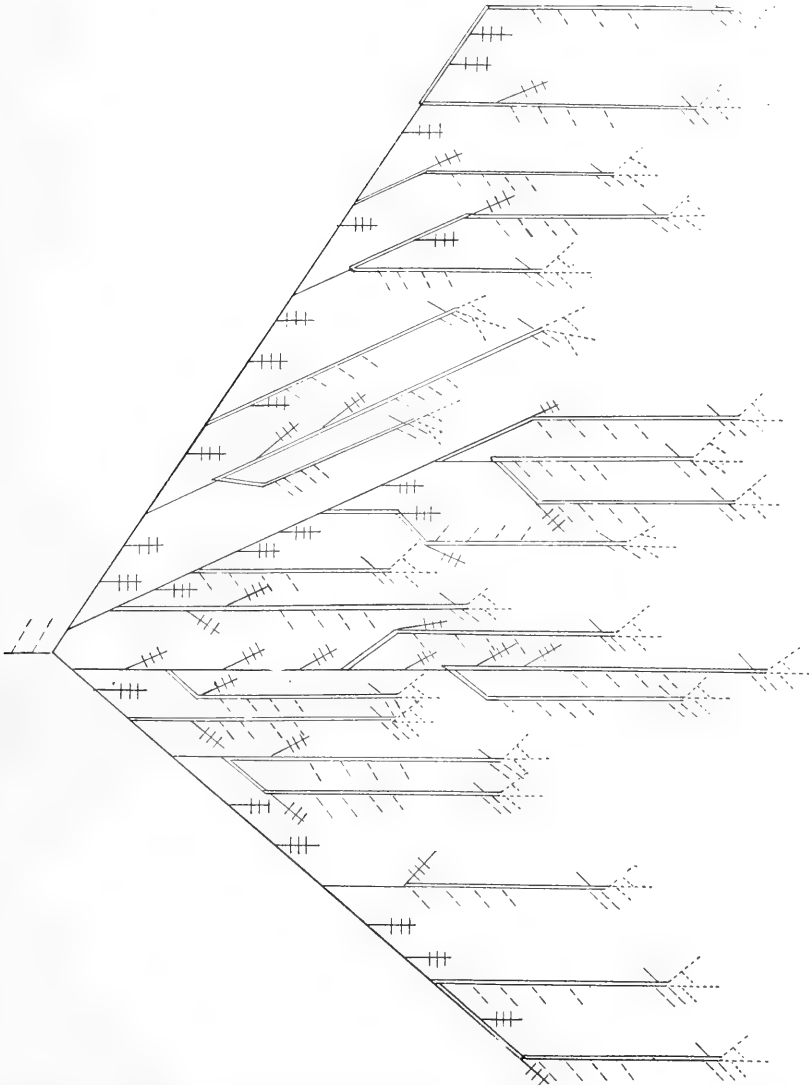

Fig. 1 Diagram to show the effect of cell lineage on the distribution of mutations. (For explanation see text.)

divisions of the parent prior to the separation of its somatic (or at least epidermal) tracts from the germinal tract have not been shown, inasmuch as mutations occurring then would often be visible in the soma of the parent, and so could not count as mutations discovered in the offspring. The diagram is continued to approximately the same point (primordial germ-cell formation) in the offspring, the first three cell cycles of the latter being shown, because a mutation occurring then might still be visible either as a 'self' or as a mosaic mutant in the individual of this generation.

Each separate line in the diagram represents a particular cell, in its passage through its individual cell-cycle; a fork in the line represents a cell division, and each line is supposed to be taken as proportional, in its horizontal projection, to the length of time during which that cell remained undivided. Hence, time is the abscissa of the diagram, and any vertical section of the diagram must show, for a particular moment, just what cells exist (in the individual and its offspring) in which mutations that would be visible in the offspring might occur. Those lines of cells in the gonad which are abortive in reproductive function, such as those resulting from the four divisions of the 'multiplication period,' which lead to the fifteen nurse cells for each oocyte, and those giving rise to the polar bodies, are only indicated at their inception, by means of very short broken lines. Those cell lines leading to offspring that do not carry the chromosome whose process of mutation is under consideration and those cell lines leading to offspring in which the mutant gene could not be detected (all the females in the case of recessive sex-linked mutant genes) are shown as short cross-hatched lines, in which no attempt is made to indicate the further course of cell divisions. On the other hand, the main lines of the parental germ tract and all lines culminating in viable  $F_1$  individuals which would carry and show the mutant factor, provided it arose, are shown as continuous uninterrupted lines. The moment of fertilization (or rather, nuclear fusion) is indicated as a fusion of two lines (making a  $\bowtie$  figure immediately following the long growth period line and between the two small polar

body branches). Those portions of the  $F_1$  cell lines after the first division which play any conspicuous rôle in the production of the soma are distinguished with dotted lines; mutations occurring here would often be visible as mosaics.

On examination of this diagram, it is evident that mutations in all portions of the continuous line subsequent to its last splitting into two continuous lines and previous to the first cell division in the offspring would result in single (entire) mutant  $F_1$  individuals. These sections of the line have been represented as double. On the other hand, a mutation in any part of the continuous cell line antecedent to the last split into two continuous lines would result in twin or multiple mutants among the offspring, the exact number of mutants being determined by the number of splits in the line subsequent to the point of mutation; these parts of the continuous line have been represented as single in the diagram. The way, then, to find the a priori chance for the appearance of single mutants, as compared with that for cases of twin or multiple mutants, is to compare the total length (in horizontal projection) of the double lines with the total length of the single lines antecedent to the double portions. If mutation is entirely indiscriminate, that is, equally likely to occur at all stages, then the ratio of the lines will give the ratio of single to multiple mutations, but if mutations are more likely to occur at one stage than another, then the line-ratio will differ from the ratio of mutations by the same proportion as the average mutability of the 'double-line' stages of the life-cycle differs from the mutability of the 'single-line' stages.

The projected length of the double line in the diagram as compared with the single line, is about 3.5 : 1. Although the cell lineage is for the most part only guessed at in this diagram, still it should be pointed out that the lengths of those portions of the double line lying beyond the multiplication period (the four divisions which give rise to the cyst) are approximately correct for *Drosophila*, relatively to the length of the entire cycle. For it may be calculated from the data of Plough ('17), which gives the number of oöcytes in the ovary and the number of eggs hatched per day, that the length of the growth period

in *Drosophila* is about three days. The duration here involved is obviously a very important factor in determining the great excess of the double line over the single; the combined lengths of these parts of the double line are by themselves about equal to the total length of the single line in the diagram. In addition to this, it is also likely that the four divisions which give rise to the oöcyst, and which evidently occur just before the growth period, consume a comparable time, as represented in the diagram. But there is still another circumstance that would tend to result in an even greater preponderance of the double line than that figured. For it may be shown that, if the actual cell lineage is at all of the type which has been pictured, the disproportion between the double and the single lines must increase with an increasing number of eggs, so that the actual disproportion would probably be very considerably greater than that shown in the simplified diagram above.

If, however, the cell lineage does not conform in its general pattern to that pictured in figure 1, it almost certainly does not differ from the latter more than do the two opposite extreme types of cell lineage indicated in figures 2 and 3. A scheme of the type shown in figure 2, if it were so constructed as to allow the six days above assumed for the multiplication and maturation periods, and also so as to give the same number of eggs as figure 1 in the same length of time, would result in a ratio of double to single line of not less than 2 to 1. The ratio on figure 2 may vary from this minimum figure, however, all the way up to an infinitely large number to one; the exact number will depend upon which cell generations the germ cells ancestral to the various eggs remain longest at rest in. A scheme like that of figure 3, if constructed for the same multiplication and growth period and for the same number of eggs in the given time as figure 1 would result in a ratio of not less than 12 to 1. The actual cell lineage is evidently something between the two extreme types of 2 and 3 and it is therefore certain at least that the chance for the production of single mutants is considerably greater than that for the production of twin or multiple mutants. Accordingly, the actual finding that more cases of single mutants

occur than of multiple mutants could not be used as evidence for a higher mutability in the later stages of the germ-tract cycle.

The reader may perhaps have been disturbed, in accepting these conclusions, by the consideration that, in the case of any one mutant individual, there can be no more a priori likelihood of the mutant factor which it contains having arisen in one stage of its ancestry rather than in another (of equal duration). This claim is perfectly valid. If we assume that a cell in one period of the life-cycle is no more likely to mutate than in another period, then the number of mutant individuals resulting from

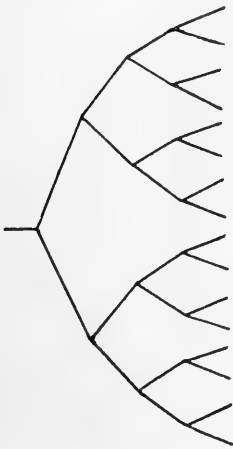

Figure 2

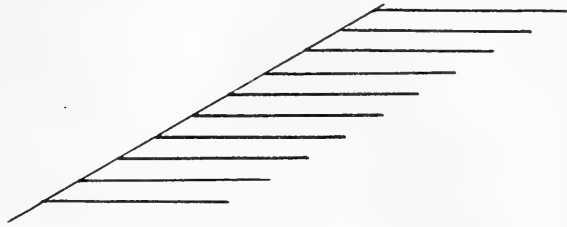

Figure 3

- Fig. 2 Scheme of symmetrical cell multiplication.  
 Fig. 3 Scheme of egg production from a single stem cell.

mutations in different periods of equal lengths would be exactly equal in frequency. In each of those cases, however, in which the mutation happened early in the germ tract, many individuals would be formed bearing the same mutation, and there would be relatively few such cases of mutation, since few cells exist in the early stages; in each of those cases in which the mutation happened late, only one or a few individuals would bear the particular mutant gene in question, but there would be correspondingly many such cases, owing to the fact that there are so many different cells in existence in the later stages which would be capable of giving rise to a mutant. Thus the number of mutant

individuals formed in the two kinds of cases would be alike, but the number of different cases of mutation would be much greater for the later mutations than for those occurring at the earlier stages.

It may be observed that the chance for the observation of half or quarter mutants, although these are due to mutations in very early stages, is somewhat high as compared with the chance for multiple mutants. The chance for such mosaics may be estimated by determining the total length of the dotted lines of the offspring; in the diagram the ratio of the lengths of dotted to single lines is about 7:5. The reason that mosaics can be found so often is because the mosaic condition may be observed directly in the individuals ( $F_1$ ) in which the mutations arose, whereas mutations in the germ tract can only be detected if they occurred in a parent ( $P_1$ ). There is, however, a chance that the mutated somatic cell will not happen to come to lie in a part of the body that would be affected by the mutation it bears. For example, if the 'new white' cells had not happened to include any eye tissue, the mutant would not have been discovered. For this reason, a correction must be applied to the criterion of 'dotted line length' referred to above, depending on what proportion of the early somatic nuclei have descendants in parts of the body in which the mutation could be observed. Another important correction, of opposite effect, would consist in the addition to the dotted line of the early cleavages of all those later somatic lines within which the mutation would produce a visible effect. These corrections will vary greatly for different kinds of characters.

With the exception, then, of cases of mosaics and other somatic mutations, the general conclusion may be drawn that the number of cases of mutation observed should become progressively greater the later the occurrence of the mutations in the germ-tract cycle, even though cells at all stages may be equally likely to mutate.

Furthermore, the evidence showing that mutation may occur during various cell generations in the life-cycle makes it highly probable that older animals, or animals of species having a



longer life-cycle or a greater number of cell divisions in the germ-cycle, will in general produce a greater proportion of mutants per generation than younger animals, or animals of species having a shorter life-cycle or a smaller number of cell divisions in the germ-cycle.

#### VII. THE DEGREE OF LOCALIZATION OF THE EVENT WHICH PRODUCES THE MUTATION

It is noteworthy that the mosaic white reported above was a male. Similarly, a mosaic yellow fly which has arisen in a more recent experiment of the author's, and which was tested and found to be an allelomorph of the original yellow,<sup>10</sup> was also a male. These two are the only somatically mosaic mutants which have been genetically tested and verified as containing a mutant factor, but a considerable number of other mosaics have been observed by other workers which are almost undoubtedly mutants, although they were not tested. In all these cases, where a recessive sex-linked mutant gene was involved, the mosaic fly was a male. This result does not mean that mutation does not occur in females; it is obvious that ivory, for example, arose in the female parent of the brood, and Sturtevant has recently found an apparent female somatic mutant involving the dominant sex-linked character notch. The more reasonable explanation is that the mutations occur similarly in males and females, but that they occur in only one X chromosome at a time, and therefore recessive mutant genes cannot manifest themselves in the female sex, on account of the presence there of the dominant unmutated allelomorph in the homologous X chromosome. In the male, since there is only one X chromosome and since the Y does not dominate, any mutation occurring in the X could be immediately visible.

The conclusion that a mutation happens in only one X chromosome at a time implies that the agent which ordinarily pro-

<sup>10</sup> The new yellow is apparently identical with the old, and not 'achete,' like the allelomorph of yellow which Weinstein found. Weinstein's yellow appeared in just three brother males among a family of ordinary size and was therefore due to a mutation in the oögonial stage (Weinstein, '18).

duces the mutation must be extremely localized in its site of application. The previously known fact that usually only one locus mutates, and not the neighboring loci of the same chromosome, might have been explained on the supposition that the influence at work was chemically specific, only affecting a gene of a given composition, but in that case it might be expected that the two similar genes in homologous chromosomes would both be affected. The fact that they are not shows that the immediate cause of the mutation is not a diffuse influence existing throughout the body, the cell, or even the nucleus; the mutation is due to an event of such minute proportions, so circumscribed, that it strikes only a single one of two near-by, similar loci in the same nucleus.

Emerson ('11) arrived at a similar result in corn, in the case of his mutable locus for variegation. In portions of the plant in which the dominant mutation to red was somatically visible, only half of the germ cells carried the mutated factor, indicating that the mutation had occurred in only one of the two homologous chromosomes.<sup>11</sup>

In view of this conclusion, the oft-suggested possibility of artificially influencing the kind of mutation that occurs (cf. Stockard, Tower, MacDougal, Kammerer, Guyer) would seem to recede indefinitely, unless some unique method is found which does not merely consist in an acceleration or intensification of the ordinary process of mutation.

#### SUMMARY

1. Three new mutations of the gene W in the X chromosome of *Drosophila melanogaster* have been described. They have given rise respectively to:

a. *Écru*, causing the eyes to be of a light straw color, not much darker than 'white.'

<sup>11</sup> Baur, too, reached this conclusion, through his finding that mosaics showing a recessive character cannot result from plants originally containing the dominant gene unless the latter was heterozygous, but, as previously pointed out, he may not have been dealing with real mutations.

b. Ivory, causing a light yellow eye color only slightly darker than *écru*.

c. White, producing a color identical with the original 'white.'

All three when crossed to white or eosin give females intermediate in eye color between those of the two parent races. The males of the *écru* and of the white race are like the homozygous females, but ivory males are slightly lighter than homozygous ivory females.

2. *Écru* first appeared in a single male, so that it is likely that the mutation occurred in a late oögonial cell, oöcyte, or egg of the mother.

3. Ivory, found by Sturtevant, appeared in 9 out of 141 male offspring of a single female; this mutation must have occurred in an early stem cell of the ovaries of the mother.

4. The new white appeared in a single male, which had one eye red and one white; this mutation therefore occurred at a stage corresponding to early cleavage.

5. A single male with orange-colored eyes was found; it did not transmit its mutant eye color. Indirect evidence makes it probable that this was due to another allelomorph of W which arose from the normal allelomorph in a somatic cell of the very early embryo.

6. There is no evidence that mutations are more likely to occur in gametes or germ cells near the period of maturation than in cells at any other stage in the life-cycle. The peculiarities of cell lineage would, however, provide a greater chance for the appearance of single mutant individuals than for cases of twin or multiple mutants; since there are more cells existing during the later stages of the germ-cycle, there is a correspondingly greater chance for mutations to occur there in one cell or another, even though mutations may occur equally readily in cells at any stage. A method is described for estimating the effect of any given type of cell lineage upon the relative numbers of fractional, single, twin, and multiple mutants produced.

7. The fact that mosaic mutants involving recessive sex-linked genes are always males indicates that mutations occur in only one member of a pair of chromosomes at a time. The

event which produces the mutation is therefore exceedingly localized

8. The variations of the locus *W* are not distributed, as regards magnitude, in a 'curve of probability.' If anything, the extreme variations are most frequent, and minute variations are probably infrequent. Selection concerned with this locus alone would not be cumulative in its effect.

9. The mutations of *W* are not quantitative variations of the entire gene; this is shown by a comparison of the eye colors of males with those of heterozygous and homozygous females.

## LITERATURE CITED

- BABCOCK, E. B., AND R. E. CLAUSEN 1918 Genetics in relation to agriculture. McGraw-Hill Book Co. 675 pp.
- BAUR, E. 1918 Mutationen von *Antirrhinum majus*. Zeitschr. induct. Abstamm. Vererb., vol. 19, pp. 177-193.
- BRIDGES, C. B. 1919 The developmental stages at which mutations occur in the germ tract. Proc. Soc. Exper. Biol. and Med., vol. 17, pp. 1, 2 (appeared after the present paper was written).
- DE VRIES, H. 1918 Mass mutations and twin hybrids of *Oenothera grandiflora*. Ait. Bot. Gazette, vol. 65, pp. 377-422.
- EMERSON, R. A. 1911 The inheritance of a recurring somatic variation in variegated ears of maize. Amer. Nat., vol. 48, pp. 87-115.
- HYDE, R. R. 1916 Two members of a sex-linked multiple (sextuple) allelomorph system. Genetics, vol. 1, pp. 535-580.
- JENNINGS, H. S. 1917 a Modifying factors and multiple allelomorphs in relation to the results of selection. Amer. Nat., vol. 51, pp. 301-306.  
1917 b Observed changes in hereditary characters in relation to evolution. Jour. Wash. Acad. Sci., vol. 7, pp. 281-301.
- LANCEFIELD, D. E. 1918 An autosomal bristle modifier, affecting a sex-linked character. Amer. Nat., vol. 52, pp. 462-464.
- MOHR, O. L. 1919 Character changes caused by mutation of an entire region of a chromosome in *Drosophila*. Genetics, vol. 4, pp. 275-282.
- MORGAN, T. H. 1910 Sex-limited inheritance in *Drosophila*. Science, vol. 32, pp. 120-122.  
1912 Further experiments with mutations in eye color of *Drosophila*: the loss of the orange factor. Jour. Acad. Nat. Sci. Philadelphia, vol. 15, pp. 321-346.
- MORGAN, T. H., AND C. B. BRIDGES. 1916 Sex-linked inheritance in *Drosophila*. Carn. Inst. Wash., publ. 237, pp. 3-87.  
1919 The origin of gynandromorphs. Carn. Inst. Wash., publ. 278, pp. 3-122.
- MULLER, H. J. 1918 Genetic variability, twin hybrids, and constant hybrids, in a case of balanced lethal factors. Genetics, vol. 3, pp. 422-499.
- PLOUGH, H. H. 1917 The effect of temperature on crossing over in *Drosophila*. Jour. Exp. Zool., vol. 24, pp. 147-209.
- PUNNETT, R. C. 1918 Note on the origin of a mutation in the sweet pea. Jour. Genetics, vol. 8, pp. 27-31.
- SAFIR, S. R. 1913 A new eye-color mutation in *Drosophila*. Biol. Bull., vol. 25, pp. 45-51.  
1916 Buff, a new allelomorph of white-eye color in *Drosophila*. Genetics, vol. 1, pp. 584-590.
- STURTEVANT, A. H. 1917 Genetic factors affecting the strength of linkage in *Drosophila*. Proc. Nat. Acad. Sci., vol. 3, pp. 555-558.
- WEINSTEIN, A. 1918 Coincidence of crossing over in *Drosophila melanogaster* (ampelophila). Genetics, vol. 30, pp. 135-173.

Resumen por el autor, G. H. Parker.  
Universidad Harvard, Boston.

### Actividades de los animales coloniales.

## II. Movimientos neuromusculares y fosforescencia en Renilla.

Renilla presenta dos formas de peristalsis: peduncular, con ondas que caminan distalmente sobre el pedúnculo, y raquidial, con ondas que marchan en dirección opuesta sobre el pedúnculo y raquis. En la peristalsis peduncular las ondas se suceden con intervalos de unos 36 segundos y progresan con una velocidad de próximamente 1.5 mm. por segundo. La peristalsis peduncular tiene por objeto hundir el pedúnculo en la arena, fijando de este modo al animal al suelo, estando también relacionada con la locomoción. Secundariamente juega un papel importante en el movimiento del fluido interno.

En la peristalsis raquidial las ondas aparecen próximamente una vez cada 130 segundos, progresando con una velocidad de 1.2 mm. por segundo. Los pedazos de Renilla separados del resto del cuerpo presentan ondas raquidiales cuya velocidad es tanto mayor cuánto mas cercano al pedúnculo estaba el pedazo separado. La peristalsis raquidial eleva al animal fuera de la arena.

Renilla es muy fosforescente durante la noche, mas no durante el día. La fosforescencia está localizada en la substancia blanquecina situada en la superficie dorsal del raquis. Se extiende en ondas que caminana una velocidad de unos 7.4 cm. por segundo. La onda de retracción de los autozoides se extiende próximamente a la misma velocidad. Las ondas de ambas clases de peristalsis son miogénicas en su origen, las de fosforescencia y retracción de los pólipos son neurogénicas. Las actividades de Renilla son coloniales, no zooidales; el zooide está dominado por la colonia.

## ACTIVITIES OF COLONIAL ANIMALS

### II. NEUROMUSCULAR MOVEMENTS AND PHOSPHORESCENCE IN RENILLA<sup>1</sup>

G. H. PARKER

TWELVE TEXT FIGURES AND ONE PLATE (EIGHT FIGURES)

#### INTRODUCTION

Although *Renilla* possesses two well-defined colonial movements, both of which may be associated with a certain amount of locomotion, neither of them seems to have excited the attention of investigators to any marked degree. This is probably due to the fact that few workers have had the opportunity of studying living animals. The two movements referred to may be designated as peduncular peristalsis and rachidial peristalsis. These movements, which make up a large part of the general activities of *Renilla*, have been vaguely noted in various sea-pens by a number of workers (Verrill, '64, p. 13; Musgrave, '09, p. 459), who, however, have not sharply distinguished them. From the accounts given it is clear that rachidial peristalsis in *Renilla* was seen by Müller ('64, p. 354) and by Eisen ('76, p. 13) and peduncular peristalsis by Wilson ('83, p. 784), who showed the relation of this activity to locomotion especially in young animals. Aside from these few references, however, past publications contain almost no mention of these activities. I shall consider them separately, beginning with peduncular peristalsis.

#### PEDUNCULAR PERISTALSIS

The extended peduncle in a large individual of *Renilla amethystina* may measure as much as 7 to 8 cm. in length. In *R. reniformis*, as Agassiz ('50, p. 208) observed, the peduncle may

<sup>1</sup> Contributions from the Zoölogical Laboratory of the Museum of Comparative Zoölogy at Harvard College, no. 325.

shorten to one-fourth of what was its distended length. If *Renillas* in a state of contraction are placed in a basin of quiet sea-water, in a short time the peduncles of many of them will show peristaltic waves, which begin not far from the region where the peduncle is attached to the rachis and proceed over the length of the peduncle to its distal end (pl. 1, figs. 1 to 4). These are the waves of peduncular paristalsis (Parker, '19).

Such waves, of which never more than one at a time is seen on the peduncle, pass over that structure with considerable frequency. Thus in a *Renilla*, that may be taken to represent the normal state, ten waves passed over the peduncle in 360 seconds, hence at the rate of one wave every 36 seconds. The periods occupied by the actual passage of the waves varied from 26 to 28 seconds, and averaged 27.4 seconds; therefore the average resting period for the peduncle as a whole was 8.6 seconds, the difference between 36 and 27.4 seconds. The distance traversed on the peduncle by one of these waves was about 30 mm., and as this distance was covered on the average in 27.4 seconds, it follows that the average rate of progress for the wave over the peduncle was a little less than 1.1 mm. per second. This determination applies to animals in sea-water at a temperature of 23°C. Attempts to ascertain the influence of change of temperature upon this rate were unsuccessful, for colonies of *Renilla* that were put into sea-water much warmer or much colder than what was normal for them never showed peduncular peristalsis clearly enough to allow of measurement.

Peduncular waves can be seen on excised peduncles, though from the fact that these are not distended with water the waves are less conspicuous than when they are seen in normally attached peduncles. They arise in the severed peduncles at less frequent intervals and with less regularity than in the attached ones. Thus in a severed peduncle they occurred at intervals varying from 110 to 400 seconds instead of every 36 seconds. Because of the collapsed state of such preparations, the moment of their beginning and ending could not be determined with accuracy, hence it is impossible to state their rate under such circumstances. So far as could be judged by the eye, however, the waves traversed



the severed, collapsed peduncles about as fast as they did the distended ones. As a rule, peristalsis is not to be observed on peduncles that have been ligated in a distended condition and then cut from the colony. Apparently this procedure inhibits the movement: In an exceptional case, however, a distended severed peduncle showed peristaltic waves at the rate twelve in 15 minutes or one in 75 seconds, about half as fast as the normal rate, though much more rapid than in the case of severed, collapsed peduncles.

If a contracted *Renilla* is placed in a shallow aquarium of sea-water that is partly filled with sand, it will usually quickly show peduncular peristalsis and, directing its peduncle downward, it will soon anchor itself in the sand by means of this structure. The peduncular waves running from the attached end to the tip of the peduncle give rise to alternate enlargements and contractions, especially of the distal portion of the peduncle, precisely the kind of movement that is appropriate for burying this structure in the sand. It is therefore probable that this form of peristalsis is primarily concerned with the process of sinking the peduncle into the substrate and thereby anchoring the *Renilla*. It is to be noticed, however, that contracted *Renillas* as soon as they commence to show peduncular peristalsis not only begin to anchor themselves, but also start to distend. This occurs even when the animal is in a glass basin of sea-water without sand and is thus unable to sink its peduncle. When I first had the opportunity of studying living *Renillas*, in 1916, I observed the distention of colonies at the same time that peduncular peristalsis was in progress, and as these two processes were invariably associated in the few specimens that I had to work with at that time, I concluded that peduncular peristalsis was an operation by which the colony became filled with water, and not one concerned with anchorage. Since then I have had the opportunity of experimenting on a much larger number of individuals and I have seen specimens of *Renilla* in which the peduncles have been ligated and cut off fill themselves with sea-water. This observation shows that the peduncle is not essential to this operation, as I once believed, and it is my opinion at present that

peduncular peristalsis has to do primarily with sinking the peduncle into the sand and that it is only incidentally concerned with pressure relations in the interior of *Renilla* whereby distention is accomplished. Individuals that are undergoing inflation very commonly show peduncular peristalsis and inflate more rapidly than those in which the peduncles are quiescent. I, therefore, believe that peduncular peristalsis is an aid in this process, but I am convinced that I was mistaken in my first opinion that this operation is essential to inflation. Inflation apparently depends primarily upon the currents of water generated in the lateral siphonozooids, currents that, as I have pointed out elsewhere (Parker, '20), are without doubt ciliary in origin.

Peduncular peristalsis is one of the commonest movements in *Renilla*. If a dozen specimens are made to contract and empty themselves of their contained water and are then placed in a glass vessel of sea-water, within a quarter of an hour half of them perhaps will show peduncular peristalsis. If those showing peristalsis are moved or otherwise disturbed, their activities immediately cease, to begin again only after an interval of quiescence. The operation is, therefore, one freely open to external influences, and yet I have never been able to find any means of exciting it artificially beyond that of causing a colony to discharge its contained water and then allowing it to refill. While this is going on peduncular peristalsis is likely to take place.

Wilson ('83, p. 783) has called attention to the fact that in the young of *R. reniformis* a peristaltic wave can often be seen passing over the colony from the end at which the rachis is forming to the tip of the peduncle. Each wave results in a forward projection of the peduncle, which thus enables the animal to creep in that direction. The same he says is true of the adults. This statement I can confirm for *R. amethystina*, for the adults of this species not only anchor and eventually bury themselves in the sand by means of peduncular peristalsis, but they will also slowly plow through the substrate by this means. In the first instance of this kind that I observed the *Renilla* was in sea-water in a shallow aquarium whose bottom was covered with a few inches of sand. The animal when discovered was

moving very slowly by what was clearly peduncular peristalsis and had left behind it in the sand a trail 6 cm. in length. Subsequently two other instances of a like kind were observed; in one the trail was 21 cm. in the other 24 cm. long. Peduncular peristalsis, therefore, is not only a means of anchoring and even burying the *Renilla* colony, it is a significant means of locomotion.

#### RACHIDIAL PERISTALSIS

Rachidial peristalsis differs fundamentally from peduncular peristalsis in the direction its waves take. These begin in the peduncle and spread through the rachis to disappear on the margin of that structure opposite the attachment of the peduncle, a region which, since it corresponds to the apex of the ordinary sea-pen, may be called the apical margin in *Renilla* (pl. 1, figs. 5 to 8). Thus the direction of rachidial peristalsis is away from the tip of the peduncle, not toward it as in peduncular peristalsis. It is thus easy to distinguish rachidial from peduncular peristalsis, and it is certain that the former was recorded as early as 1864 by Müller in *R. Edwardsii* and *R. reniformis*.

Rachidial peristalsis begins in the distal half of the peduncle and spreads over that structure into the rachis, where it appears as a pronounced transverse constriction represented by a right and a left indentation on the corresponding rachidial margins. These indentations proceed slowly around the edges of the rachis till they meet and obliterate each other on its apical margin.

The following records taken from *Renillas* in sea-water at 23°C. will give a more detailed view of rachidial peristalsis. In one specimen (table 1, A) ten individual waves appeared at intervals varying from 132 seconds to 160 seconds and averaging 146.2 seconds. The period taken by the wave in its passage over the colony varied from 125 seconds to 135 seconds with an average of 130.2 seconds. The resting periods between waves were from 5 to 35 seconds with an average of 16.0 seconds. In a second specimen (table 1, B) the average duration of the wave was 110.5 seconds and of the rest period 21.5 seconds and in a third (table 1, C) 102.5 and 8.5 seconds, respectively. The general averages from these observations show that rachidial waves start about

TABLE 1

*Times in seconds in three specimens of Renilla, A, B, and C, for duration of rachidial wave, rest interval, and total interval from the beginning of one wave to the beginning of the next*

SPECIMEN	DURATION OF WAVE	REST INTERVAL	TOTAL INTERVAL
A.....	130	25	155
	125	35	160
	130	10	140
	127	5	132
	130	15	145
	135	15	150
	135	15	150
	135	5	140
	130	15	145
	125	20	145
Averages.....	130.2	16.0	146.2
B.....	120	5	125
	120	35	155
	115	10	125
	105	35	140
	105	30	135
	115	10	125
	105	30	135
	105	25	130
	110	15	125
	105	20	125
Averages.....	110.5	21.5	132.0
C.....	95	5	100
	90	5	95
	105	5	110
	100	5	105
	105	10	115
	100	20	120
	105	10	115
	110	10	120
	105	10	115
	110	5	115
Averages.....	102.5	8.5	111.0
General average.....	114.4	15.3	129.7

once in 130 seconds and pass over the colony in approximately 115 seconds and that the average resting period is about 15 seconds. As may be inferred from what has been stated, never more than one rachidial wave at a time is to be seen on a colony.

In specimen A of those referred to in the preceding paragraph the distance traversed by the waves over the peduncle and rachis measured 148 mm., and as this course was covered on the average in 130.2 seconds, it follows that the rate at which the wave traveled was 1.1 mm. per second. In specimens B and C the respective courses measured 117 and 133 mm., and the rates in these colonies were, therefore, 1.1 mm. per second for B and 1.3 mm. per second for C, or an average of approximately 1.2 mm. per second for all three. This rate is of the same order of magnitude as that already found for peduncular peristalsis, namely, 1.2 mm. per second. The similarity in rate in these two forms of peristalsis indicates that the organization that underlies them must be essentially the same, though reversed so far as polarity is concerned.

The rate of 1.2 mm. per second for rachidial peristalsis was determined in sea-water at 23°C. Efforts were made to ascertain whether this rate was influenced by changes of temperature, but at 15°C., the irregularities in the responses of the colonies were such that measurements were not possible, and at temperatures much above normal no rachidial peristalsis occurred.

The rachidial peristaltic wave ordinarily makes its first appearance in the distal half of the peduncle and spreads thence as a right and a left wave symmetrically over the rachis, at whose apical margin the two waves meet and obliterate each other. If an incision is made on one side of the rachis (fig. 1), the wave passes around this without suffering interruption, even though the cut may reach well toward the center of the colony. Several cuts of this kind may be made in one or both sides of the rachis without interrupting the wave. If a single lateral cut is made from one side of a rachis through its center well toward the other side (fig. 2), the wave that would naturally pass up the incised side is interrupted at the cut, whereas that which traverses the intact side not only reaches the apical margin,

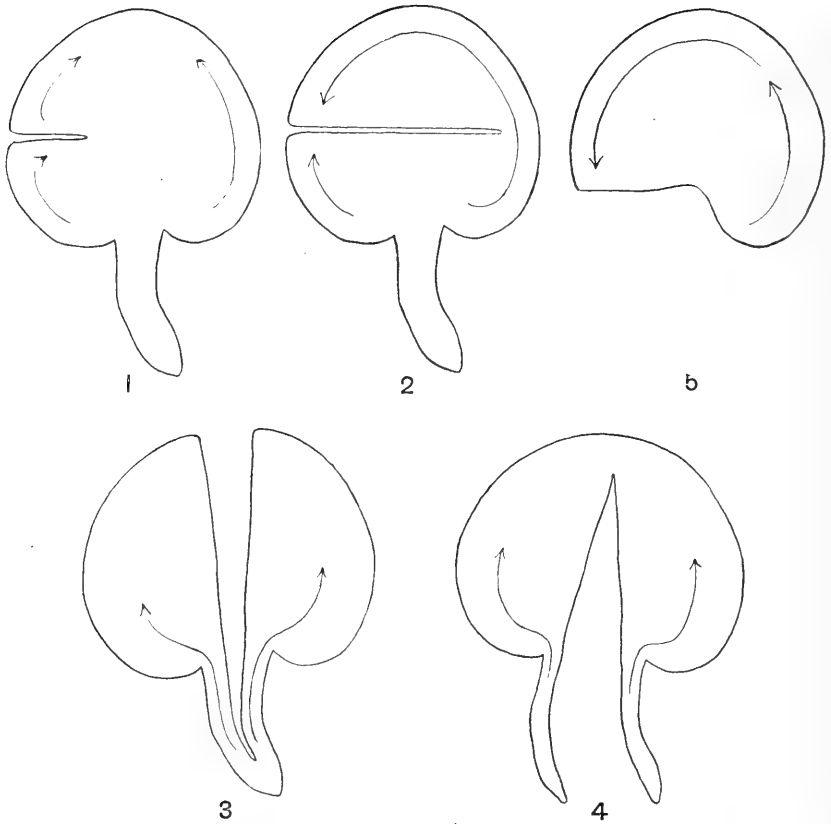

Fig. 1 A *Renilla* with a shallow unilateral incision in the rachis. The course of the rachidial wave is indicated by arrows.

Fig. 2 A *Renilla* with a deep unilateral incision in the rachis. The course of the rachidial wave is indicated by arrows.

Fig. 3 A *Renilla* bisected except for the distal end of the peduncle. The synchronous bilateral, rachidial waves are indicated by arrows.

Fig. 4 A *Renilla* bisected except for the apical margin. The bilateral rachidial waves, not necessarily synchronous, are indicated by arrows.

Fig. 5 A *Renilla* rachis devoid of one lobe and the peduncle. The course of the rachidial wave is indicated by arrows.

where it would ordinarily stop, but passes beyond this and down the opposite side to end at the cut. Thus for the latter extent of its course, after it has passed the apical region, it progresses over a part of the rachis in a direction the reverse of that which is normal for this part. If a *Renilla* is split in its axis from the apical region through its whole extent and the cut is carried well through the length of the peduncle, but not to its distal end (fig. 3), a single wave starts in the peduncle, but is soon represented by a pair of independent but synchronous waves that pass over the two halves of the rachis. If an axial cut is made in the direction severing the two halves of the peduncle completely but leaving the halves of the rachis attached at the apical margin (fig. 4), two entirely independent waves arise, one from each half-peduncle. These waves differ from those in the preceding preparation in that they are not necessarily synchronous. The single peduncular center from which in a normal colony the rachidial wave arises is in this preparation divided into two, and the two half-centers show complete and independent action.

The cutting of incisions not only fails to prevent the formation of a rachidial wave, but considerable parts of a colony may be removed without loss in this respect. Thus, although the rachidial wave ordinarily begins in the peduncle, this whole structure may be ablated without checking the formation of the wave. In a *Renilla* from which the peduncle has been cut the rachidial wave begins in what was the root of the peduncle and proceeds thence as a pair of waves along either side of the rachis to meet and disappear in a normal way on the apical margin. If instead of cutting off merely the peduncle, the whole center of the rachis is removed, the waves still start synchronously in the adjacent lobes thus produced and progress to the usual termination. If, now, one of the lobes is cut off (fig. 5), the wave as a single wave starts from the remaining lobe and proceeds not only to the apical margin, where it would ordinarily cease, but continues onward around the remainder of the edge of the rachis to the region where the lobe was cut off and ends there. If a preparation is made by cutting off a narrow band around the whole edge of the rachis, this band as well as the remaining central portion will

show rachidial waves. In the band a wave will ordinarily start from each end, the two waves meeting and becoming obliterated near the center, which is really the apical margin. The central portion of a rachis from which the edge has been trimmed will exhibit symmetrical waves like those of a small rachis. If the central part of the rachis is reduced by a delamination of the edge till an area containing only a few zooids results, this small central area will pulse, though it is almost impossible to distinguish any special direction to its movements. If a preparation is made by cutting off the sides of the rachis and leaving the axis of that part attached to the peduncle, the rachidial wave, when it appears, can be followed from a point close to the distal end of the peduncle over the whole length of that part as well as over

TABLE 2

*Intervals in seconds between rachidial waves on the separated right and left halves of a rachis*

	NUMBER OF WAVE										AVERAGES
	1	2	3	4	5	6	7	8	9	10	
Right half....	105	115	110	125	120	125	120	115	110	115	115.0
Left half.....	105	125	110	130	115	125	110	115	105	120	116.0

the axis of the rachis to the region of its disappearance on the natural margin.

As might be inferred from the experiments described in the preceding paragraphs, any fair-sized fragment of the rachis of *Renilla* may exhibit rachidial peristalsis. Thus if a rachis is cut in two lengthwise through its chief axis, the two symmetrical halves will continue to show a rachidial peristalsis in which the waves of the two pieces, notwithstanding their separation, run at very nearly the same rate, as shown in table 2. If the two halves come from a *Renilla* that is already in rachidial peristalsis and the longitudinal cut is made quickly, the peristalsis is ordinarily not interfered with. After such an operation the two resulting halves not only beat at the same rate, but their waves even keep in phase for a considerable period of time. Of course sooner or later this agreement disappears.



When a *Renilla* is divided into pieces by cuts transverse to its chief axis, a very different condition from that just described is to be seen. Each piece continues to exhibit contractions, but these contractions have a very different rate in the different regions. Thus in a *Renilla* cut in two transversely through the center of its rachis the peduncular piece was found to contract on the average once in 115 seconds and the apical piece at the lower rate of once in 205 seconds. The same condition was met with in a *Renilla* that had been cut into five instead of two transverse pieces (fig. 6). These five pieces may be conveniently designated as the peduncle, the proximal rachis, the middle rachis, the subapical rachis, and the apical rachis, and their several rates of contraction are recorded in table 3.

TABLE 3

*Rates in seconds at which one wave follows another in separate transverse pieces of Renilla*

PIECES	INTERVALS IN SECONDS BETWEEN WAVES					AVERAGES
Peduncle.....	125	160	185	170	180	164
Proximal rachis.....	175	180	190	165	160	174
Middle rachis.....	205	225	230	200	210	214
Subapical rachis.....	250	225	230	210	240	231
Apical rachis.....	280	250	300	260	310	240

As table 3 shows, the peduncular waves have on the average the shortest interval, 164 seconds, and the farther a piece is removed from the peduncle the longer that interval, till the longest one encountered is 240 seconds, in the apical rachis.

It is worthy of note in passing that, excepting the peduncle, the fragments of colonies such as those on which the tests just recorded were made, were easily kept alive in aquaria for fully a week, during which time they continued to exhibit their differences in rate of contraction.

From these and the preceding observations it appears that rachidial peristalsis may take its origin from almost any section of the colony, but that the rates at which the waves emanate become successively lower as one proceeds away from the pedun-

cle and toward the apical margin. In both these respects rachidial peristalsis has a most striking resemblance to the contraction of the vertebrate heart. In this organ, as in *Renilla*, any part may originate a contraction, but the rate at which such contraction may arise is different for different parts, being most

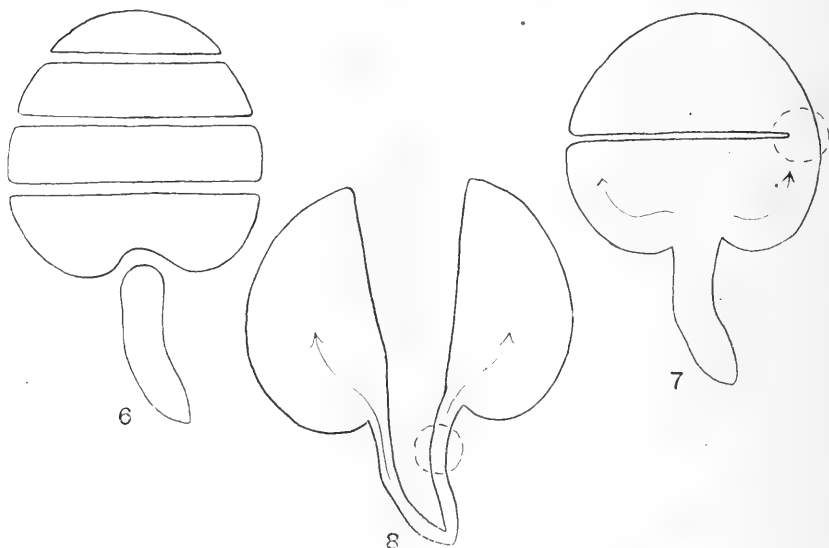

Fig. 6 A *Renilla* cut into transverse pieces to be tested for the rates at which the rachidial waves originate. The pieces may be designated, beginning at the bottom, as follows: peduncle, proximal rachis, middle rachis, sup-apical rachis, and apical rachis. (Compare table 3.)

Fig. 7 A deeply incised *Renilla* in which the connecting bridge of tissue has been treated with magnesium sulphate (dotted circle). The extent of the rachidial waves is indicated by arrows.

Fig. 8 A *Renilla* bisected except for the distal region of the peduncle. One half-peduncle is treated with magnesium sulphate (dotted circle). The two independent rachidial waves are indicated by arrows.

rapid in the sinus, less so in the auricle, and least so in the ventricle. This has been demonstrated in the vertebrate heart by the same method as that used in *Renilla*, namely, by cutting the organ into separate pieces and determining the rate of each piece. If, in consequence of its rapidity of action, the sinus of the vertebrate heart may be regarded as the pace-maker for the

whole organ, so the peduncle of *Renilla* may be looked upon as the pace-maker for the *Renilla* colony. Thus the peristaltic wave that passes over *Renilla* has a most striking resemblance to the wave of contraction that sweeps through the cardiac muscle of the vertebrate.

Although the wave of rachidial peristalsis passes from one part to another of the rachis of *Renilla* so long as there is organic continuity, it can be easily interrupted by anesthesia. If the edge of the rachis of a *Renilla* on which peristaltic waves are running is covered with crystals of magnesium sulphate, in a short time the waves pass around this region as they do around an incision. If a rachis is cut transversely so that the peduncular portion is connected with the apical portion by only a narrow bridge of tissue over which the peristaltic waves pass and this bridge is then covered with crystals of magnesium sulphate (fig. 7), in a few minutes the waves cease to pass across the bridge. On transferring such a preparation to pure sea-water, the bridge will within half an hour or so again transmit waves. If a *Renilla* is cut lengthwise on its principal axis so that the halves are connected only by the distal part of the peduncle, the halves, as already stated, will exhibit synchronous waves, which obviously have a common starting-point in the distal portion of the peduncle. If, now, the halves of the split peduncle are spread apart and crystals of magnesium sulphate are applied to one of these arms (fig. 8), the synchronism of the two halves of the rachis soon disappears, showing that one of them, that on the anesthetized arm is no longer under the control of the original peduncular center. On washing off the anesthetic and returning such a preparation to pure sea-water, synchronism in the peristaltic waves begins to reappear in about twenty minutes and is fully reestablished in thirty-five minutes. Magnesium sulphate is an effective temporary means of checking the waves of rachidial peristalsis.

I have been no more successful in exciting artificially rachidial peristalsis than I have been in inducing peduncular peristalsis. If a dozen contracted *Renillas* are set aside in as many bowls of sea-water and time is given them for partial distention, a number

of them may show rachidial waves and they may then be studied. But aside from this indirect way of inducing the formation of these waves, I know of no special method by which they may be excited. If a *Renilla*, in which rachidial peristalsis is in progress, is slightly disturbed by being gently handled or even merely jarred, these movements like those of peduncular peristalsis are likely to cease for a time. Thus, although the excitation of rachidial waves was impossible for me to accomplish by external means, their cessation is in this manner easily brought about. The interruption of rachidial peristalsis is almost certain to occur if the stimulus is applied during the brief period that intervenes between waves; it is much less likely to occur if it is applied during the passage of the wave. This suggests another point of similarity between the rachidial wave and a heart beat, for just as the contraction of the cardiac muscle is followed by a refractory period during which the muscle is not open to the reception of a new stimulus, so the passage of a rachidial wave in *Renilla* prevents the reception of a stimulus which, had it been applied in the period between waves, would undoubtedly have been an effective agent.

Rachidial peristalsis has been referred to by Eisen ('76, p. 13) as a means of locomotion. And it is true that when a *Renilla* is distended and in sea-water on the surface of the sand, rachidial peristalsis will bring about a movement from place to place. Thus in one example of this kind, a *Renilla* was observed as a result of ten rachidial waves carried out during twenty-five minutes to have shifted its position 4.2 cm. The movement was of a slow floundering kind and seemed to be the accidental result of the peristalsis rather than a direct and obvious effect of it as implied by Eisen. Although rachidial peristalsis may thus really result in locomotion, I am disinclined to regard it as a real means of locomotion in the same sense that I do peduncular peristalsis.

The real significance of rachidial peristalsis, in my opinion, is not locomotion, but the emergence of the colony from the sand and its distention. After a colony has remained contracted for some time in a sand bank exposed by the falling tide, it is in a condition to reinflate itself on the return of the water. This it

does primarily by the currents of water generated by the lateral siphonozooids, but the process of distention and the elevation of the colony as a whole is greatly aided by rachial peristalsis. Thus a contracted *Renilla* that had more or less buried itself in the sand of the aquarium was seen to begin distending itself by taking in water. In a short time one of its autozooids had expanded and was projecting through the thin layer of sand that covered the rachis. In half an hour five zooids had expanded, and in an hour almost all were expanded, whereupon rachial peristalsis set in and in a short time the whole rachis was full and plump and lifted well above the level of the sand. Thus rachial peristalsis is apparently a very effective supplement in the process of expansion and may in fact be essential to its completion. At least I have never seen a *Renilla* reach full and complete distention without exhibiting vigorous rachial peristalsis toward the close of the operation.

Although neither peduncular nor rachial peristalsis is essential to inflation, both these processes seem to aid this operation greatly, for in their presence it goes on more rapidly and to greater completion than otherwise. They are both doubtless the means of moving the sea-water contained within the colonial spaces, and thus they may be regarded as important distributors of the fluid supplied by the lateral siphonozooid. This view of the significance of the peristaltic movements was long ago advocated by Marshall (Musgrave, '09, p. 461).

Peduncular peristalsis takes its origin apparently somewhere in the proximal half of the peduncle. Rachial peristalsis is initiated in the distal half of that part. Hence the middle of the peduncle is a region that may at one time be occupied by peduncular waves running distally and at another time by rachial waves running proximally. It is, therefore, not surprising that under normal conditions peduncular and rachial peristalsis never occur at the same time. In the hundreds of examples of these movements that I have observed in living normal *Renillas*, I have never seen a single instance in which these two forms of peristalsis occurred on the same individual at once. This relation is a natural one, for, if peduncular peristalsis has to do with

anchoring and burying a colony and rachidial peristalsis with elevating it, it is natural that the two sets of waves should not be running at the same time. In a purely accidental way I discovered a means, however, by which these two operations might be made to occur simultaneously. If a ligature is tied firmly about the peduncle of an inflated *Renilla* at a position not far from the proximal end of that part and the colony is returned to a basin of sea-water, after an interval of half an hour or more two sets of waves may appear: peduncular waves running over the peduncle distally from the ligature and rachidial waves beginning in the base of the peduncle and passing in the usual direction over the rachis. The simultaneous occurrence of these two sets of waves is due, I believe, to the separation of the colony into two parts by the ligature which is so effective as to bring about a complete physiological dissociation of the regions concerned.

#### PHOSPHORESCENCE

As early as 1850 Agassiz made the observation that *Renilla reniformis* "shines at night with a golden green light of a most wonderful softness," a peculiarity which is apparently common to most sea-pens (Mangold, '10-14; Dahlgren, '16). If a fresh specimen of *Renilla amethystina* that has been exposed to ordinary daylight is carried into a darkroom and stimulated by being prodded gently, no phosphorescence is observable. On trying the same experiment at night, the colony glows with a wonderfully clear blue-green light. During August in La Jolla this phosphorescence made its first appearance about half past eight o'clock in the evening and could be excited any time during the night until toward sunrise.

If during daylight non-phosphorescent colonies are transferred to a dark room and kept there, they begin to show phosphorescence on stimulation in about half an hour and attain what seems to be their maximum capability under these circumstances in from fifty-five to sixty-five minutes. The phosphorescence thus developed seemed never to reach the degree of brightness seen during the night. This is not easy to judge by the eye, but

nevertheless I believe it to be true. It probably rests upon a natural daily rhythm in the animal's metabolism. Phosphorescence induced during the daytime by placing a colony for an hour or so in the dark is completely lost on exposure to daylight for about five minutes. If during the night a colony that shows a naturally acquired bright phosphorescence is illuminated by a strong electric light (40-watt Mazda lamp at 40 cm. distance), the ability to produce light steadily decreases. After five minutes' exposure to light the phosphorescence of the *Renilla* was obviously fainter than that of another kept in the dark as a check. And after ten minutes' exposure it was very faint in comparison. Continued exposure, however, never totally obliterated the light, showing that either electric light is not so effective in this respect as daylight or that during the night *Renilla* is more efficient in producing those substances necessary for the production of light than during the daytime. *Renilla* is then like certain other marine organisms, ctenophores for instance (Peters, '05), which become capable of phosphorescence only in the dark and lose this capacity more or less completely in the light, especially in daylight.

*Renilla* is phosphorescent only on stimulation. If in the nighttime a spot on the superior surface of the rachis is stimulated mechanically by being prodded or pinched or excited by a faradic current, a series of luminous ripples emanate from it and spread concentrically over the rachis like waves over the smooth surface of a pond into which a pebble has been thrown. If a fine needle point is used as a mechanical stimulus, a single point of light can be excited on the rachis, and this point will glow for some seconds and without becoming a center from which waves emanate, thus showing that in this instance the activity is strictly local. Although the phosphorescence of *Renilla* can easily be excited by mechanical stimulation, it is noteworthy that the rachidial waves, which were often found running on *Renilla* in the night and must have produced considerable mechanical disturbance, never excited phosphorescence. If, however, a specimen on which rachidial waves were running was even gently prodded with a rod, waves of phosphorescence would sweep over it uninterruptedly even while the rachidial wave was in progress.

When a glowing rachis is examined under a hand-lens the parts from which the light emanates are seen to be the accumulations of whitish material in which the siphonozooids are imbedded and which surrounds the bases of the autozooids. Apparently light emanates from no other source. If the peduncle with the narrow smooth band of tissue leading from this body to the axial siphonozooid is cut from a *Renilla* that is capable of phosphorescing, no amount of stimulation either mechanical or electrical will call forth any luminosity in it. No phosphorescence has even been induced on the ventral surface of the rachis. Phosphorescence is quite clearly limited to that part of the dorsal surface of the rachis that is covered by the zooids, and, as already stated, the particular bodies concerned with luminosity are the small accumulations of light-colored material limited to this region. The observations upon which this statement rests are not as easily and directly made as might be supposed. As the phosphorescence of *Renilla* is best seen only in complete or almost complete darkness, it is impossible to determine at the time when the light can be seen the exact spot from which it emanates, for the light itself is not strong enough to illuminate the general surface of the rachis. An indirect method of determining the exact parts concerned in light production was therefore resorted to and the various parts of the rachis were tested. For instance, in a dim artificial light, a single autozooid was cut from a colony and placed upon a glass slide. This was then carried into a dark room, covered with another slide and crushed. Under such circumstances no light was even observed. The same was true of fragments of the purple flesh of the dorsal surface of the rachis. When, however, a group of siphonozooids with the surrounding light-colored material was crushed, a momentary sparkling could be clearly seen. This was also observed when the light-colored base of an autozooid was crushed. These two parts were the only parts from which light could be produced in *Renilla*.

The light material which is thus associated with phosphorescence is seen on close inspection to include two substances: a whitish chalky substance and a light-yellowish crystalline one. Thus in a group of siphonozooids the central portion is made up



of the whitish chalky material and the peripheral part of the light yellowish substance. These two materials, however, were so intimately associated that it was found impossible either to separate them satisfactorily or to determine by direct inspection which was responsible for the light. In only one region could satisfactory evidence be obtained and that was on the extreme edge of the rachis. Here the two materials form a well-marked double fringe, the outer fringe being composed of the white material and the inner one of the yellowish. This edge, especially when observed from the ventral side of the rachis, shows these two fringes with great clearness, and when phosphorescence occurs, it can be definitely seen that the light is associated with the whitish substance and not with the yellowish one. Hence I conclude that the phosphorescence emanates from the white component of the light-colored masses. The light that this component produces when seen under a hand-lens is indescribably beautiful; it is a combination of intense blue-greens comparable to what one sees in a brightly illuminated opal.

The application of mechanical or electrical stimuli under appropriate conditions to the rachis of *Renilla* results in what seems to be a series of luminous waves emanating concentrically from the region of stimulation. When one of these wave fronts is closely scrutinized, it is found to be not a continuous line, but a series of luminous points which represent the small masses of white material already alluded to as the source of the light and which for the moment lie in what would be a continuous wave front. Thus the appearance of a wave is due to the momentary glowing of one concentric line of points after another as the impulse that induced the phosphorescence spreads from the center of stimulation outward. This spread of light from the center of stimulation to the rest of the colony in other sea-pens than *Renilla* was apparently first recorded by delle Chiaje in 1836 (Panceri 71, p. 11).

As with rachidial peristalsis, the waves of luminosity pass around incisions in the rachis, provided these incisions do not completely separate the parts concerned. If the rachis is cut nearly in two transversely, the luminous waves may be started

by mechanical stimulation in either part and will pass thence over the connecting bridge of tissue to the other part. If two symmetrical transverse cuts are made leaving the two parts connected by a narrow axial bridge, the luminous waves will pass from the peduncular to the apical piece or the reverse with perfect freedom. If the region of stimulation is axial in position, the

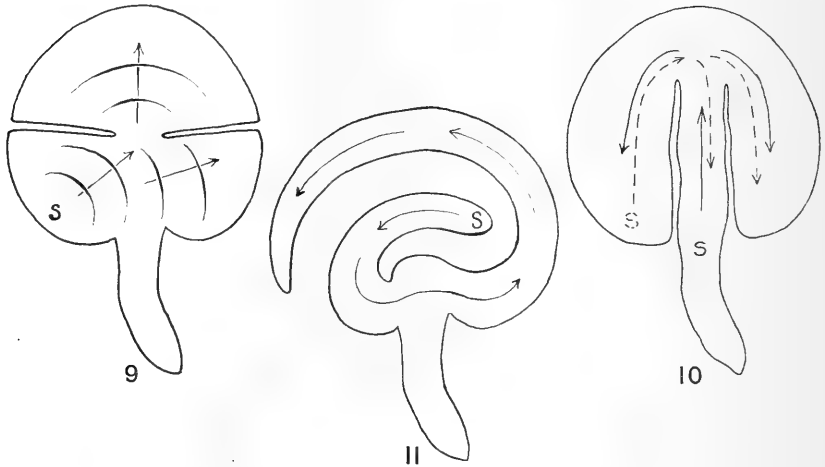

Fig. 9 An almost divided *Renilla* stimulated at *S* for phosphorescence. The luminous waves in the peduncular portion of the rachis are unsymmetrical; in the apical part, in consequence of the median position of the bridge, they are symmetrical.

Fig. 10 A *Renilla* partly divided by two longitudinal slits. When the stimulus to phosphorescence is applied in a median position (*S*), the luminous waves have a symmetrical course (solid arrows); when it is applied in a lateral position (dotted *S*), the course is unsymmetrical (dotted arrows).

Fig. 11 A *Renilla* whose rachis has been cut into a scroll and is somewhat unfolded. A stimulus to phosphorescence applied at *S* is followed by a luminous wave that takes the course of the arrows.

spread of the wave over the stimulated part as well as over the unstimulated one is symmetrical with reference to the axis. If the region of stimulation is lateral to the axis (fig. 9), the spread of the wave is unsymmetrical in the stimulated part, but becomes symmetrical on the unstimulated part in consequence of the symmetrical position of the bridge. If the rachis is cut into three

lobes by incisions that enter it symmetrically from its peduncular margin and it is stimulated at the root of the peduncle (fig. 10), a symmetrical wave of light spreads over the central lobe and into the lateral ones. If a lateral lobe is stimulated, the wave passes to the apical margin and thence onto the other two lobes. If the rachis is cut into a scroll that can be unfolded into an elongated form (fig. 11), stimulation at one end will start a luminous wave that will pass to the other end.

If a colony is split longitudinally through its chief axis and the halves remain attached only through the distal part of the peduncle (as in fig. 3), the stimulation of one half-rachis calls forth a flash of light in that half which, after it has subsided, is followed by another flash in the other half. The second flash follows the first at such an appreciable interval of time that the preparation seems to wink first with one eye and then with the other. In such a test as that just described the interval between flashes is due to the transmission of the wave of excitation through the non-luminous peduncle, for if the peduncle is completely split no such transmission occurs even if the halves of the peduncle are closely applied to each other. This observation shows that the luminous waves are under the control of some form of transmission, non-luminous in character, that spreads in wave-like fashion and for which the phosphorescent waves may be said to be luminous replicas. It also makes clear that the peduncle can transmit the impulses that excite luminosity in the rachis. Not only can the peduncle transmit these impulses, but it can also originate them, for if the distal end of the peduncle of *Renilla* is pinched, in a moment the attached rachis flashes in waves of phosphorescence. Even when the peduncle is split longitudinally and the cut is carried through much of the rachis toward its apical margin, the stimulation of the distal end of a half-peduncle will call forth in the half rachis of the stimulated side waves of light that pass over quickly onto the half-rachis of the opposite side.

As might be inferred, any portion of the rachis carrying the white material already alluded to can be made on stimulation to glow. Thus right or left halves, apical or peduncular seg-

ments, quadrants, centers, margins, or even minute fragments will on appropriate treatment give out light.

The impulses that induce phosphorescence are profoundly influenced by such anesthetics as magnesium sulphate. If a portion of the rachis of a *Renilla* is covered with crystals of magnesium sulphate, waves of luminosity can be started in the untreated part and will pass into the treated part for about four or five minutes, after which they will cease on the edge of the treated part, nor will this part give out light even when it is directly stimulated. On washing off such a preparation and putting it in pure sea-water, the power to produce light will return to the treated part in half an hour or so. If a preparation is made by cutting a rachis almost in two by a transverse incision and, after determining that the connective bridge will transmit luminous waves, this bridge is covered with crystals of magnesium sulphate (as in fig. 7), the waves of light will in ten minutes or so be blocked at this point and light will be produced in only that part of the rachis which is directly stimulated. If the edge of a rachis is cut off in the form of a strip 5 to 6 mm. wide and this strip is pinned out in sea-water, waves of phosphorescence can be made to run over it in either direction by appropriate stimulation. If, now, crystals of magnesium sulphate are freely applied to the middle of the strip, the luminosity of the region thus treated begins to decline and, after five minutes, it ceases altogether, though occasional waves that seem to stop on one side of it reappear on the other side. A complete block occurs, however, in from nine to ten minutes and waves of phosphorescence started on one side of the treated area do not reappear on the other. After half an hour in pure sea-water the phosphorescent waves reestablish themselves and pass freely through the region previously anesthetized with magnesium sulphate.

If a V-shaped preparation is made from a *Renilla* by splitting it through its long axis except at the distal end of the peduncle, it will be found, as already stated, to transmit impulses for light production from one half-rachis to the other through the partly split peduncle. If the unsplit portion of this part is covered with crystals of magnesium sulphate, in five to ten minutes no impulses

to illumination pass through it, for when one half-rachis is excited to glow, the other half-rachis does not follow by producing a flash. Recovery from this condition occurs in such preparations after they have been for half an hour or so in pure sea-water.

The rate at which the luminous waves traverse the rachis of *Renilla* is a relatively slow one. It, therefore, seemed possible to measure it and attempts were made to carry this out by a photographic method, but the light that emanates from a single phosphorescent wave in *Renilla* is so faint that the most rapid photographic plates obtainable, even when sensitized for blue-green, were not fogged by it. In this test the plates were exposed to the light without the use of a lens and under water next the source of illumination. Photographic methods were, therefore, abandoned and an attempt was made to determine the rate by the use of a stop-watch and a long strip of phosphorescent tissue. Strips of this kind were cut from the edges of large rachides; they measured 5 to 8 mm. in width and about 10 cm. in length. When first cut they were much contracted, but in an hour or so they relaxed and could be pinned out each in a small wax-bottomed dish of sea-water. After night had come on these strips could be stimulated by touching one end gently with a metal rod, whereupon a single wave of light would start at that end and pass rapidly over the length of the strip to the opposite end. If the stimulus was somewhat irregular, several such waves would pass over the preparation in rapid succession, but with a little attention the application of the rod to the end of the strip could be so regulated that a single wave was invariably called forth. Each wave consisted of a band of light transverse to the long axis of the preparation and with a sharp front edge and a faint rear. The width of the band of light itself in the direction in which it moved was 4 to 6 mm. This band progressed with great regularity from one end of the preparation to the other, and its rate could be taken with fair certainty by a stop-watch. The results of measurements on five such preparations are given in table 4, from which it will be seen that the waves travel on the average 9.24 cm. in 1.25 seconds or 7.39 cm. per second. This rate is close to the determination made on the same phenom-

enon in *Pennatula* by Panceri ('71), namely, 5 cm. per second, and is approximately sixty to sixty-five times as fast as the rachidial (1.2 mm. per second) and the peduncular rates (1.1 mm. per second). This indicates that the process of transmission that underlies the waves of luminosity is probably entirely different from that which controls peduncular and rachidial peristalsis.

Other evidence that is in favor of the view that these two forms of transmission are essentially distinct is seen in a certain kind of mutual independence that they sometimes show. When

TABLE 4

*Times in seconds for the passage of waves of luminosity over strips of Renilla rachis. The stimulus, pressure of a rod, was applied first at the right-hand end of the preparation and then at the left-hand end. Temperature of water 21°C.*

SPECI- MEN	NUMBERS OF THE TESTS										AVERAGE TIME	LENGTH  <i>cm</i>
	1	2	3	4	5	6	7	8	9	10		
A	1.0	1.0	1.2	1.4	1.2	1.2	1.2	1.0	1.4	1.0	1.16	9.3
B	1.0	1.4	1.2	1.2	1.2	1.0	1.4	1.2	1.0	1.2	1.18	9.2
C	1.2	1.0	1.4	1.4	1.2	1.2	1.0	1.2	1.4	1.0	1.20	9.3
D	1.0	1.2	1.2	1.0	1.2	1.0	1.2	1.4	1.0	1.2	1.14	9.2
E	1.4	1.2	1.4	1.6	1.4	1.8	1.6	1.4	1.6	1.4	1.58	9.2
General averages.....											1.25	9.24

a strip of tissue is prepared from the margin of the rachis of *Renilla* for the measurement of the rate of the phosphorescent waves, it is not uncommon to find that after a time rachidial peristalsis appears on it. When this occurs at night, an interesting comparison between the two sets of waves can be instituted. In one preparation where this occurred, the rate of the rachidial wave was measured and found to be approximately 1 mm. per second. The preparation was then placed in a dim light, and just after a rachidial wave had started from one end that end was stimulated mechanically and a rapid wave of phosphorescence was made to run over the whole strip. On quickly throwing a bright light on the preparation the rachidial

wave that had been observed to start from the given end was now seen to be more than half-way across the strip and progressing uninterruptedly toward the farther end notwithstanding the fact that it had been passed over by a wave of phosphorescence. The passage of these two waves, one rachidial and the other phosphorescent, on the same band of tissue and in a way so that one overtook and outran the other without, however, interfering with it, affords a strong argument in favor of their independence.

The rate at which the wave of luminosity passes over the rachis of *Renilla*, 7.39 cm. per second, was determined in sea-water at a temperature of 21°C. To ascertain whether this rate is influenced by changes of temperature, two sets of determinations were made, one at 11°, 21°, and 31°C., and another at 15°, 20°, and 25°C. These temperatures were maintained by immersing the strips of rachis pinned out on wax in large vessels of sea-water at the desired temperature. In the initial set the readings were taken first at 21°, then at 11°, next at 31°, and finally as a check at 21° again. In the second set the sequence of temperatures was 15°, 20°, 25°, and 15°C. In both instances the rate characteristic for the first test was recovering after the tissue had been subjected to lower and higher temperatures, showing that these temperatures had not of themselves caused any permanent alteration in the tissues. The results of these two sets of tests are given in tables 5 and 6.

In the first set of determinations (table 5) the average rate per second at 11° was 4 cm.; at 21°, 7.6 cm., and at 31°, 20.7 cm. In the second set (table 6) the average rate per second was at 15°, 6.5 cm.; at 20°, 8.3 cm., and at 25°, 12.2 cm. The relations of these records can best be seen in figure 12, where the two groups are plotted independently. As these plottings show, the two sets of determination lie close together and are reasonably conformable. Their relations are better expressed by slightly curved lines than by straight ones. As is shown in the shorter set, an increase of 10° in temperature is accompanied by an approximate doubling of the rate, 6.5 cm. to 12.2 cm. per second. Judging from the curve itself, the same appears to be true of the longer set except for its upper range. If in this set the rate per

second at 21° is taken to be 7.7 cm., then at 11° half that, or 3.85 cm., should be expected, which is very close to the observed rate of 4.0 cm. per second. On this basis at 31°, a rate of twice 7.7 cm., or 15.4 cm., per second should be looked for, but as a matter of fact the rate at this temperature was found to be 20.7 cm. Aside from this determination, however, all the other rates

TABLE 5

*Times in seconds for the passage of waves of luminosity over a strip of Renilla rachs 9.1 cm. long and subjected to the following temperatures: 21°, 11°, 31°, and 21°C. (see figure 12)*

TEMPERATURE	NUMBERS OF THE TESTS										AVERAGE TIME	RATE PER SECOND
	1	2	3	4	5	6	7	8	9	10		
21°	1.2	1.0	1.2	1.2	1.4	1.0	1.2	1.4	1.0	1.2	1.18	<i>cm.</i> 7.7
11°	2.0	2.2	2.0	2.4	2.4	2.2	2.4	2.4	2.4	2.4	2.28	4.0
31°	0.4	0.4	0.2	0.4	0.6	0.4	0.6	0.4	0.4	0.6	0.44	20.7
21°	1.0	1.4	1.2	1.4	1.2	1.2	1.0	1.2	1.4	1.0	1.20	7.6

TABLE 6

*Times in seconds for the passage of waves of luminosity over a strip of Renilla rachs 9.3 cm. long and subjected to the following temperatures: 15°, 20°, 25°, and 15°C. (see figure 12)*

TEMPERATURE	NUMBERS OF THE TESTS										AVERAGE TIME	RATE PER SECOND
	1	2	3	4	5	6	7	8	9	10		
15°	1.6	1.4	1.6	1.4	1.2	1.4	1.2	1.6	1.4	1.4	1.42	<i>cm.</i> 6.5
20°	1.0	0.8	1.2	1.4	1.0	1.4	1.2	1.4	1.0	0.8	1.12	8.3
25°	0.8	0.6	0.8	0.8	0.8	1.0	0.6	0.8	0.8	0.6	0.76	12.2
15°	1.4	1.2	1.4	1.4	1.6	1.2	1.6	1.4	1.2	1.6	1.40	6.6

are related in the sense that for every interval of 10° the higher rate is approximately twice the lower one. Although the usual interpretation of this condition has been more or less questioned recently, it is generally assumed, in accordance with the Van't Hoff law, that such relations in rates are indicative of chemical rather than of physical processes, an assumption that would align the kind of transmission that occurs in the wave that con-



trols the phosphorescence of *Renilla* with the burning of a trail of gunpowder rather than with some form of transmission of a purely physical type.

#### RESPONSES OF AUTOZOÖIDS

The autozoöids of *Renilla* are for the most part relatively large polyps scattered to the extent of several hundred over the superior surface of the rachis of the colony. When fully distended they

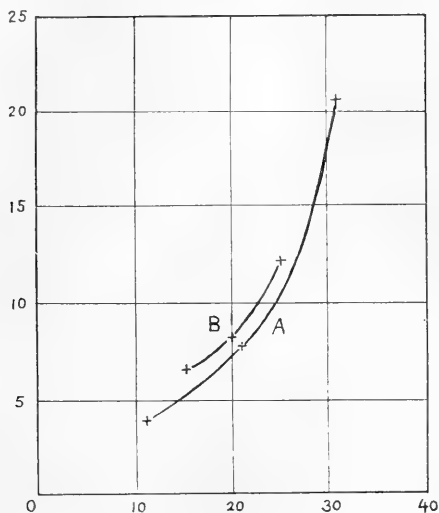

Fig. 12 Plottings of the rates of progression of the luminous waves on marginal bands from the rachis of *Renilla* as influenced by temperature. Ordinates represent centimeters per second; abscissae centigrade degree of temperature. Plotting A is taken from table 5, plotting B from table 6.

may rise 5 to 6 mm. above the level of the rachis and may have a diameter of as much as  $1\frac{1}{2}$  mm. They are delicately transparent and their mesenteries are easily visible through their outer walls. At the distal end each autozoöid has an elongated mouth, the axis of which, as already stated, is related to a structural axis of the colony as a whole. When the zoöid is fully expanded the mouth is seen to be surrounded by white lips from which eight rays pass out corresponding to the mesenteries within and bounding the bases of the eight tentacles. These

tentacles, which are pinnate, are located one at each end of the mouth and three in each of its two sides.

The autozooids are in some respects remarkably inert. They may be touched, prodded, and even bent from side to side without being brought to contraction; to such treatment they respond like inert elastic bodies filled with fluid under slight pressure. Only after the most vigorous mechanical stimulation can an autozooid be made to respond by withdrawal.

If they are flooded with weakly acidulated sea-water or with sea-water containing ethyl alcohol, they quickly contract. If they are touched with platinum electrodes, they give no response, but if a faradic current is sent through them, they draw in immediately. They contract on being touched with a naked copper wire, though they do not respond to contact with one that has been dipped in melted paraffin, showing that the reaction to the uncovered wire is probably due to the minute electric currents generated by the unprotected metal (Parker and Van Heusen, '17). To such currents they seem to be especially sensitive.

In withdrawing, the autozooids sink into pits in the common flesh of the colony. The process of withdrawal ordinarily involves three steps: the folding together of the tentacles, the sidewise bending of the zooid so that its mouth points usually toward the chief axis of the colony, and the retreat of the zooid into the zooid-pit by a process of infolding that begins at the base and eventually involves the whole zooid. The folding of the tentacles may take place before the bending of the zooid or the reverse, but in either case these two operations always precede the slipping of the zooid into its pit. The expansion of the autozooids is in all essential respects the reverse of their contraction and is brought about apparently by the slight pressure of fluids from within acting on relaxed tissue.

When a single autozooid is stimulated vigorously by a faradic current, it can be brought to a speedy and full withdrawal, but such stimulus is rarely if ever followed by the contraction of an adjacent zooid. When such a contraction does occur, it is by no means certain that it is due to the spread of an impulse from the stimulated zooid, for it happens so rarely that it may be a

spontaneous response of the neighboring zoöid itself and not due to transmission. Even the decapitation of a zoöid with a pair of sharp scissors and the subsequent vigorous contraction of the remaining stump does not seem to affect the neighboring individuals. In a similar manner when one autozoöid or a group of such individuals is fed with minute bits of crab meat or with tow, the zoöids directly concerned open their mouths, but the neighboring ones do not so respond. As a result of many tests of this kind I have come to the conclusion that, though autozoöids are freely open to individual stimulation, they of themselves are not centers from which impulses pass with any degree of freedom to neighboring zoöids or to the colony as a whole.

Although an autozoöid cannot be said to be a center from which impulses pass freely to the rest of the colony, impulses from the general colony reach the autozoöids with great ease. Thus if the distal tip of the peduncle or the dorsal surface of the rachis of an expanded *Renilla* is touched with a rod, the whole assemblage of autozoöids will quickly withdraw, an operation which is very much less likely to happen when the stimulus is applied to the root of the peduncle or to the ventral surface of the rachis. A faradic current applied to the tip of the peduncle or to the rachis also induces a general withdrawal of autozoöids. These conditions show clearly that stimulation of parts of the colony other than the autozoöids readily excites impulses that reach these polyps, notwithstanding the fact that the converse of this can scarcely be said to be true.

Effective stimuli applied to the tip of the peduncle and to the rachis are not only followed by the withdrawal of the autozoöids, but also commonly call forth more or less general contraction of the whole rachis, a reaction which can likewise be induced by very intense artificial illumination such as that from a powerful arc-light.

This general contraction may result in a discharge through the axial pore of some of the water contained in the colony, but it usually sooner or later passes off and the colony quickly refills itself. The general contraction just described must be due to the activity of the rachidial musculature as a whole, and when

carried to an extreme it temporarily reduces the colony to a mere fraction of its original volume. A stimulus that will bring about a withdrawal of zoöids will not always induce a contraction of the whole colony, so that these two processes must not be regarded as invariably concomitant.

The passage of impulses from any part of the colony into the individual zoöids is not interfered with by making cuts in the colony so long as the resulting pieces still retain organic connections. Incisions may be made to any number or extent and the rachis may be cut into narrow strips or complicated forms, but, so long as organic continuity is retained, impulses will spread from the region of stimulation to the most distant autozoöid and bring about its withdrawal. In short the spread of this form of impulse, so far as experimental pattern is concerned, is exactly like that of the spread of the impulses for phosphorescence. Even in preparations in which the colony is cut almost in two along its chief axis and the halves remain attached only through the distal tip of the peduncle, the stimulation of one half-rachis involves not only the contraction of the autozoöids of that half, but, after a brief interval, the contraction of those of the other half. This reaction suggests that the impulses to zoöid contraction run in waves as do those for phosphorescence, and this is probably true, but the zoöids contract so slowly as compared with the flashing of the phosphorescent points that, under ordinary circumstances, the undulatory nature of the impulse is quite lost sight of.

The impulse to zoöid withdrawal is checked by magnesium sulphate in the same manner as is that for phosphorescence. If a rachis is cut in two except for a small bridge of tissue over which impulses to zoöid contraction can be shown to pass and this bridge is covered with crystals of magnesium sulphate, in approximately five minutes the impulses begin to fail to pass and in ten minutes no zoöid contractions occur on one side of the bridge when the other side is stimulated. After about half an hour in pure sea-water, transmission over the bridge of tissue is again resumed. The same kind of temporary block can be established at the unsplit distal end of the peduncle of a partly bisected colony

paralleling in all respects what has been found for the transmission of phosphorescent impulses.

The rate at which the impulse to zoöid contraction traverses the rachis can be measured in much the same way as that for phosphorescent transmission. When a band of tissue is cut from the edge of a large rachis, pinned out in sea-water, and allowed to remain undisturbed till its zoöids have expanded, a stimulus applied at one end is followed by a wave of contraction that starts among the zoöids at the stimulated end and progresses to those at the opposite end. Although on the uncut rachis

TABLE 7

*Times in seconds for the passage of waves of zoöid contraction over strips of Renilla rachis. The stimulus, pressure of a rod, was applied first at the right-hand end of the preparation and then at the left-hand end. The preparations were the same as those used in the determinations given in table 4. Temperature of water, 21°C.*

SPECI- MEN	NUMBERS OF THE TESTS										AVERAGE TIME	LENGTH
	1	2	3	4	5	6	7	8	9	10		
A	1.0	1.0	1.0	1.2	1.0	1.2	1.4	1.0	1.4	1.2	1.14	9.3
B	1.2	1.0	1.2	1.4	1.0	1.2	1.4	1.0	1.2	1.4	1.20	9.2
C	1.0	1.4	1.0	1.2	1.2	1.4	1.0	1.2	1.2	1.0	1.16	9.3
D	1.2	1.2	1.4	1.0	1.2	1.0	1.2	1.4	1.0	1.2	1.18	9.2
E	1.2	1.0	1.2	1.4	1.0	1.2	1.4	1.4	1.4	1.2	1.24	9.2
General averages.....											1.18	9.24

such waves can scarcely be seen, their presence can be demonstrated beyond a doubt when a long stretch of tissue, such as the band described, is used, and if the interval between the contraction of the first large zoöid on the stimulated end and that of the last large one on the opposite end is timed, the rate of transmission of the impulse to zoöid contraction can be easily found. The five bands that were used for the determination of the rates of the phosphorescent impulses on the night of August 15th were used again the next morning in daylight for the determination of the rates for zoöid contraction. The results are given in table 7, and it will be seen that the average rate for these five pieces is 9.24 cm. in 1.18 second, or 7.83 cm. per second. This

rate is essentially identical with that obtained from the same bands for the waves of phosphorescence (7.39 cm. per second), and suggests that these two activities, phosphorescence and the withdrawal of autozooids, are controlled by the same kind of transmission.

Having found that the rate of transmission of the impulse to zooid withdrawal at a temperature of 21°C. was the same as that for the wave of phosphorescence at the same temperature, an attempt was made to ascertain whether change of temperature influenced the rate of withdrawal as it did that for phosphorescence. But the withdrawal of zooids is a much less accurately timed operation than the passage of a wave of phosphorescence, and I found it impossible to obtain accurate time readings for withdrawal. At 11°C. the rate at which the withdrawal wave traveled was certainly much slower than at 21°C., but how much slower could not be determined with accuracy. In a few instances where the attempted determinations seemed especially clear and decisive the times ranged from 2.6 seconds to 3 seconds for a stretch of 9.24 cm. Assuming the average time to be 2.8 seconds, this yields a rate of 3.3 cm. per second, which is very close to that found for phosphorescent transmission at this temperature, namely, 4 cm. per second. But these determinations were too few in number and too scattering to be relied upon, and the only conclusion that I feel justified in drawing from them is that the rate at 11°C. is slower than at 21°C.

If actual determinations were difficult at 11°C., they were quite impossible at 31°C. At this temperature the wave often seemed much quicker than at 21°C., but its beginning and ending were each so vague and indistinct that it was impossible, even by watching individual terminal zooids, to obtain any reliable readings. The most that can be said for this aspect of the question is that with increased temperature the wave for withdrawal appears to increase its rate.

When these two forms of transmission, that for phosphorescence and that for zooid withdrawal, are compared, they are found, as must have been evident from the foregoing account, to be strikingly similar. They both spread through the colony in the

same diffuse way; they are both temporarily interrupted by the action of magnesium sulphate; they have essentially the same rate, and they are both quickened by high temperatures and slowed by low ones. Because of these points of resemblance I believe them to be one and the same thing, a diffuse nervous transmission carried out in all probability by an unpolarized nerve-net. This view is supported by the fact that the rate of this transmission, 7.39 to 7.83 cm. per second, is not far from that for the nerve-net of the sea-anemone *Metridium*, namely, between 12.1 and 14.6 cm. per second (Parker, '18). In both *Metridium* and *Renilla*, however, the rate is relatively low as compared with that found in jelly-fishes, namely, 22.9 cm. per second for *Aurelia* (Romanes, '78) and 77.5 cm. per second for *Cassiopeia* (Harvey, '12).

The transmission in *Renilla* that has just been discussed controls colonial contraction, the general withdrawal of autozooids, and, at night, phosphorescence. If these three activities depend for excitation upon one nerve-net, it might be supposed that, at least when phosphorescence is possible, all three should invariably occur together and that their independent appearance would be impossible. That they are more or less independent is quite certain. At night a slight stimulus may be followed by a momentary phosphorescence and with no other result. A stronger stimulus involves usually not only phosphorescence, but also the withdrawal of the autozooids and, if the stimulus is still stronger, general contraction may follow. It, therefore, appears that though these three activities may be controlled by a single nerve-net, they may exhibit a certain amount of independence, for apparently the intensity of the stimulus determines which particular activity or combination of activities may be called forth. Phosphorescence is excited by the slightest provocation; the withdrawal of the zooids requires a higher degree of activity, and general contraction is produced only by still more vigorous stimulation.

The fact that at night I have never seen general contraction excited without zooid withdrawal and phosphorescence, and that the stimulus to zooid contraction is always productive of phos-

phorescence, but not necessarily of general contraction, supports this view. It is, therefore, quite possible that all three activities are controlled by a single nerve-net and yet possess a certain kind of independence, for apparently the strength of the stimulus may determine which particular activity or group of activities may be made to appear.

#### CONCLUSIONS

The activities of *Renilla*, as given in this and the preceding paper, show very clearly the main outlines of the organization of this animal. Although its development, as worked out by Wilson ('83), gives indisputable evidence of the origin of the colony from a single zoöid and shows that the zoöid is the morphological unit in its composition, its reactions center around the colony as a whole rather than around such units. In this sense the activities of *Renilla* make plausible the belief of many of the older naturalists that this and other sea-pens are individual animals—a view which from the standpoint of morphology has long since been abandoned.

The *Renilla* colony fills itself with sea-water through the lateral siphonozoöids and empties itself through the axial siphonozoöid, processes in which the ordinary polyps, the autozoöids, appear to play almost no part. The movement of the water within the colony is chiefly dependent upon the general musculature and particularly upon the two forms of peristalsis shown by this musculature, peduncular and rachidial. As these peristaltic movements, by which the water within the colony is moved, are strictly colonial and as the water enters the colony and emerges from it through particular classes of zoöids, the expansion and contraction of *Renilla* is a mixed operation, in part zoöidal and in part colonial.

Peduncular peristalsis has for its chief functions the anchoring and burying of the colony and locomotion. These activities are general in character and essentially colonial, not zoöidal. Rachidial peristalsis is the reverse of peduncular peristalsis in that it serves to elevate and expand the colony, but it is like peduncular peristalsis in that it, too, is strictly colonial. In both



forms of peristalsis the waves are so slow, approximately 1.1 to 1.2 mm. per second, that they are much more suggestive of muscular than of nervous activity. And when, as in rachidial peristalsis, the wave movement can be studied in some detail, its diffuse spread, its reversibility, as well as its capacity to originate in any isolated portion of the part concerned, all point to its similarity with the heart-wave in vertebrates. Like this wave, peristalsis in *Renilla* is probably primarily myogenic, but open to a certain degree of control from a nervous mechanism in which, however, the peristaltic movement does not originate. But whatever may be the details of peduncular and rachidial peristalsis in *Renilla*, it is perfectly clear that both forms of movement are purely colonial in character and have no direct relation whatever with the zoöids. Hence the expansion and elevation of *Renilla* and its contraction and withdrawal as well as its locomotion are to be regarded as colonial actions probably of a myogenic origin and surely quite devoid of any zoöidal influence.

If the waves of peduncular and rachidial peristalsis are essentially myogenic, those of phosphorescence have all the appearance of being neurogenic. This is especially striking in their rapidity of transmission, some sixty or sixty-five times that of the peristaltic waves. Apparently they are the product of an unpolarized nerve-net, which serves not only phosphorescence, but also the general contraction of the colony as a whole and the combined withdrawal of the autozoöids. These activities, though they involve the autozoöids, are strictly colonial, for they excite the withdrawal of these zoöids all together and not as individuals and, though they can be readily induced by stimulating almost any part of the surface of the peduncle or the rachis, it is remarkable that they cannot be called forth by stimulating individual autozoöids. Phosphorescence, general contraction, and the withdrawal of the autozoöids, then, are also colonial activities, probably dependent upon a nerve-net and certainly not involving the organization of the zoöid. Such a nervous organization is, as *Panceri* ('71) long ago stated, social rather than individual.

As all these activities show, the *Renilla* colony is much more of a unit than it is an aggregate of parts; its morphological constituents, the zoöids, have merged their individuality in that of the colony. Probably this merger is not so profound as it is in the siphonophores, but is it certainly vastly more so than in such a sponge colony as *Stylorella*, in which the individuals are physiologically quite distinct and apparently only incidentally attached—a state of affairs that is probably reproduced in many of the simple hydrozoan colonies such as *Tubularia* and the like.

Where colonial organization is highly developed, as in *Renilla*, many parts of the colony, like the peduncle, the rachis, and the general nerve-net, take on functions that apply strictly to the colony, and in this sense belong to an order superior to that of the colonial unit, the zoöid. These relations are not without a certain morphological interest. The unit of structure in such a colony as *Renilla* is quite obviously the zoöid. Each zoöid is made up of cells combined into tissues and these into organs. Thus each zoöid exhibits a series of graded relations that are also characteristic of the ordinary metazoan individual. It has long been recognized that most protozoans are unicellular and hence cannot be said in any proper sense to have tissues or organs, for these are always formed by combinations of cells. It is obvious, however, that the single protozoan cell often has special parts that perform particular functions in precisely the same way that the organs of metazoans do. Since these parts cannot be designated as organs, they have been termed organellae. If it is inappropriate to speak of organs in protozoans because this term should be restricted to the multicellular parts of the metazoan individual, it is also inappropriate to use it in reference to a structure in a metazoan colony, even though it may there perform a special function. Thus while it is quite appropriate to designate the tentacle of a zoöid in *Renilla* as an organ, for it is a multicellular functional unit in a single individual, it is not appropriate to speak of the peduncle of *Renilla* as an organ, for this is a structure that serves the whole colony of zoöids. Such structures stand above ordinary organs as organs stand above organellae. They might, therefore, be called superorgans. In

Renilla they are represented not only by the peduncle, but by the rachis, the contained nerve-net, and like parts. Such super-organs give a unity to a colony that would be entirely unexpressed in the individuals of which it is composed.

#### SUMMARY

1. Renilla shows two forms of peristalsis: peduncular, with waves running distally over the peduncle, and rachidial, with waves running in the opposite direction over both peduncle and rachis.

2. In ordinary peduncular peristalsis the waves occurred once every 36 seconds; the time of passage of the waves averaged 27.4 seconds with an average period of rest between waves of 8.6 seconds. The wave progressed over the peduncle at the rate of 1.1 mm. per second.

3. Peduncular waves have been seen on excised peduncles.

4. Peduncular peristalsis is primarily concerned with sinking the peduncle into the sand and thus anchoring the animal. It is also the means of bringing about a complete withdrawal of the animal under the sand and of a certain amount of locomotion. It is secondarily concerned with the distribution of fluid within the animal during distention.

5. In rachidial peristalsis the waves occurred once in about every 130 seconds; the time of passage of the wave averaged about 115 seconds, with an average period of rest between waves of 15 seconds. The waves progressed over the colony at the rate of 1.2 mm. per second.

6. Rachidial waves will pass around any number or variety of incisions in the colony so long as organic continuity is maintained.

7. Separate pieces of Renilla show rachidial waves. When these pieces are from symmetrical regions, they agree in rate; when they are not, the rates are different; the rate is most rapid in the peduncle and least so in that part of the rachis farthest from the peduncle. The peduncle is the pacemaker for the system of rachidial waves.

8. Rachidial waves are temporarily checked by magnesium sulphate.

9. Rachidial peristalsis raises *Renilla* out of the sand and distributes the fluids contained within its body. It is not concerned with effective locomotion.

10. *Renilla* is naturally highly phosphorescent at night but not so by day. At night its phosphorescence can be reduced by exposing it to light and by day this can be developed by putting it in the dark.

11. *Renilla* is excited to phosphoresce only by stimulation, particularly by applying mechanical or electrical stimuli. Concentric waves of phosphorescence emanate from the spot stimulated.

12. Phosphorescence is limited to the upper surface of the rachis of *Renilla* and is produced by the masses of whitish material that surround the siphonozooids and the bases of the autozooids.

13. The waves of phosphorescence pass around any form of incision made on the rachis.

14. The impulses for phosphorescence are transmitted by the non-phosphorescing peduncle as well as by the phosphorescing rachis.

15. The impulses for phosphorescence are temporarily interrupted by magnesium sulphate. At 21°C. they have a rate of about 7.4 cm. per second. Between 10° and 25°C. this rate doubles for each increment of 10°. At 31°C. it is more than double that at 21°C.

16. The autozooids of *Renilla* are stimulated with difficulty mechanically, with ease electrically. They are not centers from which impulses pass freely to the rest of the colony, though they are easily entered by impulses from other parts of the colony.

17. Their general withdrawal, due to stimulation of peduncle or rachis, spreads over the colony in a wave which may be temporarily interrupted by magnesium sulphate and which has a rate of 7.8 cm. per second.

18. Peduncular peristalsis and rachidial peristalsis consist of muscular waves whose rhythm is probably myogenic in origin. Phosphorescence, the withdrawal of autozooids, and general con-

tractions are called forth by impulses, often wave-like in character and probably neurogenic in origin (nerve-net).

19. The activities of *Renilla* are colonial in scope rather than zoöidal; the zoöid as a unit is dominated by the colony.

## LITERATURE

- AGASSIZ, L. 1850 On the structure of the Halcyonoid polypi. *Proceed. Amer. Assoc. Adv. Sci.*, vol. 3, pp. 207-213.
- DAHLGREN, U. 1916 The production of light by animals. *Porifera and Coelenterates. Jour. Franklin Inst., Philadelphia*, vol. 181, pp. 243-261.
- EISEN, G. 1876 *Beidrag till Kännedomen om Pennatulidsläktet Renilla Lamk. Kongl. Svenska Vet.-Akad. Handlingar, ny följd*, bd. 30, pp. 1-15.
- HARVEY, E. N. 1912 The permeability of living cells for alkalies. The question of nerve fatigue. *Carnegie Instn. Washington, Year Book no. 10*, pp. 130-131.
- MANGOLD, E. 1910-1914 *Die Produktion von Licht. Winterstein; Handb. vergl. Physiol.*, Bd. 3, Hälfte 2, S. 225-392.
- MÜLLER, F. 1864 Ein Wort über die Gattung *Herklotsia* J. E. Gray, *Arch. Naturg.*, Jahrg. 30, Bd. 1, S. 352-358.
- MUSGRAVE, E. M. 1909 Experimental observations on the organs of circulation and the powers of locomotion in pennatulids. *Quart. Jour. Micr. Sci.*, new ser., vol. 54, pp. 443-481.
- PANCERI, P. 1871 Gli organi luminosi e la luce delle pennatule. *Atti Accad. Sci., Napoli*, T. 5, no. 10, 46 pp.
- PARKER, G. H. 1918 The rate of transmission in the nerve net of the coelenterates. *Jour. Gen. Physiol.*, vol. 1, pp. 231-236.
- 1919 The organization of *Renilla*. *Jour. Exp. Zoöl.*, vol. 27, pp. 499-507.
- 1920 Activities of colonial animals. 1. Circulation of water in *Renilla*. *Jour. Exp. Zoöl.*, vol. 31, pp. 343-368.
- PARKER, G. H., AND A. P. VAN HEUSEN. 1917 The responses of the catfish, *Amiurus nebulosus*, to metallic and nonmetallic rods. *Amer. Jour. Physiol.*, vol. 44, pp. 405-420.
- PETERS, A. W. 1905 Phosphorescence in ctenophores. *Jour. Exp. Zoöl.*, vol. 2, pp. 103-116.
- ROMANES, G. J. 1878 Further observations on the locomotor system of the Medusae. *Philos. Trans. Roy. Soc., London*, vol. 147, pp. 659-752.
- VERRILL, A. E. 1864 Revision of the Polypi of the eastern coast of the United States. *Mem. Boston, Soc. Nat. Hist.*, vol. 1, pp. 1-45.
- WILSON, E. B. 1883 The development of *Renilla*. *Philos. Trans., Roy. Soc., London*, vol. 174, pp. 723-815.

## PLATE 1

### EXPLANATION OF FIGURES

All figures represent *Renilla amethystina* Verrill.

1 to 4 Successive phases of the waves of peduncular peristalsis; figure 1, the beginning; figure 2, later stage; figure 3, nearly completed; figure 4, completed.

5 to 8 Successive phases of the wave of rachidial peristalsis.

5 Colony seen from the inferior side with the peduncle elevated and out of focus. The rachidial wave has just started from the peduncle and appears as a pair of indentations on the lobes of the rachis next the peduncle.

6 A later phase of the rachidial wave in which the indentations have reached the midrachis; view of the inferior surface of the colony.

7 Rachidial wave in about the same phase as that seen in figure 6, but viewed from the superior surface.

8 Rachidial wave as a pair of indentations approaching the apical margin, where the indentations will fuse and the wave cease.



5

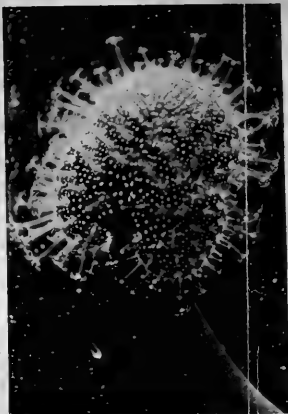

7

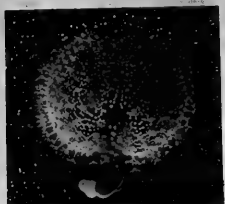

2

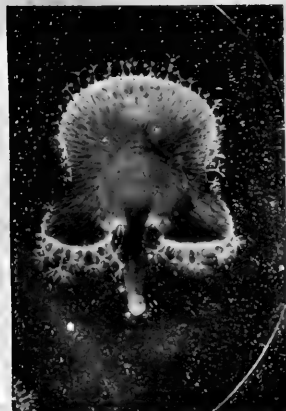

6



8

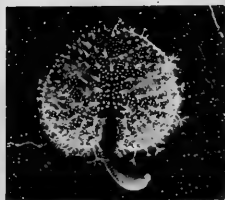

3



4





## SUBJECT AND AUTHOR INDEX

<b>A</b> CTIVITIES of colonial animals. I. Circulation of water in <i>Renilla</i> .....	343
Activities of colonial animals. II. Neuromuscular movements and phosphorescence in <i>Renilla</i> .....	475
<b>ADOLPH, EDWARD F.</b> Egg-laying reactions in the pomace fly, <i>Drosophila</i> .....	327
<b>Amblystoma.</b> The formation of nerve plexuses and the function of the limbs. Experiments on the transplantation of limbs in.....	117
<b>Amiurus nebulosus (Lesueur).</b> The results of cutting the seventh cranial nerve in.....	369
<b>Animals. I.</b> Circulation of water in <i>Renilla</i> . Activities of colonial.....	343
<b>Animals. II.</b> Neuromuscular movements and phosphorescence in <i>Renilla</i> . Activities of colonial.....	475
<b>Arms of the cephalopods.</b> On the regeneration and finer structure of the.....	1
<b>B</b> EROË cucumis. Experimental studies on primary inhibition of the ciliary movement in.....	403
<b>BISHOP, GEORGE H.</b> Fertilization in the honey-bee. I. The male sexual organs: their histological structure and physiological functioning.....	225
<b>BISHOP, GEORGE H.</b> Fertilization in the honey-bee. II. Disposal of the sexual fluids in the organs of the female.....	267
<b>C</b> ALKINS, GARY N. <i>Uroleptus mobilis</i> Engelm. III. A study in vitality.....	287
<b>Cephalopods.</b> On the regeneration and finer structure of the arms of the.....	1
<b>Ciliary movement in Beroë cucumis.</b> Experimental studies on primary inhibition of the.....	403
<b>Circulation of water in Renilla.</b> Activities of colonial animals. I.....	343
<b>Colonial animals. I.</b> Circulation of water in <i>Renilla</i> . Activities of.....	343
<b>Colonial animals. II.</b> Neuromuscular movements and phosphorescence in <i>Renilla</i> . Activities of.....	475
<b>Cranial nerve in Amiurus nebulosus (Lesueur).</b> The results of cutting the seventh.....	369
<b>Cytolysins. II.</b> Transmission of induced eye defects. Studies on.....	171
<b>D</b> EFFECTS. Studies on cytolysins. II. Transmission of induced eye.....	171
<b>DETWILER, S. R.</b> Experiments on the transplantation of limbs in <i>Amblystoma</i> . The formation of nerve plexuses and the function of the limbs.....	117
<b>Drosophila and their bearing on the manner of occurrence of mutation.</b> Further changes in the white-eye series of.....	443
<b>Drosophila.</b> Egg-laying reactions in the pomace fly.....	327
<b>E</b> GG-LAYING reactions in the pomace fly, <i>Drosophila</i> .....	327
<b>ENGELM. III.</b> A study in vitality. <i>Uroleptus mobilis</i> .....	287
Eye defects. Studies on cytolysins. II. Transmission of induced.....	171
<b>Eyes.</b> Reactions to light in <i>Planaria maculata</i> , with special reference to the function and structure of the.....	59
<b>F</b> EMALE. Fertilization in the honey-bee. II. Disposal of the sexual fluids in the organs of the.....	267
<b>Fertilization in the honey-bee. I.</b> The male sexual organs: their histological structure and physiological functioning.....	225
<b>Fertilization in the honey-bee. II.</b> Disposal of the sexual fluids in the organs of the female.....	267
<b>Fluids in the organs of the female.</b> Fertilization in the honey-bee. II. Disposal of the sexual.....	267
<b>Fly, Drosophila.</b> Egg-laying reactions in the pomace.....	327
<b>Function and structure of the eyes.</b> Reactions to light in <i>Planaria maculata</i> , with special reference to the.....	59
<b>Functioning.</b> Fertilization in the honey-bee. I. The male sexual organs: their histological structure and physiological.....	225
<b>G</b> OTHLIN, GUSTAF FR. Experimental studies on primary inhibition of the ciliary movement in <i>Beroë cucumis</i> ...	403
<b>Growth of a transplantable tumor in mice.</b> Factors influencing the.....	307
<b>GUYER, M. F., and SMITH, E. A.</b> Studies on cytolysins. II. Transmission of induced eye defects.....	171
<b>H</b> ONEY-BEE. I. The male sexual organs: their histological structure and physiological functioning. Fertilization in the.....	225
<b>Honey-bee. II.</b> Disposal of the sexual fluids in the organs of the female. Fertilization in the.....	267
<b>I</b> NHIBITION of the ciliary movement in <i>Beroë cucumis</i> . Experimental studies on primary.....	403
<b>L</b> ANGE, MATHILDE M. On the regeneration and finer structure of the arms of the cephalopods.....	1
<b>Limbs in Amblystoma.</b> The formation of nerve plexuses and the function of the limbs. Experiments on the transplantation of.....	117
<b>LITTLE, C. C.</b> Factors influencing the growth of a transplantable tumor in mice.....	307
<b>M</b> ACULATA, with special reference to the function and structure of the eyes. Reactions to light in <i>Planaria</i> .....	59
<b>Male sexual organs: their histological structure and physiological functioning.</b> Fertilization in the honey-bee. I. The.....	225
<b>Mice.</b> Factors influencing the growth of a transplantable tumor in.....	307
<b>Mobilis Engelm. III.</b> A study in vitality. <i>Uroleptus</i> .....	287

- Movements and phosphorescence in *Renilla*. Activities of colonial animals. II. Neuromuscular. . . . . 475
- Movement in *Beroë cucumis*. Experimental studies on primary inhibition of the ciliary . . . . . 403
- MULLER, H. J. Further changes in the white-eye series of *Drosophila* and their bearing on the manner of occurrence of mutation . . . . . 443
- Mutation. Further changes in the white-eye series of *Drosophila* and their bearing on the manner of occurrence of . . . . . 443
- N**EBULOSUS (Lesueur). The results of cutting the seventh cranial nerve in *Amiurus*. . . . . 369
- Nerve in *Amiurus nebulosus* (Lesueur). The results of cutting the seventh cranial. . . . . 369
- Nerve plexuses and the function of the limbs. Experiments on the transplantation of limbs in *Amblystoma*. The formation of . . . . . 117
- Neuromuscular movements and phosphorescence in *Renilla*. Activities of colonial animals. II. . . . . 475
- O**LMSTED, J. M. D. The results of cutting the seventh cranial nerve in *Amiurus nebulosus* (Lesueur). . . . . 369
- Organs: their histological structure and physiological functioning. Fertilization in the honey-bee. I. The male sexual. . . . . 225
- P**ARKER, G. H. Activities of colonial animals. I. Circulation of water in *Renilla*. . . . . 343
- PARKER, G. H. Activities of colonial animals. II. Neuromuscular movements and phosphorescence in *Renilla*. Activities of colonial animals. II. Neuromuscular movements and . . . . . 475
- Phosphorescence in *Renilla*. Activities of colonial animals. II. Neuromuscular movements and . . . . . 475
- Planaria maculata*, with special reference to the function and structure of the eyes. Reactions to light in. . . . . 59
- Plexuses and the function of the limbs. Experiments on the transplantation of limbs in *Amblystoma*. The formation of nerve . . . . . 117
- Pomace fly, *Drosophila*. Egg-laying reactions in the . . . . . 327
- R**EACTIONS in the pomace fly, *Drosophila*. Egg-laying. . . . . 327
- Reactions to light in *Planaria maculata*, with special reference to the function and structure of the eyes. . . . . 59
- Regeneration and finer structure of the arms of the cephalopods. On the . . . . . 1
- Renilla*. Activities of colonial animals. I. Circulation of water in. . . . . 343
- Renilla*. Activities of colonial animals. II. Neuromuscular movements and phosphorescence in. . . . . 475
- S**EVENTH cranial nerve in *Amiurus nebulosus* (Lesueur). The results of cutting the . . . . . 369
- Sexual fluids in the organs of the female. Fertilization in the honey-bee. II. Disposal of the . . . . . 267
- Sexual organs: their histological structure and physiological functioning. Fertilization in the honey-bee. I. The male . . . . . 225
- SMITH, E. A., GUYER, M. F., AND. Studies on cytolytins. II. Transmission of induced eye defects. . . . . 171
- Structure and physiological functioning. Fertilization in the honey-bee. I. The male sexual organs: their histological . . . . . 225
- Structure of the arms of the cephalopods. On the regeneration and finer . . . . . 1
- Structure of the eyes. Reactions to light in *Planaria maculata*, with special reference to the function and . . . . . 59
- T**ALIAFERRO, W. H. Reactions to light in *Planaria maculata*, with special reference to the function and structure of the eyes. . . . . 59
- Transmission of induced eye defects. Studies on cytolytins. II. . . . . 171
- Transplantable tumor in mice. Factors influencing the growth of a . . . . . 307
- Transplantation of limbs in *Amblystoma*. The formation of nerve plexuses and the function of the limbs. Experiments on the . . . . . 117
- Tumor in mice. Factors influencing the growth of a transplantable. . . . . 307
- U**ROLEPTUS *mobilis* Engelm. III. A study in vitality . . . . . 287
- V**ITALITY. *Uroleptus mobilis* Engelm. III. A study in . . . . . 287
- W**HITE-EYE series of *Drosophila* and their bearing on the manner of occurrence of mutation. Further changes in the . . . . . 443

