



JOURNAL OF GENETICS

CAMBRIDGE UNIVERSITY PRESS

C. F. CLAY, MANAGER

London: FETTER LANE, E.C.

Edinburgh: 100 PRINCES STREET



London: H. K. LEWIS, 136, GOWER STREET, W.C.

London: WILLIAM WESLEY & SON, 28, ESSEX STREET, STRAND

Berlin: A. ASHER AND CO.

Leipzig: F. A. BROCKHAUS

Chicago: THE UNIVERSITY OF CHICAGO PRESS

Bombay and Calcutta: MACMILLAN AND CO., LTD.

Toronto: J. M. DENT AND SONS, LTD.

Tokyo: THE MARUZEN-KABUSHIKI-KAISHA

All rights reserved

JOURNAL OF GENETICS

EDITED BY

W. BATESON, M.A., F.R.S.

DIRECTOR OF THE JOHN INNES HORTICULTURAL INSTITUTION

AND

R. C. PUNNETT, M.A., F.R.S.

ARTHUR BALFOUR PROFESSOR OF GENETICS IN THE UNIVERSITY OF CAMBRIDGE

Volume III. 1913-1914



168863.
27/1/22

Cambridge :
at the University Press

1914

Cambridge:

PRINTED BY JOHN CLAY, M.A.

AT THE UNIVERSITY PRESS

QH
431
A1J64
v. 3
cop. 2

CONTENTS.

No. 1 (June, 1913)

	PAGE
L. DONCASTER. On an Inherited Tendency to produce purely Female Families in <i>Abraaxas grossulariata</i> , and its Relation to an Abnormal Chromosome Number	1
L. DONCASTER. On Sex-limited Inheritance in Cats, and its bearing on the Sex-limited Transmission of certain Human Abnormalities	11
H. H. NEWMAN. Five Generations of Congenital Stationary Night-Blindness in an American Family. (With 2 Text-Figures)	25
GEOFFREY SMITH and MRS HAIG THOMAS. On Sterile and Hybrid Pheasants. (With Plate I)	39
N. BARLOW. Preliminary Note on Heterostylism in <i>Oxalis</i> and <i>Lythrum</i> . (With 1 Text-Figure)	53
PHILIPPE DE VILMORIN. Sur une Race de Blé Nain Infixable. (With Plate II, and 8 Text-Figures)	67

No. 2 (September, 1913)

R. C. PUNNETT. Reduplication Series in Sweet Peas	77
CAROLINE PELLEW. Note on Gametic Reduplication in <i>Pisum</i>	105
J. C. F. FRYER. Preliminary Note on some Experiments with a Polymorphic Plasmid. (With Plate III).	107
EDWARD N. WENTWORTH. The Segregation of Fecundity Factors in <i>Drosophila</i>	113
J. A. JENKINS. Mendelian Sex-Factors in Man	121
CHARLES TODD. On the Recognition of the Individual by Haemolytic Methods	123
C. J. BOND. Some Points of Genetic Interest in Regeneration of the Testis after Experimental Orchestomy in Birds. (With Plates IV and V)	131

No. 3 (February, 1914)

	PAGE
ROBERT K. NABOURS. Studies of Inheritance and Evolution in Orthoptera I. (With Plate VI, 3 Text-Figures, and 2 Diagrams)	141
C. W. RICHARDSON. A Preliminary Note on the Genetics of <i>Fragaria</i> . (With Plate VII and 4 Text-Figures)	171
W. E. AGAR. Parthenogenetic and Sexual Reproduction in <i>Simoccephalus vetulus</i> and other Cladocera	179
E. S. SALMON. On the Appearance of Sterile "Dwarfs" in <i>Humulus Lupulus</i> L. (With Plates VIII and IX)	195
I. B. J. SOLLAS. Note on the Offspring of a Dwarf-bearing Strain of Guinea Pigs.	201
C. J. BOND. On a Case of Unilateral Development of Secondary Male Characters in a Pheasant, with Remarks on the Influence of Hormones in the Production of Secondary Sex Characters. (With Plates X—XIII)	205
H. DRINKWATER. Minor-Brachydactyly. No. 2. (With Plates XIV—XVI and 1 Chart)	217
P. G. BAILEY. Primary and Secondary Reduplication Series. (With 1 Text-Figure)	221

No. 4 (April, 1914)

J. W. H. HARRISON and L. DONCASTER. On Hybrids between Moths of the Geometrid Sub-Family <i>Bistoninae</i> , with an Account of the Behaviour of the Chromosomes in Gametogenesis in <i>Lycia (Biston) Hirtaria</i> , <i>Ithysia (Nyssia) Zonaria</i> and in their Hybrids. (With Plates XVII and XVIII)	229
ONERA A. MERRITT HAWKES. On the Relative Lengths of the First and Second Toes of the Human Foot, from the Point of View of Occurrence, Anatomy and Heredity. (With Plates XIX—XXI and 6 Text-Figures)	249
ROSE HAIG THOMAS. The Transmission of Secondary Sexual Characters in Pheasants. (With Plates XXII—XXVI and 2 Text-Figures).	275
W. BOWATER. Heredity of Melanism in Lepidoptera. (With Plate XXVII)	299

ON AN INHERITED TENDENCY TO PRODUCE
PURELY FEMALE FAMILIES IN *ABRAXAS*
GROSSULARIATA, AND ITS RELATION TO
AN ABNORMAL CHROMOSOME NUMBER.

By L. DONCASTER, M.A.,

Fellow of King's College, Cambridge.

I. *The Inheritance of Unisexual families.*

IT is well-known that in Lepidoptera, families are occasionally produced which are all or nearly all of one sex. This has sometimes been observed as the result of hybridizing distinct species (e.g. Tutt, *Trans. Entom. Soc.* 1898, p. 17. Three matings of *Tephrosia bistortata* ♀ × *T. crepuscularia* ♂ gave 40 ♂, 0 ♀; 58 ♂, 0 ♀; 60 ♂, 1 ♀), but not rarely families consisting wholly of males or of females have been recorded when both parents have been apparently normal members of the same species (cf. Lamborn's experiments with *Acraea encedon* (*Proc. Entom. Soc.* 1911, p. liv) referred to below).

In 1908 I received from the Rev. G. H. Raynor a batch of larvae of *Abraxas grossulariata*, obtained by mating a wild female with a *lacticolor* male (No. '07.19¹). From these I reared 19 moths, all *lacticolor* females, and heard from Mr Raynor that from the same family he had bred 21 *lacticolor* females, making 40 in all. Of my females I paired four, one with a *lacticolor* male, three with *grossulariata* males all of which were heterozygous for *lacticolor*. The pairing with a *lacticolor* male ('08.2) gave 27 *lacticolor* females and no males; from one of the other pairings no imagos were reared; the remaining two gave respectively 40 ♂, 23 ♀, and 5 ♂, 2 ♀. Of the 27 females in family '08.2 I paired six, three with *lacticolor* males, three with *grossulariata* males.

¹ The reference numbers of purely female families are italicised.

Of these males, one (mating '09. 12) proved to be homozygous for *grossulariata*, a second heterozygous ('09. 7), and from the third no imagoes were reared. From the two successful matings with *grossulariata* males, the results were 52 ♂, 25 ♀ and 42 ♂, 25 ♀. The matings with *lacticolor* males were '09. 8, which yielded 11 ♂, 15 ♀; '09. 15, one female only; and '09. 18 with 11 females. The single female from '09. 15 was paired with a *lacticolor* male from '09. 7, but laid no eggs; of the eleven females from '09. 18 all were paired, but three produced hardly any eggs and no larvae (two of the males used in these infertile matings were *lacticolor* from '09. 8, the third a *grossulariata* from '09. 12, i.e. all were sons of females of the unisexual family '08. 2). Of the eight fertile pairings, two ('10. 21, '10. 24) were with *lacticolor* males; the male of '10. 21 was unrelated and from 80 eggs 24 females were reared, with no males; the male of '10. 24 was from '09. 7 (son of '08. 2) and from 100 eggs were reared 22 ♂, 25 ♀. Of the six fertile pairings with *grossulariata* males, one ('10. 19) was with a wild male and gave from about 75 eggs 25 ♂, 20 ♀; two were with homozygous *gross.* (unrelated) males and gave from 56 and 80 eggs 21 ♂, 23 ♀ and 4 ♂, 5 ♀ ('10. 25 and '10. 27). The other three were with heterozygous *gross.* males; in one ('10. 15), in which the male was unrelated, 32 ♂ and 27 ♀ were produced; the other two, '10. 22 and '10. 28, in which the male in each case was from '09. 12 (sons of '08. 2), produced from 19 and 91 eggs, 4 ♀ (3 *gross.* 1 *lact.*) and 62 ♀ (34 *gross.* 28 *lact.*). In these last matings, purely female families including *grossulariata* as well as *lacticolor* were produced for the first time.

Another important point arose from the 1910 matings. A *lact.* female of '09. 8 (a bisexual family, whose mother belonged to the unisexual family '08. 2) was paired with an unrelated *lact.* ♂, and produced 69 ♀, 4 ♂ ('10. 17), and in another family ('10. 10) descended on both sides more or less nearly from unisexual families (see Table of Matings) 14 ♀ and 2 ♂ were produced. The 1910 pairings showed therefore (1) that there is apparently some tendency to infertility among females of unisexual families, at least when mated with related males; (2) that unisexual families including *grossulariata* individuals can be produced; and (3) families with enormous preponderance of females were reared from parents which belonged to normal broods themselves, when one or both were descended from unisexual families.

It is not necessary to describe in detail the matings made in 1911; the results of those which are important for the present purpose are given in the table. It will be seen that of twelve matings with females

from the unisexual family '10.28, three ('11.15, '11.19, '11.26) gave only female offspring, and that of these families one was by a wild male, the other two by males unrelated to the female. Half the matings of females from '10.28 were nearly or totally infertile, in two cases ('11.27 and '11.29) when the male was unrelated to the female. Similar infertility was found in two of the three matings of females from '10.21, and in four matings (not included in the table) of females from '10.10 and '10.17 (families in which there was a great preponderance of females).

A fresh point of importance also appeared. In three matings ('11.25, '11.9 and '11.4) of which the female parent in each case was daughter of a female from '09.18, and the male in two cases a son of a female from '09.18, and in the third a member of the preponderatingly female family '10.17, only females were produced, although both parents were themselves members of bisexual families.

It is clear, therefore, not only that the tendency to produce purely female families may be transmitted direct from mother to daughter, even when the male parent is unrelated, but also that females of bisexual families directly descended from unisexual families may produce only female offspring, at least when mated with males of similar origin. Further, of the females of unisexual families, about half have only female offspring, and the remainder have offspring of both sexes.

Several points of importance remain to be determined, and it is to be hoped that the results of the pairings made in 1912 will clear them up. The more important are (1) whether females of bisexual families, whose mothers belong to unisexual families, can have only female offspring when mated with unrelated males; (2) how the families with great preponderance of females are related to the completely unisexual broods; and (3) whether mortality in the egg or larval stages has any relation to the production of only female offspring. Experiments to test all these points are in progress. It was hoped that the third would be settled by the 1911 matings, but the exceptionally hot dry weather at the time of hatching caused great mortality in the very early stages. Although in some cases a large proportion of the eggs failed to develop, in other batches from which only females were produced almost every egg hatched, and the case of '10.28, in which 62 females were reared from 91 eggs, strongly suggests that the production of only female offspring is not due to the dying off of the male larvae. Further evidence in the same direction is provided by the preliminary account of the chromosomes in unisexual broods which follows. Another

Female Families in *Abraxas*

TABLE OF MATINGS.

(Reference numbers of purely female families are italicized.)

Reference Number	Female Parent	Male Parent	N ^o of Eggs	Imagos				Total Females	Total Males	Notes
				Gross. Males	Lact. Males	Gross. Females	Lact. Females			
'07.19	wild	lact. ex. '06.28 R	—	—	—	—	40	—	40	
'08.2	lact. ex. '07.19	lact. ex. '07.4	—	—	—	—	27	—	27	
'08.4	"	gross. ex. '07.4	—	25	15	14	9	40	23	
'08.6	"	gross. ex. '07.3	—	3	2	2	—	5	2	
'08.13	"	gross. ex. '07.12	infertile	—	—	—	—	—	—	All male parents unrelated to females
'09.12	lact. ex. '08.2	gross. ex. '08.8	—	52	—	25	—	52	25	
'09.7	"	gross. ex. '08.3	—	21	21	10	15	42	25	
'09.17	"	gross. ex. '08.12	infertile	—	—	—	—	—	—	
'09.8	"	lact. ex. '08.4	—	—	11	—	15	11	15	All male parents unrelated to females
'09.15	"	"	—	—	—	—	1	—	1	
'09.18	"	lact. ex. '08.5	—	—	—	—	11	—	11	
'09.10	gross. ex. '08.3	lact. ex. '08.6	—	24	—	—	29	24	29	Female parent with no unisexual ancestry; male descended from '07.19
'10.30	lact. ex. '09.15	lact. ex. '09.7	0	—	—	—	—	—	—	
'10.20	lact. ex. '09.18	gross. ex. '09.12	4	—	—	—	—	—	—	
'10.23	"	lact. ex. '09.8	12	—	—	—	—	—	—	Infertile; male in each case son of ♀ ex. '08.2
'10.26	"	"	5	—	—	—	—	—	—	
'10.21	"	lact. ex. '09.1	80	—	—	—	24	—	24	Male unrelated
'10.24	"	lact. ex. '09.7	100	—	22	—	25	22	25	Male son of ♀ ex. '08.2
'10.19	"	wild	75	25	—	20	—	25	20	
'10.25	"	gross. ex. '09.3	56	21	—	23	—	21	23	Males unrelated to females
'10.27	"	"	80	4	—	5	—	4	5	
'10.15	"	gross. ex. '09.19	—	17	15	12	15	32	27	
'10.22	"	gross. ex. '09.12	19	—	—	3	1	—	4	
'10.28	"	"	91	—	—	34	28	—	62	Males sons of ♀ ex. '08.2
'10.17	lact. ex. '09.8	lact. ex. '09.1	—	4	—	—	.69	4	69	Female parent daughter of ♀ ex. '08.2; male with no unisexual ancestry
'10.10	lact. ex. '09.10	lact. ex. '09.8	—	2	—	—	14	2	14	Male son of ♀ ex. '08.2; female descended through her father from '07.19

TABLE OF MATINGS (continued).

(Reference numbers of purely female families are italicised.)

Reference Number	Female Parent	Male Parent	Number of Eggs	Imagoes				Total Females	Total Males	Total Females	Notes
				Gross. Males	Lact. Males	Gross. Females	Lact. Females				
'11.8	gross. ex. '10.28	lact. ex. '10.24	36	—	—	—	1	—	1	Male son of ♀ ex. '09.18; half the eggs infertile	
'11.15	"	gross. ex. '10.7	59	—	—	23	—	—	23	Male unrelated to females	
'11.19	lact.	lact. ex. '10.18	23	—	1?	—	7	1?	7	"	
'11.26	"	wild	87	—	—	39	—	—	39	"	
'11.28	gross.	gross. ex. '10.7	33	11	—	17	—	11	17	"	
'11.30	"	lact. ex. '10.24	76	23	—	—	20	23	20	Male son of ♀ ex. '09.18	
'11.22	"	gross. ex. '10.15	16	—	—	—	—	—	—	Only one egg hatched	
'11.23	lact.	lact. ex. '10.15	27	—	—	—	—	—	—	No eggs developed	
'11.23A	"	"	14	—	—	—	—	—	—	"	
'11.27	gross.	lact. ex. '10.18	21	—	—	—	—	—	—	Only one egg developed; male distantly related	
'11.29	lact.	gross. ex. '10.11	15	—	—	—	—	—	—	No eggs developed; male unrelated	
'11.31	"	gross. ex. '10.15	0	—	—	—	—	—	—	No eggs laid	
'11.14	lact. ex. '10.21	gross. ex. '10.27	185	7	11	19	14	18	33	Male son of ♀ ex. '09.18	
'11.10	"	gross. ex. '10.25	48	—	—	—	—	—	—	Only 5 eggs developed	
'11.18	"	lact. ex. '10.24	36	—	—	—	—	—	—	No eggs developed	
'11.25	gross. ex. '10.19	gross. ex. '10.15	100	—	—	6	3	—	9	In '11.25 46 eggs did not develop. Both parents children of ♀ s ex. '09.18, but themselves belonged to bisexual families	
'11.9	gross. ex. '10.15	lact. ex. '10.24	84	—	—	—	15	—	15	♀ parent daughter of ♀ ex. '09.18 ♂ ex. '10.17 (family of 69 ♀, 4 ♂)	
'11.4	gross. ex. '10.25	lact. ex. '10.17	45	—	—	—	18	—	18		
'11.1	lact. ex. '10.17	gross. ex. '10.25	74	5	7	4	3	12	7		
'11.3	"	wild	100	19	—	15	—	19	15		
'11.12	"	lact. ex. '10.24	39	—	4	—	5	4	5	Only 13 eggs developed	
'11.24A	"	"	132	—	27	—	27	27	27		
'11.6	lact. ex. '10.10	lact. ex. '10.17	68	—	7	—	16	7	16		
'11.11	"	gross. ex. '10.19	75	6	4	8	12	10	20		
'11.13	"	wild	129	7	11	19	14	18	33		

point of interest should be noticed—that in the unisexual families the ordinary rules of sex-limited transmission are followed. A *grossulariata* female, mated with a *lacticolor* male, normally produces *lacticolor* female and *grossulariata* male offspring; if the family consists entirely of females, these are all *lacticolor*, and the *grossulariata* character is not transmitted at all (cf. families '07. 19, '11. 9 and '11. 4).

It has been mentioned that a considerable proportion of matings of females from unisexual families, especially when the male is related, are infertile. In 1912 I dissected most of the females paired, after the eggs were laid, in order to see whether the ovaries were in any case abnormal. Although in three cases I have found ovaries containing no oocytes in larvae dissected for histological examination, I found no abnormal ovaries, with the exception of one which had six egg-tubes instead of four, in the moths which had been paired. In several cases, however, in which the eggs were infertile I found that the spermatheca was nearly or quite empty, showing that copulation had not been successful, but this cannot be the sole cause of the infertility, for in other cases in which the eggs failed to develop the spermatheca was well filled.

Before passing on to the account of the cytology of the unisexual families, it should be mentioned that my case of a hereditary tendency to produce families consisting of females only appears to be closely comparable with that discovered by Dr Lamborn in *Acraea encedon*, of which a preliminary account has been published (*Proc. Entom. Soc.* 1911, p. liv). I hear from Prof. Poulton that so far as the experiments have gone at present, females from purely female families always have only female offspring; those from bisexual families have both males and females. If this is confirmed, it will show that the two cases are not exactly similar.

II. *The Chromosomes in Unisexual families.*

In recent papers¹ I have shown that the unreduced number of chromosomes in both male and female of *Abraxas grossulariata* is normally 56, and that there is no recognisable difference between the type and *var. lacticolor*. In determining the chromosome number in the oogonia of certain *lacticolor* females, however, I found several perfectly clear figures in which only 55 could be counted, although in

¹ *Journal of Genetics*, I, 1911, p. 179, and II, 1912, p. 189.

other *lacticolor* females there were 56. The females in which I first found 55 belonged to a family descended from unisexual stock, and it occurred to me that possibly the absence of one chromosome might be correlated with the tendency to produce only female offspring. In the autumn of 1912, therefore, I dissected all the larvae which attained a sufficient size, and preserved the ovaries and testes¹. The sexes are quite easily recognisable on dissection when the larvae are less than half-grown, and the oogonial and spermatogonial divisions are more numerous and clearer at that stage than later. In male larvae spermatocyte divisions occur from about half-grown larvae onwards. The methods used were the same as those described in my former papers; in counting chromosomes every figure has been drawn twice, at intervals of a day or usually more, in order to get independent confirmation of each count.

Of the families obtained from females of unisexual broods only two provided any considerable number of larvae which grew to a sufficient size, '12. 8, from a *gross.* ♀ ex. '11. 26 × *gross.* ♂ ex. '11. 11, and '12. 25, from *gross.* ♀ ex. '11. 15 × *lact.* ♂ ex. '11. 14. From '12. 8, 33 larvae were dissected, every one a female; from '12. 25, 14 were dissected, 10 ♂, 4 ♀. Several other families yielded from two to six larvae, some of which will be referred to below. Since in normal families the larvae which feed up in the autumn are much more often males than females, it may be taken as highly probable that '12. 8 is a unisexual family; where only six or fewer females were dissected, it is possible that some males will appear later.

Of the 33 larvae (all females) of '12. 8 which were dissected and their ovaries fixed, only 14 provided figures of oogonial divisions which could be counted with any accuracy. Of these, nine provided altogether eighteen figures in which 55 chromosomes could be counted with almost complete confidence, and of these two or three especially are so perfectly clear that no doubt about the number is possible. In a number of other figures in these ovaries 55 is the most probable number, but in counting chromosomes, when their number is large, a few really trustworthy figures are worth much more than many rather doubtful ones. In addition, out of the fourteen larvae which yielded good or fair figures, two showed four figures in which only 54 can be seen (none of them first-class figures), and three showed four figures in which no

¹ The majority of *grossulariata* larvae cease feeding when quite small in the late summer, and hibernate at that stage. A small and varying number feed up and pupate in the autumn. All the latter were dissected, usually when about half-grown.

decision between the numbers 55 or 56 was possible. In one of the latter, however, several figures gave 55 and only one 56, and from a slight difference in staining there is reason for believing that one of the bodies counted as a chromosome among the 56 is really an extra-nuclear body at the edge of the chromosome group. Among the offspring of pairing '12. 8, therefore, we have over 20 figures in which the number 55 is certainly or almost certainly correct, four in which only 54 can be seen, and none in which there is conclusive evidence of as many as 56. The number 55 is also the most probable in several of the ovaries in which the figures are not sufficiently clear to be used as evidence.

Two other families, '12. 1 and '12. 32, provided sufficient larvae to give considerable probability that they will turn out exclusively female. Both are from females belonging to unisexual families; '12. 1 from *lact.* ♀ ex. '11. 4 × *lact.* ♂ ex. '11. 6, and '12. 32 from *lact.* ♀ ex. '11. 9 × wild ♂. Of '12. 1, four larvae were dissected, all females; two provided ovaries with three countable figures, all with 55. In '12. 32, six larvae were dissected, again all females; four of these show good or fair figures, two figures with 55 clearly, and four others with 55 probably. In the three families, therefore, there are about thirty good equatorial plates showing 55 chromosomes, and only eight in which 55 or 56 might be counted with equal probability.

In only one other family the mother of which belonged to a unisexual brood have any definite results been obtained up to the present time. Family '12. 25, from *gross.* ♀ ex. '11. 15 × *lact.* ♂ ex. '11. 14, has given ten male and four female larvae. One of the females provides an equatorial plate with 56 chromosomes shown quite clearly; two others probably have 56 and one probably 55 but possibly 56. In the case, therefore, of bisexual families of which the mother belongs to a unisexual family it is clear that some at least of the females have 56 chromosomes, but it is probable that others have 55.

The testes of a number of males from families of which the mother belonged to a unisexual family have been examined, chiefly from '12. 25 and '12. 21 B (the mother of the latter was *gross.* ♀ ex. '11. 26, the father *lact.* ♂ ex. '11. 24 A). The chromosomes in spermatogonial divisions are less easy to count than in the oogonial, but most of the really clear cases have given 56, and both primary and secondary spermatocytes have 28. As far as the work has gone at present, therefore, there is no sufficient reason for regarding the males in bisexual families directly descended from unisexual families as differing in their chromosome

number from the normal. It should be mentioned that in the males of '12. 25, almost constantly some of the spermatocytes are binucleate or more rarely have four nuclei, and these give rise to binucleate or quadrinucleate spermatozoa. I have not traced the stage at which this condition arises.

It would be premature to discuss at this early stage the meaning of the observations described above. It appears probable that all the females of a unisexual family have 55 chromosomes instead of 56. Those which have only female offspring must therefore transmit only 27 to each of their offspring, and one chromosome is thus not accounted for. An attempt will be made when the moths hatch to find out whether one chromosome is eliminated at the maturation of the egg, and until that point is decided it is useless to speculate on the relation of the chromosome number to sex-determination.

There is one point of considerable theoretical importance, however, which should be referred to. A *grossulariata* female which has only female offspring does not transmit the *gross.* factor to any of them—the mother receives it from her male parent, but does not transmit it to her daughters, and since in this case she has no sons, she does not transmit it at all. In some way, therefore, it is eliminated, perhaps most probably at the maturation of the egg. She also receives 28 chromosomes from her male parent, but transmits only 27 to her offspring; one chromosome must therefore be eliminated. It seems, therefore, highly probable that this chromosome, which is not transmitted by the female whose offspring are all females, may be the determiner or bearer of the *grossulariata* factor. It is tempting also to suggest that this chromosome is a sex-determiner—that if it is received from the mother and a corresponding one from the father, the zygote becomes a male, and if it is received from the father only, it becomes a female. A difficulty arises, however, from the fact that some females at least, whose mothers belonged to unisexual families, have 56 chromosomes, as has been shown in the case of family '12. 25. It is probably best, therefore, to reserve further consideration of this part of the subject until our knowledge of the facts is more complete.

SUMMARY.

1. Families consisting wholly of females have appeared in six successive generations of *Abraxas grossulariata*; they may consist of *var. lacticolor*, of *grossulariata*, or of equal numbers of each, according to the constitution of the male parent.

2. In some cases unisexual families have been produced when both parents belonged to bisexual families descended directly from unisexual families. In other cases such matings have given families with great preponderance of females, but some males.

3. About half the females of a unisexual family have only female offspring. Infertility in such families is frequent.

4. The normal number of chromosomes in both sexes, whether *grossulariata* or *lacticolor*, is 56. Females of unisexual families, however, have often, and probably always, only 55.

5. Females of bisexual families, descended directly from unisexual families, have in some cases 56, probably in others 55 chromosomes. As far as is known, males always have 56.

6. It is suggested that the elimination of one chromosome may be correlated with the elimination of the *grossulariata* factor. The investigation is not yet far enough advanced to give definite evidence of the relation between the behaviour of the chromosomes and the phenomena of sex-determination in this species.

ON SEX-LIMITED INHERITANCE IN CATS, AND ITS BEARING ON THE SEX-LIMITED TRANSMISSION OF CERTAIN HUMAN ABNORMALITIES.

BY L. DONCASTER, M.A.,

Fellow of King's College, Cambridge.

SEX-LIMITED inheritance is now known to be a widespread phenomenon, but several problems of importance in connexion with it still remain obscure. It has been shown to exist in Lepidoptera and Diptera, in Birds and Mammals, and falls into two classes, according to whether the sex-limited transmission is by the male or the female. In *Abraxas* (Lepidoptera) and in the Fowl, Canary and Pigeon the female is found to be normally heterozygous for certain characters, and with rare exceptions transmits them to her male offspring only; in *Drosophila* (Diptera) and in Man and the Cat the male is similarly heterozygous and transmits certain characters chiefly or only to his daughters. The simple conclusion from these facts would be that in Lepidoptera and Birds the sex of the offspring is determined by the egg, and in Diptera and Mammals by the spermatozoon. There is evidence, however, that the sex-ratio in *Drosophila* is partly at least dependent on the female parent¹, and evidence pointing in the same direction has been brought forward in the case of Man. It is plain therefore that a full knowledge of sex-limited inheritance is of fundamental importance for the solution of the problem of the determination of sex. It is also of great importance from a somewhat different point of view. The hypothesis has been widely accepted that not only is sex determined by the so-called sex-chromosomes, which have been chiefly studied in Insects, and are known to exist in many other groups of animals, but also that the factors for sex-limited characters are also borne by these sex-chromosomes. Simple

¹ Moenkhaus, W. J., *Journ. Morphol.* Vol. xxii. 1911, p. 23; Rawls, *Biol. Bulletin*, xxiv. 1913, p. 115. [Morgan, *Science*, Vol. xxxvi. p. 718, Nov. 22, 1912, has given an explanation of Miss Rawls's results which is not inconsistent with sex determination by the spermatozoon in *Drosophila*. Note added March 5, 1913.]

and attractive as this hypothesis is, it cannot be regarded as established until certain contradictory facts have been explained. Apart from the fact that an odd chromosome has been described by Guyer in the spermatogenesis of the Fowl¹, although in this case it is the female and not the male which shows sex-limited transmission, the hypothesis has to face two chief difficulties. The first and less important is that no case is certainly known in which an odd or unequally paired chromosome exists in the female². This difficulty is not serious, since it is quite possible that a physiological difference may exist between the members of a pair of chromosomes, even though it may not be made visible by our rather crude cytological methods. The second difficulty is more fundamental, and arises from the fact that in the Canary and Pigeon at least, and possibly in other cases, the sex-limitation of the transmission of the characters studied is not absolute. A dark-eyed female Canary does not transmit the factor for the dark eye *only* to her sons; for when mated to a red-eyed cock a small proportion of the female offspring are also dark-eyed³. In the case of sex-limited transmission by the male no certain evidence of exceptions of this kind has been published, although some of Morgan's exceptional cases in *Drosophila* are most easily explained on the assumption of a failure of the normal sex-limited transmission⁴.

The position is therefore this. In one order of Insects and one class of Vertebrates it appears that sex is determined by the egg; in a second order of Insects and a second class of Vertebrates the same kind of evidence suggests that sex must be determined by the spermatozoon. In the second group the evidence for sex-determination by the spermatozoon is supported by the visible existence of unpaired sex-chromosomes, giving rise to two kinds of spermatozoa, and yet in both *Drosophila* and Man there are indications that sex-determination is dependent on or influenced by the mother. Secondly, it appears that in some cases at least sex-limitation in the transmission of characters is not absolute, but is partial as in the case of gametic coupling of other characters,

¹ *Anat. Anzeiger*, Vol. xxxiv. p. 573.

² Baltzer's description of such dimorphism among the eggs of Echinoids can hardly be regarded as proved, until the discrepancies between his results and those of Tennent have been removed. [J. Seiler, *Zool. Anz.* xli. p. 246, has just published a preliminary note indicating possible chromosome-dimorphism in the eggs of the Moth *Phragmatobia*. Mar. 1913.]

³ Durham and Marryat, Reports to Evolution Committee, *Royal Soc.* iv. 1908, p. 57.

⁴ E.g. the occurrence of a miniature ♀ in F_1 from rud.-min. ♀ × long male. *Zeitschr. f. indukt. Abstamm.* vii. 1912, p. 333.

and yet the hypothesis most widely adopted, especially in America, for the explanation of sex-limited transmission assumes that the sex-factor and the factor for the sex-limited character are borne by the same chromosome.

In the hope of obtaining fresh evidence on these two points I have collected and analysed a number of pedigrees of sex-limited affections in Man—Colour-blindness, Night-blindness, Nystagmus and Haemophilia¹. A preliminary examination of these showed that all four affections had the same characteristics as regards their inheritance—an apparent disturbance of the sex-ratio among the offspring of transmitting females, an excess of affected over unaffected males in affected fraternities, and occasional exceptions to the ordinary rule of sex-limited transmission among the children of affected males. On tabulating a considerable series of pedigrees, however, it became clear that there were several important sources of error, which it is difficult to eliminate, arising partly from the incompleteness of the pedigrees, and partly from the fact that it is impossible in most cases to know that a woman is a transmitter of the affection unless she has at least one affected son. While I was engaged on the work, I received a paper by Lenz² which points out that the apparent excess of males in affected fraternities, and also the excess of affected over unaffected sons, is possibly due to the fact that of necessity the totals of offspring of transmitting females are compiled from fraternities including at least one affected male. Fraternities consisting chiefly of daughters, with no affected son, are excluded, since they provide no evidence that the mother is a transmitter of the affection, and thus there arises a preponderance not only of males over females, but of affected over unaffected males. With the object of testing this suggestion I have tabulated the fraternities from my data for the four affections in which there are at least seven children, and find that in these totals the apparent excess of males is much reduced in each case, and in some vanishes altogether. The preponderance of affected over unaffected

¹ Colour-blindness—Nettleship, *Trans. Ophthalm. Soc.* xxviii. 1908, p. 220; xxvi. 1906; and unpublished cases kindly given me by Mr Nettleship and by Mr S. P. Hayes of Mount Holyoke College, U.S.A.

Night-blindness and Nystagmus—Nettleship, *Trans. Ophthalm. Soc.* xxix. 1909, p. lvii; xxxi. 1911, p. 159; xxviii. 1908, p. 220; xxxii. 1912, p. 21; and *Royal London Ophthalm. Hospital Reports*, xvii. p. 333.

Haemophilia—Bullock and Fildes, *Treasury of Human Inheritance*, Parts v. and vi. London, 1911.

² Lenz, *Über die Krankhaften Erbanlagen des Mannes*. Jena (G. Fischer), 1912.

also disappears in the case of Colour-blindness and Night-blindness, but remains almost unaltered in the Nystagmus totals. In the case of Haemophilia it varies greatly; in some families there is in each fraternity a great excess of affecteds, in others equality or deficiency; the totals when only large fraternities are included show a smaller excess than when all fraternities of every size are added together. It is the possible existence of this excess of affected individuals in the offspring of transmitting females which is chiefly of importance for the purpose for which the enquiry was undertaken. For it has been pointed out above that in some cases at least sex-limitation is not absolute, but is partial like gametic coupling of other characters, and it seems at least possible that the excess of affected over normal males among the sons of transmitting females might be due to partial coupling of the factor for the disease with a sex-factor, among the gametes of the female parent. We know that the factor for the affection is absolutely or almost absolutely coupled with a sex-factor in the gametes of the affected male, for he transmits the factor only, or almost entirely, to his daughters, his sons being very rarely if ever affected. If then we also found that a woman bearing this factor transmitted it chiefly to her sons, we should have absolute sex-limited transmission by one sex, and partial sex-limited transmission by the other sex, in the same species. A basis would thus be provided for a reconciliation of the two types of sex-limited inheritance, exemplified respectively by *Abraxas* and Birds on the one hand, and by *Drosophila* and Mammals on the other.

If this were the case, the high ratio of affected sons of a transmitting woman should be associated with a low ratio of transmitting to non-transmitting daughters. My material gives no evidence that this is the case; although the data for determining whether the daughters of a transmitting woman do or do not transmit are very inadequate, they suggest that the transmitting daughters are more numerous than they should be if the excess of affected over normal sons were due to gametic coupling of the factor for the disease with a sex-factor, in the gametes of the transmitting mother. The families which have an exceptionally high ratio of affected males also have a high ratio of transmitting daughters, instead of a lower ratio as would be expected on the gametic coupling hypothesis. It is hardly possible, therefore, with the data at present available, to come to any definite conclusion about the nature of the transmission of these human abnormalities. It can only be said that there is in some pedigrees an excess of affected

over unaffected males, but that this is not a constant feature, and when it occurs it is improbable that it is due to partial sex-limitation among the gametes of the transmitting female. Further, it is probable, if not certain, that occasional exceptions occur, suggesting that an affected man may very rarely transmit the factor for the affection to a son, and, correspondingly, may occasionally fail to transmit it to a daughter.

The difficulties in the way of an elucidation for the human cases arise chiefly from the impossibility of distinguishing a transmitting female except by the fact that she has affected sons. In the hope of throwing further light on the question, I compared my summaries of human pedigrees with data which I have collected during several years of colour-inheritance in Cats, and find that they are in most respects so closely similar that I believe the inheritance of certain characters in the Cat may provide a solution of the problems which cannot be answered by means of human pedigrees. In the case of the Cat the "transmitting female" is visibly different from the non-transmitting, and the most serious source of error affecting the human data is thus avoided.

The character in the Cat which appears to correspond in its inheritance with the sex-limited affections in Man is the orange colour as contrasted with the black which corresponds with "normality." In 1904¹, in a short note on the subject, I concluded that in the Cat the orange colour is dominant over black in the male, but only partially dominant in the female, so that the female heterozygote is tortoiseshell. The existence of sex-limited inheritance was at that time scarcely known, but I mentioned the fact that among my collection of data there was no case of an orange male mated with a black female giving orange male kittens; the females from such a mating were tortoiseshell, the males black. Subsequent collection of further data has shown conclusively that the transmission of the orange colour by the male is sex-limited, and the same result has been arrived at independently by C. C. Little from his own experiments².

In general, the results obtained with Cats are as follows:—an orange male mated to a black female gives black male and tortoiseshell female kittens; in the converse cross, orange female by black male, the male kittens are orange, the females tortoiseshell. The orange male thus usually transmits orange to his daughters only, the orange female transmits it to all her offspring of both sexes. A tortoiseshell female by black male gives orange and black males, tortoiseshell and black

¹ *Proc. Camb. Phil. Soc.* Vol. XIII. p. 35.

² *Science*, May 17, 1912.

females, showing that a female heterozygous for orange transmits the orange factor to some kittens of both sexes. The colours cream and blue appear to be dilute forms of orange and black, and to be inherited similarly. In what follows I shall use the term "yellow" to include orange and cream, "black" to include black and blue, tortoiseshell to mean a mixture of yellow and black, and, when necessary, "blue-cream" to describe the dilute tortoiseshell. The data given are derived almost entirely from correspondence with numerous breeders, but include the litters given by Little in the article in *Science* referred to. In the information obtained from breeders I have made every effort to insure that all inaccuracies are eliminated, but it is possible that a few mistakes may have been included. Where I have good cause for doubting the accuracy of a record, it has been omitted from the tables.

A summary of the data collected with regard to the inheritance of the yellow and black colours in Cats is given in the accompanying table. It is noticeable that the divergences from equality of the two sexes are similar in kind to those observed in the case of human sex-limited diseases, where, however, as has been seen, it is doubtful whether they are significant. In the offspring of yellow male mated to black female there is some excess of females (61 ♀ : 50 ♂), as is also the case among the offspring of men affected with one of the four diseases mentioned previously; among the offspring of tortoiseshell females by black males there is a considerable excess of males (67 ♂ : 35 ♀), as has generally been found to be the case among the children of women who transmit the diseases.

Another point of great importance is that there is evidence that the sex-limitation of the transmission of the yellow factor by the male is not absolute, for thirteen black or blue females are recorded from the cross yellow male mated to black or blue female, five from yellow male by tortoiseshell female, and three tortoiseshell females from one mating of yellow male by yellow female. It should be mentioned that the majority of the eighteen black or blue females from yellow sires were blues, and it is possible that the simple explanation that sex-limitation is not absolute, is not the true one in every case. Apart from the possibility that the sex may have been wrongly recorded in some instances, it is not completely certain that a young kitten may not sometimes be recorded as a blue when it is in reality a blue-cream. The breeders of whom I have enquired on this point are not agreed; some say that blue-creams are always easily distinguished from blues at

TABLES OF MATINGS.

I. Black or blue female \times orange or cream male.

Number of matings recorded	Offspring				
	Orange or cream male	Black or blue male	Orange or cream female	Tortoiseshell or blue-cream female	Black or blue female
25	—	46 + 3 ?	—	48	13
	—	+ 1 blue-cream δ	—	—	—

Note. Three blacks were of uncertain sex. In one mating of black $\varphi \times$ yellow δ there were produced two black δ , three tabby δ ; two tortoiseshell φ , and one tabby-tortoiseshell φ (not included in the table).

II. Orange or cream female \times black or blue male.

Number of matings recorded	Offspring				
	Orange or cream male	Black or blue male	Orange or cream female	Tortoiseshell or blue-cream female	Black or blue female
6	20	—	—	16	—

III. Tortoiseshell female \times orange or cream male.

Number of matings recorded	Offspring				
	Orange or cream male	Black or blue male	Orange or cream female	Tortoiseshell or blue-cream female	Black or blue female
34	54 + 1 ?	38 + 3 ?	47 + 1 ?	43	5
	+ 1 tortoiseshell δ	+ 2 smoke	—	—	—

Note. Those marked ? were of uncertain sex. In addition, from three matings of yellow δ by "tabby-tortoiseshell" and "grey-and-orange" females, there were produced four yellow δ , three black or blue δ , two tabby δ ; six yellow φ , two tortoiseshell φ , one tabby φ .

IV. Tortoiseshell female \times black or blue male.

Number of matings recorded	Offspring				
	Orange or cream male	Black or blue male	Orange or cream female	Tortoiseshell or blue-cream female	Black or blue female
22	35	29	—	21	12
	+ 1 tortoiseshell δ	+ 2 smoke	—	—	+ 2 smoke

Note. In addition, one mating of black $\delta \times$ "brown-orange-tabby" φ produced two yellow δ , one black δ ; one tabby φ .

V. Orange or cream female \times orange or cream male.

Number of matings recorded	Offspring				
	Orange or cream male	Black or blue male	Orange or cream female	Tortoiseshell female	Black or blue female
17	48	—	40	3	—

Note. The three tortoiseshell females (one of them "blue with a cream patch") were from the same mating (two litters),

birth, others that mistakes may be made. In some cases at least these blues grew up and seem to have been undoubted blues, and I know of no case of two blues mated together giving creams, as should happen if an apparent blue may ever be heterozygous for cream. In any case, the few black females from yellow sires, about which there appears to be no doubt, seem to prove that the sex-limitation of the transmission of yellow by the male is not absolute.

Another point of considerable importance in connexion with the comparison with the human cases is the ratio of the yellow to black males in the offspring of tortoiseshell female \times black male. As was said above, in the offspring of transmitting females in the human cases, it is generally believed that there is an excess of affected sons, but Lenz regards this as due to the fact that a transmitting woman can only be identified by having at least one affected son, and that this inevitably raises the apparent ratio of affected to unaffected. When only large families are considered, this excess disappears in the case of Colour-blindness and Night-blindness, but remains in the Nystagmus and Haemophilia totals, chiefly owing to the very great excess of affecteds in certain pedigrees, but it seems doubtful whether even in these affections it can be regarded as genuine. In the Cat, in which the "transmitting female" (tortoiseshell) is visibly different from the "non-transmitting" (black), a small excess of "affected" (yellow) over black is found (35 yellow : 29 black), but as in the human cases there is also an excess of "transmitting" (tortoiseshell) over "non-transmitting" (black) daughters, (21 : 12). The numbers are small, and further data are required before they can be regarded as significant, but they give no support to the suggestion discussed above that the excess of affected males is due to partial coupling of the factor for the affection with a sex-factor in the gametes of the transmitting female.

One of the most interesting questions connected with the inheritance of these colours in the Cat is the nature and origin of the rare tortoiseshell males. Three of these are included in my records, one (a blue-cream) from the mating yellow σ with black f , one from tortoiseshell female by black male, and one from tortoiseshell female by yellow male. Two tortoiseshell males are also recorded from this last mating in a note in *Fur and Feather* for May 10, 1912. I know of no other case in which the male parent was known; the few others that I have met with have been produced by tortoiseshell females by unknown sires. It has been shown above that there is reason for believing that the sex-limitation of the transmission of yellow by the male Cat is not absolute,

since a small proportion of black females are produced from yellow sires, and if this is so, there should theoretically be as many cases in which a yellow male transmits yellow to his sons, as there are of his failing to transmit it to his daughters. I know of no satisfactory record of a yellow male mated to a black female having yellow sons, but suggest that the tortoiseshell male is produced when, exceptionally, yellow is transmitted by a yellow male to a son¹.

Very little is known of how a tortoiseshell male transmits colour-factors to his offspring. The few breeders who possess them commonly mate them to tortoiseshell females, in the belief that this is the most likely mating by which to produce tortoiseshell male offspring, and I know of only one mating with a black female, which is the one required to test the matter thoroughly. In this one case the female was not kept in confinement, so that although the pairing was seen, the parentage of the kittens cannot be regarded as certain; the only recorded kittens were a black male and a tortoiseshell female. When mated with tortoiseshell females, tortoiseshell males appear to behave like yellows, giving yellow and black male, tortoiseshell and yellow female offspring. Sir Claude Alexander, who has made many such matings with one of his well-known specimens, writes of this tortoiseshell male that with unrelated tortoiseshell females he "sires tortoiseshells freely," but that with his own tortoiseshell daughters he gives chiefly yellows, with only an occasional tortoiseshell female or a black. Unfortunately, no record of the sex of these kittens appears to have been kept; no tortoiseshell males were produced.

The facts, then, as far as they are known, of the transmission of the yellow colour in the Cat, may be summarised thus. In the female the factor for yellow when homozygous produces orange (or cream when dilute); when heterozygous produces tortoiseshell. In the male the presence of the yellow factor normally produces orange (or cream), but such males are not homozygous, for in general they transmit the yellow factor to their daughters only. Exceptions to this rule, however, occur, not apparently very rarely, for black females from yellow sires are frequently recorded. Less common are tortoiseshell males, about which little is known, except that they may apparently derive the yellow factor from either parent, and that there is no recorded case of their having tortoiseshell male offspring.

Until more data are collected, it seems of little value to attempt to express these facts in a factorial scheme, for no means of testing such

¹ See also p. 21 below.

schemes are available. Certain points of importance, however, may be considered. It has been suggested by Little¹ that both the black and yellow factors are sex-limited in the male Cat, and this suggestion is in harmony with the fact that a female heterozygous for yellow is tortoiseshell, while the heterozygous male is yellow. For if the factor for black were not sex-limited in the male, one would expect the male heterozygous for yellow to be tortoiseshell as in the case of the female. If all males containing the yellow factor were yellow, and if there were no exceptions to the rule that the yellow male transmits yellow only to his daughters, the case of the Cat would fall quite simply into the scheme which I recently suggested for characters which appear to be dominant in one sex and recessive in the other². This suggestion was that one sex (in the Cat and in Man the female) is normally homozygous for a factor for "normality" (NN), for which the normal male is heterozygous (Nn), and that N is constantly coupled with a sex-determining factor for which the female is homozygous, the male heterozygous. In the Cat the factor for normality would be the black determiner, which may therefore be written B instead of N; then if X is used for the sex-factor, adopting the notation commonly used in America, a black male would be BX.bx, a black female BX.BX. If then the yellow colour be caused by the loss of the factor B, the yellow female would be bB.bX, the tortoiseshell female BX.bX, and the yellow male bX.bx.

This scheme, however, has the obvious defect that it represents the black male and the tortoiseshell female as of the same factorial composition as far as B and b are concerned (Bb in each case). An improvement might be to represent the yellow factor as a modification of B rather than its absence; if the modified B which gives rise to yellow instead of black be called Y, the yellow female would be YX.YX, the tortoiseshell female BX.YX, and the yellow male YX.bx. Since Y is normally coupled with X, a yellow male would then normally transmit Y only to his daughters, and since when he is mated with a black they would receive B from their mother, they would be tortoiseshell, thus:—

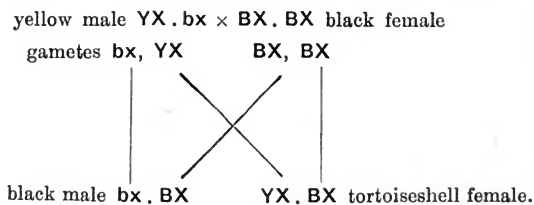

¹ *Science*, May 17, 1912.

² *Journal of Genetics*, I. 1911, p. 377.

If now, exceptionally, Y became dissociated from X in the gametes of the yellow male, and were thus transmitted to a son instead of a daughter, the result would be

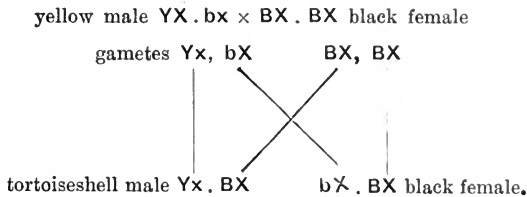

The female offspring would in this case be black, but heterozygous for B instead of homozygous, and the male, since he contains both Y and B, would be tortoiseshell.

I have one record of a tortoiseshell male produced by tortoiseshell female by black male. The kitten died when only a month old, but the breeder is confident that it was a male. If, as suggested, the tortoiseshell male has the constitution YBXx, this could only arise in this instance by the tortoiseshell mother transmitting YX, the black father Bx; the tortoiseshell male would then arise by the exceptional association of B with x in the spermatozoa, instead of B with X¹.

The scheme outlined above is satisfactory up to this point, but it has two disadvantages. It involves the assumption that the occasional black females produced from yellow sires are of different constitution from normal blacks (BX.bX instead of BX.BX), for which there is no direct evidence. The point could be tested by mating such a black female with an orange male; if the female were heterozygous for B, it would then give not only tortoiseshell females YX.BX, but also yellow females of constitution YX.bX. This experiment has never, as far as I know, been made. The second objection is more serious. The

¹ There is an additional piece of evidence supporting the hypothesis that the factor B is sex-limited. I have a record of *tabbies* being produced from yellow ♂ × black ♀. Tabby is known to be epistatic to black, but presumably can only appear in the presence of the factor B. The yellow male which transmits the tabby factor does so to both sexes, the male kittens which receive the tabby factor being brown tabbies, the females (only one recorded) "tabby-tortoiseshells." It is clear therefore that the tabby factor is not sex-limited. If, however, the black factor were present in the orange male, it is probable that the cat would be tabby or tabby-and-yellow instead of yellow. If, therefore, a yellow male can in some cases transmit the tabby factor, additional evidence is provided for the assumption that the black factor is not present. Tabby tortoiseshell males, though very rare, do exist, and are presumably tortoiseshell males which bear the tabby factor in addition. One was exhibited at the Crystal Palace Show in 1912.

tortoiseshell male should on this hypothesis be $Yx.BX$, and since B is coupled with X , such a male should transmit B to his daughters and Y to his sons. Mated to black he should have black female and tortoiseshell male offspring; mated to a tortoiseshell he should have tortoiseshell and black daughters, yellow and tortoiseshell sons. Of the mating of a tortoiseshell male with a black I have only one somewhat doubtful record, but hope to be able to test the matter with a tortoiseshell male now in my possession; in the several matings with tortoiseshell females which are reported, no tortoiseshell males were produced—the tortoiseshell male behaved as far as can be judged from the very incomplete reports as if he were a yellow.

Other possible schemes might be suggested, for example that yellow is due to an additional factor modifying B and usually coupled with it, but occasionally becoming dissociated so that the yellow male would transmit B to a female kitten and the modifying factor to a son. The tortoiseshell male so produced, however, would still receive the modifying factor from the male parent and B from the female, and it would be expected, if these factors followed the ordinary rules of gametic coupling, that they would show repulsion in the gametogenesis of the tortoiseshell male, so that again the modifying factor would be transmitted to the male offspring and tortoiseshell males would be produced as in the previous scheme.

It seems clear, therefore, that the data at present available are inadequate for the formulation of a factorial scheme of colour-inheritance in Cats, which shall be in accord with previously known cases of sex-limited inheritance and of gametic coupling in other forms. For any one, however, who is able to undertake the work, the experiments required are fairly clear, and the importance of the case is increased by the fact that the transmission of the yellow colour in the Cat is in close agreement, both in its normal course and in the exceptions which occur, with the transmission in Man of the sex-limited affections Colour-blindness, Night-blindness, Nystagmus and Haemophilia. Although so much has been written about the transmission of these diseases, no agreement has been reached, and it seems probable that the inheritance of colour in the Cat, with which definite experiments can be made, and in which the "transmitting female" can be distinguished at sight from the "non-transmitting," may provide the clue which the most complete human pedigrees would fail to yield.

In conclusion, I wish to tender my thanks to the following ladies and gentlemen who have provided the information given in the

preceding pages, and to many other correspondents who have helped me in various ways to collect and verify my data.

R. Alder, Esq., Sir C. Alexander, Bart., W. O. Backhouse, Esq., Miss W. Beal, The Hon. Mrs C. Behrens, Mrs Bennet, J. Bishop, Esq., J. L. Bonhote, Esq., Miss Cope, Miss A. M. Drury, The Misses Elliott, Mrs Forsyth Forrest, Miss F. E. Frowd, Mrs M. M. Hall, Mrs Kennaway, Miss H. Lea, Mrs L. Maxwell, Mrs Norris, Mrs F. Owen, Mrs Sinner, Mrs Slingsby, Mrs Mackenzie Stewart, Miss H. M. Tawse, Miss Turnhill, Miss Veevers.

CAMBRIDGE,

January 28, 1913.

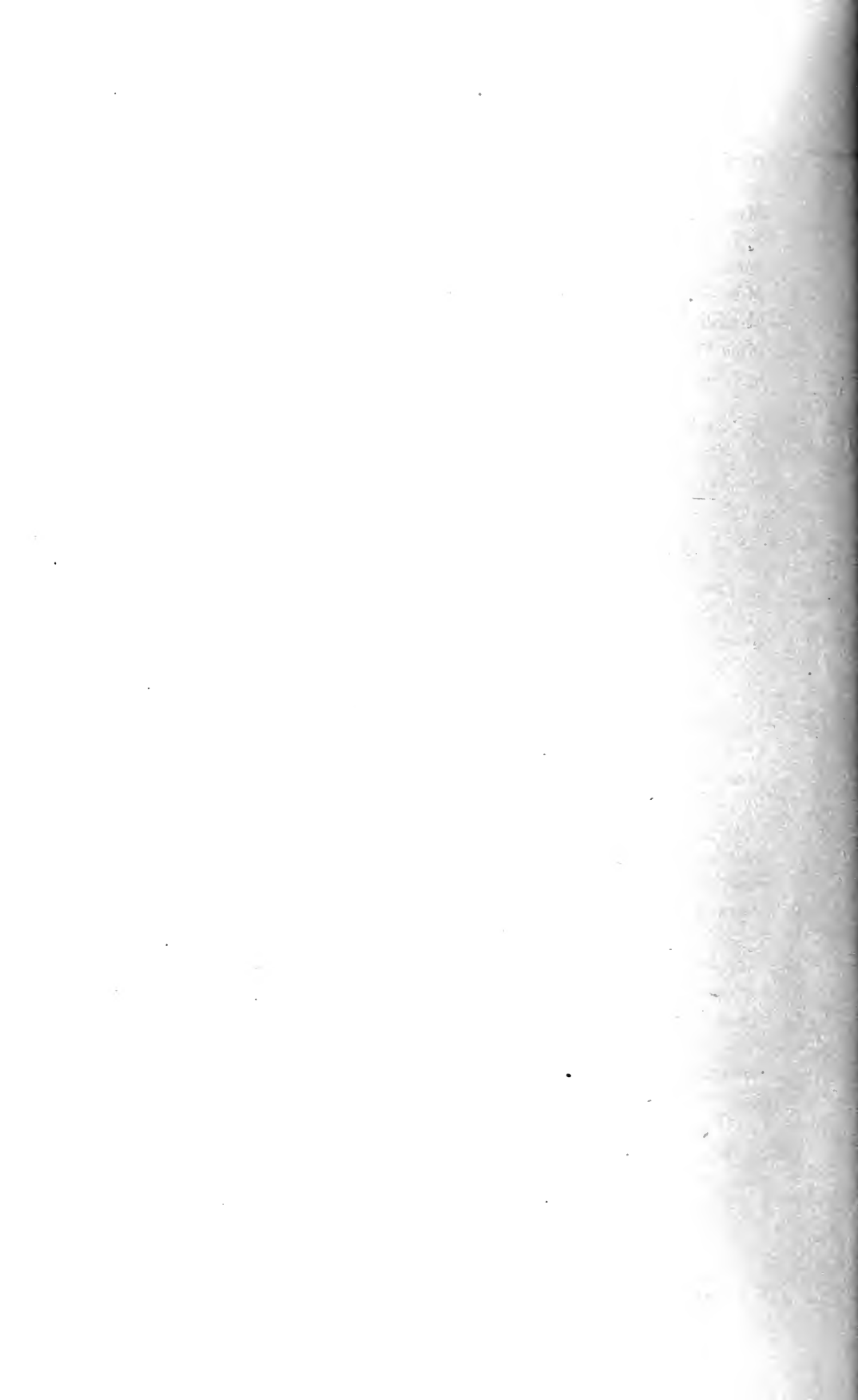

FIVE GENERATIONS OF CONGENITAL STATIONARY NIGHT-BLINDNESS IN AN AMERICAN FAMILY.

BY H. H. NEWMAN.

(From the Hull Zoölogical Laboratory, University of Chicago.)

IN his book *Mendel's Principles of Heredity*, Bateson, discussing the laws of sex-limited inheritance in man, says that "the only one of the notoriously sex-limited conditions which is available for testing the rules is colour-blindness. Haemophilia and Gowers' disease are too fatal and night-blindness is too rare and too little known." It is the purpose of the present paper to add a chapter to the present meagre literature on the inheritance of night-blindness¹. The data herewith presented were obtained in collaboration with Miss Elizabeth L. Brown, who has had exceptional opportunities for getting at the facts since she is a member of the affected family and has seen and tested the majority of her living relatives. Those whom she has been unable to observe have freely communicated the facts to her. I have been in correspondence with Miss Brown for considerably over a year and have directed her investigations. Every effort has been made to eliminate all sources of error and to obtain all information that might be of value. There is still some doubt as to the exact character of the defects associated with night-blindness, but we can vouch for the accuracy of the pedigree as given in the diagram in so far as the major defect, night-blindness, is concerned. Errors have been eliminated from the pedigree largely through the use of a questionnaire suggested by Mr Nettleship, who has been kind enough to express a personal interest in the progress of the investigation.

¹ A very recent paper by Nettleship has just come to my attention in which a case of night-blindness similar to that here dealt with is discussed. The paper is: "A Pedigree of Congenital Night-Blindness with Myopia." *Ophth. Soc. Trans.* Vol. xxxii. 1912.

The association of families dealt with in this paper is confined to the State of Texas, but originated in the State of North Carolina. Whether or not the strain can be traced back to an English origin I am unable to ascertain. It would be interesting to find that the present line is a branch of one of those investigated by Mr Nettleship. In order that it may be made possible to trace such connection, if it exist, I shall give the full names, where obtainable, of all individuals concerned.

Especial interest attaches to the present pedigree first because it appears to follow a formula hitherto undescribed for night-blindness and second because the major defect is found so generally associated with much less rare disease of the cornea known as Pterygium, which is not sex-limited but more pronounced in males than in females. Strabismic and myopic conditions appear to be in some way tied up with night-blindness and are also sex-limited.

The peculiarities in the descent of the various sex-limited characters of man are given by Bateson as follows :

1. They affect males much more commonly than females.
2. They may in certain cases be transmitted by affected males, but are not transmitted by unaffected males.
3. They are nevertheless transmitted by the *unaffected females*. Apparently normal women, sisters of the affected males, thus may transmit the condition to some of their sons.

The case herewith described falls in line with none of these schemes of inheritance but would demand a fourth formula somewhat as follows :

4. *They are not transmitted directly by males, either affected or unaffected, but only by the unaffected daughters of affected males to some of their sons.*

That this method of inheritance was recognized by Bateson but inadvertently omitted is shown in a note facing page 230 of his book, in which he corrects an error regarding the inheritance of colour-blindness. He says :

“In haemophilia and night-blindness there are cases of the direct descent of the condition from father to son in families showing ordinary sex-limited descent, but as regards colour-blindness, though there are instances of the direct descent from father to son, it is now obvious that in all of them the affection was introduced by the normal-sighted mother also. Apart from these there is no case of a colour-blind man having a colour-blind son known to me. On the contrary, from the records, for the most part communicated by Mr Nettleship, there is

now good evidence as to the condition of 23 sons of colour-blind men and all are normal (besides 15 more said to be normal on less certain authority). Such a fact is very significant."

That colour-blindness is not the sole optic affection following this interesting inheritance formula is shown in the present case where night-blindness is seen to follow exactly the same course.

Following the method adopted by Nettleship and others I shall first give a pedigree showing the inheritance of night-blindness, dealing with the less certain accompanying affections in connection with the descriptions of individual cases. The five generations will be taken up serially, beginning with the oldest, and each individual will be referred to a number shown in the diagram.

I, 1. *Joel Bryan* of North Carolina, a Quaker, probably of English extraction. No definite information as to whether or not he was night-blind.

I, 2. Wife of Joel Bryan. No information obtainable concerning her maiden name or antecedents.

I, 3. *Thomas W. Vause* of North Carolina, a physician, a first cousin (?) of Joel Bryan, but considerably younger than the latter. As a young man Mr C. D. Uzzell carried on a considerable correspondence with Dr Vause with reference to the night-blindness with which both were affected. There is no doubt then that night-blindness was of earlier origin than this generation.

II, 1. *Margaret Bryan Uzzell*, daughter of Joel Bryan, is the only issue of the latter that it has been possible to bring to light. Several years after her marriage to Mr Uzzell in North Carolina she moved to Texas and was the ancestor of the present Texas night-blind connection. She had normal vision but transmitted night-blindness to three of her four sons. There were in addition five normal daughters.

II, 2. *Mr Uzzell*, husband of Margaret Bryan Uzzell, had normal vision, as is testified by his son, Mr C. D. Uzzell.

III, 1—11. Issue of II, 1 and 2. No other pregnancies known to Mr C. D. Uzzell.

1. *J. C. Uzzell*, dead, night-blind to the same extent as C. D. Uzzell (5). He seems to have left no progeny.

2. *Mrs Haynie*, dead. There is no record of night-blindness in her or in her progeny.

3. *Mrs Bayers*, dead. Normal and normal progeny.

4. *Mrs C. U. Carson*, aet. (1912) about 77, normal vision and normal progeny.

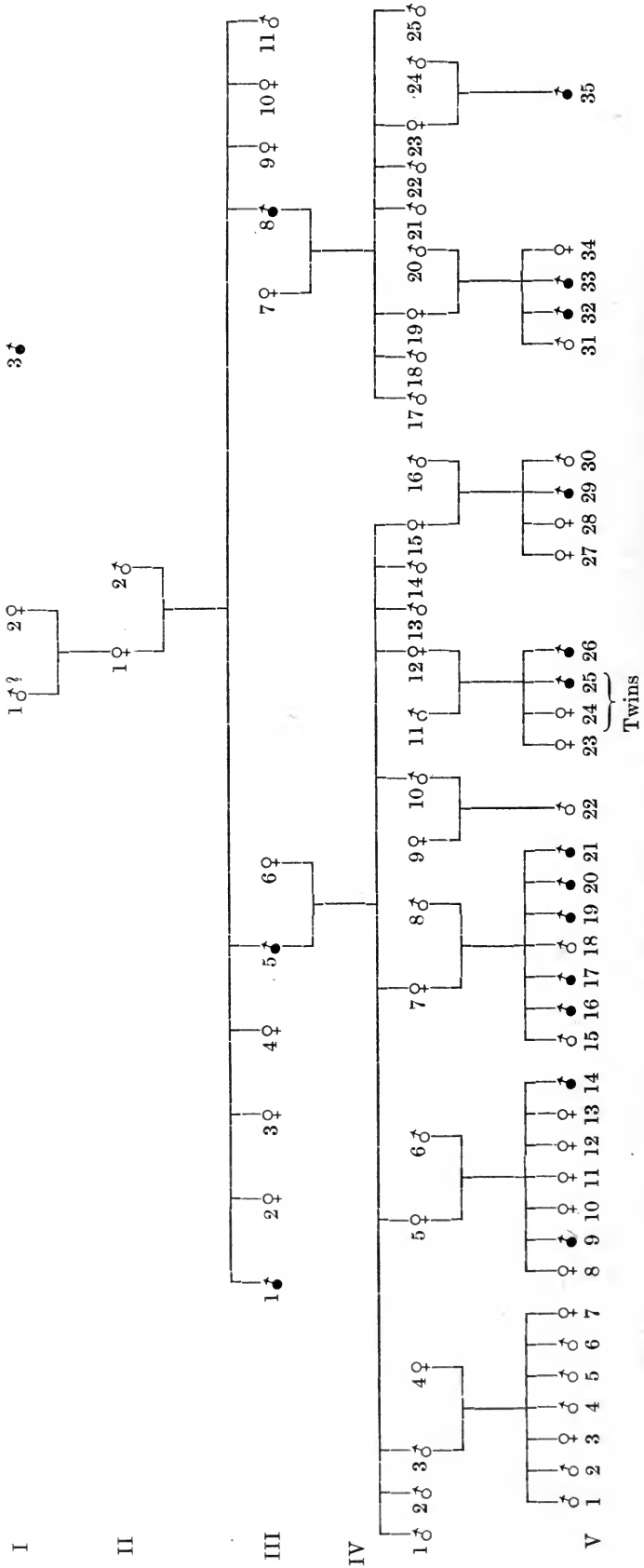

Fig. 1. (Explanation on p. 38.)

5. *C. D. Uzzell*, aet. (1912) 74, night-blind from infancy, "short-sighted" (probably myopic) and has suffered considerably from Pterygium, having been rather recently operated on for the latter with apparently beneficial results. He is the father, by his normal and unrelated wife, of six normal sons and four normal daughters and the grandfather of nine normal and ten night-blind grandsons and of eleven normal grand-daughters. Mr Uzzell has taken a lively interest in the present investigation and has furnished some of the most important information. A quotation from one of his letters should prove interesting: "Night-blindness and near-sightedness were transmitted to our family on the maternal side, but personally I never knew of but one case in a preceding generation, and he was a (second) cousin of my mother. He was a good physician and somewhat of a zoölogist. I used to have an extensive correspondence with him, hoping thereby to find some way to remedy my own defective vision, but he was unable to assist me in any way. My mother, who was perfectly normal in vision, had four male children, three of whom were affected just as I am, and one that was not. (He failed in this letter to mention that he had five normal sisters, but this fact was brought out later.) All my children have perfect eyes. This trouble does not seem to be transmitted regularly, but it seems to fall on alternate generations, so my mother told me. It is also transmitted from the father through the daughter to the grandsons. I have never heard of a girl in the family connection who did not have perfect sight. The children of both my sons (referring only to those with families) have perfect sight, but the eyes of my daughters' sons are nearly all affected, one daughter having seven sons, five of whom are affected. My other three daughters have each one son and each is affected. (Reference is made to living sons only. One grandson V, 30 has been born since the receipt of this communication.)" Miss Elizabeth L. Brown (V, 8) writes of C. D. U., her grandfather: "Grandfather (III, 5) was unable to see the moon and stars until he was about thirty. He says the defect grows less and less as he grows older. He has had much trouble with a growth similar to cataract, which grows in the inner corner of the eye and gradually spreads toward the centre of the eye with advancing years. (This condition has been diagnosed as Pterygium, a progressive formation on the cornea, beginning as a pinguicula located at the nasal angle of the cornea and overgrowing the cornea as a fold or wing of tissue, usually highly vascular in character.) It sometimes becomes inflamed. Operations have relieved the condition to some extent."

Note.—The parentheses in both of the above quotations are my own.

6. Normal wife of C. D. Uzzell.

7. Normal wife of E. B. Uzzell.

8. *E. B. Uzzell*, aet. about 70, brother of C. D. U., is night-blind, myopic and has suffered greatly with Pterygium. He was almost blind a few months ago, according to his own statement, but has been partially relieved by an operation. He writes that all of his children and those of his sons are normal so far as night-blindness is concerned, but that the sons of his daughters show a considerable percent. of night-blindness and other defects of the eyes. He has five normal sons and two normal daughters, both of whom have night-blind sons.

9. *Mrs N. Carson*, dead, normal in vision. There is no known case of night-blindness in her progeny.

10. *Mrs L. Doyle*, living, normal, with normal progeny.

11. *William Uzzell*, living, the only normal male of the childship. None of his progeny or descendants exhibit night-blindness.

IV, 1—16. Issue (minus the marriages) of III, 5 and 6. No other pregnancies.

1. First-born male child. Evidently died in infancy as no name was given.

2. *H. W. Uzzell*, dead, normal. Left no progeny.

3. *D. K. Uzzell*, aet. 43, normal so far as night-blindness is concerned, but his eyes "are in very bad condition from cataract" (Pterygium is the diagnosis here). Three of his four living sons show symptoms of Pterygium more or less advanced. His two daughters, now dead, were normal.

4. Normal wife of D. K. Uzzell.

5. *Mrs U. S. Brown*, aet. 41, normal so far as night-blindness is concerned, but has the most pronounced case of Pterygium among the female members of the connection. She has had two male and five female children. Both sons, one of whom is now dead, night-blind. The daughters, two of whom are living, all normal. Miss E. L. Brown, who has collaborated with the writer in this investigation, is V, 8, the eldest child of Mrs U. S. Brown.

6. Normal husband of Mrs U. S. Brown.

7. *Mrs Hobdy*, aet. 39, normal. She has seven sons living, five of whom are unquestionably night-blind and two are normal. No Pterygium apparent.

8. Normal husband of Mrs Hobdy.

9. Normal wife of M. W. Uzzell.

10. *M. W. Uzzell*, aet. 37, normal so far as night-blindness is concerned, but has an incipient case of Pterygium, the least troublesome case among the males of the third and fourth generations. He has only one child, a normal son, aged 3.

11. Normal husband of Mrs E. F. Floyd.

12. *Mrs E. F. Floyd*, aet. 35, normal so far as night-blindness is concerned, but shows a moderate development of Pterygium. She has had two night-blind sons, one of whom is now dead, and two normal daughters. The living son and one of the daughters are twins.

13. *C. D. Uzzell, Jr.*, aet. 32, normal so far as night-blindness is concerned, but with a pronounced case of Pterygium. He is unmarried.

14. *J. U. Uzzell*, aet. 30, normal so far as night-blindness is concerned, but with Pterygium obvious. He is unmarried.

15. *Mrs Hurst*, aet. 27, normal. She has two sons, one certainly night-blind and the other too young to exhibit the defect. She has also two normal daughters.

16. Normal husband of Mrs Hurst.

IV, 17—25. Issue (including normal mates) of III, 7 and 8. No other pregnancies.

17, 18, 21, 22. Normal sons of E. B. Uzzell. They are all married and have none but normal issue.

19. *Mrs Montgomery*. Normal. Has two night-blind sons and one normal son, and one normal daughter.

20. Normal husband of Mrs Montgomery.

23. *Mrs Norton*. Normal. Has one night-blind son.

24. Normal husband of Mrs Norton.

25. Normal unmarried son of E. B. Uzzell.

V, 1—7. Issue of IV, 3 and 4.

1. *Irvin Uzzell*, aet. 19, normal so far as night-blindness is concerned and without Pterygium.

2. *Wason Uzzell*, aet. 17, normal so far as night-blindness is concerned. Has had some trouble with Pterygium.

3 and 4. *Jewel* and *Minter Uzzell*, dead. Both were normal.

5 and 6. *Lester*, aet. 11, and *Douglas Uzzell*, aet. 9, normal so far as night-blindness is concerned, but both have incipient Pterygium.

7. Female infant, died in infancy.

V, 8—14. Issue of IV, 5 and 6.

8. *Elizabeth L. Brown*, aet. 21, normal. Miss Brown is a member of the present senior class at the University of Texas and has made a

speciality of Zoölogy. Without her aid it would have been practically impossible for me to have gathered the data for this paper.

9. *Henry W. Brown*, dead, was unmistakably night-blind and showed the usual associated defects.

10. *Aline Brown*, dead, normal.

11. *Leona Brown*, aet. 14, normal.

12. *Marjory Irene Brown*, dead, normal.

13. *Stella K. Brown*, aet. 9, normal.

14. *Walter S. Brown*, aet. 4, night-blind, and slightly strabismic.

Of him Miss E. L. Brown, his sister, writes: "Brother cannot see anything out of the light at night, except that on bright nights he can see anything between him and the sky. I took him out of doors one night and noted that he could see the wind-mill, trees, houses, fences, etc., but at the same time he could not distinguish his express wagon, his kitten or other objects on the ground. He tries to count the stars and the lights in other windows, so I am sure that he is less night-blind than some of the Floyd and Hobdy children. He is not short-sighted at all, but his eyes do not focus together. This was more noticeable when he was a baby, but he has outgrown it until it is only noticeable when he looks up."

V, 15—21. Issue of IV, 7 and 8.

15. *Drew Hobdy*, aet. 19, normal.

16. *John Hobdy*, aet. 16, night-blind, myopic and strabismic.

17. *Walter B. Hobdy*, aet. 13, night-blind, but without any other optic defect.

18. *Maurice Hobdy*, aet. 11, normal.

19. *Monroe Hobdy*, aet. 8, night-blind, myopic and strabismic.

20. *Alton Hobdy*, aet. 6, night-blind, myopic and strabismic. Was tested as follows: Turns head to one side when reading, holds book less than 8 inches from the eyes.

21. *Vernon Hobdy*, aet. 4, night-blind, but without the other associated defects.

V, 22. *Minter Uzzell, Jr.*, only issue of IV, 9 and 10, normal, aet. 3.

V, 23—26. Issue of IV, 11 and 12.

23. *Enid Floyd*, aet. 10, normal.

24 and 25. *Ira and Irma Floyd*, twins, aet. 5. Irma is normal. Ira is night-blind, myopic and strabismic. Miss E. L. Brown writes of him as follows: "He holds objects as small as a pin about five inches from his eyes. Being too young to read I could not tell how far from

his eyes he would need to hold a book. The right eye looks straight ahead, but the left does not focus with the right. In looking closely at objects he turns his head to one side and looks with the left eye. He can hold his hand over the left eye and see well with the right. He is being treated for this trouble by an oculist who claims that he will be able to see at night when he has finished with him."

26. *Edward T. Floyd*, dead. Lived long enough to exhibit sure signs of night-blindness. No facts about associated defects.

V, 27—30. Issue of IV, 15 and 16.

27. *Floyd Hurst*, dead, normal.

28. *Mildred Hurst*, aet. 6, normal.

29. *Jack Hurst*, aet. 4, night-blind, but without other defects.

30. *Marvin Hurst*, aet. 8 months (will be nearly 2 years when this paper is published. All the ages used in paper apply to the Autumn of 1911). He now shows unmistakable signs of night-blindness, but no other defects.

V, 31—34. Issue of IV, 19 and 20.

31. *J. L. Montgomery*, aet. 24, normal.

32. *R. D. Montgomery*, aet. 21, night-blind and myopic (wears concave glasses).

33. *H. L. Montgomery*, aet. 18, night-blind, myopic. Mr C. D. Uzzell (III, 5), his great-uncle, says of him: "His eyes are in terrible condition. He can hardly see in the daytime. If he starts to go through a door without his glasses he is as apt to miss it as to go through it."

34. *Evolyn Montgomery*, aet. 8, normal.

V, 35. Issue of IV, 23 and 24. Name and age unknown. Night-blind.

DISCUSSION.

The probable mechanism of the inheritance of night-blindness.

It has been shown by Guyer ('10) that there is a bivalent *X* chromosome in the spermatogonia of man and that two classes of spermatozoa are formed in equal numbers, half with an *X* element and half without¹. In the light of the investigations of E. B. Wilson and others it seems practically certain that the sex of man is in some way

¹ Some of the details of Guyer's results have been disputed, but need not be discussed here.

dependent upon or associated with the presence or absence of the X chromosome in the spermatozoa. Regarding the ova as homozygous and the spermatozoa as heterozygous for sex, we may explain the inheritance formula of night-blindness by assuming that the character is a Mendelian recessive, which has probably arisen by the loss of some factor necessary for normal vision, and that the defect has its seat in the X element of the affected male. Probably night-blindness arose in a male as a mutation.

On this assumption eggs fertilized by spermatozoa with the X element will develop exclusively females, and therefore the X element of the affected father, together with whatever defects or peculiarities may be associated with it, is transmitted only to the female offspring. This explains why all of the sons of affected men are normal. The daughters, however, all inherit the factor for night-blindness, but fail to show it because it is recessive to the normal character carried by the normal X element of the normal mother. The maturation of the ova of these night-blind carrying daughters will result in the formation of gametes of two kinds in equal numbers, half with the normal X element and half with the defective X element ($=x$) carrying night-blindness. If these daughters are mated with normal men we should expect equal numbers of male and female offspring, half of each of which would contain the factor for night-blindness. The females of course would always appear to be normal, but half of the sons would be night-blind. The following diagram (Fig. 2) will illustrate graphically the inheritance mechanism just outlined.

This diagram is a modification of that used by E. B. Wilson ('11) in explaining his idea of the probable mechanism of the heredity of white eyes of *Drosophila*. He states that the same type of explanation may be applied to the inheritance of colour-blindness in man. Since this case of night-blindness is inherited precisely as is colour-blindness, there can be little hesitation in adopting the scheme outlined above for its explanation.

Wilson points out, furthermore, that "any recessive mutation should exhibit sex-limited heredity when crossed with the normal or dominant form, if it be due to a factor contained or omitted from the X element." It is now known that a number of human traits of an abnormal or defective nature are inherited in the fashion exemplified by the present pedigree. Davenport ('11) gives the following list of such characters: multiple sclerosis, hereditary atrophy of the optic nerve, colour-blindness, myopia, ichthyosis, muscular atrophy, haemophilia. Probably

this mode of inheritance will be found, in the near future, to be much more common than now appears to be the case.

It is an interesting thought that a specific defect in the adult may be due to an equally specific defect in a single chromosome of the germ cell. Evidently any defect in the *X* element, assuming that the latter is the seat of the factors responsible for the various defective conditions listed above, must be as distinct and specific as is the condition for which it becomes responsible in the adult. One might, on the other

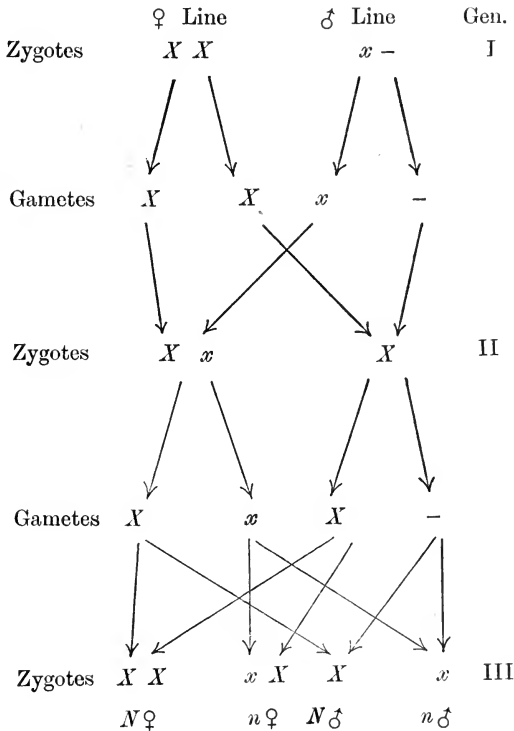

Fig. 2. (Explanation on p. 38.)

hand, conceive germinal deficiency as due to a generalized metabolic weakness of the *X* element, and might assume that the particular form of adult deficiency arising from this situation depends on the specific peculiarity of the particular line of germ plasma in which the germinal deficiency arose. In this way one simple type of germinal defect might in one family result in a complex of optic defects and in another as haemophilia or muscular atrophy.

Although the explanation here offered to show how night-blindness is probably inherited in this instance is on the whole rather satisfying, it does not completely accord with the data shown in the pedigree. Perhaps the most serious discrepancy is encountered in connection with the apparent non-inheritance of the capacity to transmit night-blindness on the part of the sisters of night-blind men. According to expectation there should be in F_3 or F_5 , assuming that there has been no consanguineous marriage, equal numbers of night-blind carrying and of normal females, but the pedigree seems to show that none of the progeny of the five married sisters of C. D. Uzzell and E. B. Uzzell (night-blind males of the third generation) show a trace of night-blindness. Whether sisters of night-blind males can transmit the defect will doubtless be determined in the present generation. If it should prove that night-blindness cannot be inherited for two consecutive generations in the female line, it would be a fact of unusual significance. It would seem to be a case in which a prolonged association of the defective X element with the normal X element in the germ plasm of two generations of females might serve to correct the defect in the former and thus eliminate night-blindness from these particular lines. The value of this idea depends on whether or not the findings in the pedigree are substantiated by future events.

In common with other writers who have reported pedigrees of this sort I find a serious discrepancy in the ratio of males and of females, and in that of affecteds and unaffecteds. Of the 36 offspring of the night-blind carrying daughters of night-blind men, 22 are males and 14 females instead of the expected 18 : 18. Perhaps this discrepancy is within the range of probable error. But the fact that of these 22 males 17 are affected and only 5 unaffected can hardly be so interpreted. An excess of affecteds, however, is found quite generally in haemophilia and in certain less known inherited affections, and it may well be, as Bateson suggests, that in these cases there is present some unknown disturbing factor that distorts the normal Mendelian ratios.

The association of night-blindness with other optic defects.

Nettleship and others have noted that the sex-limited type of night-blindness is almost invariably associated with myopia. He even finds it sometimes associated in inheritance with certain mental defects. The present pedigree is in agreement with the conditions described by

Nettleship with respect to myopia, and I find strabismus¹ almost as invariable an accompaniment of night-blindness. An expert ophthalmologist would doubtless detect several other well-defined affections, which almost certainly are present in those cases where a near approach to complete blindness is described, for, as I understand it, complete blindness is never the result of either night-blindness or any of the associated conditions known to exist in this family.

The frequent occurrence in the pedigree of the minor defect Pterygium² seems to be somewhat unusual. The defect is evidently strongly inherited, probably as a Mendelian dominant, since it is neither sex-limited nor necessarily associated with the recessive night-blind complex. Peculiarly enough, however, although not strictly sex-limited, it occurs more commonly and assumes a more serious aspect in males than in females.

It would appear then that night-blindness, myopia, strabismus (and possibly some other conditions that have not been diagnosed) form a complex due to a single sex-linked factor and that whether one, two or all of the conditions appear simultaneously or successively in an individual may depend upon cooperating or counteracting factors in the germ plasm of the normal parent, producing an intensification or a dilution of the somatic expression of the germinal defect.

In conclusion it may be well to point out that, if we follow Wilson's suggestion, it is no longer admissible to interpret such conditions as colour-blindness and this type of night-blindness as due to a factor dominant in males and recessive in females, for it seems pretty well established that such characters are really recessive and only express themselves, after the manner of recessives, in the absence of the dominant allelomorph.

¹ Nettleship suggests that strabismus is due to the necessity the affected are under of bringing the book, etc. very close to the eyes, and is unrelated with night-blindness as such.

² Nettleship is of the opinion that Pterygium as such is not inherited but that there is merely a congenital peculiarity of the mucous membrane predisposing to Pterygium. The defect itself is commonest in people whose eyes are constantly exposed to glare, dust and irritants over a number of years. The glare and dust of Texas are characteristic elements of the climate.

LEGENDS OF FIGURES.

Fig. 1. Pedigree showing the inheritance of night-blindness in a Texas family. The black symbols are the affected members. The Roman numerals on the left refer to generations.

Fig. 2. Diagram to show the possible mechanism of the heredity of night-blindness. The normal accessory chromosome is represented by X ; the abnormal accessory chromosome by x , which is assumed to carry the factor for night-blindness. In the first generation x is in the male line; in the second generation it always crosses over to the female line and is dominated by X ; in the third generation it should be equally distributed between the male and female lines. A minus sign (-) indicates the absence of the X or x element.

LITERATURE.

1. BATESON, W. *Mendel's Principles of Heredity*. Cambridge, 1909.
2. DAVENPORT, C. B. *Heredity in Relation to Eugenics*. New York, 1911.
3. GUYER, M. F. "Accessory Chromosomes in Man." *Biol. Bull.* Vol. XIX. 1910.
4. NETTLESHIP, E. "A History of Congenital Stationary Night-blindness in Nine Consecutive Generations." *Ophth. Soc. Trans.* XXVII. 1907.
5. ——. "Three new Pedigrees of Eye Disease." *Ibid.* XXVIII. 1908.

ON STERILE AND HYBRID PHEASANTS.

BY GEOFFREY SMITH, M.A.,

Fellow of New College, Oxford;

AND MRS HAIG THOMAS, F.Z.S.

THE material for this study consists of four abnormal or "mule" pheasants, which on dissection proved to be females with aborted ovaries, and a series of hybrids between Reeve's pheasant and the Japanese pheasant and Formosan variety of the Chinese pheasant bred by Mrs Haig Thomas and handed over to me for histological examination. Mrs Haig Thomas has also put at my disposal some valuable statistics derived from her extensive experiments in breeding hybrid pheasants of various kinds, which throw an interesting light on the disturbance of the sex-ratio through hybridisation. The examination of the plumage of these birds was made by Mrs Haig Thomas, and I have also had access to her records relating to their behaviour, change of plumage, etc., which occurred while they were living in her aviaries. This paper is, therefore, a joint production, in which Mrs Haig Thomas is responsible for the breeding experiments and myself for the theoretical interpretation. The facts brought out by the study of these various sources throw light on three distinct problems which may be treated separately, first, the cause of the sterility of the hybrids in so far as it is elucidated by a histological examination of the reproductive tissues, second, the assumption of partial male plumage by the sterile females and the correlation of this abnormal plumage with atrophy of the ovary, thirdly, the preponderance of males over females in hybrid pheasants and the question as to how far this preponderance is due to a selective death-rate, and at what period the incidence of this selective death-rate occurs.

1. *The cause of the sterility of the hybrids.*

In dealing with some sterile male hybrid pigeons in Part 9 of "Studies in the Experimental Analysis of Sex," *Q. J. M. S.* Vol. LVIII. 1912, it was shown that the point at which the formation of the spermatozoa became abnormal was at the synapsis preceding the first maturation division. It was proved that the chromosomes in this division failed to form the normal synaptic pairs but were distributed unequally on the spindle, and it was also found that in the majority of cases the secondary spermatocytes failed to divide again but went straight on to form spermatozoa of double the normal size, while in some cases deformed spermatozoa with chromatic beads were produced.

Two sterile male pheasant hybrids produced by crossing Reeve's ♀ with *versicolor* ♂ and Reeve's ♀ with Formosan ♂ have been investigated. The birds were killed in June, when the former was rather more than three years old and the latter two, and dissection showed that the reproductive organs were anatomically normal. The vesiculæ seminales of the Reeve's by *versicolor* male were full of spermatozoa, which moved actively when placed on a slide, though the presence of a very large proportion of deformed spermatozoa was at once apparent. In the other male the vesiculæ were empty except for a certain amount of cellular débris which appeared to have resulted from the breaking-down of deformed spermatozoa. Smear preparations of the spermatozoa from the first male, stained with iron-haematoxylin and eosin, brought out a condition of affairs very similar to that which was described for the hybrid pigeons in Part 9, except that in this case there was a much greater preponderance of deformed spermatozoa. On comparing the smear with similar preparations made from some normal male *Phasianus torquatus*, it was apparent that the same irregularity in size of the hybrid's spermatozoa occurs as in the case of the hybrid pigeons. Figs. 1 and 2 on Plate I depict the normal (Fig. 1) and the hybrid spermatozoa (Fig. 2), and it will be seen that many of the latter are about double the normal size, while others are smaller than the normal. In addition to these abnormally sized spermatozoa, a few of the deformed spermatozoa are drawn, but as a matter of fact in this hybrid these deformed spermatozoa are greatly in excess of the rest.

The examination of sections of the testes of the hybrids brought out that, just as in the hybrid pigeons, the spermatogonia are perfectly normal in appearance, but all the subsequent stages show degenerative changes in the nuclei of a more pronounced kind than was found in

the hybrid pigeons (Fig. 3, Plate I). The typical appearance of the testicular tubes is shown in Fig. 3, Plate I, and it will be seen that after the spireme stage of the primary spermatocytes, the cells appear to have fragmented irregularly, and the chromatin in them appears as intensely staining irregular masses which assume branching and beaded threads. These degenerate fragments represent the abnormally shaped spermatozoa which make up the greater number of the spermatozoa found in the vesiculæ seminales, and the method of their formation appears to have consisted in a fragmentation of the spermatocytes after the abortive initiation of the reducing division.

The occurrence in the vesiculæ of a certain number of normally shaped spermatozoa, though mostly of abnormal size, would seem to indicate that a certain number of the primary spermatocytes did divide in a less degenerate manner earlier in the year, but I cannot find any evidence of this occurring in the sections.

It will be seen from this account that degeneration sets in just at the time when the synaptic pairing of the chromosomes should follow the formation of the spireme in the primary spermatocytes, and this agrees with the account given for the hybrid pigeons, except that the degenerative process sets in rather earlier in the case of the hybrid pheasants. This earlier degeneration in the latter case accounts for the far greater proportion of deformed spermatozoa found in the pheasant compared to the pigeon. Besides the two sterile males, three sterile females from the same crosses, viz. two produced by Reeve's ♀ × Formosan ♂ and one by Reeve's ♀ × *versicolor* ♂, were dissected. The Reeve's × Formosan hybrids were rather over two years old, and had never laid eggs; the Reeve's × *versicolor* female was three years old and had likewise never laid.

The Reeve's × *versicolor* female (*M*) did not show any marked assumption of male characters in the plumage, except in the pattern of the interscapulars which showed a trace of the male Reeve's type. There was a very small ovary which however contained some fair-sized oocytes, and the oviduct was small and undeveloped. Unfortunately the ovary of this bird was lost, so that no report can be made on its histological structure. Of the two Reeve's × Formosan females, one, which will be referred to as *B*, showed very slight assumption of Reeve's male pattern in the interscapulars. The ovary consisted of two nodules of tissue about 5 mm. in length, highly vascularised and of a dark red colour. Sections of these nodules showed no trace of oocytes, the whole of the tissue consisting of nests of interstitial cells,

with a good deal of stroma and fibrous tissue (Figs. 4 and 5, Plate I). In places small cysts could be seen surrounded with a fibrous capsule and containing a fatty fluid (Fig. 5, *cy.*, Plate I). In every respect the sections through this degenerate ovary resemble the Figures 19, 33, 34 and 39 given by Prof. Poll for the ovaries of duck hybrids (1).

This bird was otherwise peculiar in that the body was laden with subcutaneous and visceral fat to an extraordinary extent, and also in possessing two very large hypertrophied oviducts.

The second Reeve's \times Formosan female (*G*) showed a very striking assumption of male plumage, both in pattern and colour of the neck, breast, interscapular and tail feathers. The ovary was still more degenerate in structure than in the foregoing, consisting of some minute nodules about 1 mm. across, which showed the same histological structure as the other female. The oviduct in this female was very small and undeveloped. It may be noted that all the sterile females were of an unusually large size, a character which may be regarded as a male one.

The histological structure of the degenerate ovaries of these females agrees in every way with the excellent descriptions which Prof. Poll has given for hybrid ducks; we see the same inability of the oocytes to grow normally, and the consequent composition of the ovary by interstitial, stroma and fibrous cells.

The interesting enquiry, which is not answered by Prof. Poll, is to determine whether the degeneration of the ova can be ascribed to the same cause as that of the spermatozoa, viz. to the inability of the chromosomes to go through the synaptic phases. At first sight such an interpretation seems absurd, since degeneration of the ova occurs in these hybrids long before polar-body formation when the maturation divisions take place. But as I pointed out in a footnote in a previous paper (*Q. J. M. S.* Vol. LVIII. p. 166), there is evidence that in the female sex a precocious temporary synapsis occurs in the young germ-cells before growth of the oocytes begins, and that this may take place in the quite young organism or even in the embryo. Since the publication of the above-mentioned paper, Mr Jenkinson has collected a great deal of information on this point, and it seems clear that in the female sex throughout the animal kingdom this temporary synapsis of the chromosomes in the young oocytes before growth begins is of universal occurrence. Furthermore Mr A. D. Sprunt has worked through the early stages of development of the ovary in the chick (*Gallus*), and he finds that the typical synaptic phases occur in the embryonic ovary

between the seventeenth and nineteenth day of incubation. After synapsis the chromosomes separate and the nuclei pass back into the vegetative phase until polar-body formation. Now it is perfectly clear from the foregoing facts that since in the normal female it is necessary for the oocytes to undergo the synaptic phases before they can store yolk and grow up into mature oocytes, we must conclude that in the case of the sterile hybrids this early synapsis was initiated, but owing to the incompatibility of the chromosomes it failed to take place normally, with the result that the oocytes failed to grow.

The fact, therefore, of this early synapsis in the female germ-cells, gives us a complete explanation of why the germ-cells degenerate in the female at an apparently earlier stage than the germ-cells in the male. In reality the germ-cells begin to degenerate and become abnormal at *exactly the same phase in both male and female hybrids, viz. at the synaptic phase, so that the generalization that the sterility of hybrids is due to the incapacity of the chromosomes derived from two species to form the normal synaptic pairs applies to both sexes of hybrids, and is probably of universal application.*

2. *The assumption of male characters by sterile females.*

The sterile females examined under this head include four Common Pheasants (*A*, *C*, *D* and *E*), which were probably all crosses between *P. torquatus* and *colchicus*; a sterile pure-bred Formosan variety of *P. torquatus* (*K*); a female hybrid between Reeve's ♀ and *versicolor* ♂ (*M*), and two hybrids between Reeve's ♀ and Formosan ♂ (*B* and *G*).

The Common Pheasants *A*, *C*, *D* and *E* will be dealt with first. These were all young birds, shot probably in their first winter, and dissection revealed an identical condition in all of them, viz. entire absence of any visible ovary or gonad of any kind, and the presence of a very small, narrow oviduct on the left side which had its opening into the cloaca occluded, and the other end narrowing down to a fine filament. I was unable to detect any trace of germinal tissue in any of these birds; otherwise they appeared healthy and normal. All four birds showed male characters in the plumage to slightly varying extents. In all of them the neck feathers, both dorsally and ventrally, but especially the former, have a large part of their distal borders metallic green, as in a cock bird. These neck feathers show distinct traces of the white ring characteristic of *P. torquatus* ♂. The feathers of the back are of normal female appearance; and so are the wing

feathers, though in three cases both primaries and secondaries show a slight tendency towards the male pattern. The breast feathers are intermediate in colour between the cock and hen, being of a rufous brown colour with some black patches, and occasional feathers showing the purple and green lustre characteristic of the cock. The tail is of the female type as a whole, but the black bars on the feathers tend to be narrower as in the cock.

A partial assumption of cock's plumage by female pheasants, as above described, appears to be of fairly common occurrence, and it is invariably associated, as far as the evidence goes, with some abnormality of the ovary. Examples of the converse event, namely, the assumption of hen's plumage by the cock, is far rarer, though a few cases have been recorded (Hammond Smith, *The Field*, Feb. 25th, 1911, p. 384), and in these cases the testes of the male show no abnormality or signs of degeneration. In reply to enquiries Mr Hammond Smith writes to me—"My experience is that female birds frequently assume male characters as to plumage, and that this change is as a rule associated with atrophy of the ovary which is often represented by merely a small patch of black pigment. But I have never seen any trace of male internal organs in these birds. This is a very common thing to see, viz., the female assuming the male secondary sexual character. I have seen it in fowls, ducks, grouse and pheasants. My special interest is and has been for years to obtain specimens of the opposite change, namely cocks assuming female characters. This is far more rare, in fact I can only find three instances, one in the *Ibis*, 1897, one in Tring Museum, and the partial change mentioned in Shattock and Seligmann's paper (*Trans. Path. Soc. London*, Vol. LVII. 1906). For eight years I have looked for such a bird, and my friends have also done the same; this winter I have got three specimens. Curiously although in cases of female allopterotism the ovary is abnormal, in these cases of male allopterotism the testes appear to be normal; in each of my three cases the testes have been carefully examined by S. G. Shattock of the College of Surgeons."

A. Brandt (6), writing in 1889, refers to "Arrhenoidie," or the assumption of male plumage by the female, as a common occurrence in various birds, and cites instances among Gallinacei, Passeres, Scansores, Gallatores and Natatores. He remarks also that these cases are always accompanied by ovarian abnormality. The opposite phenomenon, "Thelyidie," or the assumption of female plumage by the male, is, according to Brandt, much rarer, but he is not so clear in regard to these

cases, as he cites as instances some birds with hermaphrodite internal organs which obviously come into a totally different category. On the whole, however, Brandt's evidence agrees essentially with Hammond Smith's and our own. Mrs Haig Thomas on the other hand has in her records a case of a male common pheasant, probably about eight months old, with partial female plumage, in which the testes were exceedingly small, about the size of a six weeks old male chick. It seems to me probable that this was a case of a late-maturing cock bird, in which both male plumage and normal testes would have developed later. My reason for suggesting this is that I have at present a breed of white Leghorn fowls in which the cock birds fall into two classes, those which assume full male plumage, spurs and comb, and which become internally mature about six months after hatching, and those which it is impossible to distinguish from hens for eight months after hatching and which then gradually assume the male characters. The two characters of early-maturing and late-maturing are hereditary characters which appear to segregate in inheritance, but the exact nature of this hereditary transmission has not yet been worked out.

Now if the above arguments are substantiated, it would seem that the appearance of the secondary sexual characters of the opposite sex in the female and in the male bird may be due to two different causes; in the female it appears to be due to atrophy or abnormality of the ovary, and in the male to a transference of the female plumage independently of any abnormality of the testes. The case of the female is, therefore, one of *correlated differentiation*, where the atrophy of the ovary liberates some stimulus for the development of the male characters, while the case of the male is due to *hereditary transference*, where a particular set of female secondary sexual characters are transferred to the male without the structure or function of the testes being affected in any way.

That such hereditary transferences of secondary sexual characters from one sex to the other often occur, without the normal reproductive capacity of the individual being affected, is well known: common instances are the hen-plumage of the Sebright Bantam cocks, and the appearance of spurs in the females of many breeds of fowls. In both these cases the males and females are perfectly normal reproductive individuals; all that has happened to them is the transference in heredity of a particular group of secondary sexual characters which properly belong to the opposite sex.

We must, therefore, clearly distinguish between two entirely

distinct methods by which an individual can assume secondary sexual characters of the opposite sex, (1) by *correlated differentiation*, where the abnormality of the gonad induces the development of characters proper to the other sex, (2) by *hereditary transference*, where the secondary sexual characters are abnormally distributed in heredity without the gonad being affected at all.

It is on the basis of these two main subdivisions that a logical classification of secondary sexual characters, both normal and abnormal, should be founded, but it is not the intention in the present paper to apply the principles of this classification any further than to the facts under consideration. It is clear, at any rate, that the four female "mule" pheasants described above are instances of the first phenomenon, viz., correlated differentiation. Three other instances of this process are afforded by the hybrid females, *M*, *B* and *G*, and the sterile pure-bred female, *K*. The last-named bird, *K*, was a pure-bred Formosan variety of the Chinese pheasant, *P. torquatus*, hatched by Mrs H. T. May from stock obtained from Mr W. Trumperant Potts of Correen Castle, Ballinasloe. This bird was hatched in May 1909, and in September of that year was observed to "feather up" like a cock, and showed rather more of the red face-skin than a normal female. During this year it also developed a few feathers of the male colour on the inner part of the thigh. In July 1910 it began to tread the hens placed with it and was heard to utter the male cry, though no male plumage appeared until October when a few dark feathers were noticed below the bill. These were lost however at the moult. In 1911 the bird again developed male behaviour and at the September moult began to assume male plumage to a marked degree. During October it acquired a brown-tinted flush over the body, wings and tail, dark feathers appeared on the breast, the white collar characteristic of the male of this species appeared, and the throat and neck feathers were of the lustrous green colour found in the male. It was dissected in the summer of 1912, when it showed these characters, and it was found that the ovary was a shrivelled body about six millimetres across, consisting histologically of interstitial and stroma cells with a large invasion of fibrous tissue, but no trace of oocytes at all. The oviduct was in a remarkable condition, being greatly inflamed and hypertrophied, although the bird had never laid.

The other three sterile females were all hybrids. *M* was a hybrid between Reeve's ♀ and *versicolor* ♂. It never laid eggs, and on dissection during the breeding season at three years old, the ovary was

found to be small, though containing some small oocytes; the oviduct was small and comparatively undeveloped. This bird had practically typical female plumage, though the pattern of some of the feathers, e.g. the interscapulars, showed a tendency towards the Reeve's male.

Of the two hybrids between Reeve's ♀ and Formosan ♂, *B* had again typically female plumage with a trace of male pattern in some feathers. The ovary of this bird, at two years old and in the breeding season, was markedly degenerate, there being no oocytes but only interstitial and stroma cells. The genital ducts were peculiar in that there were two oviducts (an abnormality of occasional occurrence in Gallinaceous birds), which showed the same inflammation and hypertrophy as in the sterile female *K*. The other hybrid *G* exhibited a strong assumption of male plumage, green and purple feathers appearing on the back, neck and breast. The ovary in this bird was highly degenerate, consisting of a few minute nodules without any trace of oocytes, and the oviduct was exceedingly small and undeveloped.

Taking all these sterile females together we must observe a considerable variation in the degree to which the secondary sexual characters are altered, and in the degree to which these alterations are correlated with the condition of the gonad.

The females *A*, *C*, *D* and *E* showed absence of ovary associated with very small oviduct and a marked assumption of male plumage. *M* had a small ovary with oocytes, a small oviduct and very slight assumption of male plumage. *B* had a degenerate ovary without oocytes, hypertrophied oviducts and very slight assumption of male plumage. *K* had a degenerate ovary without oocytes, hypertrophied oviducts, and a strong assumption of male plumage. *G* had a degenerate ovary without oocytes, a small oviduct and a strong assumption of male characters. We see therefore that in a female with ovaries degenerate in a marked degree we may find either a small rudimentary oviduct or a greatly hypertrophied one, and we may find a very slight or a highly marked assumption of male plumage, without being able to trace any correspondence in the degree of degeneration of the ovary. Nevertheless the evidence is ample to show that degeneration of the ovary is accompanied by some degree of assumption of male plumage in every case, and by a marked assumption in the majority of cases, and we are warranted in concluding that there is an organic correlation between plumage and ovary in the case of pheasants of such a kind that the presence of a normal functional ovary is necessary for the full development of the female plumage in a female pheasant.

There is a certain amount of experimental evidence on other birds which confirms this result. Thus Guthrie (4) records the case of a hen which assumed cock's plumage after the removal of the ovary, and Goodale (5) observed the development of Drake's plumage in some Ducks from which he had removed the ovaries.

We must suppose that the ovary in a female bird normally exerts an influence on the development of the typical female plumage, but we are not in a position to say how this influence is exerted, whether by means of a specific hormone, or by entering into a chain of metabolic processes and stimulating the production in excess of substances which are formed elsewhere. In previous studies the latter mode of action of the gonad upon the body has been advocated in opposition to the ordinary hormone theory, and it may be suggested that in the cases before us the wide range of variation in the degree to which the secondary sexual characters are altered when the gonad shows no corresponding variations in its degree of degeneracy, points to other organs of the body, in addition to the gonad, taking part in the correlation.

It will be noticed that these cases of assumption of male characters by the female as the result of ovarian degeneracy are the converse of the case of the crabs infected by *Sacculina* where the males under the influence of the parasite assume female characters.

The two cases are not, however, completely parallel, because in the birds we are dealing with a mere suppression of the ovary, while in the crabs it is not merely a suppression of the testis but the active feminising of the *Sacculina* which brings about the changes.

Nevertheless the two cases are parallel, in so far as they prove that certain male secondary sexual characters are latent in the body of the female bird which can be made patent by the removal of the influence of the ovary, and that certain female secondary sexual characters are latent in the body of the male crab which can be called forth by appropriate stimuli.

It would be possible to use these facts in favour of that particular Mendelian theory of sex which looks upon one sex as heterozygous for sex and the other homozygous, and to urge that in Birds the female sex is heterozygous, the male homozygous, and in certain Crustacea the male is heterozygous and the female homozygous. It is certainly a remarkable fact that on the one hand in Birds the assumption of male characters by the female is frequently associated with abnormality of the ovary, while the assumption of female characters by the male is independent of any reproductive abnormality but is due to hereditary

transference; in Crustacea on the other hand the converse is true, viz. that assumption of female characters by the male is generally associated with abnormality of the gonad, while the assumption of male characters by the female is unaccompanied by abnormality of the gonad.

This might be taken to indicate that in Birds the female carries the male primary sexual quality in a latent state which on the removal or abnormality of the ovary comes into activity and stimulates the development of the male secondary sexual characters, while in Crustacea the male carries the female primary sexual quality which on removal or abnormality of the testis or owing to the activity of some special stimulus comes into activity and stimulates the development of the female secondary sexual characters.

Although it would be rash to press this argument, the apparent difference in the reaction of the sexes in Crustacea and Birds would seem to argue a different physiological constitution in respect to the distribution of the primary sexual character to the two sexes. In regard to the distribution of the secondary sexual characters to the two sexes, it appears probable that each sex is carrying the opposite secondary sexual characters in a latent state. This is most clearly proved by Mrs Haig Thomas' hybridising experiments with pheasants where she has been able to prove that the female can transmit to her male offspring the male secondary sexual characters of her species, and also that the male can transmit to his female offspring the female secondary sexual characters of his species. This fact is well illustrated by the hybrid pheasants dealt with in this paper. The detailed evidence, however, cannot be given here but will be described in a separate paper by Mrs Haig Thomas.

3. *The sex-ratio of hybrid pheasants.*

In an interesting paper Guyer (2) has called attention to the preponderance of males over females produced by crossing different varieties among Gallinaceous and other birds. In Part 9 of my studies (3) I alluded to this observation and recorded that as far as my experience went the same preponderance was met with. The following statistics which Mrs Haig Thomas has derived from her extensive experiments in raising hybrid pheasants are of exceptional value, because the sexes of the birds were determined in doubtful cases by dissection, and also a record was kept of the number of infertile eggs, of the number that died in the shell, and in certain cases the sex of the birds that died in the shell was determined. They also include a very

large number of cases, so that the irregularities of chance are ruled out.

The first numbers that will be given refer to the sterile hybrids raised by crossing Reeve's ♀ with males of *P. torquatus*, var. *formosanus*, and *P. versicolor*. The numbers are as follows:—

Total eggs	Infertile and Added	Dead in shell	Sex Totals
99	68	1	6 ♀ 16 ♂

The sex-ratio is here 6 ♀ to 16 ♂ or 266 per cent. of males. The especially interesting point brought out by these figures is the fact that the number of birds which died in the shell is only one, so that the disproportion in the sexes cannot be accounted for by supposing that more female birds died in the shell than males. The cause of the disproportion must be sought for at an earlier stage, either at so early a stage of development that no trace of a developing chick could be detected in the egg, or else at fertilisation itself. In other words the disproportion of the sexes appears to be due not to a selective mortality of the sexes, but to something tantamount to selective fertilisation.

We may now give the total figures relating to all the cross-bred pheasants raised by Mrs Haig Thomas. It must be noted that these cross-bred pheasants were not sterile hybrids in the strict sense of the term though they exhibit a considerable degree of sterility. The crosses were mostly between Silver and Swinhoe Pheasants, and Golden and Amherst, and Formosan and *versicolor*.

Table of Sex-ratios in Hybrid Pheasants.

Year	Total eggs	Infertile and Added	Dead in shell	Sex Totals
1909	544	356	17 2 ♀ 0 ♂	55 ♀ 83 ♂
1910	281	232	12 1 ♀ 3 ♂	17 ♀ 19 ♂
1911	424	306	11 1 ♀ 2 ♂	27 ♀ 63 ♂
1912	273	117	12	36 ♀ 63 ♂
Totals	1522	1011	52 4 ♀ 5 ♂	135 ♀ 228 ♂

Note. The death-rate of hatched birds from 1909—1912 was 143 males to 55 females thus showing a preponderance of deaths among males. 96 out of the total 1522 eggs were not incubated.

The sex-ratio is here 135 ♀ to 228 ♂ or 168 per cent. of males. This percentage represents a considerable drop from that obtained from

the perfectly sterile hybrids, but nevertheless the preponderance of males is striking enough.

Now by referring to the column Dead in shell, it will be seen that 52 chicks died in the shell, and on the supposition that all these were females it would bring the total number of females up to 191, which is still considerably below the total number of males, viz. 238. But in a few cases the sex of the birds dead in the shell was determined and in four cases the sex was female and in five male. There is therefore no reason for supposing that the 52 chicks dead in the shell were all females; on the contrary as far as the few figures go there is a slight preponderance of males. Taking this result in conjunction with the result obtained from the first series of figures, it is clear that a selective death-rate during development, at any rate after the rudiment of the chick is visible, does not occur. The cause of the disproportion of the sexes must be sought in the 1011 eggs out of 1426 which were either not fertilised or else ceased to develop at so early a stage that no trace of a blastoderm or chick could be detected. If we accept the theory which at the present time has the largest number of supporters, that sex is determined at fertilisation by the nature of the gametes that make up the zygote, we must suppose that in these cases of hybridism successful fertilisation occurs most frequently between gametes which will form a male zygote than between those which will form a female. This is equivalent to selective fertilisation, and the facts recorded certainly constitute very strong evidence in favour of this process occurring, a process which has often been suggested as a possibility though never directly proved.

SUMMARY.

1. Evidence is brought forward to show that the sterility of the male and female hybrid pheasants is due to abnormalities occurring at the synapsis stage of the reduction division.

2. The spermatozoa of the hybrids are either deformed, with chromatic beads and thickenings on them, or else of abnormal size, double-sized spermatozoa being of frequent occurrence as in hybrid pigeons. The oocytes in the hybrid females fail to grow owing, probably, to the early synapsis which should take place in the 19 day old embryo having gone wrong.

3. Partial assumption of cock's plumage by the female as the result of ovarian degeneration is shown to be of fairly common occurrence. The oviduct in these cases may be either atrophied or greatly

hypertrophied. Assumption of hen's plumage by the cock bird is much rarer and is generally due to hereditary transference of this character independently of any disturbance of the testes or the reproductive function.

4. The sex-ratio among hybrid pheasants gives a large preponderance of males over females (228 ♂ to 135 ♀). This preponderance cannot be accounted for by a greater death-rate of female chicks in the shell or subsequently, and must be presumably due to a selective fertilisation by which more male zygotes are produced than female, or else to a selective death-rate at so early a stage of development that no trace of an embryo could be detected.

EXPLANATION OF PLATE I.

[All the figures are drawn with the camera under a 4 eyepiece and $\frac{1}{2}$ objective.
Magnification about 1270.]

- Fig. 1. Six spermatozoa of normal common pheasant. (*P. torquatus*.)
 Fig. 2. Specimens of spermatozoa of hybrid Reeve's ♀ by *versicolor* ♂. They show abnormality of size, and deformity of shape in some cases.
 Fig. 3. Section of testis tubule of hybrid Reeve's ♀ by *versicolor* ♂. *Spg.* spermatogonia. *Sp.* 1, primary spermatocytes showing abnormal spireme stage. *Sp.* secondary spermatocytes, spermatids and spermatozoa all showing a high degree of abnormality and degeneration.
 Fig. 4. Section through an outer part of degenerate ovary of hybrid Reeve's ♀ by Formosan ♂ (hybrid *B*). *Ep.* external epithelium. *i.* a group of interstitial cells.
 Fig. 5. Section through an inner part of degenerate ovary of *B*. *i.* group of interstitial cells. *f.* fibrous tissue. *cy.* a cyst.

LIST OF LITERATURE.

1. HEINRICH POLL. "Mischlingstudien, VI." *Archiv f. Mikroskopische Anatomie*, Bd. 78, 1911.
2. GUYER, M. F. "On the Sex of Hybrid Birds," *Biological Bulletin*, Vol. XVI. 1909, p. 193.
3. SMITH, G. "Studies in the Experimental Analysis of Sex. Part 9. On Spermatogenesis and the Formation of Giant Spermatozoa in Hybrid Pigeons." *Q. J. M. S.* Vol. LVIII. 1912.
4. GUTHRIE, C. G. *Journal of Experimental Medicine*, Vol. XII. p. 269, 1910.
5. GOODALE, H. *Biological Bulletin*, Vol. XX. 1910.
6. BRANDT, A. *Zeitschrift f. Wiss. Zool.* Vol. XLVIII. p. 101, 1889

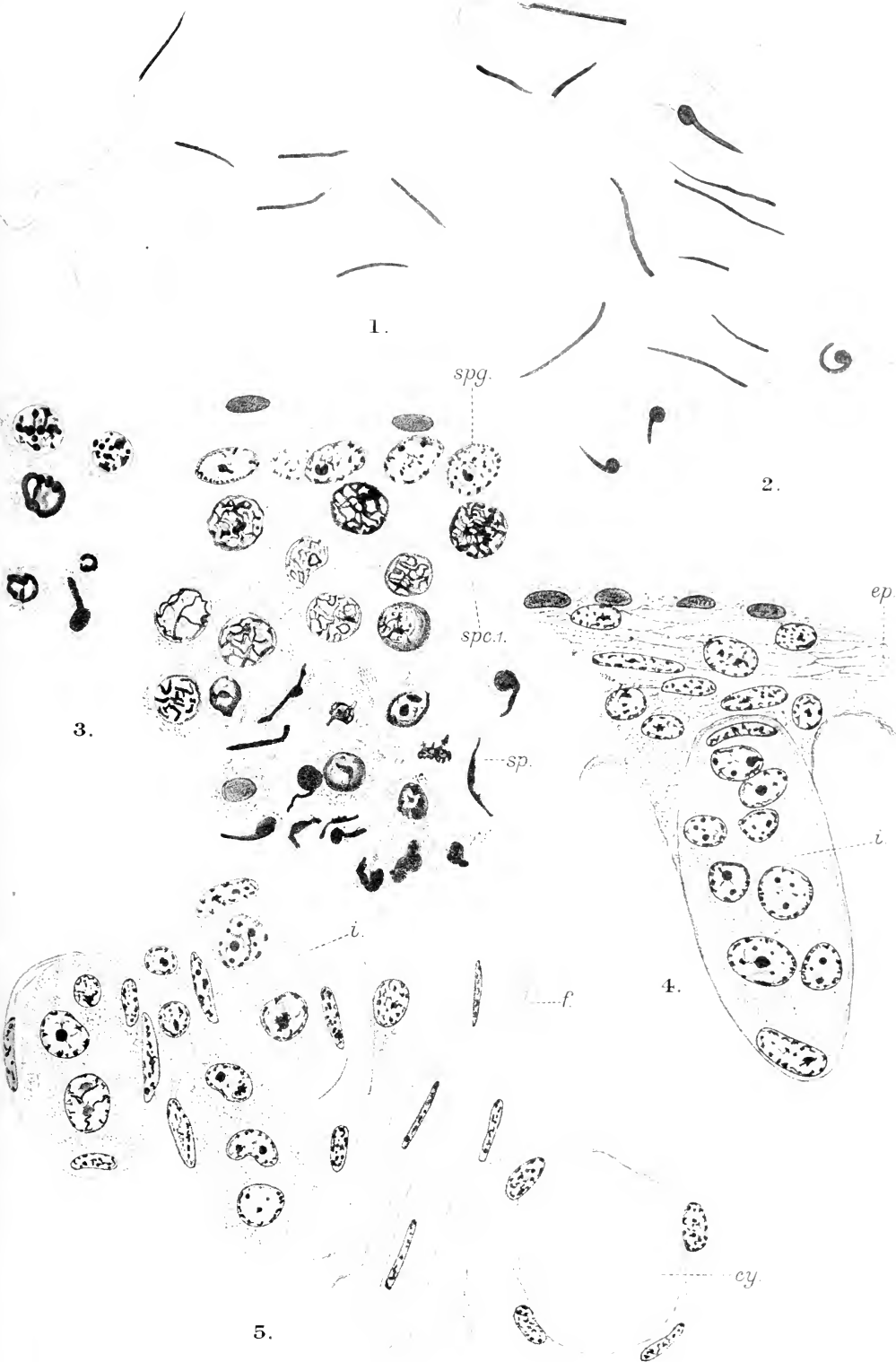

PRELIMINARY NOTE ON HETEROSTYLISM IN OXALIS AND LYTHRUM.

BY N. BARLOW.

THE following paper deals with the heredity of the three forms in trimorphic heterostyled plants. The work is far from complete, but is perhaps worth publishing as the numbers obtained are large, and certain definite conclusions have already been reached. No factorial interpretation of the results, however, has at present been devised.

Both Darwin (1) and Hildebrand (2) worked at the descent of the three forms in trimorphic species, but in Darwin's case only as a side issue. Moreover their numbers are not in agreement, and, with the exception of Darwin's self-fertilized Lythrums, the results are no great help to us at present.

Bateson and Gregory (3) have shown that dimorphism in *Primula* is a case of simple Mendelian inheritance. The long-styled plants are always recessives (RR), whereas the short-styled plants are either homozygous for the dominant short style (DD), or heterozygous, containing both D and R . The unions therefore between long- and short-styled plants can be of two kinds; the F_1 will either consist of short-styled plants only, or there will be equality of longs and shorts.

In dealing with trimorphism, there is apparently a much greater degree of complexity than might be expected in the light of these simple results obtained for dimorphic species.

The three forms within each trimorphic species only differ from one another in the developement of their sexual organs, and in the size and sometimes in the colour of the male sexual cells themselves. Each individual has two distinct sets of male organs, and one female organ, arranged in three tiers. Thus each of the females of the three different types can be pollinated by six perfectly distinct males,

making eighteen possible pollinations within the species, of which six are self- and twelve cross-fertilizations. The six self-fertilizations are always partially or quite sterile. The six "illegitimate" cross-fertilizations (♀ and ♂ of different tiers) are likewise infertile, and only the six "legitimate" unions are fully fertile. This partial sterility is a great obstacle in determining the gametic constitution of individuals, as selfed seed is difficult to obtain in any quantity and difficult to raise; nor can the "illegitimate" unions be relied on to produce sufficient seed.

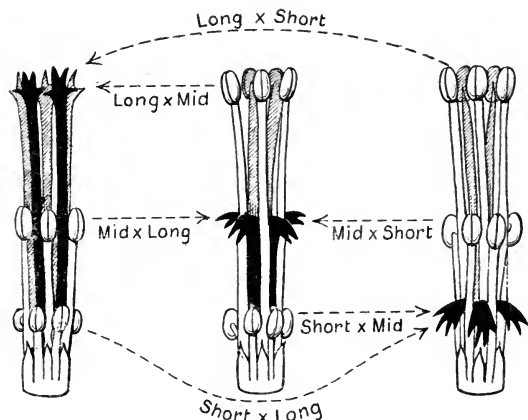

Fig. 1. Showing the arrangement of the styles and stamens in Long-, Mid-, and Short-styled plants. The connecting dotted lines indicate the six "legitimate" forms of union.

Sterility must prove to be an integral part of the problem when it is fully worked out. The relation to the main issue, however, still remains obscure.

It is significant that the three forms have different average degrees of fertility even when producing their fullest complement of seed. The relative numbers of seeds in *Lythrum salicaria* can be given as follows: Long-styled 100; Mid-styled 130; Short-styled 81. (Darwin, *Forms of Flowers*, p. 143.) Also the different degrees of sterility in different self-fertilizations and "illegitimate unions" seem constant. Again, the mid-styled form is more productive than the other two; but not equally so for all illegitimate unions. Thus Darwin got as many as 69.5 seeds per capsule in the cross Mid-styled \times long stamens of Short-styled, but on the other hand not a single seed for Mid \times own from short stamens.

The fact that the two sets of pollen on one plant behave differently towards the same female shows a segregation in the individual of the factor (or absence of factor) causing incompatibility¹. This constitutes a marked difference between heterostyled plants and such self-sterile species as *Linaria vulgaris* (de Vries (4)) and *Cardamine* (Correns (5)).

Oxalis valdiviana was selected for experiment, owing to its annual habit and its long flowering period. This plant has a very high degree of self-sterility, and it was found difficult to proceed with it alone. *Lythrum salicaria* has been found to be more self-fertile (C. D., *Forms of Flowers*); also the normal capsules set over 80 seeds, whereas in *Oxalis* there are only from 10 to 15. Experiments were started on this species in 1911 so that we have as yet only the F_1 .

The plants were obtained from the Cambridge Botanic Gardens, and from wild seed. Two plants of the variety *rosea*, growing in the Chelsea Physic Garden, were also used.

OXALIS VALDIVIANA.

Procedure.

In 1907 four long-, four mid-, and four short-styled plants were chosen from self-sown garden plants. All families subsequently raised are derived from these twelve original parents.

During the summers of 1907, 1908 and 1909 the plants were kept under wire cages covered with muslin; or each flower-head was separately covered with a paper bag. No crosses were made in 1910. In 1911 and in 1912 the plants used were either isolated in bee-proof greenhouse partitions or covered with paper bags. Bees visit this plant very freely. It was sometimes difficult to frustrate their persistent attempts to get at flowers temporarily uncovered for artificial fertilization. Insect visits may be a cause of irregularity in the results, and will be referred to later, with other possible causes of error.

Owing to the violent expulsion of ripe seed, each capsule has to be separately covered with fine muslin before it reaches maturity.

The immature anthers were removed from the females used for crossing in 1907. In subsequent years castration was not thought

¹ A flower of the short-styled *Oxalis valdiviana* was observed to have one of the mid length tier of stamens at the level of the long stamens. The pollen from this aberrant stamen was carefully tested on a long- and on a mid-styled plant, and was found to behave exactly as "long" pollen. The length factor of the stamen is bound up with the inhibitory effect of the pollen; the abnormal growth of this stamen had brought with it the inhibition of its pollen for a mid-styled plant.

Heterostylism in Oxalis

necessary, owing to the degree of self-sterility. The risk incurred was slight, and will be referred to later. In mid and short females, however, the tiers of ripe anthers above the level of the stigma were always carefully removed before the foreign pollen was administered. In the controls for this procedure no seed set. In male parents pollen at a higher level than that used was removed in a similar manner.

Unless otherwise stated, the cross denoted by "Long \times Mid," "Mid \times Short," etc., is the fertile cross between the two forms, that is, Long-styled $\text{♀} \times$ pollen from long stamens of Mid-styled; or Mid-styled $\text{♀} \times$ pollen from mid stamens of Short-styled, etc.

Results.

Four generations have been raised. The results of the crosses Long \times Mid, and Long \times Short, in the four years, together with their reciprocals, are given in Table I and Table II.

TABLE I.

Oxalis valdiviana.

	Long-styled female \times Mid-styled male			Mid-styled female \times Long-styled male		
	Longs	Mids	Shorts	Longs	Mids	Shorts
1908	6	2	0	5	4	0
1909	78	68	0	50	52	4
1910	31	45	0	140	137	2
1912	23	22	0	14	12	0
Totals	138	137	0	209	205	6

Reciprocals added together:—

	Longs	Mids	Shorts
	138	137	0
	209	205	6
Totals	347	342	6

TABLE II.

Oxalis valdiviana.

	Long-styled female \times Short-styled male			Short-styled female \times Long-styled male		
	Longs	Mids	Shorts	Longs	Mids	Shorts
1908	10	0	9	28	3	22
1909	50	3	38	52	6	68
1910	138	0	135	63	0	58
1912	5	0	9	8	0	8
Totals	203	3	191	151	9	156

Reciprocals added together:—

	Longs	Mids	Shorts
	203	3	191
	151	9	156
Totals	354	12	347

A long crossed with the legitimate pollen of a mid, or reciprocally, gives equality of the parental forms, with the occasional presence of the third non-parental type. Amongst a progeny of 695, the short-styled form occurs 6 times, or 1 per 117. Whether this is due to possible causes of error, or has a real significance, I do not at present feel qualified to say, though I incline to the latter opinion.

Again, a long crossed legitimately with a short, and reciprocally, gives a predominance of the parental forms, with the mid-styled plant occurring 12 times in a total of 713, or 1 per 59.

The crosses between mid-styled plants and short-styled plants give an entirely different result. No regularity is visible if the numbers are given in an unanalysed tabular form.

TABLE III.

	Mid-styled female × Short-styled male			Short-styled female × Mid-styled male		
	Longs	Mids	Shorts	Longs	Mids	Shorts
1908	3	4	3	4	2	12
1909	17	10	28	16	16	24
1910	44	100	174	103	136	246
1912	82	241	341	95	241	276
Totals	146	355	546	218	395	558

ANALYSIS OF F_3 MID × SHORT AND SHORT × MID, FLOWERING 1910.

In Table IV, the first group is the addition of all cases where there is at least one Long-styled plant amongst the four grandparents. We get 118 Longs : 121 Mids : 270 Shorts—a possible approximation to the ratio 1 : 1 : 2.

In the second and third groups there is complete absence of grand-parental Longs. The second gives 23 : 23 : 49—probably the 1 : 1 : 2 ratio. But the third group gives Mids and Shorts equally, with an occasional Long, the numbers being 6 : 102 : 101.

Clearly all Mids, or all Shorts, are not similarly constituted. The above families do not give clear evidence as to which form brings in the difference. There are certainly two, and probably more than two,

Heterostylism in Oxalis

different types of Mid-styled plant, and possibly two different types of Short-styled plant. We get clear evidence for different Mids in the 1912 numbers to follow. But in Table IV, if we consider cross 31 and its reciprocal 32, we get 65 Longs : 59 Mids : 130 Shorts. In cross 33 and its reciprocal 34, where the same individual Mid parent is used, we get 19 Longs : 18 Mids : 87 Shorts. This may be taken as doubtful evidence for a second type of Short-styled plant.

TABLE IV.

O. valdiviana F₃.

The letters in brackets show the extraction of the parents.

Cross Number	Parents	Longs	Mids	Shorts	
	♀	♂			
31	<i>a</i> Mid (<i>L</i> × <i>M</i>)	× Short (<i>L</i> × <i>S</i>)	28	23	52
33	<i>b</i> Mid (<i>L</i> × <i>M</i>)	× Short (<i>S</i> × <i>L</i>)	11	8	50
32	<i>a</i> Short (<i>L</i> × <i>S</i>)	× Mid (<i>L</i> × <i>M</i>)	37	36	78
34	<i>b</i> Short (<i>S</i> × <i>L</i>)	× Mid (<i>L</i> × <i>M</i>)	8	10	37
37	Short (<i>L</i> × <i>S</i>)	× Mid (<i>M</i> × <i>L</i>)	12	13	14
70	Short (<i>S</i> × <i>L</i>)	× Mid (<i>L</i> × <i>M</i>)	19	20	25
71	Short (<i>M</i> × <i>S</i>)	× Mid (<i>L</i> × <i>M</i>)	3	0	0
72	Short (<i>M</i> × <i>S</i>)	× Mid (<i>L</i> × <i>M</i>)	0	3	2
75	Short (<i>M</i> × <i>S</i>)	× Mid (<i>L</i> × <i>M</i>)	0	8	12
	Totals	...	118	121	270
41	<i>c</i> Mid (<i>M</i> × <i>S</i>)	× Short (<i>M</i> × <i>S</i>)	2	4	6
1	<i>c</i> Short (<i>M</i> × <i>S</i>)	× Mid (<i>M</i> × <i>S</i>)	17	16	37
15	Short (<i>M</i> × <i>S</i>)	× Mid (<i>M</i> × <i>S</i>)	4	3	6
	Totals	...	23	23	49
9 and 10	Mid (<i>M</i> × <i>S</i>)	× Short (<i>M</i> × <i>S</i>)	2	28	29
28	Mid (<i>M</i> × <i>S</i>)	× Short (<i>M</i> × <i>S</i>)	1	19	18
44	Mid (<i>M</i> × <i>S</i>)	× Short (<i>M</i> × <i>S</i>)	0	22	16
17	Mid (<i>M</i> × <i>S</i>)	× Short (<i>M</i> × <i>S</i>)	0	6	3
7	Short (<i>M</i> × <i>S</i>)	× Mid (<i>M</i> × <i>S</i>)	1	7	7
8 and 11	Short (<i>M</i> × <i>S</i>)	× Mid (<i>M</i> × <i>S</i>)	2	20	28
	Totals	...	6	102	101

The small letters show reciprocal crosses.

ANALYSIS OF *F₄* MID × SHORT AND SHORT × MID, FLOWERING 1912.

Unfortunately the *F₃* parents for the *F₄* generation were chance survivors through the winter of 1910. There remained in 1911 three Short-styled plants and seven Mid-styled plants to carry on

the race, besides some Longs. Moreover these ten plants were not all in the same place, and certain crosses, which might have been elucidating, were thus precluded.

TABLE V.

O. valdiviana F_4 .

Cross Number	Parents		Longs	Mids	Shorts	
	Mid ♀	Short ♂				
10	9/2 ($M \times S$)	\times 9/1 ($M \times S$)	0	30	34	
11	9/3 ($M \times S$)	\times 9/1 ($M \times S$)	0	30	24	
12	9/2 ($M \times S$)	\times 70/5 ($M \times S$)	0	24	23	
13	9/3 ($M \times S$)	\times 70/5 ($M \times S$)	0	40	32	
	Totals	...	0	124	113	= A
16	70/2 ($M \times S$)	\times 70/1 ($M \times S$)	1	17	34	
17	70/3 ($M \times S$)	\times 70/1 ($M \times S$)	1	27	36	
18	70/4 b ($M \times S$)	\times 70/1 ($M \times S$)	0	6	17	
	Totals	...	2	50	87	= B
14	70/4 ($M \times S$)	\times 9/1 ($M \times S$)	8	8	8	
19	70/4 ($M \times S$)	\times 70/5 ($M \times S$)	43	30	72	
	Totals	...	51	38	80	= C
20	37/1 ($M \times S$)	\times 9/1 ($M \times S$)	10	17	29	
15	37/1 ($M \times S$)	\times 70/5 ($M \times S$)	17	11	29	
	Totals	...	27	28	58	= D
	Short ♀	Mid ♂				
1	9/1 ($M \times S$)	\times 9/2 ($M \times S$)	0	28	25	
2	9/1 ($M \times S$)	\times 9/3 ($M \times S$)	0	4	4	
3	70/5 ($M \times S$)	\times 9/3 ($M \times S$)	0	43	39	
4	70/5 ($M \times S$)	\times 9/2 ($M \times S$)	0	33	21	
	Totals	...	0	108	89	= A'
7	70/1 ($M \times S$)	\times 70/2 ($M \times S$)	3	18	15	
8	70/1 ($M \times S$)	\times 70/3 ($M \times S$)	0	26	26	
9	70/1 ($M \times S$)	\times 70/4 b ($M \times S$)	0	9	3	
	Totals	...	3	53	44	= B'
6	70/5 ($M \times S$)	\times 70/4 ($M \times S$)	84	76	133	= C'
5	70/5 ($M \times S$)	\times 37/1 ($M \times S$)	8	4	10	= D'

A and A' = reciprocals.
 B and B' = ,,
 etc.

These figures increase our knowledge on certain points.

(1) There is no evidence against the supposition that male and female gametes of a plant are carrying the same qualities. Compare *A* and *A'* etc. In the four groups *A—D* there is good agreement with their reciprocals *A'—D'*.

Note, however, the excess of Shorts in *B*, and the excess of Mids in *B'*.

(2) Two of the three Shorts used are similar in constitution (9/1 and 70/5). It was not possible to cross the third Short with any of the Mids used with 9/1 and 70/5, so no comparison can be made.

(3) The seven Mids used can be classed according to their offspring when crossed with the same Short.

Four different Mids were used with the Short 9/1;—giving:

0 Longs	: 28 Mids	: 25 Shorts	Cross 1	Mid-parent 9/2
0	": 30 "	: 24 "	" 11	" 9/3
8	": 8 "	: 8 "	" 14	" 70/4
10	": 17 "	: 29 "	" 20	" 37/1

Again these four Mids were crossed with the Short 70/5;—giving:

0 Longs	: 33 Mids	: 21 Shorts	Cross 4	Mid-parent 9/2
0	": 43 "	: 39 "	" 3	" 9/3
84	": 76 "	: 133 "	" 6	" 70/4
8	": 4 "	: 10 "	" 5	" 37/1

Clearly the Mid-parents 9/2 and 9/3 are similar, and differ in constitution from 70/4 and 37/1.

In the case of the remaining three Mids used as parents for the *F*₄ generation, there is no comparative evidence on their conformity with one or other of the above classes, or on the possibility of their representing a third type of Mid-styled plant.

TABLE VI.

Showing the ratios given by the four Mid-parents crossed with two similarly constituted Shorts; and of the three remaining Mid-parents crossed with Shorts of unknown constitution.

Mid-Parent	Longs	Mids	Shorts
9/2	0	115	103
9/3	0	117	99
70/4	135	114	213
37/1	35	32	68
70/2	4	35	49
70/3	1	53	62
70/4 <i>b</i>	0	15	20

Self-Fertilizations and Illegitimate Crosses.

Most of such fertilizations have failed. Over 250 have been attempted, from which 87 plants have been raised.

	Longs	Mids	Shorts
Long-styled × own mid pollen (3 plants) ...	46	0	0
Long-styled × own mid + short pollen ...	12	0	0
Totals	58	0	0
Mid-styled × own long + short pollen ...	{ 3	5	3
	{ 0	4	0
Mid-styled × long pollen of different Mid ...	3	1	0
Mid-styled × short pollen of different Mid ...	1	0	0
Short-styled × own mid pollen ...	0	0	4
Short-styled × mid pollen of different Short ...	0	0	2
Short-styled × own mid + long pollen ...	0	0	3

Table VII shows the result of all the self- or illegitimately-fertilized capsules, together with the germination of the seed.

TABLE VII.

Year	Parents		Flowers fertilized	Capsules setting	Seeds	Germinations	Giving		
	Female	Male					Longs	Mids	Shorts
1907 and 9	<i>L</i> × <i>mL</i> [6] ¹		45	11	60+	46	46	0	0
1907 and 9	<i>L</i> × <i>sL</i> [8]		15	0	0	0	—	—	—
1908 and 9	<i>L</i> × <i>m</i> + <i>sL</i> [3]		12+	4+	64	12	12	0	0
1907	<i>L</i> × <i>sM</i> [5]		5	0	0	0	—	—	—
1907	<i>L</i> × <i>mS</i> [5]		5	0	0	0	—	—	—
1907 and 9	<i>M</i> × <i>lM</i> ² [11]		46	4	20	4	3	1	0
1907 and 9	<i>M</i> × <i>sM</i> ² [11]		24	1	1	1	1	0	0
1908 and 11	<i>M</i> × <i>l</i> + <i>sM</i> [3]		many	6	16	{ 11	3	5	3
						{ 4	0	4	0
1907	<i>M</i> × <i>sL</i> [5]		5	0	0	0	—	—	—
1907 and 9	<i>S</i> × <i>lS</i> [11]		20	0	0	0	—	—	—
1907 and 9	<i>S</i> × <i>mS</i> ² [12]		49+	4	7	6	0	0	6
1909 and 12	<i>S</i> × <i>l</i> + <i>mS</i> [4]		14+ many	4	7	2	0	0	5
1907	<i>S</i> × <i>mL</i> [4]		4	1	3	1	0	0	1
1907	<i>S</i> × <i>lM</i> [5]		5	0	0	0	—	—	—

¹ All the Mids, two of the Longs, and one of the Shorts which successfully produced seed, had a common Mid ancestor which seemed to be more capable of producing selfed seed than the others. See also Table VIII where the descent is from the same Mid-styled plant. The numbers in brackets after the parentage show the number of ♀ parents used.

² The pollen from another individual of the same type.

Procedure and Possible Sources of Error.

As has been already stated, the flowers were not castrated before use, except in the year 1907. The danger incurred can be gathered from the following facts.

During the five summers of 1907, 1908, 1909, 1911 and 1912 the total number of capsules setting on covered but untouched flowers amounted to 14, of which none were on Long-styled plants, eleven on Mid-styled plants, and three on Short-styled plants. Such capsules may either arise through some insect introducing foreign pollen or from a true spontaneous self-fertilization. Also, aphids were present on some of the plants. But these insects would probably act as self- and not as cross-fertilizing agents, owing to their stationary habits.

It seems probable that these fourteen capsules did not arise from any outside pollen having reached the stigmas, from the fact that they were all formed on Mid- and Short-styled plants. The protruding Long-styles would be most subject to the contact of any intruder, but no capsules have arisen on untouched Long-styled plants.

As will be seen from the details in Table VIII these capsules set very few seed, and less than half of these germinated. Also it must be remembered that these fourteen capsules occurred amongst many hundreds of flowers which opened each year under cover but were not used.

TABLE VIII.

Capsules setting seed spontaneously.

Year	Type of Parent	Number of capsules	Number of seeds	Number of Germinations	Giving		
					Longs	Mids	Shorts
1907	Mid (1 plant) ¹	4	10	2	1	1	0
1908	Mid (1 plant)	4	27	15	7	8	0
1909	—	0	0	0	—	—	—
1911	Mid (1 plant)	3	8	4	0	4	0
	Short (1 plant)	3	6	3	0	0	3
1912	Mid (1 plant)	2	2	—	—	—	—

To return to the rare appearance of the third form amongst the offspring of a fertile Long × Mid and Long × Short cross. The question arises: Can these be accounted for by the introduction of a few of the mother's pollen grains? Where a Long-styled plant is mother, this is clearly not the case, as self-fertilized Longs give Longs only. (See also *Lythrum*, below.) But three Mids have appeared in

¹ The Mid-plant of 1907 was an ancestor of all the subsequent individuals setting spontaneous seed. There may be self-setting strains. See also Table VII.

a Long ♀ × Short ♂ cross. If this is an error, therefore, it must be due to foreign pollen or seed in the soil.

In crosses with Longs as fathers, and Mid or Short mothers, there is nothing conclusive to show that the non-parental type has not arisen from the mother's pollen-grains reaching the stigma. But in Table VIII the Mid-plants setting seed have not given rise to a Short, nor have the Short-styled plants given rise to a Mid. But the numbers are few, and the evidence rather negative than positive.

Referring to Tables I and II, we see that the year 1909 gives the largest number of these possible errors. In this year I have great suspicion of the earth used for sowing, as in four separate cases one or two more plants came up in the pots than the number of seeds sown warranted¹.

But putting aside all the results of 1909, we are still left with one case in 1908 and another in 1910. Whether these rare appearances must be regarded as accidental introductions, or as a vital part of the problem, must still remain in doubt.

LYTHRUM SALICARIA.

Only the F_1 has so far been raised from this plant.

TABLE IX.

Long-styled female × Mid-styled male			Mid-styled female × Long-styled male		
Longs	Mids	Shorts	Longs	Mids	Shorts
6	5	0	93	84	0
Long-styled female × Short-styled male			Short-styled female × Long-styled male		
50	0	46	123	0	103
8 ²	12 ²	7 ²			
Mid-styled female × Short-styled male			Short-styled female × Mid-styled male		
53	63	145	71	56	162

Longs and Mids crossed together give only the two parental forms in a total of 188.

¹ None of these four cases coincided with a family in which the non-parental form made its appearance.

² This cross is under suspicion. The flower spikes were covered either by paper bags or by muslin. The muslin was found to be an insufficient protection, as several times bees were seen crawling on the surface, whilst the flowers inside were so near that it might have been possible for them to receive foreign pollen from part of the bee's body. The above case was from a muslin covered spike. All plants selected for further generations were from paper-covered spikes.

Heterostylism in Oxalis

Longs by Shorts or Shorts by Longs, with the exception of the one case already noted, give only Longs and Shorts in a total offspring of 322.

Mids by Shorts and Shorts by Mids throw all three forms in numbers not explicable at present.

There is no case of the third non-parental type occurring occasionally as in *Oxalis*.

The self-fertilizations have mostly failed, chiefly owing to the lateness of the season when they were attempted.

Parents		Longs	Mids	Shorts
Female	Male			
$M \times \text{own } l+s$		0	3	0
$S \times \text{own } l+m$		1	1	8

Darwin's numbers for self- and illegitimate-fertilizations are added.

Parents		Longs	Mids	Shorts
Female	Male			
$L \times m+sL$		8	0	0
$L \times \text{own } m+s$		48	0	0
$M \times \text{own } l+s$		1	3	0
$M \times sL$		17	8	0
$M \times lS$		14	8	18
$S \times \text{own } l+m$		1	0	8
$S \times mL$		4	0	8

There seems little doubt that in *Lythrum* and in *Oxalis*, as in the dimorphic *Primula*, the Long-styled form is the recessive, and can only give Longs.

Summary.

1. Reciprocals have always given like results. That is, there is no evidence that the ♂ and ♀ gametes carry different characters.

2. Long-styled plants selfed give Longs only. Long is the pure recessive, as in *Primula*.

3. There are certainly two differently constituted Mid-styled *Oxalis*, giving different ratios with the same Short. One gives no Longs at all, and the other gives Longs in equality with the Mids. Self-fertilizations can give Longs as well as Mids, and once in *Oxalis* all three forms have appeared. There is no comparative evidence on the result of self-fertilizing the two different types of Mid-styled plant.

4. There is doubtful evidence of a second type of Short-styled plant, which gives a ratio approximating to 1 Long : 1 Mid : 8 Shorts; whereas the usual ratio with the same individual Mid is fairly near 1 Long : 1 Mid : 2 Shorts. Self-fertilized Shorts in *Oxalis* have produced Shorts only, but in *Lythrum* one of both the other forms appeared in a family of ten.

5. A further well-established ratio in a $M \times S$ cross is

$$1 \text{ Long} : n \text{ Mid} : n \text{ Short,}$$

where n is a number between 13 and 34. This indicates the presence of yet a third type of Mid or Short, but no comparative evidence is available.

The work was undertaken at Mr Bateson's suggestion, and I wish to express my thanks for his help and encouragement, and for the facilities which I have enjoyed at the John Innes Horticultural Institution during the last two years.

REFERENCES.

- (1) DARWIN, C. *Different Forms of Flowers on Plants of the same Species*.
- (2) HILDEBRAND, F. *Bot. Zeitung*, 1864, p. 2; 1871, pp. 416 and 432; 1887, pp. 1, 17, and 33.
Monatsberichte d. Akad. d. Wissen. zu Berlin, 1866, p. 371.
Lebensverhältnisse der Oxalisarten. Jena, 1884.
- (3) BATESON and GREGORY. *Proceedings of the Royal Society*, B. 1905, p. 581.
- (4) DE VRIES. *Species and Varieties*, p. 471.
- (5) CORRENS, *Festschrift der medicin-naturw. Gesellschaft zur 84. Vers. deutscher Naturforscher und Ärzte*, 1912.



SUR UNE RACE DE BLÉ NAIN INFIXABLE.

By PHILIPPE DE VILMORIN.

LE cas que je me propose d'examiner est celui d'un froment (*Triticum sativum*) issu d'une race cultivée et fixée, semblable par tous ses caractères à cette race, et infixable au point de vue de la diminution de la taille. Cette expérience a été poursuivie pendant de nombreuses années et, d'ailleurs, le même phénomène s'est présenté dans deux variétés différentes.

1°. BESELER'S BROWN CLUB HEAD.

Cette variété, comme aussi celle que nous étudierons plus loin, se fait remarquer par un épi carré et très compact.

1905. Parmi une centaine de plantes du type ordinaire qui est de taille élevée variant suivant les années de 1 m. 50 à 1 m. 70, j'ai trouvé une seule plante n'ayant que 80 centimètres de hauteur. Il a été semé 10 grains de cette plante naine dont 7 sont arrivés à complet développement, la proportion a été de 6 individus nains pour un grand. Une plante naine a été conservée.

1907. 10 grains de cette plante donnent 8 nains et 2 grands. Une plante est conservée. La même année j'ai fait, d'autre part, une expérience sur une plus grande échelle semant environ 300 grains provenant tous de plantes naines de 1906. 271 plantes se sont développées dont 207 naines et 64 grandes. Parmi les plantes naines, 4 ont été conservées.

1908. Ces 4 plantes ont donné les résultats suivants :

1°	50	naines	et	21	grandes
2°	55	„		21	„
3°	57	„		27	„
4°	44	„		20	„

Soit au total 206 naines et 89 grandes.

Cette expérience a été abandonnée au profit de la suivante en présence de la nécessité d'opérer sur de grandes quantités et de ne pas multiplier les lots.

2°. SHIRNO.

A. *Famille blanche.*

Cette variété qui n'existe pas en dehors de Verrières provient d'un croisement fait en 1886. Elle est parfaitement fixée et elle est, comme la précédente, caractérisée par son épi court et carré. Sa taille normale varie suivant les années de 1 m. 20 à 1 m. 40.

1902. Sur 675 plantes on remarque une plante naine de 1 mètre qui est conservée.

1903. On trouve 147 plantes naines et 80 grandes.

1904. Le semis a été fait avec les grains mélangés de plusieurs plantes naines ou paraissant naines, conservées l'année précédente ; ces grains donnent 177 plantes naines et 116 grandes.

1905. Le semis se fait dans les mêmes conditions que 1904, c'est-à-dire avec des plantes en mélange. On trouve 85 naines et 196 grandes.

1906. Semis dans les mêmes conditions : 238 naines et 95 grandes.

1907. Semis dans les mêmes conditions : 197 naines et 88 grandes.

Je n'hésite pas à avouer que cette façon de procéder qui consiste à ne pas suivre individuellement chacune des plantes choisies, présente de graves inconvénients et que les résultats des deux années 1904 et 1905 seraient tout à fait déconcertants et inexplicables si, par la suite, il n'avait été remédié à cette erreur ; nous aurons à y revenir lors de l'interprétation de ces résultats.

1908. Dans la récolte de 1907 il a été choisi 4 plantes qui ont été semées séparément et ont donné les résultats suivants :

233-08	64 naines et	17 grandes
234-08	55	29 "
235-08	63	19 "
236-08	61	22 "

Soit au total 243 naines et 87 grandes.

1909. La descendance de 233-08 est seule suivie, 5 plantes naines ont été conservées et ont donné :

258-09	10 naines et	5 grandes
259-09	8	3 "
260-09	17	14 "
261-09	23	17 "
262-09	28	14 "

Soit au total 86 naines et 53 grandes.

On remarquera que cette année nous avons opéré sur des semis très restreints, de sorte qu'il ne faut pas attacher trop d'importance aux chiffres ci-dessus; à cette époque je m'imaginai encore trouver une plante fixée au point de vue de la taille naine et je ne croyais plus avoir besoin d'un grand nombre de plantes dans chaque lot. C'est cette année là cependant que pour la première fois j'ai conservé quelques plantes grandes afin d'étudier leur descendance.

En tout, dans 258-09, 260-09, 261-09 et 262-09 j'ai conservé 16 plantes dont 11 naines et 5 grandes.

1910. Les plantes naines ont continué à donner une descendance mélangée de naines et de grandes dans des proportions sensiblement constantes donnant au total 333 naines et 134 grandes soit une proportion de 1 à 2.48, elles ont été cultivées séparément, mais je crois inutile de donner les proportions pour chacune d'entre elles; les 5 plantes grandes n'ont donné *que des plantes grandes*.

Dans la progéniture des 11 plantes naines il a été conservé 54 plantes toutes naines (des plantes grandes ont été suivies dans la famille rouge).

1911. Les graines de ces 54 plantes naines ont été semées séparément et ont donné dans l'ensemble 2791 plantes naines et 1246 plantes grandes, soit une proportion de 1 à 2.24.

1912. On a semé, toujours par lot séparé, les graines de 74 plantes dont 24 naines et 50 grandes. De plus un certain nombre de plantes ont été envoyées à M. Bateson et étudiées par M. Backhouse.

A Verrières nous avons eu des résultats concordant absolument avec ceux des années précédentes, c'est-à-dire que les 24 plantes naines ont donné dans leur ensemble 657 naines pour 293 grandes, soit une proportion de 1 à 2.24. De son côté M. Backhouse, examinant la progéniture des 6 plantes naines, a trouvé 314 naines et 131 grandes, soit une proportion de 1 à 2.39, et à Merton comme à Verrières, les plantes grandes n'ont donné que des plantes grandes.

B. *Famille rouge.*

Cette famille est issue de la famille précédente, son origine remonte à 1905, année où le No. 1746 a donné une plante naine à épi rouge. Cette variation de couleur avait été déjà remarquée mais négligée les années précédentes, elle est évidemment due à un croisement accidentel avec une race à épi rouge, comme il est prouvé par l'examen de la descendance qui se compose de blancs et de rouges en proportions

ordinaires; mais, dans ce cas, le caractère dominant rouge est fixable et a été extrait dès la deuxième génération.

1906. On ne récolte que 6 plantes dont 1 à épi blanc. Toutes les 6 sont naines, ce qui n'a rien de surprenant, étant donné le petit nombre d'individus. On conserve une plante naine semée à part et 5 plantes naines pour semer en mélange.

1907. La plante naine semée à part (224-07) donne 9 plantes dont 7 à épi rouge et 2 à épi blanc; au point de vue de la taille on trouve 7 naines et 2 grandes.

Les 5 plantes semées en mélange (1851-07) donnent 266 plantes dont 70 à épi blanc; et, au point de vue de la taille, 146 naines et 120 grandes (même observation que précédemment). Il est conservé 4 plantes naines à épi rouge.

1908. Ces 4 plantes sont semées séparément avec les résultats suivants :

237-08	66 naines et 23 grandes
238-08	65 „ 21 „
239-08	64 „ 17 „
240-08	65 „ 18 „

Soit un total de 260 naines et 79 grandes.

Il n'a pas été fait de choix dans le 238-08 qui présente une proportion de 63 plantes à épi rouge pour 23 à épi blanc. Les 3 autres lots sont composés uniquement de plantes à épi rouge (dominant fixé); on conserve 8 plantes dont 7 naines et 1 grande.

1909. Les 7 plantes naines sont semées séparément donnant au total 189 naines pour 89 grandes, soit une proportion de 1 à 2.12.

La plante (263-09) grande ne donne que des plantes grandes.

Dans la descendance des plantes naines il est conservé 15 plantes dont 11 naines.

1910. Les 11 plantes naines, toujours examinées séparément, donnent au total 342 plantes naines et 144 grandes, soit une proportion de 1 à 2.38, les plantes grandes ne donnent que des plantes grandes; on conserve 55 plantes dont 2 grandes.

1911. Les 53 plantes naines donnent au total 3048 plantes naines pour 1213 plantes grandes, soit une proportion de 1 à 2.51.

Les deux plantes grandes étudiées cette année n'ont donné que des grandes.

Dans la descendance des plantes naines il est conservé 58 plantes dont 18 naines.

1912. Les 18 plantes naines ont donné au total 390 plantes naines pour 160 grandes, soit une proportion de 1 à 2.43. Les 40 plantes grandes ne donnent que des grandes. Il semble donc bien évident qu'à la suite d'une expérience portant sur un aussi grand nombre d'individus, les plantes grandes sont incapables de reproduire des plantes naines.

3°. DISCUSSION DES RÉSULTATS.

Des résultats de cette expérience il ressort clairement au moins deux faits : 1° dans cette race naine, les plantes naines ne se reproduisent jamais d'une façon homogène, la descendance des plantes naines donnant toujours une certaine proportion de plantes grandes; 2° les plantes grandes de la même origine donnent une progéniture homogène de plantes grandes et ne donnent jamais de plantes naines.

Il s'agit maintenant d'étudier le rapport entre le nombre de plantes naines et de plantes grandes dans la descendance des plantes naines.

On remarquera que si l'on fait abstraction de certains résultats douteux, surtout dans les premières années alors que les mensurations n'étaient pas faites avec toute la rigueur nécessaire, les grandes sont aux naines dans un rapport variant de 1/4 à 1/3.

Au premier abord, et si nous n'avions pas un aussi grand nombre d'observations, il semblerait que les plantes naines se comportent comme une forme heterozygote donnant 1/4 de plantes grandes homozygotes, 2/4 de plantes naines heterozygotes et 1/4 d'un type homozygote qui pour une raison quelconque ne serait pas viable; par conséquent, dans le cas présent, ce serait l'homozygote dominant qui disparaîtrait. On peut admettre que ce soit un cas analogue à celui des souris jaunes étudié par Cuénot(1) et ensuite par Miss Durham(2). S'il y avait répulsion entre certains gamètes la proportion devrait être de 3 naines à 1 grande, en supposant naturellement que tous les gamètes femelles qui ne peuvent pas être fécondés par la première catégorie des gamètes mâles le soient par la deuxième, ce qui serait plausible, le nombre de grains de pollen étant illimité.

Il se pourrait aussi que les gamètes mâles et femelles de chaque catégorie puissent s'accoupler dans les conditions normales mais que le germe provenant de l'union de 2 gamètes portant le facteur résulte en un germe incapable de se développer. Alors à quel moment de la vie, l'homozygote dominant disparaîtrait-il ?

Les grains peuvent ne pas se développer et leur place rester vide dans l'épi; pour nous en rendre compte nous avons compté les grains d'un grand nombre d'épis tant sur des plantes grandes que sur des plantes naines, arrivant à ce résultat qu'il y a une différence dans le nombre de grains (59 grains par épi chez les grands; 50 chez les nains).

Il se pourrait aussi que les grains se forment mais soient incapables de germer. Nous avons donc effectué un grand nombre de semis en terrines, après avoir préalablement compté le nombre de grains ensemencés et ensuite le nombre de plantules sorties de terre.

	gr. semés	gr. levés
FAMILLE BLANCHE: plantes naines	2657	2567
„ „ plantes grandes	805	802
FAMILLE ROUGE: plantes naines	3351	3317

La proportion de grains ne germant pas semble donc plus forte dans les plantes naines; je ne crois pas cependant qu'il faille voir là un phénomène constant expliquant la disparition des homozygotes dominants. En effet, les semis avaient été faits, plante par plante, et dans la plupart des cas la différence entre le nombre de grains semés et de grains levés ne dépasse pas la normale et est la même que dans toutes les variétés de blés. Dans les chiffres donnés ci-dessus pour les plantes naines de la famille blanche, une seule plante, le No. 303-12, dont le grain était spécialement mal constitué, a donné 307 grains levés sur 345 grains semés.

Si nous faisons abstraction de cette plante nous aurions 2260 à 2312, ce qui est une proportion très normale. J'ajoute que l'on ne s'est pas contenté de constater la germination des grains, mais que l'on a conservé les jeunes plantes jusqu'à l'âge où elles sont en état d'être repiquées et qu'aucune n'a péri dans cet intervalle.

Nous avons pensé aussi qu'une certaine proportion de plantes pouvait disparaître dans la suite du développement, c'est-à-dire entre le repiquage et la maturité; mais il n'en est rien et, si forcément un certain nombre de plantes disparaît au cours de la végétation, la proportion n'en est pas plus élevée dans les naines que dans les grandes ou que dans une autre variété de blés.

Comme je l'ai dit, un certain doute sur les résultats peut provenir des difficultés de mensuration. Afin d'arriver à une certitude parfaite nous avons mesuré individuellement, en 1912, chaque plante et tracé des courbes dont l'examen ne laisse plus aucune incertitude sur la répartition des plantes issues de naines en deux groupes bien distincts.

Je reproduis ci-dessous quelques-unes de ces courbes. (Fig. 1 à 3.)

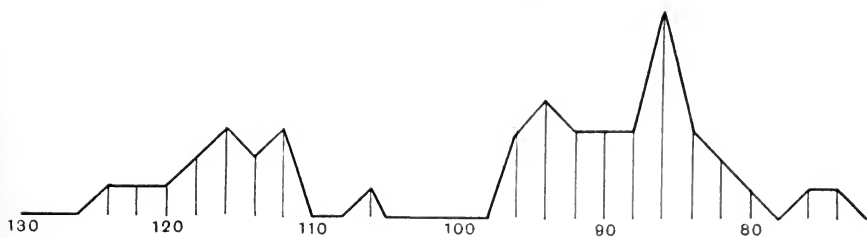

Fig. 1.

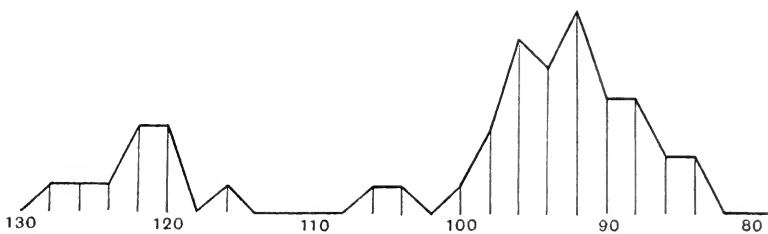

Fig. 2.

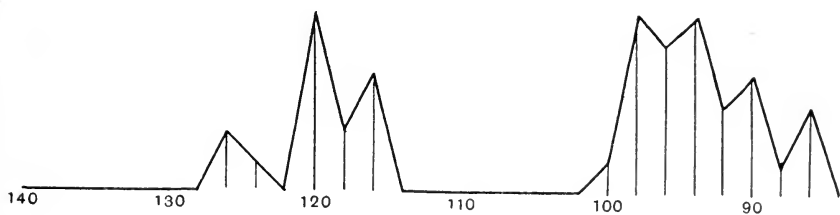

Fig. 3.

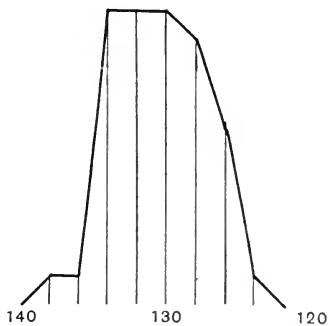

Fig. 4. (Descendance d'une plante grande.)

Il y a des cas cependant où les deux groupes se confondent plus ou moins et où il devient difficile de dire qu'une plante appartient à la catégorie des grandes ou à celle des naines. (Fig. 5 et 6.)



Fig. 5.



Fig. 6.

Ceci est dû à la fluctuation qui se manifeste dans tous les blés, mais pas plus dans cette variété que dans les autres ; pour m'en assurer j'ai fait des mensurations sur des variétés fixées, mesurant des plantes d'un même lot, qui descendaient toutes d'un même parent de 1910 et avaient été cultivées dans le même terrain.

Voici, par exemple, la courbe trouvée pour le blé de Bordeaux (Fig. 7).

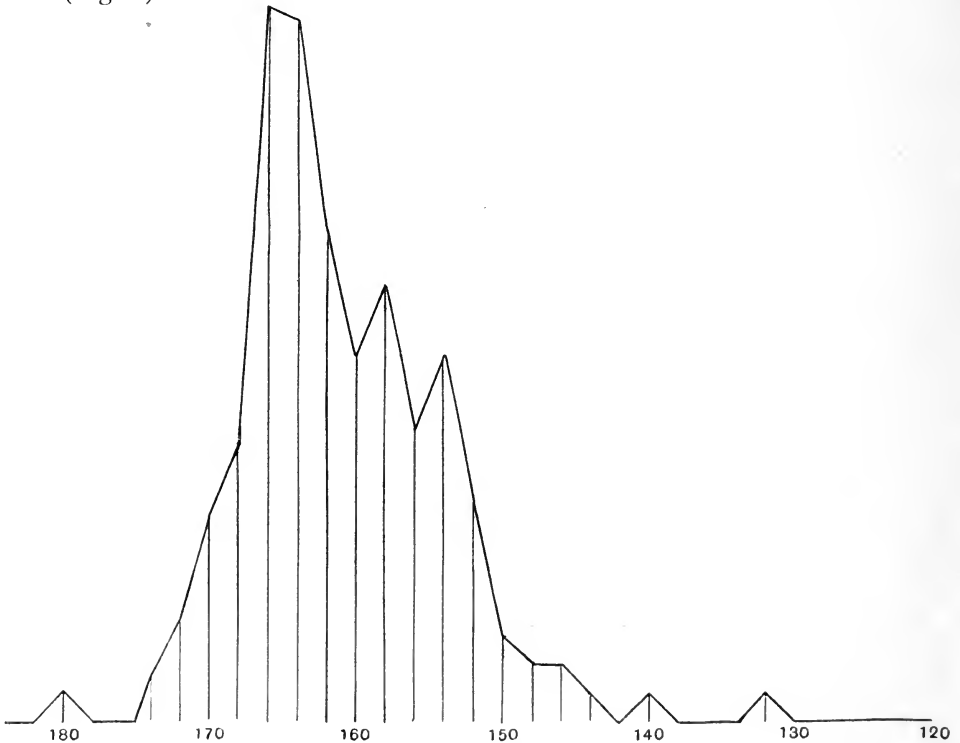

Fig. 7.

De même, j'ai trouvé que la taille, dans un lot homogène de blé blanc à paille raide, variait de 88 centimètres à 1 m. 50, dans le blé de Noé de 1 m. 04 à 1 m. 54, dans le Victoria d'automne 1 m. 40 à 1 m. 94; or, dans le blé que nous étudions, la différence moyenne entre les plantes grandes et les plantes naines n'est que de 30 centimètres¹. Il n'y a donc rien d'étonnant à ce que les conditions d'ambiance soient suffisantes pour faire passer une plante dans une catégorie à laquelle elle n'appartiendrait génétiquement pas.

C'est évidemment ce qui s'est passé en 1904 pour le blé Shirno (famille blanche) ainsi qu'en 1905, où une ou plusieurs plantes considérées comme naines étaient génétiquement grandes, ce qui explique les proportions tout à fait anormales de ces deux années.

On ne peut être absolument sûr qu'une plante est réellement naine qu'en étudiant sa progéniture. Toutefois il convient d'ajouter que l'erreur possible provenant de ce chef est extrêmement faible et peut être pratiquement négligée.

Ce cas est donc comparable à celui des souris jaunes. Il est très possible que la conjonction de deux gamètes portant le facteur nain se produise réellement, mais ne puisse donner naissance à un germe. Ceci expliquerait que les grains sont moins nombreux dans les épis des plantes naines que dans ceux des plantes grandes; mais si en réalité nous ne trouvons pas la proportion 2 à 1, c'est justement à cause du non développement de certains grains, par suite duquel les fleurs du centre de l'épillet peuvent développer leurs grains alors que dans les conditions normales elles resteraient stériles.

Comme nous l'avons déjà dit, s'il y avait réellement répulsion entre les gamètes portant le facteur nain, les ovules portant ce facteur seraient fécondés par des gamètes mâles dépourvus du facteur, le nombre de grains de pollen étant illimité. Dans ce cas nous aurions une proportion de 3 plantes naines à 1 plante grande; c'est l'hypothèse qui avait été formulée au début par Cuénot dans le cas des souris jaunes, mais les récentes expériences de Miss Durham semblent bien démontrer que la proportion est plutôt 2 à 1 que 3 à 1.

Pour terminer, je signalerai que, si le caractère nain est dominant sur le caractère grand dans cette famille, il n'en est pas de même par

¹ Toutefois dans quelques cas dans la descendance de plantes naines on trouve en dehors d'un groupe de plantes grandes et d'un autre plus important de plantes naines quelques individus de taille encore moindre variant de 30 à 50 centimètres. L'étude de ces exceptions est rendue difficile par le fait que généralement ces plantes sont stériles. Nous en avons cependant plusieurs en observation dont le produit sera examiné l'année prochaine.

rapport au caractère grand des autres races de blé. C'est ainsi qu'un croisement entre un blé Shirno nain, de 90 centimètres, et le blé Eclipse, variété de 1 m. 50 de haut, a donné un F_1 homogène et composé de plantes de 1 m. 20 à 1 m. 30 de haut.

Le F_2 est représenté par la courbe ci-dessous (Fig. 8).

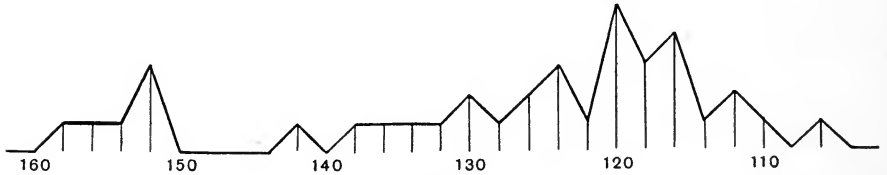

Fig. 8.

Dans un croisement entre une plante naine et une plante grande du Shirno j'ai trouvé en F_1 , sur 6 plantes 1 grande et 5 naines¹.

LITERATURE.

- (1) CUÉNOT, L. *Arch. de Zool. Exp. et Gén.*, Vols. I, II, III, VI.
- (2) DURHAM, F. M. "Further experiments on the Inheritance of Coat Colour in Mice" (*Journal of Genetics*, Vol. I, No. 2 (1911), p. 166).

¹ Ces nombres sont malheureusement trop faibles pour avoir une valeur démonstrative. Si l'hypothèse envisagée est vraie on doit obtenir le même nombre de nains et de grands. Des croisements sur une plus grande échelle devront être tentés avant de conclure avec certitude.

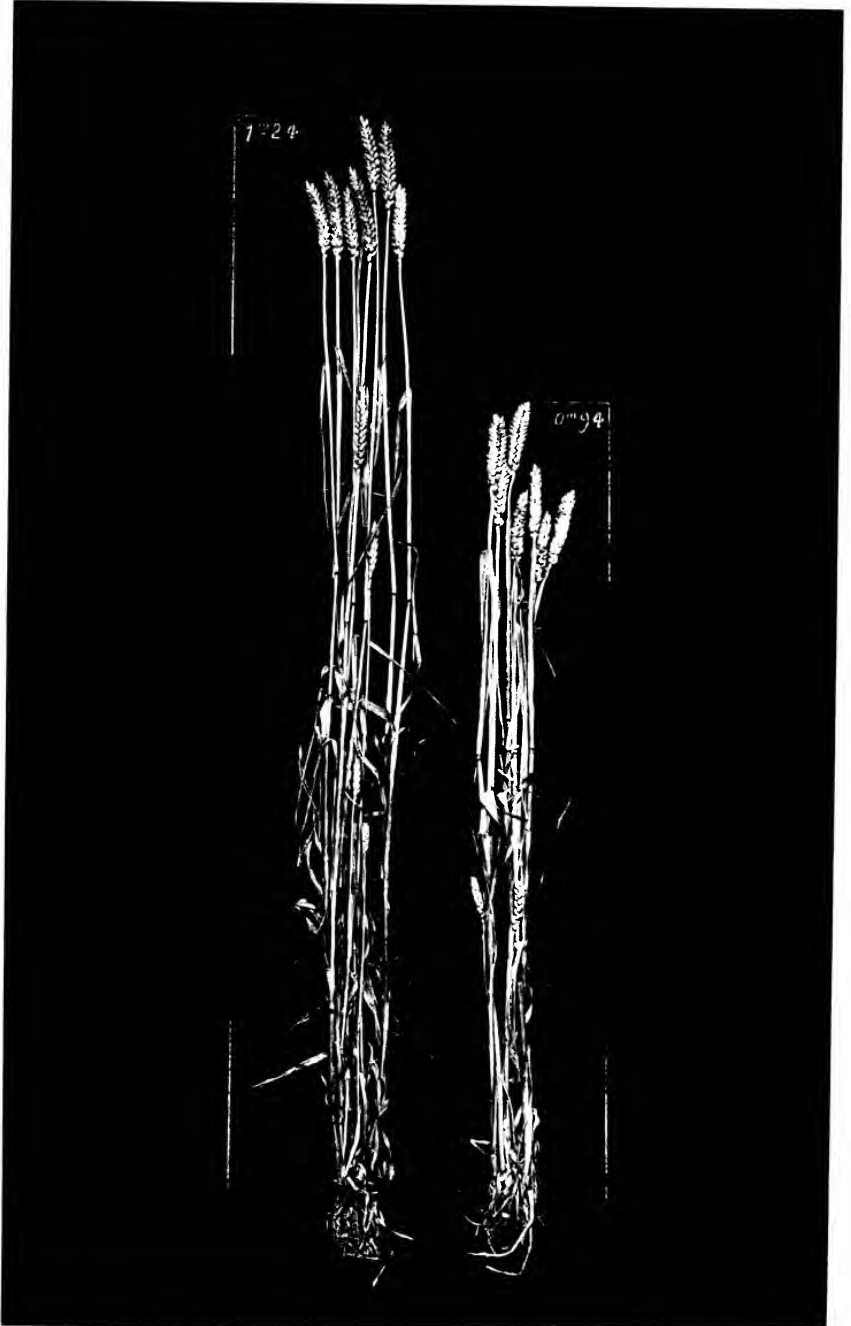

REDUPLICATION SERIES IN SWEET PEAS.

BY R. C. PUNNETT, M.A., F.R.S.

CONTENTS.

	PAGE
Introduction	77
A. The B, E, L series :	
(1) The relation between B and L	78
(2) " " " B and E	80
(3) " " " E and L	80
(4) The relations between B, E, and L in plants heterozygous for all three factors	81
B. The D, F, N series :	
(1) The relation between D and F	84
(2) " " " F and N	84
(3) " " " N and D	88
(4) The relations between D, F, and N in plants heterozygous for all three factors	88
Primary and secondary reduplications	90
Conclusion	93
Literature	95
Tables	96

INTRODUCTION.

THE present paper aims at bringing together some of the results of work done with sweet peas during the seasons 1908-13, and especially that part of it which concerns the phenomenon of the reduplication of terms in the gametic series. Some of the results have already been published in two short papers (Bateson and Punnett, (4) and (5))¹. The work is far from completion, but as the subject is beginning to excite greater interest it has seemed advisable to collect together and publish these records for the use of other students. Many new points

¹ These figures refer to the list of literature at the end of this paper.

have arisen, especially during the present summer, and several years must necessarily elapse before they can be settled satisfactorily.

The work recorded in the following pages deals with the inheritance of six factors, viz.:

B	the factor for blue as opposed to red.
E	„ „ erect standard as opposed to hooded.
L	„ „ long pollen „ „ round.
D	„ „ dark axil „ „ light axil.
F	„ „ fertile anthers „ „ sterile.
N	„ „ normal flower „ „ cretin.

As pointed out elsewhere ((4), p. 4) the relation between the factors **B**, **E**, and **L** is such that a plant which is heterozygous for any pair of this series shews coupling or repulsion according as the mating is **AB** × **ab**, or **Ab** × **aB**. Until the present summer (1913) the experimental evidence was in favour of regarding this generalisation as true also for the series **D**, **F**, **N**, and to some extent it certainly is true. But, as will appear later, there are grounds for supposing that under certain conditions, hitherto undetermined, a simple Mendelian relation, without coupling or repulsion, is to be found for this trio of factors. In this connection it is interesting to recall Baur's work with *Antirrhinum* (1) suggesting that in this genus coupling may result from the cross **AB** × **ab**, while for the same pair of characters the mating **Ab** × **aB** may give an ordinary Mendelian result. In considering the data given in the present paper, those relating to the **B**, **E**, **L** series will be taken first.

A. THE **B**, **E**, **L** SERIES.

(1) *The relation between **B** and **L** in plants homozygous for **E** or **e**.*

(α) Nature of mating **BL** × **bl**.

This was the reduplication series first discovered, and the nature of the F_2 generation can be explained on the hypothesis that F_1 plants made in this way produce a series of gametes of the form **7BL** : **1Bl** : **1bL** : **7bl**. To the evidence already given, derived from F_2 families ex Emily Henderson long pollen × E. H. round pollen ((2), p. 36), can now be added 4 further F_2 families (Table I, A), 40 F_3 families (Table I, B), and 14 families (Table I, C) derived from various crosses inside the E. H. strain. The entire material was homozygous

for **E**. As Table I shews the results from these three sources are all in accordance and confirm the original view that the results are probably the outcome of a gametic series of the form $7BL : 1Bl : 1bL : 7bl$. That the reduplication is of the same form in both ♂ and ♀ gametes is supported by some experiments made in pollinating red round-pollened plants with F_1 plants ex $BL \times bl$. 112 plants were raised in this way and consisted of

Purple long	50,	<i>Expectation being</i>	<i>49.</i>
„ round	7,	„	„ 7.
Red long	8,	„	„ 7.
„ round	47,	„	„ 49.

The figures make it evident that the ♂ gametic series is of the form suggested, and as the F_2 results can only be explained on the supposition that this series of ♂ gametes fertilizes a similar series of ♀ gametes there is every reason for supposing that the series is of the same form in both. This will be assumed throughout the various cases discussed.

It is assumed therefore that the reduplication between **B** and **L** is on the 7 : 1 basis inside the E. H. strain, and though in some families the two forms **Bl**, **bL** are in excess while in others they are deficient these will be regarded as chance results. Further there is some evidence to shew that the nature of the reduplication may remain unchanged when the E. H. strain is crossed with some other strain. Eight such families are given in Table II and shew that the expectation on the 7 : 1 basis is closely realised. These families also afford evidence that the form of the colour-pollen reduplication is unaffected by the presence of sterility in the families.

There are however other cases in which the reduplication departs considerably from the 7 : 1 basis. These are families derived from plants which are also heterozygous for **E**. To these we shall return later (p. 81).

(β) Nature of mating $Bl \times bL$.

Four families containing 419 plants were raised from this form of mating and the numbers of the four classes were

Purple long	Purple round	Red long	Red round
226	95	97	1

It has been pointed out elsewhere ((5), p. 297) that this result is in harmony with the supposition that the gametic series was

$$1BL : 7Bl : 7bL : 1bl.$$

The four families consisted of hooded plants only and were not of the pure E. H. strain. One small family however was raised from a cross between a blue round and a red long in the E. H. strain. The F_2 ('11, 43) consisted of 8 blue long, 3 blue round, and 5 red long and there is little doubt that if larger numbers were available the series would resemble that just dealt with.

(2) *The relation between B and E in families homozygous for L or l.*

(α) Nature of mating $BE \times be$.

25 families have been raised from plants of this type of mating and as is shewn in Table III the distribution of the four classes among the 2712 plants accords well with the view that the gametic series is $127BE : 1Be : 1bE : 127be$. All the plants were homozygous in L.

(β) Nature of mating $Be \times bE$.

Many of the families in which this form of mating occurred were also heterozygous in pollen, and these will be found recorded in Table VI. The result however was the same throughout. No red hooded plant was ever found, and the other three classes occur approximately in the ratio 2 blue erect : 1 blue hood : 1 red erect. The total numbers (including those in Table VI) are

Blue erect	Blue hood	Red erect
2969	1379	1441

This result points to the Be and bE types of gamete being considerably more numerous than the other two, and it is not incompatible with the view that the series is $1BE : 127Be : 127bE : 1be$. But as only one hooded red is to be looked for in 65,536 plants it is not proposed to investigate this particular case any further.

(3) *The relation between E and L in plants homozygous for B or b.*

(α) Nature of mating $EL \times el$.

At present there are no records of such a cross though a number of such families are expected in 1914.

(β) Nature of mating $El \times eL$.

Four such families were raised in 1908 and as is shewn in Table IV

they consisted of the three classes erect long, erect round, and hooded long approximately in the ratio 2 : 1 : 1. It is probable that the relation between **E** and **L** is similar to that existing between **B** and **L**, and between **B** and **E**, but at present the exact nature of the series must be left undecided.

(4) *The relations between B, E, and L in plants which are heterozygous in all three factors.*

As previously pointed out ((4), p. 7) there are four ways of mating to produce such plants, viz.:

- (α) **BEL** \times **bel**,
- (β) **BeL** \times **bEl**,
- (γ) **BEI** \times **beL**,
- (δ) **bEL** \times **Bel**.

Owing to misadventure an F_2 generation has been raised from the first two crosses only and we may now proceed to consider the results separately.

(α) Nature of mating **BEL** \times **bel**.

The appearance of a single red hooded round plant in 1910 (cf. (5), p. 297) made this mating possible and an F_2 generation was raised in 1912. Details of 13 such families are given in Table V. The results are evidently complex but some attempt at analysis may be made by considering separately each pair of the three factors concerned. The figures then become

- (a) **BL** : **Bl** : **bL** : **bl** :: 479 : 58 : 66 : 143,
- (b) **BE** : **Be** : **bE** : **be** :: 532 : 5 : 6 : 203,
- (c) **EL** : **El** : **eL** : **el** :: 479 : 59 : 66 : 142.

In each case the nature of the gametic series is evidently $n : 1 : 1 : n$ where $n > 1$. Since for any two of the factors the nature of the original cross was **AB** \times **ab** the "coupling" form of the series in each case was to be expected. But it is equally evident that the value of n in cases (a) and (b) is different from what it would have been had the plants been heterozygous for the two factors in question alone. The experimental numbers in (a) are not on the 7 : 1 system but the results are given far more closely by the gametic series **5BL** : **1Bl** : **1bL** : **5bl**. On this supposition expectation would be 501 blue long : 57 blue red :

57 red long : 129 red round—numbers not far removed from those actually found. The value of n for the **EL** series must also be very close to its value in the **BL** series.

Again in the **BE** series the figures obtained are much more closely in accordance with the supposition that the value of n is 63 instead of 127 which was found to be the case where the plants were homozygous for **L** (cf. p. 80). Apparently what may be termed the normal linkage ratios are upset, but this point will be considered later (p. 91).

It may however be suggested that it is possible theoretically to construct a gametic series which would give a close approach to the figures obtained. Such a series is :

$$\begin{array}{l}
 103 \text{ BEL} \\
 23 \text{ BEI} \\
 1 \text{ BeL} \\
 1 \text{ BeI} \\
 1 \text{ bEl} \\
 1 \text{ bEL} \\
 23 \text{ beL} \\
 103 \text{ bel}
 \end{array}
 \left. \vphantom{\begin{array}{l} 103 \text{ BEL} \\ 23 \text{ BEI} \\ 1 \text{ BeL} \\ 1 \text{ BeI} \\ 1 \text{ bEl} \\ 1 \text{ bEL} \\ 23 \text{ beL} \\ 103 \text{ bel} \end{array}} \right\} \begin{array}{l} \\ \\ \\ \text{giving the zygotic figures in} \\ \text{the proportion} \\ \\ \\ \\ \\ \end{array} \left. \vphantom{\begin{array}{l} 103 \text{ BEL} \\ 23 \text{ BEI} \\ 1 \text{ BeL} \\ 1 \text{ BeI} \\ 1 \text{ bEl} \\ 1 \text{ bEL} \\ 23 \text{ beL} \\ 103 \text{ bel} \end{array}} \right\} \begin{array}{l}
 \text{BEL } 43283 \\
 \text{BEI } 5361 \\
 \text{BeL } 310 \\
 \text{BeI } 207 \\
 \text{bEl } 207 \\
 \text{bEL } 301 \\
 \text{beL } 5267 \\
 \text{bel } 10609
 \end{array}$$

In such a series the gametic relations for the separate pairs of factors are :

$$\text{B and L—13BL : 3BI : 3bL : 13bl,}$$

$$\text{B and E—63BE : 1Be : 1bE : 63be,}$$

$$\text{L and E—13LE : 3Le : 3lE : 13le.}$$

As the subjoined figures shew the theoretical results accord fairly closely with the actual numbers.

Blue				Red				
Erect		Hood		Erect		Hood		
Long	Round	Long	Round	Long	Round	Long	Round	
477	55	2	3	2	4	64	139	
<i>Expectation</i>	493	61	3.5	2.5	3.5	2.5	60	120

At present however I do not wish to lay stress on this approximation as I am unable to picture clearly how such a gametic series comes to be formed.

(β) Nature of mating **BeL** \times **bEl**.

Details of a number of F_2 and F_3 families ex Blanche Burpee

(hooded white long) \times E. H. round were given in *Report IV, Evol. Comm. Roy. Soc.* 1908, p. 14. The general result shewed "coupling" between **B** and **L**, together with "repulsion" between **B** and **E**, and between **L** and **E**, a result which from the nature of the mating was to have been expected. It was pointed out in an earlier account (*R. E. C.* IV. p. 11), that the two classes purple round and red long were less numerous than was expected on a 7 : 1 basis, and at the time an explanation was suggested on the grounds of some of the families being on a 7 : 1 basis and others on a 15 : 1 basis. The recent publication of Trow's Paper (**16**) on reduplication series has put the matter in a new light and we shall return to this case later in discussing his suggestion (p. 91). For the moment we may turn to Table VI which adds further data by the inclusion of a number of F_2 and F_3 families derived from the cross white hooded Bush long (**BeL**) \times white erect Cupid round (**bEl**). The F_2 families were given in the earlier account (**3**), p. 12 and were there regarded as a case of coupling on a 15 : 1 basis. Fuller experience however has led to the conclusion that they should be classed with the material derived from the original cross Blanche Burpee \times Emily Henderson. Three further families ('08, 89, 93, 114) have been added derived from other material in which the mating was of the nature **BeL** \times **bEl**.

Consideration of each pair of the three factors taken separately shews their relations to be as follows:

$$(\alpha) \quad \mathbf{BL} : \mathbf{Bl} : \mathbf{bL} : \mathbf{bl} :: 3006 : 164 : 212 : 843,$$

$$(\beta) \quad \mathbf{BE} : \mathbf{Be} : \mathbf{bE} : \mathbf{be} :: 2146 : 1024 : 1055 : -$$

$$(\gamma) \quad \mathbf{EL} : \mathbf{El} : \mathbf{eL} : \mathbf{el} :: 2200 : 1001 : 1018 : 6.$$

Evidently (β) and (γ) are "repulsion" forms of reduplication in which the zygotic series $2n^2 + 1\mathbf{AB} : n^2 - 1\mathbf{Ab} : n^2 - 1\mathbf{aB} : 1\mathbf{ab}$ is derived from a gametic series $1\mathbf{AB} : (n-1)\mathbf{Ab} : (n-1)\mathbf{aB} : 1\mathbf{ab}$ (**5**), p. 295). An approximation to the value of n in such cases is most readily obtained by dividing the last term in the zygotic series into one of the two middle terms. This gives the approximate value of $n^2 - 1$ from which the value of n may be readily deduced.

In the case of (γ) $\frac{n^2 - 1}{1} = \frac{1018}{6}$ whence $n^2 - 1 = 169$ and $n =$ approximately 13. Hence the zygotic series (γ) is given most nearly by a gametic series $1\mathbf{EL} : 12\mathbf{El} : 12\mathbf{eL} : 1\mathbf{el}$.

In (β) there is no individual lacking both **B** and **E**, and all that can be stated of n is that it is almost certainly > 32 .

The zygotic series (α) is evidently a "coupling" form of reduplication, and is most nearly approached by the gametic series 10 : 1 : 1 : 10, on which the expectation of the 4 forms is 2984 : 184 : 184 : 873. It is clear that in this case, as in the **BEL** and **bel** cross, the normal value of the pollen-colour reduplication series is upset, and that instead of being on a 7 : 1 basis it approximates to a 10 : 1 basis. It is possible that this upsetting of the normal value may be true also of the standard-pollen, and of the standard-colour series, but at present the point must remain undecided. For we do not know the normal value of the standard-pollen series, and in the case of the standard-colour series the data are insufficient for determining even its approximate value.

B. THE D, F, N SERIES.

(1) *The relation between D and F in plants homozygous for N.*

(α) Nature of mating **FD** \times **fd**.

Evidence has already been given ((**3**), p. 16) for regarding the reduplication in this case as on a 15 : 1 basis, and to the figures previously set out we can now add a few more families (cf. Table VII). As the figures shew, the numbers of the two classes, dark sterile and light fertile, are rather below expectation. Certain of the families (marked * in Table VII) were also heterozygous for **B** and **L** and it is possible that this may have influenced the result. Certainly when these families are deducted the discrepancy in the remainder between reality and expectation is not so marked (cf. Table VII).

(β) Nature of mating **Fd** \times **fD**.

The experimental data for this mating are given in Table VIII. So far no light axilled sterile has occurred among 2252 plants, though 2 such plants were to be expected if the gametic series is on the 1 : 15 basis. At present therefore the value of the reduplication is undecided.

(2) *The relation between F and N.*

Details of 9 F_2 families derived from the mating **Nf** \times **nF** have been given elsewhere ((**5**), p. 295) and it was clear that the nature of the gametic series produced by the F_1 plant was **1NF** : **3Nf** : **3nF** : **1nf**. In the same paper it was suggested that the value of the reduplication affecting two factors might be the same for both the "coupling" and

the "repulsion" series, and the low value of n in the present case offered the most favourable opportunity hitherto met with for testing this point. Accordingly large numbers of pollinations from normal fertile plants (**NF**) were made on to sterile cretins (**nf**). In not a single instance however was the operation successful and it was found subsequently that the cretin, whether producing pollen or not, is always sterile on the female side. The pods, and even the seeds, may sometimes undergo swelling but in none of the numerous cases examined was a viable seed produced. The (**NF** × **nf**) plant had therefore to be sought for in another direction.

Since the gametic series produced by the plant formed from the two gametes **Nf** × **nF** is of the nature **1NF** : **3Nf** : **3nF** : **1nf** such plants should give rise to the following zygotic forms:

NNFF	1	NNff ...	9	nnFF ...	9	nnff ...	1
NNFf	6	Nnff ...	6	nnFf ...	6		
NnFF	6						
(Nf × nF) ...	18						
(NF × nf) ...	2						

normal fertile 33 :	normal } sterile }	15 :	cretin } fertile }	15 :	cretin } sterile }	1
---------------------	-----------------------	------	-----------------------	------	-----------------------	---

Hence out of 33 normal fertiles in such a family there should be 5 distinct classes distributed in the following proportions:

1 (**NNFF**) giving only normal fertiles.

6 (**NNFf**) giving normal fertiles and steriles only.

6 (**NnFF**) giving normal and cretin fertiles only.

18 (**Nf** × **nF**) giving all 4 classes with "repulsion" between **N** and **F**.

2 (**NF** × **nf**) giving all 4 classes with "coupling" between **N** and **F**.

30 such normal fertiles from F_2 families were grown on to give an F_3 generation in 1912. The expected 5 classes were all found, and as shewn below (and also in Table IX) the proportions in which they occurred accorded closely with expectation.

Reduplication Series in Sweet Peas

Type of F_2 plant	Number found by experiment	Number expected
NNFF	2	.9
NNFf	5	5.5
NnFF	7	5.5
(Nf × nF) ...	14	16.3
(NF × nf) ...	2	1.8
Totals	30	30

In one family where coupling occurred ('12, 76) the numbers were sufficiently large to indicate the nature of the reduplication. There is little doubt that it is on the 3 : 1 basis for although there was an unexpectedly large number of cretins the proportions accord fairly well with expectation¹.

	Normal fertile	Normal sterile	Cretin fertile	Cretin sterile
'12 ; 76	90	20	30	34
<i>Expectation</i>	111.5	19	19	24.5

It should be mentioned that the plants in this family were all light-axilled. There are good grounds then for asserting that for the factors N and F reduplication is on the 3 : 1 or on the 1 : 3 basis according as to whether the original mating is NF × nf or Nf × nF.

Yet it is probable that the case is not so simple as it appears at first sight. Reference to Table IX shews that in two families, viz. '12, 71 and '12, 91, the proportions in which the four forms occur afford a distinct suggestion of a 9 : 3 : 3 : 1 ratio. And if these two families are taken together the figures 42 NF, 13 Nf, 14 nF, 5 nf make a very close approximation to this ratio.

The possibility that, where the factors N and F are concerned, there may be other sorts of families than those shewing the 3 : 1 or the 1 : 3 reduplications is to some extent supported by the results of growing on a further generation from the F_2 family '12, 76. Unfortunately these did not set seed freely and only 11 F_3 families were obtained. In all of them the number of individuals was relatively small, and in two cases it was too small to give more than a qualitative result. There are however 8 families in which all the four classes occurred, and in which there are over 30 plants per family. Reference to Table X shews that these families¹ fall into two distinct groups:—

¹ I do not feel clear as to the nature of Fam. '13, 47 and have therefore not included it in the present argument. It may be a family on the 3 : 1 : 1 : 3 basis but the numbers are too few for certainty.

- (a) Fams. 38, 39, 40, 41. These four families are evidently of the same nature as the parent family '12, 76. The three classes normal sterile, cretin fertile, and cretin sterile are much in the proportions that would be expected on a 3:1:1:3 reduplication system, but the number of normal fertiles is much below expectation. These four families added to the parent family ('12, 76) give the numbers:

	Normal fertile	Normal sterile	Cretin fertile	Cretin sterile
	165	58	58	78
Expect. on 3:1:1:3 basis ...	346	59	59	76

The italicised figures shew that the three last classes are closely in the ratio 7:7:9, as expected on the 3:1:1:3 system, but that the normal fertiles are only about one half as numerous as would be expected. That there is something militating against the formation of normal fertiles in such families is borne out by the following consideration. Of the 11 F_4 families grown from '12, 76, 10 contained all four classes of plant, while one family had cretins but no steriles. Now the normal fertiles from a family producing gametes on the system $3 NF:1 Nf:1 nF:3 nf$ should be of five kinds, and in every 41 plants these five kinds should be present in the following proportions:

- 9 **NNFF** giving normal fertiles only.
 6 **NNff** „ normal fertiles and steriles only.
 6 **NnFF** „ normal and cretin fertiles only.
 18 **NnFf** „ all four classes with coupling.
 2 **Nnff** „ „ „ „ repulsion.

Hence out of 41 such plants only 20, or not quite one half, should give the four classes. But of the 11 plants tested (Table X) no less than 10 gave all four classes. It would appear then that for some reason or other the classes **NNFF**, **NNff**, **NnFF** are not produced in the expected numbers, though why this should be so is at present quite obscure.

- (b) Fams. 43, 45, 46. These three families are distinctly different from those just considered and the combined figures

	Normal fertile	Normal sterile	Cretin fertile	Cretin sterile
	75	23	21	5
Expect.	69.75	23.25	23.25	7.75

Reduplication Series in Sweet Peas

support the idea that we are here dealing with a 9 : 3 : 3 : 1 ratio. As already mentioned it is not impossible that in Fam. '12, 71 (Table IX) this type of family has been encountered once before.

(3) *The relation between N and D in plants homozygous for F.*

Hitherto the opportunity of studying this particular case has been limited to a single family. This family ('13, 119) was from a normal fertile belonging to Fam. '12, 88 (Table IX) and proved to be heterozygous in N and D but homozygous for F. It contained 100 plants and was composed of

	Normal dark	Normal light	Cretin dark	Cretin light
	48	22	27	3
Expect. on 1 : 3 : 3 : 1 system ...	51·6	23·4	23·4	1·6

The figures are in consonance with the idea that the reduplication for N and D is on a 1 : 3 basis, and this is borne out by the behaviour of these two factors in relation to one another among plants which are heterozygous for N, D, and F (see p. 89).

(4) *The relations between D, F, and N in plants heterozygous for all three factors.*

As in the case of the B, E, L series there are four ways theoretically possible by which plants heterozygous for three factors can be produced, viz.:

- (a) DFN × dfn.
- (β) DfN × dFn.
- (γ) DFn × dfN.
- (δ) dFN × Dfn.

Of these four ways I have hitherto been able to study two, viz. (β) and (γ).

(β) *Nature of mating, DfN × dFn.*

The details of four such families raised from the same parents and comprising in all 442 plants are set out in Table XI, and may be considered together. The proportion of dark axils to light axils, of fertiles to steriles, and of normals to cretins is closely 3 : 1 in each case.

And if the figures are arranged for the three different pairs of factors the result is what might have been anticipated from the nature of the mating, viz. coupling between **D** and **N**, and repulsion between **D** and **F** and between **N** and **F** respectively.

FAMILIES 48—51.

		Expectation on 3:1:1:3 system.	
ND	282	284	
Nd	49	48	
nD	52	48	
nd	59	62	
		Expectation on 1:3:3:1 system.	
NF	225	228	
Nf	106	103.5	
nF	101	103.5	
nf	10	7	
		Expectation on 1:7:7:1 system.	Expectation on 1:15:15:1 system.
DF	220	222.7	221.4
Df	114	108.8	110.1
dF	106	108.8	110.1
df	2	1.7	.4

The numbers shew that the reduplication series in the first two cases is approximately on a 3:1 basis while that for **D** and **F** fits most closely a 1:7:7:1 series. In the last case however the **df** class appears so rarely that the precise nature of the reduplication must for the present remain undecided. It is not impossible that it may be on a 1:15 basis which is rather to be expected in view of the fact that the coupling series for these two factors is on the 15:1:1:15 system.

It may be noted that the 3:1 basis for the relation between **N** and **D** from this mating is in accordance with the 1:3 basis for the relation between these two factors when the nature of the mating is **Nd** × **nD**.

(γ) *Nature of mating, DFn* × *dfN*.

The material for the study of this mating (Table XI) consists so far of two F_2 families, '13, 52 and '13, 53, and of four F_4 families, '13, 113, 114, 117, 123, all derived from an original cross of the same type. All six families appear to be of the same sort, and I have assumed the nature of the mating in the F_4 families is what is known to be the case in the two F_2 families.

In families derived from this type of mating I had anticipated

Reduplication Series in Sweet Peas

coupling between **D** and **F**, together with repulsion between **N** and **F** and between **N** and **D**. The figures here given shew that the first part of the anticipation was realised.

	Families 52, 53, 113, 114, 117, 123.	Expectation on 15:1:1:15 system,
DF	172	170.4
Df	6	7.3
dF	4	7.3
df	58	55.0

There is coupling between **D** and **F** and this is not far removed from the expected 15:1:1:15 system. But there is no repulsion evident between either **N** and **F**, or between **N** and **D**.

	Families 52, 53, 113, 114, 117, 123.	Expectation.
ND	131	135
Nd	49	45
nD	47	45
nd	13	15
NF	130	135
Nf	50	45
nF	46	45
nf	14	15

Instead of this the figures accord closely in both cases with an ordinary 9:3:3:1 ratio. The possibility of a similar ratio has already been referred to in the case of other families where these factors are concerned (p. 86) and it is hoped that a further study of this interesting case may give us the clue as to the relation between normal and reduplicated gametic series. But it is evident that several years must elapse before the necessary experiments can be completed.

PRIMARY AND SECONDARY REDUPLICATIONS.

In an interesting paper which has just appeared (16) Trow discusses the problems offered by reduplicated series of gametes, and draws a distinction between what he has termed primary and secondary series. Starting with the case where there are three factors **A**, **B**, **C** such that any two may form a reduplicated series, he has shewn theoretically that if the reduplication between **A** and **B** is of the form $m:1:1:m$, and between **A** and **C** is of the form $n:1:1:n$, then the secondary form of reduplication, derived from these two primary ones and expressing the relation between **B** and **C**, is of the form $nm+1:m+n:m+n:nm+1$. The only experimental data with

which he has hitherto been able to test his hypothesis have been provided by a case among Gregory's primulas, the three factors concerned being **M** (= magenta), **S** (= short style), and **G** (= green stigma). The experimental evidence points to the **MS** reduplication being on the 7 : 1 basis and the **MG** reduplication on the 2 : 1 basis. The secondary reduplication between **S** and **G** should consequently be of the form $(7 \times 2) + 1 : 7 + 2 : 7 + 2 : (7 \times 2) + 1$, i.e. 5 : 3 : 3 : 5, and the experimental data are in fairly close accordance with this expectation (cf. Trow (16), p. 316). The data given in this paper from the two sweet pea crosses **BEL** \times **bel**, and **BeL** \times **bEl** afford further cases for testing Trow's hypothesis.

(1) *The BEL \times bel cross.*

It has been pointed out above (p. 82) that the three reduplication series here are approximately of the following values :

$$(\alpha) \quad \mathbf{B} \text{ and } \mathbf{L}—13 : 3 : 3 : 13,$$

$$(\beta) \quad \mathbf{B} \text{ and } \mathbf{E}—63 : 1 : 1 : 63,$$

$$(\gamma) \quad \mathbf{E} \text{ and } \mathbf{L}—13 : 3 : 3 : 13.$$

If we consider (α) and (β) as the two primary reduplications then the value of (γ) should be

$$\left(\frac{13^3}{3} \times 63\right) + 1 : \frac{13^3}{3} + 63 : \frac{13^3}{3} + 63 : \left(\frac{13^3}{3} \times 63\right) + 1,$$

i.e. $41 : 1 : 1 : 41$,

a result which is closely in accordance with the experimental numbers. A feature of interest in connection with this case is that it demonstrates that when the value of one primary series is considerably greater than the other, the value of the secondary series will be very close to that of the lower primary series.

(2) *The BeL \times bEl cross.*

In this case the relations between **B** and **E**, and between **L** and **E**, are of the nature of "repulsion." Nevertheless, as Trow has pointed out, even if these be regarded as the two primary series the secondary series (between **B** and **L** here) should be of the nature of "coupling." The facts (p. 83) point to the reduplication between **L** and **E** being near 1 : 12 : 12 : 1. That between **B** and **E** is evidently much higher though how much so we have no direct means of telling. But we have already seen that the "coupling" between **B** and **E** is on the 127 : 1 basis in families homozygous for **L** and on the 63 : 1 basis in the

BEL × bel cross. Also there is evidence for supposing that the “repulsion” reduplication is of the same value as the “coupling” reduplication between two given factors. We shall assume then for argument that the reduplication between B and E is of the value 1 : 63 : 63 : 1. For B and L (p. 84) the experimental data are closely approached by a series 10 : 1 : 1 : 10. We have therefore the 3 series :

- (α) B and E— 1 : 63 : 63 : 1,
- (β) E and L— 1 : 12 : 12 : 1,
- (γ) B and L—10 : 1 : 1 : 10.

If we treat (α) and (β) as the primary series the value of (γ) deduced theoretically should be

$$(63 \times 12) + 1 : 63 + 12 : 63 + 12 : (63 \times 12) + 1$$

i.e. $10\cdot01 : 1 : 1 : 10\cdot01,$

which is a remarkably close approximation to the experimental proportions.

It will be noticed that in each of the above cases we have chosen as our two primary series those in which the reduplication values are highest. This was also done by Trow in his analysis of Gregory’s primulas. It is only in this way that the hypothesis will work, for, as can be readily shewn, the value of the reduplication in the secondary series must always be less than in either of the two primary series from which it is derived.

Let A, B, and C be the three factors concerned, and let the reduplication series for

- A and B = $p : 1 : 1 : p$ (α),
- A and C = $p + x : 1 : 1 : p + x$ (β),

where $p > 1$ and x is positive.

Then the series for

$$B \text{ and } C = p(p + x) + 1 : 2p + x : 2p + x : p(p + x) + 1 \dots\dots(\gamma).$$

It is required to shew that

$$\frac{p(p + x) + 1}{2p + x} < \frac{p}{1},$$

i.e. $p^2 + px + 1 < 2p^2 + px,$

i.e. $1 < p^2.$

which is evident since on hypothesis $p > 1.$

Hence in a series of three reduplications, two primary and one secondary, that one is to be regarded as the secondary in which the value of the reduplication is lowest.

In this connection the two groups of families recorded in Table XI are also of interest. In Group A from the mating $DfN \times dFn$ there is repulsion between D and F , coupling between D and N , and repulsion between N and F . The first repulsion is not improbably on the 1:15:15:1 system or something near it (cf. p. 89), while the second repulsion and the coupling are not far removed from the 1:3:3:1 and the 3:1:1:3 systems respectively. The figures are in general accordance with Trow's hypothesis, but the numbers are not large enough to determine more precisely the values of the reduplication systems, or to decide which of the two lower series is the secondary one.

In the families of Group B in Table XI, where the nature of the mating is $dfN \times DFn$, there is coupling between D and F but no repulsion between N and D or between N and F . Here again the experimental facts are in accordance with Trow's hypothesis, for where one of the primary series shews no reduplication it follows that no reduplication will be exhibited by the secondary series.

CONCLUSION.

Finally attention may be drawn to some points in connection with the value of the reduplication in the various cases discussed above. Where only two factors are concerned we have regarded the reduplication as of the form $(n-1):1$ where n is some power of 2, and we suggested in a previous paper how such a series might be brought about through alternating periclinal and anticlinal cell divisions ((5), Fig. 4). The experimental data hitherto obtained from sweet peas fit in with this view, but, as pointed out some years ago ((2), p. 9), they are also in accordance with the form of the reduplication being $n:1:1:n$ where n again is some power of 2. It is only in cases where n is very small that we can hope to distinguish between the two without growing an impracticably large number of plants. At present the $NF \times nf$ mating is the only one from which we can look for a critical result on this point, and the available evidence suggests that the reduplication here is $3NF:1Nf:1nF:3nf$ (cf. p. 86), i.e. that it is on the $(n-1):1$ basis rather than on the $n:1$ basis¹. It may

¹ What is evidently a case of reduplication on the 3:1 basis has been recently discovered by Collins in maize ((6), p. 579), the cross in question being one between an

Reduplication Series in Sweet Peas

be pointed out however that this scheme is not incompatible with the $n : 1$ basis. The form of the series, whether $(n - 1) : 1$ or $n : 1$, might depend upon whether the first division in the quadrant were a periclinal or an anticlinal division. In the one case (Fig. 1) we should get the $(n - 1) : 1 : 1 : (n - 1)$ series, and in the second case (Fig. 2) the

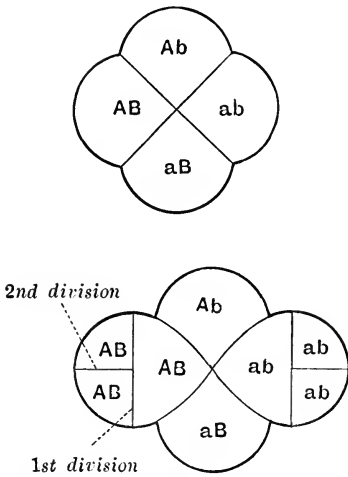

Fig. 1.

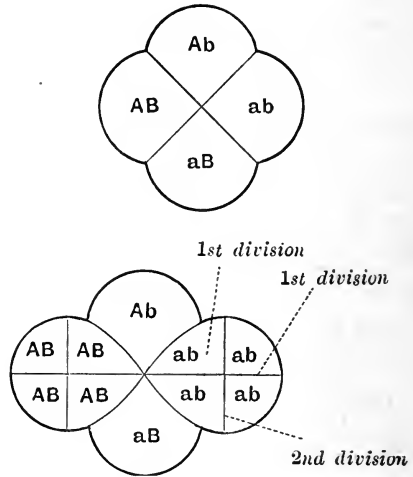

Fig. 2.

$n : 1 : 1 : n$ series. Further possible ratios also depend upon whether the first division in the other two quadrants is periclinal or anticlinal. Indeed it is obvious that there are numerous possibilities which may perhaps repay discussion when more experimental data are available. All that can be stated positively at present is that the cases hitherto worked out in the sweet pea fit in with the hypothesis that the number of cells in the reduplicated series is some power of 2 where only two factors are concerned. But where three factors are concerned this is certainly not true. The value of the primary reduplications is evidently altered, and there would seem to be some process whereby these reduplications react upon one another. Where so many points remain

American variety with coloured aleurone and horny endosperm, and a Chinese variety with white aleurone and waxy endosperm. By means of other statistics Collins is at pains to prove that the reduplication phenomena in maize are of a highly irregular nature. Much stress however cannot be laid upon these results as the author is evidently dealing with dominant as well as recessive whites in his experiments though this point does not appear to be specifically recognised by him. It is probable that a more careful genetic analysis of the whites which he uses would help to clear up the apparent irregularities in his results.

doubtful, as at present, it is difficult to suggest any scheme by which this result could be brought about, and the problem must at present be left in the hope that fresh data may eventually lead to its solution.

LITERATURE.

(Papers dealing with cases in which the phenomena of "coupling" and "repulsion" are met with, but in which sex-limited inheritance is not involved.)

1. BAUR, E. "Vererbungs- und Bastardierungsversuche mit Antirrhinum; II. Faktorenkoppelung." *Zeit. f. ind. Abst. u. Vererb.* 1912.
2. BATESON, W., SAUNDERS, E. R., and PUNNETT, R. C. "Experimental Studies in the Physiology of Heredity." *Report III, Evol. Comm. Roy. Soc.* 1906.
3. — — —. *Report IV, Evol. Comm. Roy. Soc.* 1908.
4. BATESON, W., and PUNNETT, R. C. "On the Inter-relation of Genetic Factors." *Proc. Roy. Soc.* 1911.
5. — — —. "On Gametic Series involving Reduplication of certain Terms." *Journal of Genetics*, 1911.
6. COLLINS, G. N. "Gametic Coupling as a cause of Correlations." *Amer. Nat.* 1912.
7. EMERSON, R. A. "Genetic Correlation and Spurious Allelomorphism in Maize." *Twenty-fourth Ann. Rep. Nebraska Agric. Exp. Stat.* 1911.
8. GREGORY, R. P. "On Gametic Coupling and Repulsion in *Primula sinensis*." *Proc. Roy. Soc.* 1911.
9. HAGEDOORN, A. L. "The Genetic Factors in the Development of the House-mouse, &c." *Zeit. f. ind. Abst. u. Vererb.* 1912.
10. KEEBLE, F. W., and PELLEW, C. "The Mode of Inheritance of Stature and of Time of Flowering in Peas." *Journal of Genetics*, 1910.
11. MORGAN, T. H. "Complete Linkage in the Second Chromosome of the Male of *Drosophila*." *Science*, 1912.
12. PUNNETT, R. C. "Inheritance of Coat-Colour in Rabbits." *Journal of Genetics*, 1912.
13. SAUNDERS, E. R. "Further experiments on the Inheritance of 'Double-ness' and other Characters in Stocks." *Journal of Genetics*, 1911.
14. STURTEVANT, A. H. "The Linear Arrangement of Six Sex-linked Factors in *Drosophila*, as shown by their Mode of Association." *Journ. Exp. Zool.* 1913.
15. TROW, A. H. "On the Inheritance of Certain Characters in the Common Groundsel, &c." *Journal of Genetics*, 1912.
16. — — —. "Forms of Reduplication; Primary and Secondary." *Journal of Genetics*, 1913.
17. DE VILMORIN, P., and BATESON, W. "A Case of Gametic Coupling in *Pisum*." *Proc. Roy. Soc.* 1911.

Reduplication Series in Sweet Peas

TABLE I.

Families from Emily Henderson, heterozygous in colour and pollen.

A. F_2 families ex E. H. long \times E. H. round.

Reference Number	Purple		Picotee		Red		Tinged-white		White	
	Long	Round	Long	Round	Long	Round	Long	Round	Long	Round
'08, 119	12	3	4	—	3	2	1	3	24	10
„ 120	22	7	9	—	2	6	—	4	34	13
'09, 6	33	2	9	—	3	11	—	5	37	10
'10, 58	62	4	21	2	7	15	—	6	73	16
Totals	129	16	43	2	15	34	1	18	168	49
			Purple		Red		White			
			Long	Round	Long	Round	Long	Round		
Above 4 families	...		172	18	16	52	168	49		
Report III, p. 36	...		1528	106	117	381	1190	394		
Totals	1700	124	133	433	1358	443		
Expectation among coloured			1652	140	140	458				

B. F_3 families heterozygous in colour and pollen.

Reference Number	Purple		Red		White	
	Long	Round	Long	Round	Long	Round
'04, 152	46	4	2	10	30	4
'04 F, 82	40	4	1	9	38	10
„ 102	20	—	1	2	7	3
„ 105	47	4	8	8	39	17
„ 106	12	—	1	7	5	3
„ 128	17	—	—	4	—	—
'05, 280	31	4	3	8	18	4
„ 286	8	1	1	2	7	1
„ 291	13	3	—	8	8	3
„ 292	31	4	1	10	17	2
„ 293	10	—	1	5	11	3
„ 296	20	—	2	4	15	3
'05 F, 23	23	3	5	6	11	—
'06 F, 401	128	14	8	38	102	29
„ 402	42	7	1	12	14	3
„ 404	17	3	—	4	17	5
„ 409	48	9	7	16	—	—
„ 410	60	6	3	14	—	—
„ 406	74	6	5	39	31	15
„ 412	21	2	—	7	6	—
„ 413	79	7	5	23	21	6

B. F_3 families heterozygous in colour and pollen (*continued*).

Reference Number	Purple		Red		White	
	Long	Round	Long	Round	Long	Round
'06 F, 417	50	5	4	7	28	3
„ 425	17	1	3	7	2	3
„ 428	69	5	1	18	39	18
„ 431	28	1	2	7	21	8
„ 432	15	3	3	2	19	5
„ 433	27	1	2	5	7	1
„ 437	64	2	3	16	—	—
„ 440	36	3	1	13	7	3
„ 441	84	6	5	27	75	19
„ 444	44	1	4	9	32	12
„ 448	23	4	2	5	9	2
„ 449	32	2	6	5	16	3
„ 450	23	—	—	4	—	—
„ 451	21	1	1	11	7	—
„ 452	20	1	—	6	4	1
„ 453	30	—	1	8	24	11
„ 455	47	6	2	14	9	5
„ 462	26	1	—	11	12	6
„ 463	37	1	1	10	12	4
Totals ...	1480	125	96	425		
<i>Expectation</i>	<i>1470</i>	<i>125</i>	<i>125</i>	<i>406</i>		

C. Families from various crosses inside the Emily Henderson strain.

Reference Number	Nature of cross	Purple		Red		White	
		Long	Round	Long	Round	Long	Round
'06, 359	F_2 ex Pic. long \times E. H. round	41	2	3	20	19	3
„ 391	F_2 ex Pur. long \times E. H. round	96	9	7	28	36	7
'07, 164	F_2 ex P. L. round \times Pic. long	32	6	5	8	—	—
„ 165	„ „ „	19	2	2	3	—	—
„ 166	„ „ „	16	—	3	9	—	—
„ 167	„ „ „	18	1	3	3	—	—
„ 168	F_2 ex Red round \times Wh. long (ex Pur.)	22	3	1	8	11	2
„ 170	„ „ „	12	2	4	12	7	1
„ 171	„ „ „	20	—	1	9	5	1
„ 172	„ „ „	18	2	1	5	4	—
„ 173	„ „ „	13	1	—	4	3	1
'08, 121	F_2 ex Pur. long \times T. W. round	68	6	8	16	—	—
„ 122	„ „ „	213	19	17	61	—	—
„ 125	F_2 ex Pic. long \times T. W. round	147	10	10	35	—	—
Totals	735	63	65	221		
<i>Expectation</i>	...	<i>749</i>	<i>63</i>	<i>63</i>	<i>209</i>		

Reduplication Series in Sweet Peas

			Purple		Red	
			Long	Round	Long	Round
Total from Families	A		1700	124	133	433
"	"	B	1480	1 5	96	425
"	"	C	735	63	65	221
Totals ...			3915	312	294	1079
<i>Expectation</i> ...			3871	328	328	1073

TABLE III.

Families shewing coupling between purple and the erect standard.

(Nature of mating BE × be.)

Reference Number	Purple		Red			
	Erect	Hood	Erect	Hood		
'08, 84	139	—	2	44		
'09, 2	67	1	—	22		
'10, 36	6	—	—	2		
" 37	3	—	—	3		
" 38	6	—	—	2		
" 39	17	—	—	6		
" 40	9	—	—	2		
" 41	11	—	—	2		
" 46	22	—	—	5		
" 55	158	—	1	56		
'10 F, 1	206	—	2	37		
" 2—3	178	4	—	45		
" 4	74	—	1	29		
" 5	59	—	—	17		
" 13	60	—	—	18		
" 14	138	1	—	36		
" 15	125	—	1	50		
" 18	57	—	—	11		
" 19	71	1	—	29		
" 20	62	1	—	21		
" 21	48	—	—	20		
" 22	171	2	—	63		
" 23	123	—	—	38		
" 24	168	2	2	71		
" 25	58	—	1	25		
Totals ...			2036	12	10	654
<i>Expectation on } 127 : 1 basis }</i>			2023	11	11	667

TABLE II.

Sterility families homozygous in axil heterozygous in pollen.

Reference Number	Purple		Red		Sterile		White		
	Long	Round	Long	Round	Purple	Red	Long	Round	Sterile
'05, T. L. 2	55	11	8	9	12	7	48	17	20
„ „ 5	75	9	7	13	19	7	48	23	20
'06, 340	28	4	3	16	20	—	28	8	9
„ 360	33	3	3	11	15	3	31	9	10
'07, 90	154	11	6	40	45	23	54	15	22
'08, 98 ¹	63	4	7	15	22	6	—	—	—
„ 100	64	5	6	18	29	11	16	8	13
'09, 3	25	2	2	10	11	2	5	—	5
Totals ...	497	49	42	132	173	59			
<i>Expectation on</i> <i>7:1 basis</i> }	498	42	42	138					

TABLE V.

Families heterozygous in standard, colour, and pollen.(Nature of mating **EBL** × **ebi**.)

Reference Number	Purple				Red				White			
	Erect		Hood		Erect		Hood		Erect		Hood	
	Long	Round	Long	Round	Long	Round	Long	Round	Long	Round	Long	Round
'12, 21	20	3	—	—	—	—	7	10	—	—	—	—
„ 22	71	7	—	—	—	1	9	19	20	—	2	5
„ 23	60	4	—	—	—	—	10	16	20	1	3	5
„ 24	60	7	—	—	—	—	3	20	—	—	—	—
„ 26	58	4	—	—	—	—	7	11	25	3	1	3
„ 27	26	2	1	1	—	—	1	5	10	—	1	1
„ 28	13	1	—	—	—	—	3	2	1	1	2	3
„ 30	34	4	—	1	1	—	9	14	6	1	1	1
„ 31	14	4	—	—	—	—	3	9	19	—	—	4
„ 32	46	3	1	—	—	1	4	14	6	2	3	3
„ 33	46	9	—	1	1	2	5	14	31	4	3	1
„ 34	17	4	—	—	—	—	1	4	9	3	1	5
„ 35	12	3	—	—	—	—	2	1	—	—	—	1
Totals	477	55	2	3	2	4	64	139	147	15	17	32

¹ A sister plant of '08, 98, and '08, 100, gave a remarkably aberrant result. This was '08, 99 in which there were 182 plants. Of these 180 were fertile and only 2 were sterile. As in the sister plants the coloured were all deep purples and Miss Hunt and there is no reason to suspect any error. This almost complete absence of steriles is quite unlike anything else we have encountered and we are unable to offer any explanation.

Reduplication Series in Sweet Peas

TABLE IV.

Families shewing repulsion between erect standard and long pollen.

(Nature of mating $E1 \times eL$.)

Reference Number	Red. Erect		Red. Hood	
	Long	Round	Long	Round
'08, 94	46	21	30	—
„ 95	33	11	10	—
„ 96	46	15	16	—
„ 97	34	24	10	—
Totals ...	159	71	66	—
Expectation ...	148	74	74	—

TABLE VI.

Families heterozygous for pollen, colour, and hood.

(Nature of mating $BLe \times bLE$.)

	Reference Number	Purple				Red		White			
		Erect		Hood		Erect		Erect		Hood	
		Long	Round	Long	Round	Long	Round	Long	Round	Long	Round
F_2 ex Bush \times Cupid	'07, 80	15	2	3	—	—	10	12	3	9	—
	„ 81	17	—	13	—	3	10	15	3	4	—
	„ 82	6	1	6	—	—	1	2	4	1	—
	„ 83	9	2	4	—	—	5	9	3	4	—
	„ 84	4	1	3	—	1	4	6	—	2	—
	„ 85	19	—	11	—	—	10	11	3	6	—
F_3 ex Bush \times Cupid	'08, 101	24	2	16	—	3	14	26	17	12	—
	„ 126	11	—	6	—	4	4	—	—	—	—
	„ 127	38	4	17	—	5	6	6	5	3	—
	„ 128	16	—	8	—	2	11	6	2	1	—
	„ 133	68	—	30	—	12	25	48	31	37	1
	„ 134	30	2	12	2	1	13	11	5	6	—
	„ 135	102	15	51	—	15	49	85	42	49	—
	„ 136	58	8	23	1	7	28	46	21	25	1
	„ 137	22	4	6	—	3	12	11	5	4	—
	„ 139	41	3	22	—	7	19	28	14	10	—
	„ 159	37	4	16	—	8	13	44	14	10	1
	'09, 4	46	4	17	1	4	25	54	19	14	2
	'08, 89	101	7	56	—	14	39	45	24	15	1
	„ 93	66	9	42	—	8	23	37	11	14	1
„ 114	73	4	51	—	1	23	—	—	—	—	
Rep. IV, p. 14	1185	86	605	2	114	499	279	115	128	1	
Totals ...	1988	158	1018	6	212	843	781	341	354	8	

TABLE VII.

Families heterozygous for sterility and axil.(Nature of mating $FD \times fd.$)

Reference Number	Dark axil		Light axil	
	Fertile	Sterile	Fertile	Sterile
'09, 1	49	2	2	11*
„ 2	62	1	1	18
'10, 62	114	2	3	30*
'11, 67	69	3	3	24
'12, 102	24	—	—	5*
„ 104	32	—	—	11*
„ 108	7	—	—	1*
„ 109	14	—	—	7*
Totals	371	8	9	107
From Report IV, p. 16	627	27	17	214
Totals	998	35	26	321
Expectation on 15 : 1 basis	993	42	42	303

	Dark axil		Light axil	
	Fertile	Sterile	Fertile	Sterile
*These six families ...	240	4	5	65
Expectation 15 : 1 basis	226	9.5	9.5	69
The rest	758	31	21	256
Expectation 15 : 1 basis	767	32	32	235

TABLE VIII.

Families heterozygous for axil and sterility.(Nature of mating $Fd \times fd.$)

Reference Number	Dark axil		Light axil	
	Fertile	Sterile	Fertile	Sterile
'08 84	95	45	44	—
„ 95	31	12	21	—
„ 97	37	29	31	—
„ 106	53	17	22	—
„ 107	214	95	102	—
„ 108	43	22	29	—
„ 109	81	50	58	—
„ 110	72	27	39	—
„ 111	110	55	49	—
„ 112	177	73	99	—
'10, 56	27	17	18	—
„ 60	126	59	69	—
'12, 48	49	28	27	—
Totals	1115	529	608	—

* Families also heterozygous for B and L.

Reduplication Series in Sweet Peas

TABLE IX.

F_3 families from F_2 normal fertiles ex F_1 plants heterozygous for sterility and cretinism.

(Nature of F_1 mating = $Nf \times nF$.)

Reference Number	Normal		Cretin		Reference Number	Normal		Cretin	
	Fertile	Sterile	Fertile	Sterile		Fertile	Sterile	Fertile	Sterile
'12, 70	37	22	34	1	'12, 72	×	×	—	—
" 71	22	9	9	2	" 75	×	×	—	—
" 77	×	×	×	—	" 81	×	×	—	—
" 79	×	×	×	—	" 97	33	12	—	—
" 80	8	6	1	—	" 98	×	×	—	—
" 82	12	9	8	—					
" 86	17	10	6	—	'12, 74	66	—	22	—
" 87	49	11	16	1	" 78	16	—	4	—
" 88	11	7	6	—	" 83	×	—	×	—
" 89	×	×	×	—	" 84	42	—	14	—
" 90	24	11	13	—	" 85	36	—	8	—
" 92	11	7	5	—	" 94	×	—	×	—
" 93	×	×	×	—	" 95	×	—	×	—
" 99	12	7	3	—					
'12, 76	90	20	30	34	'12, 73	×	—	—	—
" 91	20	4	5	3	" 96	22	—	—	—

TABLE X.

F_4 families from F_3 parent, '12, 76 (Table IX).

Reference Number	Normal		Cretin	
	Fertile	Sterile	Fertile	Sterile
'13 38	16	8	9	12
" 39	27	17	9	14
" 40	20	7	4	9
" 41	12	6	6	9
" 43	20	7	4	1
" 45	37	9	10	2
" 46	18	7	7	2
" 42	29	—	19	—
" 44	(all four classes present)			
" 47	23	4	5	4
" 136	6	1	1	1

¹ The cross × denotes that the type of plant indicated occurred in these families though the actual numbers were not determined. In all such cases at least 30 individuals were examined. The sign — denotes that the class of individual under which it is placed was not found.

TABLE XI.

Reference Number	Normal				Cretin				
	Dark		Light		Dark		Light		
	Fert.	Ster.	Fert.	Ster.	Fert.	Ster.	Fert.	Ster.	
A. F_2 ex	'13, 48	102	49	31	—	27	6	24	2
$DfN \times dFn$	„ 49	20	17	5	—	4	—	10	—
	„ 50	14	13	5	—	3	1	6	—
	„ 51	40	27	8	—	10	1	17	—
		176	106	49	—	44	8	57	2
B. F_2 and	'13, 52	12	1	1	6	7	—	—	1
F_4 ex	„ 53	17	2	—	12	6	1	—	3
$DfN \times DFn$	„ 113	25	—	2	9	15	—	—	1
	„ 114	31	1	1	6	7	—	—	4
	„ 117	22	—	—	4	3	—	—	3
	„ 123	19	1	—	8	8	—	—	1
		126	5	4	45	46	1	—	13

NOTE ON GAMETIC REDUPLICATION IN *PISUM*.

By CAROLINE PELLEW,

Minor Student of the John Innes Horticultural Institution.

It was shown by Vilmorin and Bateson¹ that when a normal culinary pea having tendrils (*T*) and round seed (*R*) is crossed with the "Acacia" variety in which the tendrils are represented by leaflets (*t*) and the seed is wrinkled (*r*), partial coupling between *T* and *R* occurs in the gametes of *F*₁. The numbers suggested that the system of coupling was 63 : 1. Further investigation of a number of plants of similar composition derived (in various generations) from this cross fully confirm the earlier results. From *round* seeds the numbers obtained were 1466 tendrilled, 20 acacia, on the expectation 63 : 1 system being 1471 : 15.

From *wrinkled* seeds the numbers were 15 tendrilled and 564 acacia, the similar expectation being 18 : 561.

Only seeds of which the starch had been microscopically determined² were used for these results. This precaution is necessary because not very rarely occasional seeds of each class may on external appearances be referred to the wrong class. It should be mentioned that the round and wrinkled seeds, thus determined, though all the offspring of plants heterozygous for these characters, were selected independently of each other.

In these experiments the crosses were in the form *TR* × *tr*, and the coupling was

$$63TR : 1Tr : 1tR : 63tr.$$

Subsequently crosses were made in the form *Tr* × *tR*, a tendrilled

¹ *Proc. Roy. Soc.* 1911, 84 B, p. 9.

² By the method introduced by Gregory, R. P., *New Phyt.* II. 1903, p. 226.

variety having wrinkled seed being crossed with a round-seeded Acacia. The object of this cross was to see whether among the gametes of F_1 repulsion between T and R would occur¹. The F_2 seeds were sorted into round and wrinkled by microscopical examination, and the result showed that repulsion occurred. The round seed produced 502 tendrilled, 270 acacia. The wrinkled seed produced 264 plants, all tendrilled.

The repulsion is presumably partial; but if, as is likely, the gametic distribution is $1TR : 63Tr : 63tR : 1tr$, only one plant in 16,384 would be wrinkled and acacia, so that any proof of this prediction is beyond the scope of practical experiment.

In view of the possibility that factors other than roundness might couple with the factor for tendrils, crosses have been made in which various factors have been introduced with the tendrilled and acacia characters. No signs of coupling or repulsion have been observed in F_2 from such crosses. Among the pairs of characters so tested were tallness and dwarfness, yellow and green cotyledons, purple and white flowers, glaucous and emerald foliage, fasciated and normal growth.

¹ Bateson and Punnett, *Journal of Genetics*, i. 1911, p. 293.

PRELIMINARY NOTE ON SOME EXPERIMENTS WITH A POLYMORPHIC PHASMID.

By J. C. F. FRYER, M.A.,

*Fellow of Gonville and Caius College, Balfour Student in the
University of Cambridge.*

AMONG a large brood of "stick-insects," reared from the egg by Mr E. E. Green, Government Entomologist in Ceylon, it was noticed that, though the ♂s were all similar, two distinct types of ♀ were present. The case seemed to merit a detailed investigation, the preliminary results of which are presented in the following notes.

The insect in question is a typical apterous "stick-insect," the general appearance of which can be seen at once from the plate (Plate III); the special characters studied in the experiments were firstly the colour of the adults, and secondly the presence or absence of pointed conical horns on the head (Figs. 4, 5). With respect to these characters the ♂ never varies; it never has horns, is always dark chocolate brown in colour and is a much more slender insect than the female. In the original brood two forms of ♀ were observed, the one being horned and green in colour, while the other was hornless and yellow.

This dimorphism in the ♀ in relation to the presence and absence of horns leads to a difficulty in determining the specific identity of the insect. It belongs to the division *Clitumnini* of Brunner v. Wattenwyl and Redtenbacher, but falls into the genus *Clitumnus* Stal. or *Cuniculina* B. v. Watt. according to whether the ♀ is without horns or possesses these appendages. Both Westwood in his Catalogue of the Phasmidae¹ and Brunner v. Wattenwyl and Redtenbacher in their celebrated

¹ *Catalogue of Orthopterous Insects, Phasmidae*, p. 9, Pl. 5, Fig. 2.

108 *Some Experiments with a Polymorphic Phasmid*

monograph¹ of the group express a distrust of the character, and it is now evident that the genus *Cuniculina* as described by the second author must be dropped. The hornless ♀ has not been satisfactorily determined, but the horned ♀ appears identical with *Bacillus cuniculus* Westw., and it will be sufficient for this paper if the subject of the experiments is assigned to *Clitumnus* sp?, probably *Clitumnus cuniculus* Westw.

The first two experiments consisted in isolating a horned green ♀ and a hornless yellow ♀ from the original brood and, as the ♂s and ♀s had been left together after reaching maturity, it is assumed that both these ♀s had paired.

The following table shows the distribution of the two pairs of characters among the descendants of these two ♀s and their progeny.

Brood Number	Parentage	Males	Horned green female	Hornless green female	Horned yellow female	Hornless yellow female	
1	Horned green ♀ × ♂ unknown	13	3	3	10	8	
2	Hornless yellow ♀ × ♂ unknown	3	—	—	—	2	
3	Hornless green ♀ 1 × ♂ 1	48	—	38	—	42	
5	Horned green ♀ 1 × ♂ 1	30	3	8	8	11	
6	Horned green ♀ Parthenogenetic	—	12	10	—	—	
7	Hornless yellow ♀ 1 × ♂ 1	Died young. Some ♀s with horns					
8	Hornless yellow ♀ 1 × ♂ 1	10	—	—	1	7	
9	Horned yellow ♀ 1 × ♂ 1	46	4	6	18	23	
10	Horned yellow ♀ 1 × ♂ 1	24	4	2	17	1	
11	Hornless yellow ♀ 2 × ♂ 2	47	—	12	—	43	

Note. The number following an individual shows the brood from which it was taken. Brood 4 died young and is omitted. In Brood 10 the two hornless green ♀s died when immature and there is some doubt as to their colour.

These results are puzzling in many ways, yet certain facts stand out clearly. It is evident that the characters of the presence and absence of horns are Mendelian, as also are those of colouration, and with respect to both it is noteworthy that no intermediates occurred, so that every individual could be assigned definitely to one of the four classes. The connection between the possession of horns and the green colour, suggested by the original brood, evidently does not exist, and the two pairs of characters are probably quite independent of each other. Finally, and most important, is the definite evidence in brood No. 6 of the segregation of Mendelian factors in parthenogenetic reproduction. There appear to be no previous records of this phenomenon and consequently confirmation is desirable; at the same time the absence of

¹ *Die Insektenfamilie der Phasmiden*, p. 196.

♂s and the fact that the segregating character is structural seem to be strongly in favour of the correctness of the result.

As a working hypothesis for the explanation of the experiments as a whole it may be supposed that horns are caused by the presence of a factor *H*, in the absence of which, represented by *h*, the insect is hornless. Similarly as yellow colouration appears to be dominant over green it may be due to a factor *C*, in the absence of which, *c*, the insect is green. Then if the sex factors are represented by *MM* in the ♂ and *MF* in the ♀ it must be supposed that the combination *MM* inhibits the appearance of the female secondary sexual characters.

Under this scheme the ♂s and ♀s must have the following constitutional formulæ.

Males	Horned yellow females	Horned green females	Hornless yellow females	Hornless green females
<i>MMHHCC</i>	<i>MFHHCC</i>	—	—	—
<i>MMHhCC</i>	<i>MFHhCC</i>	—	—	—
<i>MMHHCc</i>	<i>MFHHCc</i>	—	—	—
<i>MMHhCc</i>	<i>MFHhCc</i>	—	—	—
<i>MMHHcc</i>	—	<i>MFHHcc</i>	—	—
<i>MMHhcc</i>	—	<i>MFHhcc</i>	—	—
<i>MMhhCC</i>	—	—	<i>MFhhCC</i>	—
<i>MMhhCc</i>	—	—	<i>MFhhCc</i>	—
<i>MMhhcc</i>	—	—	—	<i>MFhhcc</i>

Brood 1 arose from a horned green ♀ and contained (a) about equal numbers of horned and hornless ♀s, (b) green ♀s and yellow ♀s in the ratio of 1 : 3.

As regards horns the parent ♀ was evidently heterozygous for *H* and the parent ♂ contained *hh*, lacking *H* altogether.

The colour problem is more difficult and can only be explained by supposing that the ♀ paired more than once, which was possible, since it was left for some time in a cage with numerous ♂s. The formula of this ♀ is *MFHhcc* and if it paired first with a ♂ of constitution *MMhhCc* and then with one *MMhhCC* an excess of yellow offspring would be produced.

Brood 3. A hornless green ♀ from brood 1 paired with a ♂ of the same brood and gave approximately equal numbers of hornless yellow and green ♀s. The parent ♀ being *MFhhcc*, the parent ♂ must have been *MMhhCc* and the result is an equal number of yellow ♀s *MFhhCc* and green ♀s *MFhhcc*.

Brood 5. A horned green ♀ from brood 1, paired with a ♂ of brood 1, gave 11 horned ♀s to 19 hornless ♀s, and 11 green ♀s to

110 *Some Experiments with a Polymorphic Phasmid*

19 yellow ♀s, numbers which are difficult to reconcile with the hypothesis. The most probable cross is $MFHhcc \times MMhhCc$ which ought to have given equal numbers of each class.

Brood 6. A horned green ♀ of brood 1 parthenogenetically gave approximately equal numbers of horned and hornless green ♀s. The parent was evidently heterozygous for *H* and the offspring would presumably be $MFHhcc$ and $MFhhcc$.

Broods 7 and 8 are only of interest as showing that horns can be introduced by the male parent.

Brood 9. A horned yellow ♀ of brood 1 by a ♂ of the same brood gave 22 horned ♀s and 29 hornless, while as regards colour there were 10 green ♀s to 41 yellow.

The cross which would give the nearest result to this would be a ♀ $MFHhCc$ by a ♂ $MMhhCc$ giving equal numbers of horned and hornless ♀s and green ♀s to yellow ♀s in the ratio 1 : 3.

Brood 10. A horned yellow ♀ of brood 1 by a ♂ of brood 1 gave 21 horned ♀s to 3 hornless, and 18 yellow ♀s to 6 green. This is another doubtful brood, but the most probable cross to have produced it is $MFHhCc \times MMHhCc$, giving 3 horned to 1 hornless and 3 yellow, 1 green.

Broods 2 and 11. In brood 2 a hornless yellow ♀ gave an F_1 containing only hornless yellow ♀s but in brood 11, the F_2 generation, both hornless yellow and hornless green ♀s appeared—12 green, 43 yellow. The first cross may have been either $MFhhCc \times MMhhCC$, or $MFhhCC \times MMhhCc$, and in either case the F_1 contained individuals of constitution $MFhhCc$ and $MMhhCc$, which if paired would give 3 yellow ♀s, 1 green ♀.

As a whole it is evident that the numbers realised in the experiments do not agree well with those demanded by the hypothesis, but in this connection it is necessary to point out that there was a very high mortality during the early stages of the insect's life, which might easily have disturbed the relative numbers, in which the various forms of ♀ occurred. It is hoped however that further experiments will be made with the species and the results, especially those to be obtained from broods produced parthenogenetically, should be of great interest.

Finally an expression of gratitude must be made to Mr E. E. Green, who provided the material for experiment and thanks are also due to Professor Punnett and Mr L. Doncaster for much advice.

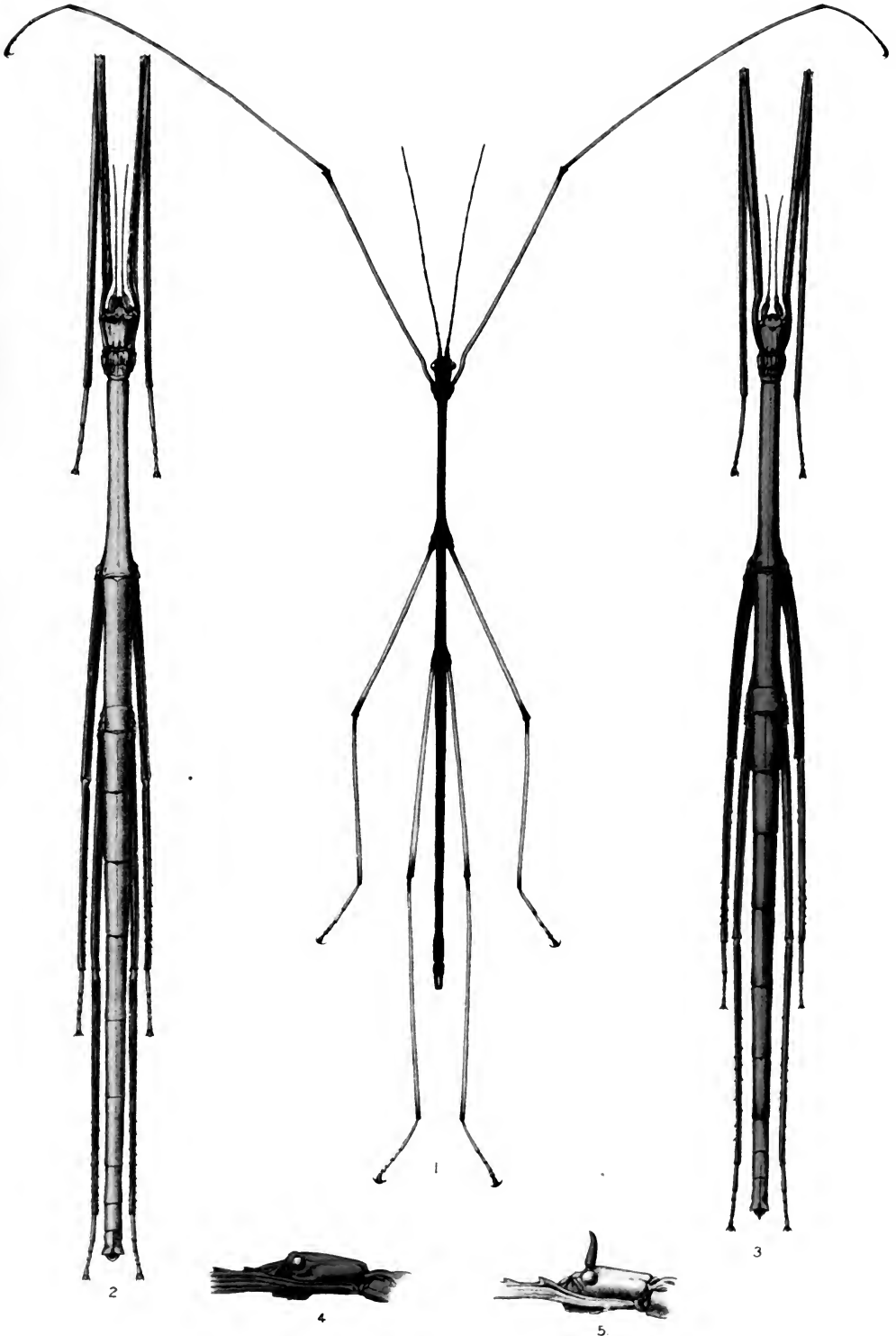

DESCRIPTION OF PLATE.

- Fig. 1. *Clitumnus* sp.? ♂
Fig. 2. ,, ,, ♀ horned yellow.
Fig. 3. ,, ,, ♀ hornless green.
Fig. 4. Side view of head of hornless green ♀.
Fig. 5. ,, ,, horned yellow ♀.

Note. The species is probably *Clitumnus cuniculus* Westw. The exact shade of green and yellow in the two forms of ♀ is not accurate, as the illustrations were made from dried specimens and were coloured from memory only.

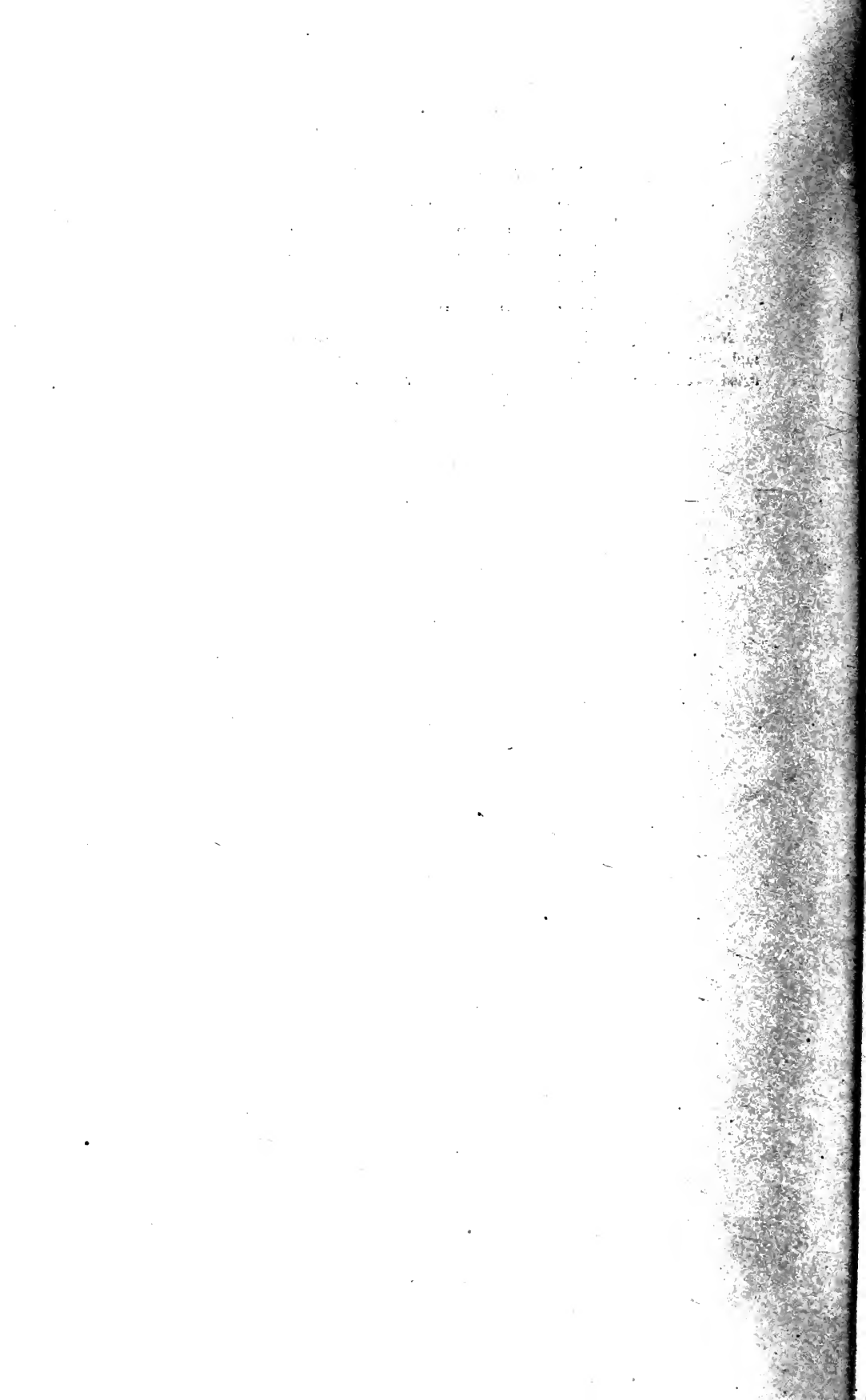

THE SEGREGATION OF FECUNDITY FACTORS IN DROSOPHILA.

BY EDWARD N. WENTWORTH.

THE inheritance of qualitative characters according to the Mendelian scheme is so well established that even the practical breeder questions no longer, but quantitative differences are still somewhat slow in yielding evidence of their accord to this system. Nilsson-Ehle, Shull, East and other plant breeders have indicated the means by which such inheritance may take place, while Phillips has shown an interesting example in size in duck crosses. The heredity of fertility is a subject of practical importance in many species, and the problem resembles those which the investigator has to attack in the genetics of size, vigor, etc. Pearl has made an excellent contribution to the knowledge of the subject in his recognition of a sex-linked fecundity factor in the domestic fowl but beyond this paper little work has been done.

The inception of the present experiment was rather accidental. Early in September 1912 mice gained access to the writer's cultures of *Drosophila* and either devoured or liberated nearly everything. From the wreckage three pupae of orange-eyed flies were rescued which hatched one male and two females. As one female died before mating the idea of making an experimental study to see what would come from inbreeding was conceived. The foundation pair were then average flies in appearance and possessed of the orange-eyed character.

The F_1 generation, if it may be so termed, was composed of 126 flies. From these four lines were started. The largest and most vigorous males were mated with the largest and most vigorous females, the rather weak and small flies were mated together and two lines of medium type, one based on size and the other on apparent vigor were also established. These divisions were not based on any actual measurements, but rather on general appearance and impression. Fortunately the divisions were justified although later generations

114 Segregation of Fecundity Factors in *Drosophila*

showed that their completeness depended on luck and not on any knowledge possessed by the writer.

Table I presents the data from Line I, the strain lacking in vigor. Four pairs were mated, they being respectively designated as A, B,

TABLE I.

Breeding Record of Line I. (A line lacking vigor and high fecundity.)

	Pair A 38 flies		Pair B 34 flies		Pair C 51 flies		Pair D 28 flies									
F_2																
F_3	30	41	28	32	43	39	36	38								
F_4	32	26	21	34	32	35	36	32	28	31	26	30	32	29		
F_5	30	24	26	25	34	31	26	30	42	26	28	36	25	18	34	40
F_6	32	30	29	31	30	26	34	28	44	30	34	40	31	died out	31	41
F_7	26	21	23	24	23	21	29	34	39	24	44	39	27		25	32
F_8	24	25	30	22	24	28	28	24	46	19	60	42	24		21	34
F_9	25	23	19	26	21	25	30	19	30	26	30	39	21		24	27
F_{10}	22	25	23	21	19	27	24	26	36	22	24	34	18		20	28

C and D. The table shows the low state of their fecundity and also the degree to which they bred true. Placed on the basis of the means, for comparative purposes, the last eight generations rank as follows:

F_3	Mean	35.875
F_4	„	30.1
F_5	„	29.7
F_6	„	32.73
F_7	„	28.73
F_8	„	29.4
F_9	„	25.7
F_{10}	„	24.6

The mean of the entire line, nine generations, is 29.5 and the standard deviation is 7.31, giving as coefficient of variability 28.17. The coefficient of variability is of little value as a means of comparing the different lines owing to the fact that the units of variation are the same and the means so widely separated. Therefore it would seem

that the standard deviation is the best method of comparison. The interesting point is the relative constancy with which Line I breeds true for fecundity.

To show that this low type is absolutely distinct let us briefly compare Table I and Table II. While the mean for the low line is

TABLE II.

Breeding Record of Line II. (Strongly Vigorous.)

	Pair A		Pair B		Pair C		Pair D	
F_2	116		132		98		141	
F_3	140	128	110	131	112	122	152	135
F_4	161 127	134 117	144 136	128 137	120 129	116 129	147 160	118 151
F_5	142 138	127 141	116 134	139 151	138 114	101 145	126 154	136 113
F_6	154	136	127	114	141	104	145	162
F_7	136	156	112	144	152	94	139	134
F_8	165	147	141	152	127	96	136	157
F_9	157	138	134	133	141	97	132	172
F_{10}	149	144	129	156	132	100	141	180

29.5 the mean for the high line is 135.86. The means of each generation when compared as in Line I are as follows:

F_3	Mean	128.75
F_4	"	134.625
F_5	"	132.1875
F_6	"	135.625
F_7	"	133.375
F_8	"	140.125
F_9	"	138.000
F_{10}	"	141.375

The mean for the entire line is 135.86 and the standard deviation 18.3. This gives a coefficient of variability of 13.47, lower than the coefficient for the low line although the range of variation is obviously higher as evidenced by the standard deviation. Suffice it to say, however, that the two lines are quite distinct, they overlap in nowise

116 *Segregation of Fecundity Factors in Drosophila*

and have each segregated from the common pair. No deterioration appears, as F_{10} is higher than any preceding generation.

The individuals from which Table III is prepared were descended from four pairs apparently medium in size, while Table IV shows the

TABLE III.

Breeding Record of Line III. (Medium in Size.)

	Pair A		Pair B		Pair C		Pair D	
F_2	81		72		79		84	
F_3	36	137	79	65	112	75	81	87
F_4	31	60	78	142	72	86	34	77
F_5	24	71	74	109	136	150	26	84
F_6	19	68	138	68	65	121	68	82
F_7	31	89	161	75	42	54	28	86
F_8	26	102	124	56	68	26	21	74
F_9	22	86	152	18	86	34	24	69
F_{10}	25	41	148	24	144	32	20	77
					127	40	23	81

TABLE IV.

Breeding Record of Line IV. (Medium in Vigor.)

	Pair A		Pair B		Pair C		Pair D	
F_2	75		80		64		78	
F_3	78	44	82	87	71	69	74	85
F_4	72	76	41	35	71	69	74	85
F_5	68	25	78	64	30	67	74	77
F_6	29	72	28	72	70	29	112	56
F_7	21	141	32	62	112	135	74	76
F_8	26	134	34	68	101	120	71	119
F_9	19	118	29	51	119	124	68	76
F_{10}	22	137	25	34	126	74	78	82
			27	25	117	76	74	73

descendants of four pairs medium in apparent vigor. Since both show the same qualitative results they will be combined for the comparison with Tables I and II. The means of the separate generations follow:

F_3	Mean	78.875
F_4	„	81.1875
F_5	„	83.6875
F_6	„	68.125
F_7	„	60.0625
F_8	„	71.25
F_9	„	69.125
F_{10}	„	66.25

The mean of the entire lot is 72.06, and the standard deviation is 37.1618. This gives the largest coefficient of all, 51.27, and from the standpoint of the coefficient would offer evidence of a 1 : 2 : 1 ratio. That this is merely apparent will be shown a little later in the paper. Summarized we get the following table.

	Mean	Standard Deviation	Coefficient of Variation
Low line ...	29.5	7.3	28.17
Medium line ...	72.06	37.2	51.57
High line ...	135.86	18.3	13.47

A segregation of fecundity factors is clearly evidenced and the supposed weaknesses from inbreeding are shown up in their true light as the mere segregation of factors for lower vigor.

In order to confirm the idea of the relative separateness of these fecundity factors a reciprocal cross was arranged between flies from the hatch of 142 in Line III, pair *A*, F_4 , and flies from the hatch of 30 in Line IV, pair *C*, F_4 . Table V shows the detailed results of this work, the confirmation being absolute. The interesting point brought out is the fact that the male, whether he come from high or low lines, apparently in nowise influences the eggs laid by the female with whom he pairs, though marked differences, apparently due to segregation, may occur among his female descendants.

Further evidence on the nature of such segregation was obtained by breeding all the pairs available in one hatch from an apparently intermediate pair. The pair selected was from Line IV, pair *B*, F_4 , Hatch 82. Thirty-nine males and forty-three females appeared and

TABLE V.

Data from Reciprocal Crosses of Strains High and Low in Fecundity.

F_5 ♂ From Line III, Pair A (hatch 142), ♀ From Line IV, Pair C (hatch 30)

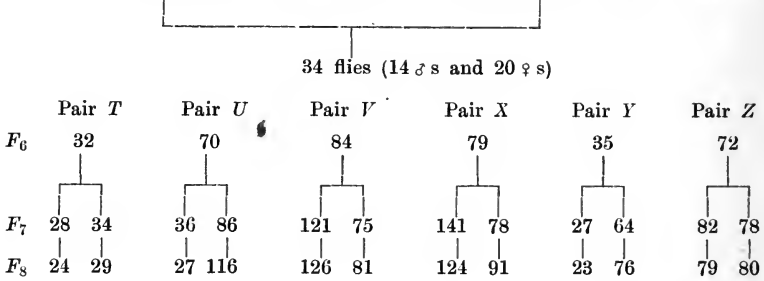

Reciprocal.

F_5 ♂ From Line IV, Pair C (hatch 30), ♀ From Line III, Pair A (hatch 142)

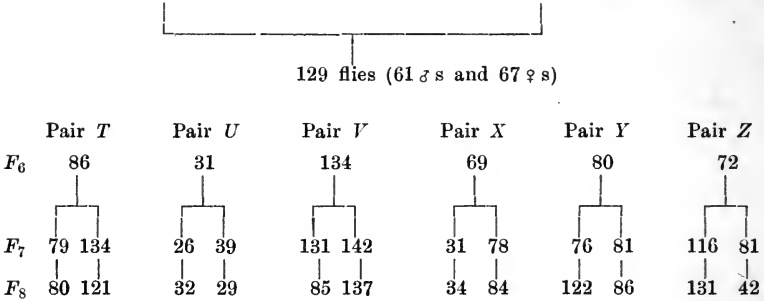

from this thirty-nine cultures were started. The progeny of each of the pairs is listed in Table VI. Instead of three simple groups which

TABLE VI.

The Record of all the Offspring from one Pair of Flies from Line IV, Pair B, F_4 , Hatch 82.

Pair Number	1	2	3	4	5	6	7	8	9	10	11	12	13	14	15
	53	19	99	131	74	38	142	76	40	102	57	129	122	59	42
Pair Number	16	17	18	19	20	21	22	23	24	25	26	27	28	29	30
	77	108	112	78	90	60	88	45	87	107	80	62	87	104	64
Pair Number	31	32	33	34	35	36	37	38	39						
	81	101	81	65	96	84	103	85	82						

might be expected from the previous calculations there are at least

seven. In fact the interpretation on a three-factor basis corresponds very well to the distribution of these pairs. Assuming twenty to be the minimum fecundity, since it is approximately the lowest that segregated out, and one hundred and forty the upper limit with rather wide fluctuations, in all groups the intervening number divides readily into six parts of twenty each. An hypothesis involving three pairs would permit of six factors in the individual homozygous for high fecundity, these factors to be of twenty each. If this were the case, then the expectation and actual results would be as follows, the actual pairs being somewhat arbitrarily distributed owing to their lying intermediate between the groups of twenty.

	Number Factors						
	Six	Five	Four	Three	Two	One	None
Fecundity Number, Offspring ...	140	120	100	80	60	40	20
Expected Number	0.6	3.6	9.0	12.0	9.0	3.6	0.6
Actual Number	1	3	9	14	7	4	1
Number produced by each group on the basis of which the above calcu- lation was made (Cf. Table VI) ...	142	131	99	74	53	38	19
	—	129	102	76	57	40	—
	—	122	108	77	59	42	—
	—	—	112	78	60	45	—
	—	—	107	80	62	—	—
	—	—	104	81	64	—	—
	—	—	103	81	65	—	—
	—	—	96	82	—	—	—
	—	—	101	84	—	—	—
	—	—	—	85	—	—	—
	—	—	—	87	—	—	—
	—	—	—	87	—	—	—
	—	—	—	88	—	—	—
	—	—	—	90	—	—	—

Circumstances prevented the breeding out of these different groups, so no definite confirmation of the above hypothesis can be offered. This does not account for the many progenies that numbered above 140. It is possible that at least four of these factors are concerned in the race instead of three, but the particular pair under consideration apparently bore only three of them. The data used in Tables I—IV inclusive more nearly fit a four-factor hypothesis than the three-factor reported for Table VI. No evidence of sex linkage of fecundity factors appeared.

LITERATURE CITED.

1908. EAST, E. M. "Inbreeding in Corn." *Conn. Agri. Exp. Sta. Report*, 1907—1908, pp. 419—428.
1910. ——. "An Interpretation of Variation that is Apparently Continuous." *Amer. Nat.* Vol. XLIV. pp. 739—746.
1912. —— and HAYES, H. K. "Heterozygous in Evolution and Plant Breeding." *Bul.* 243, *Bureau of Plant Industry, U.S. Dept. of Agriculture*, pp. 58.
1909. NILSSON-EHLE, H. "Kreuzungsuntersuchungen an Hafer und Weizen." *Lunds Universitets Arsskrift*, Vol. v. No. 2, pp. 122.
1912. PEARL, RAYMOND. "The Mode of Inheritance of Fecundity in the Domestic Fowl." *Journal Experimental Zoology*, Vol. XIII. No. 2, pp. 153—268.
1912. PHILLIPS, J. C. "Size Inheritance in Ducks." *Journal Experimental Zoology*, Vol. XII. No. 3, pp. 369—380.
1908. SHULL, G. H. "The Composition of a Field of Maize." *American Breeders' Association Reports*, Vol. IV. pp. 296—301.

MENDELIAN SEX-FACTORS IN MAN.

By J. A. JENKINS.

THAT the numerical equality of the sexes in so many types may be most simply explained on the assumption that one sex is homozygous, and the other sex heterozygous for sex-factors ("maleness" and "femaleness"), is I believe commonly granted. Again, several instances are known in which there appears to be (during gametogenesis) "repulsion" between a sex-factor and a character-unit, resulting in a "sex-limited" descent of that character; but no clear case of "coupling" in similar circumstances has yet been brought forward. A necessary condition for either repulsion or coupling to take place is the heterozygosis of *both* factors in the parent concerned (Bateson, *Mendel's Principles of Heredity*, C. U. Press, p. 151). In sex-limited cases the following general considerations arise:

(1) As by our hypothesis one sex is homozygous and the other heterozygous, the dissimilar sex-factor borne by the latter parent must in all cases be dominant: also, it is in the gametogenesis of this parent that we look for the "sex-limitation."

(2) The process in such cases being due to repulsion existing between dominant factors, we expect to find among the progeny that individuals heterozygous in sex bear the recessive character (of another pair of factors) more frequently than individuals homozygous in sex.

Applying these rules to human colour-blindness, and taking colour-blindness, n , to be recessive to normal vision, N (as shown to be the case by Doncaster, *Journal of Genetics*, Vol. I. p. 378), we see that probably in Man, the female is homozygous and the male heterozygous

for sex-factors, and that "maleness" is dominant to "femaleness." Individuals (zygotes) may therefore be represented as:

Normal female	$NN \text{ ♀♀}$	Colour-blind male	$nn \text{ ♂♂}$
Colour-blind female	$nn \text{ ♀♀}$	"Normal" male	$n \text{ ♂} . N \text{ ♀}$
Heterozygous (apparently normal) female				$Nn \text{ ♀♀}$	(repulsion existing between N and ♂)	

The various equations become:

(a) Normal female \times *CB* male.

$$NN \text{ ♀♀} \times nn \text{ ♂♂} = Nn \text{ ♂♀} + Nn \text{ ♀♀}.$$

(b) Heterozygous female \times "normal" (really heterozygous) male.

$$Nn \text{ ♀♀} \times n \text{ ♂} . N \text{ ♀} = nn \text{ ♂♀} + Nn \text{ ♂♀} + Nn \text{ ♀♀} + NN \text{ ♀♀}.$$

(c) Heterozygous female \times *CB* male.

$$Nn \text{ ♀♀} \times nn \text{ ♂♂} = nn \text{ ♂♀} + Nn \text{ ♂♀} + nn \text{ ♀♀} + Nn \text{ ♀♀}.$$

(d) *CB* female \times "normal" (really heterozygous) male.

$$nn \text{ ♀♀} \times n \text{ ♂} . N \text{ ♀} = nn \text{ ♂♀} + Nn \text{ ♀♀}.$$

If the above view of the sex-composition of Man be accepted, it of course follows that the sex of offspring is determined, not by the mother, but by the father, in Man.

(Received 1 Jan. 1913.)

ON THE RECOGNITION OF THE INDIVIDUAL BY HAEMOLYTIC METHODS.

By CHARLES TODD, M.D.

THE discovery and elaboration of the so-called "Immunity Reactions" show signs of proving one of the greatest advances made by biological science during recent years, and though discovered originally by bacteriologists in connection with the study of disease, and for a time practically limited to bacteriological research, the significance of these reactions has since overflowed into other fields, and they now constitute our most valuable method for the identification of the proteins.

For the benefit of those unacquainted with the subject of immunity we may briefly instance one or two concrete examples indicating the nature of some of these reactions. If, for example, a rabbit is injected with the white of a hen's egg, it is found that after a certain interval of time the blood-serum of the rabbit which has been so treated has acquired the property of causing a precipitate when added to a solution of hen's egg albumen. This reaction is extraordinarily sensitive—a dilution of even 1 in 100,000 of the albumen still giving a precipitate. It is, moreover, specific, that is to say, the serum, if used in suitable dilutions, only gives a precipitate with the albumen of the hen's egg and not with that of other birds such as ducks, geese etc.

In the same way if a rabbit is injected with human blood, the serum of the rabbit acquires the property of causing a precipitate in solutions of human blood and this constitutes a valuable method of distinguishing human from other blood—a method now in regular use for medico-legal purposes.

The statement that these reactions are specific requires qualification as this is only the case in certain dilutions. If strong solutions are used the serum causes precipitates, not only in solutions of the blood

of the animal used for the injection, but also in those of closely allied species. As the degree of dilution is increased, however, the precipitates given with allied species gradually diminish until a point is reached where the serum only gives a precipitate with the blood of the species for which it has been prepared. Taking advantage of this fact, the method has been used to investigate the relationship of the various animal species to one another and most interesting results in this direction have been obtained, notably by Nuttall and Uhlenhuth. These observations have shown the relationship of man to the ape, and the fact that the apes of the old world are more closely akin to man than those of the new.

These methods are extraordinarily delicate and Uhlenhuth has shown that by their help it is quite possible to distinguish between such closely allied bodies as the albumen of the fowl's egg and the albumen of the blood of the same bird—a difference which is, of course, far beyond the reach of our present chemical tests.

It is impossible here to go into the many interesting results which have been obtained by means of the precipitin reaction, but reference may be made to the work of Uhlenhuth and Roemer on the protein substances of the crystalline lens of the eye. These observers found that the crystalline lens of all animals, right down the zoological scale as far as the fishes, possesses a biologically similar protein which moreover appears to have no connection with the blood proteins of the same animal—a serum prepared for instance with the lens material of the ox gave a precipitate equally with solutions of the lenses of the pig, man, fowl, frog etc., but gave no precipitate with the blood of these animals, so that the lens must therefore be regarded as regularly consisting of a protein foreign to the organism.

Another well known immunity reaction which is now in everyday use for the practical diagnosis of typhoid and Malta fevers etc. is the so-called "agglutination test" which depends upon the fact that when certain bacteria (e.g. the typhoid bacillus) are injected into an animal the serum of the animal so treated becomes agglutinating for the species of bacillus injected, that is to say when added to a suspension of the bacilli, it causes these to clump together and fall to the bottom of the vessel in which they are contained. The exact nature of this phenomenon is not known, though various explanations have been suggested; it would appear however that the agglutination is most probably due to some change in the surface tension existing between the bacilli and the fluid in which they are suspended.

All the immunity reactions which are known appear to depend upon the fundamental fact that when a foreign protein is injected into an animal, the organism responds by the formation of an "antibody" which is specific for the protein injected. This specificity is extraordinarily complete and the relation between the protein and the corresponding antibody has been compared to that existing between a complicated lock and its key. It appears to be a *sine qua non* that the injected substance should be a colloid, and carbohydrates, fats etc. do not give rise to the formation of antibodies.

If half a dozen different foreign proteins be injected into an animal at the same time, the corresponding six antibodies duly appear in the serum; and it is difficult to suppress a feeling of astonishment at the perfection of a mechanism which enables the animal organism, within the space of a few days and with no apparent exertion, to synthesise a series of new compounds of such extraordinary complexity.

The number of antibodies which are known is now very large and is constantly increasing, but the above examples are probably sufficient to give a general idea of the conditions under which immunity reactions take place, and we may proceed at once to consider the question of haemolysis with which we are more immediately concerned.

The study of haemolysis, thanks to the labours of Bordet, Ehrlich and Morgenroth, and a host of other workers, has added greatly to our knowledge of the phenomena of immunity, and haemolytic methods now find their place in the routine work of most bacteriological laboratories. The subject is unfortunately of very great complexity, and its somewhat appalling nomenclature has hitherto not tended to render it attractive to workers in other branches. The phenomena in themselves are however simple, and by keeping to concrete cases and avoiding as far as possible technical terms, are easily described.

Supposing, for instance, a rabbit is injected with the red blood corpuscles of the ox, it is found that the serum of the rabbit, which before treatment had no action on ox corpuscles, acquires after a few days the power of dissolving these corpuscles very rapidly, owing to the formation of a haemolytic antibody or "haemolysin" in the serum. We can show that the haemolytic action is actually due to the presence of this haemolysin, by mixing some of this haemolytic serum and fresh ox corpuscles and keeping the mixture at 0° C. overnight in the ice safe and then centrifuging. At this temperature no haemolysis takes place but the haemolysin is bound by the corpuscles, and is entirely

removed from the serum, which is now found to be without any trace of solvent action on fresh corpuscles.

The serum of the rabbit which has been injected with ox corpuscles resembles the precipitin sera referred to above in that it is not strictly specific, but in addition to haemolysins for the ox, also contains haemolysins for animals of species allied to the ox, such as the sheep, goat etc.

If it is desired to remove these secondary haemolysins, this is easily accomplished by the method of "exhaustion" or "elective absorption." Supposing, for instance, we wish to remove the haemolysin for the sheep, it is only necessary to "exhaust" the serum with sheep's corpuscles, i.e. to leave it in contact with sheep's corpuscles at 0° C. and then remove these corpuscles by centrifuging. The serum is then found to be quite without action on sheep's corpuscles, whilst it remains still active for the corpuscles of the ox. In this way sera, which are originally haemolytic for two or three species, can be artificially rendered haemolytic for only one of them, that is to say they can be made more specific.

Bordet having shown that the injection of blood corpuscles into an animal of a *different* species gave rise to a haemolysin, Ehrlich and Morgenroth investigated the results of injecting animals with the corpuscles of other animals of *the same* species and found that in this case also as a rule a haemolysin is formed. They injected a goat with blood obtained from another individual of the same species and found that the serum of an animal so treated became haemolytic for the corpuscles of the individual whose blood was injected, and also for those of other goats but never for its own corpuscles. (To use their nomenclature: it became *isolytic* but not *autolytic*.)

By injecting goats with goat's corpuscles, thirteen of these isolytic sera were prepared and a careful study of their properties, by methods too complicated to be gone into here, revealed the fact that they all differed from one another, i.e. that they represented different isolysins.

The investigation of the isolysins was continued by Todd and White^{(1), (2), (3)} who had at their disposal 106 cattle which in the course of their immunisation with cattle plague had been injected with large quantities of the blood of other cattle.

An examination of the sera of these animals showed that 76 of them were very highly haemolytic for the corpuscles of normal cattle and a detailed investigation gave most interesting results.

When one of the sera was tested on a series of corpuscles of different normal cattle, it was found that the haemolytic power of the serum was quantitatively very different for the corpuscles of different individuals; being very highly haemolytic for some, less so for others, and again comparatively slightly so for others. In a similar test made on the corpuscles of the same individuals but with a second serum the same variations were observed but they did not coincide with those obtained with the first serum, that is to say corpuscles which were highly haemolysed by the first serum were often comparatively slightly affected by the second and *vice versa*. When the tests were extended to other sera similar results were obtained—in short no two sera appeared to be absolutely alike.

It was next found that if one of these isolytic sera is exhausted with the corpuscles of a particular individual ox (*A*), it remains haemolytic for the corpuscles of many other individuals, but loses its haemolytic power for the corpuscles of some other individuals as well as for those of (*A*).

If now a second isolytic serum is exhausted with the corpuscles of the same individual (*A*) and then tested, its action on the various corpuscles is not exactly parallel to that of the first serum and often shows marked differences. This result is to be expected as it was shown by Ehrlich and Morgenroth that two goats each injected with similar doses of the same goat's blood at the same time gave quite different isolysins.

As a matter of fact the isolysins formed depend upon two distinct factors:

- (a) The individuality of the injected corpuscles.
- (b) The individuality of the animal into which they are injected.

When we consider the enormous number of variations possible in each of these factors, we see the almost unlimited possibilities in the resulting sera.

In view of the above it should be possible by taking a mixture of a sufficiently large number of immune sera and exhausting this with the corpuscles of one individual, to obtain a serum which has no haemolytic action on these corpuscles but haemolyses those of all other individuals of the same species and might therefore be made use of for the identification of this particular individual.

To test this a mixture was made of between 60 and 70 of these isolytic sera. This mixture was then exhausted with the corpuscles

of a normal ox and then tested on the corpuscles of 110 different individual cattle. It was found that the mixture was powerfully haemolytic for the corpuscles of every one of these 110 individuals but absolutely without action on the corpuscles of the individual for which it had been exhausted. A number of other tests was made by exhausting the serum with the corpuscles of various individuals and similar results were always obtained, except in the case of close blood-relations where certain exceptions occur which will be referred to later.

We may therefore conclude that the red blood corpuscles of any individual (excluding for the moment the question of close blood-relations) possess characters which differentiate them quite distinctly from the red blood corpuscles of any other individual even of the same species.

Being now in possession of a method of identifying the corpuscles of a certain individual even in the presence of corpuscles of other individuals, it was possible to study the question of what happens when the corpuscles of one individual are introduced into the circulation of another individual of the same species. Eight oxen were injected intravenously with the fresh blood of other oxen, quantities of from two to four litres of blood being injected. In all these animals a similar course of events was observed, the number of the foreign corpuscles in the circulation gradually diminishing until they disappeared after a lapse of from four to seven days after the injection. Shortly after the disappearance of the foreign corpuscles from the circulation, the blood serum began to acquire haemolytic properties. These experiments emphasise in a most striking manner the definite individuality of the red blood corpuscles, and we see that the injected corpuscles are not merely not accepted by their new host, but are regarded as definitely foreign and in fact give rise to the formation of corresponding antibodies in accordance with the general laws of immunity.

Having found that it was possible to distinguish the corpuscles of non-related individuals of the same species several tests were made on the corpuscles of closely related individuals. A mixture of a large number of haemolytic sera was exhausted separately with the corpuscles of a cow and her calf. It was found that while exhaustion of the serum with the corpuscles of the calf removed the haemolysin for the calf only, exhaustion of the serum with the corpuscles of the cow removed the haemolysin not only for the cow but also for the calf. A similar

examination of a family of sheep (consisting of the father, mother and three lambs) showed the interesting fact that the corpuscles of one lamb resembled almost exactly those of the mother, whilst the corpuscles of the other two lambs had the characters of the father.

From what has preceded we see that it can be definitely proved by tests made in vitro that in the case of a warm-blooded animal the red blood corpuscles of any one individual are different from those of any other individual of the same species (always excepting the case of close blood-relations). Moreover the corpuscles of one individual when introduced into the blood-stream of another individual are regarded by their new host as foreign bodies and are treated as such. A consideration of this very striking fact at once leads to speculation as to whether this is not merely one example of a general law holding for all the cells of the body. Unfortunately the other cells present much greater experimental difficulties than the red blood cell, whose delicate stroma renders it accessible to the quite extraordinarily sensitive methods of haemolysis; we have, however, a considerable amount of indirect evidence in favour of this view, derived mainly from the results of transplantation of the various tissues in man and other warm-blooded animals. Schöne, in his most interesting work (*Die heteroplastische und homöoplastische Transplantation*), summarises the results of other observers and also gives an account of his own extensive researches on this subject. Perhaps the most striking results given are in connection with skin grafting. It is now generally recognised that whereas skin grafts replanted on to the individual from which they were taken (autoplastic transplantation) succeed with ease; those planted on to a different individual of the same species (homoioplastic transplantation) are exceedingly rarely, if ever, successful, unless the two individuals happen to be blood-relations. Schöne working with mice found that homoioplastic transplantation failed almost as regularly as autoplastic transplantation succeeded. His experiments with blood-relations showed that transplantation between brothers and sisters and from the child to the mother were possible; but, curiously enough, in the few cases in which it was tried, transplantation from the mother to the child did not succeed. This result is particularly interesting in connection with the haemolytic experiments recorded above on the difference between the red blood corpuscles of the cow and her calf. In the transplantation of bone Axhausen's most careful experiments show that autoplastic transplantation succeeds much better than homoioplastic. Rehn has shown that the same holds good for the transplantation of fatty tissue,

and other observers have proved the same fact for the transplantation of the thyroid gland and the ovary. It is a matter of common knowledge that the blood cells, both red and white, live considerably longer in their own serum than in that of another individual of the same species and a considerable amount of similar indirect evidence is available.

In view of the above facts we are probably justified in assuming as a working hypothesis that, at any rate in the case of the warm-blooded animals, all the cells of the body of an individual are, so to speak, stamped with his individuality and are different from the same cells of any other individual (not a blood-relation), even of the same species.

REFERENCES.

- (1) TODD, C. and WHITE, R. G. *Proceedings of the Royal Society, B.*, Vol. LXXXII. 1910, p. 416.
- (2) ——. *Proceedings of the Royal Society, B.*, Vol. LXXXIV. 1911, p. 255.
- (3) ——. *Journal of Hygiene*, Vol. x. 1910, p. 185.

SOME POINTS OF GENETIC INTEREST IN REGENERATION OF THE TESTIS AFTER EXPERIMENTAL ORCHECTOMY IN BIRDS.

By C. J. BOND.

IN 1906 I published some observations on the result of unilateral oophorectomy in Rabbits (see "Inquiry into some points in uterine and ovarian physiology and pathology in Rabbits," *B. M. J.*, July 21st, 1906). In this communication it was shown, among other results, that the removal of one ovary in the female Rabbit is followed by a compensatory overgrowth in the remaining ovary, and further that this hypertrophy affects both the Graafian follicles or ova-bearing cells and the internal secretion-forming cells.

At this point it seemed desirable to ascertain whether the same process occurs in the remaining testis after unilatèral orchectomy.

This was found to be the case in Birds but during this experimental investigation¹ some further facts were elucidated which seem to me to have some important genetic interest.

In the first place it was found in both male Fowls and Pigeons that when one or both testes were removed intracapsularly, that is to say when the testicular substance had been apparently wholly removed and the capsule alone left, a regeneration of the secreting tissue of the testis and the tubuli seminiferi took place within the capsule so evacuated.

In a certain period of time, varying from six weeks to six months, the whole substance of the normal-sized testis may be thus restored. Fig. 1 shows the naked-eye view of two testes so regenerated in each of two cockerels, in one case (22 c.) after six months and in another (20 c.) after seven months. Pl. IV, fig. 2 shows a transverse section of

¹ The actual operations connected with this investigation were kindly performed for me by Sir V. Horsley, F.R.S., at University College, London.

one of these testes so regenerated under a low magnification, 3" obj. Pl. IV, fig. 3 shows a portion of the same section under a higher magnification, $\frac{1}{4}$ " obj. In some sections the regenerated tubuli seminiferi are seen to be filled with spermatozoa as in the normal gland.



Fig. 1. Regeneration of the Testes after Subcapsular Castration in Fowls. (From Photo.)

Thus it is clear that a real regeneration of sperm-bearing testicular tissue occurs after subcapsular orchectomy and this regeneration must take place either from the capsule, or more probably from microscopic fragments of secreting tissue which are left adhering to the capsule at the time of the operation.

Such evidence as exists goes to show that regeneration of testicular substance within the capsule after removal does not occur, at any rate to any appreciable extent in the case of some mammals. This is a matter of some importance. The domestic fowl has undergone a process of artificial selection in regard to the egg-laying capacity of the female sex gland, and probably also in regard to the sperm-forming capacity of the male sex gland, hence it is of interest to find that the testis of the domestic fowl has great powers of structural and functional regeneration after partial removal, greater apparently than exists in mammals.

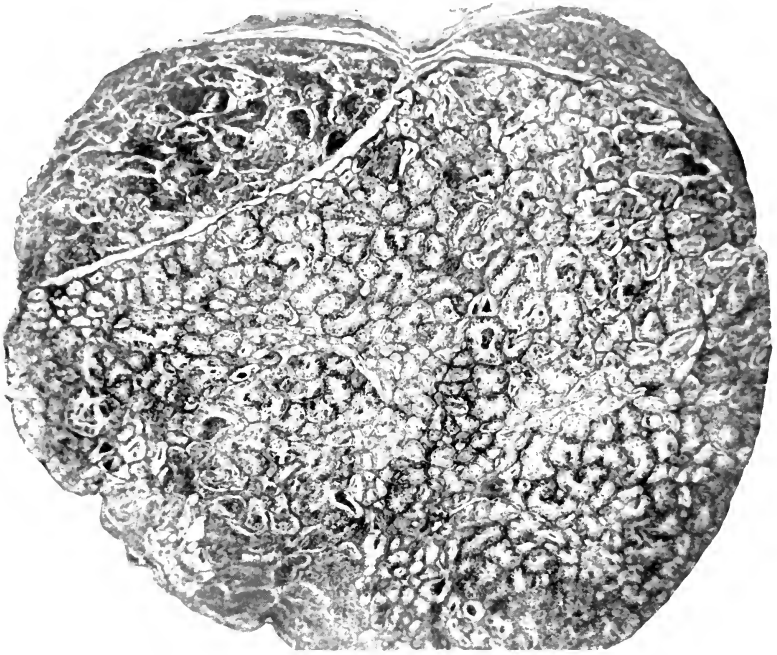
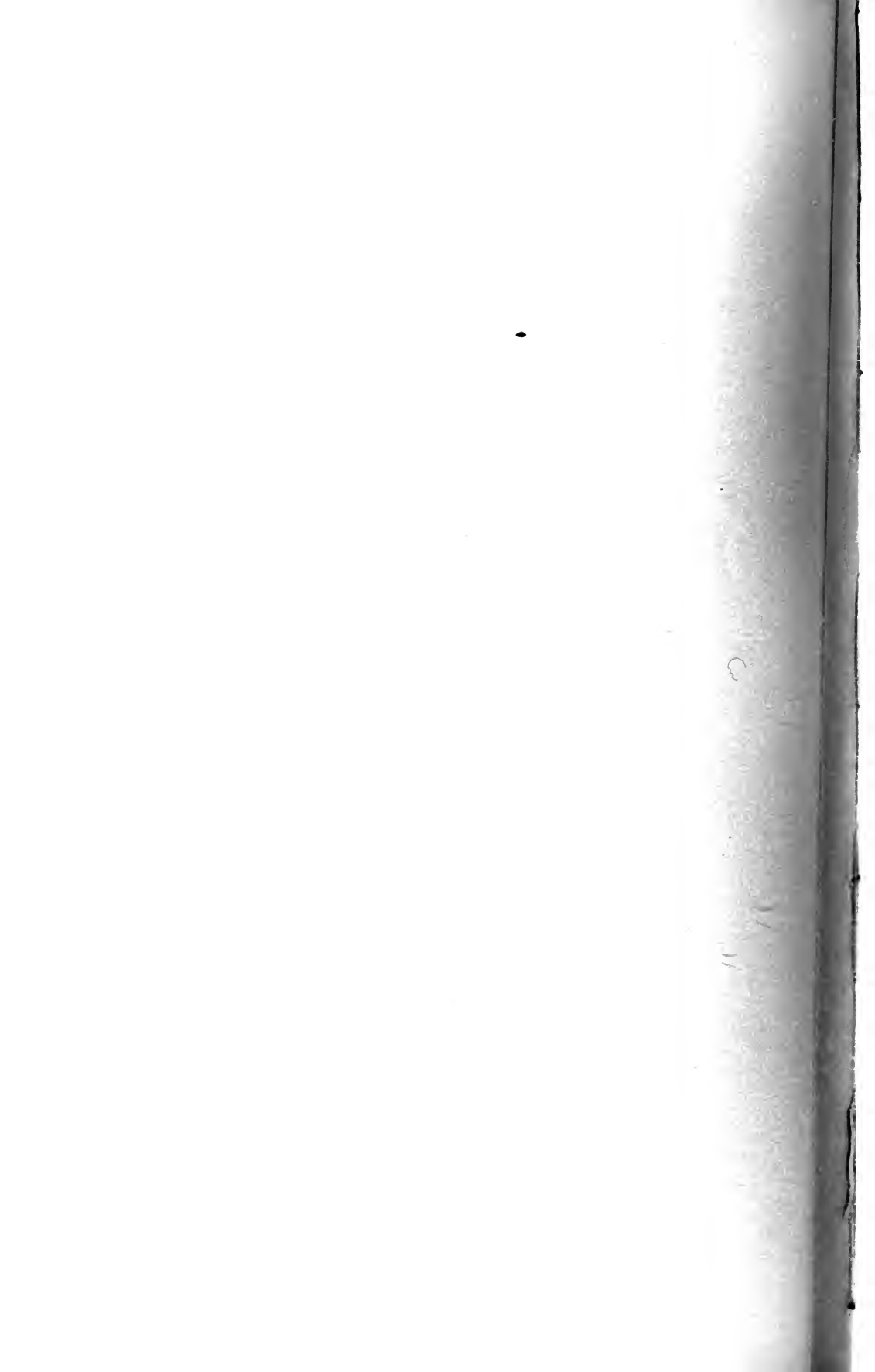

Fig. 2. Transverse Section of Testis of Fowl after Regeneration. 3" obj.



Fig. 3. Transverse Section of Regenerated Testis of Fowl. 4" obj.



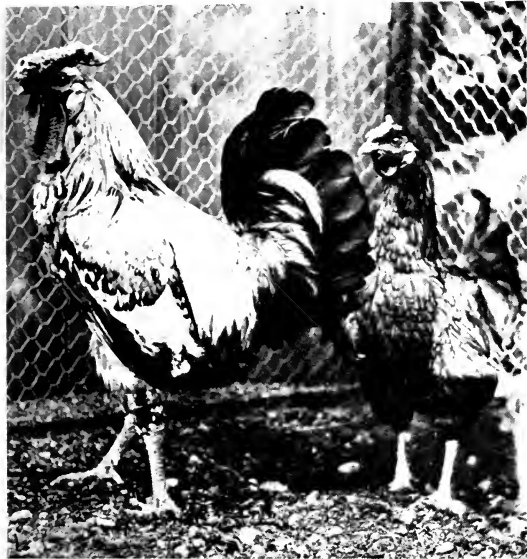

Fig. 4. Cock, Wyandotte Type, and Hen, Brown Leghorn Type. Father and Mother of Cockerel 7.



Fig. 5A. Cockerel 7, and daughter after Castration.

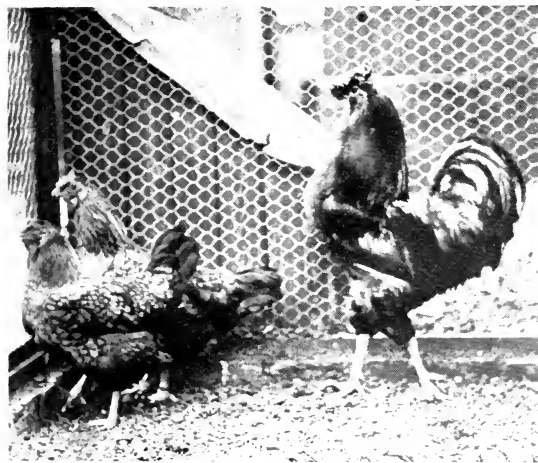

Fig. 5. Cockerel 7, and Sister Hen (mated) and daughter before Castration.



Fig. 10. Shows regenerated ovary in Hen, 1 year and 9 months after destruction by Cautery.

x Regenerated ovary.

Having ascertained that reformation of gamete-bearing tissue *does* occur after removal in the male Fowl it became a matter of genetic interest to ascertain whether the gametes which are formed in this regenerated tissue resemble, in their hereditary characters, the gametes which are formed by the original gland before removal. I will now describe some experiments on Fowls and Pigeons which bear on this point.

Experiment 1.

A Hybrid Silver Wyandotte and Brown Leghorn Cockerel (Cockerel number 7) was bred of the following Genetic composition:

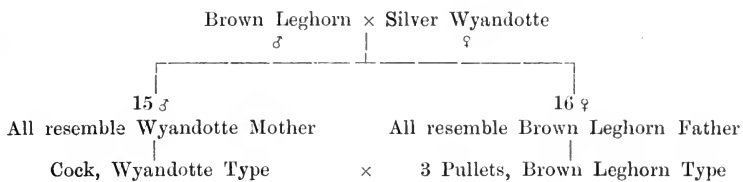

Pl. V, fig. 4.



Pl. V, fig. 5.

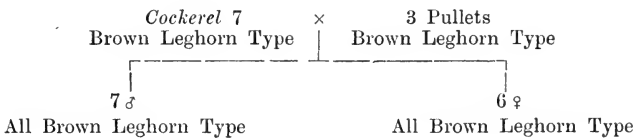

Pl. V, fig. 5 (a).

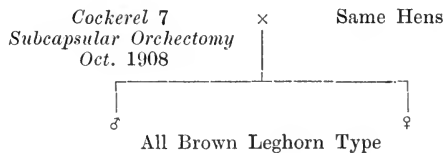

Thus *Cockerel 7* produced chickens of the same Brown Leghorn Type before and after regeneration of the testis, when mated with the same hens.

Fig. 6 (p. 134) shows a photo of the regenerated testes, life size, when the bird was killed in June 1910.

Fig. 7 shows the normal testes of a cockerel aged two years, life size, for comparison.

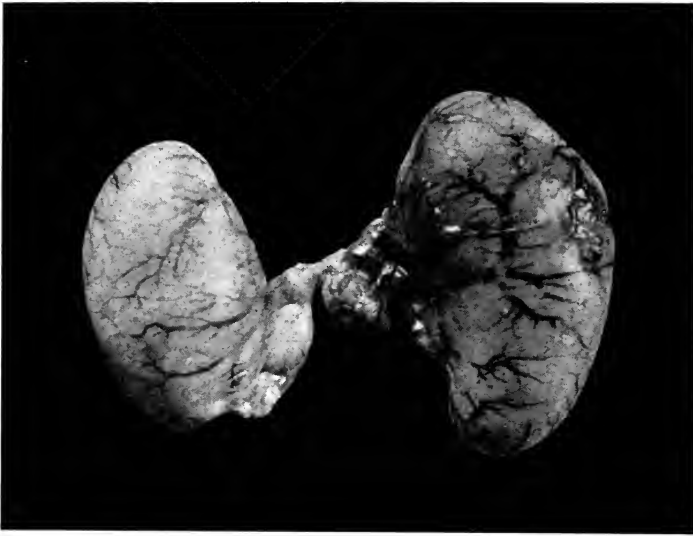

Fig. 6. Photo, Life Size. Regenerated Testes 1 year and 9 months after Subcapsular Castration. Cockerel 7.

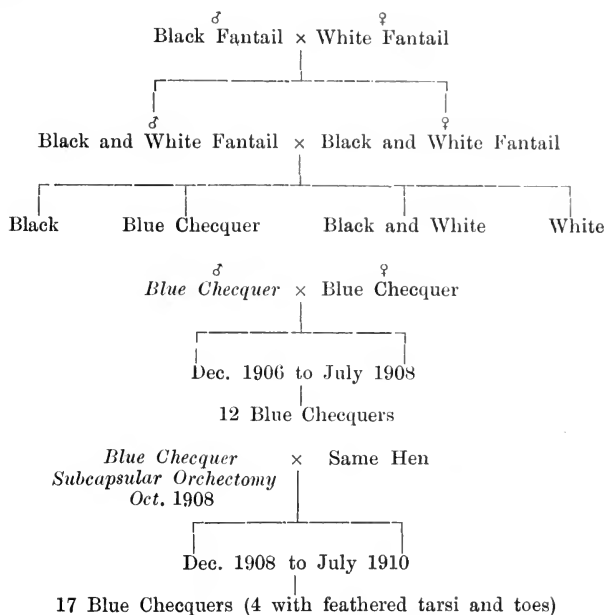

Fig. 7. Photo, Life Size. Normal Testes, Cock, aged 2 years.

REGENERATION OF TESTES IN PIGEONS.

Experiment 2.

A Blue Checquer Fantail was bred of the following Genetic composition :



The offspring of this Blue Checquer Cock after regeneration of the testes are identical in plumage with offspring hatched before subcapsular orchectomy.

One point should be noted. Among the young hatched before castration none showed any feathers on the toes, whereas out of the 17 hatched after regeneration of the testes four showed signs of feathered tarsi.

Fig. 8 (1) (p. 136) shows the regenerated testes (life size) of the *Blue Checquer Cock* one year and seven months after castration.

Fig. 8 (2) shows photo of normal testes (life size) of a White Fantail for comparison.

Fig. 9 (1) shows photo of the testes (atrophied), life size, removed from a White Fantail aged nine years which had been sterile 18 months.

Fig. 9 (2) shows the normal testes of a Fantail three years old of the same size.



Fig. 8. (1) Shows Regenerated Testes. Life size of Blue Chequer Cock.

(2) Shows Normal Testes of Fantail. Same size and age for comparison.

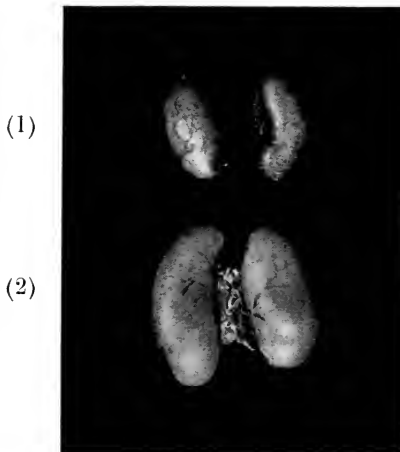
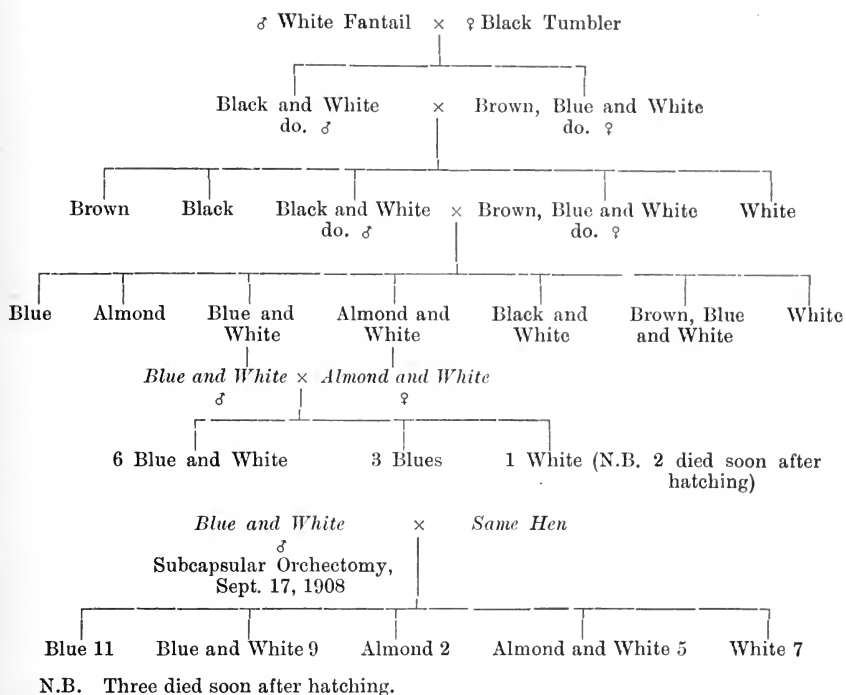

Fig. 9. (1) Shows Photo Life size of Atrophied Testes removed from Fantail Cock, age 9 years, Sterile 18 months.

(2) Shows Normal Testes of Fantail, same size 3 years old.

Experiment 3.

A Hybrid Tumbler Fantail Pigeon was bred of the following Genetic composition :



From the above table we see that the *Blue and White* Cock mated with an *Almond and White* sister produced, before castration, 10 young pigeons of which number one only was white. After castration and regeneration of the testes the same pair produced 34 young pigeons of which seven were white.

It is interesting to notice that in the smaller number of young hatched before castration, the proportion of Recessive White to the rest was 1 in 10, while after castration and regeneration of the testes the proportion of Recessive White to the rest (in the larger numbers) was nearly 1 in 5.

Although in the case of the fowl the male contribution to the zygotes hatched before and after regeneration of the testes were alike in character, as judged by the appearance of the chickens, this result may have been due to the fact that only one kind of gametes was being formed by the testes of the particular bird operated on, and so the

renewed growth of the testes after removal in this bird only led to the reproduction of the original kind of gametes.

CONCLUSIONS.

Such are the facts brought out by this investigation. Such as they are, they seem to indicate that the cell divisions of the mother sperm-cells which provide the new spermatozoa formed during regeneration of the testis do not take place in exactly the same order, or are not exactly of the same kind, as those which form the sperm-cells before removal of the sex gland.

Thus in *Experiment 2* among the 17 young pigeons hatched after castration of the male parent, four showed feathers on the tarsi and toes, while among the 12 hatched before castration none were so marked.

Again in *Experiment 3* (as has already been stated) the proportion of Recessive Whites rose from 1 in 10 before, to 1 in 5 after castration of the male parent.

It is true that in *Experiment 1* chickens hatched from eggs fertilized by Cockerel 7 when mated with three hens (sisters to cockerel) resemble the chickens hatched from eggs by the same hens fertilized after the testes had been regenerated. But the question of the genetic composition of this bird must be considered. If the bird was homozygous in respect of this character of colour, that is to say if only one kind of gametes were being produced before castration, then there is no reason to think that the increased production of spermatozoa set going, during regeneration of the testis after subcapsular orchectomy, would result in the production of gametes of a different kind.

The suggestion is, that in a sex gland where gametes of different factorial composition are being produced the temporarily arrested and the subsequently increased cell division due to the stimulus of removal of the organ would be likely to result in a different rate, or order of production of, the different kinds of gametes which are being formed in that particular male organ. This can of course only be judged of by a comparison of the zygotes which are hatched from eggs fertilized by these male gametes before and after this stimulus of removal has been applied.

For this reason it seems desirable to simplify the conditions of the experiment and to remove the male organs in fowls which are known to be producing gametes of two kinds only. Further experiments

should also be undertaken showing the effect of partial removal of the ovary in heterozygous hens, in order that the influence of regeneration may be tested in the case of female as well as male gamete-forming organs. There is, I think, no doubt from experimental evidence that the ovary in the Fowl does undergo regeneration after partial destruction or removal.

Thus the ovary was destroyed by the actual cautery in a hen aged 1 year as far as could be seen with the naked eye wholly. On examination 1 year and 9 months after the operation the ovary was found to be fully regenerated and functionally active, a number of eggs having been laid, see Pl. V, fig. 10.

If these results are confirmed, that is to say, if it can be shown that the effect of the stimulus to renewed growth which follows castration, is to alter the character of, or the proportionate rate of cell division in, the cells which produce the male gametes then it will be necessary to study these changes in cell division in detail, because it is possible that certain results in breeding which seem to be inconsistent with Mendelian expectation may owe their apparent anomaly to some change in the rate of reproduction of gametes of different kinds in that particular sex gland.

For instance, the normal relative proportion of male to female chickens hatched at different times of the year varies, and this fact suggests a seasonal difference in the relative production of male and female zygote-forming sperm-cells.

[The explanation of Plates IV and V is to be found on the plates themselves.]

STUDIES OF INHERITANCE AND EVOLUTION
IN ORTHOPTERA I.

BY ROBERT K. NABOURS.

*Paper 3. From the Zoological Laboratory, Kansas State
Agricultural College.*

CONTENTS.

	PAGE
I. Introduction	142
II. Material and Method	142
III. Analyses of gametic constitutions and the inheritance of colour patterns	144
(1) An analysis and the inheritance of the colour patterns of forms of the appearance of texanus, leuconotus, leucothorax and punctofemorata	144
(2) An analysis and the inheritance of the colour patterns of forms of the appearance of luteolineatus and rufolineatus	150
(3) The interbreeding of heterozygotes	155
(4) Further hybridization and the inbreeding of the heterozygotes	157
(5) Results from the mating of heterozygotes with one or the other of the parent forms	159
IV. Long and Short wingedness	160
(1) Long and short wingedness in nature	160
(2) Long and short wingedness in the breeding experiments	162
V. An examination of the location, arrangement and relations of the pigmental elements in the colour patterns of the parent forms and their hybrids	164
VI. Discussion	166
(1) The inheritance of the colour patterns	166
(2) The appearance of long and short wingedness	167
(3) Equivalence in the hybrids	168
(4) The "genotype conception" applied to the behaviour of these forms	168
VII. Conclusions	169
Bibliography	170
Journ. of Gen. III	10

I. INTRODUCTION.

THE well-known experiments of Mendel, and the work of the Neo-Mendelians with numerous plants and animals, show clearly that surprisingly exact predictions of the results of breeding can be made, provided the gametic constitutions of the parents are known, furthermore the gametic constitution of the parents can also be determined by breeding analyses. That there is segregation, or alternativeness, in gametogenesis which accounts for the familiar Mendelian ratios is a generalization which now seems to be well established. However, even in this matter there are some apparently important exceptions which engender doubt in the minds of some persons.

The existence of unit characters, in the De Vriesian sense, does not appear to have been as clearly demonstrated as that of alternative inheritance, and if one may judge from expressions of opinion concerning this matter, the interpretations are at great variance. Thus one group of authors recognize characters in organisms that can be replaced by other characters, when the proper crosses are made—a clear recognition of separable and replaceable characters, which are not necessarily unit characters (1, 3, 8)—while on the other side there are those who believe that the organism as a whole is the only unit and that there are no actual unit characters (9, 7).

In this paper is presented a preliminary account of an experimental inquiry into the problems of inheritance and evolution, which is now being carried on with several species of the grouse-locusts (Tetriginae) of the genus *Paratettix*, Bolivar.

II. MATERIAL AND METHOD.

The Tetriginae are widely distributed, and are principally distinguished from other nearly related Orthoptera by the pronotum which extends backwards over the body and wings, a character which varies greatly among the different genera. The North American genera are mostly geophilous, live on damp earth covered with algae, especially in moist meadows and woods, and on the margins of ponds and streams (4). The genus *Paratettix*, Bol., is distributed over a large part of the United States and Mexico, and the species therein are mainly distinguished by their striking colour patterns.

I have collected in the Mississippi Valley and on the Gulf Coastal Plain of Louisiana and Texas nine distinct true breeding forms of this genus which are being used in the breeding experiments (Plate VI, figs. 1—9). There seems to be uncertainty as to the taxonomic position to be given these forms. It has been suggested that they be called varieties and again that they be designated as biotypes, and, with best reason, it seems to me, that they be called species outright. Pending further consideration of this matter, it seems sufficient for the purposes of this paper to give them names descriptive of the colour patterns, leaving to the future the question as to whether or not these designations are to become the specific names of the forms. However, the names will be tentatively submitted as though they are the specific ones of the genus *Paratettix*, Bol., the taxonomic position which I believe will eventually be accorded them. The nine forms, all of them new, except one, are as follows: *Paratettix texanus*, Hanc. (Plate VI, fig. 1); *P. leuconotus*, n. sp. (fig. 2); *P. leucothorax*, n. sp. (fig. 3); *P. punctofemorata*, n. sp. (fig. 4); *P. luteolineatus*, n. sp. (fig. 5); *P. rufrolineatus*, n. sp. (fig. 6); *P. melanothorax*, n. sp. (fig. 7); *P. luteonotatus*, n. sp. (fig. 8); and *P. nigronotatus*, n. sp. (fig. 9). A more detailed taxonomic description of these and several other forms used and something of their habits will be presented in a separate account.

The characters used in this investigation have been the colour patterns of the pronota and of the femora of the jumping legs (Plate VI), and the length of the pronotum and wings, whether short, intermediate, or long (Fig. 2, p. 161). The final colour pattern is clearly indicated soon after the moult which ushers in the second instar, and there are no perceptible changes in it during the remainder of the life of the individual. The wing and pronotum lengths cannot be determined until the individual becomes adult, and are not in any way correlated with the colour patterns. The forms and their hybrids interbreed freely, and reciprocal crosses have invariably produced identical results. All the females used in the experiments recorded here were virgin, excepting the two heterozygous *texanus*-*leucothorax* females from nature used in the beginning of Exp. I (p. 145).

Glass cylinders, 8" × 12" and 9" × 15" respectively, set in pots of earth and covered with 12- or 24-mesh pearl wire, seem to make the most convenient cages (Fig. 1). It is found best to overlay the surface of the earth in the cages with a very rich vegetable mould, or peat substance. The smaller cages covered with the 12-inch mesh wire are

used as breeding cages. Soon after the young hatch, they are transferred by means of a damp camel hair brush to the larger cages covered with the 24-mesh wire. The best food found consists of the green scrapings (algae, lichens, etc.) from the long used pots holding hot-house plants, though the various filamentous algae serve very well. The mortality on the whole is great.

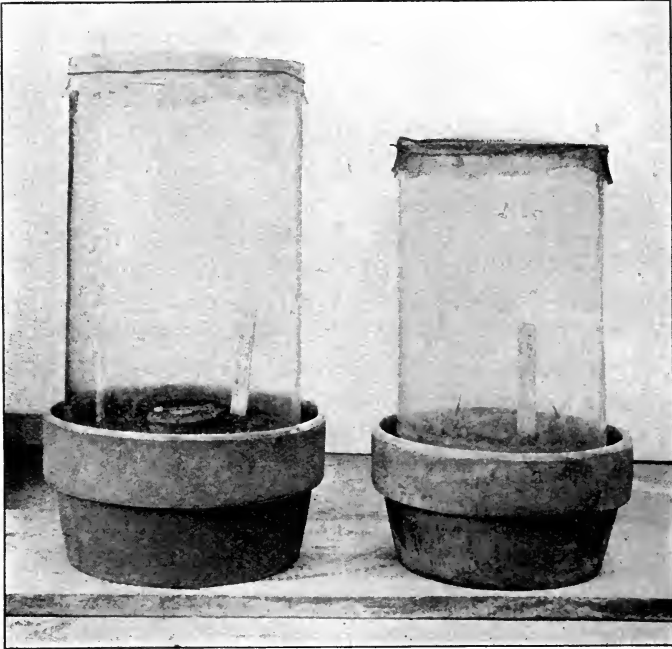

Fig. 1.

III. ANALYSES OF GAMETIC CONSTITUTIONS AND THE INHERITANCE OF COLOUR PATTERNS.

(1) *An analysis and the inheritance of the colour patterns of forms of the appearance of texanus, leuconotus, leucothorax, and punctofemorata.*

For convenience, the homozygous forms and their gametes will be designated by symbols (letters): texanus by *A*, leuconotus by *B*, leucothorax by *C*, punctofemorata by *D*, luteolineatus by *E*, rufrolineatus by *F*, melanothorax by *G*, luteonotatus by *H*, and nigronotatus by *I*.

Any two of these letters placed side by side will represent the heterozygous, or hybrid zygote, or individual, produced by the union of the homozygous gametes represented by the respective letters.

Early in September, 1908, specimens of the general appearance of texanus, leuconotus, leucothorax, and punctofemorata (Plate VI, figs. 1—4), were obtained in the vicinity of Houston, Texas. At that time nothing whatever was known of their composition, and the females were not virgin. All the forms were placed in a tin bucket and taken to Chicago. One specimen, a male of the appearance of leuconotus (Plate VI, fig. 2), two specimens, females, of the appearance of leucothorax (Plate VI, fig. 3), and several males and females of texanus and punctofemorata survived (Plate VI, figs. 1 and 4).

Experiment I. On September 12th, the male of the appearance of leuconotus was mated to the two females of the appearance of leucothorax (Table I, parents). The progeny which hatched in November and December grew slowly and after great mortality matured in the following March, and showed in F_1 five types as follows: 5 of the appearance of leuconotus, 6 leucothorax, 6 intermediate between leuconotus and leucothorax, 12 texanus, and 3 punctofemorata (Table I, F_1). The inbreeding of these F_1 types, each type to itself, in the F_2 generation was as follows: two pairs of the leuconotus type were mated in separate cages and gave F_2 progeny as follows: in cage (a) 34 leuconotus (B) and texanus-leuconotus (AB): 14 texanus (A), and in cage (b) 24 leuconotus (B) and texanus-leuconotus (AB): 7 texanus (A); the total numbers for the two cages being 59 leuconotus (B) and texanus-leuconotus (AB): 21 texanus (A), with the expectation of 60:20, respectively. The F_1 leuconotus-leucothorax (BC) heterozygotes were inbred, as a group culture, and gave in F_2 , 66 leuconotus; 136 leuconotus-leucothorax (BC): 58 leucothorax, the expectation being 65:130:65, respectively. The F_1 leucothorax type inbred, three pairs in separate cages, gave progeny in F_2 as follows: in cage (a) 43 leucothorax and texanus-leucothorax (AC): 7 texanus (A); in cage (b) 8 leucothorax (C) and texanus-leucothorax (AC): 10 texanus (A); and in cage (c) 66 leucothorax (C) and texanus-leucothorax (AC): 15 texanus (A); the total numbers from the three matings being 117 leucothorax (C) and texanus-leucothorax (AC): 32 texanus (A), with the expectation of 111.75:37.25, respectively. One of the F_1 punctofemorata type, a male, was mated to a texanus female, and they gave in F_2 , 9 of the appearance of punctofemorata: 5 texanus. This result shows at least the texanus-punctofemorata (AD) heterozygous

constitution of the F_1 individuals of the appearance of punctofemorata. The F_1 texanus bred true for five generations when the culture was terminated. For a graphic illustration of all these F_2 results compare Table I, F_2 , and diagram 1, F_2 (p. 151).

At this time, Spring 1909, I was not able to distinguish the pure leuconotus from the hybrid leuconotus-texanus, but since then I have learned to distinguish between them. On careful examination, the

TABLE I.

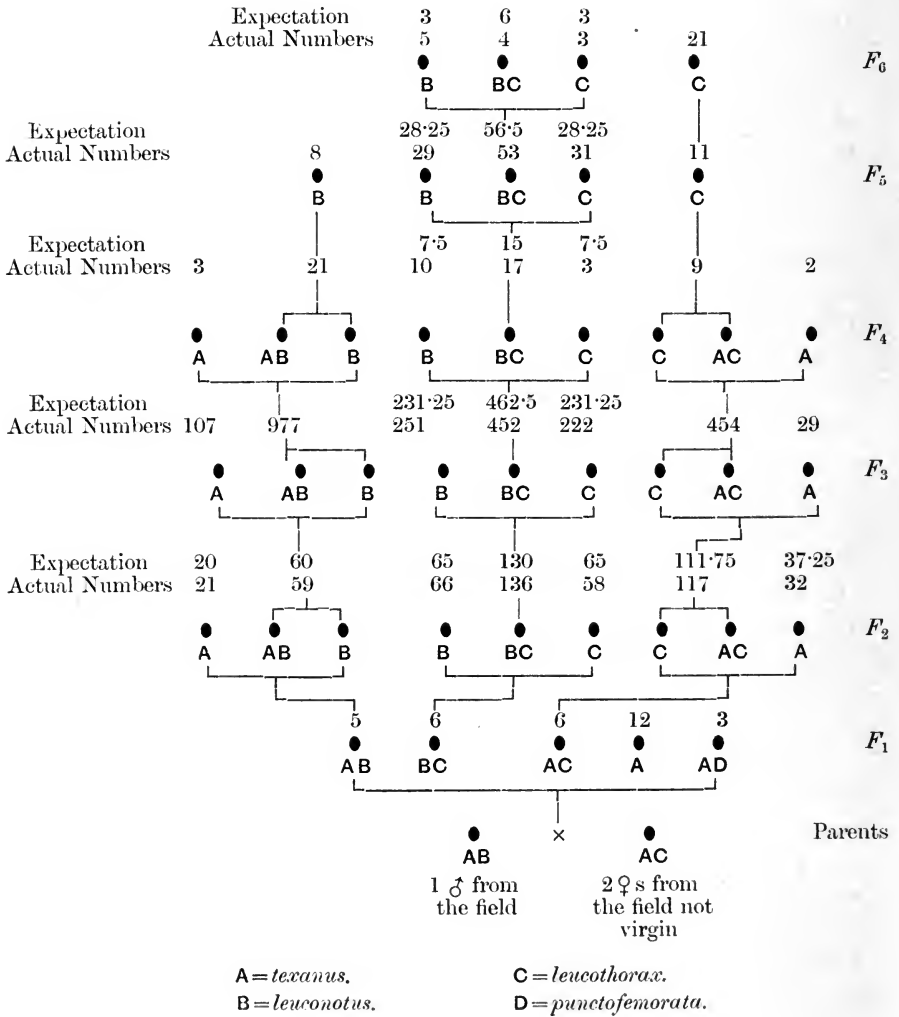

general outlines of the pattern of texanus can be clearly seen in the heterozygote. I am not able to distinguish with certainty between any of the other pure forms and the hybrids between them and texanus; that is, as ordinarily considered, texanus is recessive to all the other species.

An analysis of the F_2 results just described, with their close approximations to the expected ratios of alternative inheritance, shows that the F_1 leuconotus were heterozygous, having the gametic constitution AB (allowing A and B to represent the gametes of texanus and leuconotus, respectively). The leucothorax in the same way were also heterozygous, having the composition AC (C representing leucothorax), and the behaviour of the midtype strikingly points to its heterozygous leuconotus-leucothorax (BC) character. From this behaviour it seems that we may conclude that the parent male from nature was a texanus-leuconotus heterozygote of the gametic constitution AB , and the females (at least one of them) were texanus-leucothorax (AC) heterozygotes and that some of the eggs of at least one of these females had been fertilized by a pure punctofemorata (D), or heterozygous texanus-punctofemorata (AD) male, and his D gametes meeting her A gametes made the heterozygous texanus-punctofemorata (AD) specimens of the superficial appearance of punctofemorata (Table I, F_1 , and diagram I F_1).

F_3 results from inbreeding of the F_2 forms of this series. The leuconotus-leucothorax (BC) inbred, as a group culture, gave in F_3 251 leuconotus : 452 leuconotus-leucothorax (BC) : 222 leucothorax, the expectation being 231.25 : 462.5 : 231.25, respectively. The F_2 generation leuconotus which came from the inbreeding of F_1 leuconotus-leucothorax bred true for three generations and then the culture was destroyed. The F_2 leucothorax which came from the inbreeding of this F_1 leuconotus-leucothorax midtype were carried two generations and bred true. The F_2 forms of the general appearance of leuconotus were inbred in four cages as follows: (a) 1 male \times 1 female, (b) 1 male \times 1 female, (c) 2 males \times 2 females, (d) 2 males \times 2 females. Pair (a) gave 10 leuconotus : 3 texanus; pair (b) gave 275 all leuconotus; pair (c) gave 194 leuconotus : 47 texanus; and pair (d) gave 498 leuconotus : 57 texanus. These results are represented graphically in Table I, F_3 , as a group culture, as unfortunately they essentially were, because the main attention at this time was being given to the behaviour of the leuconotus-leucothorax midtype and its products, leuconotus and leucothorax, and to the finding of the proper food and other living conditions. However, the results are suggestive; for in cage (a)

though the numbers are small, the 10:3 ratio suggests that the parents were texanus-leuconotus (AB) heterozygotes, since this is a close approximation to the expectation of 9.75 B and AB :3.25 A . In cage (b) one of the parents could have been of the constitution AB and the other pure B , or both could have been pure B , because at that time, as has already been noted, in making records no distinction was made between the heterozygous texanus-leuconotus (AB) and the homozygous leuconotus (B). The specimens have been kept preserved in alcohol and although the general outlines of the patterns are still distinct they are not clear enough to permit the fine distinction which would be necessary for selecting the homozygous leuconotus (B) from the heterozygous texanus-leuconotus (AB), as can be done now with the live specimens.

It is obvious that nothing further than that they are AB and B can be ascertained concerning the composition of the parents in cages (c) and (d), though the ratio of 194:47 in cage (c) is suggestive of the expectation of 180.75:60.25, if all four of the individuals had been texanus-leuconotus (AB) heterozygotes. Although the matings were made in such a way as to make the numerical ratios of no value, yet it is to be noted that no unexpected individuals appeared—all were texanus (A), texanus-leuconotus (AB), or leuconotus (B).

The F_2 impure forms of the appearance of leucothorax were inbred in the same way as were the F_2 impure leuconotus, i.e., essentially as a group culture. As in the case of the homozygous leuconotus and the heterozygous texanus-leuconotus, I was not able to distinguish between the homozygous leucothorax and the heterozygous texanus-leucothorax. Four group matings were made as follows: (a) 1 male \times 1 female; (b) 2 males \times 2 females; (c) 2 males \times 2 females, and (d) 2 males \times 2 females. The F_3 results from these matings were as follows: from (a) 259 leucothorax; (b) 65 leucothorax:11 texanus; (c) 103 leucothorax:15 texanus; and (d) 27 leucothorax:3 texanus. If none of the leucothorax F_3 individuals from (a) had been bred further, it would not be known whether the F_2 parents were both homozygous leucothorax (C), or one of them homozygous (C) and the other heterozygous texanus-leucothorax (AC), but 2 males \times 2 females were bred and gave in F_4 , after great mortality due to drought in the cage, 9 leucothorax:2 texanus; thus showing one of the parents in cage (a), F_2 , to have been undoubtedly heterozygous texanus-leucothorax (AC). The individuals from the other cages were not bred further. It is here again obvious that the composition of each of the parents in these

cages cannot be ascertained by the appearance of their F_3 offspring, because 2 males \times 2 females were used in each instance. However, no unexpected types appeared, and we do know that the parents were of the two compositions, C and AC , and no other than these. The results from the inbreeding of these F_2 impure leucothorax are shown as a group in Table I, F_3 , and in more detail in diagram 1, F_3 .

A group culture of 2 males \times 2 females was made from the F_2 texanus which had come from the F_1 impure leuconotus and they gave only texanus in F_3 when the culture was terminated. Similarly, a group culture was made of the F_2 texanus which had come from the F_1 impure leucothorax and they bred true in F_3 when they were also destroyed.

F_4 results from the separate inbreeding of the F_3 forms of this series. Several of the F_3 leuconotus-leucothorax (BC) were inbred, but on account of poor attention, the mortality of the F_4 progeny was very great. The record of those reaching maturity was 10 leuconotus : 17 leuconotus-leucothorax : 3 leucothorax (Table I, F_4).

From (d), of the texanus-leuconotus (AB) F_3 group culture, two pairs, a pair each in separate cages, of the appearance of leuconotus were bred. After great mortality the F_4 result in (a) was 8 leuconotus : 3 texanus, and the pair in (b), gave 13 all leuconotus. These results added together are shown in Table I, F_4 , as a group culture, giving a 21 : 3 ratio. It appears that the parents in cage (a) were texanus-leuconotus (AB) heterozygotes, and that the cage (b) parents were both either homozygous leuconotus (B), or that one of them was homozygous and the other heterozygous texanus-leuconotus (AB). However, when a pair from cage (b) were bred, they gave in F_5 , 8, all leuconotus in appearance, and this closed the impure leuconotus part of the experiment (Table I, F_4 and F_5).

From the cage (a) F_3 progeny, in the impure leucothorax series of this experiment, two males and two females of the appearance of leucothorax were mated as a group culture, and they gave in F_4 , 9 leucothorax : 3 texanus. This result, though small in numbers, shows quite clearly that the pair of the appearance of leucothorax taken from the (a) F_2 culture and bred to make (a) F_3 259 all leucothorax in appearance, were not both of them homozygous leucothorax (C), nor were they both heterozygous texanus-leucothorax (AC), but that one of them was a homozygous leucothorax (C), and the other a heterozygous texanus-leucothorax (AC), a matter to which attention is given above. The

leucothorax progeny from this F_4 culture bred true, when inbred, for two generations, giving 11 leucothorax in F_5 and 21 leucothorax in F_6 (Table I, F_4 , F_5 and F_6).

A pair of texanus from the F_4 impure leuconotus culture, when bred, gave 100% texanus, as did a similar pair from the same generation of the impure leucothorax culture. Also a texanus male from the F_4 texanus-leuconotus culture was mated to a texanus female from the F_4 texanus-leucothorax culture and they gave 100% texanus.

The F_4 leuconotus-leucothorax (BC) were inbred and gave, in F_5 , 29 leuconotus : 53 leuconotus-leucothorax (BC) : 31 leucothorax, the expectation being 28.25 : 56.5 : 28.25, respectively. (Table I, F_5 .)

The F_5 leuconotus-leucothorax (BC) were again inbred and gave in F_6 , 5 leuconotus : 4 leuconotus-leucothorax (BC) : 3 leuconotus (Table I, F_6). With this result the experiment was closed.

Allowing the letters A , B , C , and D , as already suggested, to indicate the homozygous texanus, leuconotus, leucothorax, and punctofemorata, respectively, diagram I, with Table I, will show at a glance the inheritance behaviour in this experiment.

(2) *An analysis and the inheritance of the colour patterns of forms of the appearance of luteolineatus and rufrolineatus.*

Experiment II. Early in September, 1909, among several specimens secured in the vicinity of Many, Louisiana, were a male of the appearance of rufrolineatus (F) (Plate VI, fig. 6) and an immature female of the appearance of luteolineatus (E) (Plate VI, fig. 5). When the female became adult this male of the appearance of rufrolineatus was mated to her, and their progeny which hatched in November, after great mortality, matured the following March and showed four types in F_1 as follows: 4 of the appearance of rufrolineatus : 2 intermediate between rufrolineatus and luteolineatus : 2 of the appearance of luteolineatus : 2 texanus (Table II, (a), F_1). These F_1 progeny were bred further as follows: (a) a pair of the appearance of rufrolineatus were inbred and gave in F_2 43 of the appearance of the parents (rufrolineatus) : 13 texanus. This shows clearly that the F_1 individuals of the appearance of rufrolineatus were really texanus-rufrolineatus (AF) heterozygotes. This fact, the visibly clear luteolineatus-rufrolineatus (EF) heterozygous character of two others of the F_1 progeny and the fact that still two others were the always homozygous texanus (A), without considering the two individuals of the appearance of luteolineatus which

TABLE II.

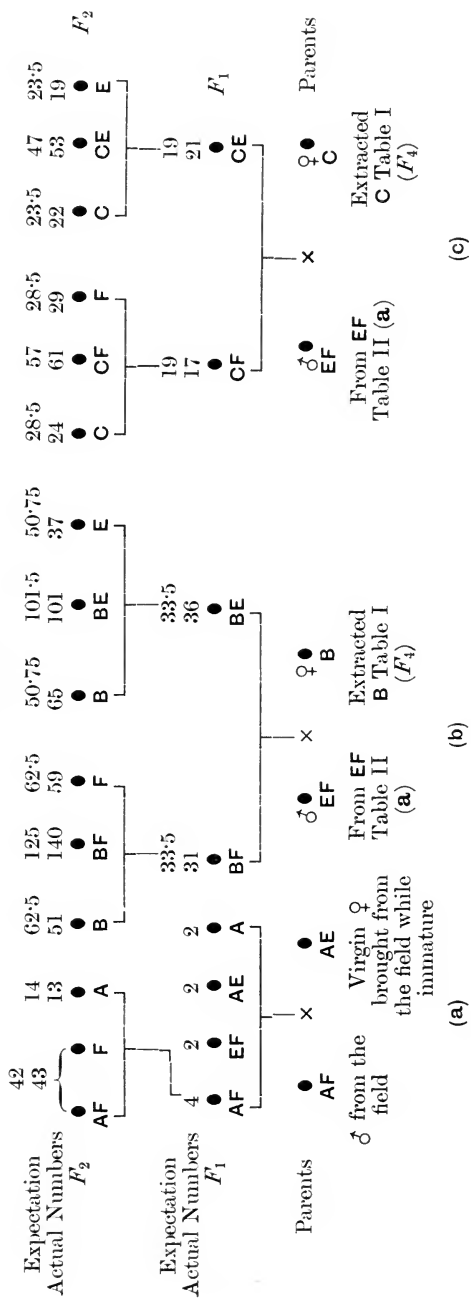

(c)

(b)

(a)

were not bred, all show that the parents from nature were really texanus-rufrolineatus (AF) and texanus-luteolineatus (AE) heterozygotes, respectively. Therefore, the F_1 progeny should read, texanus-rufrolineatus (AF) 4 : luteolineatus-rufrolineatus (EF) 2 : texanus-luteolineatus (AE) 2 : texanus 2, the expectation being 2.25 of each (Table II (a), F_1).

(b) One of the luteolineatus-rufrolineatus (EF) F_1 males (Table II (a) F_1) was mated to an extracted homozygous leuconotus (B) female, from a culture whose parents were both leuconotus-leucothorax (BC) heterozygote (Table I, F_4 , B) and they gave F_1 progeny as follows: leuconotus-rufrolineatus (BF) 31 : leuconotus-luteolineatus (BE) 36, the expectation being 33.5 of each kind (Table II (b), F_1). This result proves unmistakably the luteolineatus-rufrolineatus (EF) heterozygous character of the male parent, supplementing the evidence which the intermediate colour of his stripe had given.

The inbreeding of these leuconotus-rufrolineatus (BF) and leuconotus-luteolineatus (BE) F_1 individuals, respectively, gave F_2 results as follows: two pairs of the leuconotus-rufrolineatus (BF) individuals were mated, one pair in each of two cages. The pair in cage (a) gave the following F_2 progeny: leuconotus 27 : leuconotus-rufrolineatus (BF) 69 : rufrolineatus 29; and the pair in cage (b) gave leuconotus 24 : leuconotus-rufrolineatus (BF) 71 : rufrolineatus 30; the two pairs giving totals of 51 leuconotus (B) : 140 leuconotus rufrolineatus (BF) : 59 rufrolineatus (F), with the expectation of 62.25 : 124.5 : 62.25, respectively (Table II (b), F_2).

One of these F_2 rufrolineatus males was mated to a sister leuconotus-rufrolineatus female and they gave in F_3 6 leuconotus-rufrolineatus : 5 rufrolineatus, the expectation being 5.5 of each. A pair of the F_2 extracted rufrolineatus were inbred and gave in F_3 100% rufrolineatus. These were again inbred, as a group culture, and gave in F_4 100% rufrolineatus.

Two pairs of the F_1 leuconotus-luteolineatus (BE) were mated, one pair in each of two cages. Pair (a) gave 32 leuconotus : 53 leuconotus-luteolineatus (BE) : 17 luteolineatus, and pair (b) produced 33 leuconotus : 48 leuconotus-luteolineatus : 20 luteolineatus, both cages giving totals of 65 leuconotus : 101 leuconotus-luteolineatus : 37 luteolineatus, the expectation being 50.75 : 101.5 : 50.75, respectively (Table II (b), F_2).

Three males and three females of these F_2 leuconotus-luteolineatus (BE) individuals were inbred, as a group culture, under very unfavourable

conditions and they gave in F_3 8 leuconotus : 19 leuconotus-luteolineatus : 6 luteolineatus, the expectation being 8.25 : 16.5 : 8.25, respectively. One of the luteolineatus F_2 males (Table II (b), F_2) was mated to a virgin female of the same apparent constitution but whose pedigree is not known, and they gave in F_1 100% luteolineatus.

(c) The other luteolineatus-rufrolineatus (EF) heterozygous male (Table II (a), F_1) was mated to an extracted homozygous leucothorax (C) female from a culture whose parents were both leuconotus-leucothorax (BC) heterozygous individuals (Table I, F_4 , C). (This female was a sister of the leuconotus female parent in mating (b) of this experiment.) They produced the following F_1 progeny: leucothorax-rufrolineatus (CF) 17 : leucothorax-luteolineatus 21, the expectation being 19 of each kind (Table II (c), F_1). The behaviour of this EF male when mated to a homozygous leucothorax female was exactly the same as that of his brother when mated to a homozygous leuconotus female. Both behaviours reveal the constitution of the males, as well also as that of the females.

The inbreeding of these F_1 leucothorax-rufrolineatus (CF) and leucothorax-luteolineatus (CE) individuals, respectively, gave F_2 results as follows: two pairs of leucothorax-rufrolineatus (CF) were inbred, a pair in each of two cages. The pair in cage (a) produced 7 leucothorax : 13 leucothorax-rufrolineatus (CF) : 4 rufrolineatus, and the pair in cage (b) gave 17 leucothorax : 48 leucothorax-rufrolineatus (CF) : 25 rufrolineatus; both pairs giving a total of 24 leucothorax : 61 leucothorax-rufrolineatus (CF) : 29 rufrolineatus, the expectation being 28.5 : 57 : 28.5, respectively (Table II (c), F_2).

The leucothorax-luteolineatus (CE) were inbred, one pair in each of two cages. Pair (a) produced 12 leucothorax : 12 leucothorax-luteolineatus (CE) : 3 luteolineatus, and pair (b) gave 10 leucothorax : 41 leucothorax-luteolineatus (CE) : 16 luteolineatus; both pairs producing totals of 22 leucothorax : 53 leucothorax-luteolineatus (CE) : 19 luteolineatus, with the expectation of 23.5 : 47 : 23.5, respectively (Table II (c), F_2).

These F_2 leucothorax-luteolineatus (CE) were inbred under exceptionally unfavourable circumstances, 1 male \times 1 female, and they gave in F_3 8 leucothorax : 6 leucothorax-luteolineatus : 3 luteolineatus, the expectation being 4.25 : 8.5 : 4.25, respectively. A pair of these F_3 leucothorax-luteolineatus individuals were inbred, and after great mortality, gave in F_4 , 4 leucothorax : 1 leucothorax-luteolineatus (CE) : 2 luteolineatus, the expectation being 1.75 : 3.5 : 1.75, respectively.

(3) *The interbreeding of heterozygotes.*

Experiment III. All the crosses of heterozygous individuals with homozygous ones and the inbreeding of heterozygous ones had given results that could hardly be interpreted in any other way than by assuming that the heterozygous, or hybrid, individuals gave gametes alternatively, one representing the male parent and the other the female parent. Not a single exception to this rule had been noted. A few crosses had been made between different heterozygotes from nature whose constitutions were not ascertained till their F_1 and F_2 progeny gave the clue (Exp. I, Table I, and Exp. II (a), (b), (c), Table II (a), (b), (c)). At this time it seemed that some crosses ought to be made between different hybrids of known constitutions; so the following crosses were made simultaneously:

(a) A leucothorax-luteolineatus (CE) male from Exp. II (c), F_1 (Table II (c), F_1) and a leuconotus-leucothorax (BC) female from Exp. III (c), F_1 (Table IV (c), F_1) were crossed, and they gave in the F_1 generation (F_1 , Table III (a)):

	Leucothorax (C)	Leuconotus- leucothorax (BC)	Leucothorax- luteolineatus (CE)	Leuconotus- luteolineatus (BE)
Actual Numbers ...	9	9	7	13
Expectation ...	9.5	9.5	9.5	9.5

TABLE III.

Expectation	9.5	9.5	9.5	9.5	45	45	45	45	
Actual Numbers	9	9	7	13	52	36	44	48	F_1
F_1	●	●	●	●	●	●	●	●	
	C	BC	CE	BE	CE	BC	BF	EF	
Parents	♂ ● × ♀ ●				♂ ● × ♀ ●				Parents
	CE		BC		CF		BE		
	From Table II (c) (F_1)		From Table IV (c) (F_1)		From Table II (c) (F_1)		From Table II (b) (F_1)		
	(a)				(b)				
Expectation	21.5	21.5	21.5	21.5	10	10	10	10	0
Actual Numbers	18	23	21	24	12	11	7	10	1
F_1	●	●	●	●	●	●	●	●	●
	BE	CE	BC	E	BC	BE	CI	EI	BEI
Parents	♂ ● × ♀ ●				♂ ● × ♀ ●				Parents
	CE		BE		CE		BI		
	From Table II (c) F_1		From Table II (b) (F_1)		From Table II (c) (F_1)		Group culture		
	(c)				(e)				

B = leuconotus. C = leucothorax. E = luteolineatus.
 F = rufolineatus. I = nigronotatus.

(b) A leucothorax-rufrolineatus (*CF*) male from Exp. II (c), F_1 (Table II (c), F_1) was mated to a leuconotus-luteolineatus (*BE*) female from Exp. II (b), F_1 (Table II (b), F_1) and the resulting F_1 progeny were as follows (F_1 , Table III (b)):

	Leucothorax-luteolineatus (<i>CE</i>)	Leuconotus-leucothorax (<i>BC</i>)	Leuconotus-rufrolineatus (<i>BF</i>)	Luteolineatus-rufrolineatus (<i>EF</i>)
Actual Numbers ...	52	36	44	48
Expectation ...	45	45	45	45

(c) A leucothorax-luteolineatus (*CE*) male from Exp. II (c), F_1 (Table II (c), F_1) was crossed with a leuconotus-luteolineatus (*BE*) female from Exp. II (b), F_1 (Table II (b), F_1) and they gave in the F_1 generation (Table III (c), F_1):

	Leuconotus-luteolineatus (<i>BE</i>)	Leucothorax-luteolineatus (<i>CE</i>)	Leuconotus-leucothorax (<i>BC</i>)	Luteolineatus (<i>E</i>)
Actual Numbers ...	18	23	21	24
Expectation ...	21.5	21.5	21.5	21.5

(d) A leuconotus-luteolineatus (*BE*) male from Exp. II (b), F_1 and a female leuconotus-leucothorax (*BC*) from Exp. III (e), F_1 were mated and they gave in the F_1 generation the following progeny:

	Leuconotus (<i>B</i>)	Leuconotus-leucothorax (<i>BC</i>)	Leucothorax-luteolineatus (<i>CE</i>)	Leuconotus-luteolineatus (<i>BE</i>)
Actual Numbers ...	7	7	9	6
Expectation ...	7.25	7.25	7.25	7.25

This experiment, (d), was carried on subsequently to (c) which is the next experiment in this series to be described.)

The results from these crosses gave nothing new. They can be accounted for clearly by assuming that the parent heterozygotes gave gametes alternatively for each parent type of which they were composed and that in fertilization these gametes met by chance. Considering the small numbers, it seems that the approximations to the expectations of alternative inheritance are fairly close. However, the next cross (e) in this series is not so regular.

(e) A leucothorax-luteolineatus (*CE*) male from Exp. II (c), F_1 (Table II (c), F_1) was mated to a leuconotus-nigronotatus (*BI*) female from a cross between an extracted leuconotus (*B*) male and a nigronotatus (Plate VI, Fig. 9) female from nature. This leuconotus-nigronotatus female had the exact appearance of many other heterozygous

leuconotus-nigrinotatus (*BI*) individuals that have since been produced. Their F_1 progeny was as follows (Table III (*e*), F_1):

	Leuconotus-leucothorax (<i>BC</i>)	Leuconotus-luteolineatus (<i>BE</i>)	Leucothorax-nigrinotatus (<i>CI</i>)	Luteolineatus-nigrinotatus (<i>EI</i>)	Leuconotus-luteolineatus-nigrinotatus (<i>BET</i>)	
Actual Numbers	12	11	7	10	1	
Expectation	12.25	12.25	12.25	12.25	0	F_1

This result is perfectly regular in every respect, except for the appearance of the leuconotus-luteolineatus-nigrinotatus (*BET*) individual. This specimen was observed during its second instar when its characters were perfectly distinct, and it was kept under close observation until it became adult. The pattern was distinct at all times, but was strikingly clear just after moults. Unfortunately it escaped while the culture was being transferred from the University of Chicago to the Kansas State Agricultural College, at Manhattan, in September, 1910. It seems that the production of this aberrant individual may be accounted for by assuming that the leuconotus-nigrinotatus (*BI*) female parent gave at least one gamete containing the factors for the patterns of both of her parents and that this double character gamete was fertilized by one of the luteolineatus (*E*) gametes which came from the leucothorax-luteolineatus (*CE*) male¹.

(4) *Further hybridization and inbreeding of the resulting heterozygotes.*

Experiment IV. The following are additional data concerning the simple crossing of forms where the composition of one of the parents was known and that of the other parent unknown.

(a) A male nigrinotatus (Plate VI, fig. 9), from nature, whose pedigree was not known, and a female leuconotus, from the F_2 generation of a pure leuconotus culture, were crossed, and they gave in F_1 ten adults, all leuconotus-nigrinotatus (*BI*) heterozygotes (Table IV (*a*), F_1). A pair of these were inbred and gave in F_2 three types as follows (Table IV (*a*), F_2):

		Leuconotus (<i>B</i>)	Leuconotus-nigrinotatus (<i>BI</i>)	Nigrinotatus (<i>I</i>)
Actual Numbers	...	3	13	5
Expectation	...	5.25	10.5	5.25

¹ In subsequent experiments—the production of an individual with the patterns of three of its ancestors combined—has been repeated four times with other combinations of patterns. I now have leuconotus-rufrolineatus-melanothorax (*BFG*), leucothorax-rufrolineatus-melanothorax (*CFG*), leuconotus-leucothorax-melanothorax (*BCG*), and rufrolineatus-melanothorax-leuconotatus (*FGJ*) (the leuconotatus (*J*), a new form to be described later). These have now been bred for some time, some of them to the F_4 generation. Their inheritance behaviour will be reported soon in another account.

158 *Inheritance and Evolution in Orthoptera I*

These were bred further as follows: a male leuconotus was mated to a sister leuconotus-nigronotatus (*BI*) female, and they gave in F_3 the following progeny:

		Leuconotus (<i>B</i>)	Leuconotus-nigronotatus (<i>BI</i>)	
Actual Numbers	...	4	6	F_3
Expectation	...	5	5	

TABLE IV.

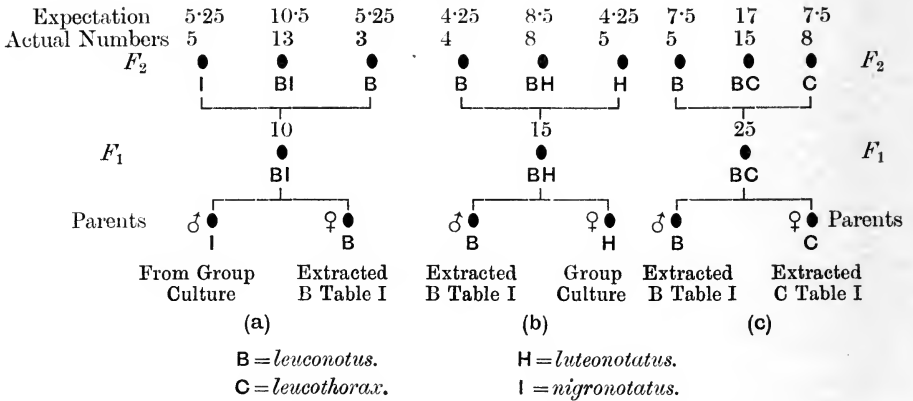

These F_3 leuconotus-nigronotatus (*BI*) were inbred, 1 male × 2 females, and they gave in F_4 the three following types:

		Leuconotus (<i>B</i>)	Leuconotus-nigronotatus (<i>BI</i>)	Nigronotatus (<i>I</i>)	
Actual Numbers	...	9	30	13	F_4
Expectation	...	13	26	13	

(b) A male leuconotus (*B*), from the F_2 generation of a pure leuconotus culture, and a female luteonotatus (*H*), whose parents had been taken from nature, were mated, and their F_1 progeny were all distinctly marked leuconotus-luteonotatus heterozygotes (Table IV (b), F_1). Two males and two females of these were inbred and, after great mortality, they gave in F_2 the following progeny (Table IV (b), F_2):

		Leuconotus (<i>B</i>)	Leuconotus-luteonotatus (<i>BH</i>)	Luteonotatus (<i>H</i>)	
Actual Numbers	...	4	8	5	F_2
Expectation	...	4.25	8.5	4.25	

These results, as in the other cases (Exp. II (a), (b), (c)), give the clue to the composition of the unknown first parent in each case, proving them to have been homozygous nigronotatus (*I*) and luteonotatus (*H*), respectively.

(c) In order to try out more completely the behaviour of the heterozygotes derived from the crossing of leuconotus and leucothorax, a leuconotus male from the second generation of an extracted leuconotus culture (Exp. I, F_3) was mated to a leucothorax female from the second generation of an extracted leucothorax culture (Exp. I, F_3). The F_1 result was twenty-five adults, all leuconotus-leucothorax (BC). These leuconotus-leucothorax heterozygotes were inbred and gave in F_2 the following progeny (Table IV (c), F_1):

		Leuconotus (B)	Leuconotus- leucothorax (BC)	Leucothorax (C)	
Actual Numbers	...	5	17	8	F_2
Expectation	...	7.5	15	7.5	

This result is in perfect accord with the other results, showing that the first parents were homozygous, and that the F_1 heterozygotes behaved in a regular Mendelian manner just as did the exactly similar leuconotus-leucothorax (BC) heterozygotes in Exp. I.

(5) *Results from the mating of heterozygous individuals with one or the other of their homozygous parent forms.*

Experiment V. (a) A leuconotus-leucothorax (BC) male from Exp. I, F_3 (Table I, F_3) was mated to a leuconotus (B) female sister, and they gave in F_1 (F_4) the following results (Table V):

		Leuconotus- leucothorax (BC)	Leuconotus (C)	
Actual Numbers	...	20	20	F_1 (F_4)
Expectation	...	20	20	

TABLE V.

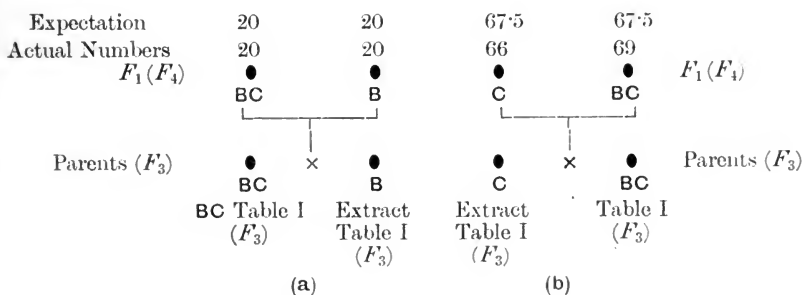

B = leuconotus.
C = leucothorax.

(b) A leuconotus-leucothorax male from Exp. I, F_3 (Table I, F_3) and a sister leucothorax (C) were mated and their F_1 (F_4) progeny were as follows:

		Leuconotus- leucothorax (BC)	Leucothorax (C)	F_1 (F_4)
Actual Numbers	...	69	66	
Expectation	...	67.5	67.5	

These results are typically Mendelian, and close the report to be made at this time on the inheritance of colour patterns.

IV. LONG AND SHORT WINGEDNESS.

(1) *Long and short wingedness in Nature.*

It is a matter of common observation that in many species of the Acridiidae and Gryllidae there is dimorphism or polymorphism in the length of the wings—some of the members bearing short and others long wings. (In the Tetriginæ, unless otherwise indicated, the word wingedness refers to pronotum also.) The differences in some cases have been considered by systematists sufficient to justify the giving of different varietal names to the two forms (e.g. *Tettigidea parvipennis*, Morse, and *Tettigidea parvipennis pennata*, Morse, the short and long winged forms of *T. pennatus*) (4).

The studies of the difference in lengths of the wings in the Acridiidae have been, so far as I can ascertain, confined to the field observations and to the examination of collections in museums. However, in the Gryllidae, Lutz (1907) has made observations concerning this phenomenon of long and short wingedness (pronotum not considered) in a breeding experiment with *Gryllus sp.* His results brought him to the conclusion that the length of the wings of the species with which he worked was not conditioned by heredity, but by the environmental conditions under which the individuals grew to maturity (6).

In the Tetriginæ, the differences in the length of the wings and pronota are usually, though not invariably, dimorphic; several variations from the long and short winged forms have been found, and some individuals were strictly intermediate between the two extremes. It is the usual occurrence to find a long pronotum with long wings and a short pronotum with short wings, but a few variations from this rule have occurred as follows: in a few instances long wings have accompanied a short pronotum, and one individual exhibited a short pronotum with one wing long and the other short (the various types are shown in Fig. 2).

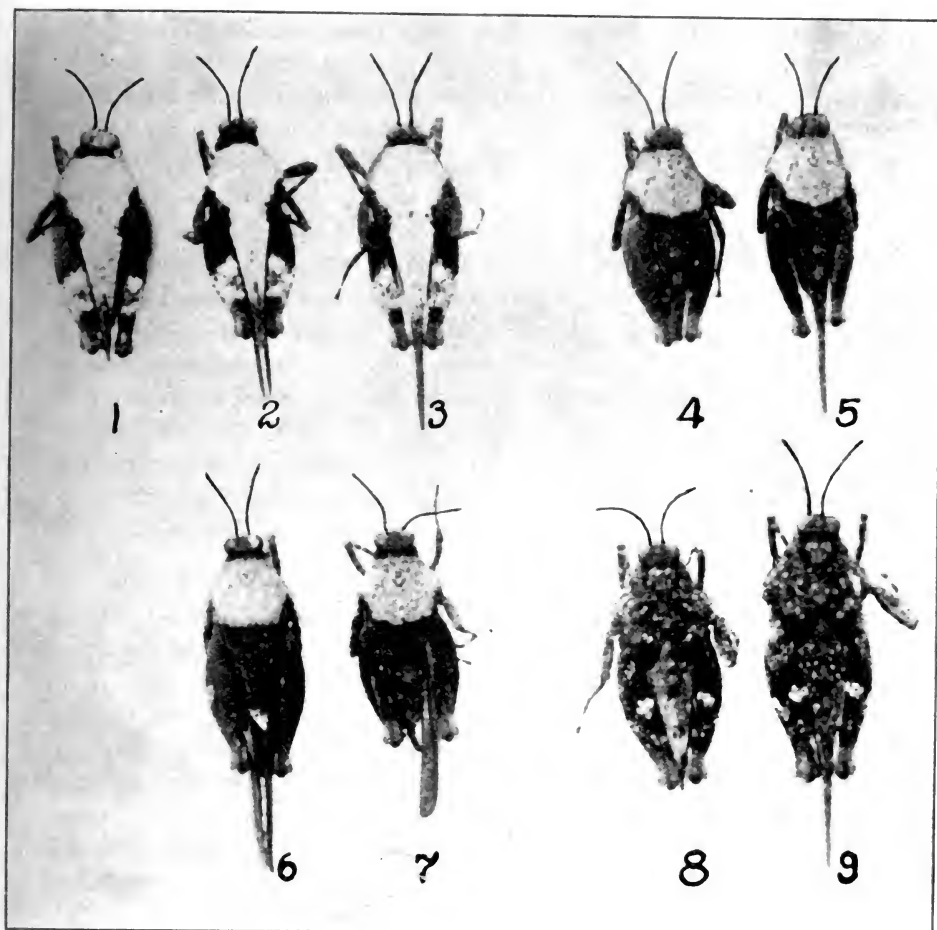

Fig. 2.

1, 2, 3, Brothers from the same cage.

4, 5, Brothers.

6, Short pronotum, both wings long.

7, Short pronotum, one wing long.

8, 9, Sisters.

All on the same scale.

In the vicinity of Chicago, the genus *Tettigidea* is found to be about equally divided between the long and short winged individuals. They are almost strictly dimorphic. The genus *Tettix* exhibits polymorphism in respect to this character, running all the way from extreme short to extreme long wingedness. The shorter winged individuals predominate in this genus, while the extreme long winged ones are rare. In the genus *Paratettix*, Bol., under more particular consideration in this paper, long wingedness is the rule in the Chicago region—only two short winged individuals having been observed among many hundreds. In Arkansas, a few short winged individuals were found among several hundred long winged ones, while in Louisiana and Southern Texas, the two forms, practically without intermediates, existed in about equal proportions. In the North, in nature, only one generation a year of any of the species is produced and the growth period is normally in the late spring and early summer when the adult stage is reached quickly, while in Louisiana and Texas *Paratettix* produces two or three generations a year, and the growth period continues practically throughout the year, with the optimum in the spring and early summer.

(2) *Long and short wingedness in the breeding experiments.*

The observation on the occurrence of long and short winged forms during the breeding experiments will be reported at this time only for the individuals maturing in the inheritance of the colour pattern in Exp. I (Table I). In that experiment the wing length of the individuals was not considered just as in the following account the colour patterns are not considered, there being no apparent correlation between the length of the wings and the pattern.

Referring to the diagram (diagram II), the first mating was made in September 1908 between one short winged male and two short winged females. At least one of the females was not virgin. The F_1 generation which hatched in December matured after great mortality the following March and April in these proportions:

Long winged 17 : Short Winged 15 (F_1).

The short winged individuals, inbred, produced progeny which hatched in May and became adult in July and August in the following ratio:

Long Winged 224 : Short Winged 7 (F_2).

These F_2 short winged individuals, inbred, produced progeny in September, which, after great mortality, matured the next March and all were short winged.

Going back to the long winged forms from the inbreeding of the F_1 generation short winged, their progeny which hatched in August matured from December to February:

Long Winged 20 : Short Winged 8 (F_8).

These last short winged did not produce progeny until the following March and they grew from March to June resulting in:

Long Winged 10 (F_4).

The F_1 generation long winged gave progeny which hatched in May and became adult in June and July and were:

Long Winged 336 : Short Winged 4 (F_2).

DIAGRAM II.

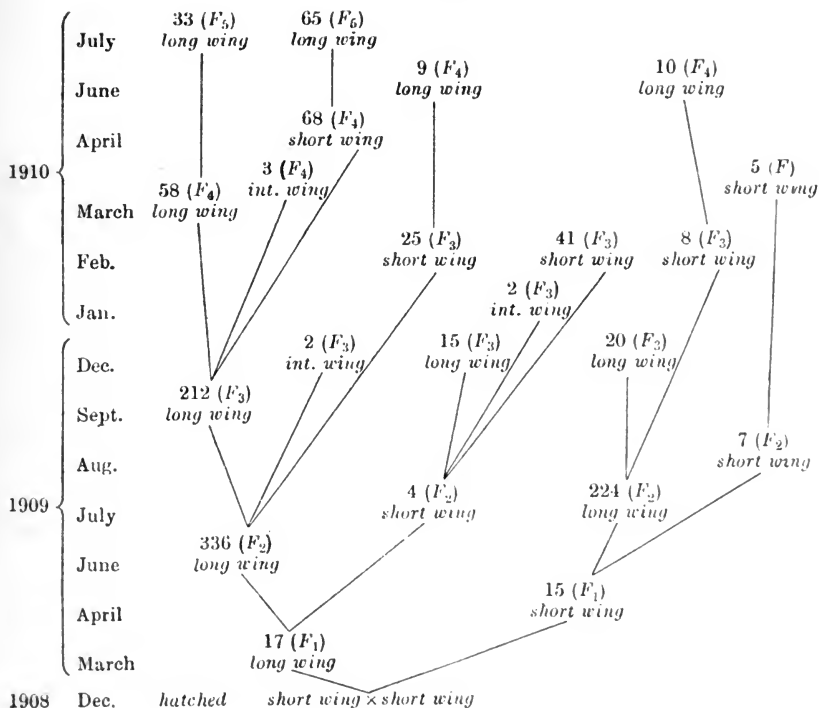

This is nearly the same result as that obtained from the inbreeding of the F_1 generation short winged brothers and sisters. From the inbreeding of the short winged of this last fraternity, progeny were

hatched in August which matured from December to February and gave:

Long Winged 15 : Intermediate Winged 2 : Short Winged 41 (F_3).

Now going back to the long winged of generation F_2 , long winged, their inbreeding gave progeny in July which matured from September to February:

Long Winged 212 : Intermediate Winged 2 : Short Winged 25 (F_3).

The long winged in this instance were nearly all matured by the end of September, while the intermediate and short winged required until February to mature. The short winged ones just enumerated as maturing in February, produced young in March, which matured in June:

Long Winged 9 (F_4).

The inbreeding from the long winged of F_3 generation progeny produced young in October which matured the following March and April:

Long Winged 58 : Intermediate Winged 3 : Short Winged 68 (F_4).

These short winged gave young in April which matured in July:

Long Winged 65 (F_5).

Their long winged brothers and sisters, generation F_4 , also produced young in April which matured in July:

Long Winged 33 (F_5).

V. AN EXAMINATION OF THE LOCATION, ARRANGEMENT, AND RELATIONS OF THE PIGMENTAL ELEMENTS IN THE COLOUR PATTERNS OF THE EXTRACTED SPECIES AND THEIR HYBRIDS.

All the hybrids thus far produced, except some of those in which texanus (A) is a component, exhibit, on superficial examination as shown in the photographs, the colour character, or part of it, of each of the components. In some cases, as leuconotus-leucothorax (BC), leuconotus-melanothorax (BG), and leucothorax-melanothorax (CG), on superficial examination the elements of the parents appear to be present in apparently equal proportions, while in others, as leuconotus nigronotatus (BI), leuconotus-luteonotatus (BH), leucothorax-nigronotatus (CI), leucothorax-luteonotatus (CH), leuconotus-rufrolineatus (BF), leuconotus-luteolineatus (BE), leucothorax-rufrolineatus (CF), and

leucothorax-luteolineatus (*CE*), the characters of the leuconotus (*B*) and leucothorax (*C*) parents appear to obscure or replace the brown or mottled brown parts of the characters of nigronotatus (*I*), luteonotatus (*H*), rufolineatus (*F*), and luteolineatus (*E*), respectively, and allow only their more brilliant parts (mahogany brown, yellowish red, and dense black) to appear (Plate VI). It was first thought that these more brilliant parts (mahogany brown, yellowish red, or dense black) were separated, in the patterns of the hybrids, from the grays or mottled brown parts which accompanied them in the patterns of the parent species. In order to test this matter more definitely than a superficial examination of the patterns allows, sections have been made through the pronota of several of the hybrids and their parent species and these

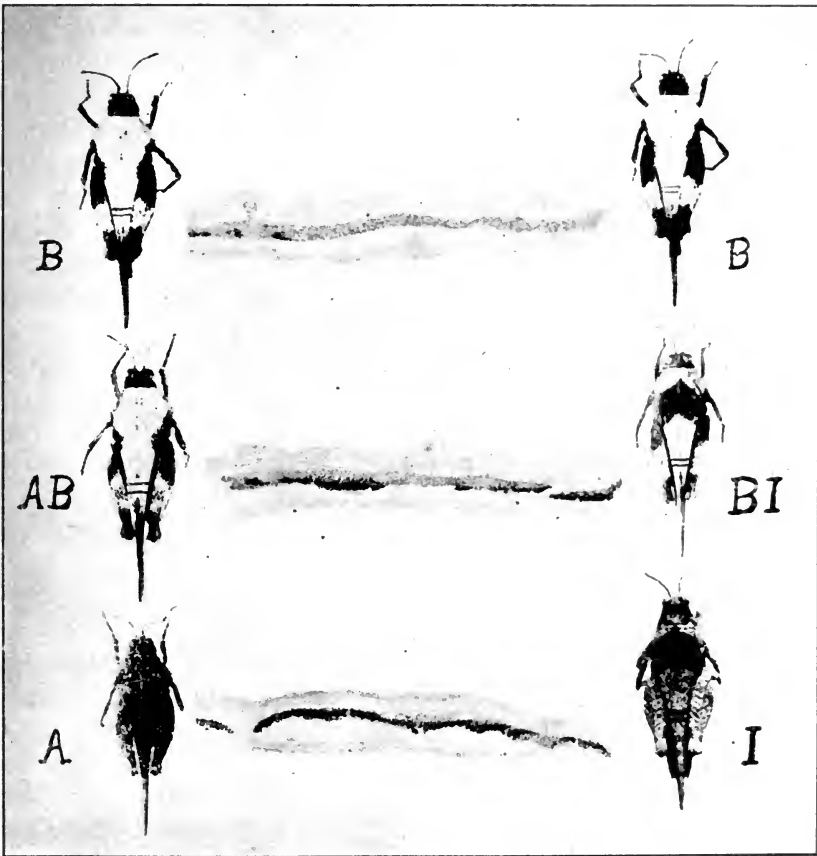

Fig. 3.

examined microscopically. The examination of the section through the pronotum of *nigronotatus* (*I*), about midway between the deep black spot and the posterior end of the pronotum, reveals a deeply pigmented hypodermis with the cuticle somewhat brown in places (Fig. 3, *I*). The examination of a section of *leuconotus* (*B*) from approximately the same location as the one taken from *nigronotatus* (*I*) (Fig. 3, *B*) shows the hypodermis to be practically without pigment and the cuticle colourless. A section from approximately the same part of the pronotum of *leuconotus-nigronotatus* (*BI*) (Fig. 3, *BI*) reveals a nearly clear cuticle with about one-half as much hypodermal pigment as is found in *nigronotatus* (*I*). The situation regarding pigmentation in the pronotum of *texanus* and the hybrid from it and *leuconotus* (*B*) appears to be exactly the same as that for *nigronotatus* (*I*), *leuconotus* (*B*) and their hybrid *leuconotus-nigronotatus* (*BI*). In the figure (Fig. 3) *texanus* is placed opposite *nigronotatus*, and the *leuconotus-texanus* hybrid is placed opposite the *leuconotus-nigronotatus* (*BI*) hybrid, although the drawings were made from the specimens first described.

This study reveals the fact that the character of *nigronotatus* (*I*) is as much present in this posterior part of the pronotum of the hybrid *leuconotus-nigronotatus* (*BI*), as the more advantageously displayed *leuconotus* (*B*), though the latter when the hybrid is scrutinized superficially, is the only one apparent. The same proportions and relations in the pigmentation of *texanus* and the heterozygote, *leuconotus-texanus*, are shown. The preliminary examination of the pronota of some of the other hybrids and their parent forms reveals a similar situation. The evidence indicates that the peculiar pigmental elements of each of the patterns of the pronota of the parents are present in the pronotum of their hybrid in about equal proportions.

VI. DISCUSSION.

(1) *The inheritance of the colour patterns.* The inheritance behaviour throughout the experiments, with five exceptions (*leuconotus-luteolineatus-nigronotatus* (*BEI*) Table III (*e*)), and four others now being bred and to be described later, fulfils very nearly the Mendelian expectations. Among more than 5000 recorded individuals resulting from the crossing of species, inbreeding and crossing of hybrids, and the crossing of hybrids with species, and more than 2000 recorded progeny from the inbreeding of species, only the five unexpected

individuals appeared, and the expectations in regard to the proportionate numbers have been fairly realized.

The Mendelian assumption that hybrids do not produce gametes representing themselves, but give gametes of the species from which they themselves were formed and that these gametes are produced alternatively in about equal proportions, accounts, with the five exceptions, for all the results which have come from my breeding experiments with the grouse locusts.

In Exps. I (F_2 -), II (*b*) and (*c*), III (*a*), (*b*), (*c*), (*d*), and V (*a*), (*b*), the ancestry of the parents used was known for one or more generations, and their resulting progeny, in the matter of patterns completely (with the five exceptions in thousands), and in the matter of proportionate numbers, fairly, approximated to the expectations of alternative inheritance. As the results from known parents are closely approximate to expectation, it seems reasonable to expect the equally regular and similar results from parents whose ancestry was not known at first to lead to the identification of the constitution of the parents themselves. It has been by this method that the constitutions of the parents from the field and group cultures used in Exps. I, II, and IV have been determined.

(2) *The appearance of long and short wingedness.* A glance at the behaviour of the wing lengths character shows that the short winged required the maximum of time to reach maturity after hatching, and that this great length of time is closely correlated with the time of the year—the fall and winter months. The long winged individuals on the other hand required a minimum of time to reach maturity after hatching, and this minimum time is also closely correlated with the time of the year—the spring and early summer. The time of the year during which growth proceeds seems to determine whether it shall extend over a long period or not. If the time for growth be a long one the wing lengths are likely to be short; if the time required for growth be a short one the wing lengths are likely to be long. The length of the wings of the parents does not condition this character in the progeny. The progeny of short winged individuals become long winged if they grow quickly in the spring. The progeny of the long winged individuals become short winged if the growth take place slowly during a long time. Long winged individuals may produce a majority short winged if the growth take place from October to April, while their brother and sister short winged ones may produce all long winged, if the growth progress from March to June. Nor does

the phenomenon appear to be due to an inherited seasonal rhythm; for the fourth generation progeny, coming from the short winged generation III, which had grown from July to February, the time required for two generations of their brother and sister generation II and III progeny, behaved exactly as the progeny F_5 of the long winged and short winged which had come from the fourth generation of the same line.

(3) *Equivalence in the hybrids.* From the examination of the pigmental compositions of the colour patterns of the pronota so far as it has progressed, the conclusion seems to be justified that the peculiar pigmental elements of each of the patterns of the pronota of the parents are present in the pattern of the pronotum of their hybrid in about, if not in exactly, equal proportions. With this knowledge in mind it does not appear that the terms dominant and recessive are applicable at all to these grouse locusts; they appear to be, in respect to their representation in the composition of their hybrids, perfectly equivalent, or, to use Davenport's term, equipotent (2). If only the superficial appearances be taken into consideration, Bateson's terms of epistatic, for the colour most apparent, and hypostatic, for the colour less apparent, may be employed in some instances (1).

The fact that the heterozygote pattern in the end result is so equivalently made up of the respective patterns of the parent species seems to warrant the suggestion that the somatic part of the hybrid zygote (fertilized hybrid ovum) in its somatogenesis may be in some way alternative, giving the character of the one, and then the character of the other, parent to the resulting soma of the hybrid; just as the gametal part of this same hybrid zygote in its gametogenesis is usually most certainly alternative, giving a gamete for the one, and then a gamete for the other parent.

(4) *The "Genotype Conception."* These forms approximately, if not completely, fulfil the requirements of the description of biotypes by Johannsen. The evidence points to the fact that in none of the inheritance behaviour observed is there any transmission of the qualities of the parent to the offspring (5). (There have been five exceptions noted.) The regular 1:2:1 ratio result of the inbreeding of hybrids, the 1:1 ratio result of the crossing of hybrids with their parent types, and the 1:1:1:1 ratio result of the interbreeding of hybrids indicate that the qualities of the parents, as well as the qualities of the progeny, are determined by the nature of the germinal material, and that the

germinal material of each species is pure and inviolate from generation to generation, whatever the combinations that are made with them. The fact that two germ plasms come together to make a heterozygote does not alter this situation, because, although combined in fertilization into a harmoniously acting zygotic system, they immediately separate in gametogenesis as though they had not been mixed at all but had been held together only. The resulting soma (the pattern only considered here) indicates that each of the gametes gives the soma characters of its own kind, and that these two sets of characters, from the two parental sources brought together in fertilization, are in a sense dove-tailed one into the other to make the individual heterozygotic combination.

VII. CONCLUSION.

The inheritance behaviour of the colour patterns in these orthopterous insects shows clearly the Mendelian type of inheritance, and the essential result of these experiments has been the extension of this principle to a considerable number of types of a phylogenetically low group of ametabolous insects.

All the hybrid patterns, except a few which have not been adequately examined, show plainly in their visible somatic constitution all the parts which can be distinguished in the somatic make-up of each of their parent patterns. No character of one parent species is ever replaced in the F_1 hybrid by any character of the other parent. All the characters of each parent are represented in the F_1 hybrid. It follows, then, that these grasshoppers do not exhibit characters, which by crossing can be replaced by other different characters; the whole pattern appears to be the only unit.

Dimorphism and polymorphism in the length of the wings and pronota are not inheritable, but are somatic, due to variable incident conditions under which the individuals grow. The conditions causing slow growth, extended over several months, produce a preponderance of short winged individuals. These conditions obtain in the fall and winter, and may be a matter largely of the lack of sunshine. The conditions causing quick growth, extended over a shorter time, produce a preponderance of long winged individuals. These conditions obtain in the spring and early summer and may be largely a matter of an abundance of sunshine.

I desire to express my thanks to Prof. W. L. Tower for the use of equipment and for much valuable time given in consultation during the progress of the work and the preparation of the MSS. The late

Prof. C. O. Whitman first suggested the problem and introduced me to Dr J. L. Hancock who has given valuable aid in the Taxonomy and Natural History of the material. To these friends I am grateful for invaluable assistance and encouragement.

EXPLANATION OF PLATE VI.

Most of the photographs are of females, the patterns of both males and females being the same. The difference in sizes is not significant, being due to the scale of the photographs.

The top row represents the true breeding forms. The middle and lower rows represent eighteen of the heterozygous forms derived from crossing the pure strains. *CG*, *CI*, *FH*, and *EH* are modified photographs, the patterns of the rest being untouched or only tinted.

BIBLIOGRAPHY.

1. 1909. BATESON, W. "Mendel's Principles of Heredity." Cambridge University Press.
2. 1907. DAVENPORT, C. B. "Heredity and Mendel's Law." *Proceedings of the Washington Academy of Sciences*, Vol. ix. p. 179.
3. 1910. DONCASTER, L. "Heredity in the Light of Recent Research." Cambridge University Press.
4. 1902. HANCOCK, J. L. "The Tettigidae of North America." Chicago.
5. 1911. JOHANNSEN, W. "The Genotype Conception of Heredity." *American Naturalist*, Vol. xlv. No. 531.
6. 1907. LUTZ, FRANK E. "The Variation and Correlation of the Taxonomic Characters of *Gryllus*." *Carnegie Inst. Pub.* 101.
7. 1910. MONTGOMERY, T. H. "Are Particular Chromosomes Sex Determinants?" *Biological Bulletin*, xix. No. 1, pp. 1—17.
8. 1910. TOWER, W. L. "The Determination of Dominance and the Modification of Behaviour in Alternative (Mendelian) Inheritance by Conditions Surrounding or Incident upon the Germ Cells at Fertilization." *Biological Bulletin*, xviii. pp. 285—337.
9. 1893. WHITMAN, C. O. "The Inadequacy of the Cell Theory of Development." *Woods Hole Biological Lectures*.





A
Paratettix texanus
Hanc.



B
P. leuconotus,
n. sp.



C
P. leucothorax,
n. sp.



D
P. punctofemorata,
n. sp.

Pure Strains



AB



BC



BG



BI

Hybrid



CF



CE



CH



CI

Hybrids



F

P. rufolineatus,
n. sp.



G

P. melanothorax,
n. sp.



H

P. luteonotatus,
n. sp.



I

P. nigronotatus,
n. sp.



BF



BE



CG



DI



FG



EH



EI



EF

H

A PRELIMINARY NOTE ON THE GENETICS OF *FRAGARIA*.

By C. W. RICHARDSON.

THE work described in this note was carried on at the John Innes Horticultural Institution, and I am deeply indebted for the facilities so kindly afforded me. This work is as yet in a preliminary stage, but enough progress has perhaps been made to justify an interim report.

§ I. EXPERIMENTS WITH *F. vesca*.

(a) Alpines (*F. vesca semperflorens*).

Alpines are generally said to belong to the *vesca* species, yet they differ from the English *vesca* in two or three minor habits of growth and in particular in the important habit of continuous flowering. Amongst the numerous varieties of Alpines is one, *F. de Gaillon*, introduced by Labaute in 1811, which never produces stolons (runners). At present my work on the nature of this runnerless condition is scarcely advanced enough to publish. But runner \times runnerless always gives runner-producing plants in F_1 , and runner and runnerless in F_2 , the runner being a marked dominant. The *DR* plants produce fewer runners in their second season than is the case with normal plants.

Fruit Colour.

In 1910 I crossed runnerless White (*W*) with runner-producing Red (*R*).

TABLE I.

1910	Parents	$W \times R$
1911	F_1	R
1912	F_2	<div style="display: flex; justify-content: space-around; align-items: center;"> <div style="text-align: center;"> 70 Red </div> <div style="text-align: center;"> 20 White (no intermediates) </div> </div>
	3 to 1	Expectation 67.5 <i>R</i> , 22.5 <i>W</i>

(b) *F. vesca monophylla*.

Duchesne's father sowed *elatior* (Hautbois) seed in 1760, and in 1761, amongst the plants that came up, sowed *vesca* seeds. The plants were neglected till 1763, when Duchesne *filed* went through them and found one plant with single leaves (Fig. 1). This plant he said bred true whether from seed or stolons.



Fig. 1.



Fig. 2.



Fig. 3.

In 1910 I received some plants of *monophylla* character from France; some of these in spring and late autumn produce a few bifoliate and trifoliate leaves. In 1912 I selfed one plant, apparently a pure *monophylla*, and obtained 15 plants, up to the present, always true, and 10 plants giving occasional bifoliate or trifoliate leaves (Figs. 2 and 3).

In 1911 I crossed *vesca*, trifoliate, normal (*N*) with *monophylla* abnormal (*A*).

TABLE II.

1911	Parents	$N \times A$
1912	F_1	
		├───┬───┘
1913	F_2	177 <i>N</i> 73 <i>A</i> (Plate VII, fig. 1)

Before leaving the subject of *monophyllas* I would call attention to a curious plant (Plate VII, fig. 2). Before I had any *monophyllas* I selfed a plant that had "gone wild" on the edge of a grass-covered bank invading a bed of Royal Sovereigns; from this I obtained a large family not unlike a family I obtained at the same date from a selfed Royal Sovereign. From one plant of this family which I selfed I obtained a small family all more or less abnormal. The plant depicted is probably the most



Fig. 1.



Fig. 2.

abnormal. As may be seen it produces leaves like those of *monophylla*, others bifoliate and trifoliate in no set order. This plant, though in its third season, has as yet produced no flowers.

§ II. GARDEN HYBRIDS.

Something of the origin of the modern Garden Strawberry is known, but its whole history is not. It springs from an old form of Garden Strawberry, the results of crosses between *vescas*, Alpines and Hautbois. This older form was again crossed with *F. virginiana*, introduced in 1629, and *F. chiloensis*, introduced to Marseilles in 1712 and to England in 1727 by Philip Miller. These crosses were again crossed with *F. ananassa* (*F. grandiflora*¹), introduced from Holland during the eighteenth century. The origin of this plant is unknown. It was said to have been brought from Surinam, where to-day there are said to be no strawberries. It is also said to have been a variety of *virginiana* brought from Carolina. It may be a *chinensis* cross, as Holland received many plants from China during the eighteenth century. Whatever its origin all our best garden varieties of to-day are descended from *Fr. ananassa* crosses. I have selfed 8 varieties of garden fruit, producing over 1000 plants. Not one resembles a *vesca*, or an Alpine, but many show distinct traces of *chiloensis*, more of *virginiana* and not a few of *chinensis*. The leaf-character of Hautbois occasionally appears in those of French origin, and I have met with it in the offspring of "Latest of All"—a variety derived by Laxton from the French Héléne Gloede as one parent.

Perpetuals.

There is no precise record of the parentage of the first perpetuals. It is generally stated that they were crosses of garden varieties and Alpines—the perpetual habit (i.e. the habit of flowering and fruiting more than once in a season) coming from the Alpines. I have crossed Alpines with garden varieties, but have invariably found the resulting plants produce very poorly developed flowers, which have no pollen, and, when crossed back with their original parents, produce very few seeds,

¹ Miller's *Figures of Plants*, Vol. II. 1760.—"Some Persons have affirmed it" (*Fr. ananasse*) "was brought from Louisiana; others, that it came from Virginia; but I received some Plants of this Kind from a curious Gentleman of Amsterdam, who assured me they were brought from Surinam."

Cf. Duchesne, *Histoire Naturelle des Fraisiers*, p. 190, Paris, 1766. Also J. Gay, *Annales des Sciences Naturelles*, VIII. 1857, p. 204. Also Knight, *Tr. Hort. Soc.* III. p. 207. None of these accept the Surinam theory of the "curious Gentleman."

The plants I have of $F_1 \times P$ are not old enough to flower, but the results should be interesting. This at least tends to discourage the view that Alpines cannot be crossed with garden varieties, though, at the same time, it does not prove that our perpetuals of to-day sprang originally from the cross Alpine and garden variety.

The first perpetual widely known was "Gloede's seedling," Ananas Perpetual, no great success. Then came Mabile (Limoges) with l'In-épuisable, also no great success. Then came Roi Henri, St Joseph and the perpetuals of to-day the work of Abbé Thivolet.

In the endeavour to segregate the perpetual character I selfed, in 1911, St Antoine de Padoue. In 1911 I counted 93 Perpetuals (*P*) and 35 non-Perpetuals (*NP*), 2 doubtfuls. In 1912 I tested these 130 plants again removing all flowers to prevent early fruiting and obtained the result in September and October

108 <i>P</i>		22 <i>NP</i>
Expectation (3 to 1)	97.5 <i>P</i>	32.5 <i>NP</i> .

In 1910 I selfed "Laxton's Perpetual."

In May 1912 I removed all flowers from the resulting plants and obtained in October,

69 <i>P</i>	11 <i>NP</i>	2 doubtful
Expectation (3 to 1)	61.5 <i>P</i>	20.5 <i>NP</i> .

In 1910 I crossed the garden variety "Bedford Champion" (non-perpetual) with "Laxton's Perpetual."

In May 1912 I removed all flowers from the resulting plants and obtained in October,

24 <i>P</i>	53 <i>NP</i> .
-------------	----------------

The simplest expectation would be equality, from which the departure is considerable. Later results suggest that various complications have to be considered which, as yet, I cannot interpret. Subsequent experiments have resulted as follows:—

In 1911 "St Antoine de Padoue" was again selfed, and gave in October 1913—

64 <i>P</i>	6 <i>NP</i>	1 doubtful, also 16 dead plants.
-------------	-------------	----------------------------------

Perpetuals appear to resist drought better than non-perpetuals, accordingly it is quite possible many dead plants were non-perpetual. Another point, worth noting, is that this year (1913), after dry weather during July, August and September, many garden varieties flowered in October which would not have done so under normal conditions.

I find F_2 's of my first St Antoine family frequently come true to the perpetual habit. But no clear case of a non-perpetual F_1 breeding true has appeared—the nearest gives

20 *NP* 2 *P* 2 possibly *NP*.

For reasons already stated the two *P*'s may be *NP*'s.

F_2 's of "Bedford Champion" × "Laxton's Perpetual" have resulted up to the present in

F_1 (Parent *NP*)

8 *NP* 6 *P*

F_1 (Parent *P*)

14 *NP* 5 *P*.

With the pure perpetuals, now obtained, more satisfactory results are to be looked for, but the evidence to hand points to the perpetual habit depending upon more than one factor.

§ III. SEX.

In crossing *Fragaria* the question of sex inheritance is of the greatest importance. It is rash to come to the conclusion that any cross, made with plants of one sex, which produces sterile flowers, is bound to produce sterile flowers when made with similar plants of a different sex. Knowledge of the heredity of sex, if it could be obtained, would be of extreme use to the producer of new garden varieties, for the best fruit comes from the plants that have both the male and female parts of the flower well developed¹.

Various sexual arrangements are found amongst strawberry flowers.

1. Females with the male organs undeveloped.
2. Females with most of the female organs atrophied or hypertrophied and inefficient and no male organs developed.
3. True hermaphrodites with both male and female organs developed.
4. Males with the female organs undeveloped.
5. Males with the female organs only developed in a few flowers (generally the first flowers produced in each truss).
6. Flowers with neither male nor female organs developed, or with female organs hypertrophied.

¹ Keens remarked on Hautbois with a dioecious arrangement. *Tr. Hort. Soc.* 11. p. 393.

My first *virginiana* plants, obtained from Kew, were females with rudiments of stamens but no pollen. Accordingly I obtained plants from America, which were said to be males. Any that flowered the first year they arrived were apparently males. In the following year (1913) I found these new plants consisted of males, hermaphrodites and females. Some apparent hermaphrodites are really males, but as these cannot be distinguished from functional hermaphrodites by simple inspection, I have as yet been unable to make the crosses Male \times Female, Male \times Hermaphrodite and Female \times Hermaphrodite, and to self Hermaphrodite; but at the earliest possible date I intend to make these crosses, as my plants are now apparently classified.

The following crosses made in 1911 are of interest (purely female *virginiana* used throughout).

Parents *virginiana* and *chiloensis* (I think) pure male.

F_1 16 ♀ 12 ♂ 6 ♀.

Three plants did not flower.

Parents *virginiana* \times *chiloensis lucida*, pure male.

F_1 49 ♀ 27 ♂ 16 ♀.

Eleven plants did not flower.

Parents *virginiana* \times *grandiflora*, hermaphrodite.

20 ♀ 0 ♂ 14 ♀.

Forty-two plants did not flower.

Parents *virginiana* \times *vesca*, hermaphrodite.

F_1 . A very few fertile females, a very few fertile hermaphrodites, sterile females, some apparently males and a large number of plants that did not flower. (The plants are rather too young to base results on but show three sex-types.)

A cross of nearly pure male *chiloensis* hermaphrodite \times *grandiflora*, hermaphrodite (used as male parent) gave a minority of hermaphrodite, a majority of males, and no females.

That the crosses female *virginiana* \times *grandiflora* hermaphrodite and nearly male *chiloensis* \times the same *grandiflora* pollen produced no males in the first case and no females in the second is certainly curious.

It is worth remarking that one or two female flowers on a plant may set a seed or two and all the other flowers be quite sterile, or again on another plant of the same parentage one female flower may set seed freely and all the other flowers be sterile.

Fig. 4 represents an effort of a sterile female to produce a fruit without setting a single seed, though it has been thoroughly pollinated¹. The actual cross here is *vesca* × Laxton's Bedford Champion.



Fig. 4.

A few plants of this cross have set a few seeds when pollinated with either parent; of the two The Champion seems the more successful sire; at present these cross-backs are too young to draw conclusions from.

The cross pink-flowering *vesca* × *white vesca* produced pink F_1 's. I have F_2 plants which should flower next spring. The cross double × single flowering *vesca* produced plants with single flowers and occasionally flowers with a few extra petals in F_1 . My F_2 's should flower next season. The thick *rubbery* leaves of *chiloensis* have appeared in all F_1 's I have obtained from this species crossed with others, though the leaves are larger than those of the normal *chiloensis*; some F_2 's of my *chiloensis* crosses should be old enough next year to show to some extent how far leaf characters can be segregated. Some multifoliate plants when selfed have given a majority of multifoliate plants. My actual numbers were too small to base conclusions on. On the whole, I expect, judging by results I have already obtained, that most characters possessed by *Fragaria* are capable of segregation, but at the same time some linked characters may present difficulties which it may take years to solve.

For plants of *F. virginiana* from a wild source I am indebted to Dr W. A. Orton of the Department of Agriculture, Washington, and Professor Czapek of Prag very kindly sent plants of *F. elatior* which I am also using.

¹ Knight mentions a seedling Hautbois × Alpine in which the fruit developed though no seed was formed. *Tr. Hort. Soc.* v. 294.

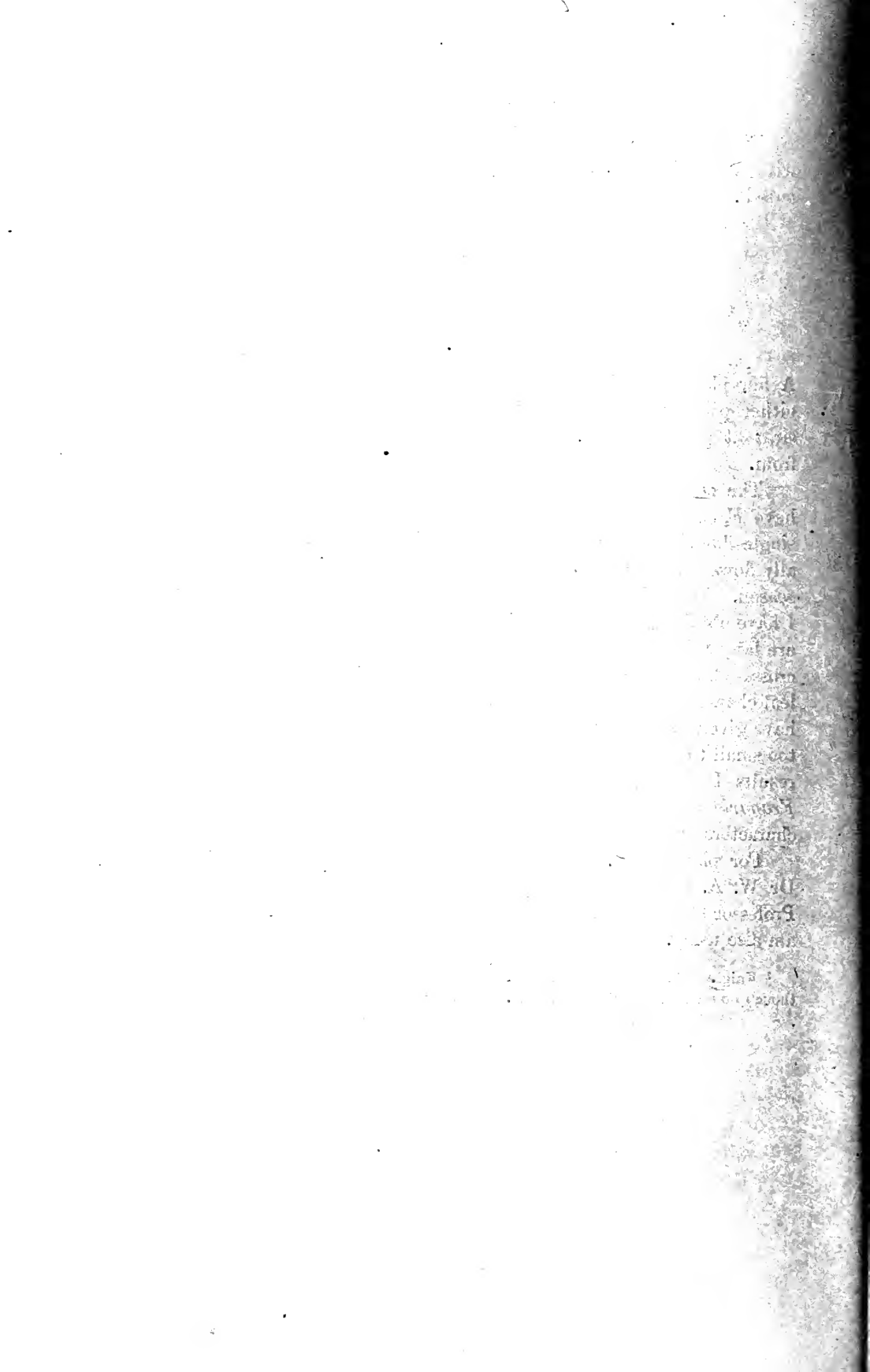

PARTHENOGENETIC AND SEXUAL REPRODUCTION IN *SIMOCEPHALUS VETULUS* AND OTHER CLADOCERA.

By W. E. AGAR,
University of Glasgow.

IN 1879 Weismann formulated the theory that in the Cladocera "der Eintritt der Geschlechtsperiode wird überhaupt nicht durch direct wirkende äussere Momente veranlasst, sondern lediglich durch innere in der Natur des Organismus begründete." There can be no doubt that this total denial of the influence of environment can no longer be maintained. It is as certain as experiment can ever make it, that under some conditions parthenogenetic reproduction will proceed longer than under others, and that to some degree the appearance of sexual forms can be controlled by controlling the environment. The latest and probably the most conclusive evidence of this is given by Grosvenor and Smith for *Moina*. It is true that many experimenters have failed to find any evidence of the direct effect of environment, but this negative evidence cannot be put against the quite satisfactory positive results of other workers. On the other hand, even those who admit the influence of environment do not give up the idea of an underlying "cycle" as well (Issakowitsch, Papanicolau, Woltereck, R. Hertwig).

The object of this note is to present some new evidence and point out some general indications that the change from parthenogenetic to sexual reproduction, and the degeneration which so often accompanies it under experimental conditions, is determined by environment only, and that the number of preceding parthenogenetic generations or the lapse of time since the last sexual act are not, as such, relevant to the matter at all.

My own experiments have dealt chiefly with *Simocephalus vetulus*, and were not undertaken in relation to the reproductive cycle problem,

but in connection with various problems of heredity. As, however, the experiments have been extensive, and as one line in particular was bred for 46 successive generations, they are able incidentally to afford very instructive information upon the sexuality question.

It would be useless to review completely the bulky literature dealing with reproduction in Cladocera, and for this I refer the reader to the discussions and literature lists in the works of Papanicolau, Woltereck and Hertwig. It is well, however, to mention a few researches dealing specially with *S. vetulus*.

This species was one of those dealt with by Weismann in 1879, and on which his theory quoted above was based.

Issakowitsch (1908), who experimented with this among other species, comes to the conclusion that it has an inherent reproductive cycle, the duration of which is not, however, independent of external conditions. For the "cycle" is due to an increasing "depression" of the germ cells (in the nucleo-cytoplasm relation sense) which in the early stages can be alleviated by various external factors, but at last gets to a stage when nothing but conjugation will save it from death.

Kuttner (1909) supported Weismann's extreme view. *S. vetulus* was one of the species experimented with.

We must consider Papanicolau's experiment (1911) rather more closely as it was carried out in great detail and thoroughness, and as the conclusions have been accepted by R. Hertwig and used by him in support of his theory of "depression" periods leading to sexual conjugation.

Papanicolau's main experiment dealt with a line bred from an *ex-ephippio* female at room temperature, and gave the following chief results.

1. The line bred parthenogenetically for twenty generations, sexual and degenerate forms getting more and more numerous, the twentieth generation consisting entirely of males and degenerated animals, and parthenogenesis then ceased altogether.

2. Sexual individuals began to appear in late broods of early generations (e.g. in the tenth brood produced by generation 2, in the eighth brood produced by generation 3) and appeared in earlier and earlier broods in later generations, till they occurred in the second brood of generation 17 and first of generation 20.

3. A great many weak and degenerate forms appeared, often abnormal and dying before birth. The appearance of these degenerate forms accompanied that of the sexual ones, and the same phenomenon

of their earlier and earlier appearance in succeeding generations was observed.

4. There was a gradual decrease in the number and an increase in the size of the eggs from generation to generation, and also, as regards size, from brood to brood of the same generation.

He therefore concludes that there is an inherent "sexual cycle" of the orthodox kind in *S. vetulus*, beginning with vigorous parthenogenetic reproduction which gradually gives place to increasing sexuality and degeneracy, ending in total cessation of asexual reproduction. He is, however, prepared to admit that external conditions influence the duration of the cycle to a certain extent.

The line of *S. vetulus* whose sexual condition I wish to describe originated from a parthenogenetic female taken from one of the laboratory tanks in September, 1911. I have of course no knowledge of the number of generations which intervened between it and the last ephippial egg.

Some of the descendants of this individual formed the material on which I did some experiments recently published on the transmission of environmental effects, and also an experiment on parthenogenetic inheritance, not yet published. The method of breeding employed for the great majority of the individuals was that which I described as "normal" or "control" in my former paper. They were bred in cylindrical glass tubes 10 × 3 cms., which when corked (as they always were) contained about 50 c.c. of water and 15 c.c. of air. With rare exceptions one specimen only was kept in each tube, and when it had produced a brood, this was removed within 36 hours. The culture medium was the water from a tank in which were living a number of *Lepidosiren paradoxa*, fed daily with *Anodonta*. The water in this tank was changed weekly (except for that held in a thick layer of mud at the bottom of the tank) and was thick with Infusoria and organic detritus. A jar of water was taken from this tank on alternate days, strained through linen to remove Rotifers, Lynceids, etc. which swarmed in it, and used to renew the water every alternate day in all the breeding tubes. Each *Simocephalus* was picked out of its tube with a pipette, the tube emptied and refilled with the new water and the specimen returned.

The sexual conditions of this line are shown in Table I.

The sex of a new-born *S. vetulus* is very difficult to determine, and I did not attempt to do so, as the experiment was not directed towards this question. The sex of every individual which was kept to maturity

TABLE I.

Number of Broods and Individuals tested for Sexuality in each Generation.

Generation	1st Broods	2nd Broods	3rd Broods	4th Broods	5th Broods	6th Broods	7th Broods	8th Broods	9th Broods	10th Broods	11th Brood
1	1-1	—	—	—	—	—	—	—	—	—	—
2	1-1	1-2	×	×	—	—	—	—	—	—	—
3	×	3-4	1-1	1-4	—	—	—	—	—	—	—
4	4-13	×	×	×	—	—	—	—	—	—	—
5	7-21	5-13	2-13	1-6	1-1	×	×	—	—	—	—
6	*8-11	4-5	4-10	2-2	2-2	×	1-1	—	—	—	—
7	*11-25	5-10	2-2	×	×	—	—	—	—	—	—
8	11-11	×	2-2	4-10	×	—	—	—	—	—	—
9	*8-15	1-9	×	×	×	×	×	—	—	—	—
10	10-26	×	1-2	×	—	—	—	—	—	—	—
11	9-20	9-17	5-11	1-2	×	×	—	—	—	—	—
12	18-36	×	×	×	×	—	—	—	—	—	—
13	24-82	3-12	1-3	1-2	×	—	—	—	—	—	—
14	38-72	1-3	3-9	1-2	×	—	—	—	—	—	—
15	31-62	×	×	×	×	—	—	—	—	—	—
16	28-28	×	—	—	—	—	—	—	—	—	—
17	26-26	—	—	—	—	—	—	—	—	—	—
18	24-48	×	×	×	×	×	×	8-8	—	—	—
19	39-44	×	×	×	×	×	×	1-2	1-2	1-2	—
20	×	6-29	×	×	×	×	×	×	×	×	1-3
21	11-37	×	×	×	×	×	×	×	×	1-2	—
22	6-9	×	×	×	×	2-4	—	—	—	—	—
23	2-4	—	—	—	—	—	—	—	—	—	—
24	2-4	—	—	—	—	—	—	—	—	—	—
25	2-3	—	—	—	—	—	—	—	—	—	—
26	×	3-12	—	—	—	—	—	—	—	—	—
27	9-31	—	—	—	—	—	—	—	—	—	—
28	13-17	—	—	—	—	—	—	—	—	—	—
29	6-7	—	—	—	—	—	—	—	—	—	—
30	2-4	3-3	—	—	—	—	—	—	—	—	—
31	3-3	—	—	—	—	—	—	—	—	—	—
32	3-10	—	—	—	—	—	—	—	—	—	—
33	5-7	—	—	—	—	—	—	—	—	—	—
34	5-9	—	—	—	—	—	—	—	—	—	—
35	3-4	—	—	—	—	—	—	—	—	—	—
36	1-6	—	—	—	—	—	—	—	—	—	—
37	3-7	—	—	—	—	—	—	—	—	—	—
38	3-4	—	—	—	—	—	—	—	—	—	—
39	4-4	—	—	—	—	—	—	—	—	—	—
40	3-3	—	—	—	—	—	—	—	—	—	—
41	3-3	—	—	—	—	—	—	—	—	—	—
42	3-3	—	—	—	—	—	—	—	—	—	—
43	3-3	—	—	—	—	—	—	—	—	—	—
44	3-3	—	—	—	—	—	—	—	—	—	—
45	3-3	—	—	—	—	—	—	—	—	—	—
46	×	—	—	—	—	—	—	—	—	—	—

In each column the number of broods (families) tested is given first, and then the number of individuals from these broods which were allowed to come to maturity (see text).

×, Brood recorded, but not tested for sexuality.

* Males occurred in these broods (see text).

was however recorded, and these form the material available for the table. One example of how the table is to be read will explain it at once. Take generation 10¹ for example. In this generation ten first broods were tested for sex—i.e. the first broods from ten individuals of the preceding generation. By "tested for sex" I mean that one or more of the young were brought to maturity and the sex recorded. In this case altogether 26 individuals were taken from the ten broods. In the same generation no individuals belonging to second broods were kept to maturity, but one third brood was tested by the isolation of two members of it. As the members of a brood in *Simocephalus* (as in *Daphnia*) generally all, or mainly all, belong to the same sex, it is important to state how many broods were tested, and not merely the number of individuals without reference to the number of families from which they were taken.

The result of the experiment was as follows:—No sexual (ephippial) females appeared during the whole of the experiment. Males appeared in three generations only, where the asterisks are placed in the table. In generation 6 there was one male from one of the first broods, in generation 7 two of the first broods furnished between them five males, and in generation 9 there were three males from one of the first broods. All the other broods and all the other generations afforded parthenogenetic females only.

Thus so far from a progressive increase in sexuality, the very few sexual forms that did appear were in the early generations of the experiment.

These 46 generations were passed through in twenty-one months, at room temperature. The average duration of each generation would however have been far greater at the mean annual temperature in their natural ponds. Papanicolau estimates the maximum number of parthenogenetic generations in a natural "cycle" at twelve, and this agrees roughly with my estimate of the greatest number that could be produced in a year under the climatic conditions of Glasgow. Even during the time in which the line was bred in my experiment, parthenogenesis lasted therefore for nearly four times as many generations as may be expected in nature (though of course the natural "cycle" is by no means a rigid one), and at the end of the experiment no trace of loss of vigour was detectable.

According to Papanicolau, not only should sexual forms appear with

¹ The original parthenogenetic female from which the line was started being counted as generation 1.

increasing frequency in later generations, but also in later broods of earlier generations. Now all the four broods which gave males in my experiment were first broods. Yet broods of a much higher order were tested and furnished parthenogenetic females only.

Also according to Papanicolau, a potent factor in producing sexual forms is not only the order of the brood, but the order of the brood to which the parent belonged. The greater part, but far from all, of each generation in my experiment was descended from first broods in the preceding generation. This however was also the case in Papanicolau's main experiment (Tafel I), in which the line ended altogether in sexual and degenerate forms in the twentieth generation. A direct test of the influence of the order of the brood was also made. It will be seen that in generation 22 two sixth broods were tested for sex. Now the parents of these sixth broods were members of the tenth brood of a specimen of generation 21 which was itself a member of the eleventh brood of an individual of generation 20, itself descended from the tenth brood of generation 19, the parent of which was a member of the ninth brood of generation 18. This is a far severer test than any which Papanicolau describes, and yet all were parthenogenetic females. (Breeding from late broods like this makes each generation fall far behind, in point of time, the generations bred chiefly from first broods. The sixth broods of generation 22 were contemporary with the first broods of generation 36 of the main part of the line.)

The third of our list of Papanicolau's conclusions has been no more my experience in this experiment than were his others. He found degenerate broods extremely common, increasing in frequency *pari passu* with the sexual forms. I have had very few of these degenerates, and they certainly showed no tendency to increase as the line grew older.

As mentioned above, the great majority of the individuals of this line were bred under the conditions which I have for convenience termed "normal" as distinct from the intentionally abnormal conditions under which a part of the line was bred. The "normal" and abnormal environments resulted in similar sexual conditions however. The abnormal environments included feeding with a protophyte culture which produced certain specific abnormal characters (described in my paper of 1913), cultivation in chemical solutions, and at high and low temperatures. In the case of the high temperature, part of the line was subjected to the abnormal condition for four or five successive generations. Naturally abnormalities and a higher death rate were

produced by these conditions, but in the main part of the line, under the normal conditions, "degenerates" have been extremely rare.

On two occasions however there was an epidemic of deaths among young individuals and embryos in the part of the line under normal conditions. The first of these occurred in generation 4, the second in generation 30. The second one was very instructive as at that time I had under identical conditions parallel cultures of two other lines started from specimens obtained from different localities to that from which the parent of the principal line was obtained. The two lines in question were started from parthenogenetic females from Cambridge and Beith respectively, and generation 13 of the Cambridge line and generation 14 of the Beith line were contemporary with generation 30 of the main line, and all of them showed simultaneously the same "degeneration." In the main line four females laid altogether 19 eggs, from which only two living young were obtained. In the Cambridge line, six females laid together 31 eggs, and only 12 living young were born, while from the Beith line no living young were produced from 29 eggs laid by six females. These figures all refer to the first broods of the parents. All three lines had completely recovered by the second broods of the same generation, the second batches of eggs laid by all these sixteen females developing perfectly normally into normal healthy young. Moreover, except for occasional cases here and there, no more "degenerate forms" appeared in any of the three lines. In fact in the main line (Table I), in the last eleven generations not a single one of the new-born young isolated failed to arrive at maturity, and to produce perfectly normal young. Clearly therefore the temporary and simultaneous disturbance in the three lines was due to some temporary unfavourable factor in the environment, although there was no reason to suppose that the water in the *Lepidosiren* tank varied in any way from the normal at that time; while all the other factors of the environment were, so far as could be ascertained, unaltered.

The last of the visible accompaniments of degeneracy observed by Papanicolau which we need consider is the diminution in number and the increase in size of the parthenogenetic eggs as the line grew older. These are really largely the same phenomenon, there being a strong organic correlation between the number and size of the eggs, the larger the number the smaller being their size. This is the case, that is to say, if we judge the size of the eggs by that of the new-born young hatched from them. I have found it very difficult to get a satisfactory series of measurements of the eggs owing to their rapid increase in size

as they develop. The young however do not grow between ecdyses to any extent detectable by the micrometer. An actual determination of the coefficient of correlation between size of young and number of eggs for *S. vetulus* gave $-.74 \pm .04$. The value for *S. exspinosus*, worked out in larger numbers, gave as an average $-.43$. The values were computed for groups for individuals belonging to the same generation and all giving birth to their young nearly at the same time, and refer to first broods only.

As these experiments were primarily directed to the inheritance of certain dimensions of the young, I have a large number of measurements available. Table II gives the mean length of the new-born young

TABLE II.

Mean Length of the New-Born Young (in first Broods only).

Unit of Measurement = 0.018 mm.

Generation	Mean Length of New-Born Young	Number of Broods	Number of Individuals	Generation	Mean Length of New-Born Young	Number of Broods	Number of Individuals
3	43.717	3	23	25	43.667	4	30
4	44.448	4	29	26	44.654	3	13
5	43.455	2	11	27	43.954	12	76
6	43.450	4	20	28	45.277	23	195
7	45.643	2	7	29	44.629	11	58
8	43.911	5	28	30	45.000	1	1
9	43.333	6	24	31	45.133	3	15
10	43.276	5	29	32	46.500	2	4
11	43.191	9	44	33	43.714	3	28
12	41.628	7	39	34	42.071	3	14
13	43.952	15	104	35	44.050	3	10
14	43.616	62	468	36	47.083	1	6
15	41.736	64	639	37	43.547	3	21
16	42.194	62	474	38	45.864	3	11
17	44.896	28	203	39	not measured		
18	44.279	26	231	40	not measured		
19	43.384	43	241	41	43.115	3	13
20	43.263	42	302	42	44.017	3	30
21	41.536	29	223	43	44.692	3	26
22	41.310	37	179	44	43.667	3	12
23	44.000	8	47	45	43.278	3	27
24	44.350	4	20	46	44.848	3	23

Note. The column "Number of Individuals" gives the number of young measured in each generation, not the total number of young born. When any brood contained less than ten individuals all of them were measured, but when there were more than ten, only the first ten, taken at random. Thus the mean number of young per brood cannot be obtained from this table by dividing the number of individuals in each generation by the number of broods.

(i.e. in their first instar), for the last 44 generations, the first two not being available for this purpose. Only *first* broods are dealt with in the table, and those portions of the line living under the abnormal conditions described above are omitted, as these conditions directly affected the size of the new-born young.

It will be seen that the size fluctuates greatly, but there is no real tendency to a progressive increase. If the forty-four generations are divided into four groups of eleven each, we find:

Mean length for generations	3—13	43·637
"	"	14—24	...	43·017
"	"	25—35	...	44·423
"	"	36—46	...	44·457

It will be seen that the second set of eleven generations average smaller than the first. It is true that the last period gives the highest average, thanks to generation 36 which was represented by only a single brood of exceptionally large individuals. The mean of the last six generations however is 43·936, almost exactly equal to the total mean (43·889) and so is the mean for the first six, 44·104. There is thus no justification for supposing that the size of the young is increasing, although by taking twenty successive generations (Papanicolau's number) a good case might be made out for either increasing or decreasing size according to the portion of the table included by them.

I can fully confirm Papanicolau's statement that the size of the egg (or new-born young) increases from brood to brood—at any rate up to about the fifth. Exact measurements of this increase were given in my former paper. This increase however is in no sense due to a cyclical or cumulative action of the increasing lapse of time since the last sexual act. It is a phenomenon which begins afresh in each generation, and seems to be a common occurrence throughout the animal kingdom. The increasing size of the eggs of successive ovipositions has been shown in detail by Halban for *Salamandra maculosa* and *S. atra*, and also for *Anura* and *Chelonia*. It is the experience of every poultry keeper that the young hens lay smaller eggs than the older ones, and it is well known to be the case with man that the size of the new-born infant tends to increase in successive parturitions.

Whilst the line described above was in progress I also bred numerous others, the most important being two started respectively from a parthenogenetic female kindly sent me from Cambridge by Mr F. A. Potts and from one from Beith, 16 miles from Glasgow, kindly sent to me by

Mr John Ritchie. From the Beith specimen 17 generations were taken and from the Cambridge specimen 16 generations, giving with the original females 18 in the Beith and 17 in the Cambridge lines. They were kept under exactly the same conditions as the main line, and in neither of them were any sexual forms found at all, nor any appearance of "degeneracy," though as described above a very large proportion of the eggs of the first broods of the contemporary thirteenth generation of the Cambridge, and fourteenth of the Beith lines failed to develop.

It again happens that if the period during which these lines were bred is divided into two portions, the mean size of the young in the earlier generations is less than in the later ones. Combining the contemporary generations of the two lines together we find that the mean length of the first brood young of the first period (seven generations measured) is 45.256, and of the second period (also seven generations measured) is 45.904. A closer analysis shows however that it would be again quite unjustifiable to conclude that a progressive increase was taking place. If we arrange the generations in order of the magnitude of the new-born young, we find the order, beginning with the smallest, is (generations 1 and 9 not being available)

8, 5, 16, 2, 11, 17, 4, 3, 10, 14, 6, 12, 15, 7.

In a fairly extensive experience of breeding Cladocera I have of course often experienced the phenomena of bursts of sexuality and of "degeneracy"—or better, of high mortality. I have had both these phenomena appearing in *D. pulex*, and the sexuality in *S. exspinosus* kept under the conditions described as normal above, and also in *S. vetulus* kept under other conditions.

It is obvious therefore from this and from the work of others that the same species may under certain conditions exhibit an increasing tendency to sexuality and degeneration ending in total cessation of parthenogenetic reproduction, and under others may continue the asexual reproduction apparently indefinitely. My main line was to all appearance as vigorous at the 46th generation as at the first, and so were the Cambridge and Beith lines as long as they were bred—and it must be remembered that the parthenogenetic females which originated the three lines may themselves have had a long parthenogenetic ancestry. There is no justification for the supposition that if the experiment had been continued "long enough" the lines would have at last been unable to maintain themselves without sexual reproduction.

Three conditions of the environment seem to be specially significant in interpreting the almost uniform lack of sexuality, and the total lack of any tendency to degeneration observed in these three lines under long continued parthenogenesis.

Firstly, with the few exceptions of those individuals fed with the protophyte culture, they were all fed with the same food, and this food supply, though it may have fluctuated from day to day, probably did not do so over long periods, as the water in the *Lepidosiren* tank (which had been established more than three years before the experiment began) was changed weekly. Hence any cyclical change in the food supply was probably a weekly one, and there was little chance of a progressive deterioration in the culture medium lasting over weeks and months which might have caused sexuality and degeneration to set in.

Secondly, practically every individual was isolated in a separate tube within 48 hours of birth. The only exceptions were so rare as to be negligible, and moreover in only one case where more than one individual was kept in the same tube was such a specimen used as the ancestor of any considerable number of generations. In the light of Grosvenor and Smith's results as to increased sexuality in overcrowded animals, this is a significant point.

Thirdly, the water was changed regularly in all the tubes every second day—with again an insignificant number of exceptions.

General considerations.

It is obvious that it is no longer necessary in the present state of our knowledge to discuss the extreme Weismannian hypothesis that the parthenogenetic or sexual mode of reproduction is determined entirely by internal changes which are an integral part of the physiology of the animal and independent of environment. The idea of an internal cycle or rhythm still persists however, and it is undoubtedly the most generally accepted view to-day among workers on Cladocera that the change from parthenogenetic to sexual reproduction is determined by such a cycle, with the limitation that this change can be accelerated or delayed by particular conditions of the environment. This is expressed by Hertwig in the following sentence (p. 29): "Fortgesetzte Parthenogenese führe schon *als solche*¹ in der Beschaffenheit der Tiere zu Veränderungen, welche die Entwicklung der Geschlechtsgeneration veranlassen. Diese Umformung der Zellen könne durch einen entgegengesetzt wirkenden Faktor, wie die Wärme, vielleicht dauernd zurückgedrängt werden."

¹ My italics.

Amongst other upholders of the view of an inherent cyclical change which can be influenced to a greater or less extent by environment are Issakowitsch, Papanicolau, Woltereck. The kind of cycle maintained by Woltereck is however quite different from that supposed by Hertwig. The last-named worker correlates it with his nucleo-cytoplasm relation theory and considers that the lapse of parthenogenetic generations and of time leads to a state of depression in the germ cells that eventually under normal conditions ends in sexual conjugation or death. Woltereck justly points out that the theory would have to be strained to breaking point to cover his own experiments with *Hyalodaphnia*, etc. For instance, Woltereck bred a line of *H. cucullata* parthenogenetically for four years, during which time it fluctuated between pure parthenogenesis and pronounced sexuality. Hence we should have to suppose that the line recovered from pronounced sexual depression periods without sexual conjugation.

Woltereck's own view is that there are two antagonistic substances in the egg, the predominance of one resulting in parthenogenetic individuals, and of the other in sexual forms. These substances are supposed to wax and wane alternately and autonomously. At such times (labile periods) as they are nearly equally balanced, external conditions are able to turn the scale one way or the other, and thus at times environment influences sex. "Mann kann deshalb die *innere zyklische Periodizität der Valenz* (of these two substances) mit Recht als das Kernproblem der Cladocerenfortpflanzung bezeichnen" (p. 123).

Although Woltereck's cycle is far more compatible with the observed facts than is the theory of a depression caused by continued parthenogenesis as such, nevertheless there does not seem to be sufficient evidence for the existence of any sort of cycle at all, while there is strong evidence against it.

The evidence for the existence of such cycles consists mainly of:

1. Experiments where the conditions were supposed to be constant, such as (a) Papanicolau's work with *Simocephalus* and *Moina*, where an increasing sexuality and degeneration are observed, and (b) Woltereck's with *Hyalodaphnia*, where the line fluctuated between pure parthenogenesis and a high degree of sexuality.

2. Experiments where abnormal conditions of various kinds are found to have a determining influence in some cases and not in others. When such conditions are effective it is supposed that it is because the cycle has reached the point where the tendencies to parthenogenesis and sexuality are nearly balanced. When they are ineffective, it is ascribed

to the fact that the cycle is too near one end or the other for the opposite condition to be evoked.

Now it is quite possible to account for these observations without invoking an internal cycle. Firstly, it is extraordinarily difficult to keep all the conditions of the environment constant, and especially the great difficulty of keeping food cultures constant for long periods imposes upon the experimenter, who assumes that physiological changes in his animals were not correlated with changes in the environment, the obligation of stating very fully what precautions and tests he took to ensure that the conditions really were constant.

Secondly, even where the conditions are constant throughout the whole experiment, an increased tendency to sexuality in, say, the twentieth generation as compared with the tenth may be due to the fact that the line has been living for a longer period in an unsuitable environment—perhaps, for example, one deficient in some essential constituent or “vitaminic.” As both Papanicolau and Woltereck point out, not only the number of generations but also the length of time during which a line has been subjected to the experimental conditions is of importance in determining sexuality, for sexual forms appeared in late broods of early generations and early broods of late generations. In my experience with *S. vetulus* an individual of any generation produces its fourth brood about the same time as the members of its first broods produce their first brood of offspring. That is, the fourth broods of the n th generation are contemporary with the first broods of the $n + 1$ th generation. If this held true for Papanicolau’s strain of *S. vetulus*, it is easy to calculate from his Tafel I that sexual and degenerate forms appearing in the later broods of the earlier generations actually appeared earlier, in point of time, than those of later generations.

I have described experiments (1913) where the effects of a peculiar environment produced on a given generation of *S. vetulus* were still detectable in their great-grandchildren, and Woltereck has produced evidence to show that an environment acting on an individual may determine the sexuality of its grandchildren. It is plain, therefore, both that environmental effects may persist for some generations after they were produced—in other words that it may act in cumulative fashion—and also that the length of time and not only the number of generations during which the line has been in the conditions of the experiment, is of importance in determining sexuality. Taking this in conjunction with the fact that under some environmental conditions no

tendency to sexuality or degeneration appears even after an enormous number of parthenogenetic generations, it seems necessary, on the principle of accepting the simplest hypothesis which will fit the facts, to conclude that the sexual cycle (obligatory parthenogenesis—labile period—obligatory or preponderating sexuality, often accompanied under experimental conditions by “degeneration”) is, when present, due entirely to the cumulative effect of an unfavourable environment or to an actual though often unsuspected change from a favourable to an unfavourable environment.

This view does not, of course, diminish the physiological interest of the change from the parthenogenetic to the sexual mode of reproduction. Indeed the tendency to replace asexual by sexual reproduction under certain conditions (often unfavourable ones) is a phenomenon of the deepest significance, but it seems to be no more due to an inherent life cycle than the increasing hunger, ending in degeneration and death unless the conditions are changed, which accompanies the withholding of food from an organism, is due to an inherent physiological cycle.

The ascertainment of the exact conditions under which asexual is replaced by sexual reproduction, and the precise advantage conferred by the latter, is indeed a most important task. The external conditions under which parthenogenesis will continue indefinitely are certainly different for different species. They may be rarely realised in nature, and still more rarely for any prolonged period, natural conditions being subject to seasonal and other changes. For many species of the related Ostracoda however these conditions do seem to obtain in nature. On the other hand the other extreme is not impossible, that for some species in which asexual reproduction is one of the normal modes of reproduction, there are no conditions under which asexual reproduction can go on for more than a limited time. In other words, that there is no environment which does not act in a way prejudicial to parthenogenetic reproduction. If such species do exist, it might be legitimate to speak of their sexual cycle, but in that case it would be necessary to remember that the “cycle” is not due to anything of general import but merely to the peculiar relations of that particular species to the environment.

It appears that a similar change of view is taking place in regard to the life cycle of the Infusoria. For many years the orthodox view has been that originated by Maupas as the result of his classical experiments. According to this view the life history is a cyclical one, the near descendants of the exconjugate being in a state of immaturity, which gradually yields, as asexual multiplication proceeds, to puberty,

ending in senility and to the necessary death, through internal causes, of the asexual colony. As better and better methods of cultivation have been evolved the duration of this "cycle" has been gradually lengthened, and artificial stimuli substituted for the "rejuvenescing" conjugation, till at last we have Woodruffe, after breeding *Paramecium aurelia* for 3340 asexual generations without evoking any signs of "degeneration," coming to the conclusion "dass das Protoplasma einer einzigen Zelle unter günstigen äusseren Umständen ohne Hilfe von Konjugation oder einer künstlicher Reizung in stande ist, sich unbegrenzt fortzupflanzen und zeigt ferner in klarer Weise, dass das Altern und das Befruchtungsbedürfnis nicht Grundeigenschaften der lebendigen Substanz sind" (p. 36).

Similar conclusions have been reached by Jennings as the result of extensive experiments on individuals of *Paramecium* which had conjugated, and others which had been prevented from conjugating though ready to do so.

Conclusion.

The following conclusions, though referring particularly to *S. vetulus*, may probably be safely extended to a wide range of the Cladocera.

1. Certain not yet fully elucidated factors in the environment influence the onset of sexuality.

2. Certain factors likewise bring about "degeneration" or high rate of mortality.

3. Certain factors of the environment may act cumulatively over a number of generations.

4. Therefore the increasing sexuality and "degeneration" (or high mortality) observed under certain supposedly constant experimental conditions receive a ready explanation in the supposition that the environment is one favourable to the development of these phenomena.

5. This explanation is made much more probable when we find that under other experimental conditions there is no tendency to increasing sexuality or degeneration.

6. Many species exhibit the phenomenon of specially labile periods, when sexuality is easily influenced by certain factors of the environment. This labile condition is usually ascribed to the fact that the line is in about the middle of the reproductive cycle, the diminishing tendency to parthenogenesis being about equally balanced by the increasing tendency to sexual reproduction. Such a balanced condition must however be passed through equally whether the tendency to sexuality

is being increased by the progress of the "cycle" or by the cumulative effect of an unfavourable environment. Hence the existence of labile periods is as readily explained on the one hypothesis as on the other.

7. There is no justification for retaining the hypothesis of an inherent reproductive cycle—that is to say, the hypothesis that the number of generations or lapse of time since the last fertilised egg influences, as such, the production of sexual or degenerate forms. For the production of these forms is under certain conditions not influenced even by the lapse of an enormous number of parthenogenetic generations, while their production certainly is influenced by environment in other cases. The residuum of cases being equally well explicable on either hypothesis (cycle or environment) it is most reasonable to suppose that the factor that was effective in the one case (environment) was the one that was effective in the other, and conversely, that the ineffective factor of the one case ("reproductive cycle") was ineffective in the other.

LITERATURE CITED.

- AGAR, W. E. "Transmission of Environmental Effects from Parent to Offspring in *Simocephalus vetulus*." *Phil. Trans. Roy. Soc. London*, Series B. 203, 1913.
- GROSVENOR, G. H., and GEOFFREY SMITH. "The Life-cycle of *Moina rectoris*." *Quart. Journ. Micr. Sci.* Vol. LVIII. 1913.
- HALBAN, JOSEF. "Die Grossenzunahme der Eier und Neugeborenen mit dem fortschreitenden Alter der Mutter." *Archiv für Entwicklungsmech.* Vol. XXIX. 1909.
- HERTWIG, R. "Über den derzeitigen Stand des Sexualitätsproblems nebst eigenen Untersuchungen." *Biol. Centralbl.* Vol. XXXII. 1912.
- ISSAKOWITSCH, A. "Es besteht eine zyklische Fortpflanzung bei den Cladoceren, aber nicht im Sinne Weismann's." *Biolog. Centralbl.* Vol. XXVIII. 1908.
- JENNINGS, H. S. "The Effect of Conjugation in *Paramecium*." *Journ. Exp. Zool.* Vol. XIV. 1913.
- KUTTNER, O. "Untersuchungen über Fortpflanzungsverhältnisse und Vererbung bei Cladoceren." *Internat. Revue der gesamt. Hydrobiol. u. Hydrographie*, Vol. II. 1909.
- PAPANICOLAU, G. "Experimentelle Untersuchungen über die Fortpflanzungsverhältnisse bei Daphniden." *Biol. Centralbl.* Vol. XXX. 1910.
- WEISMANN, A. "Beiträge zur Naturgeschichte der Daphnoiden." *Zeitschr. für wiss. Zoolog.* Vol. XXXIII. 1879.
- WOLTERECK, R. "Veränderung der Sexualität bei Daphniden." *Internat. Rev. der gesamt. Hydrobiol. u. Hydrographie*, Vol. IV. 1911.
- WOODRUFFE, L. L. "Dreitausend und dreihundert Generationen von *Paramecium* ohne Konjugation oder künstliche Reizung." *Biolog. Centralbl.* Vol. XXXIII. 1913.

ON THE APPEARANCE OF STERILE "DWARFS"
IN *HUMULUS LUPULUS* L.

By E. S. SALMON, F.L.S.,
S.E. Agric. College, Wye, Kent.

IN a large number of "crosses" which I have made during the past seven years between different cultivated female varieties of hops and various individual male hops¹, some of the resulting seedlings are remarkably distinct in character from either parent. The distinguishing features of these seedlings are (1) their total, or almost total, inability to climb; and (2) their complete sterility, no flowers being produced.

With reference to the first character, we find that in these abnormal seedlings the strong relatively thick climbing stems ("bines") which in the normal male or female hop-plant arise annually from the perennial rootstock are replaced by a number (often a very large number) of weak, thin, sometimes almost thread-like stems, of limited growth, which are either totally unable to climb, or climb weakly a short distance. In many of these abnormal seedlings—which may conveniently be termed "dwarfs"—all the shoots either grow prostrate on the surface of the ground or form an erect bush-like growth about 1 foot high; in other cases the longest shoots if provided with a piece

¹ Prof. J. Percival (*Agric. Botany* (1902), p. 335) writes: "...the male [hop] is always practically a wild form, for on account of their being of no use to the grower, males have never been subject to special selection and improvement. It is somewhat curious that although female seedlings show considerable variation, we have never seen any morphological differences among males, no matter what their origin, except in one or two solitary instances where the 'bines' were a paler colour than usual." This statement is somewhat misleading, since we find in the forms, or varieties, of the male hop quite as much variation in such characters as the colour of the stem and petioles, length of the lateral branches, and in other vegetative characters as in the female hop-plant.

of cocoa-nut string (such as is used in hop-gardens for "training" hops) and "trained" round it from time to time through the summer, will climb in rather a feeble manner and reach a height of 3 to 5 feet. No better climbing habit is shown if the shoots are allowed to grow up finely-branched pea-sticks. In the majority of cases a "dwarf" produces a large number of thin shoots, which radiating from the rhizome run prostrate on the ground and produce a "mat"-like growth covering a square yard or more (see Pl. VIII, fig. 1); in rarer cases a few of the shoots if carefully "trained" raise themselves by climbing round each other and the cocoa-nut string, either to a height of 5 feet, as shown in Pl. VIII, fig. 2, or more usually to a height not exceeding 2 feet (Pl. IX, fig. 3). The leaves on the "dwarf" are much smaller than those on the normal hop-plant, and are less divided, being often unlobed, and never more than 3-lobed; the diameter of the stem at its base does not exceed $\frac{1}{5}$ in., and is often less than $\frac{1}{10}$ in., whereas in the normal plant it is from $\frac{3}{8}$ in. to $\frac{1}{2}$ in. The stem of the "dwarf" possesses the hooked hairs found in the normal plant. So far as has been observed, the root-system of the "dwarfs" is characterised by none of the roots running horizontally; further, no underground stems growing horizontally ("runners") have been seen in the dwarfs.

The distinctive characteristics of the "dwarf" are usually evident soon after germination. A normal seedling produces in a few weeks a stem with a strongly developed climbing habit, which, in the case of a vigorous plant, will reach at the end of the first year's growth, to a height of 5, or even 6, feet. In cases where "dwarfness" is most marked, the seedling plant produces in its first year one or more shoots of very limited growth, which never climb and which bear abnormally small and often curled leaves; at the end of the season's growth the whole plant may be only 1 inch high. In other cases, where the "dwarfness" is not so extreme, a number of shoots are produced, which may reach to a length of 6 to 9 inches; none of the stems, however, are able to climb. In the second year from germination, the normal seedling, whether male or female, produces a fairly stout stem, which climbs to 10 feet or more, and produces flowers. A normal seedling developing the fresh shoots in the spring of its second year is shown in Pl. IX, fig. 4. In the case of "dwarfs," the one-year-plant if vigorous produces the next spring a number of shoots, with thin sometimes almost thread-like stems, which never climb, but run prostrate over the ground and attain a length of 2 to 3 feet. No flowers are ever produced (as noted below). Pl. IX, fig. 5 shows a one-year-old "dwarf" seedling, starting the season's

growth. In the cases where the "dwarfness" is most pronounced¹, the plant remains for the second year and longer extremely stunted, producing a number of shoots only a few inches high with very small and often curled or distorted leaves. Pl. IX, fig. 6 shows such a dwarf, at the end of the second year's growth. Such plants apparently—where no special care is given to their cultivation—die after a few years. The larger "dwarfs," however, may show a vigorous growth in the third and succeeding years, and may produce a very large number of trailing stems (frequently over fifty) which radiate in all directions to a distance of 3 or 4 feet. The most vigorous "dwarfs," however, some of which are now 7 years old, have never produced a single normal climbing stem, nor reached a height (or length) of more than 5 feet,—whereas the stems of all the other normal seedlings of the same "crosses" can climb to 20 feet or so.

"Dwarfs," like the normal plants, are liable to be attacked, and much injured by "mould" (*Sphaerotheca Humuli*) and "green fly" (*Phorodon Humuli*), and to be killed by "eelworm" (*Heterodera schachtii*).

The second characteristic of "dwarfs" is their absolute sterility, no flowers or rudiments of sexual organs having been produced in any case. Over 200 "dwarfs," arising from various "crosses," have been kept under observation. "Dwarfs" have occurred among the normal seedlings in the majority of the "crosses" I have made; e.g. in 25 "crosses" in which the following female (English) varieties of hop were used;—Cobb's Golding, Colgate, Fuggles, Early Bird, Early White, Canterbury Whitebine. The male hops used were different individuals of the English forms of the male hop, and in one case a male hop obtained from Oregon, U.S.A., which differs in leaf- and other characters, from the English forms.

As some of the "dwarfs" are now 7 years old, and as the normal seedling produces flowers in the second year after germination, it appears safe to conclude that the present kind of dwarfness, unlike that recorded in *Humulus japonicus* by Figdor², is associated with absolute sterility.

With regard to the proportion of dwarfs that may occur in the F_1 generation, the following facts are available.

¹ "Dwarfness" is most pronounced in those "crosses" in which the male hop is a form from Oregon, U.S.A., and the female a variety cultivated in England.

² W. Figdor, Uebergangsbildungen von Pollen- zu Fruchtblättern bei *Humulus japonicus* Sieb. et Zucc. und deren Ursachen, in *Sitzungsber. d. kaiserl. Akad. d. Wissensch. Wien*, Bd. cxx. Abt. 1 (1911).

In a "cross" (Ref. no. 5/07) made in 1907 the female hop was the variety known as Fuggles¹, and the male hop (Ref. no. M8) one of the English forms with a red-bine. 51 hops containing 256 seeds were obtained from the pollinated flowers; while the 44 "control" hops contained no seeds². 87 seedlings were raised, of which 52 proved to be climbers and fertile³, and 35 proved to be "dwarfs" and sterile. Prof. Bateson has pointed out to me that here the ratio of "dwarfs" to "climbers" approximates to 7:9.

In a second cross (Ref. no. 4/07) made at the same time, between the same female variety (Fuggles)—though different individuals⁴ were used from those in the first cross—and a certain male hop (Ref. no. G 27), one of the English forms with a green-bine, 99 hops containing 285 seeds were obtained from the pollinated flowers, and 28 hops, all without seeds, from the "control" branches. 67 seedlings were raised, of which 66 plants proved to be climbers and fertile⁵, and 1 plant a dwarf and sterile. If we assume that this single dwarf was due to the fertilisation of a flower by a strange pollen-grain during the time the bag was removed⁶, and if we also assume that the female plant in these two "crosses" was identical in character⁴, then it appears that the latent characters of dwarfness and sterility are carried by some English forms of the male hop and not by others. However this may be, it is quite certain that the proportion of "dwarfs" to climbers (if dwarfs really occurred at all) in this second "cross" was altogether different from that obtaining in the first "cross."

In a third "cross" (Ref. no. 1/09) made in 1909, the female hop was the German variety "Stirn" and the male hop one of the English forms with a bine striped with red and green (Ref. no. Z 12). The pollinated

¹ Prof. Percival (*Journ. Royal Agric. Soc. England*, LXII. p. 87 (1901)), writing of the origin of this variety, says, "The original plant was a casual seedling which appeared in the flower-garden of Mr George Stace, of Horsmonden, Kent. The seed from which the plant arose was shaken out along with crumbs from the hop-picking dinner-basket used by Mrs Stace, the seedling being noticed about the year 1861. The 'sets' were afterwards introduced to the public by Mr Richard Fuggle of Brenchley, about the year 1875."

² The controls, it should be noted, were imperfect in that the bags covering them were not removed at the time when this was done to the branches that were pollinated.

³ 31 were ♀, 4 were ♂, and 17 were killed by eelworm before they flowered.

⁴ The commercial cultivation of the hop being entirely vegetative, by means of sets or cuts—the thickened basal portion of the stem—it might be assumed that all individuals of any variety are identical; it is very probable, however, that the stocks of some varieties have not been kept true.

⁵ 57 were ♀, 7 were ♂, 1 was monoecious, and 1 was killed by eelworm before it flowered.

⁶ See footnote 2 above.

flowers gave 15 hops with 261 seeds, and the "control" branches 58 hops with no seeds. 120 normal seedlings were raised, all climbers and fertile¹,—no "dwarf" appearing among them.

In a fourth cross (Ref. no. 14/09) the English female variety Canterbury Whitebine was pollinated from a male hop obtained from Oregon, U.S.A., which possesses vegetative characters distinct from all the English forms of *H. Lupulus*. 110 hops, containing 899 seeds, were obtained from the pollinated flowers, and 85 hops, containing 2 seeds, from the "control" branches. 109 seedlings were raised, of which 79 were climbers and fertile, and 30 "dwarfs" and sterile. In this "cross," however, many of the "dwarfs" were extremely stunted, and were weakly from the first, and died in the first or second year after germination before a count was made. It is certain, therefore, that the proportion of "dwarfs" to climbers in this "cross" is considerably higher than 30 to 79, which are the numbers of plants surviving in the fourth year after germination.

The only apparent reference to "dwarfness" in *H. Lupulus* which I have been able to find is in a Bulletin² by Dr W. W. Stockberger and J. Thompson, where a bare mention is made of the occurrence of "hills with dwarfed vines" in a Californian hop-field.

Figdor (*l.c.*) has recorded the occurrence among seedlings of the annual species *Humulus japonicus* of some individuals which showed a dwarfed habit. *H. japonicus* usually attains a height from the ground of 1.5 to 2 m.; the tallest of the "dwarf" seedlings measured only 0.41 m. and the shortest 0.11 m.

Upon such dwarf plants which seemed to be otherwise males were developed flowers hermaphrodite in various degrees (for details see original paper), and in a few cases female flowers also were formed. Figdor sought to explain the production of these dwarfs as follows: "Der Nanismus der einzelnen Individuen wird durch die gleichzeitige Einwirkung einer bestimmten chemischen Lichtintensität bei verhältnismässig niedriger Temperatur und ebensolchem Feuchtigkeitsgehalte der Atmosphäre in Verbindung mit Nahrungsmangel hervorgerufen."

The "dwarfs" of *H. Lupulus* described above differ in being absolutely sterile, and whatever may be the true explanation of the appearance of "dwarfs" in *H. japonicus*, it is certain that "dwarfness" in *H. Lupulus* cannot be attributed to the influence of outside factors,

¹ 108 were ♀, 11 were ♂, and 1 was monoecious.

² *Some Conditions influencing the Yield of Hops* (U.S. Department of Agriculture, Bureau of Plant Industry, Circular No. 56 (1910)).

since the "dwarfs" were treated as regards cultivation etc. from the time of germination onwards in exactly the same way as the seedlings which developed into normal plants.

EXPLANATION OF PLATES.

PLATE VIII.

- Fig. 1. Photograph taken in the Experimental Hop-garden at Wye College, Kent, showing the climbing bines of normal seedlings of *H. Lupulus*, and, to the right, two "dwarf" seedlings which have produced a large number of very thin stems all totally unable to climb. These "dwarfs" are 7 years old.
- Fig. 2. Photograph as in Fig. 1; in the background can be seen the climbing bines of normal seedlings, in the foreground a "dwarf" seedling, the most vigorous shoots of which have climbed to a height of 5 feet. The leaves are cordate and simple, and may be compared with those of the normal climbing plants shown in Fig. 1.

PLATE IX.

- Fig. 3. Photograph of a "dwarf" seedling; the most vigorous shoots have climbed 2 feet. The leaves are simple and cordate, and the stems thread-like. This "dwarf" is 7 years old.
- Fig. 4. A normal one-year-old seedling, starting the season's growth.
- Fig. 5. A "dwarf" one-year-old seedling, starting the season's growth.
- Fig. 6. A "dwarf" seedling at the end of its second year's growth. Natural size. (This was one of many similar seedlings obtained in the "cross" Canterbury White-bine \times male hop from Oregon, U.S.A.)

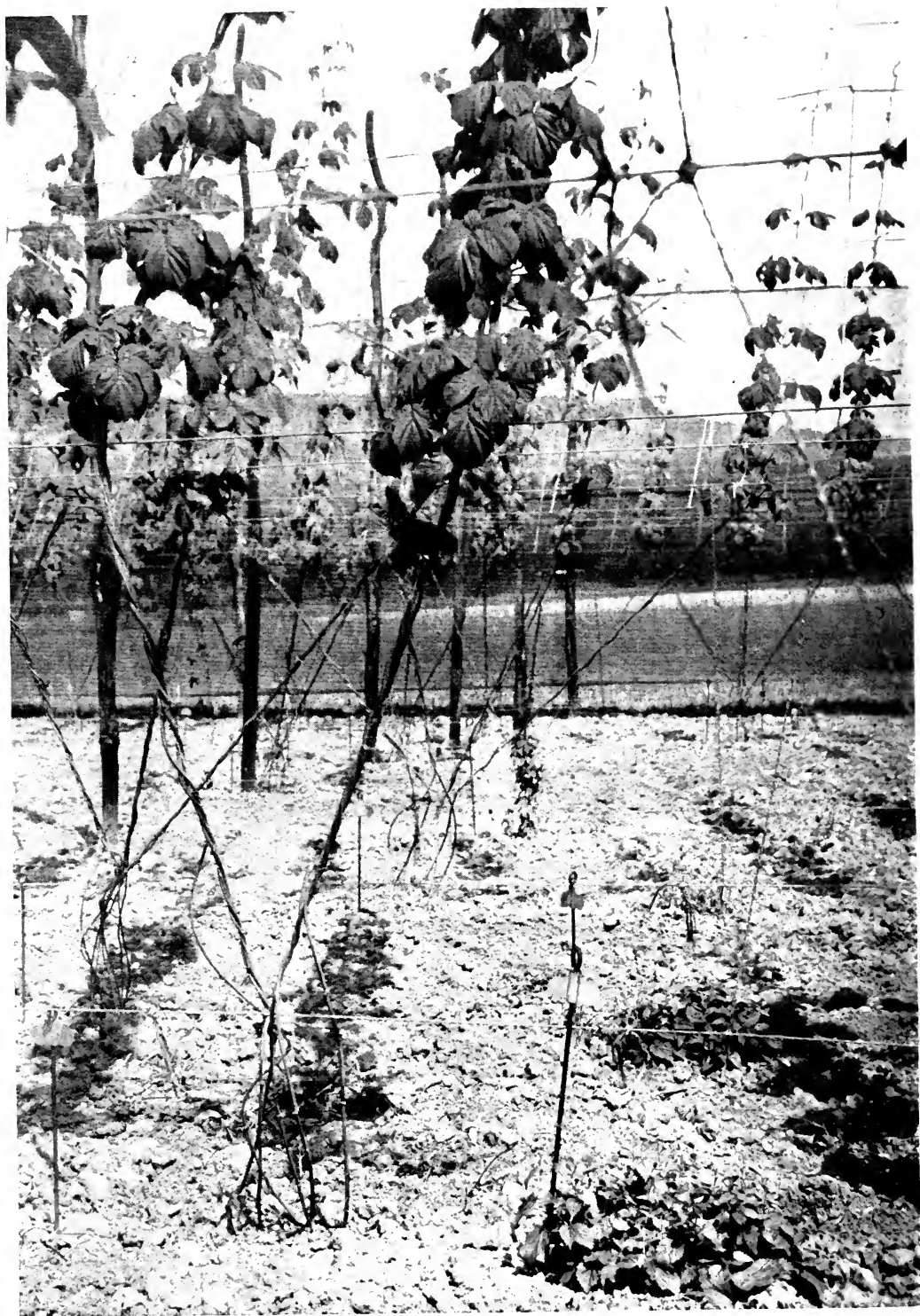

Fig. 1.



Fig. 2.

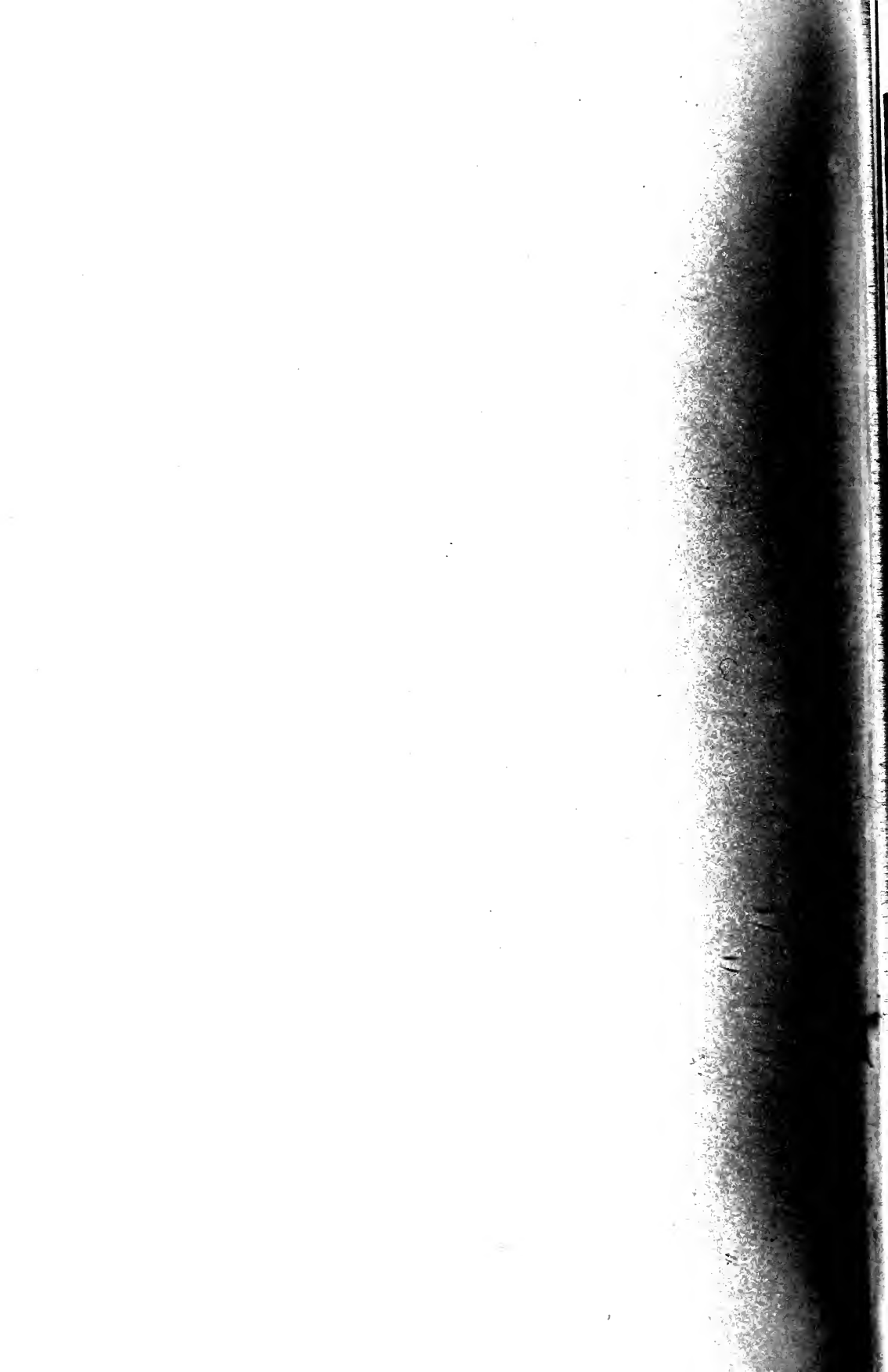



Fig. 3.



Fig. 4.



Fig. 5.



Fig. 6.

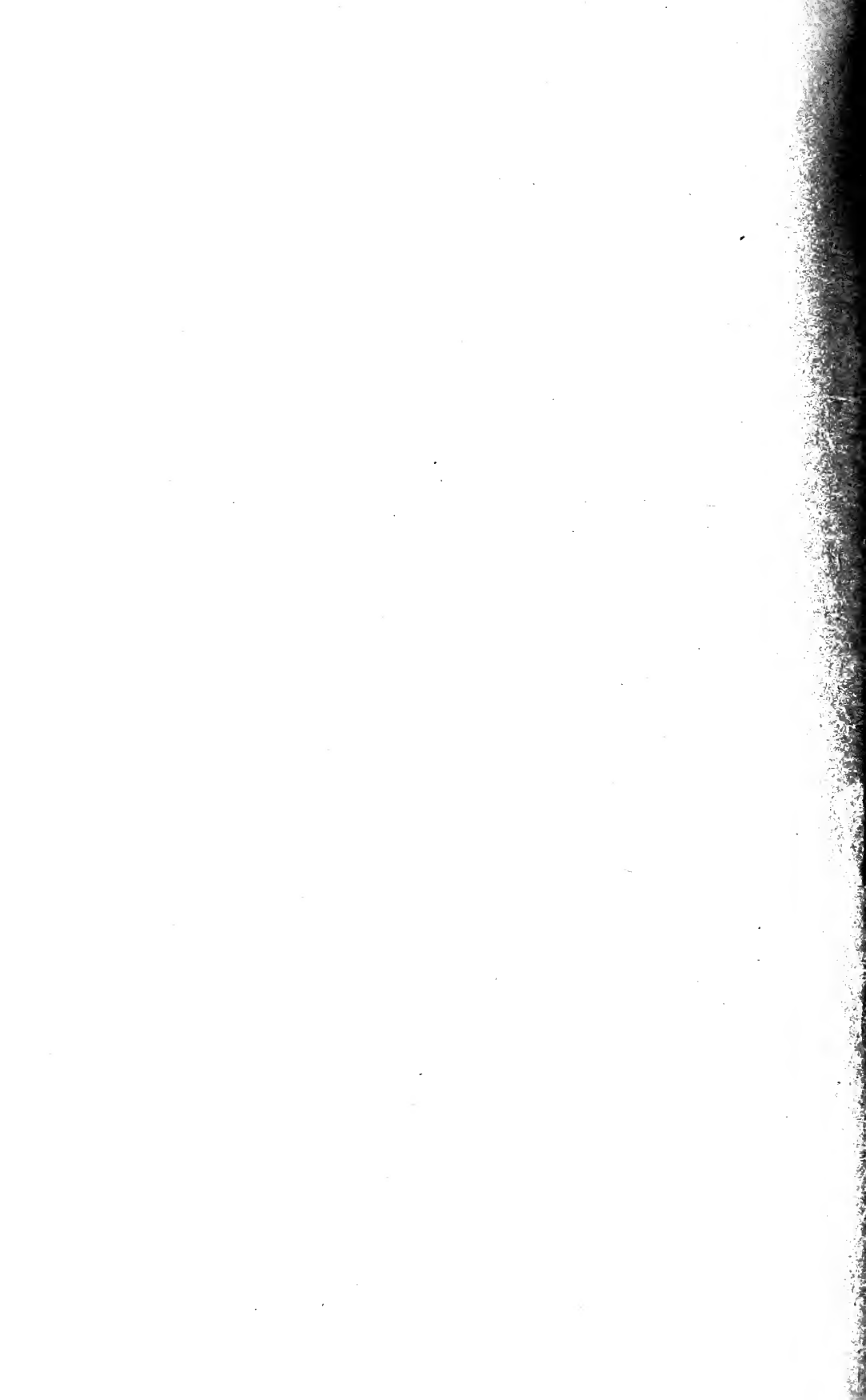

NOTE ON THE OFFSPRING OF A DWARF BEARING STRAIN OF GUINEA PIGS.

BY I. B. J. SOLLAS,
Newnham College, Cambridge.

THE breeding experiments on a dwarf bearing strain of Guinea pigs described in the *Reports to the Evolution Committee of the Royal Society* (Sollas 1909) have been continued. The results up to the present are shown in the following tables:

(1) *Complete list of all the dwarf-containing families¹.*

	Parents		Offspring				
	Female	Male	Normal Female	Normal Male	Dwarf Female	Dwarf Male	Normal, sexes unrecorded
(1)	286	287	2	3	—	1	—
(2)	400	401	5	14	—	9	18
(3)	409	401	2	—	—	1	—
(4)	413	416	—	4	—	3	—
(5)	415	416	4	8	—	4	—
(6)	495	497	10	8	2	6	—
(7)	571	416	—	2	—	—	—
(8)	571	401	3	2	—	2	—
(9)	571	312	7	5	1	3	—
(10)	571	497	1	5	—	—	—
(11)	571	741	4	4	—	—	—
(12)	572	369	1	—	—	1	—
(13)	572	416	10	11	3	3	—
(14)	572	497	4	3	1	2	—
(15)	586	416	—	2	1	—	4
(16)	586	550	3	3	2	—	—
(17)	644	312	1	2	1	—	—
(18)	644	416	1	—	—	—	—
(19)	644	741	6	2	3	1	—
(20)	718	Y	3	1	—	1	—
(21)	718	550	1	1	1	—	—
(22)	718	497	1	1	—	1	—
(23)	718	312	1	4	2	—	—
(24)	718	741	2	3	1	2	—
(25)	X	X	—	—	2	—	—
(26)	735	416	2	—	—	—	—
(27)	735	497	1	1	—	—	—
(28)	735	741	5	1	4	—	—
Totals	80	90	24	40	22

Normal 192; Dwarf 64. Females 104; Males 130.

¹ Errors in the previous table have been corrected.

202 *Offspring of a Dwarf Bearing Strain of Guinea Pigs*

The proportion of normal offspring to dwarfs is 3:1. That the numbers in the total are in exactly this proportion is of course merely a coincidence.

The preponderance of male dwarfs and of the total number of males is very considerably diminished since the last report.

If we consider separately the offspring in families in which the dwarfs were all male, in those in which the dwarfs were all female and in those in which the dwarfs were of both sexes, we find that the excess of males is confined to the first set of families, i.e. those in which the dwarfs were all male. In this total the males are more than three times as numerous as the females. In the earlier experiments most of the families were of this kind; the diminution in the excess of males

(2) *Families containing dwarfs of both sexes.*

	Parents		Offspring			
	Female	Male	Normal		Dwarf	
			Female	Male	Female	Male
6)	495	497	10	8	2	6
(9)	571	312	7	5	1	3
(13)	572	416	10	11	3	3
(14)	572	497	4	3	1	2
(19)	644	741	6	2	3	1
(24)	718	741	2	3	1	2
Totals	...		39 ♀	32 ♂	11 ♀	17 ♂

Total 50 ♀ : 49 ♂.

(3) *Families containing besides normal offspring male dwarfs only.*

	Parents		Offspring		
	Female	Male	Normal		Dwarf
			Female	Male	Male
(1)	286	287	2	3	1
(2)	400	401	5	14	9
(3)	409	401	2	1	1
(4)	413	416	—	4	3
(5)	415	416	4	8	4
(8)	571	401	3	2	2
(22)	718	497	1	1	1
Totals	...		17 ♀	33 ♂	21 ♂

Total 54 ♂ : 17 ♀, a fairly close approximation to a 3 : 1 ratio.

is due to the fact that our present total is made up largely of the offspring of families of the other two kinds.

In families in which dwarfs of both sexes have already occurred the numbers of the sexes are equal. In families in which up to the present no male dwarfs have been born there is an excess of females.

In making out the tables of families containing dwarfs of both sexes we are clearly safe in including all families; but in both the other cases we cannot be certain that any of the families, if they had increased, would have remained in the class in which we have placed them. Nevertheless the facts may have some interest.

Thus in the families containing dwarfs of the male sex only, the proportion of the male to the female offspring approximates to 3:1. It is possible that the 18 normal offspring of unrecorded sex in family 2 (see Table 1) would have altered this proportion: but even if we make the unlikely supposition that they were all female we should still have a large excess of males. In family 22 each parent has, when paired with other mates, produced female dwarfs; of the other parents 416 and 571 have produced female dwarfs when paired with other mates. Possibly further breeding would show that some of the families in this table are out of place.

(4) *Families containing female dwarfs only.*

	Parents		Offspring			Normal, of unrecorded sex
			Normal		Dwarf	
	Female	Male	Female	Male	Female	
(15)	586	416	—	2	1	4
(16)	586	550	3	3	2	—
(17)	644	312	1	2	1	—
(21)	718	550	1	1	1	—
(23)	718	312	1	4	2	—
(25)	X	X	—	—	2	—
(28)	735	741	5	1	4	—
	Totals	...	11 ♀	13 ♂	13 ♀	4

In this table, the female parents in the matings 15, 16, and 28 have never yet given birth to any male dwarfs, the males with which they were mated have had male dwarfs among their offspring. The parents in the matings 17, 21, and 23 have all, when paired with other mates, had male dwarfs among their offspring.

Sturtevant (*J. Exp. Zool.* 12, 1912, p. 513) has published an interesting attempt to explain these results, as far as they went in

204 *Offspring of a Dwarf Bearing Strain of Guinea Pigs*

the previous report, as a case of partial sex linkage. His explanation accounts for the occurrence of some families containing besides normal offspring male dwarfs only, others containing besides normal offspring both male and female dwarfs. According to his scheme there would be no complete families containing none but female dwarfs. So far there may be nothing to conflict with the facts, but as far as I can see, in both his families the numbers of the sexes would be equal, though he does not seem to recognise this difficulty himself (see p. 515).

The experiments will be continued by Miss N. M. and Mr J. B. S. Haldane.

ON A CASE OF UNILATERAL DEVELOPMENT
OF SECONDARY MALE CHARACTERS IN A
PHEASANT, WITH REMARKS ON THE IN-
FLUENCE OF HORMONES IN THE PRODUC-
TION OF SECONDARY SEX CHARACTERS.

By C. J. BOND, F.R.C.S., Leicester.

DESCRIPTION.

THE skin now described is that of the white ringed Formosan variety (*Phasianus Torquatus*) of the Chinese pheasant.

On the left side (cf. Pl. X, figs. 1—4), it shows the plumage and spur of the male bird. The red portion of skin round the eye is much larger on the left than on the right side. The head and neck feathers are blue green, iridescent on both sides but more so on the left. There is a semilunar patch of the white collar feathers strictly limited to the left side of the neck. The wing primaries and coverts are of the female type though a few male plumage feathers appear in the left wing coverts. The tail coverts show marked male characters, more especially on the left side. The breast feathers, which are rufous in colour, especially on the left side exhibit the black tipping seen in the male bird. The left leg shows a well developed spur, pointed, and of the size found in the cock of the second year (cf. Pl. XI, fig. 5). On the right leg there is no spur but only the usual rudiment or scaur found in the hen pheasant (Pl. XI, fig. 6).

The bones of the left tarsus and phalanges are longer and thicker than the corresponding bones in the right leg.

The tail feathers (rectrices) are especially interesting. While the assumption of male plumage is more or less confined to the left side in the head and neck and trunk and limbs, it is not so limited in the

case of the tail feathers. In the tail (as far as can be ascertained owing to the unfortunate absence of the two central feathers) it is the outer half of each feather that has assumed the male type of plumage (Pl. XII, fig. 7). In other words instead of the tail as a whole showing a division into a male half and a female half, each feather of the tail shows male colouring and pattern on the outer or less covered half, and female colouring and pattern on the inner or more covered half.

EXAMINATION OF THE INTERNAL ORGANS.

Careful dissection shows the presence of a well developed oviduct opening into the cloaca in the usual situation on the left side.

In the situation of the ovary (though somewhat nearer to the middle line) a sex gland was found roughly $\frac{3}{4}$ inch long by $\frac{1}{2}$ inch wide, nodular on the surface and in parts deeply pigmented (Pl. XIII, fig. 10). No trace of a sex gland could be found on the right side. Microscopical examination of this gland shows actively growing areas of tubular gland structure in some of which bodies like spermatozoa can be detected; the acini are lined by columnar epithelium (Pl. XIII, fig. 12). Smaller areas of fibrous tissue with much pigment and degenerating cysts are found in another part while a third portion resembles in structure the cortical part of the suprarenal gland. This sex gland is in fact an ovo-testis, and from the degenerating pigmented condition of the ovarian portion (Pl. XIII, fig. 11), and the actively growing character of the testicular portion, it seems probable that it functioned originally as a female gland, and that the ovarian portion subsequently atrophied while the tubular gland or male portion then became functionally active.

Remarks. The assumption of male secondary characters on one side of the body only in this case presents considerable difficulty when we attempt to apply the usual hormonal explanation to the development of these characters. And yet the facts already established compel us to accept the hormonal explanation as a partial although not a complete solution of the problem.

The older experiments on the results of castration in the male animal and the more recent observations of Marshall, Shattock, and others on birds and animals conclusively show that with the removal of all traces of the sex gland in the male the secondary male characters fail to appear if they have not already begun to grow, or undergo a

sharp and permanent arrest of growth if they have already begun to develop before the castration was performed.

Such are the facts, as experimentally determined, but the nature of the association, and the way in which the removal of the sex gland influences the growth of the tissues, are not fully known.

Recent observations suggest that it is not merely the absence of one sex gland that brings about the development of the opposite secondary sex characters, but that there must also be the starting into functional activity of some hitherto dormant elements in the degenerating gland or in some other situation in order to bring about the evolution of the corresponding sex characters.

In other words, as Shattock has suggested, the presence of male sex gland elements is necessary for the development of secondary male characteristics in every individual whether the female sex gland be present or not. The essential point is the presence of a stimulating factor rather than the absence of an inhibiting factor. There are some facts which support this view thus:

(a) In an increasing number of cases in birds in which atrophy of the ovary has been found in association with the development of secondary male characters, careful microscopical examination of the degenerating female gland reveals the presence of islands of male elements showing active growth.

Pl. XIII, fig. 13 shows such male gland elements in the degenerating ovary of a hen pheasant in which male plumage and well developed spurs were both present.

(b) It is known that the gradual destruction of the normal tissue of both ovaries by a new growth in young women is more often associated with the growth of hair on the face, alteration in the voice, and the appearance of other secondary male characters than is even complete bilateral oophorectomy, the explanation being that the gradual destruction of the Graaffian follicles and interstitial cells by disease acts like parasitic castration and affords an opportunity for the growth and functional development of dormant rudiments of male gland cells present in the degenerating ovary, while in complete bilateral oophorectomy these male elements are removed along with the female gland and all possibility of their subsequent growth is thereby prevented. The same seems to be true of birds also. Mr Cooper of Knaresborough has kindly sent me the photo of a Blue Leghorn Pullet which developed a well marked comb and other male characters (but no spurs); in this case the ovary was destroyed by a large new growth.

(c) Although the complete removal of the sex glands at an early age in the male does no doubt prevent the development of secondary male characters in most vertebrates, it does not produce the development of female secondary characters except in so far as these resemble those of the young or immature male.

In the few recorded cases (chiefly among birds) where males have taken on female plumage, either completely or in part, the change has accompanied some (at present unknown) natural cause independently of castration and unassociated in most cases with any atrophic change in the testes (Hammond Smith, *The Field*, Feb. 25, 1911). It is possible therefore that the assumption of female plumage may be associated with the growth of some dormant ovarian elements in some abnormal situation. In any case the more frequent occurrence of the change in the female is of interest when we recall the supposed heterozygous constitution of the female in respect of sex.

Influenced by these facts Geoffrey Smith and Mrs Haig Thomas (*Journ. Genetics*, June 1913) suggest a different causation for the secondary sex characters in each case. They suggest that the case of the female assuming the characters of the male sex is one of "Correlated Differentiation" and is directly associated with changes in the corresponding sex gland, while the case of the male assuming female characters is due to the "Hereditary Transference" of characters originally associated with one sex to individuals of the opposite sex, and they instance the hen plumage of the Sebright Bantam Cock as a case in point.

But even supposing it to be true, as seems likely, that the case of the female assuming male characters and the case of the male assuming female characters rest on a different footing as regards causation, this specimen still falls into a different category because the assumption of the opposite sex character is limited to one side of the body in this individual. While it seems clear that such a localized change of plumage cannot be entirely dependent on the circulation in the blood of any internal secretion it is also clear that the explanation of opposite sex characters by Hereditary Transference is also insufficient, because in this individual bird the sex characters are different on the two sides of the body. Moreover, not only are the somatic characters different on the two sides but the sex gland is also a dual gland composed of male and female elements. The bird is in fact a true *genetic* as well as a *somatic* Hermaphrodite. It should I think be placed in a separate class along with those described by

Brandt (*Zeitschrift für wiss. Zool.*, Vol. XLVIII, 1889, page 101). Weber quoted by Biedl mentions the case of a bird (a chaffinch) with right sided male and left sided female plumage in which a testis was found on the right side and an ovary on the left side of the body. Virchow (also quoted by Biedl) records the case of a human pseudo-hermaphrodite, in whom a left sided anomaly of the sex gland was associated with imperfect growth and development on the left side of the body. There is in the Royal College of Surgeons Museum a butterfly (one of the Blues) with male wing pattern on one side and female on the other, but I am not aware that any microscopical examination of the gonads has been made in this case.

Heinrich Poll ("Zur Lehre von den Sekundären Sexual Characteren," *Stzgsber. Ges. Naturf. Freunde zu Berlin*, 1909), refers to three cases of true hermaphroditism associated with a hemilateral distribution of secondary sex characters in birds. He gives a full and careful description of a bullfinch in which the plumage of the breast was male in character on the right side and female on the left, and this hemilateral distribution of secondary sex characters was associated with a double sex organ, testicular or male on the right side and ovarian or female on the left side of the body. Poll directs attention to the suggestive fact that in true hermaphrodite birds with hemilateral secondary sex characters the male character occurs on the right side of the body, the side on which the sex gland is also male. He suggests that the presence of the testis on the right side may be associated with the atrophy of the right sex gland which normally occurs in birds.

In the case of the Pheasant here described however, the male characters are present on the left side of the body, while the male and female elements are gathered together in one single sex gland which lies on the left side but nearer to the middle line than usual.

Among the Invertebrata, especially the Lepidoptera, abnormal examples of hermaphroditism occur somewhat frequently. In such cases the association between the relative position of the internal sex gland and the distribution of the secondary sex characters is not however apparently so close as in birds.

Thus while true Hermaphrodites do rarely occur in which male secondary characters are present with a male sex gland on one side of the body, and female secondary characters with a female sex gland on the opposite side, there are still reasons for thinking that the localization of sex gland and sex character in different halves of the body both have a common genetic cause, and are not causally related the one to the other.

If this be true of these Hermaphrodites it is also probably true of normal individuals, all of whom are Hermaphrodites in some degree. In other words in addition to the sex gland with its Hormonic secretion, we must also recognise a somatic or peripheral factor in the causation of secondary sex characters. No amount of Hormone will bring about the development of secondary male characters in individuals, and in tissues, in which the rudiments of such characters are absent. On the other hand sex gland and somatic rudiments being given in heredity, the due development, and the continued growth of the sex character, depend on the presence of the sex gland and on the integrity of its internal secretion.

Without the help of some such somatic, or tissue factor, it is very difficult to explain these unilateral cases by any Hormonic theory even if we invoke the aid of the nervous system.

There are some further facts which support this view. Thus, as Shattock has pointed out, all secondary sex characters are not equally dependent for their growth and development on the internal secretions of the corresponding sex glands. See the case of the male Leghorn chick in the Royal College of Surgeons Museum in which the precocious development of the testes was associated with a fully formed male comb, but in which this testicular activity failed to bring about the growth of spurs, or sickle tail feathers, another male character. Comb and spurs and sickle tail feathers stand on a different footing then in this respect, and it is also known that hens occasionally develop spurs while continuing to lay fertile eggs. The somatic tissues which contain the rudiments of the secondary sex characters differ in their susceptibility to the influence of the corresponding sex gland Hormone, and it is quite conceivable that in these hemilateral cases tissues which are genetically homozygous in respect of the male or female character, tissues which have as it were received a double dose of femaleness or maleness, are more susceptible to the influence of their corresponding Hormone than tissues which are heterozygous (or singly dosed) in respect of such sex qualities.

EXAMINATION OF THE TAIL FEATHERS.

The peculiar arrangement of the pigment pattern in the individual tail feathers of this bird is of interest in this connection. From a cursory examination of some skins in the Natural History Museum S. Kensington, I am inclined to think that hemilaterality of male plumage pattern in individual tail feathers goes with hemilaterality of

secondary sex characters in the body as a whole, and there can I think be little doubt that this depends on some important law of ontological development in birds. In the head and neck, trunk and limbs, the development of the pigmentary pattern and feather structure seems to be under the control of separate unilaterally acting factors, whereas in the tail (at any rate in some birds) one single factor controls the development of the tail as a whole, and this single factor may differentiate later into secondary factors which control the development of each half of each tail feather, as in this case.

There are some interesting facts in neural physiology which bear on this point. Langley and others have shown that unilateral stimulation of the central nervous system produces unilateral action in the sympathetic pilo-motor fibres which supply the trunk and limbs, whereas in the tail the effect of the unilateral stimulation passes over the middle line and affects the tail as a whole in the cat.

Rörig of Frankfort has recorded cases in which unilateral castration in the stag has been associated with abnormal growth of the antler on the opposite side of the body, and other cases of injury to the fore leg with arrested growth of the antler on the same side, and cases of injury to the hind leg with arrested growth of the antler on the opposite side. There is a specimen in the Royal College of Surgeons Museum which shows the same thing. The question of the influence of unilateral castration and unilateral injury on antler growth would well repay further inquiry. It is possible that secondary sex characters in the stag are peculiarly sensitive to nervous influences, and it would seem at any rate that if Rörig's observations are confirmed they cannot be entirely explained by any purely Harmonic theory.

It is interesting to compare this hemilateral feather pattern in the tail of this hermaphrodite bird with a case described by Shattock and Seligman in the *Transactions of the Path. Soc.* LVII, 1906, where they figure the tail feather of a cock pheasant hatched in 1902 (cf. Pl. XI, fig. 14). At Christmas 1903, this bird, while showing the usual adult male plumage, began to develop female markings at the proximal end of the central tail feather. This localized assumption of a secondary female sex character did not come about through the moulting of the male feather and the growth of a female one, but by the appearance of the female pattern at the base of the male feather. The portion of the feather so marked was sharply divided transversely from the male portion and included the whole width and both sides of the feather. During subsequent moults in 1904-5 there was no reappearance of the female

pattern, the bird at that time showing the full adult male plumage and functioning as a male.

It is I think reasonable to conclude that the gametic factors (whatever their nature) in this case controlled the pigmentary pattern of this tail feather alternately along male and female lines, whereas in my hermaphrodite specimen they controlled the pigmentary pattern in opposite halves of each tail feather coincidentally.

But there is yet another point of interest about the tail.

In the Royal College of Surgeons Museum the skin and the internal organs are preserved of a true hermaphrodite Leghorn fowl. The microscopic structure of the double sex gland in this case has been carefully worked out by Shattock; it undoubtedly constitutes an ovo-testis. In this specimen a well-developed male comb and spurs are present, but there are no sickle feathers and the tail as a whole (though rather long) is of the female type. The distribution of the male sex characters is arranged on an antero-posterior or segmental rather than a bilateral pattern.

There would seem then to be two main types of sex character manifestation, as far as the body and limbs are concerned.

Type I. In which a double sex gland is associated with a hemilateral distribution of secondary sex characters, as in my specimen.

Type II. In which a double sex gland is associated with an antero-posterior or transverse distribution of secondary sex characters, as in this White Leghorn fowl. These two Types might be distinguished as the Lateral and the Segmental Types.

Although both halves of the tail seem to function in heredity as one whole (no one has seen a tail with one half male and the other half female), yet the individual tail feathers show the same antero-posterior and hemilateral types of manifestation of secondary sex characters that we find in the body as a whole.

The first type is illustrated by the hemilateral male and female pigmentary pattern in each feather in my hermaphrodite specimen. The second type is illustrated by the transverse distribution of the same characters in the tail feathers in Shattock's specimen (cf. Pl. XI, fig. 14). Both represent extreme conditions of the normal arrangement in the tails of many birds in which not only does the outer or less covered side of the tail feathers exhibit a different pigmentary pattern to the inner side, but the distal portion may be also marked off from the proximal portion by transverse areas of different pattern.

The value of this specimen seems to lie in the light it may possibly throw on the process of Sex Differentiation. This individual bird shows

a tendency to divide into two halves of different sex, a male left half and a female right half, and along with this somatic differentiation the sex gland itself also shows a tendency to divide into a female portion and a male portion. Owing further to the fortunate fact that these two sex glands do not functionate coincidentally, we have an opportunity of observing a natural experiment, in which the effect of a female Hormone is first exercised simultaneously on the male and the female side of one and the same individual, while at a later stage the male Hormone exerts its influence on the same dual organism, with the result that while in the case of the trunk and limbs the male side only responds to the male Hormone, the tail responds as a whole, but only as regards one side of each individual tail feather.

Moreover along with, but not as the cause of or consequence of this abnormal somatic segregation, another abnormal segregation also occurred in the sex gland by which a dual gland or ovo-testis was formed and in which (as usual) the female portion came into functional activity and retrogressed before the male portion began to develop.

In some such manner it seems possible to explain the limitation of influence of the male and female sex gland Hormone to opposite sides of the body, for the side which possessed only femaleness and no maleness (i.e. no somatic rudiments capable of developing male characters) could not respond to the male Hormone, while the side which contained no female rudiments could not respond to the female Hormone. There is however a difficulty in this explanation, for as I have already pointed out (cf. Pl. XI, fig. 6), a well-marked spur rudiment such as normally occurs in the hen pheasant also occurs on the right leg (that is on the female side) in this bird. How are we to interpret this fact? It is true that it is small and resembles the rudimentary spur in normal female birds. Hence it may be regarded as a "specific" and not as a "sexual" character and so may be considered to be out of the reach of the influence so to speak of the male Hormone.

Or it may be that this spur rudiment on the right, or female, side represents a *single* dose of maleness instead of the double dose on the left side, in which as a consequence the spur is well developed. If this be so, then instead of simple "Presence and Absence" of maleness and femaleness the question becomes one of the volume of these factors. The greater volume of the male factor on the left side would then account for the readier response to the stimulus of the male Hormone in the left leg.

But whether we try to explain the facts by the presence and

absence of any given factor, or by the unequal volume of any factor on opposite sides of the body, or by the inhibition of one factor by another, or by a third or metabolic factor as suggested by Geoffrey Smith (*Proc. Linnæan Soc.* March 6, 1913) and Doncaster (*Brit. Assoc. Birmingham*, 1913), which acts as an intermediary between the sex gland and the secondary sex characters, still this bird differs from the normal individual in the fact that a process which normally affects both sides of the body equally, in this case affects them unequally. And yet this does not occur in a sharply defined or clear cut manner. In some parts, as for instance the limbs, the head and neck, this hemilateral limitation of influence is well marked, while along the middle line of the body and in the posterior part of the trunk there is some overlapping, and in the tail the influencing factor is broken up into secondary factors which control individual tail feather areas.

This latter is I think a point of some importance. It suggests that the segregation of controlling factors (whatever may be their material basis in heredity) does not occur suddenly at one stage only in the development of the organism but that it runs on and accompanies those cell divisions which at different stages regulate the growth of the different organs and tissues of the body.

Now if the ontological process be continuous and gradual, may not the segregation of gametic factors in the germ cell be a gradual and continuous process also? Although we draw an arbitrary line at the stage of fertilization, it is probable that gametic and blastomeric segregation are one and the same process which becomes accelerated at the time of fertilization.

If this be so, then from what we know of the irregular and asymmetrical cell divisions which lead to overlapping and blurring of unit characters in the zygote, it is reasonable to suppose that those qualitative divisions of the nuclear hereditary material (whatever it be, by which the gametic factors, the precursors of unit characters, are separated out in the germ cells) may also be less sharply defined than we have been led to think. Segregation may not be the cutting asunder of a chromosome or a portion of a chromosome by a sharp division into two distinct portions but the pulling asunder of one portion from another with detached particles adhering to either end.

SUGGESTED EXPLANATORY HYPOTHESIS.

The question now arises whether any explanation can be suggested which will fit the facts in this and similar abnormal cases. Assuming that the fertilized egg from which this zygote developed was a female egg, i.e. heterozygous in respect of sex, then we must suppose that at the stage of blastomeric segmentation at which the division of the body into two halves was laid down, the sex factor (instead of passing in equal portions to each half of the germ) divided unevenly, the factor for maleness passing into the left half and the factor for femaleness into the right half of the body. This lateral segregation was not however clear cut in those rudiments which represent the median fusion body areas, while in the tail region this qualitative segmentation was delayed till those cell divisions occurred which control the development of the separate halves of each tail feather.

The essential feature in this explanation is that it takes account of genetic as well as physiological factors. It ascribes an abnormal physiological phenomenon like the asymmetrical assumption of secondary sex characters to the interaction of two factors, a peripheral or somatic factor, and a central or sex gland gametic factor, though of course both these owe their abnormal limitations to a common abnormality of genetic origin, possibly arising at the time of the segregation between somatoplasm and reserve germplasm in the zygote.

In thus falling back on genetic factors one is forcibly reminded of certain features in modern views of heredity. There also the association between the gametic factor in the fertilized ovum and the unit character in the zygote is pictured in just the same way. The gametic factor stands to the unit character in the same relation that the sex gland and its Hormone stand to the corresponding secondary sex character. Just as we are still unable to decide whether the appearance of any given secondary sex character is due to the presence of a corresponding sex gland Hormone, or to the absence of an opposite sex gland Hormone which, if present, might inhibit the influence of the former, so students of heredity are still unable to decide whether any dominant unit character, such as tallness in the pea, or an abnormality like Brachydactyly, depends on the presence of a factor for tallness or short fingeredness, or on the absence of another factor which, if present, might inhibit the action of this abnormal factor, and so make for normality.

In fact the "Presence and Absence" theory, the "Inhibition" theory, and the "Unequal Volume" theory of Dominance and Recessivity are all as relevant to the study of the physiology of sex as they are to the study of the origin of all unit characters. Moreover, sex itself being a unit character, observations on abnormal examples like the present may possibly throw light on the larger problem.

For instance the fact that in vertebrates the sex gland influences the epithelial or other tissues which develop secondary male characters by means of some internal secretion, probably an enzyme, suggests that genetic factors in the nucleus of the fertilized ovum exercise their long drawn out influence over the development of all unit characters in the zygote in the same way. In both cases three elements are concerned:

- (a) Peripheral cells or unit characters.
- (b) Central sex gland or gametic factor.
- (c) Some communicating medium, possibly an enzyme, circulating in the blood rather than any structural continuity between (a) and (b).

We may even extend Ehrlich's side chain theory of immunity to the field of the development of secondary sex characters. We may conceive of the sex gland as liberating an Hormonic key capable of fitting the peripheral cell lock, but this must be made available and carried to the cell by some intermediate agency, and this intermediate handle or amboceptor may be supplied by one or more of the other ductless glands.

Just as it is possible by cross fertilization to replace one gametic factor by another and so to substitute one unit character for another in the zygote, so also by the removal of the sex gland in the individual (and more especially by parasitic castration) it is possible to bring about the replacement of the secondary sex characters normal to one sex by those peculiar to the other.

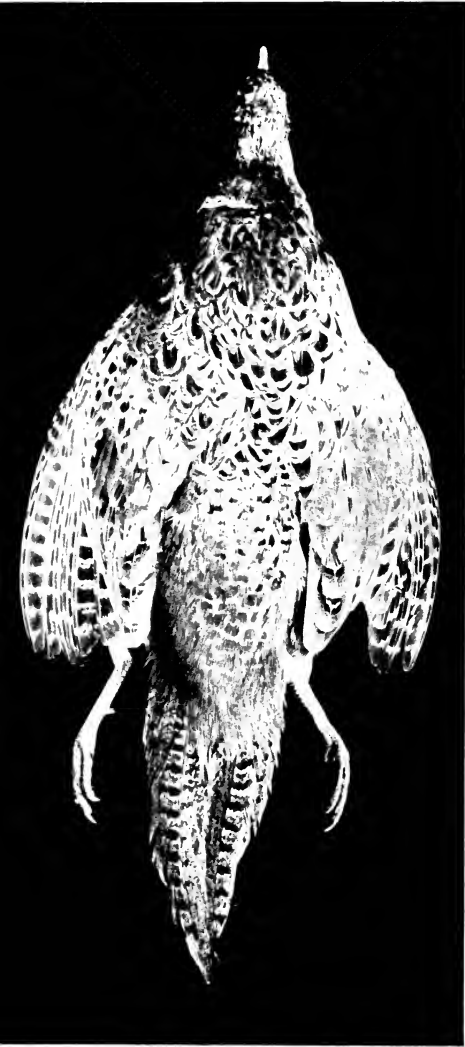

Fig. 1. Dorsal Surface. Hermaphrodite Pheasant.

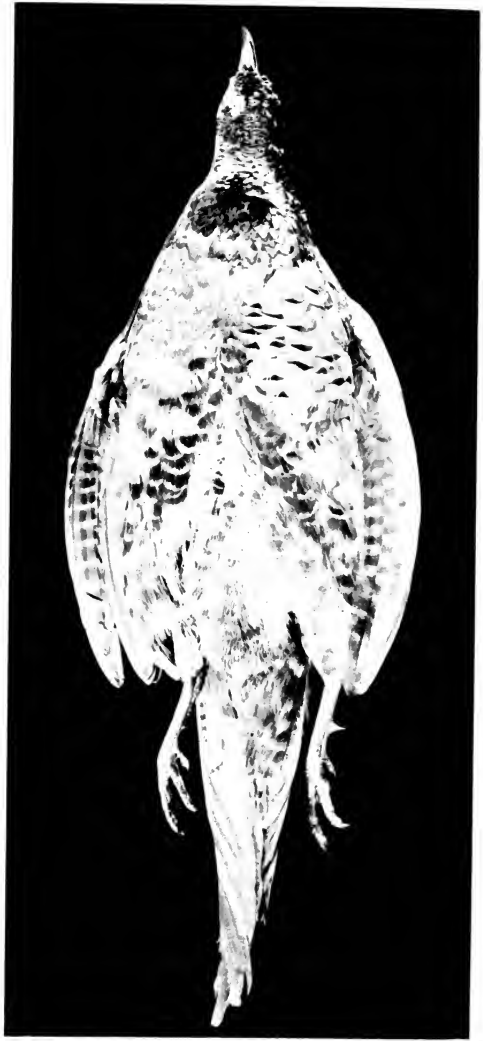

Fig. 2. Ventral Surface. Hermaphrodite Pheasant.



Fig. 3. Left or Male side. Hermaphrodite Pheasant.

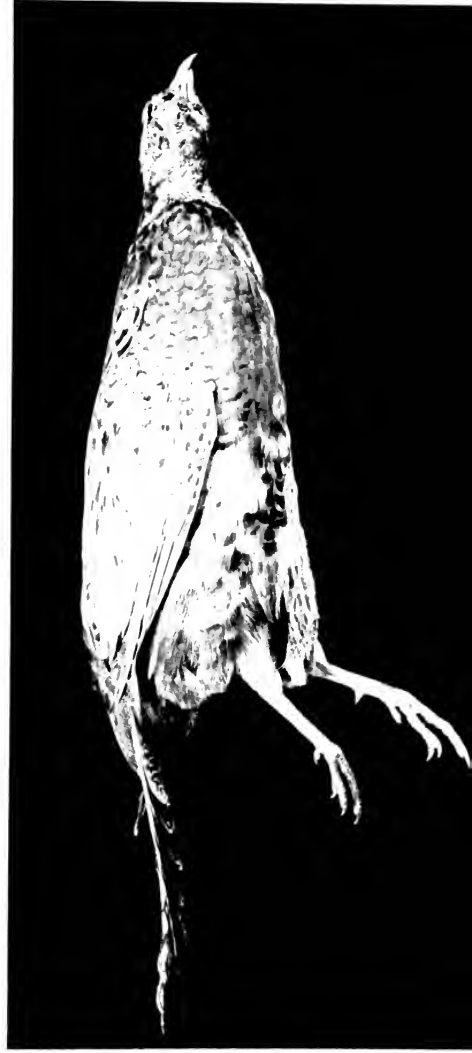
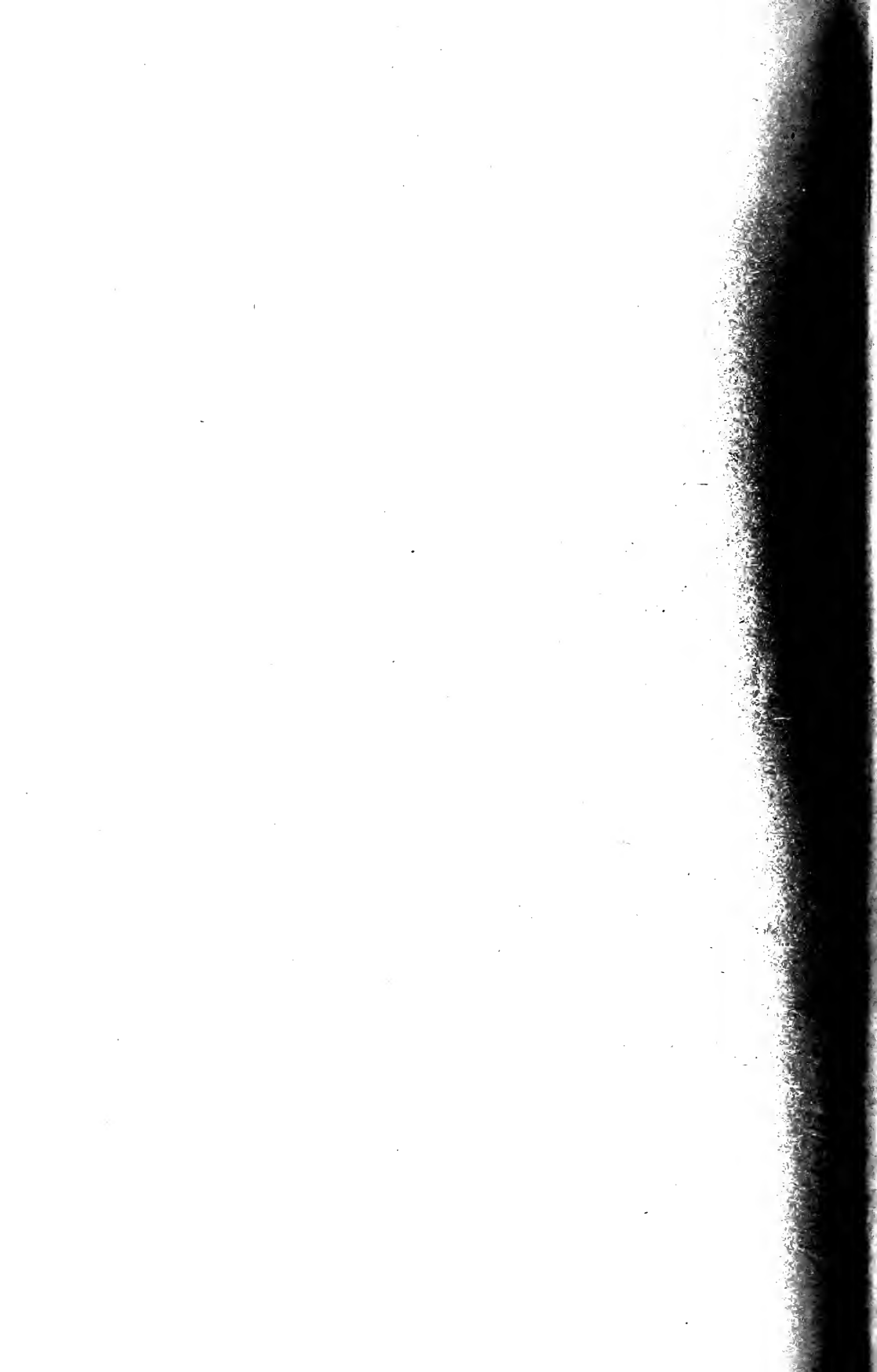

Fig. 4. Right or Female side. Hermaphrodite Pheasant.



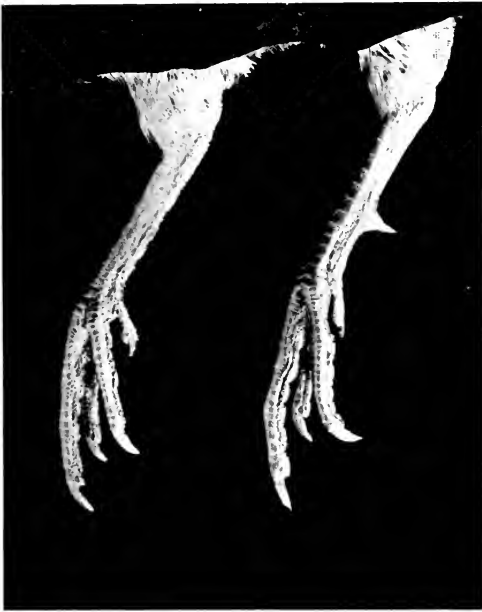

Fig. 5. Right leg. Left leg with spur.
Hermaphrodite Pheasant.



Fig. 6. Right leg. Enlarged. Rudiment of spur.
Hermaphrodite Pheasant.

Rudiment of spur. Right Leg.



Fig. 14. Tail feather of Cock Pheasant assuming Female colour pattern at proximal or growing end. Transverse limitation of ♂ and ♀ characters. Specimen in Museum Royal Coll. Surg. See Shattock, *Trans. Path. Soc.* Vol. LVII. (Copied by permission.)

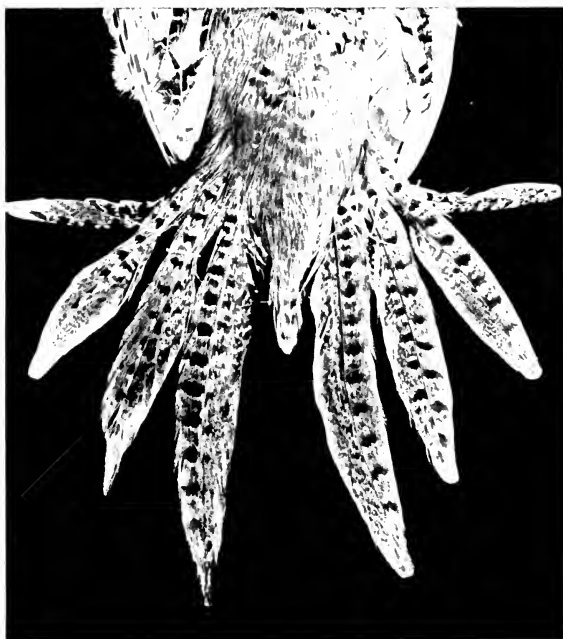

Fig. 7. Unilateral male colour pattern in individual tail feathers. Hermaphrodite Pheasant.



Fig. 8. Bilateral male colour pattern in individual tail feathers. Hen Pheasant, atrophy of ovary, and presence of male elements.



Fig. 9. Cock Pheasant. Normal male colour pattern in tail feathers.

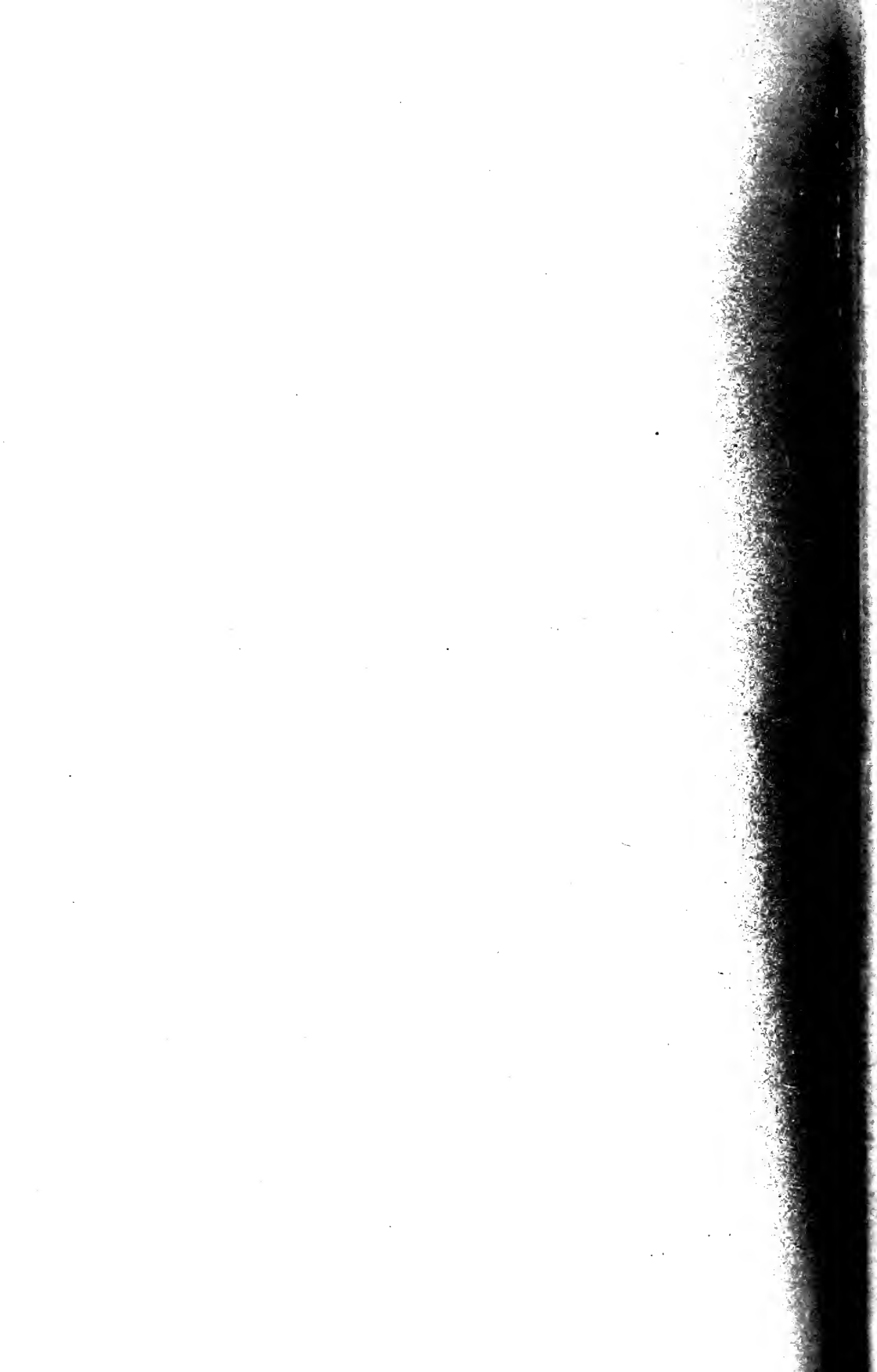



Fig. 10. Sex-gland. Ovo-testis ($\times 2$).
Hermaphrodite Pheasant.



Fig. 13. Sex-gland. Hen Pheasant. Symmetrical
assumption of male plumage, atrophy ovary.
A, Male portion. B, Female portion of gland.



Fig. 11. Ovarian portion of Sex-gland.
Hermaphrodite Pheasant.



Fig. 12. Testicular portion of Sex-gland.
Hermaphrodite Pheasant.



MINOR-BRACHYDACTYLY. No. 2.

BY H. DRINKWATER, M.D., F.R.S. (Edin.), F.L.S.

IN September 1911, at a Meeting of the International Conference of Genetics, held in Paris, I gave an account of a family showing an inherited abnormality, which I termed *Minor-Brachydactyly*, to distinguish it from a more marked defect of the same kind, termed *Brachydactyly*, described previously¹. The account of the *Minor-Brachydactyly* family was also published in the *Journal of Genetics*, Vol. II. Part I. February 1912. More recently, owing to the courtesy of my friend Dr F. Drinkwater of Llangollen, I have been able to study another family showing the *Minor-Brachydactylous* condition. So closely do the two families resemble one another, as regards this abnormality, that one cannot help thinking they must have arisen from a common stock, though the connection cannot now be traced, and as far as the records go back there is no blood-relationship between them.

The most marked peculiarities in each family are the shortness of the digits (fingers and toes), and the shortness of stature.

As a full description was given in the accounts already referred to, it will only be necessary in this paper, to draw attention to the main features.

In the *Brachydactyly* family, the abnormality in the fingers was shown to consist in a marked shortening of the middle phalanx, which in the adult was found to be united to the terminal one: so that the finger has two bones instead of the normal three. The length of the finger was found to be about half the normal length.

In the *Minor-Brachydactyly* family there is also a shortening of the digits, but to a smaller extent and due to the same abortive condition

¹ Account of a *Brachydactylous* Family, *Proc. Roy. Soc. of Edin.* Vol. xxviii. Part 1.

Minor-Brachydactyly

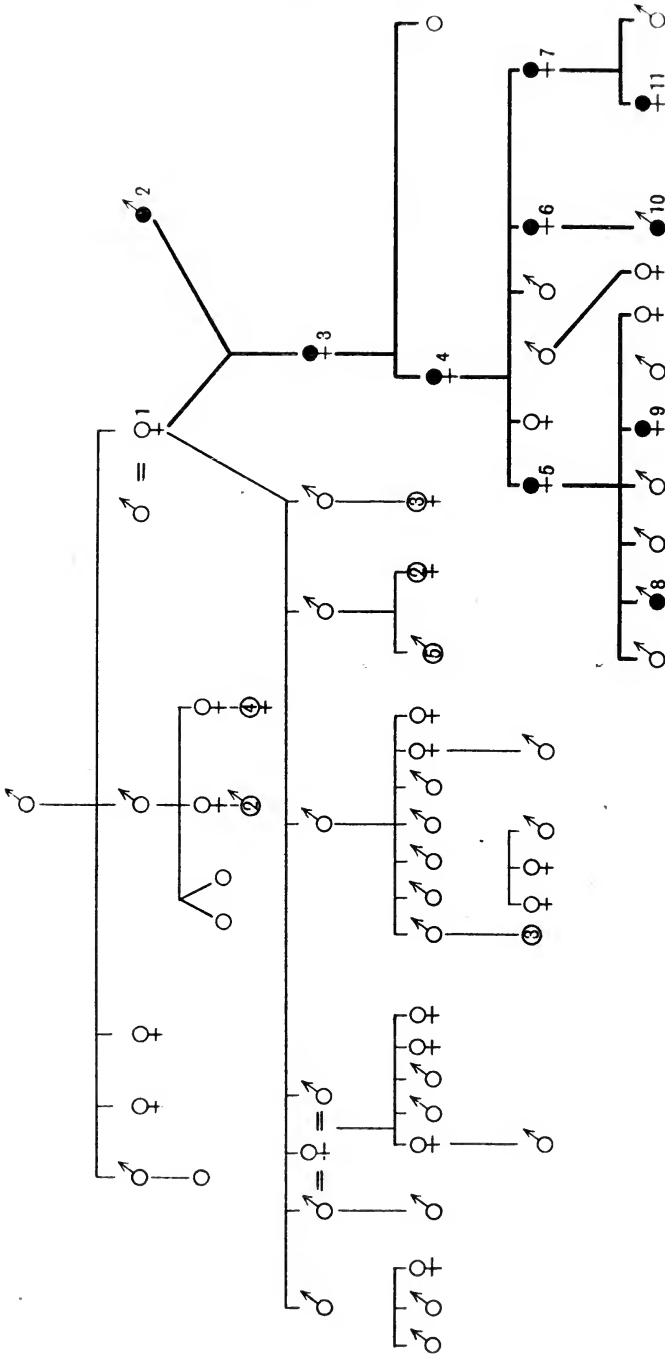

Pedigree of Family showing Minor Brachydactyly.

of the middle bone, the second phalanx, which however always remains in the adult separate from the terminal bone.

This second family of Minor-Brachydactyly can be traced through five generations, and there are eight abnormal individuals alive at the present time. These are numbered in the chart, 4 to 11 inclusive. I am able to present radiographs of each case, and photographs of the right hand of four of them.

Radiographs of the hand.

(1) Adults. These show the shortened middle phalanx in every case. It remains a separate bone. (Pl. XIV, fig. 1.)

(2) Children. The epiphysis is seen to be absent as a rule. (Pl. XV, fig. 1.)

Radiographs of feet.

(1) Adults. Ankylosis has occurred between the second and terminal phalanges in every case. The feet are therefore more degenerate than the hands. (Pl. XIV, fig. 2.)

(2) Children. The epiphysis is absent from the base of the second phalanx in every toe (except the big toe). (Pl. XV, fig. 2.)

Photographs of hands.

A comparison with the normal hand will show the peculiarities. (Pl. XVI, figs. 1 and 2.)

Mendelism.

The abnormality behaves as a Mendelian dominant; only being reproduced by an affected individual. The children of normals are all free from the abnormality and have fingers and toes of the ordinary type. The expected ratio is approached as nearly as possible, for of 19 descendants of abnormals 9 are abnormals.

It is necessary to explain one part of the pedigree chart.

No. 1, a normal woman, and the female ancestor of all the abnormals, was married to a normal man. All *their* descendants, as well as *her* brothers and sisters, are seen to have been normal. In the village in which this couple lived was a short-fingered man (No. 2) who was occasionally employed by them to perform a certain surgical operation on their young pigs. Eventually the woman gave birth to a daughter (No. 3) who was Brachydactylous.

Measurements in Inches.

Number	Age	Middle finger	Hand width	Height
4	—	$2\frac{1}{4}$	$5\frac{3}{4}$	57
5	39	$2\frac{1}{2}$	$6\frac{1}{2}$	60
6	32	2	$5\frac{3}{4}$	59
7	28	$2\frac{1}{4}$	$6\frac{1}{8}$	59
9	7	2	$4\frac{1}{2}$	43
10	$9\frac{1}{2}$	$1\frac{5}{8}$	$4\frac{3}{8}$	$46\frac{3}{8}$
11	6	$1\frac{5}{8}$	$4\frac{1}{2}$	$42\frac{1}{2}$

The average length of the middle finger in the adults is $2\frac{1}{4}$ inches: about 1 inch shorter than the normal.

The average height of the adults is $58\frac{3}{4}$ inches: about $4\frac{1}{2}$ inches below the normal average.

EXPLANATION OF PLATES.

PLATE XIV.

- Fig. 1. Right hand of woman showing minor-brachydactyly. No. 7 in pedigree.
 Fig. 2. Right foot ,, ,, ,, ,,

PLATE XV.

- Fig. 1. Right hand of girl showing minor-brachydactyly. No. 11 in pedigree.
 Fig. 2. Right foot ,, ,, ,, ,,

PLATE XVI.

- Figs. 1 and 2. Hands of mother and daughter. Nos. 4 and 6.
 Fig. 3. Boy (No. 8 in pedigree, *actat.* 14) on left, and younger normal brother, *actat.* 12, on right.



Fig. 1.



Fig. 2.



Fig. 2.



Fig. 1.



Fig. 1.



Fig. 2.

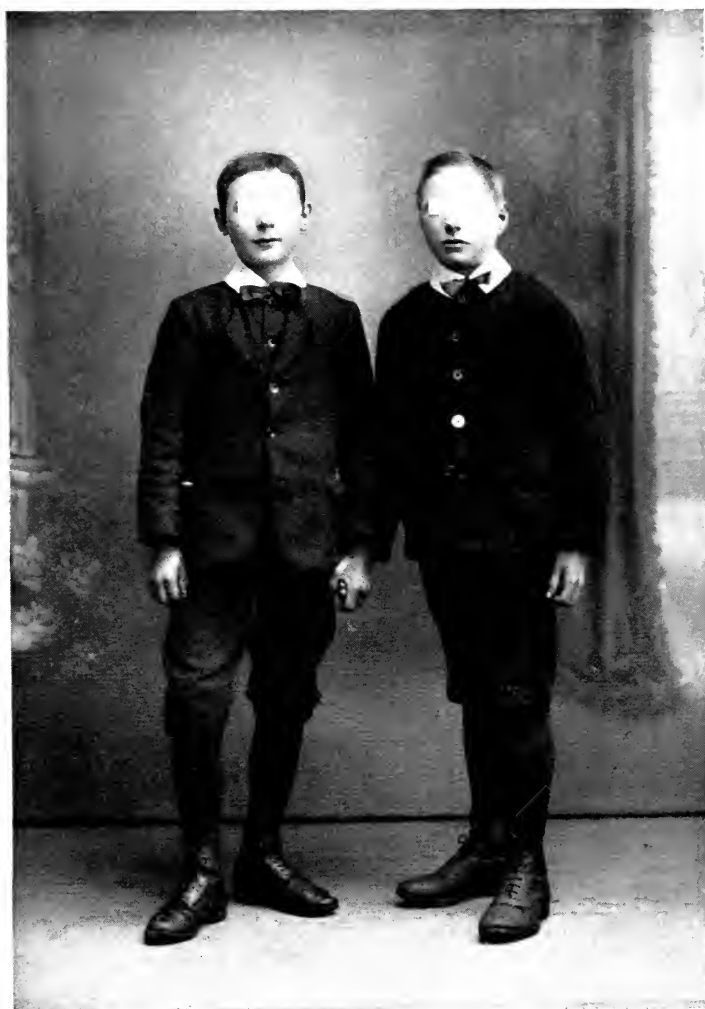

Fig. 3.

PRIMARY AND SECONDARY REDUPLICATION SERIES.

By P. G. BAILEY, M.A.
(*Clare College, Cambridge.*)

IN a recent paper, Trow (4) discusses theoretically the possible interactions of the factors making up a three-factor group of such a nature that any two may form a reduplicated series. He shows that if the three factors of such a group have the primary reduplication series

$$\begin{aligned} l &: 1 : 1 : l \\ m &: 1 : 1 : m \\ n &: 1 : 1 : n, \end{aligned}$$

then the secondary or observed reduplication series will be

$$\begin{aligned} lmn + l &: m + n : m + n : lmn + l \\ lmn + m &: l + n : l + n : lmn + m \\ lmn + n &: l + m : l + m : lmn + n. \end{aligned}$$

He further points out that if n becomes 1, that is if there is no primary reduplication series between one of the pairs, the series become

$$\begin{aligned} l &: 1 : 1 : l \\ m &: 1 : 1 : m \\ lm + 1 &: l + m : l + m : lm + 1. \end{aligned}$$

For the convenience of reference the former series will be called Trow's general hypothesis; the latter series Trow's special hypothesis.

There exists, also, the possibility to which Punnett (3) calls attention, namely that the primary reduplication series, obtained by analysis as above of the facts observed when three factors are involved, differ from the reduplication series found when only two factors are involved. In order to avoid confusion it is desirable that the three possible series should be given distinctive names. In this

paper the series found when only two factors are involved will be called the 'fundamental' series for those two factors; following Trow the series observed when three factors are involved will be called the secondary series; the underlying series calculated from these secondary series will be called the primary series.

The data obtained from crosses involving three factors have been discussed by other writers from the point of view of the special hypothesis. Owing to the great importance of the subject of coupling and repulsion it seemed to me that it would be interesting to study the observed phenomena by means of the general hypothesis also.

The most complete account of such crosses is given by Punnett (3) in a recent paper. The following calculations are based upon the data there discussed, and reference should be made to that paper for an explanation of the symbols used in the following account.

(α) *Nature of mating* **EBL** \times **ebl**.

The equations from which the primary reduplication series can be determined are

$$\frac{lmn + l}{m + n} = \frac{13}{3},$$

$$\frac{lmn + m}{l + n} = 63,$$

$$\frac{lmn + n}{l + m} = \frac{13}{3},$$

which give

$$l = n = 2 \cdot 1,$$

$$m = 48 \cdot 3^1.$$

These numbers indicate the complicated primary series

$$\mathbf{BL : Bl : bL : bl} = 21 : 10 : 10 : 21$$

$$\mathbf{BE : Be : bE : be} = 483 : 10 : 10 : 483$$

$$\mathbf{EL : El : eL : el} = 21 : 10 : 10 : 21.$$

These complicated series however approach closely to the simple series

$$2 : 1 : 1 : 2$$

$$52 : 1 : 1 : 52$$

$$2 : 1 : 1 : 2,$$

¹ It may be noted that if the two smaller observed reduplication series are equal, the assumption that $n=1$ cannot be true, for then $l=1$. However it is impossible at present to decide whether these two series are in fact equal or not owing to the relative smallness of the numbers.

which would give rise to the following secondary gametic series:

$$39 : 10 : 10 : 39$$

$$65 : 1 : 1 : 65$$

$$39 : 10 : 10 : 39.$$

These gametic series would give rise to zygotic series, which agree fairly closely with those actually observed, cf. Punnett (3), p. 81:

$$\text{BL} : \text{Bl} : \text{bL} : \text{bl} :: \begin{array}{l} 479 : 58 : 66 : 143 \text{ observed} \\ 490 : 68 : 68 : 122 \text{ calc.} \end{array}$$

$$\text{BE} : \text{Be} : \text{bE} : \text{be} :: \begin{array}{l} 532 : 5 : 6 : 203 \\ 554 : 5.7 : 5.7 : 184 \end{array}$$

$$\text{EL} : \text{El} : \text{eL} : \text{el} :: \begin{array}{l} 479 : 59 : 66 : 142 \\ 490 : 68 : 68 : 122. \end{array}$$

(β) *Nature of mating* $\text{BeL} \times \text{bEl}$.

The observed **BL** relationship is most accurately explained on the basis of a 10 : 1 : 1 : 10 series, and the **EL** relationship on a 1 : 12 : 12 : 1 series, but it is by no means impossible that these gametic series are in reality of the same intensity. It will be assumed for the sake of simplicity that they are.

The equations may then be written

$$\frac{l^2m + l}{m + l} = 10,$$

$$\frac{l^2m + m}{2l} > 32.$$

The only value of l which would be of a simple nature and would approximately satisfy these equations is $l=3$. Then the observed secondary relations between **B** and **L** and **E** and **L** must be of a type with less intensity than 9 : 1 and greater intensity than 8 : 1.

The observed (cf. (3), p. 83) and calculated zygotic series are given below:

$$\text{BL} : \text{Bl} : \text{bL} : \text{bl} :: \begin{array}{l} 3006 : 164 : 212 : 843 \text{ observed} \\ 2980 : 200 : 200 : 856 \text{ calc. } 9 : 1 : 1 : 9 \text{ basis} \end{array}$$

$$\text{EL} : \text{El} : \text{eL} : \text{el} :: \begin{array}{l} 2200 : 1001 : 1018 : 6 \text{ observed} \\ 2135 : 1040 : 1040 : 10.6 \text{ calc.} \end{array}$$

224 *Primary and Secondary Reduplication Series*

(γ) *Nature of mating* DfN \times dFn.

The value of l is again very near that of n if not equal to it. Assuming $l = n$, the observed secondary reduplication series can be shown to depend upon the complicated series

$$\begin{aligned} &19 : 10 : 10 : 19 \\ &10 : 57 : 57 : 10 \\ &10 : 19 : 19 : 10. \end{aligned}$$

These complicated series are not very different from the simple series

$$\begin{aligned} &2 : 1 : 1 : 2 \\ &1 : 6 : 6 : 1 \\ &1 : 2 : 2 : 1, \end{aligned}$$

which would be obtained if the observed secondary series were

$$\begin{aligned} &3\cdot2 : 1 : 1 : 3\cdot2 \\ &1 : 7\cdot3 : 7\cdot3 : 1 \\ &1 : 3\cdot2 : 3\cdot2 : 1. \end{aligned}$$

Below are given for purposes of comparison the actual numbers obtained (cf. (3), p. 89), the numbers to be expected upon the above hypothesis, and the numbers to be expected on Trow's special hypothesis.

		Expectation on Trow's special hypothesis			
		On the assumption that this is the secondary series			
	Found	Expectation on 3 \cdot 2 : 1 : 1 : 3 \cdot 2 system	On the assumption that this is the primary series 3 : 1 : 1 : 3	If the DF series is 7 : 1	If the DF series is 15 : 1
ND	282	286	284	273	277
Nd	49	46	48	58.3	54
nD	52	46	48	58.3	54
nd	59	65	62	52	56.5
		On 1 : 3.2 : 3.2 : 1	On 1 : 3 : 3 : 1		
NF	225	227	228	231	230
Nf	106	104.2	103.5	100	101
nF	101	104.2	103.5	100	101
nf	10	6.3	7	10.8	9
		On 1 : 7.3 : 7.3 : 1	On 1 : 7 : 7 : 1	On 1 : 15 : 15 : 1	
DF	220	223	222.7	221.4	
Df	114	109	108.8	110.1	
dF	106	109	108.8	110.1	
df	2	1.6	1.7	.4	

The above table shows that Trow's special hypothesis fits the figures better than the general hypothesis¹, if the assumption be made that the **NF** series is the secondary series, and that the **DF** relationship is on the 1 : 15 basis. The agreement may be purely accidental but it is interesting to note that Punnett found certain strains in which the fundamental **NF** series was itself on a 1 : 1 basis.

(δ) *Nature of mating* $DFn \times dfN$.

The values obtained in this case are $l = n = 1$, and $m = 15$, i.e. the apparent relations are the real relations. The **ND** and **NF** fundamental repulsion series are reduced to a 1 : 1 : 1 : 1 basis.

The only additional data² bearing upon this question are those furnished by Gregory (2) in his description of the results obtained from a cross of the nature **MSG msg** \times **msg msg**. Trow (4), p. 315, discusses these results from the point of view of the special hypothesis, and he shows that the observed numbers agree fairly well with those obtained by calculation on the assumption that the **SG** series is the secondary one. On the other hand it can be shown that, if in reality the general hypothesis applies to this case, the numbers fit in very badly with any simple primary series. It should be noted that the observed **MS** series closely approximates to the fundamental **MS** series, and that no fundamental **SG** series has yet been described. Consequently it is by no means clear that the case, which Gregory has described, is really comparable with those described by Punnett.

Conclusion.

The general hypothesis adopted above, although it admits the possibility of a difference between the fundamental and the primary series due to the interaction of the reduplication series one upon another, does not postulate a differential interaction. The special hypothesis on the other hand does postulate a differential interaction.

¹ If the complex series calculated on the general hypothesis be taken, the agreement between the numbers found and the numbers obtained by calculation would be even better than on Trow's simple hypothesis.

² Morgan and Cattell (5, 6) have described certain crosses with *Drosophila* which involve three factors. The results, however, are complicated by the phenomena of sex limitation, and by differential death rates. Moreover it is not clear in each case whether the given relationships are to be looked upon as fundamental or primary. Nevertheless it is interesting to note that in the most satisfactory case, namely that involving black body colour **B**, red eye colour **R**, and long wings **L**, the secondary relationship for **L** and **B** i.e. 1.9 : 1 calculated upon Trow's special hypothesis closely approximates to the relationship found by experiment.

226 *Primary and Secondary Reduplication Series*

For three factors taking part in a reduplication series, Bateson and Punnett (1) suggest an octant arrangement. Such an octant arrangement showing the possible course of the divisions in the formation of reduplication series is given below.

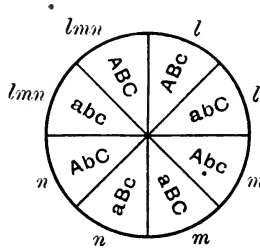

It is difficult to see any cause for differential treatment on such a scheme. Trow's scheme, however, which involves one factor waiting its turn to segregate until the other two have completed their reduplication series, does from its very nature offer a possible explanation for such differential treatment. Consequently further research showing whether the course of events is best explained by the general hypothesis or by the special hypothesis may throw light upon the question as to whether the octant scheme or Trow's scheme is to be preferred as a better picture of the process of segregation and the formation of reduplication series.

An interesting feature that becomes apparent on analysing the observed fact by means of the general hypothesis, is the regularity of the underlying phenomena. Such analysis shows that in all four cases the two fundamental series of least intensity have their intensity reduced when they become primary series, although the observed or secondary series may be of a greater intensity. It is by no means impossible that the same holds good for the third reduplication series, as is certainly the case in the $EBL \times ebl$ and in the $DfN \times dFn$ matings.

Another possible regularity in the observed phenomena is the reduction of two of the fundamental series to primary series of identical intensity. The numbers are strongly in favour of this suggestion in at least two of the cases. If such a relationship is shown to be general, it may be due to the necessity for the divisions involved in segregation and in the formation of reduplication series to be on a symmetrical plan.

LITERATURE.

1. BATESON, W., and PUNNETT, R. C. "On Gametic Series involving Reduplication of certain Terms." *Journal of Genetics*, 1911.
2. GREGORY, R. P. "On Gametic Coupling and Repulsion in *Primula sinensis*." *Proc. Roy. Soc.* 1911.
3. PUNNETT, R. C. "Reduplication Series in Sweet Peas." *Journal of Genetics*, 1913.
4. TROW, A. H. "Forms of Reduplication, Primary and Secondary." *Journal of Genetics*, 1912.
5. MORGAN, T. H. and E. CATTELL, 1912. "Data for the Study of Sex-linked Inheritance in *Drosophila*." *Journ. Exp. Zool.* XIII.
6. ———, 1913. "Additional Data for the Study of Sex-linked Inheritance in *Drosophila*." *Journ. Exp. Zool.* XIV



ON HYBRIDS BETWEEN MOTHS OF THE GEOMETRID SUB-FAMILY *BISTONINAE*, WITH AN ACCOUNT OF THE BEHAVIOUR OF THE CHROMOSOMES IN GAMETOGENESIS IN *LYCIA* (*BISTON*) *HIRTARIA*, *ITHYSIA* (*NYSSIA*) *ZONARIA* AND IN THEIR HYBRIDS.

By J. W. H. HARRISON, B.Sc., AND L. DONCASTER, Sc.D.

PART I. GENERAL ACCOUNT OF HYBRID *BISTONINAE*.

By J. W. H. HARRISON, B.Sc.

IN the *Entomologist* for July 1910 I indicated that I had succeeded in producing a number of new hybrids in the trio of genera included in what may be called, for the sake of convenience, the Biston group. I did not then, however, publish any details, either biological or otherwise, concerning them. Since then, in the case of many of these hybrids, I have worked out their detailed life history and have therein compared them, point by point, with the parent species. Further, I have secured several new and important pairings; not only is this so, but in the case of most of them I have published an exhaustive account in Oberthür's *Lepidopterologie comparée*, Fascicule VII, pages 333—655. In case this work is not readily accessible to English readers, I am writing this summary of my results to accompany Dr Doncaster's statement of his investigations into the oogenesis and spermatogenesis of *Lycia hirtaria* and *Ithysia zonaria*, and their two crosses, hybrids *denhami* and *harrisoni*. (Plate XVII.)

The hybrids reared may be divided into two sections.

- (a) The Primary hybrids, i.e. those with pure species as parents.
- (b) The Secondary hybrids, i.e. those in which either of the two parents was a primary hybrid.

The primary hybrids reared up to the present are as follows :

<i>Lycia hirtaria</i> ♂	×	<i>Ithysia zonaria</i> ♀	(Pl. XVII)	=	<i>Lycia hybr. denhami</i> .
<i>Lycia hirtaria</i> ♂	×	<i>Ithysia graecaria</i> ♀		=	<i>L. hybr. buloveci</i> .
<i>Lycia hirtaria</i> ♂	×	<i>Poecilopsis pomonaria</i> ♀		=	<i>L. hybr. pilzii</i> .
<i>Ithysia zonaria</i> ♂	×	<i>Lycia hirtaria</i> ♀	(Pl. XVII)	=	<i>L. hybr. harrisoni</i> .
<i>Ithysia zonaria</i> ♂	×	<i>Poecilopsis lapponaria</i> ♀		=	<i>I. hybr. merana</i> .
<i>Ithysia zonaria</i> ♂	×	<i>Poecilopsis pomonaria</i> ♀		=	<i>I. hybr. langei</i> .
<i>Poecilopsis pomonaria</i> ♂	×	<i>Lycia hirtaria</i> ♀		=	<i>P. hybr. hunii</i> .
<i>Poecilopsis pomonaria</i> ♂	×	<i>Ithysia zonaria</i> ♀		=	<i>P. hybr. helenae</i> .
<i>Poecilopsis lapponaria</i> ♂	×	<i>Ithysia zonaria</i> ♀		=	<i>P. hybr. smallmani</i> .

Similarly, the secondary hybrids are appended :

<i>Poecilopsis pomonaria</i> ♂	×	<i>L. hybr. pilzii</i> ♀		=	<i>P. hybr. brooksi</i> .
<i>Lycia hybr. pilzii</i> ♂	×	<i>L. hirtaria</i> ♀		=	<i>L. hybr. burrowsi</i> .
<i>P. hybr. hunii</i> ♂	×	<i>L. hirtaria</i> ♀		=	<i>P. hybr. hulli</i> .

Up to the present, only one tertiary hybrid, that is to say a hybrid with one of my secondary hybrids as a parent, has been obtained. This form has been successfully reared to the pupal state and I trust to have the pleasure of seeing the imagines next spring. Its parentage is *L. hybr. burrowsi* ♂ × *L. hirtaria* ♀ and I am calling it *L. hybr. adkini* in honour of my friend Mr. R. Adkin, who has assisted me in many ways during the course of my many experiments.

I have no intention of giving a prolonged account of the comments I made in my work in *Lepidopterologie comparée* upon the various phenomena observed which demanded special treatment. Two of these features, however (in my eyes at least), are so important that I have reserved them for a special paper to be published shortly.

The various points are given below and a brief *résumé* of the discussion in my longer paper is added to each.

(1) *The great constitutional strength of the larvae.*

(2) *The growing sterility of the primary hybrids as the specific divergence between the parents increases.*

I pointed out that "strength" in the case of all of the crosses behaved as a Mendelian dominant, and that, granting the possibility of aberrations (mutations) possessing great constitutional strength, these two factors alone would result, in some cases, in what could only be classed as new species.



Ithysia (Nyssia) zonaria



Lycia (Biston) hirtaria



L. hirtaria ♀ × *I. zonaria* ♂



I. zonaria ♀ × *L. hirtaria* ♂



(3) *Dominance of characters derived from the undoubtedly weaker Ithysiae.*

This was treated at length and shown to depend on the fact that, highly specialised as the Ithysiae are, they are yet, in many points, the most primitive genus of the group in spite of the fact that, for the most part, the genus *Lycia* is nearer the common phylogenetic ancestor of both genera. In other words, we have a recurrence of common ancestral features.

(4) *The superior influence of the male.*

This is an experimental result that I have noted in practically all of the hybrids I have reared, not only in this family, but amongst the Ennomids and Larentiads likewise. No reasonable explanation of this fact has ever been suggested.

(5) *The refusal of the food plants of the Ithysiae.*

I have pointed out that this probably depends on the fact that, in general, the Boarmiads are an arboreal group and that the Ithysiae have almost certainly abandoned the family habit; there is thus latent in them a tendency to eat the same food plants as the *Pocilopsis-Lycia* fraternity.

(6) *The abnormal sex proportions yielded.*

Four of the hybrids,

Lycia hybr. *denhami*,

L. hybr. *buloveci*,

P. hybr. *smallmani*,

P. hybr. *helenae*,

exist only in the male sex under normal conditions.

It must not be supposed that this failure to give females is restricted to this compact group of genera, for I have observed it in the case of two other crossings I have made amongst the Boarmiinae, viz.:

(1) *Epione parallelaria* ♂ × *E. apiciaria* ♀ = hybr. *isabellae*

and (2) *Tephrosia crepuscularia* ♂ × *T. bistortata* ♀ = hybr. *bacoti*.

Strong inbreeding of the parents producing two of the above hybrids, on one occasion, resulted in the production of odd females, but the same procedure was without effect whenever *Lycia hirtaria* took part in the cross.

Five of the hybrids,

L. hybr. pilzii,
P. hybr. hunii,
L. hybr. burrowsi,
P. hybr. hulli,
L. hybr. adkini,

yield the two sexes in approximately equal numbers.

Three hybrids,

P. hybr. lungei,
I. hybr. harrisoni,
P. hybr. merana,

give a large excess of females.

Lastly, the sole form reared from a hybrid ♀, i.e. *hydr. brooksi*, gives specimens which are hopelessly gynandromorphic, wings, body, genitalia, antennae being built up of parts chosen at random, as it were, from both sexes of the parents and grand-parents. It is worthy of note that the larger and more robust the specimen, the more the male characters predominate and *vice versa*.

(7) *The tendency for the hybrids to emerge long before the parent species.*

In most of the hybrids, it appeared that the emergence was hastened by a period varying from a fortnight to three months. Most curiously, this varied with the sex for, in most cases, the acceleration noted in the case of the females was very great compared with the slight displacement seen in the males, although the divergence was never so great as that observed in hybrid *robsoni* = *Larentia (Oporabia) dilutata* ♂ × *Lar. (O.) autumnata* ♀. In this case, the females appeared about four and a half months before the males and a similar period before both sexes of the reciprocal cross *rungei* = *L. (O.) autumnata* ♂ × *L. (O.) dilutata* ♀.

It is not my intention to give here my thoughts on the import of this, nor what appears to me to be the significance of the sex proportions detailed above. I hope to be in a position to publish my paper (already planned out) before long.

(8) *The wing development of the hybrid females.*

The hybrid females, when produced, vary greatly in their wing development; those between *hirtaria*, fully winged, of course, in both sexes, and one of the so-called apterous species, possess wings varying enormously even within the limits of the same brood. This is a distinct

consequence of the fact that, whilst there is but little difference in the wings of various specimens of *hirtaria* females, in the apterous forms there is an extraordinary amount of variability.

In *lapponaria*, for instance, the wings vary from mere vestiges to long lanceolate appendages and similarly with *pomonaria*; *zonaria* on the contrary, although not quite constant, for it varies slightly in the same direction, is almost so. The hybrids have thus to combine the immutability of the female wings of *hirtaria* with the varying forms developed in the other species. The result is that, whilst in most cases we have wings produced resembling very roughly ordinary male wings, although only two-thirds of the expanse, in many, we have long, narrow pointed wings, and in others, wings most curiously shortened, giving one the notion that a piece has been cut from them. As one might expect, the variation is least in the *zonaria* ♂—*hirtaria* ♀ cross and greatest in the two *hirtaria*—*pomonaria* crosses.

Nor is the variation confined to size and shape for, strange to say, the wing scales vary simultaneously; the smaller the wings the greater the tendency for the scales and fringes to become bristle or hair-like as in normal apterous females. Further, although the rudimentary wings of the apterous forms are not melanic, nevertheless the smaller the wings in the hybrids the greater the melanic tendency, which, however, it must be remarked, is present in all of the female hybrids.

In crosses between the apterous forms, in the majority of cases, the wings are small and constant, and seem greatly influenced by the wing form of *zonaria*.

The tendency of hybrid *brooksi* to produce forms with all the possible wing shapes combined in one specimen has already been noticed.

The wing forms of the other two secondary hybrids demand special attention. The females yielded by the crossing *humii* ♂ and *hirtaria* ♀ possess forewings about five-sixths of the normal wing expanse of *hirtaria* ♂ but with the inner margin shortened, and the costa and termen strongly rounded. The hindwings, except that they are proportionately stouter and broader, are not unlike those of *humii* ♀. The scaling of both sets is that of *hirtaria* ♀; the markings, too, except that the fringes are quite black, follow *hirtaria*.

The hybrid between *pilzii* ♂ and *hirtaria* ♀ very curiously produces females, which, except for the slightly rounded costa and termen, have both sets of wings almost, but not quite, as fully developed as those of *hirtaria* ♀. If the predominant influence of the male, as mentioned

above, is carried through both generations this would explain the difference in form between two hybrids so nearly the same in blood, both being three quarters *hirtaria* and one quarter *pomonaria*.

PART II. ON THE CHROMOSOMES IN GAMETOGENESIS OF THE MOTHS *LYCIA (BISTON) HIRTARIA* AND *ITHYSIA (NYSSIA) ZONARIA*, AND IN THEIR HYBRIDS.

By L. DONCASTER, Sc.D.,

Fellow of King's College, Cambridge.

The work of which this paper gives a preliminary account was undertaken to find out, if possible, any cytological cause for the fact that reciprocal crosses of *Lycia (Biston) hirtaria* and *Ithysia (Nyssia) zonaria* give different results as regards the sexes of the offspring. Mr J. W. H. Harrison, who very kindly supplied me with the hybrid material used, has described the results of the two crosses, together with other hybrids, between species of the same genera. For the present purpose the important facts are that the cross *zonaria* ♀ × *hirtaria* ♂ produces only male offspring, resembling *zonaria* somewhat more nearly than *hirtaria*; *hirtaria* ♀ × *zonaria* ♂ gives both sexes, with a conspicuous excess of females (more than 2 ♀♀ : 1 ♂). The males of this second cross are not strikingly different from those of the converse cross; the females are remarkable in having small flightless wings. (Plate XVII.) The wings of the *hirtaria* ♀ are of normal size and are capable of flight; those of *zonaria* are vestigial, so that in this respect the hybrid is intermediate¹.

Although the observations which I have been able to make on the small supply of material hitherto available have not led to very satisfactory results with regard to cause of the difference in sex-determination in the reciprocal crosses, the general behaviour of the chromosomes in the gametogenesis of the hybrids is so remarkable that I think it worth while to publish an account of it at once. The chromosomes of the two species are very different from one another, and in the hybrids most of the chromosomes derived from each parent can be recognised at a glance.

¹ It should be noted that the reduction of the wings, which is a secondary sexual character of *zonaria*, is transmitted by the *zonaria* male.

Further, in the maturation divisions, as was found by Federley in hybrids of species of *Pygaera*¹, most of the chromosomes are unpaired and divided singly, so that the spermatocyte divisions have nearly as many as the spermatogonia and oogonia, but my results differ from those of Federley in the fact that a few of the *hirtaria* chromosomes pair with some derived from the *zonaria* parent, and that there is a distinct synapsis stage in the prophases of the maturation divisions. The methods of preservation, etc., employed were the same as those described in my papers on gametogenesis of *Abraeus*, with the exception that the gonads were dissected out in water, which I have found, since those papers were written, to give better results than Ringer's fluid. The material of the pure species was obtained from quite young pupae purchased from Mr L. W. Newman; that of the hybrids, from larvae and pupae given me by Mr Harrison.

1. The chromosomes of *L. (B.) hirtaria*.

(a) *Oogenesis*. I have very few satisfactory figures of the oogonial divisions, but there seems to be little doubt that the chromosome number is 28. Plate XVIII, fig. 2 shows an oogonial equatorial plate, with 28 chromosomes varying considerably in size, and including six which are noticeably smaller than the remainder. I have one figure in which in addition to a similar group of 28, there is a body just outside the circle which might be a chromosome. I am inclined to believe that it is not a chromosome, but an extra-nuclear body (fig. 1).

A typical synapsis stage succeeds the last oogonial divisions, followed by a growth phase of the oocytes in which a relatively small number of fairly thick threads form a spireme. As the oocytes enlarge, these threads shorten in the usual way, and become faintly double, and by the time they have become elongated rods about thirteen can be counted (fig. 3). They then contract still further to double, or often faintly quadruple, bodies, of which again about thirteen may be counted. Meanwhile a chromatin-nucleolus has been conspicuous, and still remains much more sharply defined than the other chromosomes. It is compound, and in the many figures is seen to be composed of four parts, two small and two larger. The latter are frequently seen to be unequal in size. If the chromatin-nucleolus may be regarded, as in other forms, as a "sex-chromosome" there is thus perhaps an indication of its being unequally paired. There is no regularity, however, in its appearance; the parts may be together or widely separated, and are sometimes seen

¹ H. Federley, *Zeitschr. f. indukt. Abstamm. und Vererbungslehre*, ix. 1913, p. 1.

themselves to be composed of smaller units which show various degrees of separation. The counting of the double rods is not quite easy; usually thirteen seem to be present, but in some cases I cannot find more than twelve. If, as seems probable, there are thirteen, the larger and smaller members of the chromosome-nucleolus cannot consist of a large and small pair of united chromosomes, as occurs in the spermatogenesis (see below). Seiler has described the "sex-chromosome" in the female of the moth *Phragmatobia fuliginosa* as being double¹, and the doubleness of the chromatin-nucleolus seen in *hirtaria* may perhaps be due to the same cause. As I have not investigated the polar divisions of the eggs, I cannot test the truth of this suggestion.

(b) *Spermatogenesis.* I have a number of clear figures of the spermatogonial divisions, and as in those of the oogonia there are clearly 28 chromosomes, of which six are smaller than the rest, and four of these conspicuously smaller (fig. 4). In the growth-stages of the spermatocytes a typical synapsis of the spireme occurs. As in other Lepidoptera, the stages are less easy to arrange in order than in the ovaries, but there is no doubt that a thin spireme thread, closely withdrawn to one side of the nucleus, is succeeded by a thicker and looser spireme (figs. 5, 6), and this by a reticulum, from which the double chromosomes of the first spermatocyte division arise by a process of concentration.

In the younger spermatocytes there are usually two chromatin-nucleoli; in the older ones commonly four, two larger and two small. These may be united so as to give three or two, a large one commonly being paired with a small one. I cannot find any constant difference in size between the two pairs; one of the larger or of the smaller is sometimes of greater size than its fellow, but this does not seem to be regular. The stages in which the chromatin threads contract into chromosomes are so confused that I am unable to count them, or in many cases even to distinguish the chromatin-nucleolus from the other chromosomes.

The primary spermatocyte divisions are usually extremely clear and diagrammatic, but are somewhat difficult to interpret, for in place of the 14 chromosomes which one would expect they constantly have only 13. Careful inspection, however, shows that one of the largest is compound, and consists of a large chromosome to which a very small one is attached (figs. 7, 8). That the large one is double (i.e. composed of an equally matched pair) is often quite clear, but the small one attached to it

¹ J. Seiler, *Zool. Anzeiger*, xli. 1913, p. 246.

usually shows no sign of doubleness, and on the spindle when seen sideways it sometimes appears to be attached to one half only of the large one, as if it were going entire to one pole of the spindle. This, however, appears to be exceptional; the compound chromosome is usually recognisable only with difficulty in side view (fig. 9, *a, b, c*). If it were the case that the small chromosome went undivided to one pole like a heterochromosome, the second spermatocyte equatorial plates should be of two kinds of equal frequency; half of them should have thirteen, and half either fourteen, or thirteen of which one should be compound. All these conditions in fact are found, but the great majority have thirteen of which one may be more or less clearly composed of a large and small member attached to each other with varying degrees of closeness. In some, perhaps the majority, only thirteen apparently simple chromosomes are visible; in others a large one clearly has a small one attached to it, and in a few fourteen separate chromosomes may be counted (figs. 11, 12, 13). In one of the latter class of figures, the largest chromosome has clear indications of being compound although there are thirteen separate chromosomes in addition to it, an arrangement which is undoubtedly abnormal (fig. 14).

Usually there are two chromosomes, in addition to the small member of the compound one, which are conspicuously smaller than the rest, but, probably according to the depth of staining and the position of the chromosomes on the spindle, there is some variation, so that only one, or sometimes three small ones, may be visible. It is thus not easy to identify any one chromosome with confidence, but when fourteen are visible, one very small one is usually, if not always, in close proximity to one of the largest. It is clear from this account that equatorial plates of the second spermatocyte divisions do not make it quite certain whether one chromosome goes over undivided in the first division or not. Unfortunately I have found only one case of a first division anaphase in which the chromosomes of both groups can be counted (fig. 10), and this is not entirely unequivocal. In each group there are thirteen chromosomes, one of which shows signs of being composed of a larger and smaller unit in each group. This would indicate that the double chromosome divides equally, a large and a small portion going to each pole. In one group, however, there is a body outside the group, and at a different level in the section, which might possibly be a chromosome. It is nearer the pole than the group of thirteen, and I am fairly confident that it is not a chromosome but an extra-nuclear body. Such occur regularly in the spermatocyte cells.

Although, therefore, there are some appearances which suggest the presence of a heterotropic chromosome in the male, I am inclined to believe that these are deceptive, and that one of the smallest chromosome pairs constantly unites with one of the largest in the first spermatocyte division, and divides normally, but that the closeness of the union varies in different cases in the second division, so that sometimes thirteen, sometimes fourteen, appear to be present.

2. The chromosomes of *Nyssia (Ithysia) zonaria*.

(a) *Spermatogenesis*. A glance at a spermatogonial equatorial plate shows at once that the chromosomes are very unlike those of *L. (B.) hirtaria*. Instead of 28 rather large chromosomes, there are a very large number of extremely small ones. I have found no figure in which they can be counted with accuracy; they tend to come into contact and one can only make out with confidence that there are over 100 (fig. 15).

The synapsis and growth phases are closely similar to those of *hirtaria*, except that the "bouquet" stage (fig. 16) is less typical; as in that species there are sometimes four chromatin-nucleoli, consisting of a larger and smaller pair, but more frequently these are united to form three or two. They are very nearly of the same size as those of *hirtaria*. The prophases of the first spermatocyte division are clearer than in *hirtaria* owing to the much smaller size of the chromosomes, and it can be seen that the chromatin-nucleoli approach one another more and more closely, and finally unite into a single rounded mass in which no division can be seen.

The primary spermatocyte divisions show equatorial plates of really surprising beauty and perfection (fig. 17). The chromosomes lie absolutely in one plane, and widely separated from one another, so that there is not the smallest difficulty in counting 56 with complete certainty. Of these, two are noticeably larger than the rest, and usually two others intermediate in size. The number 56 is so clearly and certainly shown, that one may conclude with confidence that the spermatogonial (diploid) number is 112, that is to say, four times that of *hirtaria* (28). The largest chromosomes of *zonaria* are of about the same size as, or possibly even smaller than, the smallest of *hirtaria*. In metaphase and anaphase it is seen that each chromosome is dividing in the normal "heterotype" manner, the diverging halves being connected by double strands, and I can find no evidence of unequal division, nor of the union of two pairs, such as occurs in *hirtaria*.

The second spermatocyte division resembles the first very closely, except that the chromosomes are half the size; 56 can easily be counted, of which four are larger than the others (fig. 18).

Some follicles of both *zonaria* and *hirtaria* have abnormal spermatocyte divisions, leading to spermatozoa without nuclei, as in *Pygaster*, *Abraxas*, etc.

(b) *Oogenesis*. My *zonaria* pupae were too old to give satisfactory observations on the oogenesis. The ovaries were already large, with eggs at the lower end of the tubes in which a considerable amount of yolk had been deposited, so that the tubes were becoming moniliform. I have found no diploid mitotic figures in which the chromosomes can be counted accurately. The younger oocytes at the top of the tube had already undergone synapsis, and were in the stage with the chromosomes arranged under the nuclear membrane. Completely accurate counts of this stage are scarcely possible when the chromosomes are numerous; it can only be said that there are between 50 and 60 small double chromosomes, and a composite chromatin-nucleolus of which the two largest portions are almost always of recognisably unequal size.

3. Chromosomes of the Hybrids.

(a) *Zonaria* ♀ × *hirtaria* ♂. This cross gives only male offspring. My material consists of testes of two larvae shortly before pupation, and of one pupa about three weeks old. The larval testes contain no divisions later than the spermatogonia; the pupal testis has also first and second spermatocyte divisions, and contains spermatids in an advanced stage of development towards spermatozoa.

The spermatogonial equatorial plates show at a glance two kinds of chromosomes—comparatively few large ones intermingled with a much larger number of small ones.

A count of a very good figure (fig. 19) gives 55—57 small and 14 large; although this cannot be regarded as absolutely accurate, the error certainly does not amount to more than two or three small chromosomes at most. The theoretical expectation is 70, so that it may be assumed that complete haploid sets of *hirtaria* and *zonaria* chromosomes are present.

The spermatogonial divisions are succeeded by a stage in which a thin spireme is contracted to one side of the nucleus, after which the thread thickens somewhat and becomes reticular, but the typical "bouquet" stage (pachynema), which is found in pure *hirtaria* and less

typically in *zonaria*, seems not to occur (figs. 20, 21). In the mature spermatocyte there are either one or two chromatin-nucleoli which are clearly compound; the parts show less tendency to become separate than in either of the pure species.

Federley, in his work on hybrids between species of *Pygaera*, found no synapsis (synizesis) stage in the hybrids; in the present case, although most of the chromosomes fail to pair, so that there is almost the diploid number in the spermatocyte divisions, there is no important difference between the spermatocytes in the earliest growth stage of the hybrids and those of the parent species. The fact, however, that I have found no "bouquet stage" with thick thread still contracted to one side of the nucleus, is probably to be correlated with the fact that most of the chromosomes fail to pair. Federley's failure to find any synapsis (synizesis) in *Pygaera* hybrids may possibly be due to his material being too old. In the present case I find such a stage very frequently in larval testes, but not in pupal testes about a month older, in which the majority of the follicles contain advanced spermatocytes, and the earlier stages are scarce. The various stages seem to overlap less in the hybrids than in the pure species.

The spermatocyte division figures are very remarkable, and are not conspicuously different from those of the spermatogonia. I have a number of very perfect figures, and in all it is quite clear that the chromosomes are nearly in the somatic number (figs. 22, 23), as was found by Federley in his hybrids with *Pygaera* spp. Careful counts show, however, that the full somatic number is not present, and that some pairing of chromosomes has taken place. It is not easy to draw the line quite clearly between the large and small chromosomes, for as was said above the larger *zonaria* are similar in size to some of the smaller of *hirtaria*. In the first spermatocyte equatorial plate there are always about 12 or 13 which are certainly larger than all the rest, and most of these may be regarded as *hirtaria* chromosomes. The number of small ones is commonly about 50; careful counts have given 50, 50 or 51, and 51 or 52, in the three best figures I can find. Another fair figure (slightly oblique, fig. 23) in which I cannot find that any chromosomes are omitted from the section, gives 13 large and about 40 small, and others have given intermediate numbers; it is possible that some are covered by others, but it is unlikely that so many would disappear in this way, and probably the smaller number may be due to the fact that more chromosomes find mates in some cases than in others. There seems no doubt that the total does not amount to the theoretical number

of 69 or 70 (56 + 13 or 14) which would be expected if no pairing of chromosomes took place at all. This is further confirmed by the fact that there are constantly 12—14 large ones. *Hirtaria* spermatocytes have eleven large and two small, and the largest of *zonaria* are hardly big enough to be classed in the "large" group. If, however, the larger of the *zonaria* chromosomes paired with the smaller of the *hirtaria* chromosomes, these would make additional large ones in the hybrid spermatocyte equatorial plate. Several, in fact, often appear to be double, and as the number in the best figures adds up to 65, it may be concluded that about five *zonaria* chromosomes (probably the largest) pair with five derived from *hirtaria*, while most of the rest remain unpaired. An examination of the prophase figures of the first spermatocytes just before the nuclear membrane disappears, shows, in addition to several clumps of three or more chromosomes together, a large number of single chromosomes of various sizes, and among them a few which are paired, either equally or unequally (fig. 24). Further confirmation of the evidence that some of the chromosomes are paired in the first spermatocyte division and that the smaller number counted is not due to error, is found in the fact that almost exactly the full number can be counted in the spermatogonial divisions, which are smaller and less easy to examine accurately than those of the spermatocytes. If it is easy to count very nearly 70 in the spermatogonia, it is hardly possible that the smaller number in the spermatocytes can be due to error.

In the first spermatocyte division, it appears that not all the chromosomes divide. Most undoubtedly do, but some show no signs of division in metaphase when seen from the side of the spindle (fig. 25), and the appearance of the secondary spermatocyte equatorial plates confirms this supposition. The chromosomes in these second division figures are less easy to count with complete accuracy, but it is not difficult to get a fairly close estimate of their number, and this is almost constantly less than in the first division (fig. 26). Counts have given 9 large and 42 small, 9 large and 46 small, 12 large and 42 small. In one case, where I counted 12 large and 52 small, it is almost certain that several had already divided, and that the halves were counted as separate chromosomes.

(b) *Hirtaria* ♀ × *zonaria* ♂. This cross gives a preponderance of females, with some males. The ovaries of full-grown larvae are extremely small and difficult to find, and from the three female larvae sent me by Mr Harrison I only succeeded in getting one ovary.

I allowed one larva to pupate; it was fortunately a male and the testis was preserved about two weeks after pupation.

The single larval ovary is most unfortunately not very well preserved. It contains only one oogonial equatorial plate which is sufficiently in face for the chromosomes to be seen at all clearly, and it is not good enough to provide an accurate count of the chromosomes. It shows, however, a mixture of large and small chromosomes such as I have described in the spermatogonial plates of the converse cross. Other oogonial divisions, which lie more obliquely, also show chromosomes of two very different sizes. Owing to the defective preservation, the development of the oocytes cannot be made out completely. There is a stage with a thin spireme thread massed at one side as in the normal early synapsis stage, and lower down the tube there are larger nuclei with a thicker thread, but I have not found any nuclei in which the thread has segmented into separate chromosomes, such as are found in normal older oocytes. The ovary, however, is so small that this might perhaps not have occurred at this stage of development even if normal synapsis had taken place. Since the development of the chromosomes is much more clearly seen in oocytes than in spermatocytes of Lepidoptera, it is disappointing that in my only ovary the stages required are not represented.

Spermatogenesis. The testis of the single male pupa is large and well developed, and contains all stages up to the spermatids, but no nearly mature spermatozoa such as would probably occur in either of the parent species at the same date. The spermatogonial divisions are like those of the converse cross; I have not been able to make counts which I can regard as completely accurate, but in the equatorial plate from which fig. 27 is taken the chromosomes are clear enough to give some approach to accuracy. I count in this plate 14 large and 55 small; in other plates I have counted only 11 or 12 large, and it is probable that two or three reckoned as large in the group figured are *zonaria* rather than *hirtaria* chromosomes. It is also possible that two or three small ones counted as two are really single ones in division. The number is sufficiently near to the theoretical expectation of 70 to make it almost certain that complete sets from each parent are present.

The early stages of the development of the spermatocytes show quite clearly cells with a fine spireme contracted to one side of the nucleus; it does not differ conspicuously from the corresponding "contraction-phase" of synapsis in the pure species (fig. 28). After this stage the nuclei enlarge considerably, and the thread takes the

form of a reticulum, as in the converse cross (fig. 29). There are usually at this stage two chromatin-nucleoli, each of which is double, with halves which are slightly unequal; the parts of one or both may become separate, so as to produce three or four distinct masses.

The testis includes good equatorial plates of both first and second spermatocyte divisions. Counts of first division figures have given numbers ranging from 52 to 60 chromosomes (figs. 30, 31); in those with the higher numbers it is possible that one or two dividing pairs have been counted as two singles in each case. There seems no doubt that the total number is not more than 60, and usually several less, and as in some figures as many as 18 have been reckoned as large, it is practically certain that a considerable amount of pairing has taken place, since only about eleven large ones are introduced from the *hirtaria* parent, and the remaining large ones must be formed of pairs of small ones. This is confirmed by the second spermatocyte divisions, in which only about 10 large ones are counted; the small chromosomes in this division are so small as to be counted with difficulty, but the total of second equatorial plates is clearly not far from 50, made up of about 10 large and 40 small (fig. 32). It is probable, therefore, that in the cross *hirtaria* ♀ × *zonaria* ♂ more chromosomes find mates in the maturation divisions than in the converse cross, in which over 60 are usually present in the first spermatocyte divisions, but as a lower number was found in some equatorial plates of this cross, it is probable that the number which pair varies somewhat in different cells.

Conclusions and Discussion.

The general conclusions which may be drawn from the observations described are then as follows: (1) there are 28 somatic chromosomes in *hirtaria*, giving 13, of which one consists of a large united to a small, in the spermatocytes. (2) There are 112 somatic and 56 spermatocyte chromosomes in *zonaria* which are much smaller than most of those of *hirtaria*. (3) The spermatogonial number of the hybrids, whichever way the cross is made, is as nearly as can be counted 70, of which fourteen are conspicuously larger, and of these twelve are derived from the *hirtaria* parent, the other two from *zonaria*. (4) The early synapsis stage of the spireme in the young spermatocytes and oocytes of the hybrids does not differ greatly from that of the pure species, but it is apparently not followed by a normal pachytene ("bouquet") stage with thick coiled thread. (5) Comparatively few of the chromosomes are

paired in the spermatocyte divisions, so that these have only from 5 to 15 fewer than the somatic number. It is quite clear, however, that some chromosomes, the number of which is small and probably somewhat variable, do find mates in the maturation divisions, and that there are probably homologous chromosomes in the two species which pair together, while the remainder are unable to do so.

I do not propose to discuss at length the observations of which only a condensed account has been given, firstly because to a considerable extent they are similar to those of Federley, and he has discussed the questions raised at considerable length; and secondly because I hope next year to complete the investigation on additional material of the same and other species, which should make a fuller understanding of the problems possible. There are, however, a few points which seem to require comment.

The chief points of interest are (1) the difference in chromosome number in nearly related species, and the behaviour of the chromosomes in the hybrids, and (2) the possible causes of the fact that the cross *zonaria* ♀ × *hirtaria* ♂ gives only male offspring, while the converse cross gives both sexes with excess of females.

In the former group of phenomena we have important data on the vexed question of the individuality of the chromosomes. Since there are exactly four times as many chromosomes in *zonaria* as in *hirtaria*, and since the *zonaria* chromosomes are so much smaller that the total amount of chromatin, as judged by the size of the resting nuclei, is approximately equal in the two species, it seems a fair inference to suppose that the *hirtaria* chromosomes may be regarded as compound, made up of units corresponding with the separate chromosomes of *zonaria*. Since however there are large and small chromosomes in *hirtaria*, and some in *zonaria* which are noticeably larger than the rest, it is probable that not every *hirtaria* chromosome is made up of four parts each of which corresponds with one *zonaria* chromosome, but that the larger *hirtaria* chromosomes are made up of more than four units, and the smallest ones are probably single. That is to say, if there are 56 units in the haploid group of *zonaria*, there are the same number of units in *hirtaria*, but these are combined with one another in various ways so that only 14 (or 13) chromosomes appear. For example, if the 56 haploid *zonaria* chromosomes are taken as units, the haploid set of *hirtaria* might be made up of four chromosomes each composed of six units, five of five, one of four, and three of one unit each. The total 56 is thus made up ($4 \times 6 + 5 \times 5 + 1 \times 4 + 3 \times 1$). This is of course not

the only possible arrangement; I give it merely as an illustration of the way in which I regard the *hirtaria* chromosomes as perhaps being composed of a variable number of units each corresponding with one *zonaria* chromosome. It is of course probable, if the *hirtaria* chromosomes are compound, that those of *zonaria* are so also, and that the true "unit," whatever that may be, is smaller than either. Meek¹ has shown that the chromosome lengths in various species of insects and other animals are terms of an arithmetical series, as if they were composed of units of standard length, and the comparison of *hirtaria* with *zonaria* leads by a different route to a somewhat similar conclusion.

Another aspect of the individuality question is touched by the phenomena of the maturation divisions of the hybrids. I have shown that although the majority of the chromosomes fail to pair in synapsis, it is certain that some of them do so. The number of those which pair is sometimes not more than ten (five pairs), giving a maximum number of 65 in first spermatocyte equatorial plates in the cross *zonaria* ♀ × *hirtaria* ♂; in other cases, especially in the converse cross, the number of pairs appears sometimes at least to be larger. If I am right in suggesting that about three of the small *hirtaria* chromosomes correspond with single *zonaria* units, we might expect these to pair normally together, and the indications of occasional unequal pairing suggest that some of the compound *hirtaria* chromosomes may pair also, perhaps less regularly, with *zonaria* units. This would lead to the conclusion, not that chromosomes are individuals in the sense of being indivisible units, but that they are composed of units, and that pairing in synapsis is due to some affinity between chromosomes made up of similar components. This is of course the hypothesis which has been widely accepted on evidence of a different kind, in connexion with the hypothesis that the chromosomes are the bearers of Mendelian unit characters.

If there is any truth in this view, it may give some clue to the baffling problem of interspecific sterility. The *hirtaria*—*zonaria* hybrids are completely sterile. If the haploid set of 56 chromosomes of *zonaria* consists on the whole of the same units as the 14 haploid chromosomes of *hirtaria*, combined in different ways, the sterility between the two nearly allied species may have arisen simply from a difference of grouping. Since the units are grouped differently, the chromosomes cannot pair properly in synapsis, and this may be the cause of the

¹ C. F. U. Meek, "A metrical analysis of chromosome complexes, etc.," *Phil. Trans. Roy. Soc.* Vol. B. 203, p. 1, 1912.

sterility. It is true that Federley's *Pygaera* hybrids were not sterile, but that may be because little or no pairing took place, so that the resulting gametes would be less abnormal than in a case where some chromosomes pair and others do not.

The second point mentioned at the beginning of this discussion was the one which led in the first instance to my undertaking the work—the possible cause of the fact that only males are produced from the cross *zonaria* ♀ × *hirtaria* ♂. Similar results have been obtained with other species by various observers, notably the cross *Tephrosia bistortata* ♀ × *T. crepuscularia* ♂ described by Tutt¹. Brake and Goldschmidt's observations on *Lymantria dispar* and *L. japonica* may also be compared, in which they find that *dispar* ♀ × *japonica* ♂ gives males and gynandromorphs, although the converse cross gives normal males and females². As Mr Harrison has shown, true hermaphrodites occur in certain crosses with the genus *Biston*, but not with those used in the present case.

My observations on the chromosomes do not yet give any conclusive results with regard to the cause of these sex-phenomena, but there are certain indications which perhaps deserve mention. It is probable that in Lepidoptera there are two similar "sex-chromosomes" in the male, and that one of these differs from the other, and may be regarded as lacking the male determiner, in the female. This has been suggested on the ground of the facts of sex-limited inheritance (*Abraxas*); the suggestion is supported, though not proved, by the observations of Seiler, of which only a preliminary account has been published³; and I have obtained additional evidence for it from a study of the chromosomes in a strain of *Abraxas* which in each generation produces families consisting only of females. In a first account of this work⁴ I have shown that females of this strain have 55 instead of 56 chromosomes, and further work, an account of which I hope will be published shortly, confirms this observation, and shows that all spermatozoa have 28 chromosomes, while eggs have either 28 or 27.

In *B. hirtaria*, although there is no certain indication as to which chromosome is the "sex-chromosome," I think it may be assumed with some probability that it is one of the larger ones. One of the largest is always coupled with a small one in the first spermatocytes and such

¹ J. W. Tutt, *Trans. Entom. Soc.* 1898, p. 17.

² R. Goldschmidt, *Zeitschr. f. indukt. Abstamm.* VII. 1912, p. 1.

³ E. Seiler, *Zool. Anz.* XLI. 1913, p. 246.

⁴ *Journ. of Genetics*, III. 1913, p. 1.

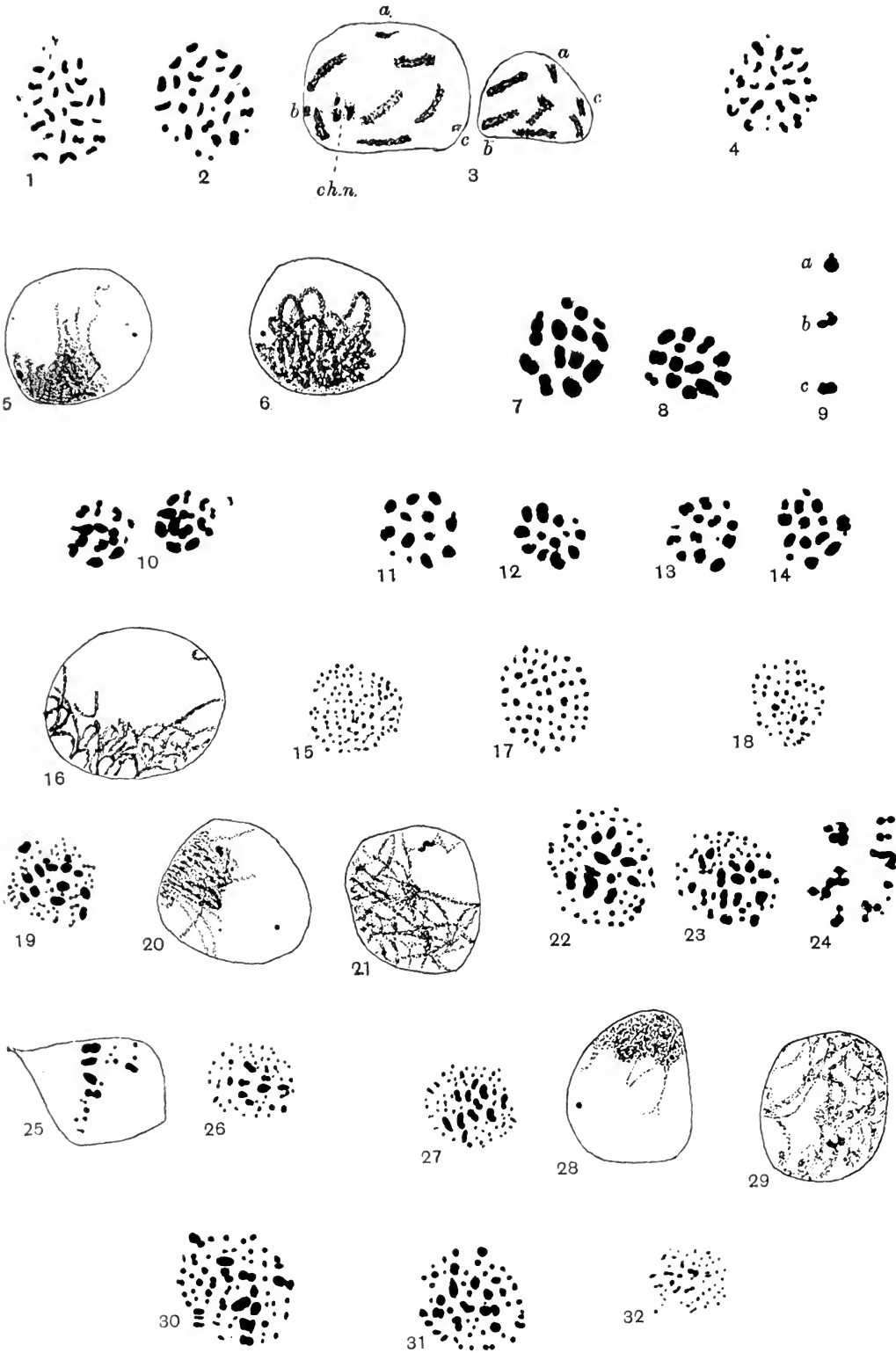

coupling has frequently been described in connexion with heterochromosomes or "sex-chromosomes"; the size of the chromatin-nucleolus also indicates that it would give rise to one of the larger chromosomes. Now all the larger chromosomes of *hirtaria* are of greater size than any of *zonaria*, so that if the size of the sex-chromosome is any indication of its intensity of action, it is probable that in the cross *zonaria* ♀ × *hirtaria* ♂, in which all the spermatozoa have the large male-determining chromosome of *hirtaria*, all the zygotes might receive a sufficient quantity of the male-determining substance to cause them to become male, whether they received any from the female parent or not. In the converse cross, only half the eggs would receive a male sex-determiner from the *hirtaria* ♀, and therefore both males and females would be produced.

This suggestion does not differ essentially from that used by Goldschmidt to explain the results obtained with *Lymantria dispar* and *L. japonica*, the essence of which is that the "potency" of the sex-determiner may be different in different species. It is founded, however, on observations on the size of the chromosomes rather than on the simple results of breeding experiments. It is admittedly very hypothetical, and does not explain the excess of females which seems constantly to occur in the cross *hirtaria* ♀ × *zonaria* ♂. I hope to be able next season not only to amplify my work on the species used this year, but also to examine other crosses which give comparable results, and to confirm or disprove the hypothesis suggested by observations on ampler and more varied material.

EXPLANATION OF FIGURES.

PLATE XVIII.

All the figures were drawn free-hand, with a Zeiss 3 mm. 1·40 ap. immersion objective and Compens. oc. 12.

[N.B. In Figs. 19, 22, 23, 26, 27, 30, 31, 32 the reproduction has made some small chromosomes appear in contact which in the original were near together but quite distinctly separate.]

Figs. 1—14. *B. hirtaria*.

Figs. 1, 2. *B. hirtaria* oogonial equatorial plates. 28 chromosomes in each, if the small body at the top of Fig. 1 is not a chromosome. There are in each four very small and two rather small chromosomes.

Fig. 3. Oocyte nucleus, cut in two sections. Three chromosomes are cut in both sections (lettered *a*, *b*, *c* in each). Thirteen elongated chromosomes showing traces of doubleness, and compound chromatin-nucleolus (*ch.n.*).

Fig. 4. Spermatogonial equatorial plate. Four very small and two rather small chromosomes. Total 28.

- Fig. 5. Early synapsis stage; fine thread withdrawn to one side of nucleus.
- Fig. 6. Later synapsis (bouquet or pachytene stage), with coiled thick thread.
- Figs. 7, 8. Primary spermatocyte equatorial plates. 13 chromosomes, of which one consists of a large coupled with a small (left upper side in Fig. 7, right lower in Fig. 8).
- Fig. 9, *a, b, c*. The compound chromosome in side view. In *b* the small member appears not to be dividing; more commonly in metaphase all the large chromosomes appear like *c*.
- Fig. 10. Primary spermatocyte anaphase; two daughter groups, cut in successive sections. In the left group there are 13, one of which is compound; in the right group there are 13 with a stained body outside the circle which is probably not a chromosome.
- Figs. 11—14. Secondary spermatocyte equatorial plates. In Fig. 11 there are 13, one of which is clearly compound; in Fig. 12, none is obviously compound; in Fig. 13 the small member is quite separate from the large; Fig. 14 an abnormal figure in which there are 14, one of which is compound.
- Figs. 15, 16, 17, 18. *B. zonaria*.
- Fig. 15. Spermatogonial equatorial plate. The chromosomes are so small and crowded that an exact count is impossible. There are more than 100 and less than 120.
- Fig. 16. Pachytene stage of spermatocyte. The thread is thinner than in *hirtaria*, and takes a less typical "bouquet" form.
- Fig. 17. Primary spermatocyte equatorial plate. 56 chromosomes quite clearly, of which four are larger than the rest.
- Fig. 18. Secondary spermatocyte equatorial plate. 56 chromosomes, of which four are larger.
- Figs. 19—26. Hybrid, *zonaria* ♀ × *hirtaria* ♂. (This cross yields only males.)
- Fig. 19. Spermatogonial equatorial plate. 14 large chromosomes and about 56 small.
- Fig. 20. Early synapsis.
- Fig. 21. Thread becoming reticular, apparently omitting the bouquet stage.
- Figs. 22, 23. Primary spermatocyte equatorial plates. In Fig. 22, 12 or 13 large and 50 or 51 small; in Fig. 23, 13 large and about 40 small; several of the latter are of intermediate size, as if consisting of pairs.
- Fig. 24. Typical chromosomes from primary spermatocyte prophase, showing single, equally paired, unequally paired and grouped chromosomes.
- Fig. 25. Outline of part of primary spermatocyte spindle in side view, showing some chromosomes dividing, others apparently not.
- Fig. 26. Secondary spermatocyte equatorial plate—about 9 large and 46 small.
- Figs. 27—32. Hybrid, *hirtaria* ♀ × *zonaria* ♂. (This cross gives females and males.)
- Fig. 27. Spermatogonial equatorial plate. About 14 large and 55 small chromosomes.
- Figs. 28, 29. Early and later synapsis stages, corresponding to Figs. 20 and 21 of the converse cross.
- Figs. 30, 31. Primary spermatocyte equatorial plates. In Fig. 30 about 11 large, 8 or 9 intermediate, and about 40 small; in Fig. 31, 11 large and 42 intermediate and small.
- Fig. 32. Secondary spermatocyte equatorial plate. About 9 large and 41 small.

ON THE RELATIVE LENGTHS OF THE FIRST AND SECOND TOES OF THE HUMAN FOOT, FROM THE POINT OF VIEW OF OCCURRENCE, ANATOMY AND HEREDITY.

BY ONERA A. MERRITT HAWKES, M.Sc., B.Sc.

CONTENTS.

	PAGE
1. The Study of the Foot in the Living Subject	249
2. The Study of the Foot of the Foetus	257
3. The Relation of the Toe-types to the Anatomy of the Foot	258
4. The Inheritance of Toe-types	264
5. Summary of General Conclusions	272
Description of Plates	272
Literature	273

I. *The Study of the Foot in the Living Subject.*

THE following research was undertaken in the hope of discovering the method of inheritance of two types of feet which were known to occur commonly in England. As might be expected, however, the work branched off into a study of the anatomy of the foot, and into an enquiry into the percentages of these types of feet in the population.

An examination of the living feet of adults and of children, soon showed the existence of three types, of which two only are common. These types are represented diagrammatically in Fig. 1, and photos of three of the types are shown in Plate XIX.

These types are :

1. (Figs. 1 and 2, 1) in which the first or great toe projects beyond all the others, so that the outline of the toes is a comparatively straight line. This type will be referred to as *L* (long great toe). Park Harrison (1885) stated as a result of examining only 120 persons, that

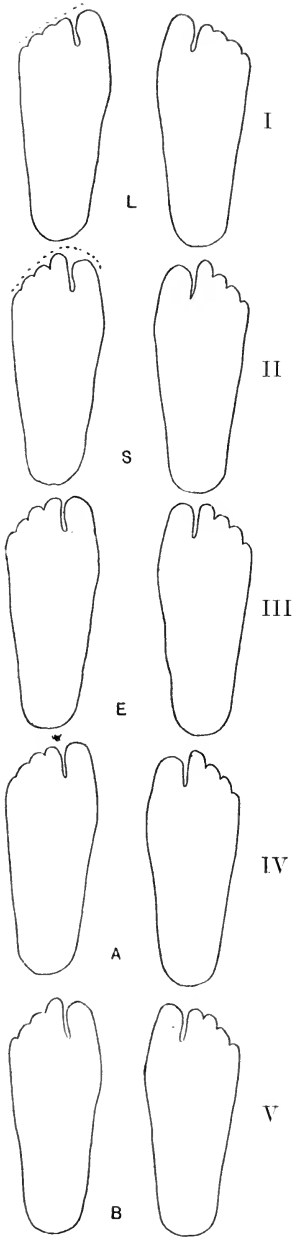

Fig. 1. Diagrammatic Drawings to show Toe-types.

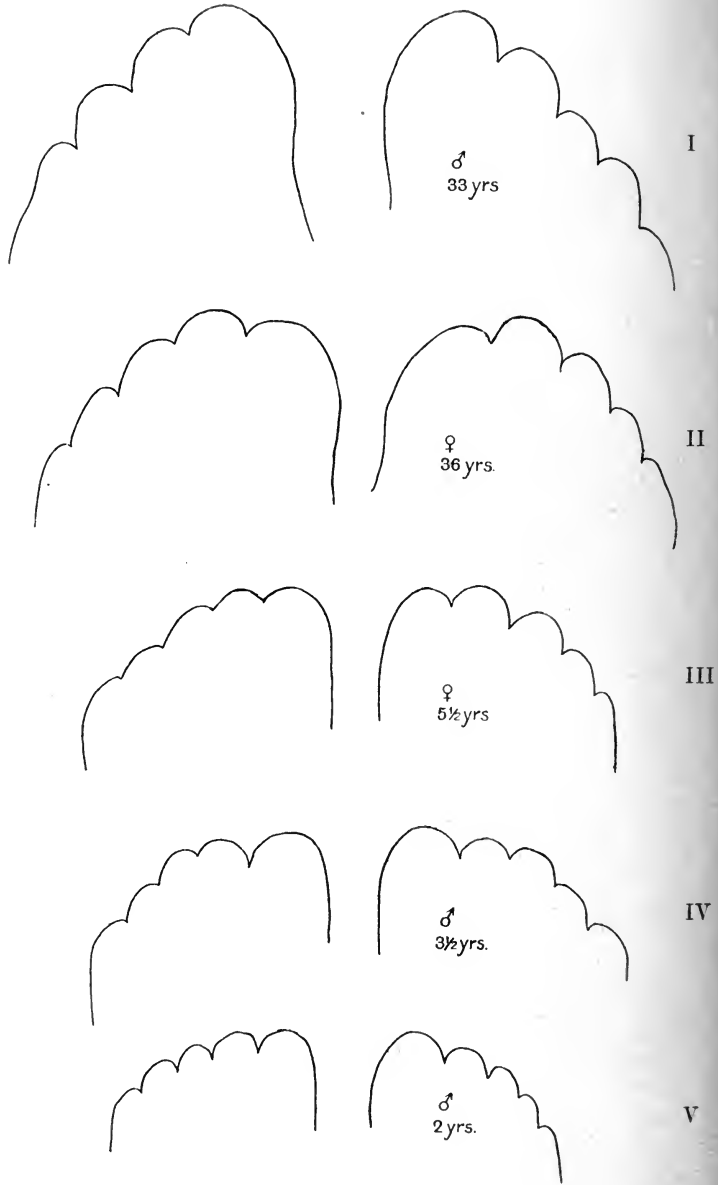

Fig. 2. Toe-tracings made by method described on page 255. Photos of these feet are found on Plate XIX and Radiographs on Plates XX and XXI.

the *L* type was the commonest and his results are confirmed by my examination of over 2000 persons. Pfitzner (1901 et seq.) and Weissenberg (1895) found this the commonest type in Germany.

2. (Figs. 1 and 2, II) in which the second toe protrudes not only beyond the 3rd, 4th and 5th toes, but also beyond the first. Hence the outline in this case is an arc. This type of foot will be called *S* (short great toe). It is much less common than the *L* type: but, in spite of this, it occurs constantly in ancient and modern statues and in nearly all pictures, although usually in an exaggerated form.

3. (Fig. 1, III) in which the first and second toes are of the same length but longer than toes 3, 4 and 5. This type is called *E*. Even a superficial observer would gather the impression that this type seldom occurs and careful observation shows it to be very unusual.

The feet of the same individual are usually of the same type, but not very rarely one foot may be *L* and the other *S*. For convenience the combination of right *S* and left *L* is called *A* (Figs. 1, IV and 2, III), and left *S* and right *L* is called *B* (Fig. 1, V). Combinations of *E* with another type have not been met with.

The analysis was made as the result of examining 2301 persons, 1461 males and 840 females, found in 22 institutes and schools. (See Table II.)

It was desirable to see the feet of adults as well as of children, but as adults are curiously unwilling to show their feet, I was obliged very largely to confine myself to persons under 18. This limitation, however, need not invalidate the results, for, as will be seen, the proportions are not materially changed with increasing age.

TABLE I.

(Taken in a simplified form from Weissenberg (1895), Table VII, p. 98.)

Age ..	5 to 10		11 to 20		21 to 30		31 and over	
Number of Persons ..	198		552		160		99	
	Percentage		Percentage		Percentage		Percentage	
Right foot:								
I > II	137	69.2	350	63.4	93	58.1	67	67.7
I < II	56	28.3	164	29.7	58	36.3	27	27.3
I = II	5	2.5	38	6.9	9	5.6	5	5.0
Left foot:								
I > II	135	68.2	361	65.4	96	60.0	67	67.7
I < II	58	29.3	155	28.1	56	35.0	28	28.3
I = II	5	2.5	36	6.5	8	5.0	4	4.0

Weissenberg (1895) analysed, as shown in Table I, the feet of 1009 Jewish children and adults and found that there was no measurable

TABLE II.

Type of Toes	Age	L		S		A		B		B		Totals
		Male	Female	Male	Female	Male	Female	Male	Female	Male	Female	
School in Birmingham...	8-13	66	23	11	8	8	—	—	—	—	—	116
"	8-13	45	43	17	10	2	4	4	1	—	—	127
"	7-13	48	19	4	11	5	4	1	—	—	—	93
Women at Hospital	over 21	—	5	—	7	—	4	—	—	—	—	16
Boys at Hospital	8-10	5	—	—	—	—	—	—	—	—	—	5
Various adults	over 21	4	5	—	2	1	1	—	1	—	—	14
Women at College	19-21	—	8	—	6	—	—	—	1	—	—	15
Factory Girls	14-17	—	16	—	4	—	1	—	2	—	—	23
Blind Institute	8-15	12	16	1	1	2	1	—	—	—	—	33
Various children	5-9	2	7	1	—	—	—	—	—	—	—	10
Two Board Schools	7-13	284	296	18	29	28	20	4	5	—	—	684
Children in Crèche	2-3	4	3	1	3	1	—	—	—	—	—	12
Blind Asylum	6-14	52	39	2	1	1	1	—	2	—	—	98
Rescue Home	16-20	—	13	—	—	—	—	—	—	—	—	13
Feeble-minded Home	8-16	105	5	8	—	7	1	1	—	—	—	127
Orphanage	7-15	95	82	2	7	5	6	1	1	—	—	199
Industrial Home	8-14	121	—	1	—	2	—	—	—	—	—	124
Rescue Home	8-16	56	30	—	2	1	1	—	—	—	—	90
Orphanage	4-17	97	78	2	2	1	—	1	—	—	—	181
Orphanage	2-14	211	—	3	—	1	—	2	—	1	—	218
Industrial Home	8-17	96	—	1	—	5	—	1	—	—	—	103
Total Number	...	1303	688	72	93	70	44	15	13	1	2	2301
Percentages	...	89.117	81.93	4.928	11.07	4.79	5.23	1.02	1.54	.068	.23	1461 ♂ 840 ♀

An analysis of the types of toe found in above institutions.

variation in the comparative length of the toes, on account of age. But, as the epiphyses unite with the shaft bones of the feet at 17 to 21 years in males and 14 to 18 in females, those ages must be considered adult as regards the feet, so that the female children examined by me were approximately adult. During the last four years I have had 19 children under observation from birth. Six of these babies altered from *A*, *B* or *S* types to *L* during the first two years of life, but in no case did a child obviously an *L* type at birth or slightly later (1 month) change to any of the other types. Never have I found a change of toe-type taking place after two years of age. These observations suggest that the adult condition as regards toe-type is reached by the age of two years. That a change does take place can be seen by comparing the radiograph of a child of one (Fig. 3) with the toe-tracing of the same child at two years (Fig. 2, v). The final position of the bones depends upon the period at which the child walks, the flexed position of the bones being retained in the foetal condition until the foot is flattened by some months of standing and walking.



Fig. 3. Radiograph of child of one year, showing *S* type. (Foot held down by an adult.)

The persons examined may be considered as fairly average of the population, as they came from some schools in Birmingham, two in Lancaster and a number of institutions in the Midlands, in which the children were drawn from all parts of England. The analysis shows the scarcity of all types except *L* and *S*. It is noticeable that there is a distinct sex bias in the *S* type, the females being twice as numerous as the males.

My method of examination was to have the person under observation stand upright with the mesial surfaces of the feet together. I then looked down upon the feet, my eyes being as nearly as possible above the middle of the metatarsal bones. In most cases the toe-type could be easily and rapidly determined, but, in a number of cases, the second toe had to be held flat down during the examination and, in some persons, the first toe had also to be held in its undeformed and primitive position. My method differed little from that of Weissenberg (1895), which he describes thus, "I lay the foot on the ground or on a stool and hold the leg upright, and after laying flat the toes, observe them from above in a line parallel with the *crista tibiae*. This appears to me the correct method of observation, when the sight falls in the middle of the foot."

It must be emphasised that what has been studied is the relative apparent length of the first two toes, or, in other words, the protrusion of one toe beyond the other. When beginning the research it was hoped that not only would the relative protrusion be noted, but that exact measurements of the amount of the protrusion would be obtained. This was abandoned for several reasons. Measurements on the living foot could have been made with considerable accuracy by first arranging the toes in their normal position, but it would have been impossible to take such measurements, as I was only allowed to examine the feet of persons in Institutions after undertaking to spend the minimum of time in the examination. This compelled me to resort to a personal decision as to which toe was the longer. In the great majority of cases the decision is obvious and easy and hence the error from the personal equation is very small.

Owing to the distortion of the average foot (p. 256) measurements were quite impossible from the toe-tracings (Fig. 2, p. 250), upon which the hereditary part of the work depended. A study of even a few family trees indicated that it was the actual protrusion and not the amount of the protrusion which was of fundamental importance and therefore the lack of measurement was not as important as it appeared.

As a problem in genetics the question of the inheritance of toe-type had the interest of being a *normal* human character, whereas most of those previously considered from the Mendelian standpoint have been pathological. I wished to attack the problem simultaneously from three points of view—first, an anatomical study was made by dissection, by examination of skeletons, of living feet of child and adult, the foetal foot and of radiographs; second, statistics were collected as to the percentages of the various types that occurred, and third, a study of family histories was made by means of toe-tracings (Fig. 2). In order to obtain these tracings, 7000 cards were circulated, each card having printed on it, name (not for publication) and in another corner, right foot. With the cards went the following instructions:

“I am doing a piece of research upon the human foot, and I should be very grateful if you would help me by doing as follows:—Place your bare foot on the enclosed card, and with a pencil held upright draw an outline of the toes. Do not draw between the toes. One side is for the right foot, the reverse for the left. Please press the second toe *out well*, until flat, before drawing, as this toe is frequently not flat owing to pressure of boots.

I enclose cards also for each member of your family, parents, brothers, sisters, children and grandchildren.

Please put name on each card and state whether child or adult, male or female.”

There are certain possibilities of error in the drawings: (1) the pencil may not be held in the same upright position throughout the drawing; (2) the second toe may not be pressed out flat; (3) the toe nails may protrude beyond the toes and be of unequal proportional lengths. The paper did not state the point to be studied, so that there could not have been any prejudice in the mind of the recorder: particular directions are given as to how the pencil should be held and there is small likelihood of the position becoming changed in doing the first two toes. That the direction “press the second toe out well” was duly considered, was evidenced by the number of persons who explained that it was difficult or impossible. In some cases, when the outline was blurred or uncertain, it has been repeated and then the subject was requested to note the relative protrusion. As a control over the accuracy of the drawings, 97 persons (over two years of age) were examined after their toe-tracings had been made and amongst these only one error occurred.

The paper circularised probably contains one error, viz. the statement that "the second toe is frequently not flat owing to pressure of boots." That was the idea held when the work was started, but it is not supported by observations on the naked feet of children and adults. It seems probable that the first toe is the only one which is flat in repose, the flexed position being the normal one for the others, which flatten out only when in use. The wearing of boots with a stiff sole has much reduced the use of the toes, so that the tendency is for them to remain in a flexed position, with possibly a consequent small degeneration of the toe muscles. These observations bear a certain relation to those of Pfitzner (1902) on the degeneration of the little or fifth toe. (Plate XXI, Right foot of Fig. III *a*).

As a rule, boots are too narrow for our feet, and there is therefore a lateral pressure which compresses the toes together: but boots are very rarely too short, at any rate among the middle classes, from whose feet these toe-tracings were principally made. The curled up second toe cannot therefore be accounted for as a result of foot-gear, especially as the majority have the first toe longest, and that, because of its very bulk, determines the length of the boot. The chief deformities are due to the unnatural curve of the inner margin of the boot, which presses the great toe outwards and then consequently produces an enlarged joint. There is a considerable difference in deformity between the feet of men and women (Plate XIX, 1, 11), the boots of women being by far the less natural. It is just this lateral displacement that makes the difficulty in judging the living foot and the tracings. Indeed, the toe-type of the tracings can only be determined accurately after an examination of a considerable number of feet, the experience with the living foot acting as a guide in determining the character of the tracings.

Both *S* and *L* types of feet occur among races which have never worn any foot-covering, so that neither the one nor the other type of toe can be exclusively due to the effects of foot-gear. Flower (1881) gives some very bad cases of deformed feet but I have not met any foot whose toes could not be arranged flat except in the case of congenital hammer toe. The few persons who had this deformed condition were not enumerated.

In passing, one may note that Park Harrison (1883) states that the third toe is never longer than the second, but this is certainly not the case as I have found it so in 19 persons. Weissenberg (1895) says "the third toe longer than the second may be hereditary or due to bad boots." How such a condition could arise from the latter cause is

difficult to conceive, but I have a series of tracings which seem to indicate that it is a hereditary character.

Weissenberg (1895) states that the first toe protrudes from 10 to 13 mm., but the second toe seldom more than 5 mm. In these statements I am at one with Weissenberg as regards measurements on 43 persons.

I regret not having been able to work out the relation of toe-type to height.

II. *The Study of the Foot of the Foetus.*

The only age factor of any importance is the foetal period, as shown by an examination of 91 embryos. (Table III.) This table shows that the *S* type is the commoner at this age, as it represents 50 per cent. of the females and 41.3 per cent. of the males. It is interesting to observe that, in spite of the smallness of the numbers, no *L* type appears in females until the fifth month, whilst it is found in males of four months. Perhaps, here too, there is evidence of the female retaining the primitive

TABLE III.

An analysis of the result of examining 91 foetuses.

Female Foetuses			Male Foetuses		
No. of Specimens	Age	Type	No. of Specimens	Age	Type
1	2 months	<i>S</i>	2	2 months	<i>S</i>
4	3 "	<i>S</i>	1	3 "	<i>S</i>
1	4 "	<i>S</i>	2	4 "	<i>S</i>
1	5 "	<i>S</i>	2	4 "	<i>B</i>
1	5 "	<i>L</i>	1	4 "	<i>L</i>
2	6 "	<i>S</i>	1	5 "	<i>S</i>
1	8 "	<i>L</i>	1	5 "	<i>B</i>
1	8 "	<i>S</i>	2	5 "	<i>L</i>
3	7-9 months	<i>A</i>	2	6 "	<i>L</i>
5	7-9 "	<i>B</i>	3	6 "	<i>S</i>
10	7-9 "	<i>S</i>	8	7-9 months	<i>S</i>
9	7-9 "	<i>L</i>	3	7-9 "	<i>B</i>
3	9 months	<i>S</i>	1	7-9 "	<i>A</i>
2	9 "	<i>L</i>	6	7-9 "	<i>L</i>
1	9 "	<i>A</i>	3	9 months	<i>L</i>
			1	9 "	<i>B</i>
			1 pair twins	9 "	<i>A</i>
			1 "	9 "	<i>S</i>
			1 set triplets	9 "	<i>B</i>

45=13 *L*, 23 *S*, 4 *A*, 5 *B*.

46=14 *L*, 19 *S*, 3 *A*, 10 *B*.

character longer than the male. These results by no means agree with the observations of Braune (1884), who stated that the second toe was always the longest in the embryo. Volker (1905) supports this contention when he writes that, "in all its elements as well as in its position, the foot of the new-born child is analogous with that of the monkey." P. Harrison (1883) examined the feet of fifteen foetuses (8 male and 7 female) and found them to be 11 *L*, 3 *E*, 1 *S*. He does not state the ages or the relation of the type to the sex. It would be valuable to have radiographs of foetal feet and babies' feet at intervals from the sixth foetal month to the age of two, thus showing the change from the foetal to the adult condition.

The result of the examination of 14 foetal skeletons is shown in Table IV, from which it appears that there was not one *L* type. This result is probably incorrect as 11 of the 14 are over six months old. The error is probably due to the difficulty of preparing and mounting a foetal skeletal foot, for, to get accurate results as regards the relative lengths of the toes, it would be necessary to retain the foot in the flexed position and certainly not to place it flat on the ground.

TABLE IV.

Skeletons of Foetuses.

No. of Specimens	Age	Type
1	4 months	<i>S</i>
2	5 "	<i>S</i>
3	6 "	<i>S</i>
1	7 "	<i>S</i>
1	7 "	<i>B</i>
1	8 "	<i>S</i>
2	9 "	<i>A</i>
3	9 "	<i>S</i>

Total number 14

III. *The Relation of the Toe-types to the Anatomy of the Foot.*

There has been considerable diversity of opinion as to whether type *L* or *S* was the more common. Thus, in the plates of Vesalius' anatomy (1543) the second toe is generally represented as the longer, but in one diagram, the two feet differ. Unfortunately it is impossible to state how far these diagrams are conventional or actually represent Italian conditions. Passing on to the "Anthropologia Nova" of Drake in 1707, one finds the woman of Table XXI and the man of Table XXII both

represented with the second toe longest (type *S*) but the text reads, "*Pollex pedis* is longer than the other toes." In 1864 Vogt, in *Lectures on Man*, refers on p. 153 to "the length of the great toe which generally exceeds in man, that of the other toes," but the skeleton on p. 56 shows the second toe as the longest. Marshall in *The Human Body* (1875), makes no statement, but the skeleton represented shows the *S* type and the drawings of the feet are *L*, *S*, *A* and *B*. Flower in 1881 writes: "The first or inner toe is much larger than either of the others and its direction is parallel with the axis of the foot....It seems to be a common idea with artists and sculptors as well as anatomists, that the second toe ought to be longer than the first in a well proportioned human foot....Among hundreds of bare and therefore undeformed feet of children I lately examined in Perthshire, I was not able to find one in which the second toe was the longest." Braune in 1884 stated that the second toe was always the longer in the foetus and also among 70 per cent. of adults and this statement is repeated as authoritative by Stratz in 1903. Kollmann, agreeing with Braune, says that 30 per cent. only of the population of civilized countries have the *L* type of foot, whilst Holden on the other hand says that the majority are of the *L* type. Weissenberg in his important paper of 1895 finds that the majority have the *L* type of foot. Lazarus in 1896 published complex tables of the exact measurements of the foot bones, but does not give their relation to the relative lengths of the toes of the foot. Dunlop in *Anatomical Designs for Art Students* (1899) represents the foot and the skeleton with the second toe decidedly the longer. Pfitzner in his papers from 1901 to 1903 recognises the existence of both types. Thomson in *Anatomy for Art Students* (1906) makes no statement but writes, "in regard to the length of the toes, there is much diversity of opinion." Volker (1905) did not examine the living foot nor does he state the appearance of the skeleton, but makes it clear, that for most Europeans, the first toe appears the longest. Volker was limited by examining only the skeleton of the foot, very few of which are prepared sufficiently well for careful work. Undoubtedly radiographs give a truer idea of the relation of the bones than the dried skeleton. Dwight (1907) in *Variations of the Bones of the Hand and Foot* did not touch on the point now under consideration. An examination, however, shows both *S* and *L* types among his radiographs, but the majority of them were so taken that no conclusion can be reached as regards the relation of the toes to one another. From the above summary of the literature, it becomes obvious that a further enquiry was needed for England.

The examination of a number of skeletons showed that, compared with the results of a study of the living foot, too large a proportion had the *S* type of foot. In order to discover to what this discrepancy is due, it would be necessary to make an examination of a large number of fresh feet, the fresh skeletons of these feet and the same skeletons when carefully dried. As I was only able to carry out this work in one instance, this question must be left to future investigators.

In consequence of the existence of a number of types of feet, it has become necessary to discover to what factor the difference in the apparent length of the toes is due. It was important from the Mendelian point of view to decide whether this difference was due to variations in length of one or more of the skeletal elements or to the terminal soft tissue. In other words, is it due to some unit character or is this difference, like height, due to a group of characters too complex to be analysed, or, though due to a complex of factors, may it still be inherited as a "unit"?

For the purpose of this research radiographs were taken of two complete families, each consisting of two generations. In one family there were the two parents and four sons; in the other (Fig. 2, and Plates XIX—XXI), the two parents and three children, two boys and a girl. In both these families the feet of the two parents were different, whilst the children were of various types. The only difficulty which attended the taking of the photos was in keeping the second toe flat, but this was overcome in the case of the young children by means of a board placed on the toes. The radiographs were taken by placing the naked foot on a plate and arranging the centre of focus to fall about one-third from the distal end of the third metatarsal. The arch of the foot makes the radiographs slightly incorrect as the distal ends of the metatarsals are nearer to the plate than the proximal ends. As the arch increases with the length of the bones, that is, from childhood to maturity, there would be the same proportion of error for each foot. Hence the error may be considered negligible when making comparisons between a series of radiographs, all taken under the same conditions. The only condition which might have detracted from the results would have been a bad case of flat-footedness, but of this, no instance was found.

A comparison of Fig. 2, with Plates XIX, XX and XXI, shows the correctness of the toe-tracings in these cases. But, it is apparent that the outline of the foot is not exactly the same as the outline of the skeleton. If the skeleton of the feet as shown by the radiographs had alone been examined, the feet would, with one exception (not illustrated), have

appeared of the same type as indicated by the toe-tracings. In this exception, the foot when judged by the outline appeared *L*, but appears as an *E* when judged by the skeleton.

Measurements of the thickness of the soft tissue at the ends of the first and second toes were made and are shown in Table V. These measurements show that the soft tissue at the end of the great toe is constantly longer than that of the second toe and that this difference increases with age. Thus, the average length of the soft tissues for the first toe is 0.535 cm. and for the second toe is 0.396 cm. On further analysing the results, it appears that the excess in length of the soft tissue of the first toe is 0.111 cm. for the *L* type of foot and 0.177 for

TABLE V.

Measurement of Length of Soft Tissues at end of First and Second toes, taken from Radiographs.

Type of Toe	Sex	First Toe	Second Toe	Reference to Radiograph
<i>S</i>	♂	0.6	0.35	
<i>L</i>	„	0.7	0.4	
<i>L</i>	„	0.5	0.4	
<i>L</i>	♀	0.55	0.3	
<i>L</i>	„	0.55	0.4	
<i>S</i>	♂	0.5	0.4	
<i>S</i>	„	0.55	0.4	
<i>S</i>	♀	0.4	0.4	} Plate XXI, III <i>a</i> and III <i>b</i>
<i>L</i>	„	0.4	0.35	
<i>S</i>	„	0.6	0.4	} Plate XX, II <i>a</i> and II <i>b</i>
<i>S</i>	„	0.6	0.45	
<i>S</i>	♂	0.7	0.4	
<i>L</i>	„	0.6	0.45	
<i>L</i>	„	0.52	0.45	} Plate XX, I <i>a</i> and I <i>b</i>
<i>L</i>	„	0.5	0.5	
<i>S</i>	„	0.4	0.3	Figure 3
<i>L</i>	„	0.45	0.3	
<i>L</i>	„	0.4	0.35	
<i>L</i>	„	0.55	0.5	} Plate XXI, IV <i>a</i> and IV <i>b</i>
<i>L</i>	„	0.55	0.45	
<i>L</i>	„	0.5	0.45	
<i>L</i>	„	0.5	0.45	
<i>S</i>	♀	0.65	0.3	
<i>S</i>	„	0.6	0.3	
<i>L</i>	♂	0.55	0.4	
<i>S</i>	„	0.5	0.45	
Average length		0.535	0.396	
Average length of <i>L</i> type		0.521	0.41	
Average length of <i>S</i> type		0.554	0.377	

the *S* type. The importance of these measurements is, that the *L* type is not, at any rate in these cases, due to the extra length of the soft tissue, and the *S* type of foot has the second toe longest, *in spite of* the excess of soft tissue at the end of the great toe. These observations by no means aid in explaining why so large a proportion of skeletal feet are of the *S* type—except that they suggest that the discrepancy is due to careless preparation of the feet. Volker met the same difficulty in that his measurements of the skeletal elements contradicted “les résultats de plusieurs mensurations prises sur les vivants....Je dois avouer que dans ce moment je n’ai pas de données pour expliquer cette contradiction. Peut-être faut-il la chercher dans l’épaisseur des tissus graisseux au bout du gros orteil chez les vivants, ou peut-être aussi dans ce fait que beaucoup de mensurations ont été faites sans appuyer sur le deuxième orteil presque toujours plus plié, pour le redresser en toute sa longueur.” Unless, however, the toes tabulated are unusual, the explanation certainly does not lie in the soft tissues.

Table VI gives the measurements of the phalangeal bones, of the metatarsal bones and of the complete column or digit, in 26 radiographs. The measurements have been taken along the median axis of each bone by means of a transparent glass cm. rule. The axes of the digits are not naturally parallel to the main axis of the foot. When a digit was displaced from its correct position, each bone was measured separately in order to obtain the correct undistorted length.

The most striking result is, that in all cases, except one, the first phalanges are longer than the second, whether the foot be of the *L* or *S* type. In this one instance, the female of the first family in Table VI, the bony toes of the left foot are equal and on the right foot the second toe is 0.1 cm. longer than the first. It is hence obvious that the factor for toe-type does not lie in the toe alone.

Lazarus gives a table with the lengths of the phalanges in 13 cases, of which 11 show the first toe-bones longer, in one the skeletal toes are equal, and in the thirteenth case the second phalanges were longer than the first. He, however, makes no statement concerning the appearance of the living foot. Volker, who also dealt only with the skeleton, made extensive measurements, and he writes: “The first toe in all races is longer than the second, except it appears among the Melanesians, among whom the two toes are of equal length.”

Table VI shows further, that in every case the second metatarsal is longer than the first. Lazarus also found this to be the condition in 15 cases, which varied in age from a foetus of 3½ months to an adult.

TABLE VI.

Giving lengths in cm. of the Metatarsals (Mt), Phalanges (Ph), and complete Digit (Dg), of the Left and Right feet of two complete families and of four other persons.

Person	Toe type	Left					Left					Left				
		Mt1	Mt 2	Mt 3	Mt 4	Mt 5	Ph 1	Ph 2	Ph 3	Ph 4	Ph 5	Dg 1	Dg 2	Dg 3	Dg 4	Dg 5
Parent ♂	... B	7.1	7.8	7.2	6.1	5.5	6.0	5.8	5.1	4.8	4.0	13.3	13.9	12.6	11.1	9.9
Parent ♀	... S	6.55	7.1	6.7	6.45	6.2	4.9	4.9	4.1	3.8	3.2	11.5	12.1	10.9	10.4	9.5
son S	6.8	7.7	7.4	6.4	5.8	5.7	5.2	4.8	4.2	3.3	12.7	13.1	12.6	11.0	9.2
son L	6.2	7.3	7.1	6.7	6.0	5.15	4.8	4.5	4.0	3.0	11.6	12.1	11.7	10.8	9.2
son B	6.2	7.4	6.9	6.8	5.1	5.0	4.7	4.5	4.2	3.3	11.3	12.3	11.7	11.1	9.6
son L	4.0	4.8	4.5	4.4	4.0	3.8	3.45	3.3	3.0	2.6	8.3	8.8	8.4	7.9	7.3
Parent ♂	... L	7.0	8.4	8.0	7.4	6.9	6.4	5.8	4.8	4.3	3.7	13.5	14.3	13.2	11.8	11.0
Parent ♀	... S	—	—	—	—	—	5.3	4.9	4.25	3.7	2.9	—	—	—	—	—
Daughter	... A	4.2	4.9	4.8	4.5	4.3	3.7	3.2	3.0	2.7	2.3	8.3	8.5	8.2	7.6	7.2
son L	3.45	3.55	3.2	3.15	3.25	3.3	3.2	3.05	2.5	2.3	7.4	7.5	7.05	6.6	6.3
son S	2.5	2.6	2.4	2.25	2.2	2.55	2.4	2.15	1.95	1.85	5.6	6.1	5.5	5.1	5.0
Child ♀	... L	7.8	8.4	8.2	7.5	7.2	6.7	5.8	5.1	4.8	3.6	14.5	14.4	13.4	12.2	11.0
Child ♂	... L	—	—	—	—	—	—	—	—	—	—	—	—	—	—	—
Child ♂	... L	—	—	—	—	—	—	—	—	—	—	—	—	—	—	—
Child ♂	... S	—	—	—	—	—	—	—	—	—	—	—	—	—	—	—
Average all types		5.61	6.36	6.44	5.6	5.13	4.87	4.51	4.05	3.66	3.0	10.72	11.19	10.47	9.6	8.65
Average L types		5.44	6.22	5.97	5.61	5.27	4.84	4.37	3.96	3.55	2.91	10.6	11.03	10.32	9.48	8.66
Average S types		5.83	6.52	6.12	5.6	4.96	4.91	4.65	4.15	3.77	3.09	10.88	11.38	10.66	9.74	8.64
type	... 100	114.33					100	90.3				100	104.0			
type	... 100	111.83					100	94.7				100	104.6			
Person	Toe type	Right					Right					Right				
		Mt 1	Mt 2	Mt 3	Mt 4	Mt 5	Ph 1	Ph 2	Ph 3	Ph 4	Ph 5	Dg 1	Dg 2	Dg 3	Dg 4	Dg 5
Parent ♂	... B	7.0	7.7	7.1	6.2	5.5	6.1	5.8	5.3	5.0	4.9	13.3	13.75	12.4	11.2	9.8
Parent ♀	... S	6.7	7.2	6.9	6.8	6.7	5.0	5.1	4.55	4.0	3.3	11.7	12.4	11.4	10.8	9.9
son S	6.7	7.6	7.0	6.1	5.0	5.5	5.2	4.6	4.2	3.4	12.4	13.0	11.4	10.4	8.6
son L	6.3	7.1	6.7	6.0	5.2	5.0	4.8	4.4	3.9	3.2	11.6	12.1	11.1	10.1	8.5
son B	6.2	6.8	6.5	5.9	5.0	5.2	4.8	4.4	4.2	3.2	11.4	11.9	11.2	10.4	8.3
son L	4.0	4.7	4.3	4.2	4.0	3.7	3.3	3.15	3.0	2.5	8.2	8.7	8.1	7.7	7.1
Parent ♂	... L	7.6	8.3	7.9	7.4	6.6	6.4	5.6	4.6	4.1	3.8	13.9	14.1	12.6	11.6	10.3
Parent ♀	... S	—	—	—	—	—	5.4	5.2	5.0	3.8	3.2	—	—	—	—	—
Daughter	... A	4.3	4.9	4.7	4.4	4.1	3.65	3.25	2.8	2.32	2.1	8.3	8.9	8.2	7.4	7.2
son L	3.5	3.6	3.35	3.15	3.3	3.5	3.3	3.2	2.7	2.3	7.5	7.7	7.4	6.7	6.56
son S	—	—	—	—	—	—	—	—	—	—	—	—	—	—	—
Child ♀	... L	7.95	9.0	8.6	8.0	7.5	6.3	6.2	5.2	4.4	3.8	14.5	15.3	14.1	12.1	11.3
Child ♂	... L	6.8	7.8	7.8	7.7	7.3	6.2	5.2	4.8	4.7	3.7	13.1	13.2	13.0	12.8	11.0
Child ♂	... L	6.8	8.1	7.8	7.4	7.1	6.4	5.5	4.6	4.3	4.0	13.3	13.75	12.7	11.8	11.2
Child ♂	... S	6.4	7.1	6.9	6.8	6.6	5.4	5.4	4.7	4.2	3.5	12.15	12.9	12.0	11.25	10.6
Average all types		6.17	6.91	6.58	6.15	5.68	5.26	4.9	4.37	3.91	3.35	11.64	12.13	11.2	10.32	9.25
Average L types		6.24	7.01	6.67	6.21	5.72	5.42	4.94	4.4	4.03	3.48	11.86	12.27	11.4	10.48	9.34
Average S types		6.02	6.7	6.37	6.02	5.6	4.99	4.83	4.33	3.7	3.1	11.13	11.8	10.75	9.96	9.07
type	... 100	112.3					100	91.14				100	103.45			
type	... 100	111.3					100	96.8				100	106.0			

Volker, whose work extended to many races besides Europeans, found that in *all* races, the second metatarsal was longer than the first.

The next measurements taken were the total lengths of the toe bones plus the metatarsals, that is, the complete anatomical digit. Here again my findings agree with Volker, that the second digit (la colonne métatarso-phalangeale) is in all cases the longer, and this, *whether the foot is of the L or of the S type.*

The findings from the three sets of measurements, (1) that the average length of the first phalanges (bony toe) is always greater than the second; (2) that the second metatarsal is in all cases longer than the first, regardless of toe-type; and (3) that the whole second digit is constantly longer than the first, throw no light upon why there are *L* and *S* toe-types. Hence, the relations of the phalanges, metatarsals and digits have been calculated in percentages, the first digit or any of its constituent parts being reckoned as 100 (see last two lines of Table VI). From these numbers is obtained the important result *that both for right and left feet, the second digit in the S type is proportionately longer than in the L type.*

IV. *The Inheritance of Toe-types.*

In order to study the inheritance of toe-type, tracings were obtained, in the manner already described, of 808 persons (Table VII), of these 381 were offspring of known parents (Table VII, *A*), 150 had one known parent (Sub-tables *B* and *C*), 92 were members of fraternities (Sub-table *D*), and 185 were the parents of persons in Tables *A*, *B*, *C*, *D* who do not therefore appear in these tables. It is at once apparent that the proportion of the various types among these 808 persons is not the same as among the 2301 persons (Table II) I had personally examined. This discrepancy, however, is not due to the faultiness of the toe-tracings, but to the fact that these were made from selected cases, whilst the feet examined may be regarded as an average of the population. There were great difficulties in obtaining the tracings, as there are strong prejudices connected with the naked foot, so that, in order to see the inheritance in the hybrid generation, very special efforts were made to obtain families where *S*, *A* and *B* toe-types were known to exist, and other families had to be neglected. The large proportion of females among the tracings is explainable on the same ground, as it was possible for me to persuade more females than males to submit themselves to what appeared an ordeal. There is, therefore, for two reasons, selection and sex, a larger proportion of *S* type and therefore of *A* and *B* types than would normally occur in the general population.

TABLE VII.

Tables A, B, C, D, E, analysing the Offspring of Various Matings.

Sub-Table A. In which both parents are known.

Number of Matings	Type of Mating	L		S		A		B		E		Total Number
		♂	♀	♂	♀	♂	♀	♂	♀	♂	♀	
54	L ♂ × L ♀	85	65	—	—	1	2	1	—	—	—	154
2	S ♂ × S ♀	—	1	2	6	—	—	—	—	—	—	9
16	L ♂ × S ♀	18	12	1	5	3	1	1	2	—	—	43
9	S ♂ × L ♀	10	18	3	1	—	1	2	1	—	1	37
25	L ↔ S	28	30	4	6	3	2	3	3	—	1	—
14	L ♂ × A ♀	13	20	1	4	1	1	1	1	—	—	42
12	A ♂ × L ♀	15	20	1	2	—	2	—	2	—	—	42
26	L ↔ A	28	40	2	6	1	3	1	3	—	—	—
4	L ♂ × B ♀	5	5	—	2	1	—	1	—	—	—	14
1	B ♂ × L ♀	4	3	—	2	—	—	1	—	—	—	10
5	L ↔ B	9	8	—	4	1	—	2	—	—	—	—
0	S ♂ × A ♀	—	—	—	—	—	—	—	—	—	—	—
1	A ♂ × S ♀	2	—	1	—	—	—	—	—	—	—	3
1	S ↔ A	2	—	1	—	—	—	—	—	—	—	—
2	S ♂ × B ♀	4	3	—	4	—	1	—	—	—	—	12
3	B ♂ × S ♀	5	1	2	—	—	—	1	—	—	—	9
5	S ↔ B	9	4	2	4	—	1	1	—	—	—	—
0	A ♂ × A ♀	—	—	—	—	—	—	—	—	—	—	—
2	B ♂ × B ♀	1	1	—	—	1	—	—	—	—	—	3
1	A ♂ × B ♀	—	1	—	—	—	—	—	—	—	—	1
2	B ♂ × A ♀	2	—	—	—	—	—	—	—	—	—	2
3	A ↔ B	2	1	—	—	—	—	—	—	—	—	—
0	E ♂ × E ♀	—	—	—	—	—	—	—	—	—	—	—
123	—	164	150	11	26	7	8	8	6	—	1	381 (190♂ + 191♀)

Sub-Table B. In which mother only is known.

Number of Matings	Type of Parent	Toe Type of Offspring										Total Number of Offspring
		L		S		A		B		E		
		♂	♀	♂	♀	♂	♀	♂	♀	♂	♀	
24	L	16	29	1	7	1	1	—	2	—	—	57
14	S	6	12	1	3	3	2	—	2	—	—	29
5	A	3	5	—	—	—	1	—	—	—	—	9
43	—	25	46	2	10	4	4	—	4	—	—	95 (31♂ + 64♀)

Sub-Table C. In which father only is known.

Number of Families	Type of Parent	Toe Type of Offspring										Total Number of Offspring
		L		S		A		B		E		
		♂	♀	♂	♀	♂	♀	♂	♀	♂	♀	
16	L	19	21	2	1	1	2	—	—	—	—	46
1	S	1	—	—	—	—	—	—	—	—	—	1
2	A	2	2	—	3	—	1	—	—	—	—	8
19	—	22	23	2	4	1	3	—	—	—	—	55 (25♂ + 30♀)

Sub-Table D. Families in which neither mother or father is known, designated by H. (homogeneous) and M. (mixed).

Number of Fraternities	Type	L		S		A		B		E		Total Number of Offspring
		♂	♀	♂	♀	♂	♀	♂	♀	♂	♀	
21	H.	21	31	—	—	—	—	—	—	—	—	52
11	M.	8	13	3	8	2	3	1	2	—	—	40
32	—	29	44	3	8	2	3	1	2	—	—	92 (35 ♂ + 57 ♀)

Sub-Table E. Tracings of persons (parents) who do not appear in A, B, C or D.

L		S		A		B		E		Total Number of Offspring
♂	♀	♂	♀	♂	♀	♂	♀	♂	♀	
57	57	11	23	13	15	3	6	—	—	185 (84 ♂ + 101 ♀)

Sub-Table F. Total of all persons appearing in above tables.

Total of Group	Type	L		S		A		B		E		Total Number of Offspring
		♂	♀	♂	♀	♂	♀	♂	♀	♂	♀	
A		164	150	11	26	7	8	8	6	—	1	381 (190 ♂ + 191 ♀)
„	B	25	46	2	10	4	4	—	4	—	—	95 (31 ♂ + 64 ♀)
„	C	22	23	2	4	1	3	—	—	—	—	55 (25 ♂ + 30 ♀)
„	D	29	44	3	8	2	3	1	2	—	—	92 (35 ♂ + 57 ♀)
„	E	57	57	11	23	13	15	3	6	—	—	185 (84 ♂ + 101 ♀)
		297	320	29	71	27	33	12	18	—	1	808 (365 ♂ + 443 ♀)

Percentages ... 81.09 72.23 8.22 16.02 7.39 7.44 3.28 4.06

Table VII (Sub-table A) gives an analysis of the various types of matings and of the offspring. The total number of families consisting of two complete generations is 123, producing on the average about three offspring each.

Fifty-four matings of $L \text{ ♂} \times L \text{ ♀}$ were obtained, which produced 154 offspring, all of which were L except 4, which were A and B (Fig. 4, Trees B and C). This indicates that the L type practically breeds true. The persistence of the L type is seen in Fig. 4 (Trees A, B, C). It was not possible for me to see the four exceptional cases, but re-tracings in each case confirmed the type. An enquiry was made into the history of these four exceptions (3 A and 1 B). Tree C in Fig. 4 shows the family of one male A in which there is no trace of any departure from the L type. The one case of a male B , as shown in Fig. 4, Tree B, gives an L ancestry of both the male and female parents, but there is nothing here to show that one of the parents was not heterozygous. Consideration may next be given to the two females (Table VII, Sub-

FIGURE 4.

Showing three family groups (Trees A, B, C) in which there is persistence of the *L* toe-type.

Tree A.

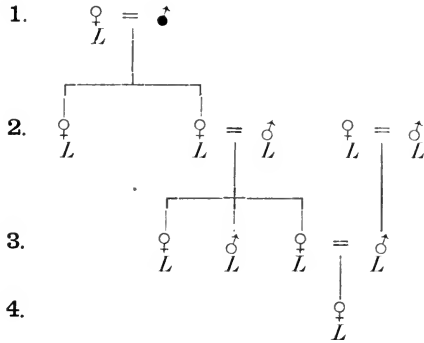

Four generations of *L* type.

Tree B.

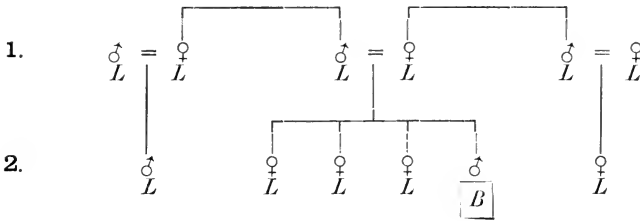

Two generations of *L* type with the appearance of a *B* (one of the exceptions mentioned in text).

Tree C.

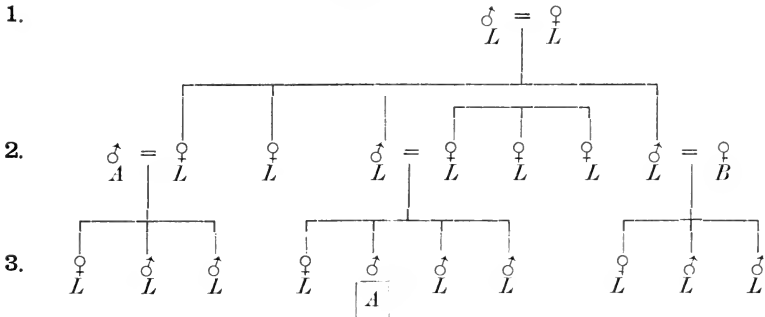

Three generations with persistence and dominance of *L*, but the appearance of an *A*.

table A) of the *A* type. In one case both parents had *L* toe-type, but the tracing of the father was unsatisfactory. Nothing is known of the ancestry or sibs of the parents. The sister and brother of this case were undoubtedly *L*. The second case of a female *A* is seen in Fig. 5, Tree *D*, where an *S* grandparent is known, and where, therefore, the *L* father may be a heterozygote.

Unfortunately I only obtained two matings of *S* ♂ × *S* ♀; these produced nine offspring, eight *S* and one *L*. These numbers are far too small, but they seem to indicate a tendency to breed true. One of the families is seen in Fig. 5, Tree *E*, (iii). This tree shows side by side two family groups (ii and iii) which certainly suggest segregation, and here the offspring are numerous enough to make the results impressive.

The next mating analysed is *S* ♀ × *L* ♂ and *L* ♀ × *S* ♂. These 25 matings gave 80 offspring, divided thus, 58 *L*, 10 *S*, 11 *A* and *B*, 1 *E*, or 58 *L* and 22 of the other types; here there is partial dominance of the *L* over the *S* type, approximately $2\frac{3}{4}$ to 1, suggesting either that there are several factors which make up the final result, or that some *L* type parents were not pure. If *S* is the recessive type, as appears from this crossing and others yet to be studied, how can any *S* arise as the result of the $L \longleftrightarrow S$ cross? The explanation is to be found in the probability that a few *L* types are heterozygous: this would also account for the few *A* and *B* types found among the descents of $L \times L$. Of the 25 cross-matings, 9 only have any *S* offspring, and of these enough is only known in one case to suggest an explanation. This history is seen in Fig. 5, Tree *F*. The grandmother here is an *S*, so that the father may be a heterozygote.

There were 31 matings of $L \times A$ and $L \times B$, producing 124 offspring, 85 *L*, 12 *S*, 11 *A* and *B*, or 85 *L* to 23 of the other types, approximately $3\frac{3}{4}$ to 1; again the *L* type shows its dominance, and as would be expected if *A* and *B* are the heterozygous forms, there is a larger proportion of *L* produced than in the $L \times S$ matings where the *L* offspring are to the "other" type offspring as $2\frac{3}{4}$ is to 1.

The appearance of any *S* type is not to be accounted for in this cross, unless again, some *L* are heterozygous. Amongst the 31 matings 9 only produced the 12 *S* offspring. In 7 of these matings nothing is known of the ancestry of the *L* parent; in the eighth case the *L* parent is one of a pure *L* fraternity and there is therefore no collateral history. In the remaining case, the *L* parent had a pure *L* ancestry but had a sister who was *A* type. It should be noted that of the 12 *S* offspring, a large proportion, 10, are females.

FIGURE 5.

Tree D.

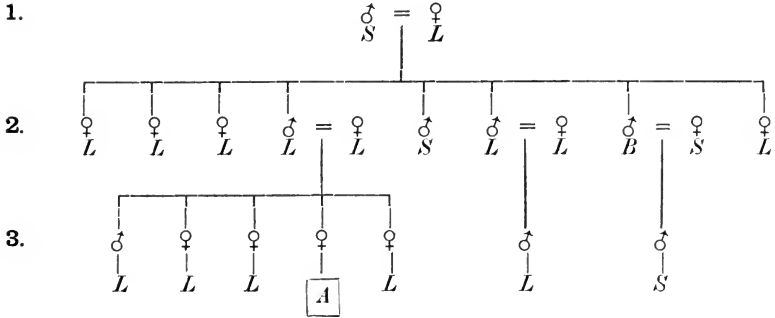

Three generations showing an unexpected *A* and an expected *S* in third generation.

Tree E.

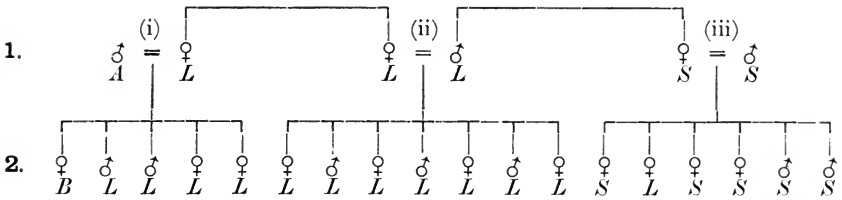

Two generations to show a hybrid generation (i), and pure breeding in (ii) and (iii).

Tree F.

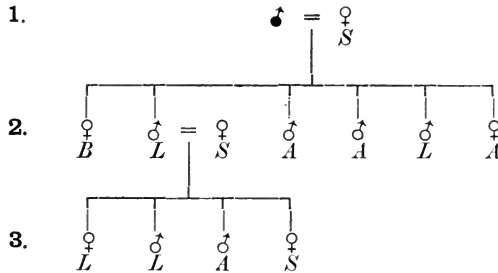

Three generations showing a variety of types.

Only 6 matings $S \times A$ and $S \times B$ were recorded, these produced 24 offspring, 15 L , 7 S , 2 A and B , or 15 L type and 9 of the other types. Again there is dominance of the L type, but the proportion, 15 : 9, indicates a very real genetic difference between this type of mating and $L \times (A \text{ or } B)$ in which the offspring are as $3\frac{3}{4} : 1$ or 15 : 4.

The five remaining matings between A and B types gave only 6 offspring, 5 L and 1 A , the L factor being preponderatingly dominant. The behaviour of A and B with one another and with S and L respectively, makes it clear that they are heterozygous types, just as the matings $L \times L$ and $S \times S$ show that these are generally pure types for the character under consideration.

The net result of all these groupings is to show that the L toe-type is the dominant, the dominance being, so far as yet determined, irregular. The usual heterozygous forms are A and B , but some L types also behave as heterozygotes. That L may be both a hetero- and a homozygote is seen from Fig. 6, Tree G .

FIGURE 6.

Tree G.

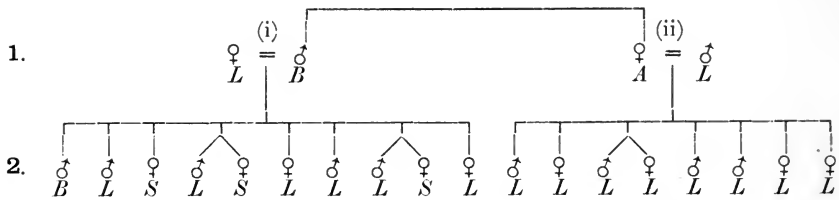

Two generations to show the two values of L . Amongst the offspring are three pairs of ordinary twins.

Tree H.

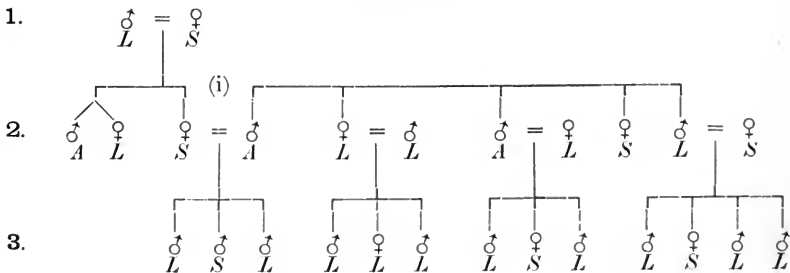

Three generations.

Consideration must be now given to the possibility that S is sometimes a heterozygous form. The six matings $S \times (A \text{ or } B)$ produced 15 L and 9 of the other types, a very large proportion of L , unless S is sometimes heterozygous or unless the L factor is what may be described as an *excessive* dominant, and the matings $L \times S$ by no means indicate that. In this connection the family in Fig. 6, Tree H , (i), is interesting, where the mating $S \text{ ♀} \times A \text{ ♂}$ produced two male L . Now this female S may be a heterozygote, being the child of the mating $L \text{ ♂} \times S \text{ ♀}$, or the two male L of generation three may themselves be heterozygotes, a point which can only be settled during the next decade. This may be a case in which the heterozygote appears as an S because it is a female.

There is certainly a sex factor in the S type and this may be accounted for by the existence of certain female heterozygotes appearing as S type; on the contrary, there may be a tendency for the male heterozygote to appear as an L . It is possible that a comparison of the matings $L \text{ ♂}$ with A , B or S , and $L \text{ ♀}$ with A , B or S , may throw some light on the sex difference. Of the former, there are 34 matings, producing 72 L , 14 S , 13 A and B , or 72 L type to 27 of the other types, a proportion of 16 : 6. Of the latter ($L \text{ ♀}$ with A , B or S) there are 22 matings producing 70 L , 9 S , 10 A and B , or 70 L to 19 other types or approximately 23 : 6. These results suggest at once that more male than female L are heterozygotes. Reference must here be made to Fig. 6, Tree G , in which it is the female L which appears heterozygous rather than the male L .

The above results must be controlled by an enquiry into the proportion of the sexes in the groups of offspring arising from the above two groups of matings. In both cases the A and B types will not be counted as they show no sex difference.

The mating $L \text{ ♂} \times (A, B \text{ or } S)$ produces 86 L and S offspring, divided thus: L , 35 ♂ and 37 ♀; S , 3 ♂ and 11 ♀, i.e. ♂ : ♀ :: 3 : 4, and there are 19.4 per cent. of S type.

The mating $L \text{ ♀} \times (A, B \text{ or } S)$ produces 79 L and S offspring divided thus: L , 29 ♂ and 41 ♀; S , 4 ♂ and 5 ♀, i.e. ♂ : ♀ :: 3 : 4, and there are 12.8 per cent. of S type.

The sexes in both cases are approximately the same, but a larger proportion of S is produced where the L parent is male rather than female. Thus, the above deduction is confirmed, that when the L type is heterozygous, it is more frequently male than female.

The results of the various matings may be summarised thus :

Type of Mating	Toe-Types				
	<i>LL</i>	<i>SS</i>	<i>A (LS)</i>	<i>B (SL)</i>	<i>E</i>
54 <i>L</i> × <i>L</i>	154	—	3	1	—
2 <i>S</i> × <i>S</i>	1	8	—	—	—
25 <i>L</i> × <i>S</i>	58	10	5	6	1
31 <i>L</i> × (<i>A</i> or <i>B</i>)	85	12	5	6	—
6 <i>S</i> × (<i>A</i> or <i>B</i>)	15	7	1	1	—
5 <i>A</i> × <i>B</i>	5	—	1	—	—

V. Summary of General Conclusions.

1. Three toe-types occur, but two are much more common than the other.
2. The commonest toe-type in England is one in which the first toe is longer than the others.
3. There is some limitation in regard to sex, the *S* type occurring more commonly in females than in males.
4. The *S* type of toe is commonest in the foetus.
5. The *S* or *L* types are produced by the comparative lengths of the digit, combined with an unknown factor.
6. The *L* type of foot is irregularly dominant over the *S* type of foot.
7. The heterozygous types are usually *A* and *B*, but some *L* types are heterozygous.
8. The male heterozygote tends to be *L*, the female heterozygote to be *S*.

DESCRIPTION OF PLATES.

PLATE XIX.

Photographs of feet of I. male parent, II. female parent, III. female child, IV. male child, outlines (toe-tracings) of which are represented in Figure 2.

PLATE XX.

Radiographs of feet of male (*I a* and *I b*) and female (*II a* and *II b*) parents represented in Plate XIX.

PLATE XXI.

Radiographs of feet of female (*III a* and *III b*) and male (*IV a* and *IV b*) children, represented in Plate XIX.



Fig. II.



Fig. IV.



Fig. I.



Fig. III.





Fig. 1 *a.* Right foot of I. (Pl. XIX).



Fig. 1 *b.* Left foot of I. (Pl. XIX).



Fig. 2 *a.* Left foot of II. (Pl. XIX).



Fig. 2 *b.* Left foot of II. (Pl. XIX).



Fig. III *a.* Right foot of III. (Pl. XIX).



Fig. III *b.* Left foot of III. (Pl. XIX).



Fig. IV *a.* Right foot of IV. (Pl. XIX).



Fig. IV *b.* Left foot of IV. (Pl. XIX).



LITERATURE.

- ANTHONY, R. (1903 A.) "L'évolution du pied humain." *Bull. et Mém. Soc. d'Anthrop.* Sér. 5, Tom. III. pp. 818—835. Paris, 1903.
- (1903 B.) *Rev. Scientif.* Sér. 4, Tom. XIX. pp. 129—139. 1903.
- BRAUNE. (1884.) "Ueber einige Formverhältnisse des Menschlichen Fusses." *Congrès périod. internat. des sc. médicales.* 8^e sess. Copenhague.
- BROOM, R. (1906.) "On the Arrangement of the Epiphyses of the Mammalian Metacarpals, etc." *Anat. Anz.* Vol. XXVIII. pp. 106—108.
- DRAKE. (1707.) "Anatomy" or "Anthropologia Nova."
- DUNLOP, JAMES M. (1899.) *Anatomical Diagrams for the use of Art Students.* Geo. Bell and Sons, London.
- DWIGHT, T. (1907.) *Variations of the Bones of the Hand and Foot.* Lippincott and Co.
- ELLIS, HAVELOCK. (1904.) *Man and Woman.* 4th edition.
- FLOWER, W. H. (1881.) *Fashions in Deformity.* Macmillan and Co., London.
- GRÜNING. (1886.) "Ueber die Länge d. Finger und Zehen bei einigen Völkerstämmen." *Arch. f. Anthropologie*, Bd. XVI. p. 511.
- HARRISON PARK, J. (1882 A.) "On the Length of the Second Toe of the Human Foot." *Brit. Ass.* p. 606.
- (1883 B.) "On the Relative Length of the First Three Toes of the Human Foot." *Proc. Anth. Instit.* Vol. XIII. p. 258.
- HASSELWANDER. (1903 A.) "Untersuchungen über die Ossifikation des Menschlichen Fusses, etc." *Zeitschrift für Morphologie und Anthropologie.* Bd. v. pp. 438—508.
- (1908 B.) "Ueber die Ossifikation des Fuss skeletts." *Anat. Anz.* Bd. XXXII. p. 608.
- HOLDEN, "Human Osteology."
- KEIBEL, FRANZ and MALL, FRANKLIN, P. (1914.) *Manual of Human Embryology.*
- KLAATSCH, HERM. (1901.) "Die wichtigster Variationen am Skelet der freien unteren Extremitäten des Menschen." Wiesbaden, 1901. (Sep. Abdr. d. *Ergebnisse der Anatomie und Entwicklungsgesch.* Bd. x. 1900, p. 599.)
- LAZARUS, J. (1896.) "Zur Morphologie der Fuss skeletts." *Morph. Jahrbuch*, Bd. XXIV. 1896, p. 1.
- LOMBROSO. (1901.) "Sulla cortezza dell' alluce negli epilettici, nei criminali e negli idioti (con 3 figure nel testo)." *Arch. di Psich.* p. 337.
- MARSHALL, J. (1875.) *The Human Body.* 2 vols. Smith, Elder and Co., London.
- OLTOLENGHI E CARRARA. (1892.) "Il piede prensile negli alienati e nei delinquenti (con tre figure nel testo)." *Arch. di Psichiatria*, 1892, Fasc. IV, v, p. 373.

- PAPPILAUT. "L'homme moyen à Paris." *Bulletin de la Société d'Anthropologie de Paris*, 1902.
- PFITZNER. (1892 A.) "Beiträge zur Kenntniss des menschlichen Extremitätenskelets." *Schwalbe's Morphologische Arbeiten*, Bd. I. 1892.
- (1901 B.) "Beschreibung von Aberrationen aus meiner Sammlung." *D. Ent. Zs. Ins.* Berlin, Bd. xiv. 1901, pp. 113—115.
- (1903 C.) "Beiträge zur Kenntniss der Missbildungen des menschlichen Extremitätenskelets. IX. Ein Fall von beiderseitiger Verdopplung der fünften Zehe." *Zs. Morph.* Stuttgart, Bd. iv. 1902 (pp. 38—393, mit 1 Taf.).
- (1904 D.) "Social-anthropologische Studien. IV. Die Proportionen des erwachsenen Menschen." *Zs. Morph.* Stuttgart, Bd. v. 1903 (pp. 201—314).
- PIERSOL, GEO. A. (1907.) *Human Anatomy*. J. B. Lippincott and Co., Philadelphia and London.
- STRATZ, C. H. (1902.) *La Beauté de la femme*, trans. from German by R. Waltz. Paris, Gaultier, Magnier et Cie.
- THOMSON, A. (1906.) *Anatomy for Art Students*. Clarendon Press, Oxford.
- VESALIUS. *Epitome of*, 1543.
- VOGT. (1864.) *Lectures on Man*.
- VOLKER, M. TH. (1905.) *Variations squelettiques du pied chez les Primates et dans les Races humaines*. Beaugency, Imprimerie Laffray Fils et Gendre.
- WEISSENBERG, R. (1895.) "Die Formen der Hand und des Fusses." *Zeitschrift für Ethnologie*, Berlin, Bd. xxvii. 1895, p. 82.

September, 1913.

THE TRANSMISSION OF SECONDARY SEXUAL CHARACTERS IN PHEASANTS.

BY ROSE HAIG THOMAS, F.Z.S., F.L.S.

INTRODUCTION.

MY experiments in pheasant breeding were commenced over eight years ago after reading Mr Punnett's "Mendelism" which opened up a study so fascinating that various schemes were undertaken to ascertain whether pheasant crosses would follow Mendel's law. Some of the *inter se* experiments not yet published furnish extremely interesting evidence of segregation, but every experiment seemed so involved with the problem of sex (producing unexpected pure recessives among small numbers) that for several years schemes have been arranged breeding back with the female parent or with the male parent to try and throw some light on the subject.

Cases of the female transmitting the male characters of her species to her male offspring have been recorded by others previously: amongst my pheasant breeding experiments many such instances have occurred.

Examples are found in both fertile and sterile hybrids.

Dealing with the first, we will take the Silver ♀ × Swinhoe ♂ series, which form the subject of this paper. In this the F_1 male offspring have to some extent, and F_2 and F_3 male offspring have the plumage, with the exception of some very interesting mutations on the under parts¹, bulk, call, and moral character (bold and tame) of the Silver ♂ transmitted to them by the Silver hen—the female parent. In a cross made between *P. formosanus* ♀ × *P. versicolor* ♂, an F_1 female, which was in appearance a *P. versicolor* ♀, yet proved to have the male Formosan secondary sexual characters present,

¹ 3rd April, 1914. Recent investigations have shown these to originate from the Male parent of F_1 .

transmitted to her by the female parent, for she transmitted some of these to her male offspring when mated with a *P. versicolor* ♂.

Turning to the sterile hybrids we find the influence of the female on the various characters of her male offspring still stronger, a mating made between *P. reevesi* ♀ and *P. formosanus* ♂ produced two F_1 males, having the colour, form, pattern and structure of the majority of the plumage areas together with the bill and bulk of the *male* of the *female* parent species.

A very peculiar case illustrating the phenomenon of the transmission by the one sex of the secondary sexual characters of the other sex was shown in the difference between the 1910 and the 1911 plumage of a sterile F_1 Reeves × Formosan ♀. The 1910 plumage was *female*, and much of it was transmitted by the male parent resembling that of the *female* of his species. In 1911, the plumage of this F_1 Reeves × Formosan ♀ assumed male characters, and was in every area in which it occurred the *male* plumage of the *female* parent species, proving that to this one individual both the male and the female parent had transmitted the secondary sexual characters of the opposite sex of their species.

A mating between *P. reevesi* ♀ × *P. versicolor* ♂ produced sterile offspring, and here also the female parent transmitted to her male offspring, in several areas, the male characters of her species in bulk, colour and pattern.

The number of male birds reared in the above crosses has been considerable, therefore the statement might be made that these facts are of pretty general distribution in pheasant crosses.

In previous papers (*Proc. Zoo. Soc.* April, 1910; *Proc. Zoo. Soc.* September and December, 1912), I have brought to notice facts relating to the transmission by the *male* of the *female* secondary sexual characters of his species. In the first, an account was given of a cross between a Silver ♀ and Swinhoe ♂, followed by a F_1 ♀ × Swinhoe ♂ which produced an F_2 female offspring very difficult to distinguish from a pure Swinhoe ♀: and when bred with a Swinhoe ♂ the only offspring this F_2 female produced was a pure Swinhoe male.

The crossing of Formosan with Versicolor formed the subject of the other paper, in which it was shown that the male parent transmitted to his F_1 female offspring much of the female plumage of his species together with the dimension of the egg, and that in the F_2 generation the offspring of F_1 Formosan × Versicolor ♀ with *P. versicolor* ♂ the Versicolor male seems to have transmitted every character, bill, leg

colour, plumage, habit and temperament, of the female of his species, to the F_2 female offspring, even the dimension of the egg.

It is further worthy of notice that in this experiment, though the Versicolor male transmitted every character of the female of his species to his F_2 female offspring, yet he did not transmit all his own plumage to his F_2 male offspring.

Following on the above facts, the *Gennaesus nycthemerus* × *G. swinhoi* series here dealt with confirm the previous investigations into these strangely sex-limited phenomena, eliminating that certain source of error, small numbers, and demonstrating that the first were no isolated cases but evidence of very general application of some significance. In this experiment, as in all my pheasant crosses, many instances occur of pattern and colour transference from male parent to female offspring, or female parent to male offspring, or again from one plumage area to another. Where these have been observed, they have been recorded to obviate any erroneous classification of these characters as hybrid, when they are really due, not to a mosaic of the two species crossed, but to a shifting of colour and pattern from one sex to the other within one of those species; but after eliminating these it will still be seen that in certain of the plumage characters, in the moult habit and in

PEDIGREE OF MATING, 1907.

“B” ♀ *Gennaesus nycthemerus* (Silver).

“A” ♂ *Gennaesus swinhoi* (Swinhoe).

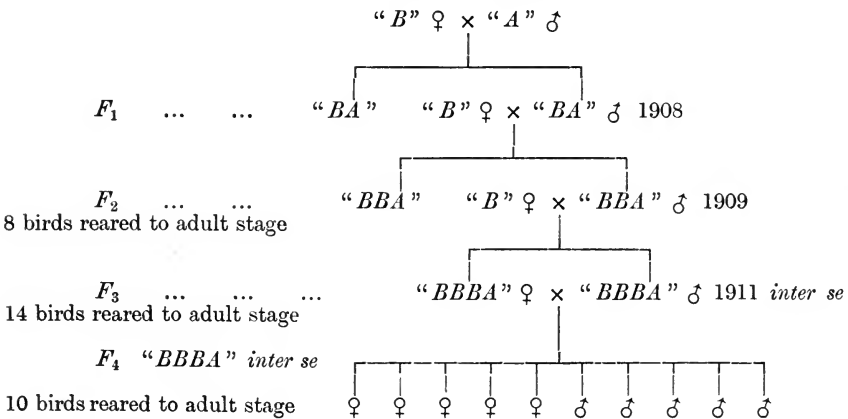

Note. Amongst the F_3 “BBBA” two mutations, i.e. birds having new characters not present in either parent species, were bred, a ♂ and a ♀ which were mated *inter se*. Their offspring F_4 *inter se* ♀ ♀ are included in this paper and show clear segregation, Journ. of Gen. III

the leg colour, the F_1 , F_2 , and F_3 female offspring are hybrid¹, notwithstanding the three doses of Silver ♀ to one of Swinhoe ♂.

The birds dealt with in this experiment were obtained by the series of crosses shown in the preceding pedigree of mating.

We will consider the characters of the birds produced by these matings under two headings, dealing first with time of maturity, plumage and leg colour; secondly with the moulting habits and pattern transference.

1. *Time of Maturity, Plumage and Leg Colour.*

From 1906 to 1909 it is recorded that the two parent species in this cross-breeding experiment were, both male and female, immature at ten months old, and did not breed, but the hybrids F_1 "BA" and F_2 "BBA" matured in the first year and bred when mated at ten months old. There was an increase in size accompanied by premature sexual development, but not by secondary sexual development. In the second year as in the parent species the adult plumage was assumed.

In 1910, at ten months old, F_3 "BBBA" ♀♀ were penned separately from F_3 "BBBA" ♂♂ and they laid no eggs; but in my pheasant experiments, extending over seven years, frequent instances have been recorded of hens not laying when penned apart from cocks in the mating season, therefore this was not absolute proof of immaturity.

The records of 1911 remark that F_1 "BA" 1907 birds mated *inter se* were laying well, and raising healthy offspring, and that F_3 "BBBA" 1909 birds mated *inter se* were very fertile, hatching 13 birds out of 14 eggs, 12 of which were reared; it is noted that these F_4 "BBBA" *inter se* as chicks were strong, healthy, and displayed great courage.

In 1912, during the mating season, the F_4 "BBBA" *inter se* ♀♀ were separated from the F_4 "BBBA" *inter se* ♂♂ under the same conditions as F_3 in 1910, i.e. kept in adjacent pens with a wire netting to keep them apart, and though these unmated ♀♀ laid no eggs, being possibly immature at ten months, yet four of the ♀♀ attacked and beat the fifth ♀ so that it had to be removed, which, occurring during the mating season, must be attributed to rivalry.

When selecting from the 5 F_2 "BBA" ♂♂ in 1909 a male parent to cross with a Silver ♀, the most mixed looking hybrid was chosen, which in the following summer assumed like the brothers the Silver

¹ By the term "hybrid" is meant the blending of characters derived from the two original parents, due to the simultaneous presence of factors derived from each parent and patently exhibited in the offspring.

pattern, but showed Swinhoe colour, in that many feathers were deeply stained with brown. Amongst the offspring reared from this bird and the Silver ♀ (F_3 "BBBA," eight in number), two birds exhibited new plumage characters, "mutations," the one a ♂ the other a ♀, these two mutations were mated *inter se* in their second year, 1911, and bred the F_4 "BBBA" of this series, reproducing amongst these birds, of which ten were reared to the adult stage, replicas of the plumage mutations.

Two examinations of plumage were made (see Appendices A and B), the first giving detailed descriptions of the hybrid areas observed (Plates XXII—XXVI).

In the second examination (Appendix B) I sought, not so much to define the details of the plumage patterns, but rather to make it my task to trace their hybrid origin, and in this investigation the immature eight month plumage of the Silver ♂, a transition stage between the chick and adult plumage, proved of great value for it was found to play a large part in the varied designs of F_2 , F_3 , and F_4 in some apparently hybrid characters, and where absent in other hybrid characters served to confirm the presence of the Swinhoe characters. It is plain that the factors for this male immature transition plumage were transmitted by the *female* parent to her *female* offspring, and it is interesting to note that the characters of the patterns of that plumage show the connection between the Silver and Swinhoe species: for instance, the flank feather pattern of the immature Silver ♂ (Plate XXIV, fig. 3 *b*) is very similar to the breast feather pattern of the Swinhoe ♀ (Plate XXIV, fig. 2 *a, b*), though in colouring they differ widely.

On the wing, tail, breast, and flank of F_1 , F_2 , F_3 and F_4 ♀♀ the scapular, interscapular and tail covert patterns of the Silver ♂ eight month transition plumage can be traced in competition with the breast and flank of the Swinhoe ♀. It is remarkable that upon the breast and some anterior scapulars of the Silver ♂ transition plumage (Plate XXII, fig. 16 *a, b*) was found the same delicate grey shade that distinguishes the plumage of F_3 mutation ♀ "P" (Plate XXII, fig. 16 *c*) and her offspring F_4 mutation ♀ "G" a male factor transmitted by the female parent.

The following list of areas having hybrid characters in F_1 , F_2 , F_3 , and F_4 may be given:—

Crest (Plate XXII)	Wing	{	Primary and covert
Breast (Plate XXIV)			Secondary and covert (Plate XXV)
Flank " "	Tail	{	Centrals
Thigh (Plate XXVI)			Laterals (Plate XXIII)

In the case of leg colour, we also find evidences of hybridism through all four generations, but in some cases there is distinct segregation of the colour of the parent species. Thus:—

Parent Species.

Silver	}	“B” ♀	pale scarlet
		“B” ♂	bright rose
Swinhoe	}	“A” ♀	deep dark red
		“A” ♂	deep dark red

Hybrids.

(In earlier years, records were not made of every bird.)

Number of birds examined:

- (2) Adult F_1 “BA” ♀♀ deep bright rose.
 (3) Six months old F_2 “BBA”: ♀♀ (2) bright scarlet, (1) rose colour.
 (26) Chicks F_3 “BBBA”: (20) like “B” ♀, (4) mosaic, (2) like “A” ♀.
 (12) Chick stage, five weeks old, F_4 “BBBA” *inter se*: (9) pale red, (3) mosaic of dull dark red and pale bright red.
 (5) Adult stage F_4 “BBBA” *inter se* ♀♀ “GMCKF” bright rose like the Silver ♂ transmitted by female parent.

Thus we see that F_2 , F_3 , and F_4 generations showed hybrid leg colour.

The early records in 1911 of F_4 “BBBA” *inter se* notice distinct evidence of Mendelian segregation even in the chick stage. The leg colours of the two parent species are as follows: Silver ♀ pale scarlet; Silver ♂ bright rose; Swinhoe ♀ and ♂ dull dark red. At five weeks old the leg colour of the 12 F_4 “BBBA” *inter se* is recorded as nine (9) pale bright red legs and three (3) mosaics of dull dark red and pale bright red, also at two months old notes were made of a strong brown colour staining the immature plumage of several F_4 “BBBA” *inter se* ♀♀ and these Swinhoe characters would appear to have been transmitted through F_1 , F_2 and F_3 ♂♂ from the one dose of Swinhoe ♂ in the first cross. The hybrid characters of F_1 , F_2 and F_3 ♀♀ must also have been derived from the males in each generation.

2. *Moult habit.*

The moult in pheasant crosses is an interesting character to observe. In two species crossed probably both the order and the season of the moult will differ. They did so in this series. The Silver moult early and the central rectrices grow in some time before the laterals. The Swinhoe moult late and the lateral rectrices grow in completely long before the centrals appear. Throughout this series all the hybrids exhibited the mosaic or hybrid moult on body and wings peculiar to every hybrid pheasant I have reared, quills of young feathers interrupting the plumage and loose feathers being noticed in the birds long after the season is past and the moult completed in the two parent species; the condition might be attributed to different plumage areas on the same bird inheriting the late or the early moult character or both, for new feathers are often shed two or three weeks after arriving at their full size.

Observations made this year, 1913, on the moult of *Gennaesus nycthemerus* (Silver) ♂ and *Gennaesus swinhoei* (Swinhoe) ♀ confirm previous records of the period and order of the moult in the two species; the Silver early, the Swinhoe late, the Silver moult centrals before laterals, the Swinhoe laterals before centrals. The Silver ♂ centrals on July 31st measured two inches longer than any of the laterals, the Swinhoe ♀ centrals measured two inches shorter than any of the laterals, and were still hidden under the coverts. In the Swinhoe ♂ the centrals do not grow out till long after the laterals are fully grown.

F_4 *inter se* ($F_2 \times F_3$) Silver \times Swinhoe ♂ "E" has the late Swinhoe moult and also the Swinhoe tail moult, for all the laterals were shed by the 21st July, and the centrals were shed on the 2nd August; these two moult habit factors must have been transmitted by the Swinhoe male parent through F_1 and F_2 males to the F_3 parents. F_4 *inter se* Silver \times Swinhoe ♀ "G" also shed her laterals first and her centrals two days later than F_4 ♂ "E." The dominance of the Swinhoe moult is also seen in F_2 *inter se* of another series, not connected with this paper.

The phenomena of pattern-transference from one area to another or from one sex to another, so often seen in pheasant hybrids, occurred in several individuals of this series, and have been carefully recorded that these should not confuse the issue by a false suggestion of hybridism.

There is clear evidence that colour and pattern-transference is the source of the factor for the delicate grey that distinguishes the mutation F_3 "P" ♀ and some of her offspring F_4 , a factor transmitted by the female parent from the transitional plumage of the male of her species to her female offspring, transmitted discontinuous and constant to F_3 "P" ♀ for the mutation is reproduced in her female offspring F_4 "G" ♀ and also appeared in the immature plumage in three or four others of her male and female F_4 , and where it occurred in the male resulted in a mutation in the breast feathers, which instead of being like the Silver ♂ a self black with a dark blue lustre in certain lights, have down the centre of each feather a long narrow V-shaped white mark; the thigh also shows mutation white being present in considerable quantity.

It is possible that further observation and investigation may reveal a law governing these phenomena of colour and pattern-transference and that varieties among species may be found to be partly due to their influence.

SUMMARY.

Judging from the result of this experiment, it would appear that the transmission of her female characters by "B" ♀ to her female offspring was far from complete even in the third generation. In fact the investigation of the birds concerned plainly demonstrates the following points:

I. Premature sexual development occurred in the crosses, which bred in the first year instead of like the parents in the second year.

II. That "B" ♀ failed to transmit her plumage to F_1 ♀♀ "BA," and that the hybrid condition of "BA" was continued in F_2 ♀♀ "BBA" after two doses of "B" ♀, and again the same hybrid condition was observed in F_3 ♀♀ "BBBA" after three doses of "B" ♀, and finally when "BBBA" were crossed *inter se* segregation appeared in the leg colour and in some plumage areas in F_4 ♀♀, and that in others of the various areas examined the *hybrid* nature of the plumage was maintained, showing that throughout the series certain of the characters of the female of "A" parent were carried by F_1 , F_2 and F_3 ♂♂.

III. It is also shown that the factors for the male eight month transition plumage were transmitted by the female parent to her female offspring and caused a hybrid appearance, but that these sexual hybrid patterns were quite distinct from the racial hybrid patterns and readily

traced to their source; also that the moult habit remained Swinhoe in the fourth generation, and that the leg colour was sexual hybrid and racial hybrid throughout the four generations.

IV. That the connection between the two species crossed can be traced by the eight month transition plumage of the Silver ♂ and the adult Swinhoe ♀ plumage.

V. That a mutation appeared in F_3 which has been distinctly traced to colour and pattern-transference and which was capable of hereditary transmission (Plate XXII, fig. 16).

APPENDIX A.

Here follow a detailed examination and comparison of the several plumage areas exhibited in the framed feathers, of which plates are printed.

Feathers were extracted and set on cardboard from the tail, wing, breast, flank, thigh and crest, taken from the same locality in each area, of the following birds. The method employed was to copy the ring inscription on to an envelope then extract the feathers and place them within.

Parent Species.

*Gennaëus nycthemerus*¹, "B" ♀, Silver ♀, parent of F_1 .

Gennaëus swinhoei, "A" ♀, Swinhoe ♀, female of parent of F_1 .

Gennaëus nycthemerus, "Z" ♀, mottled and vermiculated type of "B."

Gennaëus nycthemerus, "B" ♂, young male of eight months old in first plumage.

3. F_1 . "BA" ♀ ♀.

2. F_2 . "BBA" ♀ ♀.

6. F_3 . "BBBA" ♀ ♀.

5. F_4 . (F_3 , *inter se* "BBBA") ♀ ♀.

First examination giving pattern and colour in detail.

CREST. (PLATE XXII.)

Parent Species.

"B," ♀. *Crest*: blue-black, feathers slender, barbs long, structure degenerate.

Anterior: length $1\frac{1}{8}$ inches.

Posterior: length $1\frac{3}{4}$ inches. Plate XXII, fig. 1.

"B" type of *Gennaëus nycthemerus* ♀ was used throughout the experiment.

"Z," ♀. *Crest*: the same as "B" colour, structure, form and length.

"A," ♀. *Crest*: brown, ruddy buff mark down each side of rachis, feathers broad, barbs very short, structure normal.

Anterior: length $\frac{3}{4}$ of an inch.

Posterior: length $\frac{14}{16}$ of an inch. Plate XXII, fig. 2.

"B," ♂ (8 months). Omitted to extract crest until too late, adult plumage had grown in.

Hybrids.

"BA."

F_1 . ♀♀, "A," "B," "C," "D," "E." Plate XXII, figs. 3, 4, 5, 6.

Crest of all five *hybrid*, dark brown, mottled and vermiculated with red brown, feathers broad, structure normal like female of "A" parent. Length of crest the same in all five.

Anterior: length $\frac{3}{4}$ of an inch.

Posterior: length $1\frac{1}{2}$ inches.

"BBA."

F_2 . ♀♀, "A," "B."

Hybrid.

F_2 . ♀, "A." *Crest*: same pattern, colour, form, structure and length as F_1 . *Hybrid*. Plate XXII, fig. 7.

F_2 . ♀, "B." *Crest*: (rather injured) feathers, darker and shorter.

"BBBA."

F_3 . ♀♀, "A," "B," "P," "C," "A¹," "B¹." Plate XXII, figs. 8, 9, 10.

Hybrid. *Crests*: similar in pattern, colour and form to F_1 , the brown darker, the mottling less distinct.

Structure *hybrid* between "B" parent and female of "A" parent.

Lengths of all six similar.

Anterior: length $\frac{14}{16}$ of an inch.

Posterior: length $1\frac{1}{2}$ inches.

"BBBA," *inter se*.

F_4 . ♀♀. (F_3 , *inter se*), "C," "M," "F," "K," "G." All five *hybrid*.

F_4 . ♀, "C." *Crest*: Posterior and Anterior rusty black, mottled ruddy buff—structure *hybrid*.

Anterior: length 1 inch.

Posterior: length $1\frac{9}{16}$ inches. Plate XXII, fig. 13a, b.

- F*₄. ♀, "M." *Crest*: Anterior, brown thickly mottled ruddy buff—
Hybrid. structure same as female of "A" parent.
Posterior black, mottled ruddy buff—structure *hybrid*.
Plate XXII, fig. 11 *a, b*.
Anterior: length $\frac{3}{4}$ of an inch.
Posterior: length $1\frac{3}{4}$ inches.
- F*₄. ♀, "F." *Crest*: Anterior, brown mottled ruddy buff, hybrid—
Hybrid. structure *hybrid*.
Posterior blue-black like "B" parent—structure *hybrid*.
Plate XXII, fig. 14 *a, b*.
Anterior: length $\frac{1\frac{1}{2}}{6}$ of an inch.
Posterior: length $1\frac{1\frac{1}{2}}{6}$ inches.
- F*₄. ♀, "K." *Crest*: Posterior and Anterior, brown mottled ruddy buff—
Hybrid. structure *hybrid*. Plate XXII, fig. 12 *a, b*.
Anterior: length $\frac{1\frac{1}{2}}{6}$ of an inch.
Posterior: length $1\frac{1}{2}$ inches.
- F*₄. ♀, "G." *Crest*: Posterior and Anterior blue-black like "B" parent
Hybrid. but structure *hybrid*. Plate XXII, fig. 15 *a, b*.
Anterior: length $1\frac{1}{2}$ inches.
Posterior: length $1\frac{1\frac{1}{2}}{6}$ inches.

With one exception, pattern, colouration, form, length and structure of the *crest* are *hybrid* throughout the "B," "A" series, and that exception, *F*₄ "G" (Plate XXII, fig. 15), had the *structure hybrid*.

TAIL. (PLATE XXIII.)

Parent Species.

- Silver "B," ♀. Centrals: very finely mottled.
Moults centrals before laterals. Laterals: first pair vermiculated; all the others have sloping, irregular bands of alternate black and white, the black bands the widest. Plate XXIII, fig. 1.
- Silver "Z," ♀. Centrals: same as "B" ♀.
Laterals: all vermiculated; first and second pairs a finer, all the others a coarser pattern.
- Swinhoe "A," ♀. Central rectrices: pattern, wide bands thickly
Moults laterals before centrals. mottled, divided by narrow ruddy buff bands. Plate XXIII, fig. 3 *a*.
Laterals: copper brown, inner margins mottled black, tips black. Plate XXIII, fig. 3 *b*.

Silver "B," ♂ (eight months bird). Centrals: coarse vermiculation ground white tinted fulvous.

Laterals: sloping regular bands of black and white of equal width. Plate XXIII, fig. 2.

F_1 . "BA," ♀♀. *Tail*. Laterals: pattern of female of "A" parent centrals. *Pattern-transference*. Plate XXIII, fig. 4.

F_2 . "BBA," ♀♀. *Tail*. Centrals and laterals: *hybrid*. Plate XXIII, fig. 5.

F_3 . "BBBA," ♀♀. *Tail*. Centrals: mutation.
Laterals: *hybrid*. Plate XXIII, figs. 6 and 7.

"BBBA," *inter se*.

F_4 . ♀, "C." (F_3 , *inter se*.) Centrals: pattern same as "B" ♀ first pair of laterals, colour *hybrid*. *A Pattern-transference*.

Laterals: *hybrid* pattern and colour.

F_4 . ♀, "M." Centrals: pattern of "Z" ♀ centrals; colour, *hybrid*.
Laterals: *hybrid* pattern and colour.

F_4 . ♀, "F." Centrals: *hybrid* pattern and colour.
Laterals: 1st and 2nd pairs unpatterned olive brown—*hybrid*. Other laterals same *hybrid* pattern and colour as centrals.

F_4 . ♀, "K." Centrals: *hybrid* pattern and colour.
Laterals: somewhat resembling "B" ♀ and young male "B" in pattern; colour, *hybrid*.

F_4 . ♀, "G." Centrals: (mutation) unpatterned olive grey.	} Like parent F_3 ♀ "P," "grey mutation."
Laterals: Very finely vermiculated grey.	

Of these F_4 ♀♀ (F_3 "BBBA," *inter se*), "M," "F," "K" and "G" are darker and greyer birds than any in this series and could be picked out easily when laid amongst the "B" ♀ parent, the F_1 ♀♀, the F_2 ♀♀ and the F_3 ♀♀ not even excepting the grey mutation parent ♀ "P." The heads and necks are dark grey, but *inter se* "BBBA" F_4 ♀ "C" is a somewhat lighter bird than her four sisters, being much the same colour as her parent "grey mutation" "P" only a lighter and more olive tint of grey.

BREAST AND FLANK. (PLATE XXIV.)

Parent Species.

- "B," ♀. *Breast*: fine, irregular, broken, zigzag lines of white on a black ground. Plate XXIV, fig. 1*a*, *b*.
Flank: pattern the same, lines fewer and coarser, ground black. Plate XXIV, fig. 1*c*.
- "Z," ♀. *Breast*: very fine mottling on brownish olive ground.
Flank: mottling coarser, ground lighter tint of same colour.
- "A," ♀. *Breast*: coarse black lines of pointed form on ruddy buff ground. Plate XXIV, fig. 2*a*, *b*.
Flank: same ground colour, lines irregular and broken. Plate XXIV, fig. 2*c*.
- "B," ♂, transition plumage. Breast and Flank. Plate XXIV, fig. 3*a*, *b*, *c*.

*Hybrids.**"BA."*

- F*₁. ♀♀, "A," "B," "C," "D," "E," all *hybrid* in colour and pattern. Plate XXIV, figs. 4, 5.
- F*₁. ♀♀, "E" and "D." *Breast* and *Flank* coarsely vermiculated, somewhat resembling "B" parent but finer lines.
- F*₁. ♀♀, "C" and "A." *Breast* and *Flank*, black vermiculation on ruddy buff ground.

"BBA."

- F*₂. ♀♀, "A" and "B." *Hybrid* colour and pattern.
- F*₂. ♀, "A." *Breast* and *Flank* very fine grey vermiculation on pale buff ground. Plate XXIV, fig. 6.
- F*₂. ♀, "B." *Breast* and *Flank*, coarse black vermiculation on pale buff ground. Plate XXIV, fig. 7.

"BBBA."

- F*₃. ♀♀, "A," "B," "C" and "P" are again all *hybrid* in pattern and colour and show a remarkable degree of variation in these areas.
- F*₃. ♀, "A." *Breast* and *Flank* alike, coarse, broken, black, zigzag lines on a light buff ground.

*F*₃. ♀, "B." *Breast*: coarse vermiculation, ground a pale olive shade of buff; the Anterior feathers resemble "Z" ♀.

Flank: coarse vermiculation or broken lines on same ground.

*F*₃. ♀, "C." *Breast*: Posterior feathers, in that the lines are light on a black ground, resemble "B" parent, but in the form and colour of them, pale buff, they differ. Anterior feathers *hybrid*. Plate XXIV, fig. 8*a*, *b*.

Flank: light lines on black ground resembling "B" parent but again the form and colour, pale buff, differ. Plate XXIV, fig. 8*c*.

*F*₃. ♀, "P." (Grey mutation.)

Breast: Anterior dark grey; Posterior, fine dark grey vermiculation on pale grey ground. Plate XXIV, fig. 9*a*, *b*.

Flank: same as Posterior feathers.

"BBBA," *inter se*.

*F*₄. ♀♀, "K," "F," "M," "C," "G," all hybrid, patterns widely divergent, showing segregation.

*F*₄. ♀, "K." *Breast* and *Flank*: light broken lines on dark ground like "B" parent are nevertheless hybrid in pattern and colour of lines, which are buff. Plate XXIV, fig. 12*a*, *b*.

*F*₄. ♀, "F." *Breast* almost an unpatterned olive of a buff shade, some very fine mottling on part of the feathers. Plate XXIV, fig. 13*a*.

Flank fine vermiculation on lighter shade of buff olive. Plate XXIV, fig. 13*b*.

*F*₄. ♀, "M." *Breast*: Anterior *hybrid*; Posterior like "A" ♀ also resembling in pattern the *flank* feather of the young eight months old male of "B" parent. Plate XXIV, fig. 3*b*, *c*. A sex pattern-transference. Plate XXIV, fig. 14*a*.

Flank: *hybrid*; over all these feathers lies the buff stain of "A" parentage. Plate XXIV, fig. 14*b*.

*F*₄. ♀, "C." *Breast* and *Flank*: *hybrid*, like "M," the "A" parentage is clearly traced both in pattern and in the colour, a warm buff, which suffuses both areas. Plate XXIV, fig. 10*a*, *b*.

F_4 . ♀, "G." (This bird is being bred from, 1913.)

Breast: Anterior, dark silver grey; Posterior, dark silver grey vermiculation and mottling on lighter grey ground. Plate XXIV, fig. 11a.

Flank: Dark silver grey mottling on slightly paler grey ground. Plate XXIV, fig. 11b.

Degeneration in size of feathers.

It is to be remarked that the size so diminishes and the form so alters in the breast and flank feathers of two F_3 and all the F_4 as hardly to be recognised as having been extracted from the same areas as those of the females of the parent species. The pointed form referred to is a male character in both species but much more extreme in the Swinhoe ♂.

Laying the four F_4 *inter se* ♀♀ "K," "F," "M," "C" breast uppermost beside "B" parent and the female of "A" parent, the Mendelian segregation is distinct, ♀ "K" resembles "B" parent, ♀ "F" neither parent, whilst ♀♀ "M" and "C" though hybrid, yet have a strong family resemblance to the female of "A" parent.

WING. (PLATE XXV.)

Parent Species.

Primaries. Secondaries. Major Coverts.

- "B," ♀. *Primary*: inner vane grey self, outer vermiculated buff.
Primary Major Covert: similar.
Secondary: grey ground vermiculated and mottled buff.
 Plate XXV, fig. 1.
Secondary Major Covert: similar. Plate XXV, fig. 10a.
- "Z," ♀. *Primary*: same as "B," colour browner, vermiculation finer.
Major Covert: to correspond.
Secondary: same as Primary.
Major Covert: rather browner vermiculation.
- "A," ♀. *Primary*: wide bands of dark grey divided by narrow bands of warm ruddy buff.
Secondary: similar pattern, bands of warm ruddy buff narrower.

In both areas the ruddy buff bands are spotted here and there with dark grey. Plate XXV, fig. 3a, b.

Major Coverts: same colour and pattern with heavier sprinkling of spots on the ruddy buff bands. Plate XXV, fig. 10b.

"B," ♂ (eight months old). Transition plumage.

Primary: grey ground, coarse fulvous vermiculation on outer vane and tip of inner vane.

Secondary: grey ground very coarse fulvous vermiculation on both vanes. Plate XXV, fig. 2a.

On both the lines of vermiculation are generally continuous and unbroken.

Adult Secondary. Plate XXV, fig. 2b.

Hybrids.

"BA."

F₁. ♀ ♀, "A," "B," "C" (Plate XXV, fig. 4), "D," "E," all five have both *Primaries* and *Secondaries* the pattern and colour of the female of "A" parent: the ruddy buff bands are rather more thickly spotted.

Major Coverts, both primary and secondary groups the same as the female of "A" parent. Plate XXV, fig. 10c, d, e.

"BBA."

F₂. ♀ ♀, "A," "B" (Plate XXV, fig. 5). In both birds *Primaries* and *Secondaries* colour of female of "A" parent, *pattern hybrid*, a coarse broken vermiculation, both vanes patterned.

Major Coverts of both *hybrid*.

"BBBA."

F₃. ♀ ♀, "A," "B," "C," "P" (grey mutation), also "A¹" and "B¹."

F₃. ♀ ♀, "A," "B," "A¹," "B¹." *Primaries* and *Secondaries*, colour of female of "A" parent, *pattern hybrid*, similar to F₂. Plate XXV, fig. 6.

F₃. ♀, "P" (grey mutation). *Primaries* and *Secondaries*, very dark grey finely mottled. Plate XXV, fig. 7.

F₃. ♀, "C." *Primaries* and *Secondaries*. Colour of female of "A" parent but with finer vermiculation than "A," "B," "A¹," "B¹."

In all, vermiculation is much broken.

"BBBA," *inter se*.

F₄. "C," "M," "F," "K," "G."

F₄. ♀, "K." *Primaries, Secondaries, Major Coverts, hybrid*, same as F₃ "A," "B," "C," "A¹," "B¹."

F₄. ♀, "F." *Primaries, Secondaries, Major Coverts, hybrid*, greyer colouration more finely vermiculated. Plate XXV, fig. 9.

F₄. ♀, "C." *Primaries, Secondaries, Major Coverts* similar to "K" and F₃. *Hybrid*. Plate XXV, fig. 8.

F₄. ♀, "M." *Primaries, Secondaries, Major Coverts*, pattern similar to F₄ "C" and "K," but less distinct and colour greyer and darker. *Hybrid*.

F₄. ♀, "G." *Primaries, Secondaries*, very dark grey finely mottled like F₃ ♀ "P" the parent.

THIGH. (PLATE XXVI.)

In this area in the pheasant the dimensions of the feathers are reversed, the Posterior being the smaller, the Anterior the larger.

Parent Species.

"B," ♀. *Thigh*: Posterior and Anterior, pure white zigzag lines on black ground. Plate XXVI, fig. 1a, b.

"Z," ♀. *Thigh*: Posterior and Anterior, pattern *grey*, less regular sometimes undefined on *cream* ground.

"A," ♀. *Thigh*: Posterior and Anterior, dark grey zigzag lines on ruddy buff ground. Plate XXVI, fig. 2a, b.

"B," ♂ (eight months old). Transition plumage. White lines on greyish black ground. Plate XXVI, fig. 3a, b.

Hybrids.

"BA."

F₁. ♀ ♀, "A," "C," "D," "E."

Thigh: patterns *hybrid*, some like "Z," colour ruddy buff same as female of "A" parent. Plate XXVI, figs. 5, 6a, b.

F₁. ♀, "B." *Thigh*: the lines are finer, more delicate and so broken as to be almost mottled. Plate XXVI, fig. 4a, b.

“BBA.”

F_2 . ♀♀, “A,” “B.” *Thigh*: colouration of F_1 , all feathers smaller than parents “B” and “A” or F_1 .

F_2 . ♀, “A.” *Thigh*: pattern *hybrid*, somewhat coarse. Plate XXVI, fig. 7 *a, b*.

F_2 . ♀, “B.” *Thigh*: pattern same as F_1 “B,” *hybrid*. Plate XXVI, fig. 8 *a, b*.

“BBBA.”

F_3 . ♀♀, “A,” “B,” “C,” “P.” *Thigh*: all feathers *very* much smaller than parents and F_1 . Patterns and colouration *hybrid*, much individual variation.

F_3 . ♀, “C.” *Thigh*: Posterior and Anterior closely resemble “B” parent in pattern, ground *hybrid* tinged buff. Plate XXVI, fig. 11 *a, b*.

F_3 . ♀, “P” (grey mutation). *Thigh*: Posterior and Anterior fine grey lines on paler grey ground. Plate XXVI, fig. 12 *a, b*.

F_3 . ♀, “A.” *Thigh*: Posterior same as F_3 ♀ “P,” Anterior same as F_3 “C,” but ground a deeper tinge of buff. *Hybrid*. Plate XXVI, fig. 9 *a, b*.

F_3 . ♀, “B.” *Thigh*: Posterior and Anterior pattern and colour same as F_2 “A.” Plate XXVI, fig. 10 *a, b*.

“BBBA,” *inter se*.

F_4 . ♀♀, “C,” “M,” “F,” “K,” “G.” In all these birds the thigh feathers are still more diminished in size than those of F_3 ♀♀.

F_4 . ♀, “C.” *Thigh*: Posterior, *pattern of female of “A” parent*, ruddy Degeneration buff ground paler. Anterior, pattern of female of “A” in size of feather, ruddy buff ground paler. This feather measures just half the length of that of female of “A” parent extracted from the same zone.

F_4 . ♀, “M.” *Thigh*: Posterior and Anterior, pattern of female of “A” parent *breast*, ground colour pale ruddy buff. Pattern-transference.

F_4 . ♀, “F.” *Thigh*: Posterior and Anterior, grey pattern like “Z” but ground colour *hybrid* of the ruddy buff shade belonging to “A” parent.

F_4 . ♀, “K.” *Thigh*: Posterior, pattern of “B” parent. Anterior, feathers very degenerate but “B” pattern can be traced, ground *hybrid*, pale fulvous.

F_4 . ♀, "G." *Thigh*: Posterior and Anterior, pattern of very marked scratchings of dark silver grey on pale cream ground. Size of feathers very small.

The gradual degeneration in the dimension of the feathers in the thigh area (Plate XXVI) is a marked and distinct feature of the series which reaches the point in F_4 "K," of degeneration of the barbs. In this area of their plumage the F_4 ♀♀ (F_3 , *inter se*) show the same individual Mendelian segregation as in the breast and flank (Plate XXIV). This dwindling in size associated with change of form was also observed in the breast and flank of some F_3 ♀♀ and all the F_4 ♀♀ (Plate XXIV).

APPENDIX B.

INVESTIGATION INTO ORIGIN OF HYBRID CONDITION.

TAIL. (PLATE XXIII.)

	<i>Central pattern</i>	<i>Lateral pattern</i>
F_1 . "BA," ♀♀, <i>Hybrid</i> .	Silver ♂, 8 months, lateral.	Swinhoe ♀, central. Plate XXIII, fig. 2.
	<i>Colour</i>	<i>Colour</i>
	Swinhoe ♀, central.	Silver ♀, lateral.
	Silver ♀, lateral.	Swinhoe ♀, lateral.
F_2, F_3, F_4 , all <i>hybrid</i> .	Plate XXIII, figs. 5, 6, 7.	
F_3 ♀ mutation "P."	2nd lateral exact shade of delicate grey found on Silver ♂ transition plumage anterior scapulars. Plate XXIII, fig. 7 and Plate XXII, fig. 6.	

BREAST AND FLANK. (PLATE XXIV.)

Second examination alongside of 8 month immature plumage of Silver ♂.

	<i>Patterns</i>	
F_4 . "BBBA" <i>inter se</i> , "C" ♀, <i>Hybrid</i> .	a. Silver ♀, "B." Plate XXIV, fig. 1c.	
	b. Silver ♂, 8 month. Plate XXIV, fig. 3b.	
Breast.	Plate XXIV, fig. 10a.	
Flank.	" " " b.	
	<i>Colour</i>	
	Fig. 10a, b.	Swinhoe ♀ and Silver ♂, 8 month.
	" "	" "

294 *Secondary Sexual Characters in Pheasants*

Breast feathers. The pointed form of Silver ♂ adult breast and Swinhoe ♂ adult breast feathers. Size degenerate.

Patterns

- F*₄. "BBBA" *inter se*, "M" ♀, *Hybrid*. Swinhoe ♀, Pl. XXIV, fig. 2.
Plate XXIV, fig. 14, *a, b*. Silver ♂, 8 month, Pl. XXIV, fig. 3.
Silver ♀, "b" variety, Pl. XXIV, fig. 1.

Colour

Silver ♂.
Swinhoe ♀.

Breast feathers: the pointed form of Silver ♂ and Swinhoe ♂ breast feathers. Size degenerate.

Patterns

- F*₄. "BBBA" *inter se*, "K" ♀, *Hybrid*. Silver ♂, interscapulars transition.
Swinhoe ♀.
Silver ♀, "B."

Colour

Silver ♂, transition.
Swinhoe ♀.

Breast feathers: the pointed form of Silver ♂ and Swinhoe ♂ breast feathers. Size degenerate.

WING. (PLATE XXV.)

- F*₁. "BA," ♀ ♀. All very similar and level in colour, pattern, and form of Primaries, Secondaries and their respective coverts. *Hybrid*. Both Primaries and Secondaries are alike in pattern.

Number of bands: same as Silver ♂ adult secondary (Plate XXV, fig. 2*b*). *Pattern*, Swinhoe ♀ (Plate XXV, fig. 3*b*). *Colour*, Swinhoe ♀.

- F*₂. "BBA," ♀ ♀. Pattern, colour and form of Primaries and Secondaries alike in all the birds. Resemblance closest to Silver ♂ 8 month transition secondary (Plate XXV, fig. 2*a*) with a possible trace of Silver ♀ secondary (Plate XXV, fig. 1) and Swinhoe ♀ lateral pattern (Plate XXIII, fig. 3*b*).
*F*₃. "BBBA." No change, *hybrid* and very level in colour, pattern, and form; replicas of *F*₂ "BBA" ♀ ♀. Plate XXV, figs. 6, 7.

Finding that two distinct patterns of the Silver hen exist in the aviaries of this country I sent a breast feather of each to the Natural History Museum, South Kensington, and I append to this paper a table, kindly made at my request by Mr Ogilvie Grant, of the patterns of the wild *G. nycthemerus* from the specimens at the Natural History Museum, which shows these birds to be in a mutating or extremely varying

NOTES FROM BRITISH MUSEUM, NATURAL HISTORY,
ORNITHOLOGICAL DEPARTMENT.

Gennaesus nycthemerus.

			B	Z	C	D
♀	Ah Ch'ung, Fohkien, S. China	7 Dec. '02	B	—	C	—
♀	Kuatum, N.W. Fohkien	26 Nov. '01	B	—	—	D
♀	" "	16 Mar. '99	—	Z	—	D
♀	" "	3 Nov. '98	B	—	C	—
♀	" "	8 Nov. '98	—	Z	—	D
♀	" "	6 Nov. '98	—	Z	—	D
♀	" "	8 Nov. '98	—	Z	—	D
♀	" "	6 Nov. '01	—	Z	C	—
♀	" "	3 Nov. '98	—	Z	C	—
♀	" "	17 Oct. '96	—	Z	C	—
♀	Amoy (Aviary)...	Jan. '98	—	Z	—	D

B, Z, see illustration below (1) B type, (2) Z type.

C, Lateral tail-feathers finely mottled or vermiculated with black and white.

D, Lateral tail-feathers black and white in wavy bars.



Fig. 1.

Fig. 2.

Breast feathers of the two types B (1) and Z (2) of the female *Gennaesus nycthemerus*.

condition of plumage, of such a nature that the two extremes of the scale of patterns would undoubtedly, if found in the ♂♂, have been classed separately. Now though these might account in some measure for the widely divergent patterns met with in the series we are considering, yet they do not furnish us with the real clue to the origin of those colours and patterns found in the legs and plumage of "BA," "BBA," "BBBA," and *inter se* "BBBA" ♀♀; thus, in one area, the crest (which has the same structure, pattern and colour in both "B" and "Z" varieties of Silver ♀), the characters of the female of "A" parent can be clearly traced in every adult ♀ throughout these four generations, and in several other plumage areas (with the exception of one or two of the birds) the characters of the female of "A" parent are present.

"Wild females of the Silver Pheasant vary considerably individually in the characters of the outer tail-feathers and the feathers of the breast and flanks.

As regards the outer tail-feathers, in some specimens they are black with oblique mottled lines of white; in others they are very finely vermiculated with black and brownish-white; and all intermediate gradations are to be found.

Young birds have the breast and flank-feathers uniform brown; in older birds the breast and flank-feathers may be either finely or coarsely marked with black and white.

These remarks are based entirely on wild shot birds from China."

DESCRIPTION OF PLATES.

PLATE XXII.

CREST.

- Fig. 1. "B" Silver ♀.
 Fig. 2. "A" Swinhoe ♀, female of "A" parent species.
 Fig. 3. "BA" F₁, "A" ♀.
 Fig. 4. "BA" F₁, "C" ♀.
 Fig. 5. "BA" F₁, "D" ♀.
 Fig. 6. "BA" F₁, "E" ♀.
 Fig. 7. "BBA" F₂, "A" ♀.
 Fig. 8. "BBBA" F₃, "A" ♀.
 Fig. 9. "BBBA" F₃, "C" ♀.
 Fig. 10. "BBBA" F₃, "P" ♀.
 Fig. 11. "BBBA" *inter se*, F₄, "M" ♀. Anterior, a; posterior, b.
 Fig. 12. "BBBA" *inter se*, F₄, "K" ♀. Anterior, a; posterior, b.
 Fig. 13. "BBBA" *inter se*, F₄, "C" ♀. Anterior, a; posterior, b.
 Fig. 14. "BBBA" *inter se*, F₄, "F" ♀. Anterior, a; posterior, b.
 Fig. 15. "BBBA" *inter se*, F₄, "G" (mutation). Anterior, a; posterior, b.
 Fig. 16. "B" Silver ♂ (male of "B" parent species) transition plumage. a, Breast; b, Scapular.
 "BBBA" F₃, "P" ♀. c, Lateral rectrix.

PLATE XXIII.

TAIL.

- Fig. 1. "B" Silver ♀ ("B" parent). Lateral.
 Fig. 2. "B" Silver ♂ (transition plumage). Lateral.
 Fig. 3. "A" Swinhoe ♀, female of "A" parent species. *a*, Central rectrix; *b*, lateral rectrix.
 Fig. 4. "BA" F₁, "B" ♀. Lateral.
 Fig. 5. "BBA" F₂, "A" ♀. Lateral.
 Fig. 6. "BBBA" F₃, "P" ♀. Lateral.
 Fig. 7. "BBBA" F₃, "A" ♀. Lateral.

PLATE XXIV.

BREAST AND FLANK.

- Fig. 1. "B" Silver ♀. Breast: *a*, posterior; *b*, anterior. *c*, Flank.
 Fig. 2. "A" Swinhoe ♀. Breast: *a*, posterior; *b*, anterior. *c*, Flank (female of "A" parent species).
 Fig. 3. "B" Silver ♂ (transition plumage). *a*, Breast. *b*, *c*, Flank.
 Fig. 4. "BA" F₁, "B" ♀. Breast: *a*, anterior; *b*, posterior.
 Fig. 5. "BA" F₁, "E" ♀. Breast, posterior.
 Fig. 6. "BBA" F₂, "A" ♀. Breast, posterior.
 Fig. 7. "BBA" F₂, "B" ♀. Breast, anterior.
 Fig. 8. "BBBA" F₃, "C" ♀. Breast: *a*, posterior; *b*, anterior. *c*, Flank.
 Fig. 9. "BBBA" F₃, "P" ♀. Breast: *a*, posterior; *b*, anterior.
 Fig. 10. "BBBA" *inter se*, F₄, "C" ♀. Breast, *a*. Flank, *b*.
 Fig. 11. "BBBA" *inter se*, F₄, "G" ♀. Breast: *a*, posterior; *b*, anterior.
 Fig. 12. "BBBA" *inter se*, F₄, "K" ♀. Breast, *a*. Flank, *b*.
 Fig. 13. "BBBA" *inter se*, F₄, "F" ♀. Breast, *a*. Flank, *b*.
 Fig. 14. "BBBA" *inter se*, F₄, "M" ♀. Breast, *a*. Flank, *b*.

PLATE XXV.

WING. SECONDARIES AND MAJOR COVERTS.

- Fig. 1. "B" Silver ♀. Secondary.
 Fig. 2. "B" Silver ♂. *a*, Transition secondary; *b*, Adult secondary.
 Fig. 3. "A" Swinhoe ♀, female of "A" parent species. *a*, Secondary; *b*, Secondary.
 Fig. 4. "BA" F₁, "C" ♀. Secondary.
 Fig. 5. "BBA" F₂, "B" ♀. Secondary.
 Fig. 6. "BBBA" F₃, "B" ♀. Secondary.
 Fig. 7. "BBBA" F₃, "P" ♀. Secondary.
 Fig. 8. "BBBA" *inter se*, F₄, "C" ♀. Secondary.
 Fig. 9. "BBBA" *inter se*, F₄, "F" ♀. Secondary.
 Fig. 10. Major Coverts. *a*, "B" Silver ♀; *b*, "A" Swinhoe ♀; *c*, *d*, *e*, "BA" F₁, ♀ ♀.

PLATE XXVI.

THIGH.

- Fig. 1. "B" Silver ♀. *a*, posterior; *b*, anterior.
 Fig. 2. "A" Swinhoe ♀, female of "A" parent species. *a*, posterior; *b*, anterior.
 Fig. 3. "B" Silver ♂ (transition plumage). *a*, posterior; *b*, anterior.
 Fig. 4. "BA" F₁, "B" ♀. *a*, posterior; *b*, anterior.
 Fig. 5. "BA" F₁, "C" ♀. *a*, posterior; *b*, anterior.
 Fig. 6. "BA" F₁, "E" ♀. *a*, posterior; *b*, anterior.
 Fig. 7. "BBA" F₂, "A" ♀. *a*, posterior; *b*, anterior.
 Fig. 8. "BBA" F₂, "B" ♀. *a*, posterior; *b*, anterior.
 Fig. 9. "BBBA" F₃, "A" ♀. *a*, posterior; *b*, anterior.
 Fig. 10. "BBBA" F₃, "B" ♀. *a*, posterior; *b*, anterior.
 Fig. 11. "BBBA" F₃, "C" ♀. *a*, posterior; *b*, anterior.
 Fig. 12. "BBBA" F₃, "P" ♀. *a*, posterior; *b*, anterior.

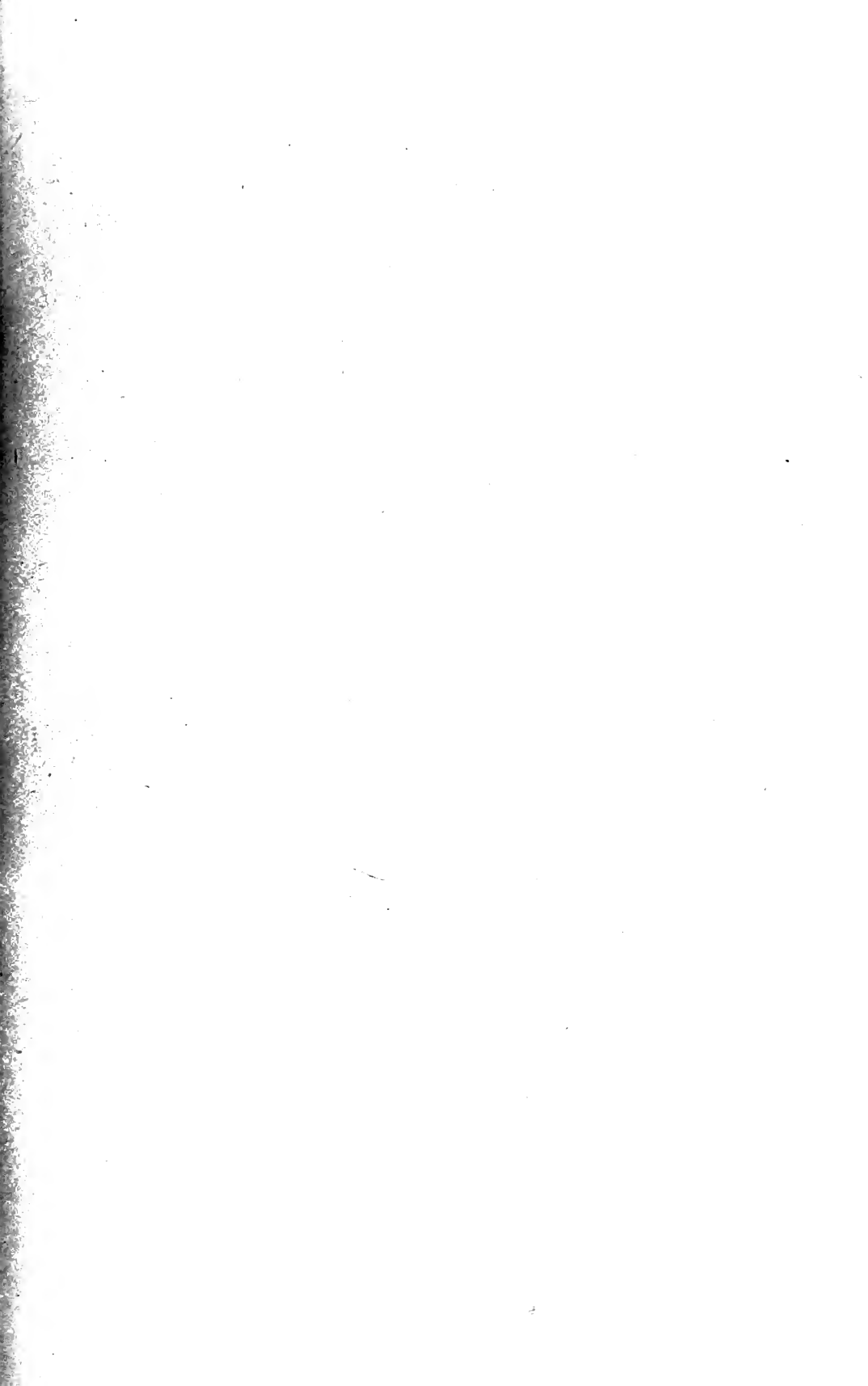



16

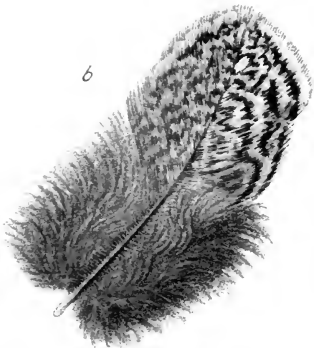
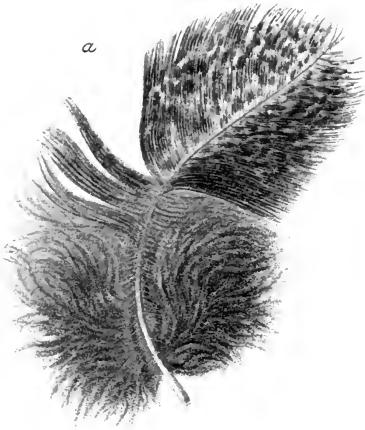

c

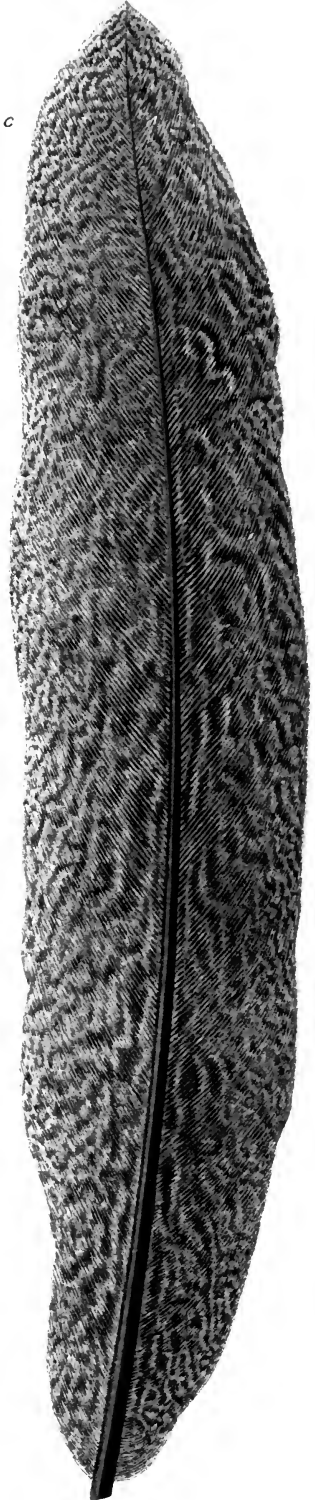



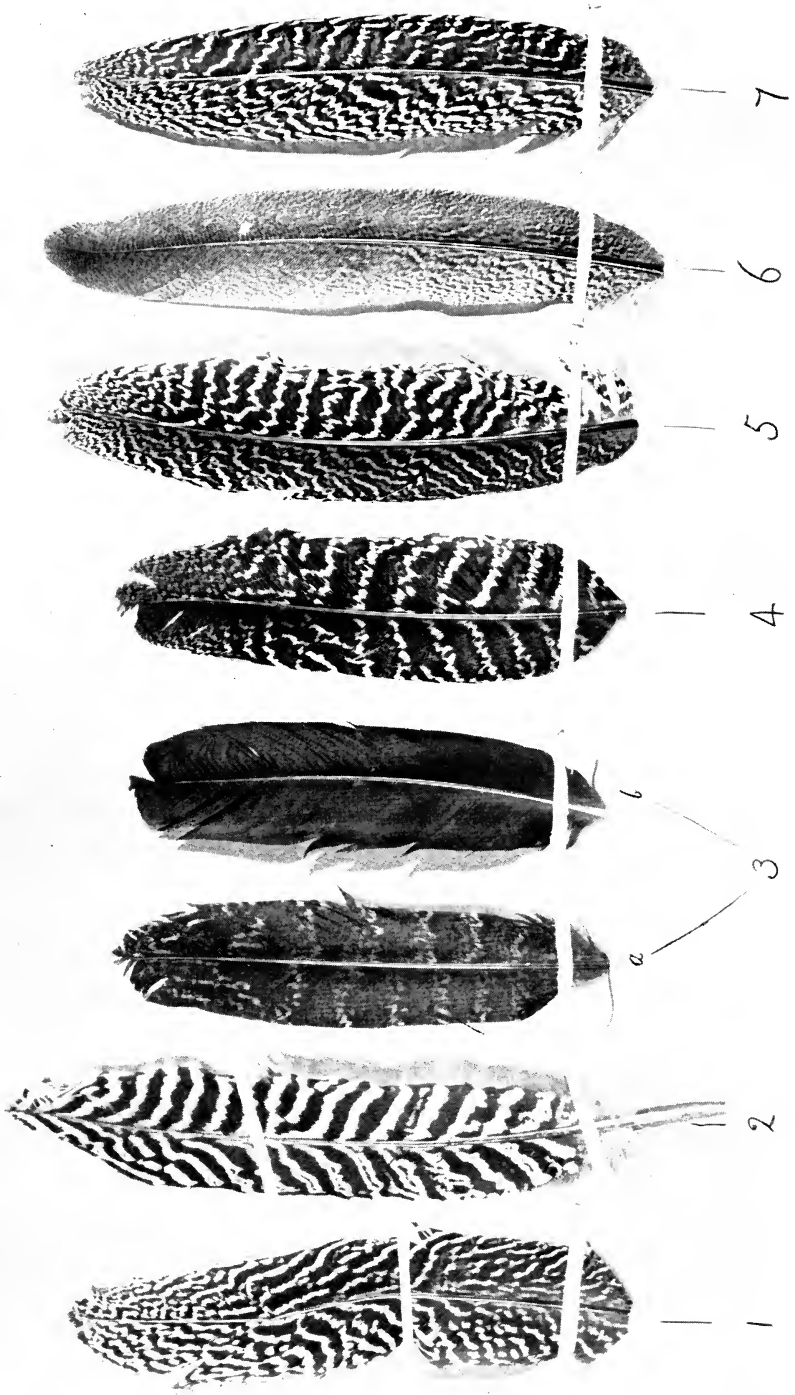

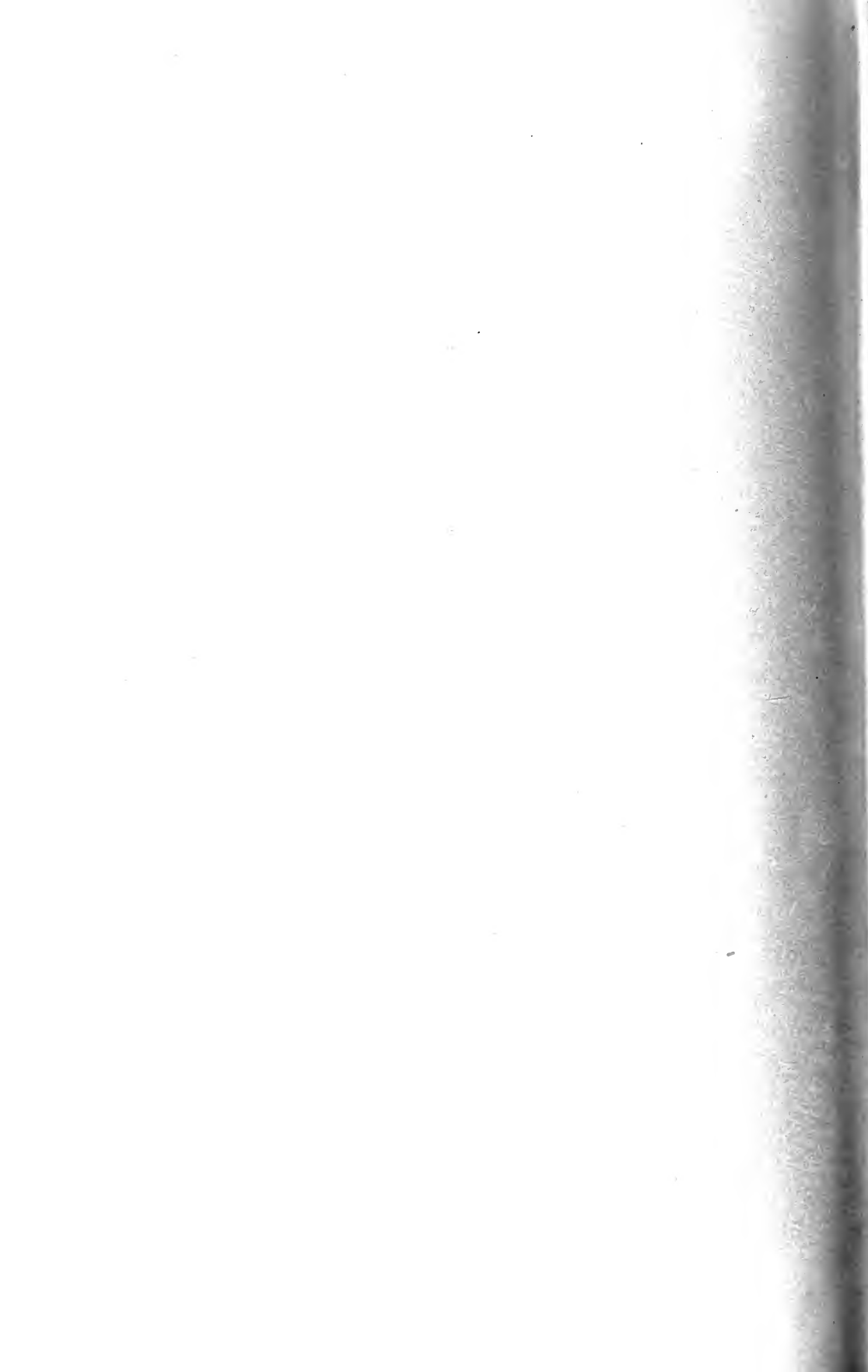





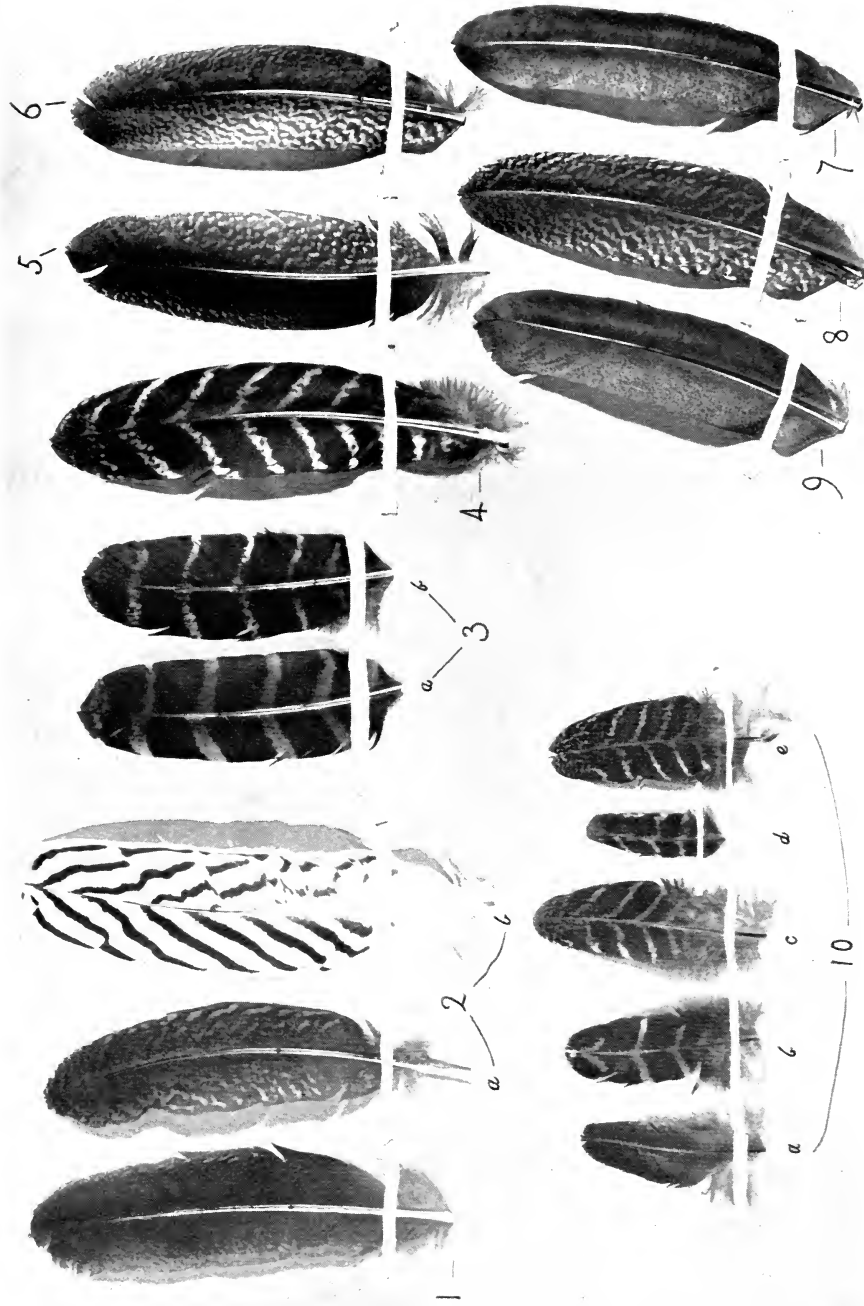



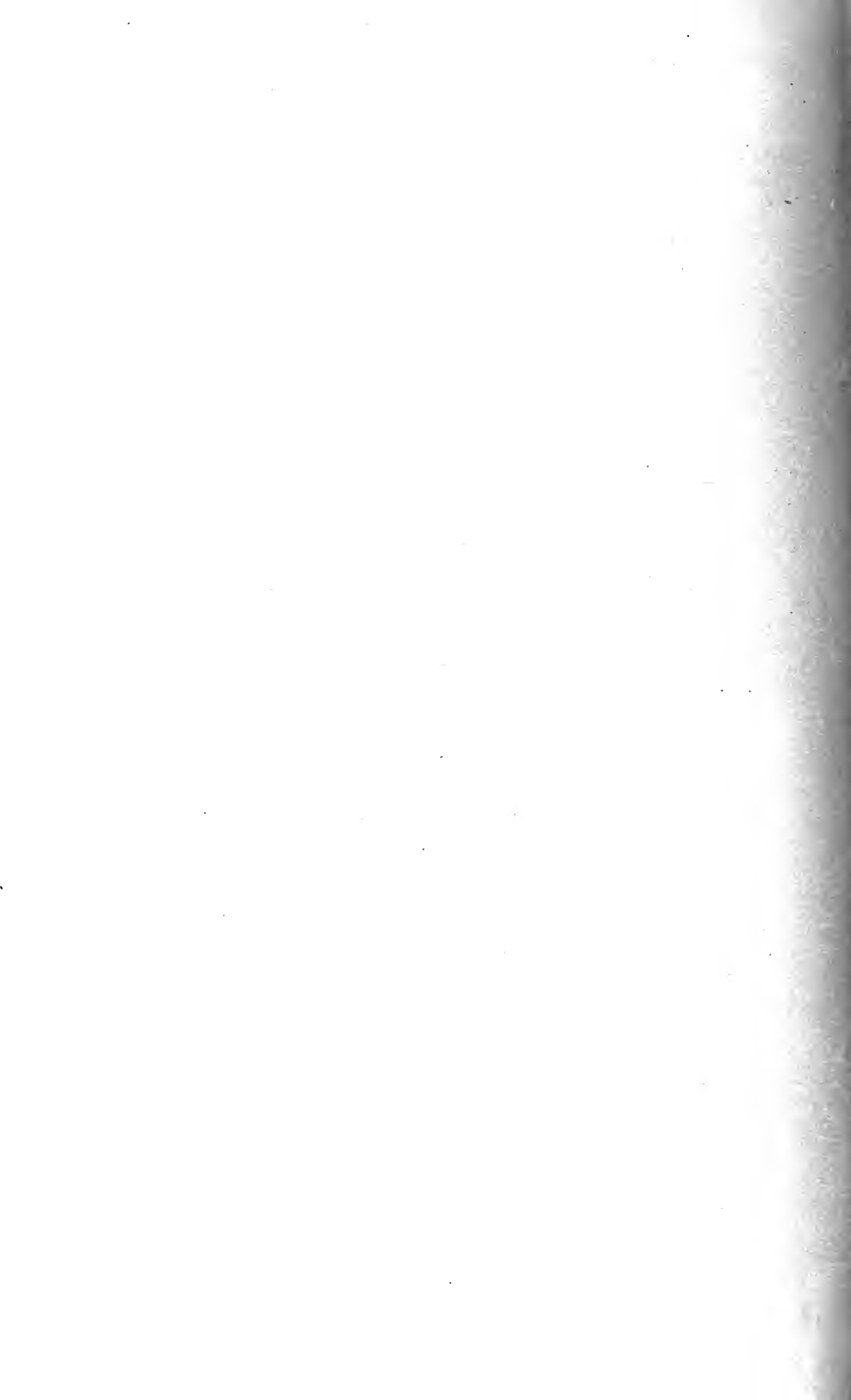

HEREDITY OF MELANISM IN LEPIDOPTERA.

By W. BOWATER, B.D.S.

IN certain of the Lepidoptera (not naturally black) black specimens occasionally appear, and it has been noticed that this melanism has become more and more frequent of recent years, that in some species the black specimens are to-day distinctly more numerous than the original type, and in some localities have even superseded it¹.

Such an evolutionary change obviously possesses features of considerable scientific interest, and much has been written on the subject of its causation and the exact method in which it is being carried on, but the question is still unsettled.

Apparently the term melanism as applied to Lepidoptera should be restricted to the substitution or increase of black on the wings or body, or both, at the expense of some other colour; but any darkening of the ground colour, even if not black, has been included in a general way, although strictly the term melanochromism should be applied to the latter.

I have compiled a list² of 211 species of British Lepidoptera in which melanic or melanochromic specimens have been recorded.

Although the heredity of melanism in the higher orders has been worked out in many species, comparatively little seems to have been done with regard to Lepidoptera, and it is still a fairly open question as

¹ Collective Inquiry as to Progressive Melanism in Lepidoptera. L. Doncaster. *Ent. Record*, Vol. xviii. 1906.

² (a) Melanism and Melanochromism. Tutt.

(b) List of varieties and aberrations peculiar to British Isles. Tutt. *Ent. Record*, 1902.

(c) Melanism in Yorkshire Lepidoptera. Porritt. *Trans. Brit. Ass.* 1906.

(d) *Feuille des Jeunes Naturalistes*. April, 1913.

(e) Standfuss, *Handbuch d. Gross-Schmetterlinge*, 1896.

(f) *Les Mécanismes du Mélanisme et de l'Albinisme chez les Lépidoptères*. Pietet. Geneva, 1912.

(g) *Entomologist* and other sources.

to whether the heredity of melanism in these insects follows definite rules, and especially as to whether it follows Mendelian Laws of Heredity.

In the literature bearing on the subject records are to be found of the breeding by entomologists of many thousands of moths which have melanic forms, but the accounts are very seldom of such a nature as to allow inferences to be drawn as to whether the heredity is Mendelian or otherwise.

In 12 species definite investigations have been made or are being made :

1. *Spilosoma lubricipeda*. The experiment of Mr J. Harrison¹ on this species and its melanic variety *zatima*, Cramer (= var. *radiata*, Haworth), and other experiments made here², and abroad³, seem to show that there is no complete dominance, but by selective breeding pure strains of the melanic forms have been obtained, and an interesting point is that these forms become larger and stronger than the type, and double-brooded.

2. *Aplecta nebulosa*. Experiments have been carried out by Messrs Mansbridge, Harrison and Main (see table), and to my mind prove that melanism is a Mendelian dominant; and a point of special interest is that the homozygous and heterozygous forms are probably distinguishable. In the first instances it seemed certain that the melanic variety *thompsoni*, which is black but has white terminal area (i.e. wing margin and fringes), is the homozygous form; and the melanic variety *robsoni*, a dark suffused form, at times almost black, but never with white terminal area, is the heterozygote.

Mr Mansbridge now considers it likely that only those specimens of *robsoni* which have grey scapular areas are the heterozygotes and hopes to settle the question by experiments now in hand.

Of the 10 families recorded in the table, only one, the last, fails to support the assumption that melanism is dominant, the fact that 13 type specimens appeared seems to show that both parents are heterozygous, which is not impossible, as entomologists differ as to the exact differentiation of the two melanic varieties, *thompsoni* and *robsoni*; and unless the specimens are in perfect condition it is most difficult to decide.

¹ *Entomologist*, 1893, pp. 65, 247, 346; 1894, pp. 95, 129, 205.

² *Naturalist*, 1894. W. Hewett, p. 253.

³ Standfuss, *Handbuch d. Gross-Schmetterlinge*, 1896, p. 307.

Another difficulty is that this species is particularly liable to succumb in confinement even in the hands of the most expert, and inbreeding seems always fatal.

Aplecta nebulosa.

Date	Observer	Parentage	Imagines		Type
			Melanic		
			<i>Thompsoni</i>	<i>Robsoni</i>	
		♂ × ♀			
1908	Harrison ¹	Type × Type	—	—	all
1905	Mansbridge	Type × Type	—	—	76
1906	„	? × <i>robsoni</i> wild	—	16	15
1908	„	Type × <i>thompsoni</i>	—	16	—
1909	„	Type × <i>robsoni</i>	—	4	1
1909	„	<i>robsoni</i> × <i>robsoni</i>	7	15	8
1910	„	<i>robsoni</i> × <i>robsoni</i>	15	27	9
1911	„	<i>robsoni</i> × <i>robsoni</i>	3	27	25
1908	Harrison and Main ¹	<i>robsoni</i> × <i>robsoni</i>	*67	158	75
1910	„ „ ²	<i>thompsoni</i> × <i>robsoni</i>	16	21	13

* Approximate numbers.

The melanic form does not appear to be increasing in Delamere Forest, and of 972 imagines reared by Mr Mansbridge from larvae collected there during the last 9 years, 142 are melanic, but only 3 of these are *thompsoni*.

Thus it seems that although melanism is dominant in this species, yet in Nature there is some factor which counterbalances this at present, and prevents the variety becoming more common.

3. *Triphaena comès*. Messrs Prout and Bacot³ conducted breeding experiments in 1903, 1904, which showed that in this species melanism is dominant, but not completely so, as its depth varies, but Mendelian segregation occurs.

4. With *Boarmia repandata*, Mr Mansbridge has been experimenting for some years, but quite conclusive results are not expected until next year.

5. The same applies to *Tephrosia consonaria* and Mr J. W. H. Harrison.

¹ *Proc. Ent. Soc. Lond.* October 21, 1908, p. lxi. *Proc. South Lond. Entom. and Nat. Hist. Soc.* 1908—09, p. 84, and 1909—10, p. 64.

² *Trans. Ent. Soc. Lond.* May 3, 1911.

³ *Ent. Record*, Vol. xv. 1903, pp. 217—221; Vol. xvi. 1904, pp. 1—5. *Proc. Ent. Soc. Lond.* 1905, pp. 67—71.

6. *Acidalia virgularia*. The classical experiments of Messrs Prout and Bacot¹ on this species, where they reared 10 generations represented by 5531 specimens, showed that the two varieties—London, dark, and French, light—were not Mendelian forms of the species, but the experiments were of great value in proving other points in heredity.

Ova from pairings in generation F_{10} were given to Mr Bateson, who in February, 1909, handed the resultant larvae to Mr W. B. Alexander², who successfully reared them and carried on further broods, and eventually, with the aid of the former specimens and his own, demonstrated that although *A. virgularia* and its light variety, *canteneraria*, had been proved not to be Mendelian forms of the species, yet one of the differences between the two forms, namely, the speckling in *virgularia*, behaves as a Mendelian dominant to the absence of speckling in *canteneraria*. Here then is a Mendelian rule, but the variation in the ground colour obscured the evidence of it.

Mr R. T. Baumann³ has recently bred *black* specimens of *virgularia* and with Mr Bacot is conducting further experiments on the heredity of this form.

7. *Acidalia contiguaria*. Mr W. Buckley, in a series of experiments on the dark form of this species extending through 8 generations, has produced evidence, conclusive to my mind, that the dark form is a simple Mendelian dominant. The experiment is still going on, and detailed results are as yet unpublished.

8. *Xanthorhoe ferrugata* = *Coremia unidentaria*. The breeding experiments of Mr L. B. Prout⁴ in 1895 show conclusively that this species follows Mendelian rules.

In addition to the facts contained in the paper, the author drew certain conclusions which he afterwards modified, and is now quite in accord with the statement that the experiment proves the reddish or purple form to be dominant and the black form recessive⁵.

9. *Abraxas grossulariata*. The black variety of this moth (*variegata*) has been bred by Messrs Porritt and Newman, and it seems that it follows Mendelian lines but is recessive to the type⁶.

¹ *Proc. Roy. Soc. Lond. B.* Vol. 81, 1909.

² *Proc. Roy. Soc. Lond.* 1912, p. 45.

³ *Entomologist*, February 1913, p. 30.

⁴ *Trans. City of Lond. Ent. Soc.* 1897—98, pp. 26—34, and *Trans. Ent. Soc. Lond.* 1906, pp. 525—531.

⁵ *Proc. Ent. Soc. Lond.* 1907, p. xx.

⁶ *Ent.* 1909, p. 75.

Mr B. H. Crabtree is now conducting an experiment, commenced in 1912, which apparently makes this certain.

10. *Hemerophila abruptaria*. Mr Harris¹ and Mr T. H. Hamling² have shown that the dark form is a Mendelian dominant.

11. I can discover only two records of experiments on *Odontopera bidentata* which throw light on the heredity of its melanic form:—

a. A paper by the late Mr T. H. Hamling³, in which it is recorded that a black ♀ taken at Methley deposited ova, which produced 70 black and 66 type imagines. From this family inbred, 14 successful pairings are reported:

	Parentage		Imagines	
	Male	Female	Melanic	Type
4 broods combined	<i>T</i>	× <i>T</i>	24	44
3 broods combined	<i>T</i>	× <i>M</i>	25	13
3 broods combined	<i>M</i>	× <i>T</i>	37	10
4 broods combined	<i>M</i>	× <i>M</i>	90	6
Total	...	249 specimens		

These results can be explained, but only in a way which would be unjustifiable were it not that a much more extensive experiment has now been made, which supports the following argument:

The first family was mixed, therefore neither parent was dominant. The original ♀ parent being black must therefore have been heterozygous; and the ♂ either similar; or type (recessive). In the former case, the offspring should be 75 per cent. melanic (heterozygous and homozygous) and 25 per cent. type; and in the latter, 50 per cent. melanic (all heterozygous) and 50 per cent. type.

The comparative frequency of occurrence of the two forms in nature makes it more likely that the ♂ was type; and the fact that 136 moths were reared from the 146 ova deposited, makes this almost certain, because the melanic form seems to be the more hardy, and of the 10 ova which failed to reach maturity, the majority would probably be type, and even if all were black, the numbers would only be 80:66.

Thus it seems that all the 70 blacks were heterozygous, so we should expect *M* × *M* to give 75 per cent. *M* and 25 per cent. *T*, but the mortality amongst the larvae was very high indeed, and would account for the hardier melanic outnumbering their type brethren by more than 3:1.

¹ *Proc. Ent. Soc. Lond.* 1904, p. lxxii.

² *Trans. City of Lond. Ent. Soc.* 1905, p. 5.

³ *Trans. City of Lond. Ent. and Nat. Hist. Soc.* 1903, pp. 40—43.

In the results of the type × melanic crosses the same explanation is probable.

With regard to the melanic specimens recorded from parents both type, it seems that one of the 4 ♀'s had really paired with a black ♂. Pairing occasionally occurs immediately the wings have dried, and all breeders of Lepidoptera know how difficult it is to exclude all possibilities of error when dealing with large numbers of pupae. On the much less probable of the two original hypotheses, viz., that the original ♂ parent was melanic (heterozygous), some of the 70 would be homozygous, and this would the more easily explain the preponderance of melanics in their offspring.

b. A paper entitled "Melanism in Yorkshire Lepidoptera," by Mr G. T. Porritt¹.

A melanic female captured in 1904 deposited ova, which developed into 6 melanic and 3 type specimens. From the black moths a large brood was reared, which included 75 per cent. black specimens, and from these again a considerable number were reared in which the percentage of black was even greater.

Mr Porritt has also repeatedly crossed type and melanic and found the produce is about half and half of the two forms. These results are easily reconcilable with the following experiment and the conclusions drawn therefrom:

In the autumn of 1909, on the advice of Mr Leonard Doncaster, I commenced an experiment on *Odontopera bidentata* in the hope of discovering whether the heredity of the melanic form of this species followed any rule or law.

I commenced with a perfectly open mind on the subject, and in fact had only a slight acquaintance with the various facts and theories of heredity and variation.

In November, 1909, I obtained 12 pupae, from which in April, 1911, 6 type and 6 melanic moths emerged. (Family 09.1).

Two pupae were also obtained from a different source and produced one type and one melanic specimen—09.2 (see 1909 table).

Six pairings were made, but in only two cases were the offspring successfully carried to maturity:—10.2 and 10.3.

In June, 1910, I obtained 24 larvae bred from two melanic parents, probably both of 09.1 family. The resultant moths are 10.4.

¹ *Trans. Brit. Ass.* 1906.

Odontopera bidentata. 1909 Table.

Parentage Male × Female	Label of family	Imagines						Totals
		Type			Melanic			
		Male	Female	Totals	Male	Female	Totals	
<i>M</i> × <i>M</i>	09.1	4	2	6	4	2	6	12
<i>M</i> × <i>M</i>	09.2	—	1	1	—	1	1	2
Total								14

O. bidentata. 1910 Table.

Parentage Male × Female	Label of family	Imagines						Totals
		Type			Melanic			
		Male	Female	Totals	Male	Female	Totals	
09.1 <i>T</i> × 09.1 <i>T</i>	10.2	15	23	38	—	—	—	38
09.1 <i>T</i> × 09.2 <i>T</i>	10.3	22	21	43	—	—	—	43
<i>M</i> × <i>M</i>	10.4	—	—	—	10	7	17	17
<i>M</i> × <i>M</i>	10.5	—	1	1	2	—	2	3
	Warwick- shire 1	York- shire 1		2	—	—	—	2
Total for year								103

O. bidentata. 1911 Table.

Formula	Parentage	Label of family	Imagines						Totals	
			Type			Melanic				
			Male	Female	Totals	Male	Female	Totals		
B.	10.4 <i>M</i> × 10.4 <i>M</i>	11.11	—	—	—	12	11	23	23	
	10.4 <i>M</i> × 10.4 <i>M</i>	11.15	—	—	—	16	10	26	26	
Totals			...	28	21	49	49			
C.	10.3 <i>T</i> × 10.4 <i>M</i>	11.4	—	—	—	22	16	38	38	
	10.4 <i>M</i> × 10.3 <i>T</i>	11.13	—	—	—	28	31	59	59	
Totals			...	50	47	97	97			
E.	10.5 <i>M</i> × 10.2 <i>T</i>	11.5	9	14	23	11	11	22	45	
	10.2 <i>T</i> × 10.4 <i>M</i>	11.9	12	22	34	21	17	38	72	
	10.4 <i>M</i> × 10.2 <i>T</i>	11.8	—	—	—	—	2	2	2	
Totals			...	21	36	57	32	30	62	119
F.	10.2 <i>T</i> × 10.2 <i>T</i>	11.1	5	4	9	—	—	—	9	
	10.3 <i>T</i> × 10.2 <i>T</i>	11.12	3	2	5	—	—	—	5	
	10.3 <i>T</i> × York. <i>T</i>	11.14	15	14	29	—	—	—	29	
	War. <i>T</i> × 10.3 <i>T</i>	11.23	20	26	46	—	—	—	46	
Totals			...	43	46	89	—	—	—	89
Yorkshire	...	—	1	1	2	1	2	3	5	
Middlesbrough	...	11.24	22	15	37	—	—	—	37	
Birmingham	...	11.25	4	1	5	—	—	—	5	
Cambridge	...	—	2	1	3	—	—	—	3	
Gateshead	...	—	—	4	4	—	—	—	4	
Burnley	...	—	1	1	2	—	—	—	2	
Total								56		
Total for year								410		

O. bidentata. 1912 Table.

Formula	Parentage	Label of family	Imagines						Totals	Totals	
			Type			Melanic					
			Male	Female	Totals	Male	Female	Totals			
A.	11.9 <i>M</i> × York. <i>M</i>	12.44	—	—	—	7	5	12	12		
or											
B.	Wakef. <i>M</i> × Wakef. <i>M</i>	12.52	—	—	—	6	3	9	9		
					Totals ...	13	8	21	21		
C.	11.15 <i>M</i> × 11.9 <i>T</i>	12.23	—	—	—	21	19	40	40		
	11.11 <i>M</i> × 11.23 <i>T</i>	12.34	—	—	—	31	35	66	66		
	11.5 <i>T</i> × 11.15 <i>M</i>	12.41	—	—	—	8	6	14	14		
					Totals ...	60	60	120	120		
D.	11.4 <i>M</i> × 11.15 <i>M</i>	12.11	3	3	6	11	14	25	31		
	11.5 <i>M</i> × 11.9 <i>M</i>	12.16	7	9	16	25	17	42	58		
	11.13 <i>M</i> × 11.13 <i>M</i>	12.33	2 + <i>G</i> * + 2		4	8	8	16	20		
	11.13 <i>M</i> × 11.15 <i>M</i>	12.40	4	6	10	16	14	30	40		
	11.9 <i>M</i> × 11.9 <i>M</i>	12.46	2	1	3	7	3	10	13		
	11.5 <i>M</i> × 11.5 <i>M</i>	12.18	—	—	—	1	1	2	2		
	11.11 <i>M</i> × 11.9 <i>M</i>	12.29	1	—	1	1	1	2	3		
	11.13 <i>M</i> × 11.9 <i>M</i>	12.53	—	1	1	6	8	14	15		
					11.13 <i>M</i> × 11.13 <i>M</i>	12.57	—	—	—	2	2
		Totals ...	19	22	41	75	68	143	184		
E.	11.4 <i>M</i> × 11.24 <i>T</i>	12.12	11	7	18	15	18	33	51		
	11.24 <i>T</i> × 11.15 <i>M</i>	12.20	5	9	14	13	9	22	36		
	11.13 <i>M</i> × 11.14 <i>T</i>	12.26	21	25	46	17	17	34	80		
	11.15 <i>M</i> × 11.14 <i>T</i>	12.26 <i>C</i>	9	4	13	4	1	5	18		
	11.11 <i>M</i> × 11.14 <i>T</i>	12.31	8	8	16	8	3	11	27		
	11.9 <i>M</i> × 11.9 <i>T</i>	13.39	11	4	15	13	5	18	33		
		Totals ...	65	57	122	70	53	123	245		
F.	Burn. <i>T</i> × Burn. <i>T</i>	12.7	1	—	1	—	—	—	1		
	11.24 <i>T</i> × 11.5 <i>T</i>	12.10	20	29	49	—	—	—	49		
	11.24 <i>T</i> × 11.5 <i>T</i>	12.17	36	25	61	—	—	—	61		
	11.24 <i>T</i> × 11.24 <i>T</i>	12.24	4	10	14	—	—	—	14		
	11.25 <i>T</i> × Gates. <i>T</i>	12.43	22	21	43	—	—	—	43		
	11.9 <i>T</i> × 11.9 <i>T</i>	12.45	21	16	37	—	—	—	37		
	11.23 <i>T</i> × 11.24 <i>T</i>	12.47	7	2	9	—	—	—	9		
	Camb. <i>T</i> × Camb. <i>T</i>	12.50	15	7	22	—	—	—	22		
	Tunb. <i>T</i> × Tunb. <i>T</i>	12.59	10	7	17	—	—	—	17		
	I. W. <i>T</i> × I. W. <i>T</i>	12.63	46	61	107	—	—	—	107		
	Mosel. <i>T</i> × Mosel. <i>T</i>	12.64	32	30	62	—	—	—	62		
Wimbl. <i>T</i> × Wimbl. <i>T</i>	12.65	5	10	15	—	—	—	15			
		Burn. <i>T</i> × Burn. <i>T</i>	12.66	8	6	14	—	—	—	14	
		Totals ...	227	224	451	—	—	—	451		
					Total for year	1021		
					Total of specimens shown	1548		

* Gynandromorph.

In September, 3 pupae from an altogether fresh source were obtained (10.5).

The following April they emerged, 103 specimens (see 1910 table). Various pairings and cross-pairings were made, and 13 families safely reached maturity—410 specimens (see 1911 table).

From these 62 pairings were made, and 33 families, comprising 1021 specimens, were raised to maturity (see 1912 table).

From the specimens which emerged in 1913 various pairings were made, including crosses between the palest of the type forms and the most nearly black, and at the present moment there are over 1000 living pupae, comprised in 21 families, 4 of them represented by over 100 specimens each¹.

O. bidentata. Classified Table.

Formula	Label of family				Families	Specimens		Totals
						Type	Melanic	
(A)	12.44 or 12.52 or both				2	—	21	21
(B)	10.4	10.5			2	—	20	
	11.11	11.15			2	—	49	
	12.44 or 12.52 or both				2	—	21	
	Totals ...				6	—	90	90
(C)	11.4	11.13			2	—	97	
	12.23	12.34	12.41		3	—	120	
	Totals ...				5	—	217	
(D)	12.11	12.16	12.33	12.40	5	39 = 24.1 %	123 = 75.9 %	184
	12.46							
	12.18	12.29	12.53	12.57	4	2	20	
	Totals ...				9	41 = 22.3 %	143 = 77.7 %	
(E)	11.5	11.9	11.8		3	57	62	
	12.12	12.20	12.26	12.26c	6	122	123	
	12.31		12.39					
	Totals ...				9	179 = 49.17 %	185 = 50.83 %	364
(F)	10.2	10.3			2	81		621
	11.1	11.12	11.14	11.23	4	89		
	12.7	12.10	12.17	12.24	13	451		
	12.43	12.45	12.47	12.50				
	12.59	12.63	12.64	12.65				
	12.66							
Totals ...				19	621	—		
Combined Totals					48	841	635	1476

¹ 470 imagines have emerged up to date (March 14, 1914) and they support the former evidence.

I have given all care to the technique of the experiment such as profuse note taking (including many points besides those referred to in this paper), frequent counting of the specimens in all stages, double labelling, and so on; and Mr Doncaster has kindly made various visits of inspection during its progress, and is willing to accept it as reliable.

In a survey of the specimens reared in the experiment, certain points are worth noting:

(1) In melanic specimens the abdomen, legs, and antennae are black or nearly so; and the wings are usually black, but in some cases have a slight brownish suffusion as in (12.52); and in some cases a patch of tan on the fore-wing (as in 12.11).

Type specimens have light coloured abdomen, legs, and antennae. The wing colour varies between light brownish-yellow and dark brown, and many northern specimens tend to be banded, but all show the normal markings, and are always easily distinguishable at a glance from melanic specimens.

(2) In both type and melanic forms the male specimens are darker than the corresponding females; there is no other sign of influence of sex.

(3) I cannot point out any difference to the eye between homozygous and heterozygous forms.

Now if we classify the results from the point of view of the constitution of the parents we note that:

(1) Type by type breeds type only, no melanic specimen cropping up among the 621 type specimens bred (F).

(2) Segregation is clearly shown in 9 families (D) where 25 per cent. of type specimens appear in the offspring of melanic parents.

(3) Five families (C) are cases of a pure homozygous melanic paired with a type, giving all heterozygous melanic offspring.

(4) Nine families (E) are cases of a heterozygous melanic pairing with a type, the resultant progeny consisting of type and melanic specimens in equal numbers.

(5) The fact that the melanic specimens are usually slightly in excess of the expected percentage seems to show that they are more hardy and fewer die during the early stages, and this is borne out by the fact that the melanic specimens usually emerge more early in the year than their type brethren, and will even emerge in temperatures between 1° and 5° C.

(6) This species stands close breeding well and inbreeding fairly well, though in many of the families which died out the cause seemed to be inbreeding.

GENEALOGICAL TABLE. *O. bidentata*.

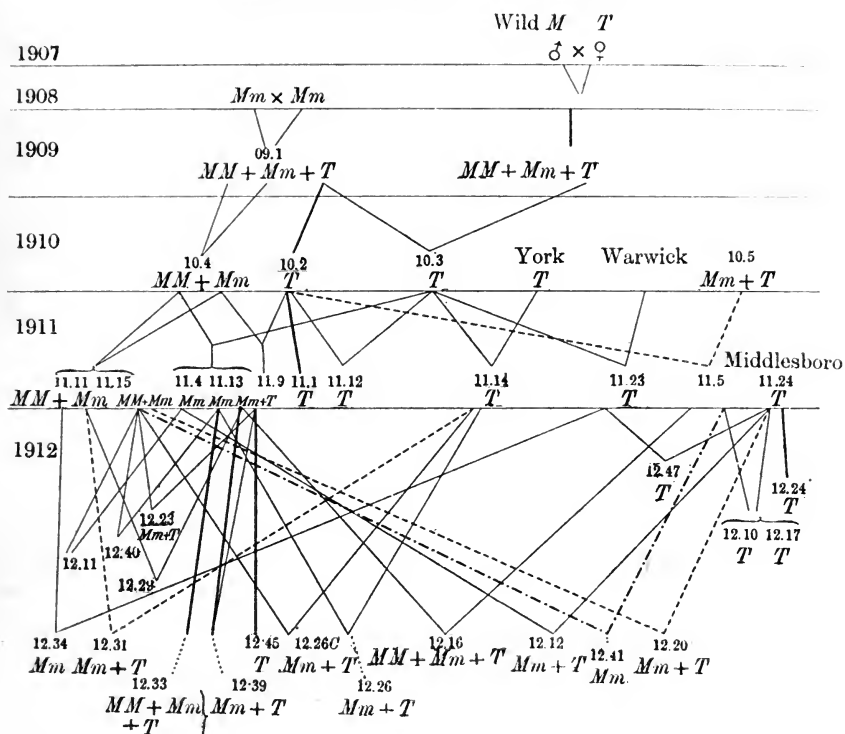

Thus each of the 50 families (48 bred from ova) falls under one or other of the following well-known Mendelian formulae :

If MM = homozygous melanic,
 Mm = heterozygous melanic,
 mm = type,

- then $MM \times MM = MM$ (A)
 $MM \times Mm = MM + Mm$ (B)
 $MM \times mm = Mm$ (C)
 $Mm \times Mm = MM + Mm + mM + mm$ (D)
 $Mm \times mm = Mm + mm$ (E)
and $mm \times mm = mm$ (F)

I feel that the foregoing is sufficient evidence to prove, that in *Odontopera bidentata*, melanism follows Mendelian rules and is dominant.

12. The question of the exact method of the heredity of melanism in the familiar Peppered Moth, *Amphidasys betularia*, is of special interest because the melanic variety, *doubledayaria*, in the 65 years since it first appeared has multiplied and spread all over England, and is now far commoner than the type, and is often quoted as a good example of a distinct alteration in a whole species occurring in our own times and apparently not due, directly at any rate, to man's influence.

In the *Type* form the body and wings are white, abundantly dusted with black. On the costal margin are five black spots. From the first two arises a duplicate angulated black first line, to the third is attached a black discal spot, the fourth originates the second line, which is angulated. On the hind margin is a series of black dots, extending into the white cilia. Hind wings white (especially so in costal area), dusted or spotted with black, and having usually 2 or 3 obscure partial transverse lines. Central spot black. Leg tufts brownish grey, tarsi and antennae in female black spotted with white. In male antennae brown-black.

In the *Melanic* form (*doubledayaria*) the whole insect is almost uniformly smoky black, except lower portion of face which is white, and a round white spot at the extreme base of the costa of each fore-wing.

Varieties of the type have occurred where the definite markings have been reduced, leaving the whole white surface but scantily dusted with black, and one specimen has occurred almost white. In other cases the typical markings are accentuated and somewhat increased.

In what are usually termed the *intermediate* forms, the normal markings are much increased and become partly confluent, so that in many cases the moth is black spotted all over with white dots and minute irregular blotches. The hind-wings are almost always lighter than the fore-wings.

Between the type and the *doubledayaria* variety every gradation of intermediate has occurred, although the intermediate is the rarest of the three forms. It occurs in nature as well as in bred specimens. The thorax and abdomen are of exactly the same colouration as the wings in all specimens of type and varieties.

The black which is velvety in a live specimen diminishes in intensity on death, and has a strong tendency to "rust" on the slightest provocation, and after a time even in spite of precautions.

The accompanying table consists of those records of genetic value of breeding this moth which I have been able to find.

In February, 1910, I started an experiment which I hoped would furnish some evidence on this question. The claims of my other

Amphidasya betularia.

Parentage	Imagines			Observer	Reference
	Male × Female	Type	Melanic		
<i>T</i> × <i>M</i>	75	—	90	Steinert ...	<i>Isis</i> , 1892, pp. 424—427.
<i>T</i> × <i>M</i>	123	none	109	Bacot ...	<i>Trans. City Lond. Ent. Soc.</i> 1905, p. 5.
<i>T</i> × <i>M</i>	18	—	11	Fletcher ...	Bateson, <i>Sci. Progress</i> , 1898, vii, p. 13.
<i>T</i> × <i>M</i>	8	—	7	Smallwood ...	<i>Ent.</i> Vol. xxix, 1896, p. 222.
<i>T</i> × <i>M</i>	72	—	72	Miller (Miss) ...	<i>Ent. Record</i> , 1913, p. 109.
<i>T</i> × <i>M</i>	less than 48	none	12	Cassal ...	<i>Ent. Record</i> , 1904, p. 49.
<i>M</i> × <i>T</i>	57	—	47	Main and Harrison ...	<i>Proc. Ent. Soc. Lond.</i> 1905, p. vi.
<i>M</i> × <i>T</i>	59	—	50	Harrison and Bacot ...	<i>Trans. City Lond. Ent. Soc.</i> 1905, p. 5.
<i>M</i> × <i>T</i>	15%	—	85%	Arkle ...	<i>Ent.</i> Vol. xxii, 1889, p. 236.
<i>M</i> × <i>T</i>	5	—	6	Greening ...	<i>Proc. Northern Ent. Soc.</i> 27 June 1863.
2 of the 6 inbred } <i>M</i> × <i>M</i> }	9	—	32	Baker ...	<i>Ent. Record</i> , Vol. xviii, 1906, p. 222.
<i>M</i> × <i>M</i>	—	—	all	Newey ...	<i>Ent.</i> Vol. xxix, 1896, p. 222.
<i>M</i> × <i>M</i>	—	—	all	Banks ...	<i>Ent. Record</i> , Vol. vii, p. 181, 1895—96, and <i>Brit. Lep.</i> , Tutt, Vol. v, p. 58.
<i>M</i> × <i>M</i>	34%	none	66%	Newman ...	In litt. specimens in writer's collection.
(2 <i>gpM</i> , 1 <i>T</i> , 1 unknown)	—	—	several whole families	Carr ...	<i>Ent.</i> 1902, p. 218; <i>Entom.</i> 1901, p. 213.
<i>M</i> × <i>M</i>	—	13	—	Miller (Miss) ...	In litt. 1912.
<i>T</i> × dark <i>I</i>	50%	50%	—	Bate ...	<i>Ent. Record</i> , 1895, p. 27.
<i>T</i> × dark <i>I</i>	—	—	—		
<i>T</i> × <i>T</i>	13	—	—		
2 of the 13 inbred } <i>T</i> × <i>T</i> }	—	—	—		
	200+	—	—		

experiment preventing me from giving sufficient attention to the larvae, and the special liability to disease from which this species suffers in confinement, and the usually fatal results which follow inbreeding, militated against very full results.

I have preserved all the specimens, however, and give a table of results, as I fail to find a record of even this measure of success by others in the continuous breeding and inbreeding of this species.

The male parent of family 10.2 was melanic and is recorded to have been *doubledayaria*. The female parent is type. Of the offspring all the 36 males and many of the females are undoubtedly intermediates. Five of the females are so nearly black that it is difficult to place them.

The offspring of 7 pairings from this family were safely reared and emerged June, 1912 (see table), and one pairing from these was successful, and the resultant moths appeared June 1913. Pairings have been again obtained and at the present moment a few descendants survive as pupae.

It is worthy of note that in the four families, each the offspring of two intermediate parents, the type specimens total 14 and the melanic 44 (approximately 1:3); and in the four families, each the offspring of one type and one intermediate parent, the type and the melanic specimens appear in about equal numbers (45 and 48).

1910 Table.

Parentage Male × Female	Label of family	Imagines							
		Type			Intermediate			Black	
		Male	Female	Totals	Male	Female	Totals	Male	Female
* <i>M</i> × <i>I</i>	10.1	—	3	3	2	2	4	—	—
* <i>M</i> × <i>T</i>	10.2	—	—	—	36	37	73	—	—
						(32)			(5)
<i>T</i> × <i>M</i>	10.5	—	2	2	—	—	—	—	—
	10.3	—	—	—	8	1	9	1	4
	10.4	1	1	2	7	1	8	—	—
Colchester	—	—	2	2	1	—	1	—	—
Scotland	—	—	1	1	—	—	—	—	—
Totals ...								110	

* *M* = Melanic, but not necessarily true black (*doubledayaria*).

Apparently, therefore, the *M* factor is not completely dominant but seems to give either partial or complete blackening and the cause of this difference between full melanism and intermediate must be left open, but one point is clearly shown, namely, that clean Mendelian segregation occurs (vide 12.2, 11.8, 11.20, 11.29 and 11.34).

1911 and 1912 Table.

	Parentage Male × Female	Label of family	Imagines						
			Type			Intermediate			
			Male	Female	Totals	Male	Female	Totals	
1911	10.2 <i>I</i> × 10.2 <i>I</i>	11.18	1	4	5	1	4	5	—
	10.2 <i>I</i> × 10.2 <i>I</i>	11.20	2	2	4	10	15	25	—
	10.2 <i>I</i> × 10.2 <i>I</i>	11.29	—	2	2	7	5	12	—
	10.2 <i>I</i> × 10.2 <i>I</i>	11.34	2	1	3	1	1	2	—
		Totals	...		14			44	
1912	10.2 <i>I</i> × Colch. <i>T</i>	11.25	8	3	11	7	3	10	+1 <i>M</i> ?
	10.2 <i>I</i> × Scot. <i>T</i>	11.38	5	7	12	9+* <i>G</i> +7		17	—
	10.2 <i>I</i> × Colch. <i>T</i>	11.41	2	1	3	1	—	1	—
1912	11.34 <i>T</i> × 11.20 <i>I</i>	12.2	9	10	19	14	6	20	—
		Totals	...		45			48	
					Total for 1911	113	
					Total for 1912	40	
					Total specimens shown	263	

* *G* = Gynandromorphous.

GENEALOGICAL TABLE.

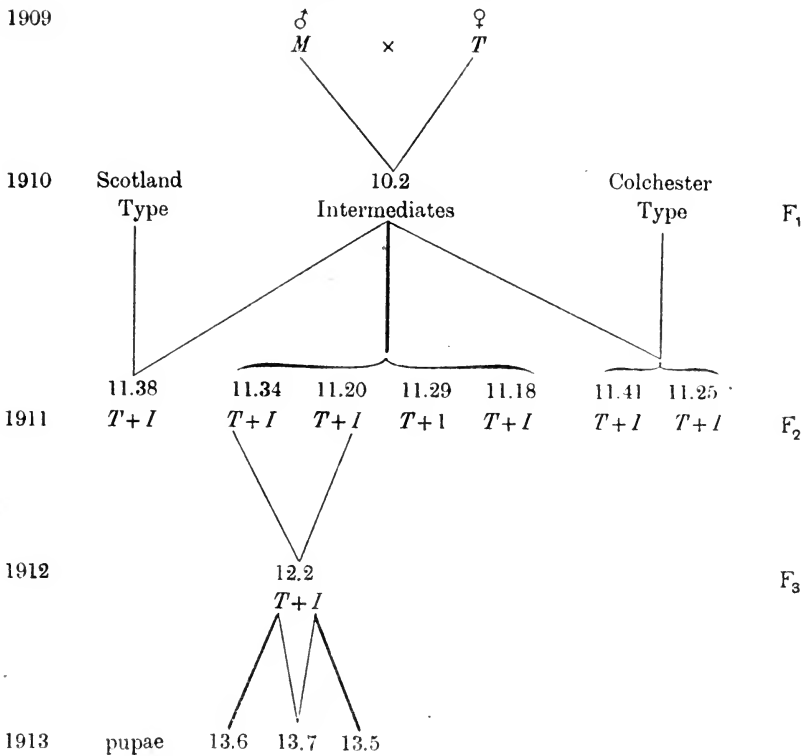

It is hoped that the whole question can be settled during the next few years.

In conclusion, with regard to most species which have melanic forms, the evidence is not extensive, but the weight of evidence up to the present seems to show that melanism in Lepidoptera frequently follows the Mendelian Law of Heredity, and in most cases is dominant, but in some few species is recessive.

I wish to record my indebtedness to the various observers mentioned, especially Messrs Mansbridge, Prout, Porritt, J. W. H. Harrison, and Buckley, for their courtesies in correspondence, and for permission to include the data of their respective experiments.

DESCRIPTION OF PLATE XXVII.

1—12. *Amphidasys betularia*.

1. Light type ♂, Kent.
2. Light type ♀, Kent.
3. Dark type ♂, Kent.
4. Dark type ♀, Kent.
5. Intermediate ♂, Family 11.20.
6. Intermediate ♀, Warwickshire.
7. Intermediate ♂.
8. Intermediate ♀, Family 12.2.
9. Intermediate ♂, Family 11.20.
10. Intermediate ♀, Family 11.20.
11. Var. *doubledayaria* ♂.
12. Var. *doubledayaria* ♀.

13—16. *Spilosoma lubricipeda*.

13. Type ♂, Worcestershire.
14. Var. Yorkshire ♂.
15. Var. Intermediate ♂.
16. Var. *radiata* ♀.

17—19. *Boarmia repandata*.

17. Type ♂, Devon.
18. Banded ♀, Devon.
19. Melanic ♀, Lancashire.

20—22. *Acidalia virgularia*.

20. Light (*canteneraria*) ♀. Hyères parents.
21. Dark ♂, London parents.
22. Melanic ♀.

23—25. *Aplecta nebulosa*.

23. Type ♂.
24. Var. *robsoni* ♂.
25. Var. *thompsoni* ♀.

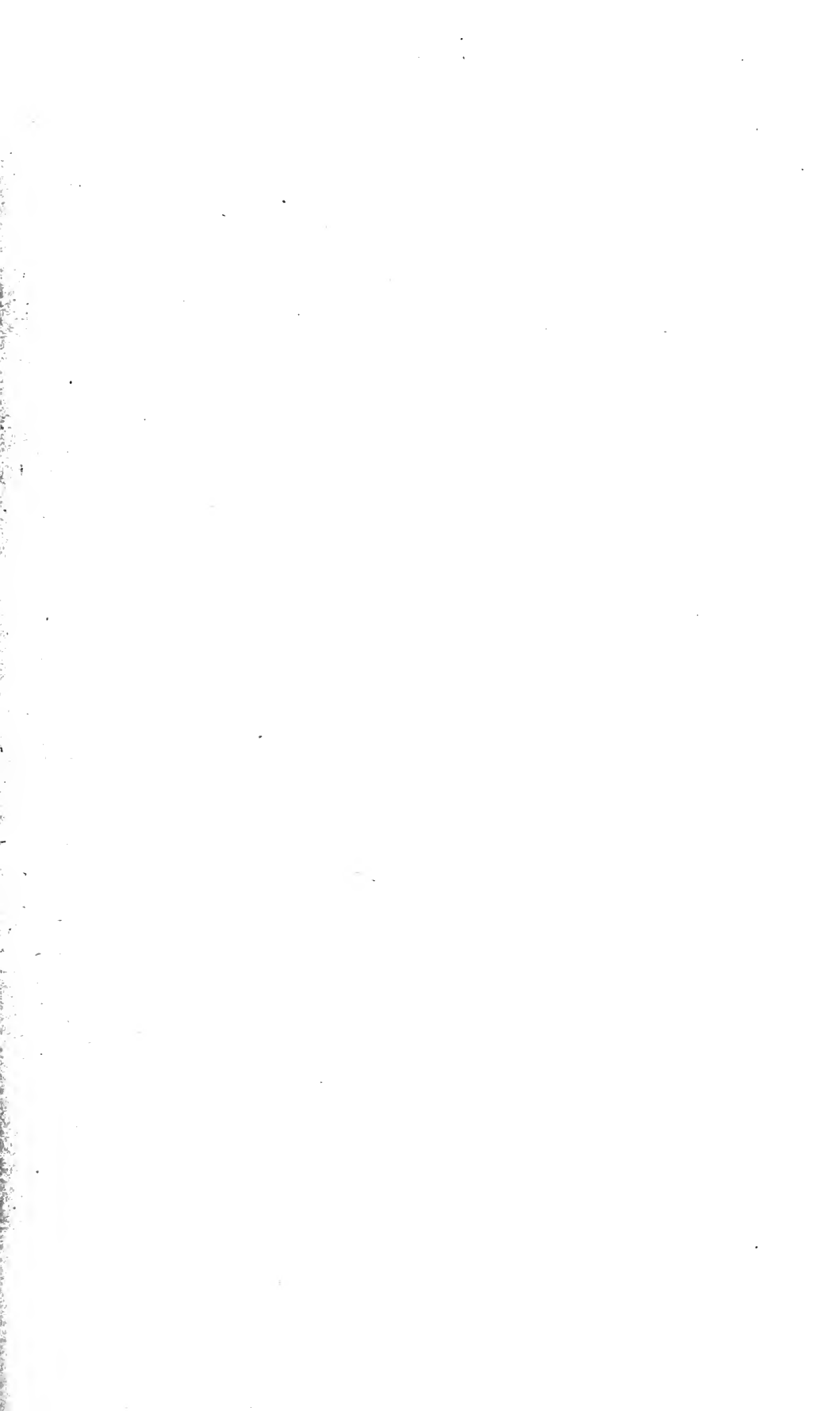

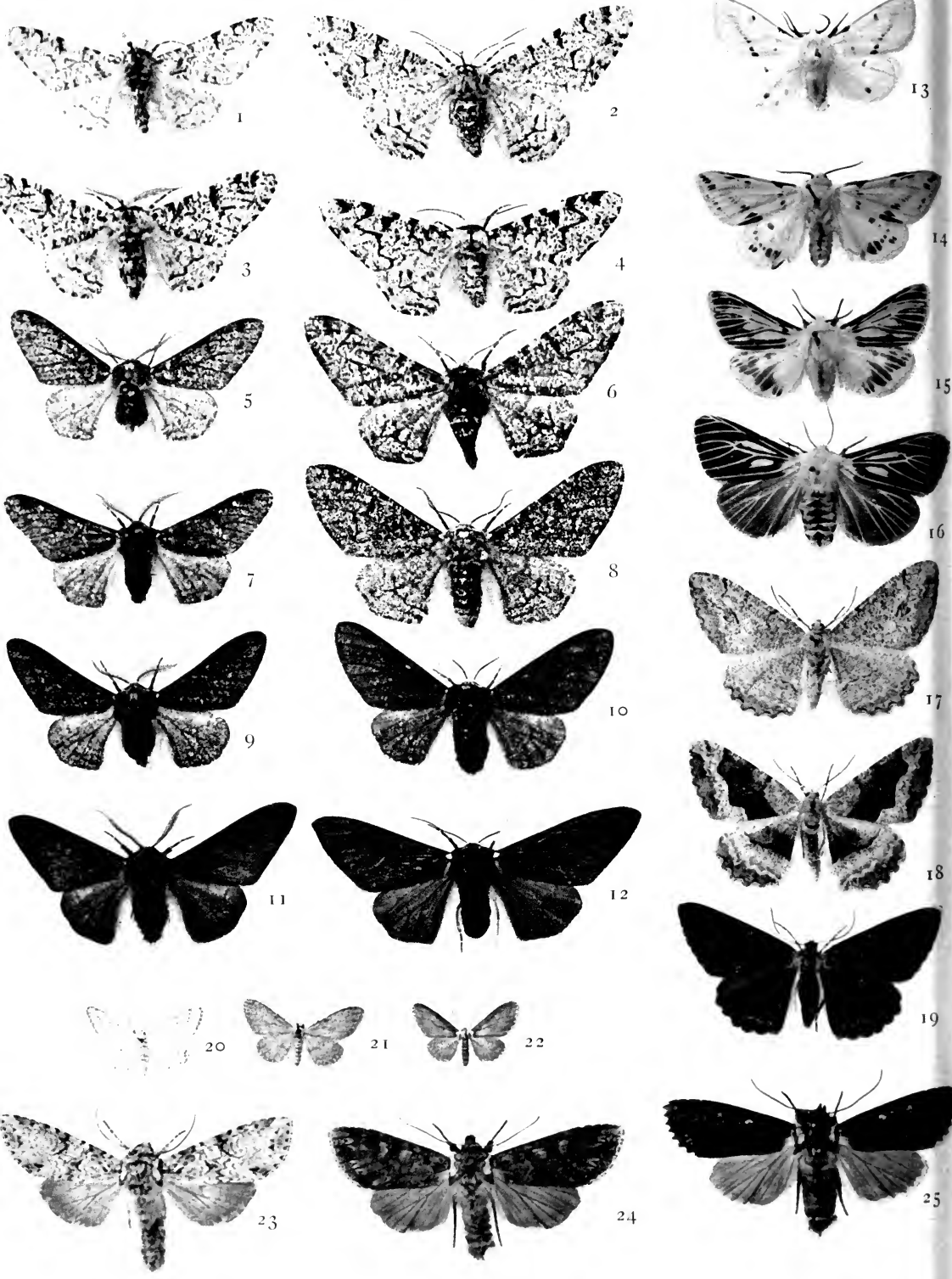

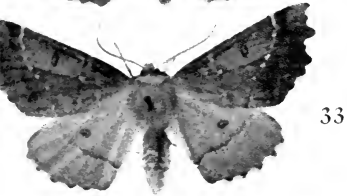
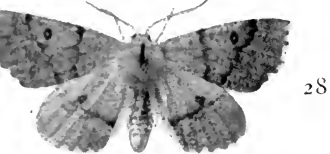
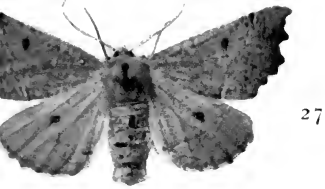

- 26—33. *Odontopera bidentata*. Type forms.
- 26. Isle of Wight ♀.
 - 27. Family 11.14 ♀.
 - 28. Isle of Lewis ♂.
 - 29. Isle of Lewis ♂.
 - 30. Family 11.24 ♀.
 - 31. Surrey ♂.
 - 32. Family 12.64 ♂.
 - 33. Family 12.26 ♂.
- 34—39. *Odontopera bidentata*. Melanic forms.
- 34. Yorkshire ♂.
 - 35. Family 11.11 ♂. Homozygous parent of 12.34.
 - 36. Family 12.34 ♂. Heterozygous.
 - 37. Family 12.34 ♀. Heterozygous.
 - 38. Family 12.11 ♀, with fulvous tint.
 - 39. Family 12.11 ♀, with light fulvous patch.
- 40, 41. *Coremia unidentaria*.
- 40. Reddish banded ♀.
 - 41. Black banded ♂.
- 42, 43. *Hemerophila abruptaria*.
- 42. Type ♀.
 - 43. Melanic ♂.
- 44, 45. *Abraxas grossulariata*.
- 44. Type ♀.
 - 45. Var. *varleyata* ♂.
- 46, 47. *Triphaena comes*.
- 46. Type ♂.
 - 47. Melanic ♂.
- 48, 49. *Acidalia contiguaria*.
- 48. Type ♀.
 - 49. Melanic ♂.
- 1—12. Selected from 700 specimens in writer's collection.
- 13, 14. Lent by Mr A. Horne.
- 15—18. Lent by Dr Beckwith Whitehouse.
- 19, 23, 24, 25. Lent by Mr W. Mansbridge (bred in his experiments).
- 20, 21. Bred in experiment by Messrs Prout and Bacot. Lent by Professor Poulton.
22. Lent by Mr R. T. Baumann.
- 26—39. Selected from 2100 specimens in writer's collection.
- 40, 41. Lent by Mr L. B. Prout (bred in his experiment).
- 42, 43. Lent by Dr Beckwith Whitehouse.
- 44, 45. Lent by Mr G. T. Porritt.
- 46, 47. Bred in experiment by Mr Bacot. Brood B. Lent by Professor Poulton.
- 48, 49. Lent by Mr W. Buckley (bred in his experiment).

QH
431
ALJ64
v.3
cop.2
Biological
& Medical
Serials

Journal of genetics

1913-14

PLEASE DO NOT REMOVE
CARDS OR SLIPS FROM THIS POCKET

UNIVERSITY OF TORONTO LIBRARY

