





0062640

ROYAL GARDENS KEW.



Period.



Digitized by the Internet Archive
in 2018 with funding from
BHL-SIL-FEDLINK

<https://archive.org/details/journalofhorticu3221hogg>

THE

JOURNAL OF HORTICULTURE,

COTTAGE GARDENER,

AND

HOME FARMER.

A CHRONICLE OF COUNTRY PURSUITS AND COUNTRY LIFE, INCLUDING BEE-KEEPING.

CONDUCTED BY

ROBERT HOGG, LL.D., F.L.S.

Established



in 1848.

VOLUME XXII. THIRD SERIES.

JANUARY — JUNE, 1891.

LONDON:

PUBLISHED FOR THE PROPRIETOR, 171, FLEET STREET.

LONDON :
PRINTED AT THE JOURNAL OF HORTICULTURE OFFICE,
171, FLEET STREET.



TO OUR READERS.

ANOTHER volume of the JOURNAL OF HORTICULTURE is completed, making the eighty-fourth of the series that find a place in the libraries of those who have fortunately preserved them.

We can say "fortunately" without any egotism, because the information those volumes contain, on all subjects pertaining to Gardening, has been contributed by able and busy workers, and we are always glad to find a fitting opportunity for expressing our appreciation of their services.

Without the ever active pens of skilled exponents of the art of Gardening, it would not be possible to produce week after week, over a long series of years, fresh, readable, interesting, and useful matter, suited for the multitude of tastes that are comprised in our world-wide constituency; yet this is what is done, and far over two thousand issues have been completed, each differing from the other, yet with the family character impressed on all.

It is not the conductors alone of the JOURNAL OF HORTICULTURE who are proud of the ability of those contributors who have made it what it has long been—a welcome guest in the homes of the affluent who delight in gardening, and of those experienced men and young probationers who engage in the pursuit they love; but it is the great body of readers, who are not regular writers, who value so highly what is provided for them, and which we have the best means of knowing is highly approved.

Expressions of satisfaction are ever pouring in. An amateur who says he "reads everything," and who has spent what many would consider a large fortune in gardening, also says he "cannot do without the JOURNAL." Those are the kind of amateurs we like, and we are glad to know there are many such scattered all over the kingdom and beyond its shores.

A gardener, one of the best and most famed, says, "The JOURNAL is the paper for me, and all the young men who have ever lived here, and are worth anything, take it weekly." The qualification is that of a shrewd and careful man, and may be taken as typical. Young gardeners who are "worth anything" read the JOURNAL, and it has undoubtedly been of great service to many.

Another shining light in the gardening world, but who has not much time for writing, appears, however, constrained to send a few words in praise of our artist, and we think they are justified. He says:—"Your artist is a smart fellow or he could not execute the work he does in such finished style." It is true our artist sometimes sketches a plant at one of the Royal Horticultural Society's meetings on Tuesday, and sends us an engraving on Wednesday for our columns on Thursday; and this could only be done by a "smart fellow," and we recognise his services.

One other short extract from the letter of a head gardener may be given—namely, "We are all very interested in your paper here. There are some excellent discussions on various subjects, and plenty of good sound advice for gardeners."

It is our wish that discussion should be free and pleasantly conducted so as to elicit truth and never impair private friendships; it is our desire to give sound advice; it is our endeavour to produce useful and attractive issues, and with the aid of good helpers we shall not fail. We tender our best thanks to all.

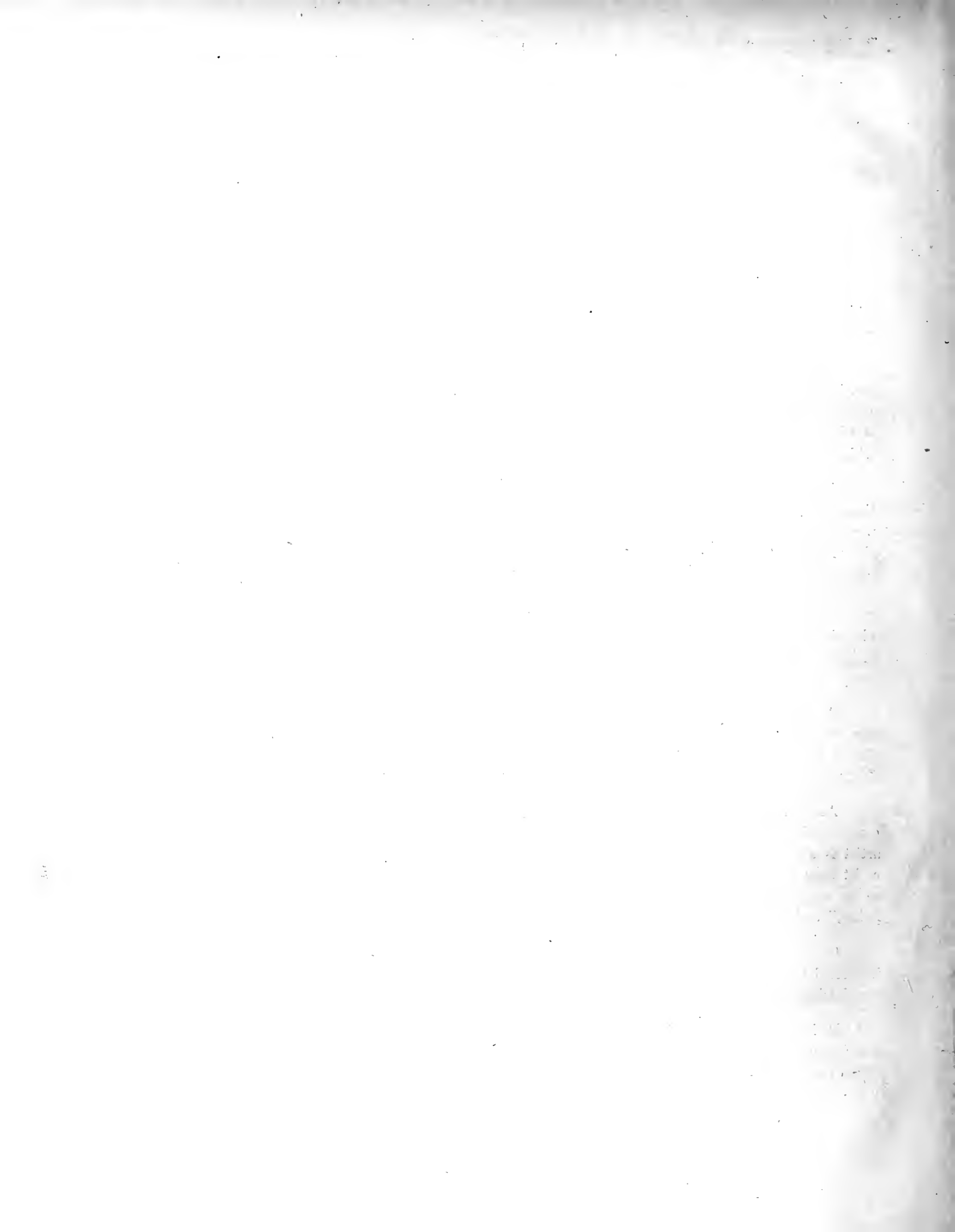

INDEX.

- ABERCROMBIE, JOHN, AS A WRITER, 463
 About London, 377
 Achimenes Rosy Morn, 17
 Address, a curious, 176
 Adiantum cuneatum, 95
 Advertising, results of, 21
 Aerides Savagenum, 441
 Agricultural College at Mill-dura, 429
 Alocasias, 18
 Apple and Pear trees, canker in, 438
 Alpine plants, rare, 190; in winter, 300; free growing, 43
 Allamandas, 174
 Allium neapolitanum, 305
 Almanack, Illustrated London, 10
 Alternantheras 374
 Alysum saxatile raising, 344
 American horticulture, Mr. Laing's paper, 247, 270, 297, 302, 324
 Ammoniacal solution for fungoid diseases, 284
 Amorphophallus Titanum, 44; campanulatus, 85
 Andromeda floribunda, 304
 Anemones, 263; Hepatica, 264; coronaria, 292; alpina sulphurea, 365
 Angraecum fragrans, 145
 Annuals for cutting, 76; half-hardy, 282
 Annuals, hardy and half-hardy, 292
 Anthracite coal, 86
 Anthurium barfordiense and Laingi, 392
 Anti-blight, 413
 Anti-in ainery, 295
 Antwerp, proposed exhibition at, 225
 Aphelenchus fragariae, 289
 Aphides on Roses, 217
 Apple scab, 492; and remedies, 504
 Apples, the American Mother, 9; Pomme Grise, 76; Bismarck, 84, 110, 146, 206, 163; in East Anglia, 150; Fenn's jelly, 152; selection of, 193; Chelmsford Wonder, 212; the Cobham, 216; Mère de Ménage, 245, 283; Reine de Grise, 275; Tasmanian, 334; culture of espaliers, 363; Northern Spy, 396; New Zealand, 490
 Apricots, pruning and protecting, 153; note on, 373
 Aquarium (Royal) Begonia Show, 511
 Aquilegias, 423
 Arachokes, scarcity in France, 159; culture of the Globe, 300
 Arum palæstinum, 267
 Ascott Gardens, 105
 Ashby Folville, avenue at, 144
 Asparagus, forcing, 174; forwarding, 253; culture of, 312; weak, 478
 Asparagus plumosus, 304
 Aster, White Queen, 71
 Aubrietias, 191
 Anchenraith, 243
 Auricula and Primula Show, 329
 Auriculas in January, 82; in Scotland, 223; cross-bred, 265; at Slough and Reading, 370; the Northern Show, 372; Scottish Society's show, 387; blue self, 408; Mr. Gill's paper on the, 412, 432; the late Mr. Woodhead's, 435; hints on, 490
 Auricula Society (National), 187; Southern Show, 348; Northern Show, 372
 Antralla, the locust plague in, 114
 Australian economic plants, 369
 Azaleas, American, 149; note on, 291; Phalaride Mathilde, M. Labrousse, and Princesse Clementine, 328; hardy, A. mollis fl. pl., 347; note on, 476
- BABYLON, HANGING GARDENS OF, 350
 Baillie, Mr. E. J., portrait of, 7
 Barbe du Capucin in Paris, 159; note on, 189
 Barron, death of Mr. William, 325
 Batatas edulis, 334
 Bath Bulb Show, 250; Summer Show, 413
 Beans, Kidney, 19; Early Kidney, 174; (Kidney) in France and England, 235, 255; broad, 253; culture of runner, 355; runner and kidney, 437
 Bees—Aparian notes, 19, 116, 175, 215, 254, 274, 293, 313, 417, 437, 499; the late Mr. Neighbour, feeding bees, 33; dysentery, 55; history of comb foundation, 75; flying and covering, 95; breeding, artificial supplies, 95; spring dwindling, carbolic acid, foul brood, Sedum spectabile and bees, 116; the past winter, flowers and peameal, feeding, dead bees, preserving bees, my apiary, Punic bees, 136; foul brood, prevention and cure, 155; observatory hives, 154; dead bees, 195; preparing honey, 215; glass sections, 276; Bee Publication Company, 216; fixing foundation, 234; preventing swarming, uniting queens, reworking combs, 251; cells containing many eggs, 293; wittering bees, 294; a dwindling hive, 313; weak hives, covering, 335; Punic hives, 353; robbing, bee escapes, patent rights, bees and bee pants, 375; wintering bees, 417; death's head moth and bees, 418; foreign bees, bees and death's head moth, 438; wintering, robbing, queen excluder zinc, 457, 477; swarming, bees and the death's-head moth, 476; death of "A Renfrewshire Bee-keeper," 477; drone breeding queen bees, 479; hints for beginners, queens and hives, feeding, 499; sniping, 509; swarming, queen excluder zinc, 521
 Bedding out, preparing for, 413
 Bedding plants, propagating, 136
 Beetroot, culture of, 339
 Beginning, the, 28
 Begonia Winter Gem, 50, 83; semperflorens carnea, 23; Vernon, 290; Triomphe de Nancy, 311, 329; manicata, 488; Major Hope and Madame Baronne de St. Didier, 516
 Belvoir in May, 499; Orton in May, 443
 Bengal forests, 246
 Berberis aquifolium, 407; Darwini, 449
 Birds and hard weather, 8; and fruit buds, 226
 Birmingham Gardeners' Association, 85, 114, 284
 Birmingham Spring Show, 306
 Black Currant mite, 222, 265, 281, 366; parasite 448, 469; caterpillar, 490
 Blood for Vine borders, 137
 Blossoming time, 379
 Bolton Chrysanthemum Society, 244
 Bombay Gardens, 52, 191, 240, 303, 328
 Bonemeal, steamed, and stable drainings, 117
 Bordeaux mixture for fungi, 231
 Boronias, propagating, 418
 "Botanical Magazine," original drawings for the, 443
 Botanic Society (Royal) of London, 128, 231, 393, 443, 496
 Botany of the Burmese frontier, 489
- Bougainvillea glabra, 174
 Bouvardias at Dove Park, Woolton, 114
 Brighton and Sussex Horticultural and Mutual Improvement Society, 468; Mr. Wright's lecture, 512
 British Fruit Growers' Association, general meeting, 42; lectures, 245
 Broccoli, for spring, 352
 Brockham Rose Association, 423
 Bulbs failing, 255; after flowering, 497
 Bullfinches, destroying, 166; and fruit trees, 187; destructiveness of, 207; note on, 409
 Burma, a journey to, 68, 83, 188, 168
 Burnett, experience of Mr. in California, 38
 Buttercups in lawns, 127
- CABBAGES CLUBBING, 97; spring, 214
 Cactus Society in America, 490
 Caladium argyrites, 194
 Calanthe culture for profit, 79, 122
 Calceolarias, culture of, 318; and their substitutes, 374; successful, 443; blooms, 458
 Californian vegetation, 147
 Calliandra Tweedii, 25
 Calypso hemirabilis, 27, 327
 Camellias, cutting down, 41; buds falling, 117; in pots, feeding, 187; note on, 293; Duchess, 311; blooms not opening, 335; liquid manure for, 395
 Campanula pyramidalis, 153; note on, 416; abietina, 516
 Campylobotrys retulgens, 265
 Canker in fruit trees, 424, 469
 Canna Jules Chrétien, 516
 Cape Colony, horticulture in, 439
 Cardiff Chrysanthemum Society, 127
 Cardoons, 234
 Carnation border, 20; winter flowering, 32; flowers in America, 112; large blooms of, 144; for cutting, 317; from seed, 345; Lizzie McGowan, 406; Mr. Douglas's paper on the, 466, 442, 484; plants dying, 458; Souvenir de la Malmaison, 471; Iver White and Lord Rendlesham, 516
 Carnation Society in the midlands, 114, 151, 208
 Carnations and Picotees in winter, 82; sowing, 292
 Carpet beds, 376, 411, 435
 Casey, death of Mr. Frank, 163
 Caterpillars in Cheshire, 46, 112; and Hollies, 315; methods of destroying, 382; and fruit trees, 497; on Hollies, 522
 Cattleyas, diseased, 34; Trianae plumosa, 125; Trianae Hardyana, 213; Behrensiana and elegans Arnoldiana, 311; Schroeterae Leyswoodensis, 384; Rex, 457
 Cauliflowers and Chou de Brughley, 352
 Cauliflower disease in Strawberries, 289
 Cauliflowers, forcing, 120; culture of, 272
 Celery, 424
 Celery for late use, 360; exhibition, 435; culture of, 471
 Celmisia spectabilis, 505
 Château de Gouville Gardens, 257
 Cherrics, forcing, 154; culture of, 423
 Cherry house, 194
- Cherry Plum as a fencing, plant, 91
 Chevallieria Veitchi, 287
 Chimnanthus fragrans in pots, 77
 Chionodoxa Luciliae, 304; sardensis, 341
 Chionoscilla (bigener), 323
 Chiswick fruit trees at, 357
 Chiswick Gardeners' Association, 285
 Chiswick Horticultural Society, 186
 Cholsya ternata, 449
 Chorozema Lowi, 125
 Christmas Roses, 28
 Chrysanthemums—M. E. A. Carrière, John Lambert, varieties for decoration, 13; new varieties, 14; cutting down Chrysanthemums, 14; cutting back, single, large v. small prizes, 30; notes on new, English seedlings, for Christmas, 49; for decoration, 72; Sheffield Society, 73; Fanny Boucharlat, varieties for Christmas, late varieties, bush plants at Trentham, culture in America, the Hull Society, 91; Mrs. F. Thompson, Golden Gem, late varieties, National Society, and the Hull Society, 104; late white, 123; at Christmas, 124; Eccles Society's meeting, 124; Beauty of Castlehill, 147; a late white, 191; mistakes in culture, 191; Mr. Mawley's analysis, 204, 246; fatality with soot and lime, 330; note on, 47; English raised, 424; Society (National), annual excursion, 443; Mr. Woodcock's paper, 503
 Cinerarias deteriorating, 244; note on, 298, 349
 Cissus discolor, 194
 Clematises, propagating from cuttings, 376
 Cleome heptaphylla, 5
 Clerodendron fallax seedlings, 10; Balfourianum, 174
 Clivias, Caladiums, and Begonias at Forest Hill, 359
 Clivias at Forest Hill, 325; raising, 333
 Cliviecharis pulchra, 468
 Colognye cristata, 201; culture for profit, 262
 Coleworts, 24
 Coltsfoot as an aquatic, 805
 Conifer hedge, 96
 Cool house Orchids, 298
 Cork dust, 216
 Coronilla glauca, 215
 Corridor roof, plants for a, 275
 Corypha umbraculifera in Burma, 89
 Cotoneaster frigida, 28
 Cottage gardening, 413, 458
 Cottager, definition of a, 197
 Cotton plant in the United States, 305
 Court, the late Mr. W., monument to, 112
 Crocuses on lawns, 308, 340
 Crosswood Park, 209
 Crotons, essentials of culture, 60
 Croydon Gardeners' and Amateurs' dinner, 168
 Croydon Gardeners' Society, 225; Mr. Wilks' lecture, 514
 Crystal Palace, horticultural appliances at the, 192
 Crystal Palace Shows in 1891, 16; Spring Show, 249; Show, 390
 Cucumbers, management of, 32; raising in frames, 74; in winter, 167; forcing, 292; scorching and prevention, 335; in pits, 437
 Cupressus macrocarpa, hardiness of, 407, 444
 Currant mite, 222, 345, 386, 407, 511
- Currants—Red, White, and Black, 467
 Current notes, 280, 333, 421
 Cutler testimonial, 8
 Cutler, death of Mr. E. R., 163, 183
 Cyclamens, 197
 Cymbidium, 201
 Cyripediums, hardy, 81
 Cystleum, 101; Creon, 125; Maynard, 231; porphyroclamys, 408
- DAFFODILS IN IRELAND, 166; Samson, 203; white 301; early, 348; at Ditton, 382; Creasida, 335; maximus, 386
 Dahlias, Tom Thumb, 31; Pompon 193; prizes for Cactus varieties, 226; propagating, 252; analysis 1883-1990, Mr. Mawley's, 276; Society, the National, 439
 Daphne mezereum, 261
 Denbrobium signatum, 41; notes on, 162; noble, Hardy's variety, 213; melanodiscus varieties, 231; culture of, 260; Venus, 311; Mr. Glover's paper on culture and varieties, 321; thyrsiflorum, 319, 384; Phaleonopsis Statteriana, 516
 Deutzia gracilis in shrubberies, 27, 44
 Dichorisandra undata, 265
 Dicksonia Lathamii, 513
 Dileptra spectabilis, 207
 Dippe, Gustave, bequest to gardeners, 283
 Disas, Mr. Burberry's, 41; notes on, 223; Veitchi, 465
 Dominy, death of Mr. J., 143
 Draba gigas, 429
 Dream, as of a, 17, 43, 92, 151, 213
- EDINBURGH SPRING SHOW, 24
 Emigrant's enterprise, 38; information for, 285
 Encephalartos caffer outdoors, 334
 Endives, curled or broad-leaved
 Batavian, 202
 Epacris, 273
 Epidendrum polyribbon, 102; dellense, 311
 Eremurus robustus and Olga, 190; himalaicus, 453
 Ericas, 273, 476; carnea, 264
 Eritrichium narum, 281
 Erythronium grandiflorum, 171
 Espaliers, 363
 Essex Field Club, 87
 Eucalypti, globulus, 20; in the Isle of Wight, 27
 Eucharis grandiflora, 208
 Euonymus radicans variegatus, 469
 Euphorbia jacquiniæfera, 63, 457
 Enryangium Sumbul, 289
- FARM—PRIZE ROOT CROPS, 22; Dairy, pantry, and fruit farming, growing prize roots, 36; Stephen's Book of the Farm, division 5, 98; liquid manure, 117; sewage, 133; agricultural education, 158; shelter for live stock, 177; Hogg and Wood's seed report, 178; green crops, 193, 218; manure experiments with Mangolds, 236; the lambing season, 256, 275; the lambing season—food, 296; grass land manage-

FARM—continued.

ment, 336; management of lambs and calves, 355; farm poultry, 377; the dairy, 398; a field for emigration, 419; good butter, 439; cream management, 440; butter not keeping, 440; the Wheat bulb fly, 440; good butter, 460; a good dairy cow, 479; butter not keeping, 480; swine fever in the north, 480; Normandy butter, 52; rural holdings, books on farming, 523
 Farming in America, emigrants, 78
 Fertilised moss, plants in, 448
 Ficus stipulata, fruiting and barren branches, 133
 Figs, forcing, 54; earliest in pots, 134; trees, pruning, 255; out of doors, 273; forcing, 332; trees casting their fruits, 400; forcing, 415; early trees, 475; St. John's, 485; forcing, 520
 Flora of British India, 305
 Floral decorations in Birmingham, 134
 Florist flower Societies in Birmingham, 92
 Florists' flowers, notes on, 82, 490
 Flower culture for profit, Hellebores, 5; Calanthes, 79; Cœlogyne cristata, 202
 Flower garden, insects of the, 12, 202; January work, propagating plants, 95; notes on, 416; early bedding out, 456; work in the, 498
 Flower pot suspenders, 207
 Flowers for cutting, 110; in Paris, 159; showing, cut, 196; pressing, 197; note on hardy, 220; hardy perennials, 199, 263; half hardy annuals, 282; gumming, 358; the value of, 366; hardy, 422; drying, 438
 Fogs in London, 3
 Fog effects on plants, Dr. Oliver's report, 267, 288
 Foliage plants, variegated, 81
 Forests of Europe, 8
 Forget-me-nots, 490
 Frames, protecting plants in, 32
 France in February, 159
 Francoa ramosa, 533
 Freesias, hints about, 123
 Frost in November, 10; severity and effects of, 59; trees cracking, 64; results of the, 85; record at the Kew Observatory, 94; effects of the, 126; and insect life, 161, 183; and vegetation, 167
 Fruit and flower factory, Mr. Whiteley's, 142; protectors, 489
 Fruiterers' Company, annual banquet, 88
 Fruit, hardy—Red, White, and Black Currants, 467; culture of the Strawberry, 437
 Fruit pests, the Toddington Conference, 433
 Fruit production and distribution, 6; preserved, 17; for market, 20; comments on culture, 23; exhibiting hardy, 44; exhibitions, 68; farming; quality versus size in, 102; growing, economic, on arches, 146; forcing, 173; growing (British) as an industry, 163; packing, 176; houses, arranging pipes in, 179; garden, work in the, 193; thinning buds, 227; notes on hardy, 231; hardy, prize paper at Cardiff, the Apple, 363; growing in India, the Mango, 371; notes on blossom, 379; culture under glass, 383; prospects, 387; prize paper on culture, 390; disqualifying exhibitors of, 407; prospects, 405, 477, 424, 430; farms in Colorado, 445; and vegetables at the Temple Show, 453; garden, work in the hardy, 455; production in California, 507
 Fruit trees, pruning, 54; barked, 97; planting, 97; and rainfall, 112; artificial manures for, 376; flowering of, 434
 Fuchsias, starting and potting, 74
 Fungicide and distributor, 437
 Fungi in relation to plant diseases, 85; heterocercial, 413
 Fungoid diseases of the Grape, 234
 Fungus on Mushrooms, 156

GALANTHUS ELWESI, 642
 Garden difficulties, 358; scene in May, 431
 Gardeners as domestic servants, 157, 176; lady, 345; Sultan's, 346; definition of, 351
 "Gardener's Chronicle," Jubilee of the, 109
 Gardeners, City Company of, 168
 Gardeners' Royal Benevolent Institution, financial statement, 46; election, presentations and dinner, 63; note on, 85; the late Mr. Cutler, 203

Gardeners' Orphan Fund, 112; proposed fête in the Crystal Palace, 245, 488, 432
 Gardenias cankered at the collar, 97; culture of, 381; treatment of, 418; note on, 457
 Garden glory, 99
 Gentiana bavarica, 280
 Gentians, 463
 Gesnera cinnabarina, 34
 Gilbert, death of Mr. Thomas, 167
 Gladioli, Lemoine's hybrids, 511
 Glass, rough, 196
 Gloxinias in frames, 314; Eleonora and Monarch, 516
 Gooseberries in spring, 415
 Gooseberry bushes, sparrows and, 176
 Gooseberry, the, 468; Early Green, 500
 Gossip in a parson's garden, 2
 Grafting and budding Apples, 363
 Grafting fruit trees, 272
 Grapes, cleaning of mealy bug, 13, 108; Alnwick Seedling and Barbarossa, 157; springing Muscats, 216; Duke of Buccleuch, 255; fungoid diseases of the, 231; dwindling, 376; ripening, 415; scorched and rusted; 459; that will keep, 483; late, 497; scalding, 517
 Grass edging broken, 176
 Grassendale and Aigburth show, 265
 Graveling paths, 346
 Green fly on Peach trees, 263
 Greenhouse, climber for a, 133
 Grey, death of Mr. John, 265
 Grinstead Horticultural Society, 127
 Guano, native, 186
 Gumming flowers, 358
 Gynurim, a new, 9
 Gypsophila paniculata, 191

HALL FOR HORTICULTURE, PROPOSED, 423
 Ham House, 11
 Hamamelis Zuccariniana, 125
 Hardy flower notes, 220, 230, 337, 422, 481
 Hardy fruit, essay on, 423
 Hardy plants (Mr. Upstone's paper), 507
 Haycock, death of Mr. C., 126
 Haywards Heath Spring Show, 372
 Heating by steam, 304, 322, 325
 Heating fruit houses, 179
 Hedges, planting quickset, 193, 291
 Hellebores, 5, 212
 Helleborus atrorubens, 340
 Hemerocallis, 203
 Herbaceous borders, 155
 Herbaceous plants, rare, 190; for exhibition, 258; for borders, 416; Mr. Wilks' lecture, 514
 Heterocercal fungi, 413
 Hibberd memorial fund, 283
 Hibber's library, the late Shirley, 488
 Highfield Gardens, 508
 Hippeastrum J. R. Pletcher, 213; at Chelsea, 325
 Hollies and caterpillars, 315
 Hollyhock, notes on, and election of varieties, 37; for exhibition, 108
 Horticulture in America, Mr. Laing's paper, 247, 270, 299, 312, 324
 Horticultural appliances at the Crystal Palace, 192
 Horticultural progress, sixty years of, 238, 493
 Horticultural (Royal) Society, Journal of, 9; committees and programme, 50; meetings, 124, 172, 212, 249, 266, 310, 328, 347, 391, 412, 495, 515; nominations for the Council, 111; annual meeting, 125; report of the Council for 1890-91, 130; special prizes, validity of elections, 139; interpretation of by-laws, 171; charter and by-laws, 187; Mr. Morris's resignation, 210; Mr. Wilks' explanation of procedure, 226, 230; Journal, Temple Show and dinner, 365; annual dinner, 516
 Horticultural (United) Benefit and Provident Society's annual meeting, 132
 Hot-water pipes, arranging, 210, 243, 267, 250, 309, 320
 Hot water and steam heating, 359
 Hyacinths, notes on varieties, 319; at Kew, 357; falling, 376; Tour d'Auvergne, 429

ICE STACKS, CONSTRUCTING, 77
 Indian corn, 45
 Indigofera Gerardiana alba, 516
 Insect life, frost and, 161
 Insect enemies of fruit trees, 423
 Insecticide a continental, 407

Insects, Miss Ormerod's works on, 289
 Insects injurious, methods of prevention, 302
 Insects of the flower garden, 12, 202, 384
 Ireland, a gardening tour in, 46, 228
 Irestines, 374
 Iris Danfordiae, 125, 151; variegata, Robert Burns, 516; Gatesi, 516
 Irises, raising from seed, 334
 Iron and fruit trees, 15; its use in fruit culture, 39;
 Iron sulphate, applying, 156; for Potatoes, 176
 Iron sulphate and sewage, 76

JUSTICIA FLAVICOMA, 457

KALE, SCOTCH CURLED, 24; hardy, 86; Asparagus and Jerusalem, 357
 Kamperferia tubers, 343
 Kello Cabbage competition, 429
 Kerria japonica flore-pleno, 490
 Kew Observatory, 182
 Kingston and Surbiton Chrysanthemum Society, 264
 Kitchen garden notes, 74; formation of a, 237; prize plan of a, 247; notes, 529
 Kombe poison, 9

LACINA BICOLOR, 516

Laelia anceps Ballantineana, 50; hybrida Arnoldiana, 465, 490; Gottiana and Tring Park grandis, 516
 Laelias in winter, 65
 Langford Lodge, 47
 Laurel shoot, blanched, 127, 167
 Lawn grass seeds, sowing, 262
 Lawn improving, 156
 Lawn mowers, setting, 376
 Leaves, a lesson on, 52; unhealthy, 93
 Leeks, culture of, 24
 Leptospermum bullatum, 454
 Leschenaultia biloba major, 455
 Lettuces, the Blockhead, 8; for market, 9, 15; culture in Parisian market gardens, 102, 145; early, 174; Lee's hardy green, 340
 Lettuces and Onions, 16
 Lencophyllum texanum, 45
 Lewisia rediviva, 231
 Libonias, culture of, 224; floribunda, 500
 Lilac from cuttings for forcing, 222
 Lillium auratum, 368; giganteum, 496, 510
 Lilliums for exhibition, 29
 Lilies in pots, 62
 Lily of the Valley, growing and forcing, 72
 Lime and sulphur mixture, 56
 Lime, superphosphate of, 137
 Lindsay, presentation to Mr. G., 9
 Liquid manure, 211
 Lisburn Chrysanthemum Society, 127
 Liverpool Horticultural Association, 112, 127, 266, 285, 308
 London, about, 357
 London Almanack, 10

MAGNOLIA CONSPICUA, 438

Manchester Show, 414, 429; notes at the, 425
 Marantas, repotting, 34
 Market gardening in pre-railway times, 438
 Market gardens, lessons in, 100
 Market, growing produce for, 315
 Marsden, death of Mr. W., 181
 Masdevallias, Mr. Burberry's paper on, 4, 25; Trochilus, 125; Armini, 409
 Masters, Dr. M. T., 109
 Maxillaria Sanderiana, 455
 Maximowicz, death of C. J., 245
 Mealy bug, clearing from Grapes, 108
 Meehan's Monthly, 284
 Meissner and his gardener, 167
 Melons, raising, 32; management of, 154; culture, 165, 182; late, 207; Mr. Palmer's paper on, 211; forcing, 292, 453; notes on setting, 381; in houses and pits, 416; late setting, 493
 Memorial funds, 44
 Mentzelias, 334
 Meteorological Society, the Royal, monthly meeting, 11; annual meeting, 85; meeting, 127, 168, 245, 430
 Metropolitan Public Gardens Association, 127

Mezereum, the common, 264
 Mice, destroying, 264
 Mice and aphides, 231
 Microlepis hirta cristata, 95
 Midland Counties Pansy Society, 429
 Mignonette, 281; as standards, 399
 Mildew, new remedy for, 168; a preparation for destroying, 413
 Mistletoe in Normandy, 286
 Mite of the Black Currant, 223
 Montrenil, Peaches at, 461
 Moorman, Mr. J. W., appointment to Brockwell Park, 365
 Morel, the edible, 459
 Moth, the winter, 4, 264; death's head, and bees, 365
 Muscat Grapes, early, 174; syringing, 238; not setting, 419; berries not swelling, 478; lateral growth on, 485
 Mushrooms, 19; beds, frozen, 56, 86; growing, a critique, 99; united, 136; growing, 294; nitrate of soda for, 385; growing, an experiment in, 474; withering, 478
 Myosotis Bexley Geni, 392
 Myrobalan hedges, 176, 185

NANZ, DEATH OF H., 429
 Narcissus Backhousei, 241; Horsefieldi and princeps, 496; habitat of maximus, 497; cultivation of, Mr. Edmonds' paper, 426; Trumpet maximus, 429; maximus from Spau, 448; Bernardi, 473; Leedsi Beatrix, 495
 Narcissus hybrids, Albatross, 391
 Neighbour, death of Mr., 33
 Nepenthes, improving, 194
 Newcastle Show, 330; Gardeners' Society, 336
 Nitrate of soda for Onions, 294
 Normandy, a run through, 286
 Nut trees, neglected, 137

ODONTOGLOSSUM TRIUMPHANS, WHITELEY'S VAR., 143; lutco-purpureum Amesianum, 213; Pescatorei, var. Prince of Orange, 328; cool winter treatment, 340; shading and potting, 341; natural hybrid, 341; crispum varieties, O. crispum var. Amesianum, 361; hastilabium, 408; vexillarium, 428; Leroyanum, 465; crispum (Burford var.), and luteo-purpureum illustre, 516
 Oleander, poisonous, 216
 Omphalodes verna, 325
 Oncidium heteranthum, 41; Phaenopsis, 65; Larkinianum, 328; lorenzoense, 444, 517
 Oranges, proliferous, 64, 111; grafting, 376
 Orange trees, black fungus on, 76
 Orange fungus and coccids, 323
 Orchards of Normandy, 286
 Orchards, renovating, 92
 Orchids — Masdevallias and Disas, 4; shows of, 64; at Holloway, 65; leaves in Orchid houses, hardy Cyrtopodiums, 81; the Vanilla, 82; at Streatham and Carshalton, 101; Oncidium superbiens, 121; catalogue of cultivated Orchids, leaves and seaweed for Orchids, City fogs and soot, a large Vanda caerulea, 121; Odontoglossum triumphans Whiteley's variety, 122, 124; Orchids at Cleveley, 122; Oncidium Cavendishianum, 122; at Camp Hill, Woolton, 163; at Forest Hill, Odontoglossum maculatum, Schomburgkia Sanderiana, 163; Dendrobium, notes on, 182; leaves in Orchid houses, 181; Cœlogyne cristata, Cymbidiums, 291; Disas, 223; Laelia anceps, cultural notes on, 240; Cœlogyne cristata, culture of, 232; sale of the Fernside, 235; the Comte de Germiny's, 237; at the Drill Hall, 310; cool house, 237; white flowered, 314; notes on, 321; cool house, 339; in Holland, 331; jottings, 361; new, Odontoglossum crispum Wrigleyanum, O. Halli leucoglossum, excellens, 334; at Aymestrey Court, Woolton, 428; for grouping, cut flowers, Oncidium Larkimanum, 428; at the Temple, 450; new, 444; Jottings, 464; new, Laelia hybrida Arnoldiana, Disa Veitchii, 465; renovating, 478; on tree stems, 493; review of the Lindenia, 517
 Orchids and fog, popularity of, 145
 Ormerod's works, Miss, 289; Report, notes on, 332
 Orton Longueville, 35, 443

PALMS, BURMESE, 89
 Palms, cutting off the roots of, 339, 366
 Pancreatiums, 175
 Panicum variegatum, 194
 Pansy, cultivation of the, 122; the Fancy, and best varieties, 140; note on, 364; Society, Midland, 429
 Parcell's post for flowers, 336
 Parson's garden, gossip in a, 2
 Paris, gardening and flowers in, 87
 Paris green, its application, 212; and red spider, 376; and caterpillars, 385
 Parisian market gardening—Radishes, 436
 Parsley for a sandy soil, 85; providing a winter supply of, 147; scarcity of, 161, 187; on mounds, 345
 Passiflora planting, 20
 Patent rights, 354
 Peach trees, regulating the growth of, 262; setting and stoning fruits, green in a, 266, 280, 282, 301, 319, 342, 359, 376, 387; unsatisfactory, 235; leaves blistered, 489
 Peaches, forcing, 32; tree casting its buds, 137; removing flower buds, 181; growing at Bexley Heath, 187; Crimson Galande, 225; forcing, 232; mildew on, 234; spraying, 275; outdoor, 331; injured by fumigating, 334; forcing, 393; at Montrenil, 431
 Peaches and Nectarines, Mr. Tunnington's paper on, 35, 80, 106; forcing, 73, 114, 273, 519; under glass v. outdoor, 142; forcing, 154; description of varieties, 160; notes on, 200, 298; under glass, 211; cultural notes on, 341; watering, trees gumming, 354; earliest, 436; in June, 475; note on, 497
 Pearl bush, 470
 Pear tree, grafting a, 116; bush and pyramid, 180
 Pears, selection of, 193; not ripening, 334; cracking in, 492; and remedies, 504
 Peas, raising early, 115; culture of, 184; for succession, 253; Sweet, 252; three good varieties, 323; early, 510
 Pelargonium, 135; for winter, 209; at Twickenham, 358; Ivy-leaved Zonal, French and Faneys, 417; Zonal, 478; for exhibition, 500
 Phalaenopsis speciosa, Imperatrix, 384; Major-General Berkeley's, 464
 Phenological phenomena, 429
 Phloxes, propagating, 397; herbaceous, 416; dwarf, 433
 Phyllanthus niveosus, 265, 325
 Phyllocactus, notes on, 71
 Phylloxera in champagne districts, 147
 Pine beetle, 354
 Pines, forcing, 135; starting, 173; forcing, 291, 436; for winter fruiting, 475
 Pinetums, small, 107
 Pink Society, National, 136
 Pipes in fruit houses, arranging, 179
 Pither plants, renovating, 397
 Plant houses, February work in, 115; seasonal work in, 95
 Planting and pruning, 193; in spring, 219
 Plants and gardens in the West Indies, 401
 Plants, variegated for rooms, 39; top-dressing, 277, 363; certificated at the Palace Show, 453
 Platycerium, notes on, 392
 Pleurothallis Colibri, 102
 Plums, pruning, 154; culture of the, 423
 Poinsettias, 457
 Pope, death of Mr., 510
 Poppies, the Shirley, 9; note on, 253; double annual, 359
 "Potato culture," Mr. Ward's Manu l, 344
 Potatoes for Ireland, suggestions on, 61, 82, 103; two good early, 87; a curious, 114; Fenn's first crosses, 152; early, 239; for exhibition, 299; early in Ireland, 305; Sweet, 334; early planted, 489
 Potting plants, 3, 43
 Preston and Fulwood Horticultural Society, 245
 Primrose, James Nimmo, 311; Covenanter and Lady Erskine, 328; dividing and replanting, 522
 Primroses and Polyanthus, 243
 Primula capitata, 345, 344
 Primula imperialis, 515
 Primula Kentish Fire and Kentish Purple, 125; propagating double, 127; at Perry Hill, 161; sikkimensis, 275; Primula's, 333; Scottish Society's Show, 337
 Propagating, hints on, 189
 Pruning, rough methods, 45; fruit trees, 137; in spring after planting, 211
 Pteris serrulata, 95; Victoria, 388
 Pulmonaria officinalis, 334

Pump, Snow's patent, 213
 Pyrus japonica, 489
PLANTS CERTIFICATED—
 Amaryllis, J. R. Pitcher, 213;
 Olivia, Vandyke, 250. Anthurium burfordense Laingi, 292. Arum palatinum 250. Aspidium lanceolatum microdon, 458. Athyrium Filix-femina Girdleston cristatum, 453. Azalea mollis fl. pi. Mecene, Norma, 250; indica, M. Labrousse, Pharaide Mathilde, and Princesse Clementine, 328. Begonia, Duchess of Leinster, Lady Lawrence, 474; Lady Addington, Mrs. R. Dean, and W. Marshall, 453; Madame la Baronne de Saint Didier, and Major Hope, 516; Triomphe de Nancy, 311; Winter Gem, 50. Bertolonia Adolphe de Rothschild, Madame Leon Say, 259. Bulbophyllum mandibulare, 250. Ca'dium B. S. Williams, 453. Camellia Beauty of Waltham, 250; Duchess, 311. Campanula abietina, 516. Canna Jules Chretien, 516. Cattleya Mossiae var. gigantea, 384; Mossiae Lawrencei, 474; Schroedera var. Leyswoodensis, 384; Trianae Hardyana, 218; Trianae plumosa, 125. Carnation Iver White, and Lord Rendlesham, 516; Selby, 474. Celmisia spectabilis, 474. Chorozema Lowi, 125. Cirrhopetalum Mastersianum, and picturatum, 250. Clematis Snow White Jackmanni, 453. Clivia Prince of Orange, 251. Cocos Pyuaerti, 453. Cycnocheilus chlorochilon, 516. Cypridium Creon, 125. Dendrobium melanodiscus pallens, and Rainbow, 250; noble, Hardy's variety, 213; Phalaenopsis Statteriana, 516; Venus, 311. Dracana australis variegata, 453. Epidendrum hybridum dellense, 311. Eremurus himalaicus, 453. Gloxinias electra and Monarch, 516. Hamamelis Zuccariniana, 125. Indigofera Gerardiana alba, 516. Iris Danfordiae, 125; Gatesi, 516; Princess of Wales, Queen of May, 474; variegata: Robert Burns, 516. Lacena bicolor, 516. Laelia anceps Ballantineana, 50; elegans Cullimore's variety, 474; Gottoniana, 516; grandis, Tring Park variety, 516; hybrida Arnoldiana, 474. Lilac Leon Simon, 392; Madame Lemoine, Michael Buchner, 453. Lycaste Mastersiana, 311. Masdevallia Trochilus, 125. Miltonia vexillaria Mrs. H. Ballantine, 474. Myosotis Bexley Gem, 392. Narcissus Albatross, 391. Odontoglossum crispum Amesianum, 213; Wrigleyanum, 384; crispum Burford variety, 516; Halli leucoglossum, 384; luteo-purpureum illustre, 516; Pescatorei, var. Prince of Orange, 328; trinmphans, Whiteley's variety, 124. Oncidium Larkinianum, 328. Paeonia arborea Mrs. W. Kelway, 453; Louise Mouchet and Paradoxa, 474; Moubeam, 516. Pelargonium

PLANTS CERTIFICATED—continued

Royal Ascot, 453. Phalaenopsis speciosa, var. Imoeratrix, 384. Pink Princess Maud, 474. Polystichum, 453. Primrose Covenanter and Mary Erskine, 328; James Nimmo, 311. Pritaulas Keatish Fire and Kentish Purple, 125. Pteris cretica crispata, 392. Pyrethrum James Kelway, 474. Rhododendron Championi, 328; Rosalie Siedel, 453. Roses Clothilde Souper, Crimson Queen, Souvenir de la Rosieriste Gonod, and Spencer, 453; Denmark, 250. Saxifraga Boydii, 250. Sobralia macrantha var. Kienastiana, 474. Spiraea multiflora compacta, 474. Streptocarpus New Hybrid, 453. Sweet Briar Lady Penzance, 392. Thunia Bensoniae Winniana, 516. Weigela hortensis nivea, 516

QUICKSET HEDGES, 201

RABBITS, EXCLUDING FROM GARDENS, FEEDING, 33

Radishes, culture in the Paris gardens, 435
 Rainfall and fruit trees, 112
 Ramondia pyrenaica alba, 241
 Ranunculus, seasonable notes on, 83, 263; anemonoides, 304
 Raspberries, removing, 96; autumn bearing, 112; note on, 45; culture of, 468
 Review of 1890, 1
 Review of book, Webster's International Dictionary, 93; the Lindenia, 517
 Rhododendron Boothii, 28; greenhouse (Mr. Waterman's paper), 131, 148; dahuricum, 264; seed sowing, 314; Championi, 328
 Rhubarb, the earliness of, 246, 288; notes on varieties, 355; Early Red, 368, 396; description of varieties, 493
 Richardias, after flowering, 414
 Richards, death of Mr., 228
 Richmond Horticultural Society, 10
 Romulea bulbocodioides grandiflora, 338
 Rooksbury Park, 342
 Root-pruning fruit trees, 423
 Roseland—Hyères, 51
 Rose Shows for 1891, 212
 Rose, transplanting Maréchal Niel, 97
 Roses, grafting under glass, 56, 91; stray notes, William Barton, judging cards, judging difficulties, 107; failing and planting, 152; the "Rosarian's Year Book," 164; duplicates, pruning, 185; aphides on, 217; propagation in America, 239; pruning, 270; list of shows, Maréchal Niel, a large, 920; new French Teas, 323; single Banksian, 349; Mrs. Paul, 363; from cuttings, 366; "Concert," 388; artificial manure for, 396; new, 402; (Tea) Sappho, 413; Safrano, Gloire de Dijon, 404; new, 453; stray notes, 437;

ROSES—continued

Rose notes and prospects, 486; Tea, in pots, 500; in November, 501; National Show of Teas, 509
 Rose Society (National) meeting, 68
 Rouen orchards, 286
 Ruthin Castle, 306

SALADING, 19

Salvias, culture of, 180; patents, 252; generiflora, 293
 Sander, Mr. F., 449
 Sarcopodium Godseffianum, 25
 Saxifragas, notes on, 281
 Schlumbergeria Lindenii, 237
 Schomburgkia Sanderiana, 163
 Schomburgk, death of Dr., 406
 Sea sand, 216
 Seaweed, decayed, 97; for Orchid houses, 121
 Sedums, notes on, 103; notes on, 150
 Seed germination, 45, 241; vitality and distribution, 241; sowing, 294
 Selaginella caesia, 194; Kransiana, hardy, 344
 Sewage sludge, 438
 Shanes Castle, 229
 Sheffield Floral and Horticultural Society, 127
 Shortia galacifolia, note on, 281
 Shoulder sprays and buttonholes, 338
 Shropshire Floral and Horticultural Society, 245
 Shrewsbury Floral Fete, 111
 Silene acaulis, 231
 Sisley, death of Jean, 84
 Snow, effects on plants, 345
 Soil, improving, 177; burnt, 196; and aspect for fruit trees, 424
 Somerville, Dr. W., 293
 Southampton Show, 414
 Southport Gardeners' Society, 10
 Sparrows and fruit buds, 111; versus caterpillars, 63; and Gooseberry bushes, 16
 Spinach, New Zealand, 520
 Spiraes, 263; confusa, 271; japonica, 377
 Spraying, 216; appliances, 250; trial of, 251
 Spraying and syringing, 193
 Spinach Beet, 21; Victoria, 385
 cultivation, 259; future supply, 380
 Spring planting, 119; and pruning, 219
 Stachys tuberosa, 170, 186, 325
 Stakes for trees, 84
 Statice Swarowi, 215
 Stephanotis floribunda, 174
 Stocks for fruit trees and Roses, 56
 Stokesia cyanea for late flowering, 314
 Stoking, remarks on, 100
 Stoneleigh Abbey, 470
 Storax and Benzoin, 419
 Storm damages, 225
 Stove plants, notes on, 233
 Strawberries, productive, 28; in pots, 32, 115; Bothwell Bank and President, 244; diseased, 289; in pots, 292; Bothwell Bank and President, 395, 323, 365, 413, 425; cultural notes on, 331; early forced, 343; note

STRAWBERRIES—continued

on, 415; in pots, 437; preparing plants, 466; early, 488; culture of, 487; Waterloo, 488; netting, 497; records of ripening good earlies, Alice Maud, Noble, Marguerite, 505; Laxton's Scarlet Queen, 510
 Streptocarpus, hybrids, 344, 453
 Strophanthus Kombe, 9
 Sulphate of iron and sewage, 117; of a monia, uses and application, 235
 Sulphuric acid injuring foliage, 348
 Sulphur remedies, 377
 Sultan, Yellow, Sweet, 255
 Sunderland Gardeners' Mutual Improvement Society, 265
 Sunshine in 1890, 278; in winter, 269
 Swansea Chrysanthemum Society, 285
 Sweet Briar, Lady Penzance, 425
 Syringing Muscat Grapes, 233

TELEKIA SPECIOSISSIMA, 9
 Temple Show arrangements, 284; Show, the, 421; report of the, 449
 Thames Ditton Horticultural Society, 244
 Thunia Bensoniae Winniana, 516
 Thysanacanthus rutilans, 48
 Tiarella cordifolia, 281
 Tomatoes in winter, 56; early, 126; imported, 187; mildew on, 255; failing, 438, 459; in the open, 441; blossoms falling, 478; new, 470; fungus on, 478, 501; diseased, 500; remedies for, 591
 Top-dressing plants, 277; in pots, 339, 366
 Tree, large, 63, 167
 Trees, failing and improving, 27; cutting down large, 147
 Trees and shrubs for wet positions, 255
 Trowel (garden) improving, 147
 Tuberoses, culture of, 409
 Tulips, notes on early, 494; National Show, 438; Society, Royal National, 428; Dr. Hogg's, 462; double, 470; Society's Show, Royal National, 472; failing, 500
 Turner Memorial prizes, 8
 Turnips, early varieties of, 43; note on, 253
 Tuberoses, cultural notes on, 102

UPPER HOLLOWAY, PLANTS AT, 512

VANILLA, CULTURE OF, 82, 101
 Variegated plants for decoration, 39, 64, 81, 123
 Vaseline in insecticides, 407
 Vegetables and frost, 147
 Vegetables and fruit, 126
 Vegetables, notes on useful, 24; destruction of and early supply, 29; under glass, 115; their varieties and cultivation, 200, 224; scarcity of, 120; exporting, 458

Verbenas, 252
 Vine and Cucumber leaves, 295
 Vine borders, watering, 253; watering, 289; leaves, warts on, 478
 Vines and vineries, seasonable work, 300
 Vines, forcing, 18, 54, 94, 134, 173, 252, 373, 415; young, 20; borders, making, 21; scraping and dressing rods, dressings for borders, 56; borders, blood for, 137; in pots, cropping, 137; borders, enriching, 176; early and late, 193; planting, 234, 291; buds and insect, 294; notes on planting and management, leaves warted, 335; thrips on, 376; early and mid-season, 455; mildew, remedies for, 500, 501
 Violets in fames, 34, 151; in winter, 257; Comte Brazza's, 305; note on, 374

WAKEFIELD PAXTON SOCIETY, 265; annual dinner, 326
 Wakefield Talip Society, 495
 Wallflowers, 416
 Wanderings in Belgium, 26
 Ware Horticultural and Mutual Improvement Society, 245
 Water and watering, 593
 Warts on Vine leaves, 157
 Wasps, a trap for, 446; queen, 469
 Water culture, ingredients for, 45
 Weather, severe, 8; in London and the north, 27; in Lincolnshire and Herts, 23; in London and Scotland, 44; in Notts, 45; remarkable snow-storm, 207; in Paris, 325; sensation, 405, 430; and the crops, 447
 Weather notes, 83
 Webber (garden), 231
 Webster's International Dictionary, 93
 Weevils on Vines, 523
 Weigela hortensis nivea, 516
 Widcombe Institute, 433
 Williams Memorial Fund, 87
 Wilson, death of Mr. John, 365
 Wines, home made, 112
 Winter effects in gardens, 104
 Winter garden, an attractive, 38
 Winter moth, the, 4, 117; destroying the larva, 255
 Winter difficulties, 80
 Winters, references to severe, 59, 67
 Winter sunshine, 269
 Wiot, death of M. François, 285
 Wireworm in flower beds, 255
 Witloof, culture of in France, 221
 Woodseat gardens, 71
 Woolton Gardeners' Mutual Improvement Society, 87, 167, 265, 285
YEAST, CULTURE OF, 64
 York florists, 9; floral gala, 46, 111, 518



WOODCUTS.

	PAGE		PAGE		PAGE
Achimenes Rosy Queen	17	Dendrobium signatum	41	Odontoglossum crispum var. Amesianum	361
Arum palæstinum	267	„ Venus	321	„ excellens var. dellense	341
Ascott Gardens, view in	105	Dicksonia Lathamii	513	„ triumphans, Whiteley's variety	143
Aster White Queen	71	Disa Veitchii	465	Oncidium heteranthum	41
Azalea mollis fl.-pl. Mecene	347	Dominy, portrait of Mr. John	149	„ Larkinianum	427
Baillie, portrait of Mr. E. J.	7	Erythronium grandiflorum	171	„ loxense	517
Bees, foundation fixing	234	Ficus stipulata, fruiting and barren branches	133	„ Phalenopsis	65
Begonia Triomphe de Nancy	329	Fig, St. John's	485	„ superbiens	121
„ Winter Gem	83	Fungicide Distributor, a new	437	Orange Trees, grafted	376
Burmese Bungalow	129	Garden Scene in May	431	Pteris Victoriae	389
„ Kyoung	169	Ham House	11	Potato, a prolificious	115
„ Palms	89	Iris Danfordiæ	151	Pump, Snow's Patent	213
„ Village	69	Irish Cottage Garden and Round Tower	47	Raspberry Catawissa	113
Carnations at the Temple Show	471	Kew Observatory, the	183	Rose (Bourbon) Mrs. Paul	367
Carpet Beds, plans of	411, 435	Kitchen Garden, Prize Plan of	247	Rose (Tea) Sappho	403
Cauliflower Disease in Strawberry Plant	289	Lælia hybrida Arnoldiana	491	„ single Banksian	349
Calliopsyche mirabilis	327	Lawn Mowers, Setting	370	Ruthin Castle and Flower Garden	307
Celmisia spectabilis	505	Leptospermum bullatum	454	Sander, portrait of Mr. F.	451
Château de Gouville and Gardens	286, 287	Leschenaultia biloba major	455	Sarcopodium Godseffianum	25
Cherry Plum as a Fencing Plant	93	Masdevallia Armini	409	Schomburghkia Sanderiana	163
Cleome heptaphylla	5	Masters, portrait of Dr. M. T.	109	Shanes Castle and Gardens	228, 229
Corypha umbraculifera	89	Maxillaria Sanderiana	445	Spiræa confusa	271
Cotoncaster frigida	29	Narcissus Albatross	391	Stott Insecticide Distributor and Syringe	250
Crosswood Park	209	„ Backhousei	241	Strawberry Plants Diseased	289
Cutler, portrait of Mr. E. R.	189	„ Bernardi	473	Streptocarpus hybrid	453
Cypripedium Castleanum	101	„ Leedsi Beatrice	495	Sweet Briar, Lady Penzance	425
„ Maynardi	281	„ pseudo-Narcissus Cressida	383	Vinery, a useful	309
Dahlias, Tom Thumb, and their raiser	31	„ pseudo-Narcissus Dr. Hogg	301	Wasp Trap	447
Dendrobium melanodiscus var. pallens	261	„ pseudo-Narcissus Samson	203	Webber, a garden	231
		Nesting Boxes, Belgian	303		

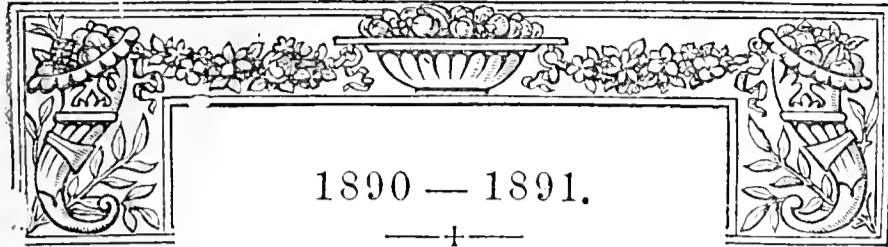

1890 — 1891.

NO one interested in horticulture can think, speak, or write of the year that has now closed without somewhat depressed feelings. Never in the many years that I have been associated with horticulture have so many in all its departments passed away from amongst us. Never have I had to mourn the loss of so many valued friends with whom I have been associated in our common love. From the accomplished artist, probably the best, and certainly the most adventurous and enthusiastic botanical artist of modern times, Miss Marianne North, down to the working gardener, many and many a gap has been made, and my first thought in reviewing the past year must be given to them. Passing by, then, those with whom I was not acquainted, what a list there is of friends whom one will never again meet here. Early in the year we received the news of the death of Mr. Wildsmith, the accomplished gardener at Heckfield. No one who has ever visited that charming spot, and had the privilege of being shown over it by Mr. Wildsmith is likely to forget it, and when some years ago the members of the Horticultural Club spent one of their most pleasant outings there, it was a day in all the memories of those who shared in it to be marked with the whitest of white chalk, and the memorial which was founded by his friends in connection with the Gardeners' Orphan Fund is ample testimony that the feeling of sorrow was not confined to them alone, but was shared by a large circle of admirers.

In the month of June there passed away two very prominent figures in our metropolitan horticultural circle. Mr. B. S. Williams (Ben Williams, as he was generally known), the eminent nurseryman of Holloway, but who is more associated in my mind with Manchester, where in former years I used to meet him at the great Whitsuntide festival, which he energetically supported, and where he was a general favourite. He was too well known for me to do more than say that as a grower of Orchids, Ferns, and stove and greenhouse plants he had few to equal him. A Williams' memorial, also in connection with the Gardeners' Orphan Fund, and which was one of the last generous acts of dear Shirley Hibberd, is a witness to the worth which made him so many friends. In George Deal horticulture had to mourn not a grower of plants, but a warm and sympathetic friend to any movement likely to advance the material interest of the gardener. More especially does the Gardeners' Orphan Fund owe him a deep and lasting debt of gratitude, for as its Chairman he threw a vast deal of life and energy into it, and by his thorough financial knowledge placed it on a firm and substantial basis. It was a graceful act in kind and generous Mr. Harry J. Veitch and Mr. N. Sherwood to contribute a sum which, supplemented by the contributions of other friends, enabled the seven unsuccessful candidates at the last election to be placed on the list of recipients. There is no one more missed at our horticultural meetings than our genial and hearty friend.

No one ever was in the company of James Backhouse of York, I am sure, without feeling drawn towards him, there was so much of that simple piety and quiet gentleness which belonged to the Society of Friends of which he was a member, and no one has ever visited the York Nurseries under his guidance without being charmed by his extensive and accurate knowledge, more especially of alpine and herbaceous plants; many were the pleasing stories of

his rambles in search of them, and of his journey to see the "midnight sun," of which he made a beautiful oil painting, for he was an accomplished artist. Another who is associated in my mind with these plants, although he was an excellent and successful Orchid grower, was Mr. Enoch Hurvey, whom, however, I saw but once at his home at Aigburth. I have already in my review of the Rose season alluded to the death of that very successful raiser of Roses, Mr. Henry Bennett of Shepperton, and I need not further refer to it.

For many years we have missed at our horticultural gatherings the presence of that most generous and kindly of the patrons of horticulture, Mr. James McIntosh. Of him, too, I have already written in the pages of the Journal, and therefore I need do no more than say that every day proves how great is the loss that we have sustained.

The Chrysanthemum Centenary, however successful it may have proved, will be ever remembered by all lovers of the flower with mournful feelings, as directly or indirectly it occasioned the death of two of the most ardent supporters of the flower, Mr. Wm. Holmes and Mr. Shirley Hibberd. The former was, indeed, suffering from a disease which sooner or later must have carried him off, but his arduous exertions to secure a success for the Exhibition no doubt hastened his end, while I believe there is little doubt that that "chamber of horrors" called St. Stephen's Hall with its wretched cold draughts brought on the illness by which Shirley Hibberd was done to death. No figure was more conspicuous in horticulture, no name more generally honoured, and no one could possibly be more genial and energetic than the good friend whom we all mourn.

But now passing away from our death roll let us turn to some brighter subjects, and now at any rate no one interested in horticulture can avoid giving the first place to the Royal Horticultural Society. Time was, in the days when the nursemaids and babies reigned supreme at South Kensington, when all its doings were looked on with alarm, wondering what might come next. We now feel that all its intentions are designed for the good of horticulture, and are, therefore, prepared to welcome them. The grand idea what has been a long time in the air of having a central Hall for Horticulture has culminated this past year in a decided step in advance, and although it now somewhat hangs fire, yet it is but undergoing the process which so many of us know so well, when in building a school, restoring a church, or some similar effort the last portion of the money is that which it is most difficult to pull together, so half or more than half of the money is subscribed, and there it seems to stop. Let us hope that 1891 may see it carried out or advanced a still further step. The meetings in the Drill Hall have been most interesting, and it shows much love for the Society when such men as Baron Schröder, Sir Trevor Lawrence, Major Mason, and the leading nurserymen will exhibit their rich treasures in so wretched a place as it is. If I could give a note of warning it is that the Society should not assume too much. There are some fetish worshippers amongst its members who think no good to horticulture can come from any other source, and who look jealously on all societies that would seem to them to detract from its importance.

In looking back at the novelties of the past year the most noticeable have been, as in the past few years, amongst the Orchids, where the hybridisers are "bothering" the botanists by the introduction of garden varieties, which they have so strenuously ignored; and among Orchids Cypripediums still hold in general estimation the first place. Amongst stove and greenhouse plants there has not been, as far as I recollect, anything very remarkable. The novelties amongst Roses I have already spoken of, and in other florists' flowers there has not been anything exceptionally fine. One striking feature in the taste for special flowers has been the great interest which has attached itself to Carnations. The

florist varieties have not come in so much for this, but the border varieties, and especially selfs, white, yellow, and crimson, have become very popular. It is not to be wondered at, for they are very pretty and very sweet, and so long as persons who are enamoured of them do not deny the beauty of the more refined and finished florist varieties, well and good. There is room for both sections. Begonias have reached their climax, it would seem, and we hardly expect to be startled by anything that may be produced amongst them, or in Pelargoniums or Fuchsias.

In herbaceous and alpine plants I do not think we have anything very noticeable in the way of novelty to record, although some good things have been brought before the public; and I think there is no diminution in the taste for them, but we have to be careful when a taste of this kind springs up. There is undoubtedly a supply to meet the demand, and we must be cautious as to what that supply is. Because a plant is herbaceous it does not follow that it is worth growing, and unless a garden is very large it is not worth while to encumber it with things which must be afterwards discarded; and it would be a pity that anything should check a taste which promises for us not only the old-fashioned flowers of our boyhood, but also many choice productions which the zeal of cultivators has added to our gardens in more recent years.

I am sure I am justified in saying that the taste for horticulture in all its branches is ever increasing. A great impetus has been given during the past year for instance to the subject of fruit growing, and if people will only recollect that we live in a very uncertain climate and not expect unreasonable things it cannot but be for the benefit of growers and the good of the community at large. The last season has not been a favourable one, and has acted perhaps as a wholesome check on extravagant expectations, but that a great impetus has been given to the proper cultivation of the most approved sorts of hardy fruits cannot be denied, and all wellwishers of horticulture, and indeed of agriculture, must hope that it may be continuous.

And now we must look hopefully forward. We have ended the year with a thoroughly old-fashioned winter, and it may be, let us hope, the prelude of a successful season. I am but one out of many contributors to the Journal, although its oldest one, and I am sure I may on their behalf and my own offer to our venerated chief our fullest wishes for a Happy New Year, and that he and all those who so zealously work with him to maintain the long established reputation and position of the Journal they so ably conduct may see another successful year, and that the spirit of unity and brotherly feeling which has always characterised the Journal may be maintained, as indeed under our chief's able and wise administration it is sure to be. Like him I have grown old in the service, and yet one's love for flowers and one's love for those of like tastes does not grow colder. I have received so many kindly proofs of their love and affection that I should be cold indeed if my heart did not warm towards them; and I must conclude this rapid sketch of the past year by wishing them much happiness and blessing in the coming one, and to contributors and readers alike to bid them God speed and a

HAPPY NEW YEAR.

—D., Deal.

GOSSIP IN A PARSON'S GARDEN.

I WAS very much struck with the admirable papers, headed "Renovating Orchards," by my friend Mr. John Wright—who I hope has not forgotten my existence, as it is so long since we met—and published in the *Journal of Horticulture*, Nos. 2199, 2201-2, in which among other valuable advice he strongly advocates the unstinted application of liquid manure, especially in the ordinary form of sewage, wherever and whenever available.

Now, as I have constantly used this plant food for years I believe it will be to the benefit of the public if I ask permission, Mr. Editor, in a somewhat egotistical paper to give my experience and its results. I will premise my remarks by stating that I am,

like most of my brother parsons, my own head gardener, so I can confidently vouch for my facts and figures being reliable.

First I would mention the situation of my two walled kitchen gardens, which are several hundred feet above sea level and well sheltered; aspect facing south; soil a calcareous clay on an unusually deep and naturally drained marl, singularly poor in nitrogen, but including valuable potash salts and other inorganic substances by the size and colour of the fruit it grows. Its surface-conglomerates under a few hours' sun, and when thus seen would be enough to bring a look of despair even into a Scotch gardener's face.

By dint, however, of frequent hoeings and forkings, liberal supplies of manure from my glebe farm (mostly in the shape of cow manure), and above all by copious libations of sewage all through the year when work is slack from a large tank supplied from the house and stables—without which paragon of utility I maintain no country establishment should be built, and against which if only properly trapped and upshafed the most nasally fastidious should have nothing to object—my naturally poor soil is rapidly becoming productive, while my crops already more than hold their own, my fruit especially when brought into comparison with my neighbours, who grow them under far more advantageous conditions. And now to give some details. My only failure, and one shared by most gardeners and orchardists in Herefordshire and other counties for the last two years, was in the Apple and Pear crops. My cordon Pear wall (facing south) I mention here as an exception, on which I had rather more than half a crop of well-flavoured and highly coloured fruit, though not so large as usual, mostly of the best late French varieties, which are ripening unusually well and seasonably.

The following varieties have done admirably this year:—Durondeau (splendid colour), Baronne de Mello (always highly flavoured with me), Beurré de Ghélin (richest Pear I grow); General Tottleben, Madame André Leroy (fine, but uncertain in ripening), Pitmaston Duchess (several last year 14 to 16 ozs.), and Maréchal de Cour all produced heavy crops. The season of 1889 was so disastrous, owing to the caterpillar scourge, that a crop of Apples and Pears could hardly have been expected or even desired this year, so terribly did the trees themselves suffer, in many instances to the entire denudation of their leaves. At the present time I rejoice to say there is every appearance of perfect health and abundant promise of a crop next year, well-ripened wood and short-jointed fruit buds being the rule everywhere, not the exception.

I much regret that last year I received a Stott's patent sprayer too late to judge with any degree of certainty as to the experiments I made with Paris green and his insecticides, but as to the usefulness of the instrument itself when attached as mine is by a hose to an ordinary garden water syringe, I cannot speak in too high terms. I hope early next spring to give his insecticide a careful trial *pari passu* with Paris green, and report results to our Journal.

I may mention that the few varieties of Apple trees and pyramids (about some 400), which bore any crops worth recording, were Stirling Castle (enormous crop on pyramids); Herefordshire Beefing (very late keeper and wonderful bearer); Golden Winter Pearmain (perhaps the most profitable Apple grown); and strange to say on my poor ground Cox's Orange Pippin. Every tree and shrub vigorous and bearing fine crops. Apropos to Apples, Why is it the Britisher will go wild as a producer and consumer about that mongrel variety the Blenheim Pippin, neither first rate for the kitchen nor eligible for the dinner table? but so it is. To travestie an old line I remember to have seen somewhere in reference to another Apple, "Omne Malum malum præter Blenheim Malum." What a thing it is to be in the fashion, or to once command the market! In pleasing contrast to the almost complete failure in my Apple-crop I am proud to set off my east Plum wall as a complete success, in greater contrast from an almost universal as well as local failure this year.

When I came to my present residence five years ago I bought my Plum as well as my Peach, Nectarine, and Cherry trees from Richard Smith & Sons' nurseries, Worcester, and so well have they started and flourished that I calculate the average crop on each tree, which now quite covers the wall, at fully thirty-five dozens of uniformly fine smooth fruit on trees looking all over like having a similar good crop next year.

The varieties include the Victoria, Magnum Bonum, Washington, Coe's Golden Drop, Kirke's, and last, but not least, Jefferson, peerless among Plums, and perfect in richness and flavour. I may mention my wife begins quite early, as soon as the small fruit-season is over, to thin out the green Plums (on wall) for compôtes, and they are by many preferred in that immature state to when they are riper and not so delicately tasted; certainly they come in

very useful in the great dearth of most other fruit for culinary purposes.

My two walls facing west and running parallel with each other are planted with the following varieties of Peach and Nectarine trees—Peaches: Dr. Hogg, Alexandra Noblesse, Royal George, Noblesse, Violette Hâtive, Late Admirable, and Walburton Admirable. Nectarines: Lord Napier, Elruge, and Violette Hâtive. These all bore excellent level crops, quite average eight dozen each tree, the late varieties of Peaches being especially fine and well coloured, and lasting well into the middle of October.

A slight sketch of my *modus operandi* might give a hint to an amateur reader or two. Owing to my high and dry situation no protection is required from frost except what is supplied by a 6-inch heavy coping, from which hang old sea nets. Constant attention, however, is required from the early start in growth the trees make to prevent a check to the sap, and to keep under the attacks of the aphides and other insect pests, which would soon spoil all chance of a crop. This I do by periodical leaf-picking and shoot-rubbing, foreright and others where crowded or needless, thus giving plenty of light and air to the surface of the tree, as well as free access to spraying daily with soft tepid water, gradually earlier as the season advances. I find it very advantageous also to pick off every abnormally large and gross leaf, whether affected by the "curl" or not, as these leaves, I believe, are nearly always unhealthy and susceptible to becoming diseased. Once every nine days or fortnight I spray with Stott's insecticide, which I find invaluable in preventing and killing aphides and other insect pests, besides giving a surprising hue of health to the trees themselves. I may here mention in passing that I found this insecticide when sprayed over Roses most successful in destroying mildew, from which my Roses suffer much; very rarely my fruit trees. But while I have been inviting attention to these minor details as being necessary to successful fruit culture, especially with the Peach and Nectarine during a growing state, I must repeat in conclusion, as I began by saying, if possible and practicable let each gardener have a sewage tank, and if he makes as good use of it as I have done he will be able to congratulate himself of having obtained the same successful results in first class fruits and vegetables as I have done.—THE HEREFORDSHIRE INCUMBENT.

POTTING.

GENERALLY, during the early months of the year this subject is brought forward as the most suitable period when potting operations should be performed. This may be perfectly right as regards some plants, or where an annual system of repotting only is practised. It has occurred to me, however, that if more attention in private gardening establishments was paid to repotting plants when they need more root room greater success would be obtained.

It is not an uncommon practice to discontinue potting early in autumn until the months of February and March, after which the whole stock of what may be termed permanent plants is overhauled. The impression is that the plants will pass the winter better in pots that are fairly well filled with roots than when they have a quantity of unoccupied soil. This certainly sounds reasonable, and at one time was not only regarded as sound doctrine, but was persisted in until experience taught us that no greater mistake could possibly be made. The principle laid down, and so long accepted as being sound, will scarcely bear an intelligent scrutiny. When a plant has filled its pot with roots, say in October, it can scarcely be expected to be in the same satisfactory condition five months hence. By the time the pot is full of roots the plant has extracted the main supplies of food, or that has been washed out by frequent applications of water, and the consequence is that the plant gradually suffers. This may be contested on the ground that artificial manures can be applied that contain all essential elements to sustain the plant, in the same pot, in health and vigour. This is true, and much more might be done in keeping plants in good condition by applying artificial manures to the surface of the soil periodically. These certainly are useful, but they are not always at command, and when used on a large scale they soon become a prominent feature in the expenditure for the year. It may be as well to say that artificial manures are not regarded unfavourably. On the contrary, rightly applied they are very beneficial, and much safer than liquids from the farmyard or stable. I am convinced that by the free use of the latter more harm than good frequently results, as it is most difficult to gauge the actual strength. There is a time when a pinch of suitable material applied to the surface is beneficial, and acts like magic upon the plants. But feeding plants over a period of five or six months to save potting cannot be advocated. In some cases it

becomes necessary to feed plants for some months when they are specially grown for a certain object, and must be confined to a certain sized pot until they have done the duty for which they have been produced.

These remarks have reference to plants that it is intended to grow large, and even supposing that plants confined during the period indicated can by "feeding" be kept in perfect health, there is another objection which is the most weighty of all. A plant confined for months in a pot may to all appearance be healthy, but being cramped at its roots the wood becomes firm, and the plant seriously checked. When potted it does not start into the same vigorous growth afterwards as would have been the case had it been repotted several months earlier. If we take two stove *Dracænas* at the present time that were raised from root portions of the stem during the early part of June that have been repotted to this stage as they have needed root room. Suppose they have a fair quantity of active roots through the soil, in fact ready for potting, the one is placed in a 6-inch pot, and the other confined until March. The one in the 6-inch will need potting again by that time, and in May one will be as large again as the other. It is just possible, however carefully the confined one has been fed, it may never grow freely afterwards. The comparison need not be confined to *Dracænas*, the same marked difference is observable with *Crotons*, and all who aspire to grow these plants well cannot hope to attain much success by cramping their roots. From the first they must be repotted as soon as a fair quantity of roots are through the soil in which they are growing. To the inexperienced the plants will for a time present the appearance of being overpotted even until they are given their final shift. The free growth and bold foliage that plants make under this system is astounding even to those in the habit of practising it. The rapidity with which plants grow that are rooted and repotted as they need it should render obsolete those starved specimens that we too frequently see destitute of foliage at the base. If we look for one moment at a totally different class of plants, we find exactly the same results. Take two tiny Ferns in thumb pots, allow the one to be confined in its first pot too long, and it is a struggling example in a 4-inch pot, while the other is a large spreading plant in a 6-inch pot. If there is one secret in plant growing more pronounced than any other it is in pushing them on as rapidly as possible. This is principally accomplished by repotting on the plants when they need it, provided watering is done carefully, the temperature and other atmospheric conditions are rendered suitable.

Though stove plants have been given as examples the system advocated is by no means confined to them. It is the same with Roses in pots, *Cyclamen* and greenhouse plants generally. The exhibitor who figures in the front rank with *Chrysanthemum* is not the individual who allows his plants in their early stages to be checked by confinement at their roots. They are carefully watched, and shifted into larger pots directly they need it. The principle so strongly enforced a few years ago of confining these plants in small pots to ripen their wood has long since been exploded. The person who reverts to this principle of culture will find that he has but a poor chance by the side of those who give their plants more liberal treatment. While this principle of potting is recognised as essential in the culture of the *Chrysanthemum* we find even in the same garden the opposite treatment accorded to a host of plants. How is this?

We frequently find plants retained year after year in the same pots by an annual reduction of their roots; yet many plants can be grown so rapidly that it is much better to strike cuttings frequently, and grow the plants quickly. By constantly striking and repotting there need be no excuse for sickly bare-stemmed plants, even when quantities are used for room and other forms of decoration, that is certain to seriously injure them. When plants are constantly in demand for these purposes it is better to employ them until they are no longer suitable, and then convey them to the rubbish heap. If needed for stock the case is different, and they must be retained. Fresh plants raised from cuttings or by seed always grow with vigour, and eventually make, under good culture, presentable specimens. This is not all. Young plants generally can be grown free from insects, while those that are in feeble health are a certain prey to them, and give constant trouble in sponging and other methods of cleaning.

The practice of taking out the roots of plants with a pointed stick before they are repotted cannot be too strongly condemned. If the object is to grow the plants they should never be in a condition to need the liberation of their roots. When potting has been neglected until the roots are coiled firmly together it is better to pot them than severely root-prune them. Many plants might as well be conveyed to the rubbish heap as subjected to such extreme measures.—WM. BARDNEY.



MASDEVALLIAS AND DISAS.

[A paper by Mr. E. BURBERRY, Orchid Grower to the Right Hon. J. Chamberlain, M.P., Highbury, Birmingham. Read at a Meeting of the Birmingham Gardeners' Association.]

OF what are termed cool house Orchids the Masdevallias and the Disas are the most beautiful. There are some among them it is true that lack both size and gay colours; but to lovers of quaint and curious flowers these little gems are the most interesting of all cool Orchids, while the larger and more brilliant varieties should satisfy the most fastidious. I will first take the Masdevallias, a large genus, embracing upwards of 150 distinct species. They are natives of Central America, from Peru to Mexico, where they are found in mountainous regions from 5000 to 8000 feet above the level of the sea, growing by the side of streams, and in other moderately cool and damp situations.

Masdevallias had undoubtedly been somewhat neglected previously to the last few years, owing to the fact that the few first introduced into this country, such as *M. infracta*, *M. floribunda*, and *M. triangularis*, were of an inferior character; but within this last twenty years many new and beautiful forms have been imported, and it is thought that there are yet others to come which will surpass anything we have at present. I think there is yet a great future for them. They are being taken up by nearly all Orchid growers in a most spirited manner, some having formed whilst others are forming complete collections. How brilliant and rich in colours some of the Masdevallias are! what a range from the darkest red to the most exquisite shades of purple and scarlet, snowy white and golden yellow! Who can see Masdevallias *Veitchiana*, *igneae*, *Harryana*, *Lindeni*, *Davisi*, *tovarensis*, and *rosea*, grouped together in flower without admiration, and wondering why the Masdevallia is not better known and more largely grown by amateurs in general? Then there are those which are most interesting on account of their quaint forms and peculiar colours, their minute flowers, and in some the foliage, as in *M. tridactylites* and *M. triglochis* to the bold *M. macrura*, and *M. trochilus*, and the wonderful *Chimæra* section. What a field of study for the amateur and professional alike is a collection of these Orchids.

Picture a small house (for a large one is not necessary, these plants are of compact growth and need but little space) with from 100 to 200 distinct varieties, of various shapes, sizes, and colours. There are always some in flower, for when well grown they produce flowers in abundance, some twice a year and others continually. Then again there are chances of adding to the collection by the grower's own pains and perseverance, for the Masdevallia submits readily to the hybridiser, is easily fertilised, and new forms are thus obtained. Many have been raised, some of which are in commerce; amongst them is the beautiful *M. Chelsoni*, which was the first hybrid of this genus raised in Europe, its parents being *M. Veitchi* and *M. amabilis*. If their beauty, and the value of some for decorative purposes, the graceful habit when not in bloom, the easy growth, and the small outlay with which they can be obtained and grown were better known, this remarkable family of Orchids would find a home in many gardens if all others were excluded.

As I have said the Masdevallia will do credit to the cultivator, and it has, as an Orchid, two things in its favour:—first, instead of "becoming beautifully less," it will increase in size, and in time make handsome specimens, if the growers only give it rational treatment. Secondly, if this rational treatment is not forthcoming these plants, having no pseudo-bulbs, will die out of the way. I will endeavour to illustrate how Masdevallias succeed with me. I will, in the first place, describe the house and the position thereof. Although it is an Orchid which adapts itself readily to cool house culture, yet I find a lean-to having an east, north, or west aspect, suit it best; anywhere as long as it is well sheltered from the sun. On no account must it be a south aspect, for the Masdevallia is a cold and moisture loving plant, and therefore requires shade. No matter if it is in a position surrounded by walls or buildings, leaving only the north, east, or west aspect, so much the better, for this is the house I prefer. In addition to this plant loving shade and moisture, it also delights in a uniform and even temperature, sudden fluctuation being most detrimental. And there it is snug, and sheltered from the sun and winds, hot, dry or cold, and there it is easy to maintain an atmosphere wherein the plants will revel. The house should be built upon the ground level, not sunk below the

surface, well ventilated, with a good supply of soft water, and with open stages. The general idea is that the Orchid house is not complete if it has not closed stages, with some moisture retaining material placed thereon. I acknowledge that moisture is most necessary, but it is better not to obstruct the free passage of air. Air and moisture together constitute the key-note of success. Both are absolutely necessary; but let one be in excess of the other and the results are soon apparent. One result is this, a few leaves on a plant look a trifle sickly; touch the plant, and many, if not the whole of the leaves, fall to the ground. The best Orchids that I have ever grown, and the best that I have ever seen, have been grown on open stages, therefore I am of opinion that it is the right principle to adopt. I do not mean to infer by describing this house and position so minutely that it is absolutely required for the culture of these plants; for instance, where the *Odontoglossum* and other cool Orchids grow successfully, there also at the warmest end will the Masdevallia thrive, let it be a lean-to, span-roof, or otherwise. Knowledge has simply to overcome difficulties, and there are sure to be some in every house, but in the one I have described there are the least.

In making a purchase plants that are established are preferable, for newly imported plants are difficult to establish and frequently die. Great care must, therefore, be taken if imported plants are secured. At first hang them up by the roots in a shady part of the house, giving no water direct. Signs of life will soon appear, the leaves becoming too plump. When this takes place a gentle watering occasionally will do no harm, and soon the new roots will make an appearance, when they should be potted or in baskets, according to their varieties, using pots that are just large enough to receive the roots, filling up any little space with a little sphagnum. Water sparingly till the plants are fairly established, when they may be potted in the usual way, and prepared for the general treatment.

The potting material I use for these plants consists of equal parts of sphagnum moss and fibrous peat (not necessarily all fibre), a few half-decayed leaves, rubbed fine through a sieve, with a liberal quantity of coarse silver sand. The sphagnum and peat are chopped up rather small and mixed with the leaves and sand. A little good fibre loam may be added with advantage for the strong growing kinds.

For potting I prefer the early spring—February or the beginning of March. Examine every one. Those that require larger pots should have all decayed matter removed from the roots and be repotted in new material. If well potted previously it will be in one mass, grown and rooted firmly together, and the old compost can be shaken away without the plant falling to pieces; should it, however, present a loose and scattered appearance place it in the centre of the pot, so that it may grow together. Do not overpot. A space of 1 inch between the breaks and the rim is quite sufficient; this will furnish a good criterion as to the size of the pots to use. The pots should be half filled with crocks. The plant can then be held in the position it is intended it should grow, slightly elevated above the rim, the roots carefully handled, evenly distributed, and the compost packed in moderately firm between and around, leaving a firm, even, and pleasing surface rising from the rim upwards to the base of the leaves.

Do not pot unnecessarily; repotting Orchids is a necessary evil. If Masdevallias have room to grow, and the roots are in good condition, do not disturb them by any means, but simply top dress. A plant once properly potted and watered should last for two years, and all that it will require is to be top dressed; this should be done twice a year, in spring and autumn, and the cleaner the surface, the pots, and other surroundings are kept, so much the better will the cultivator be rewarded.

(To be continued.)

THE WINTER MOTH.

THE severe weather has for a time prevented these pests depositing their eggs, but my experience is that sharp frost has no injurious effects on the eggs already laid, so that it would be folly to think that their vitality is in the least impaired. A very gratifying result has followed our spraying with Paris green, &c., last spring, scarcely a moth being seen in our fruit plantation, while they have been very plentiful only a few hundred yards away from it. As stated, this I attribute to repeated sprayings and to poultry, the latter having done an immense amount of good. On previous years the first winter moth was observed about October the 8th. This year the first I noticed was on November 15th, which was a female I discovered on the trees when pruning; since then I have not found a female in the plantation. I think this will prove that untiring energy in combatting the enemy will meet with its due

reward, and I may further add that our trees have never looked so promising, proving that Paris green when properly applied is not injurious to vegetation.

A friend sent me a cutting from the *Evesham Standard*, in which Mr. Hiam questioned the power of the male moth to convey the female into the trees. That such is an absolute fact I am positive, as I have caught many males and females flying together, as a rule ranging from 2 to 3 feet from the ground. In only a very few cases have I found them as high as I could reach, and then they were between high hedges. In the autumn of 1888 we greased and regreased our dwarf trees when necessary, yet in spite of this millions of eggs were deposited on them, which puzzled me how the females got into the trees over the sticky grease bands, which were about 4 inches wide. Immense numbers were caught, chiefly at the top and bottom of the bands. After watching with a lantern some time I saw several couples fly into the trees, explaining at once how the females got in, and also proving how they came to be caught on the top side of the grease bands, as after laying their 200 or more eggs it is natural they would descend, and thus get entangled. Mr. Hiam further remarks that the moths when disturbed on the trees fall to the ground. I think that when thus assaulted it would be a very natural result for them to fall. However, as previously stated, I have had too much evidence of the sexes flying together to be in any doubt about it, so must beg to differ with Mr. Hiam on this point. With all his other remarks I fully agree, as our experience is very much the same, and I heartily wish him a more fruitful season than has been the case of late.—S. T. WRIGHT, *Glewston Court Gardens*.

FLOWER CULTURE FOR PROFIT.

HELLEBORES.

AT one time these enclosed five rows of plants in beds 18 inches apart. The rows were rather less than 9 inches apart, a similar distance dividing the plants in the row. When they began to crowd each other the second row from each side was transplanted to another bed, and also every other plant in the three rows left intact, and from two well filled beds our number was thus increased to four, a few odd plants being also put out where they could be covered with handlights. Every spring, or immediately after the flowering period and just before root action commences, all well established clumps have the surface soil cleared from them, this being returned after a good dressing of decayed manure has been spread over the roots. Moisture in abundance is also supplied during dry hot summers, drought being most injurious to Hellebores. The frames are removed soon after the flowers have been gathered, and we make a point of removing all the flowers whether particularly wanted or not, seed pods weakening the plants, but a temporary protection in the shape of branches of evergreens is given should spring frosts be imminent. The frames are placed over the beds again about the middle of November. Slugs being troublesome, the surface of the beds are cleared of old leaves and loose soil, and then covered with cocoa-nut fibre. Ashes disfigure the blooms. Strong clumps afford a long succession of bloom lasting sometimes from Christmas to Easter.

Owing to this lateness of flowering many private growers will probably have been tempted to pot some of their clumps—it is often done in fact without this inducement—and to force them, and this may end badly. They may be forwarded in gentle heat, or say a warm greenhouse temperature; but they do not do well in a strong heat. It is in the after treatment of these plants, however, that so many mistakes are made. If gradually hardened off and returned to an open and moderately cool position, kept well supplied with water or liquid manure, the plants may form strong leaves and abundance of bloom buds later on, but they ought not to be flowered in the same pots more than once. They would grow even more strongly if kept in gentle heat for some time after flowering, but thus treated they are kept free from aphid with the greatest difficulty only, and these insects once allowed to get the upper hand soon ruin the plants. The wisest course to pursue with pot plants after flowering is to harden them off and plant out before active root growth commences, or say early in March, and if need be take up more next autumn. They must not be put out with their balls of soil and root intact, much as the cultivator may be tempted to do, with the idea probably of further increasing the size of these already valuable clumps. Pot plants nor extra large newly lifted clumps do not take readily to their fresh quarters, and the only safe course to pursue is either to split them up freely or else to carefully fork away the greater portion of the old soil away from the roots. Done at the proper time—that is to say, either in March or early in April, or in the autumn, or say early in September, root action being strong at this time—the clumps may safely be very freely split up, the best pieces being arranged in

beds, and quite the smallest divisions put out among fruit bushes, where they can remain till large enough to group together. In each and every case, or whether the clumps are freely split up with plunging forks, or only shook clear of much old soil, the roots should be preserved as much as possible, spread out into the soil, and covered with some of the best of the same. It is not advisable to mix much raw or somewhat fresh manure with the surface soil intended for Hellebores, but all will be benefited by spring or early summer mulchings of strawy manure and liberal supplies of water in hot dry weather.—M. H.

CLEOME HEPTAPHYLLA.

COMPARATIVELY few plants of the Capparid family are cultivated in British gardens. Even the typical caper-yielding *Capparis spinosa* is



FIG. 1.—CLEOME HEPTAPHYLLA.

a stranger except in botanical collections of economic plants. This points to the fact that there are not many possessing marked floral attractions; but some may come under the heading of "neglected plants." Amongst these the Cleomes find a place. Of the numerous species long known in cultivation there are a few well worth a little attention. Cleome is a large genus, and includes plants of very diverse habit and character, both annuals and perennials, from tropical and temperate regions. Cleome heptaphylla, of which a flowering shoot is illustrated in fig. 1, was shown from the Royal Gardens, Kew, at the meeting of the Royal Horticultural Society, on October 28th last, together with several other rare or interesting plants. It is of moderate height, with seven-lobed leaves and white flowers, the long purplish stamens of which contrast

with the spreading white petals. The flowers are produced freely, and when well grown the plant possesses a light graceful appearance. It can be treated similarly to many other annuals from warm climates—namely, the seeds are sown in heat, and the young plants grown in light soil in the stove, or placed during the summer in the conservatory. It flowers late in summer and autumn, and lasts some weeks in good condition with ordinary care.

FRUIT PRODUCTION AND DISTRIBUTION.

IN writing upon the subject of fruit production and distribution, in these days, it is probably impossible to say anything that has not been said before in some form or other, that is to say if we confine ourselves to the sober utterance of truth and of actual fact. It is, of course, always possible to say things strikingly new, but, like the adage of the laconic critic—"What is new may not be true, and what is true may not be new"—we will rather deal with an old truth than a new falsity. I do not think, however, that this needs apology so long as the methods we advocate are on the one hand desirable, and on the other prove to be inadequately applied, or neglected altogether. It may be needful in passing too, that we, as vegetarians, view these matters in a particular, perhaps a peculiar, way.

The word *Vegetus*, in a sense our motto, indicates the direction of our view and thought, even applied to subjects such as these. Whilst the strict economist, in the utilitarian spirit of the times, approaches the question purely from the pounds, shillings, and pence point of view, and is apparently concerned in the mercenary aspect, his first and only anxiety being a satisfactory answer to his question, "will it pay?" we are moved with other, wider and deeper considerations and emotions; we are concerned chiefly with the happy healthy life of the people in the social communities which our "ism," amongst other good things, is intended to foster, and we look upon the ideal life for the happy Englander of the future as that which nearest approaches that state which can be best expressed as "self-containment," if I may be permitted to build up the word or expression best calculated to convey the impression of that happy household where little, or very little is required beyond what may be raised by its members, from the land which constitutes their holding. These suggestions seem needful to have in mind at the threshold, as it seems to be a popular belief that it is the farmers of the land who are the fruit growers. The phrase which has caught the public ear, "fruit-farming," seems to have encouraged this notion.

There is a wide difference between the agriculturist and the horticulturist—a difference which we have no time now to analyse and define closely, but, broadly stated, it is the difference between the plough and the spade, between the slashing-hook and the pruning knife. The fruit growers must be classed with the gardeners rather than with the farmers. The pomologist is more horticulturist than agriculturist. As an industry, British fruit growing will be a distinct industry in its more successful phases, the persons engaged in it will form a distinctive class, employing distinctive methods. This not only implies that a number of people have to be found to take it up, but it takes us a step further, and asks who are the people that shall take it up, and what is their training to be? These are really essential points, little as they are heeded, for we are dealing not with dead matter, but with living tissues; though Mother Earth is by nature helpful and kind to those who work with her on the lines of her laws, she cannot hinder disaster if her laws be disobeyed either through ignorance, accident, or intention. At the moment there is evidence of a fairly widespread desire on the part of those who have hitherto been occupied in towns, and who have had only town training, to take up the spade and start to turn some barren waste into an Eden. The desire is as laudable as, in many cases, the subsequent failure will be deplorable. We have here our Scylla and Charybdis. Our way must lie somewhere between this all-worthy desire on the part of those at present forming a portion of the congested population thronging our larger towns, and the rural population proper, who have practical knowledge of the management and treatment of land, but have not qualified themselves for the details, and the more careful handling of crops which the business of fruit growing demands.

I do not propose to make my paper more than a suggestive sketch of a wide subject, as within the limits at my disposal it would not be wise to attempt anything like exhaustive treatment, even of one phase of the fruit question. Further, it is only my intention to deal with such fruits as may be termed "hardy British fruits," and we may ask ourselves at the outset what main features arrest our attention as we endeavour, briefly, to grasp what is involved in the idea before us. We will consider, first, fruit production—with fruit distribution we will deal later. We find the facts which concern us arrange themselves in some such sequent order as this following—viz.: (A) Climate, (B) Land, (C) Shelter and Situation, (D) Trees and plants, (E) Labour, (F) Supervision, (G) Cultivation.

With regard to climate, we have neither Italian skies nor southern sunshine. We cannot grow Grapes on our cottage walls, nor Oranges in our garden groves; yet we can raise such fruits as will bear favourable comparison with those of any other clime, and the flavour of some of our best grown British fruits cannot be surpassed, if equalled. Even beyond the border line of England we find fruit growing carried on with energy and spirit, and I have seen and tasted Scottish grown

Apples, Pears and berries of such perfect quality as to command such enthusiastic commendation as one would think could only be evoked for the produce of Kent, or some other county just over the hedge of the garden of England. There are garden grumblers as well as holiday grumblers—people who, metaphorically speaking, are always under the shade of the umbrella, or in the vale of mist, but the climate is all right, and, as I write, I see in front of the summer house a line of cordon trained trees, and of Devonshire Quarrenden and Worcester Pearmain, with the rich red fruits peeping shyly from their green lattice. They have blushed into prettiness as they have paid court to the sun. Yes, the climate is all right.

The question of "Land" next engages attention. This is a topic bristling with suggestiveness, and were we to pursue properly any one feature of the subject, we should have quite enough in hand for the remainder of the paper, and more. The larger towns have their congested population, and when one is in the whirl of the big cities and sees the fruit shops heaped up with foreign produce—with American Apples, French Pears, and with the foreigner in strong evidence everywhere, one is inclined to become tinged with the pessimistic belief that England is all coal fields and factories, but when you take a long stretch into the country, where the eye rests on the soft blue belt of the horizon, when you pass on and on towards western, eastern, or northern districts, from this great centre, you are made aware of the fact that there is plenty of room yet for fruits and flowers, and that there are thousands and thousands of square miles and broad acres waiting to be wooed and won over to the side of higher cultivation which fruit production necessarily implies.

In the present uncertainty of the land laws, there is an element which seems to tell against the rapid and sustained extension of the orchards and fruit gardens of Britain, but it is to be noticed that many land owners are now prepared to meet tenants fairly in matters of improvement of this nature; still it is the person who is, or who becomes, a land owner himself who takes the initiative in this industry, and this accounts, in some measure, for the result at times not proving so satisfactory as one was led to believe would be the case, as persons purchasing land are oftentimes helped to a decision as to position by the price at which the land is offered. That which is apparently cheapest in the sale room is not adapted to his particular requirements like some of the better land adjoining, which carries sleek lazy cattle, or broad-backed sheep, at sight of which breeder and butcher nod approvingly to each other, and exchange silent compliments in expansive smiles, whilst the more sterile plot over the way seems only able to bear its fruit bushes as a burden, and lacks the life gift which puts vigour in the shoots and health into the tree, making it a weakly looking, weary thing, whilst over the next field or two is a rich little patch which cost the owner a few pounds per acre more as a first purchase, but it is radiant with dainty blossom in the spring time and glorious with its weight of Apples at Apple-tide, when the orchard is decked in purple, green, scarlet, and gold. The State may not be prepared to take up upon a national basis the question of land law, but it ought at least to recognise the true importance of the industry of British fruit growing, by putting it upon some footing of advantage as to State aid in some form or other—just as it has helped the fishing industry and other movements similarly favoured.

There is then, happily, no scarcity of land, and suitable land, for those who wish to enter upon this occupation fraught with health and blessing—the only caution needed is the ordinary caution demanded in any commercial undertaking—caution to see that the chosen patch is not appraised at a fictitious value, and to discern that a bleak moor, away from man and market, is not the best position to make a start. Even without encroaching upon the tillage land at all there is room for a remarkable development in the direction of stone fruits in hedgerows and other fruits in places now lying waste with weeds. There is one further remark needed in this division. Apart altogether from the question of landlord-help, or compensation, the trifling cost for trees and plants will very quickly be repaid by fruit crops, so that the farmer, or food reformer, may surely secure himself against anything approaching to loss under any circumstances. It is possible for a false economy to see overwhelming difficulties where, in reality, there are but disadvantages.

We are naturally led up to the next point—that of situation and shelter. Some people seem to plan and plant their fruit gardens with no more consideration for these points than if they were going to stick in posts for a clothes line for the laundry, or poles for a gymnasium. It is quite true that some of the hardier kinds of various fruits will thrive, with care and attention, upon almost any soil and in most situations, but it must be remembered that successful cultivation depends greatly upon the favourable character of these conditions. A good friable but substantial loam will be found most suitable for Apples, Plums, Cherries, and other stone fruits, while Pears will be better in a stronger soil. Bleak situations, and sites in exposed positions, should be as far as possible avoided. Shallow, poor soils, or wet, cold land will lead to unsatisfactory results. The ground should be drained carefully, as nothing is more injurious to fruit trees than a cold, undrained subsoil. If the site is sheltered naturally, so much the better. If not, it is well to assist success by providing artificial shelter by screens of quick and dense growing trees, that can readily be kept well within bounds as they grow older.

We now come to the items of trees and, in the case of the smaller fruits and berries, bushes and plants. Upon this, time will only permit us to say a passing word. It is of all importance that good trees of

good kinds be got—sorts that are at once prolific, bearing fruits of good quality, and of kinds having a brisk local demand. There are some kinds—of Apples, say—which are safe anywhere: Lord Suffield, Eclinvile, Cellini, Dumelow's Seedling, Stirling Castle (an almost always safe cropper in every season. This year, I daresay Stirling Castle is more generally full cropped than any other variety), and amongst finer coloured fruits, Worcester Pearmain, Cox's Orange Pippin (for flavour, unequalled by any Apple, British or foreign, to my thinking), Blenheim Orange (splendid for kitchen or dessert), Irish Peach, and a dozen others. These are always safe to find ready sale in their season; it is oftentimes a desire with the fruit grower to extend his list, and this is a matter in which there is a real danger, for multiplying kinds, for the mere sake of multiplication, is a most undesirable method of procedure.

As to the form in which the trees should be grown, and the way in which the garden, or the fruit farm, should be planted, that greatly depends upon the purpose in view, the surroundings, and upon other conditions and circumstances which will not be slow to suggest themselves. It is of course desirable to have variety in safe limit, and I think it is the wiser method to choose kinds, and to secure trees and plants that will prolong the fruit season as far as possible—that is to say, in the case of Strawberries, for instance, you must have a certain number—say the greatest number—to come in early in the season, but you should also have kinds that will carry you over late into the season also. In Apples, too, it is desirable to have an abundance of early kinds; I see, for instance, that the importation of Apples, for the present year, has already reached a total of bushels running far into five figures, but it is also desirable to have late keeping kinds. Quite late last summer we used the last of our Dumelow's Seedling of harvest 1889.

But we must leave this interesting section all too soon, and pass on.

There must next be due provision of intelligent labour, directed by skilful supervision. In newly formed gardens and orchards, planted up with young trees, judicious planning in the arrangement, and careful regard to right principles in the execution of the work as it progresses, and to the trees as they grow, are essential, otherwise a waste of land, time, and labour will readily result. Deep planting is a frequent cause of failure, and a tree tumbled into a hole, with the soil "rammed home," as the phrase goes, cannot possibly give a good account of itself.

As to kinds and proportions of kinds of fruit—that is to say, the area allotted respectively to Apples, Pears, stone fruits, berries, and other fruits, or fruit-like vegetables, that must be determined by market demands and conveniences, but in all mixed fruit farms it is best to give the preference to those fruits less liable to "pulp," otherwise there may possibly be too heavy demand upon anxious attention at periods when the uncertainty of the weather, or other causes, tend to increase cares and disturb the labour balance, and thus to prejudice other crops.

Under the head of cultivation, a host of details present themselves. We must only glance at some of them and go on. As a general rule, sadly too little attention is paid to the after care and management of fruit trees. I am often struck with the continuous care and attention bestowed upon the fruit quarters in a well-ordered nursery—the washing, trimming, and training, the frequent surface cleaning of the land, the watering and feeding—a continuous process, or series of processes, insuring cleanness of stem and leaf, and an immunity from insect depredation, or from the blight of disease; a safeguard against the scaly covering of the Lichen, and a preventive method against parasitic attack, either of the vegetable or the animal kingdom. It is very much the same in the garden as it is in the house. Neglect weakens the barrier which Nature sets up to prevent the attack of influences harmful, whilst cleanliness and "heartiness" (if the word may pass) seem to give power of passing through the midst of the scourge unharmed. The enemies of the fruit growers are numerous, and may be classed under headings, atmospheric, entomologic, and parasitic, under adverse influences of season, so that only watchfulness, helpfulness, and perpetual care can secure even the chance of a successful result; for this is the reward only of intelligent industry, on right lines, in right temper, with good material and proper method. Truly man in the garden is there to dress it and to keep it. Production is the law of the earth. It is impossible to keep weeds out of the garden; but it is only the sloven, or the sluggard, who will have a garden of weeds.

We must take a brief glance at the second division of the subject to complete the paper. In the matter of fruit distribution, there is serious need of well arranged and properly applied organisation.

Fruit growing as an industry is most heavily weighted, firstly, by lack of united effort and action on the part of producers themselves; and, secondly, by a certain apathy on the part of purchasers, and by many other things, chief amongst which may be classed "monopolists," whom for convenience we class under the all-embracing term of "middle men," and thus must also include carrying companies in general.

The second part of our subject may then be briefly considered as having a bearing upon—(A) Gathering, (B) sorting, (C) storing, (D) packing, and (E) marketing.

If any responsible market salesman were asked to say in a word what is essential to command a market, he would, I am sure, say emphatically and without hesitation, "quality." After fruit is produced, the initial process to insure quality is necessarily careful gathering; nothing is more easily damaged and blemished than fruit, and a bruised Plum,

or a crushed berry, can never be coaxed, or conjured, into perfection afterwards.

After the gathering comes the sorting, or rather ought to come the sorting. The difference in value between sorted and unsorted fruit would scarcely be believed. This is to be noticed as a distinguishing feature of American and other imported fruits. My remarks under these headings are necessarily brief, but they are none the less emphatic.

In cases where the fruit is stored, extreme care must be taken in the handling, and choice kinds should be wrapped in soft tissue paper. When once placed into position, they should not afterwards be moved about or handled. An even temperature should be secured in the fruit room, and kinds should, of course, be kept separate and distinct as gathered, and deposited. Farmyard straw, or musty hay, must be carefully avoided. Nothing is more unpleasant than a straw-flavoured Apple, or Pears that have been robbed of their richness by the mouldy atmosphere to which they have been subjected. I have often wondered whether in this age of invention some chemist may not some day invent some saturated preparation of flavoured material, in which the fruits shall be placed and stored, and, when the aroma has been absorbed, we

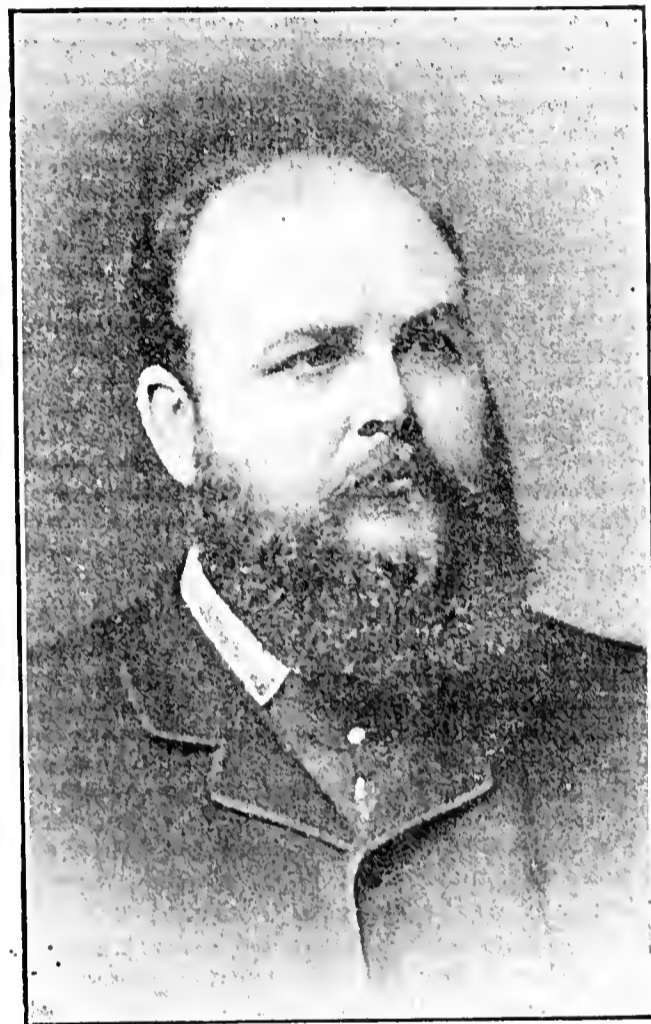

FIG. 2.—MR. EDMUND J. BAILLIE, F.L.S.

should have the natural fruit, plus the added quality (a doubtful advantage truly) of, say chocolate or vanilla, or some other delusive delight of the laboratory and a false appetite; but for those of us who prefer Nature's flavouring, as imparted by the air, the atmosphere, and the sun, all we need is that no foreign peculiarity shall be imported. Let those who want essences and condiments get them in the phial of the druggist, or the canister of the dealer in such products, we are content with the luscious juice, distilled and stored in the casket prepared for it by a beneficent Providence in the due advance of the laws of Nature and in the changing seasons of the varying year.

In packing, we are coming nearer to the processes more distinctly commercial. I have before referred to the perfection of many of our imported fruits, as illustrative of careful sorting. The illustration may serve also for right packing. I have seen a basket of Apples sent across one county more knocked and damaged than a barrel of choice fruits which had come hundreds of miles across country, and over the ocean afterwards. With such fruits as Raspberries and Strawberries, especially, the art of packing must be duly recognised, or you may soon spell disaster. I am not comfortable in having to pass matters of so much importance under such hasty review, but space is inexorable.

Lastly, under the head of Marketing, I should include all methods of distribution. When shall we buy and sell fruits by sample? This will be a marked advance. Why should a fruit grower take his produce, and stand by until an uncertain public clears him out? Miles from home, it often becomes a forced sale, and is, at best, a shocking waste of valuable time, according to our present system. The vendor or his

representative should attend market, and sample his wares just as the corn merchant does his. Then the market staff should be so arranged that if I one week buy, say, Baxter's Pearmain, or Bramley's Seedling, and want these kinds again, I should be able readily to get them. Some kind of central agency is needed to accomplish all this. Then our philanthropic agencies, our well directed societies and missionaries, ought to encourage the extended use of fruits as food. Our railway stations and places of meeting should have supplies of fresh British fruits in season, and even the automatic craze ought to be supplemented by a machine, which gives to the person following the directions as to slot and index, Plum, Pear, or Apple, as his taste may dictate. In fact, no opportunity should be lost for spreading the principles, of which the end and aim is wisdom and peace.—EDMUND J. BAILLIE (in *The Vegetarian*).

[To the courtesy of the Editor of the Journal named we are indebted for the excellent portrait of Mr. Baillie, one of the finest specimens of vegetarians in the kingdom; and his mental powers are equal to his physical development, while his knowledge of fruit, gained in the great Chester firm of Dicksons, entitles him to be listened to on the subject on which he writes and speaks so well.]



EVENTS OF THE WEEK.—Horticultural engagements are not numerous at this time of year, but several important meetings will be held later in January. In the present week we have only the following to announce—Meeting of the Quekett Microscopical Club on Friday, January 2nd, at 8 P.M., and the National Chrysanthemum Society's midwinter Show, Westminster, Wednesday and Thursday, January 7th and 8th.

— THE WEATHER still continues extremely cold and winterly. The snow has now remained upon the ground for a longer time than it has done for some years, and the temperature has been low, but not excessively so, in the London district. North and north-easterly winds prevail, and it seems likely that more snow is yet to come. Mr. N. H. Pownall, Lenton Hall Gardens, Nottingham, writes: "Our second coldest night this storm was on Sunday evening and Monday morning, December 21st and 22nd, when we registered 29° of frost." A London paper of Dec. 29th says:—"People who want to get away from the cold will not travel southwards. They will take a railway ticket to Wick, if they can hope to survive the journey. For in that far northern town we read to-day there has been no snow, 'Roses and all sorts of flowers' are in bloom in the gardens, and full-grown Strawberries may be plucked in the open air."

— SEVERE WEATHER IN THE WEST OF ENGLAND.—On November 29th the thermometer at 3 feet from the ground registered 23° of frost; on December 12th and 13th, 20°; on 15th, 22°. There was very little snow until the 19th, when there was 4 inches, which was increased to 16 inches on the 21st. Not a pleasant prospect for Sunday morning, with paths to be cleared and trees to be shaken, as many of the branches were bent to the ground with more snow on them than I have seen for the last twenty years. Strange to say, I have not seen a broken branch; the snow was so light. Several old Cedars are carrying a great quantity, which is difficult to reach. The first frost damaged some winter Broccoli that was planted early and laid, while late planted quarters of the same varieties seem all right. Late growths of Laurels are browned, but not much hurt.—J. M., *Camerton, Bath*.

— FOGS IN LONDON.—At a meeting of the Royal Botanic Society, Regent's Park, last week, the Secretary answered various questions as to the destructive action of fogs on plants. He said it was most felt by those tropical plants in the Society's houses of which the natural habitat was one exposed to sunshine. Plants growing in forests or under tree shade did not so directly feel the want of light; but then, again, a London or town fog not only shaded the plants, but contained smoke, sulphur, and other deleterious agents, which were perhaps as deadly to vegetable vitality as absence of light. Soft, tender-leaved plants and aquatics, such as the *Victoria regia*, suffered more from fog than any plants he knew.

— THE CUTLER TESTIMONIAL.—The occasion of the re-election of Mr. Cutler for the fiftieth time as Secretary of the Gardeners' Royal Benevolent Institution affords a fitting and appropriate opportunity to the gardeners of the United Kingdom to give expression to their gratitude to him for the splendid services he has rendered to the poor and unfortunate of our craft for the long period of fifty years. The prejudice which at one time existed among some gardeners against subscribing to this excellent charity has now almost passed away. Let me, then, make an earnest appeal to my brother gardeners to show their appreciation of our old and faithful servant's successful services by contributing as their means will allow to the testimonial now being raised to him by his friends, and which is to be presented to him on the occasion of his re-election early this month.—OWEN THOMAS, *The Gardens, Chatsworth*.

— TURNER MEMORIAL PRIZES FOR 1891.—A meeting of the Trustees of the above was held on December 9th, at which the sum of £30 was voted for prizes next year, to be distributed as under. It having been decided to hold an Exhibition of Carnations and Picotees in July next in the Gardens of the Botanic Society, Birmingham, under similar conditions as the Northern and Southern Sections of the National Society, to take in the Midland growers, the Trustees have voted £10 to the prize list. They also give £10 for the purchase of a silver cup, as a special extra prize for the collection of fruit at the Edinburgh International Exhibition on September 9th, 10th, and 11th, which in the opinion of the Judges may be deemed most worthy of the award. The sum of £10 has also been voted to the Royal Horticultural Society as part of the amount for two sets of prizes for naturally grown plants of Chrysanthemums at the meeting on November 10th. There was a good competition for the prizes offered last season, for which £27 10s. was paid as follows:—£10 for Roses at Tibshelf, £10 for Dahlias at Edinburgh, and £7 10s. for seedling Tulips at Manchester.

— MESSRS. J. WEEKS & CO., CHELSEA, send us good wishes in their Horticultural Pocket-book. This, like their wishes and their work, is genuine, being strong, neat, and serviceable—just what gardeners will like to place in their pockets at the beginning of the year, and it will wear to the end and be useful.

— TURNIPS.—I mentioned a few weeks ago a Radish-shaped Turnip I had received from MM. Vilmorin, the name of which I had forgotten, but which I did not think was the Vertus mentioned by your correspondent "B." I have since found that it is called the "Half Long White Forcing," and is recommended for frames. As I mentioned, it is extremely early and good, and slow to run to seed.—H. S. EASTY.

— THE FORESTS OF EUROPE.—The forests of Europe according to a recent report of one of the State foresters of Prussia, cover the following areas:—Germany, 34,596,000 acres; Russia, 494,228,600 acres; Austria-Hungary, 46,951,700 acres; Sweden, 42,000,000 acres; France, 22,240,000 acres; Spain, 19,769,000 acres; Italy, 9,884,570 acres; and England, 2,471,000 acres.

— THE "BLOCKHEAD" LETTUCE.—In giving the name of "Blond Blockhead" to the Lettuce alluded to in recent numbers of the Journal, Messrs. Vilmorin & Co. wish to state that "the variety so named is a better keeper than any other of their Lettuces and that it is rather stubborn (obstinate) in running to seed; or, in other words, that the head is very hard, and, alluding to a block, they have made 'Blockhead,' which, taken in the strict sense of the word, is not a very fortunate term." [It has the merit of being "distinct" as applied to a vegetable, and a Lettuce so stupid as not to bolt with other runaways will not suffer by the appellation.]

— BIRDS AND THE HARD WEATHER.—An appeal has been made in favour of the birds, decorators being particularly asked to desist from cutting much berry-bearing Holly. That the birds are badly in want of food is very evident; but unfortunately for themselves they have been most improvident in the matter, the blackbirds being the greatest offenders. Long before frosts set in these voracious creatures had cleared numerous Thorns and nearly all the Hollies of berries, and they and various other fruit-eating birds are likely to fare badly in consequence. One large Holly 35 feet high, in a conspicuous position where I am now writing, escaped being stripped till December 16th, at which date it was almost a mass of scarlet, but on that day the birds made a deadset at it, and before forty-eight hours had elapsed it was completely stripped of berries. Included in the flock of birds were many

fieldfares, thrushes of all kinds, blackbirds, and a specimen of the rare ring ousel, which will not be shot.—W. I.

— THE JOURNAL OF THE ROYAL HORTICULTURAL SOCIETY.—We have received for review a copy of part iii., vol. xii. of the above Journal, and have much pleasure in expressing our appreciation of its general excellence. It is devoted mainly to the consideration of Pæonies, Carnations, Ferns, and Gladioli from various aspects, scientific and practical; and also contains articles on spring flowering trees and shrubs, hardy flowers, and fruit drying, with a record of shows and meetings. As a rule the matter differs somewhat from that which is so plentifully distributed through the gardening journals, as we think it ought; for, useful and interesting as this may be, the public undoubtedly expect that the official Journal of the foremost Horticultural Society in the kingdom should possess distinct features. Though the issue is not devoid of what may be reasonably termed commonplace matter, this certainly does not predominate, and the majority of the contributors have acquitted themselves well. We are also pleased to note that the work has been carefully edited, and only the hypercritical can find fault with it in that respect. It is a decided improvement on some previous issues, and both Mr. Morris and Mr. Wilks are to be congratulated on its production. We may possibly, if space permits, refer to the part again, and can only in the meantime say that it contains upwards of 130 pages of letterpress, and that its price to non-Fellows of the Society is 5s.; to Fellows it is free. Sequel, join the old Society, and make it young again, for the stronger it is the better for the ancient craft of which it is the chief exponent in this country.

— THE JARDIN DES PLANTES has, says a gentleman recently returned from Paris, greatly improved during the last few years under the direction of Professor Maxime Cornu. It is well worth a visit. The most interesting thing that he saw in the French capital was a magnificent Pampas Grass, of which specimens have been introduced by M. Edouard André from the outlying districts of Uruguay. It is in the way of *Gynerium jubatum*, but with stems 10 feet high, the inflorescence drooping gracefully down, fountain like, on each side. It has not at present been decided whether the new Pampas is a *Gynerium* or an *Arundo*.—P.

— THE AMERICAN MOTHER APPLE.—On page 536 mention is made of this fine dessert Apple, and advising a south wall for it if room can be spared. In the midlands and north no doubt a wall would be necessary to get the fruit good, but in the west and south of England it will do very well in the open as a dwarf tree. We have here a number of trees in a very exposed position, and which produce very fine highly coloured fruit. So far as I know it is the sweetest Apple grown, and a very pleasing smell, and will always carry weight in a collection of dessert Apples on the exhibition table. Our soil and climate suit this variety; this, in connection with liberal manuring, will no doubt account for its answering so well here, but many varieties of Apples are considered failures which would be considered quite the reverse if they had sufficient manure to supply them with the food requisite for their well being.—S. T. WRIGHT.

— THE ANCIENT SOCIETY OF YORK FLORISTS, the oldest in the kingdom, having had an unbroken existence of over 100 years, held their annual festive gathering recently, at which Lord Mayor Mathews intended presiding, but an important meeting elsewhere kept him engaged until a late period of the evening, when his appearance was heartily welcomed. Meantime Mr. Councillor Milward, the Sheriff of York, occupied the chair. Both gentlemen are active members of the great York Floral Galas, and are as much esteemed by horticulturists attending the annual galas as they are by their fellow citizens. The Society is well off now, having about £160 in hand, and numbers some 400 members. Mr. John Lazenby is the active and courteous Secretary, and is backed up by a good strong Committee. Under all these circumstances the Committee and friends could but feast right merrily—truly “the feast of reason and the flow of soul.”

— THE preparation of the KOMBE POISON is one of the important industries of Central Africa. The poison is contained in the seeds of *STROPHANTHUS KOMBE*, a strong, climbing plant which is always found in the vicinity of high trees, on which it supports itself. The native method of preparing the poison is very simple. The seeds are first cleaned of their hairy appendages, and then pounded in a mortar until they are reduced to a pulp; a little water is then added, and a gummy substance obtained from the bark of a tree which helps to

keep the poison on the arrow. Game wounded by arrows thus poisoned die quickly. The flesh is said to be eaten without any injurious effects. The seeds form an article of export.—S.

— PRESENTATION TO MR. DAVID LINDSAY.—On Christmas Eve a presentation was made at Otterspool to Mr. David Lindsay, gardener to Sir J. Edwards-Moss, Bart. It consisted of an elegant arm chair, which had been subscribed for by the men under Mr. Lindsay and a few neighbours and friends as a token of their esteem. Mr. White, Chairman of the Liverpool Horticultural Association, in presenting the chair dwelt on the length of time Mr. Lindsay had been in the neighbourhood, both at Roby Hall and at Otterspool, and of the many friends he had made, and hoped Mr. Lindsay would be long spared to enjoy the use of it. Mr. Blomily, Mr. Jellicoe, and Mr. Dutton added their testimony to that of the previous speaker, and Mr. Lindsay in a few suitable remarks thanked them for the presentation. A vote of thanks to Mr. White brought a very pleasant evening to a close.

— THE WEATHER during December has been unusually severe. On the 14th the mercury of the thermometer fell to 10°, or 22° of frost, and on the 22nd to 7°, or 27° of frost; but fortunately the ground was covered with snow to the depth of about 6 inches, which would be a great protection to vegetation. Snow fell again on the 27th, bringing up the total depth to about 10 inches. This will be very beneficial to the land, as the springs were very low, and water in some parts of the country very scarce. The rainfall for the year is under the average. Up to this date (23th) only 17·86 inches has fallen. July was the wettest and September the driest month of the year. Gardening operations are practically at a standstill.—G. R. ALLIS, *Old Warden Park, Biggleswade*.

— THE WEATHER IN IRELAND.—The severe frost we are this winter experiencing is most unusual for the south of Ireland. During the past four winters we have not experienced more than 12° of frost, and that but once. On December 17th we registered 18° of frost, while from 2° to 16° have been registered every night since the 2nd of last month. The days generally have been bright, consequently the temperature by day has ranged from 32° to 46° at midday. The thermometer is behind a wall facing north, and is 5 feet from the ground. Christmas Roses are very late this year; there is not one flower open yet; there are thousands of buds which will make a grand display later on. Up to this date (December 29th) we have had no snow, but the clouds look threatening.—HANDY ANDY.

— GARDENING APPOINTMENT.—Mr. S. Summers, who has acted as foreman at the R.H.S. Gardens, Chiswick, for some years, was on Tuesday last in the Council room there presented with a handsome writing case accompanied by an address on his removal shortly to another sphere of labour. The presentation was made by Mr. J. Barry on behalf of the men, who showed their appreciation of the recipient's services in this agreeable manner.

— THE SHIRLEY POPPIES.—These are very useful and beautiful when grown in pots or in the herbaceous borders, and last a long time when cut for filling vases, especially so when they are associated with any of the common variegated Ribbon Grasses, or *Eulalia japonica*, making a very chaste and beautiful effect. We are sowing these Poppies now in pots for decorations, and in pans for cut flowers to be brought on in cold frames, and sow early in March outdoors for the summer, and again in June for a late supply. A very pleasing effect was produced here late this autumn by using the common red field Poppy freely interspersed with Oats, showing what fine effects may be produced with these wild flowers.

— TELEKIA SPECIOSISSIMA.—This rare fine old herbaceous perennial, growing from 6 to 8 feet high, bearing large spreading heads of beautiful bright Marguerite-like flowers, is well worthy of being more extensively cultivated. It is a very stately growing plant, suitable for the rockery, garden, banks, or back lines in the herbaceous border, where it has a telling effect. It is also very useful when cut for filling large trumpet vases, lasting well in water, and makes a pleasing effect when mixed with the great Ox-eyed Daisy (*Chrysanthemum uliginosum*). It is propagated by divisions, and thrives luxuriantly in a moist situation.

— MARKET LETTUCES.—In reply to “J. B., Nottingham,” (see page 490), I can recommend him Horniman's Cabbage Lettuce, which is, I believe, exclusively confined to Devonshire, where it originated, and it

supersedes all other old-established varieties of Cabbage Lettuces grown for market, either for spring, summer, or autumn use, and in hot dry weather lasting longer than any variety I ever grew before bolting. It is a crumpled-leaved variety in the way of the Old Neapolitan, not so large as that variety, but larger than a full-developed specimen of All the Year Round, of a light yellowish green in colour, without the slightest trace of bitterness, and is extremely crisp and refreshing. It is grown extensively by the leading market growers, and commands as much as 4d. to 6d. per dozen more than such varieties as the Grand Admiral, All the Year Round, &c. The Horniman, being so highly appreciated by all classes of society, is taken in preference. These are facts which have frequently come before my notice during the past three years. I have grown it extensively myself for private use, but I have never seen any variety of Lettuce sell so freely and profitably as this one. The land is well dressed with good manure before planting, and the plants are grown 1 foot apart each way. I have not sufficiently proved the Horniman for winter use, but hope to do so in the future, at present relying upon the old standards, as Grand Admiral, All the Year Round, Hicks' Hardy, and Bath Cos.—J. T. EBBUTT, *Winslade Gardens*.

— CLERODENDON FALLAX SEEDLINGS.—This fine old stove plant is now seldom met with in good character, and many can look back to the old Chiswick and Regent's Park days when fair specimen plants were seen at the exhibitions. Mr. Pritchard, gardener to G. A. Muntz, Esq., Umberslade Hall, near Birmingham, each year raises a batch of young plants from seeds he himself saves, sowing it in February or early in March, and warmth, and growing them on in a warm house, and a good supply of strong young plants with large heads of bright orange-scarlet flowers are always to be met with there from July onwards. It is a most valuable decorative plant, and Mr. Pritchard finds it most useful. Umberslade is a fine old place, the gardening there of a good all-round order, and amongst other things the old *Tritonia aurea* is cultivated in pots, some four to six bulbs in a large 48 or 36 pot, and grown on for conservatory decoration in the latter part of the summer, and this plant and the *Clerodendron* also would be found valuable acquisitions to those who exhibit groups at the August and September exhibitions.—W. D.

— SOUTHPORT AND BIRKDALE GARDENERS' FRIENDLY SOCIETY.—The annual meeting of the Southport and Birkdale Gardeners' Friendly Society was held recently at the Cocoa Rooms in King Street. Mr. T. Smith presided, and there was a very large attendance of members. The minutes of the last meeting were read and confirmed. The Secretary read the annual report, which set forth that the Society was still progressing both financially and numerically. This Society was formed about three years ago, and during this year twenty new members had been elected, bringing up the membership to fifty-four. The officers and Committee had worked harmoniously together, which accounted in a very great measure for the success that had attended the operations of the Society. The Treasurer's statement showed that after meeting all expenses and paying a dividend of 27s. 6d. to each of the members (being 1s. 6d. more than the total amount of the contributions) there remained a balance in the bank of £24 9s. 3d. Mr. Wintle moved the adoption of the report and the financial statement, Mr. Gilchrist seconding. The Chairman in supporting the motion, said, Unity was strength, and the success achieved by the Society proved the truth of that saying. He hoped its prosperity would continue, and that in a short time they would not be able to find a single gardener in Southport or Birkdale who was not a member of that Society. The motion was carried unanimously. The election of members for the ensuing year followed. T. Smith, Esq., was re-elected as President; Mr. T. Tomkins as Secretary; and Mr. A. Francis was re-appointed Treasurer; Messrs. H. R. Goddard and W. Spencer were elected Cash Stewards; and Messrs. W. Morley and W. Wintle Auditors; the following being elected as the Committee—Messrs. W. Breeze, H. Turner, J. Campbell, J. Royle, H. Blackhurst, and J. Garlick. Several new members having been enrolled, a vote of thanks was accorded to the Chairman for his services, and the proceedings terminated.—W. S.

— THE RICHMOND (SURREY) HORTICULTURAL SOCIETY.—The annual meeting of this Society was held recently at the Greyhound Hotel. Sir J. Whittaker Ellis presided. The Committee in its sixteenth annual report states that it has the satisfaction of being able to refer to the very favourable results of its labours during the past year, and to the present position of the Society. The summer Exhibition has this year been well maintained, both in the quantity and quality of the

exhibits. The number of entries for Roses exceeded all previous years, and it was acknowledged by competent judges to be the best Show yet held by the Society. The Committee note with pleasure the continued interest which the ladies of Richmond and district take in the Society, as demonstrated by the exceptionally large number of entries made for table decorations and bouquets. The Committee congratulate themselves on the fact that the list of this year's subscribers shows an increase of forty-three names. The Committee tenders its best thanks to the subscribers and donors of special prizes for the support given to the Society during the year, and would urge upon all the necessity for a continuance of pecuniary support in order that the Society may be maintained in the highly satisfactory position it now occupies among the horticultural institutions of the country. The Committee also begs to offer an expression of its thanks to the Honorary Auditor (Arthur Cooper, Esq.), and to the Honorary Secretary (J. H. Ford, Esq.), for their gratuitous and valuable services. Votes of thanks were accorded to the Committee, to the Chairman (Mr. Skewes-Cox), the Vice-Chairman (Mr. Nicholson), and the Hon. Sec. Mr. Ford, in acknowledging the compliment, said that the Society had done very well during the past year. Though they had had two Shows, they had not had to ask a single subscriber for a second subscription. The retiring members of the Committee were re-elected. A letter was read from the Baroness von Hagen, stating that she would be very glad to become a patroness of the Society. Mr. G. Cave moved a vote of thanks to the Chairman, and remarked that some money was coming to the Surrey County Council for technical education. Richmond was entitled to a share of this, and if that Society thought it could do anything in the way of giving technical education in the matter of gardening now was the time to speak, and he thought the County Council would consider any application that might be made to it. The vote of thanks was heartily passed, and suitably acknowledged by Sir Whittaker Ellis.—(*Surrey Comet*.)

— THE ILLUSTRATED LONDON ALMANACK.—We have received a copy of the above almanack from the office of the *Illustrated London News*, 193, Strand, London. It is large, useful, and beautifully illustrated, the six coloured plates of flowers alone being worth more than the cost of the work. They are well worthy of being framed for the homes of gardeners, and the size, 9 by 6 inches, would only involve a trifling cost. The almanack also contains woodcuts of high artistic merit, and at the commencement of each month the "Feathered Friends and Foes of Farmer and Gardener" are represented in miniature. It is an excellent production throughout.

— EXCESSIVE FROST IN NOVEMBER.—In Mr. G. J. Symons's "Meteorological Magazine" for last month a full report is given of the low temperatures registered in November at different places, accompanied by the following general introductory remarks:—"This November frost was an extremely remarkable one; (1) because it occurred in the daytime; (2) because it was so local. As will be seen further on, the temperature fell much lower at other places than it did at Greenwich, or at Camden Square, but as long records are available at those places, it will be well first to examine what occurred at them. Greenwich.—November 23rd was quite exceptionally warm; the average was 54.9°, which was higher than on any day in the third decade of November during the sixty years, 1814 to 1873. Then a rapid fall of temperature set in, and on the 23th the maximum was 26.9°, the minimum was 18.3°, and the mean 21.8°, which is nearly 2° colder than any other day in November during the above-named long period of sixty years. Camden Square.—Out of the thirty-two Novembers ending with that of 1889 there has been one—1838—in which there was no frost; there have been fourteen in which the temperature fell below 27°, and four in which it fell below 23°, these cases being as follows:—Air temperatures in November below 23°.—1858, 20.1° on the 24th; 1861, 21.8° on the 19th; 1871, 21.0° on the 19th; 1887, 22.1° on the 17th. In 1890 it fell below all these, excepting 1858—viz., to 20.8° on the 29th. It is necessary to explain why the minimum at Greenwich is stated to be on the 23th and at Camden Square on the 29th. The minimum—as will be further explained subsequently—occurred nearly at the same time (4 to 5 P.M.) on the 23th at both places, but at Greenwich for many years it has been the custom to record the temperatures as they would have been if read off at midnight. We believe that no readings are now really taken at that hour, but the theory has survived the practice. This minimum was therefore on the Greenwich system correctly set down to the 23th. The rule, however, for climatological stations is that the maximum read on any morning is to be entered to the day before, but the minimum to the day on which it is read, because in an overwhelming

majority of cases the minimum occurs in the early morning hours, and therefore belongs to the day on which (at 9 A.M.) it is read. Hence, in accordance with rule, the entry at Camden Square is for November 29th." Returns are published from twenty counties.

— ROYAL METEOROLOGICAL SOCIETY.—At the last monthly meeting of this Society, Mr. H. F. Blanford, F.R.S., Vice-President, in the chair, Dr. T. Fowler, Mr. A. Greg, and Mr. H. Woolcock, C.E., were elected Fellows of the Society. The following papers were read:—1, "Note on a Lightning Stroke, Presenting some Features of Interest," by Mr. R. H. Scott, F.R.S. On January 5th a house near Ballyglass, Co. Mayo, was struck by lightning, and some amount of damage done. A peculiar occurrence happened to a basket of eggs lying on the floor of one of the rooms. The shells were shattered, so that they fell off when the eggs were put in boiling water, but the inner membrane was not broken.

HAM HOUSE.

PASSING up the River Thames from London to Hampton Court it is curious how few gardens or mansions of note are seen on the left or Surrey side, though on the Middlesex bank they are very numerous for a good portion of the distance. Kew, of course, is one of the great exceptions, but after that there is nothing remarkable until Buccleuch House, just beyond Richmond Bridge, is reached, and there the beautiful grounds now constitute a public resort in the "Terrace Gardens," transferred to the town in recent years. Shortly after leaving that point Ham House is approached, and there is little else on that side until far beyond Kingston. Possibly this may be due in some degree to the prevailing flat character of the Surrey shore for a considerable distance above Richmond, but this reason is not very weighty either, as the other side is not much more elevated or varied, but the neighbourhood of a succession of small towns may also have had some influence, and a more direct communication with London by road. However the fact remains, whatever the cause may be, that Ham House, the subject of

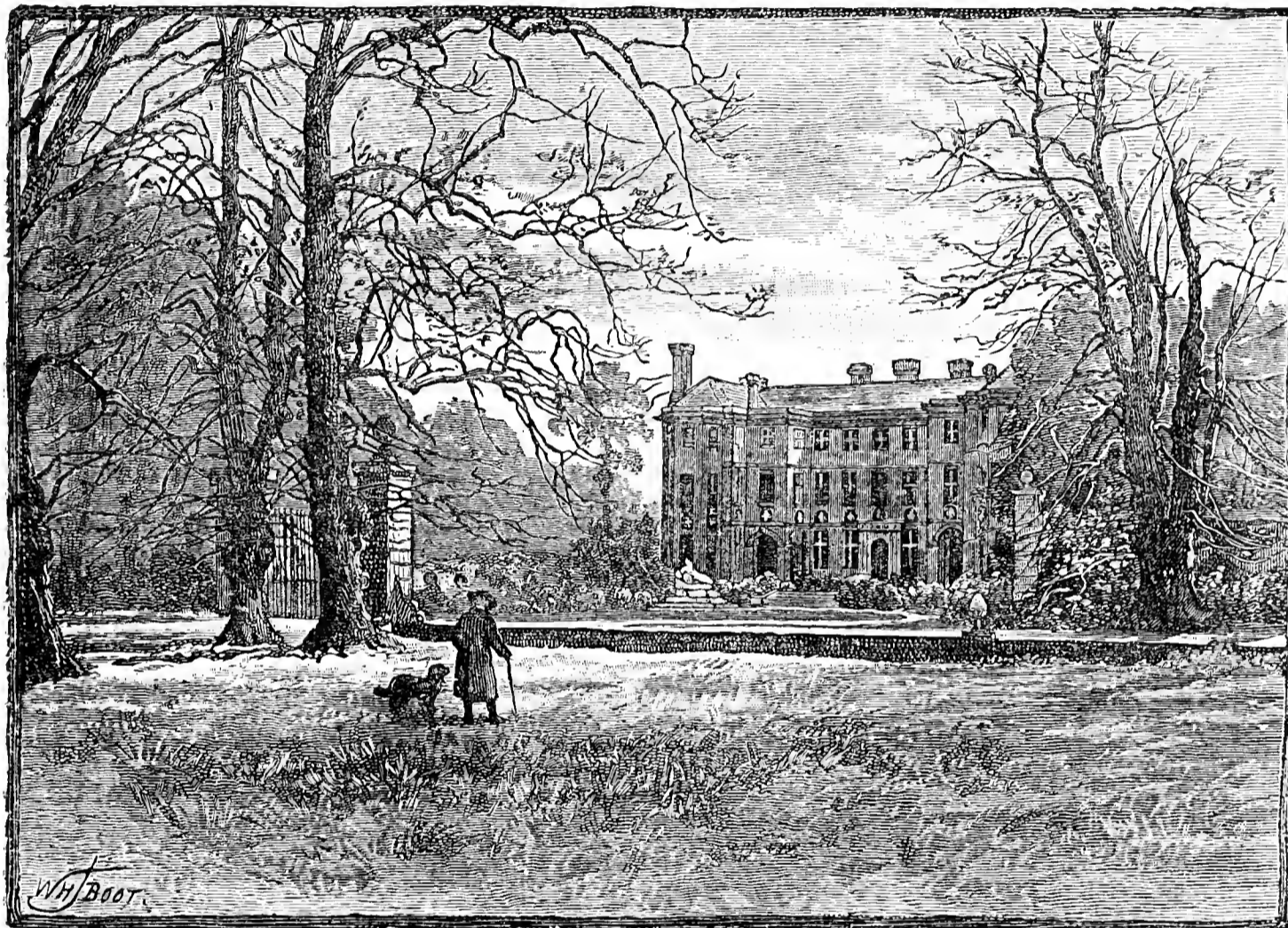

FIG. 3.—HAM HOUSE.

The eggs tasted quite sound. The owner's account is that he boiled a few eggs from the top of the basket, the rest were "made into a mummy," "the lower ones all flattened, but not broken." 2, "Note on the Effect of Lightning on a Dwelling House," by Mr. A. Brewin, F.R.Met.Soc. This is an account of the damage done to the author's house at Twickenham on September 23rd. 3, "Wind Systems and Trade Routes between the Cape of Good Hope and Australia," by Capt. M. W. C. Hepworth, F.R.Met.Soc. The author is of opinion that the best parallel on which commanders of vessels navigating the South Indian Ocean between the Cape of Good Hope and the Australian Colonies should run down the longitude is between the 41st and 42nd parallels during the winter months, and between the 45th and 46th parallels during the summer months. 4, "Report on the Phenological Observations for 1890," by Mr. E. Mawley, F.R.Met.Soc. Taking the year ending August, the weather of the autumn, winter, and spring, and of the first summer month could scarcely have been more favourable for vegetation, while that of July and August proved altogether as unpropitious. 5, "The Climate of Hong Kong," by Dr. W. Doberck, F.R.Met.Soc. This is a discussion of the meteorological results at the Hong Kong Observatory, and at the Victoria Peak during the five years, 1884-88.

this notice, is almost the only private establishment of consequence near the river on that side for a distance of twenty or thirty miles.

The attractions of the river Thames between Richmond and Kingston are very great in the summer months, and familiar to thousands of holiday makers who journey up and down in the steamers running daily from London Bridge to Hampton Court. But there is one point near the celebrated Eel Pie Island where a most delightful view is obtained of the wooded heights of Richmond Hill and Park, which cannot fail to awaken the enthusiasm of the most prosaic or unromantic traveller. Seen on a fine summer's evening when coming down the river it can scarcely be rivalled, and it is not surprising that poets have there found an ample theme. Then, too, the historical associations of the district are full of the deepest interest, and not the least of these are furnished by Ham House, concerning which something has now to be said, but it would require a lengthy discourse to do it justice in all its aspects.

First, as regards situation. There are few residences of similar importance an equal distance from London that are as isolated as this, and so removed from the noise and bustle of modern life. Richmond station is about three miles away, Kingston is almost as far, and the nearest station is at Twickenham, on the opposite side of the river; but the ferry affords a direct if a slow means of communication between the two shores. The quiet little village of Ham itself is fully a mile away, and so there is practically nothing to disturb the solitude and serenity of the house, its garden, and surroundings. All this is appropriate in

the highest degree, for it is difficult to imagine the incongruity that would result from surrounding such stately solemnity with the rush of nineteenth century business or bank holiday pleasure resorts. There seems, also, every probability that it will long remain in a similar condition, for though alterations and improvements on an extensive scale have been undertaken in the place itself, the estate comprises so large an extent of the surrounding country that encroachments of an objectionable character can be successfully resisted.

Reference has already been made to the antiquity of the building, and that it has some claim to a place in history is amply supported by the fact that it was erected in 1610, so that its record covers a period of over two and a half centuries, an important epoch in British history. It is said to have been built for Sir Thomas Vavasour, and some years afterwards passed into the possession of the Tollemache family, and through them has descended, with the title, to the present young Earl of Dysart, who is the ninth in succession. To trace the history of the house and its occupants during the long period named would be a serious task, and an unnecessary one in these pages. All can imagine what a varied record it would furnish, and how many celebrities in successive reigns have entered its portals. But turning to modern times, Ham House and gardens were for a long period neglected, or half-forgotten, and it was therefore a memorable day in local history when, on May 21st of the past year, the Earl of Dysart returned from his travels abroad to take possession of his ancestral home. "On that day," says a Surrey paper, "all Ham, and its neighbour Petersham, rose to the occasion, and the humblest inhabitant vied with the parish dignity in according the Earl a right loyal reception. A triumphal arch was erected, an address presented and the huge iron gates at the end of the avenue were thrown back for the first time within living memory. A tea was provided, and at a "house warming" in the evening, the Earl of Dysart and Lady Huntingtower entertained a distinguished company of guests." This may be said to have been the commencement of a new order of things at Ham, and its effects were not less manifest in the garden than in the house.

The garden is or was in all respects fully as antiquated as the house; but though at one time it was celebrated for its beauty, in late years it had become little better than a wilderness. Neglect tells much sooner in a garden than in a house, and a visitor but a short time since could scarcely have realised the truth of Evelyn's description in his diary of August 27th, 1678. He there says, "After dinner I walked to Ham to see the house and garden of the Duke of Lauderdale, which is indeed inferior to few of the best villas in Italy itself; the house furnished like a great prince's. The parterres, flower gardens, orangeries, groves, avenues, courts, statues, perspectives, fountains, aviaries, and all this at the banks of the sweetest river in the world must needs be admirable." We still find the old trees and avenues, grand old Elms, Evergreen Oaks and Firs, Rose gardens, and gardens of old-fashioned flowers judiciously preserved, as it were, from the ruins of its former magnificence. But there has been a great reorganisation in other departments; the walls have been repaired and planted with fruit trees, extensive ranges of glass houses have been erected, and every effort is being made not only to improve the usefulness of the garden generally, but also to render it worthy of a place amongst the best kept establishments of the time. Something like twenty acres are included within the walls, the extent of the latter being remarkable, for there are several garden divisions of two or three acres each with boundary walls in several cases 130 to 200 feet long. As a careful selection of fruit trees has been made for covering these, it may be imagined, that ere long a plentiful supply will be secured. In the open quarters, too, young fruit trees have also been planted, while a fine Rose garden is in course of formation.

The glass houses comprise a well-built lean-to range of vineries, 156 feet long in three divisions, planted last spring mainly with Black Hamburgh and Muscat of Alexandria. Then there is a splendid range of Peach and Plum houses, 212 feet long in four divisions, the trees mostly planted at the back and trained to the wall, the front part being utilised for Strawberries, Figs in pots, and other fruits. In the very compact frame ground are forcing pits for Cucumbers, Melons, Kidney Beans, &c., together with a good supply of useful young plants for table decoration and similar purposes. Here, too, are fruit rooms, Mushroom houses, and miscellaneous offices, well designed, and substantially built, while elsewhere are two large plant houses. It will thus be seen that the producing power of the garden is of no mean order, and it is being steadily increased.

An old orangery still remains, but it is now a laundry where the work is chiefly performed by electrical power, which has been successfully utilised for lighting purposes throughout the establishment. Poultry keeping and home farming also come within the range of work at Ham, and structures of a remarkable character have been erected. In the present year during a journey in France I visited the garden of a wealthy gentleman, and there saw the most luxurious and ornamental "cow house" it had ever been my lot to inspect. Tiled walls and floors, carved and polished woodwork, and fittings of a most elaborate character were the distinguishing features, add to which that the "house" immediately adjoined the residence of the owner. The "cow shed" at Ham House is equally as well appointed, but the differences are that it is not in proximity to the mansion, and it is illuminated with the electric light, which can be regulated with the same nicety as in the best appointed hotel in London.

After this brief digression, which may possibly possess a little interest for home farm readers, we must return to the garden. The engraving (fig. 3) represents a view of the river part of Ham House as seen

from the meadow, a short distance from the ha-ha. On the east side is the "old-fashioned garden" of herbaceous plants in substantial and effective clumps. The south side looks on to a spacious and well-kept lawn, and commands vistas up the different avenues, the chief being that leading to Ham Common, which is nearly a mile long. The Elms comprising it are not large, but there is a fine background of Scots Firs that impart much distinctive character to the scene. The oldest Elms, or the remains of them, are in one of the courtyards on the west side, nothing but a shell of bark and wood being left in some instances of what must have been grand specimens in their prime, a century or so back. The Evergreen Oaks in one of the garden divisions are also remarkable, forming a short avenue of tall, well-furnished trees, while huge old Bays, Portugal Laurels, and other shrubs abound in all directions.

It is very pleasant to see an old garden being restored to usefulness, and, in conclusion, it must be said that it is in excellent hands, for Mr. G. H. Sage is a gardener of the best modern school, thoroughly practical, with a comprehensive knowledge of his work in all departments, and fully capable of maintaining the credit of such an extensive and historical garden.—L. CASTLE.

INSECTS OF THE FLOWER GARDEN.

(Continued from page 334.)

I MUST briefly refer to a few other species of bugs allied to the frog-hopper or "cuckoo-spit," described in my last, though these are less frequently noticed. One of these, however, does attract the eye by its garb of black and scarlet: its wings also have a velvety appearance, which is caused by a crowd of tiny points, such as may be seen on the petals of some Pelargoniums by the help of a glass. From its colour this insect is called the scarlet hopper (*Cercopis sanguinolenta*), and it is fond of crawling upon the fronds of Ferns, but it leaps off dexterously when an attempt is made to secure it. The grub or larvæ sucks the juices of plants, but it has not the power of covering itself with an envelope of froth. Commoner than this, yet less in size, is the eared-hopper (*Centrotus cornutus*), remarkable in the mature condition for the extraordinary structure of the thorax, which has in front two horn-like projections, and extending towards the abdomen another appendage like a miniature dagger. Possibly there are insect-eating birds that devour bugs, but they would, I imagine, regard this one as an uninviting morsel.

We have now reached a group which contains insects, certainly of diminutive proportions, but which from their numbers and their mode of attack upon vegetation must rank amongst the most formidable foes to horticulture. These are in popular phrase plant blight. To some species the vague name of "fly" is given, and some again are called the "dolphin," rather oddly; in science they are the aphides, too well known to need description, though a few species are occasionally supposed to belong to the allied group of scale insects, the Coccæ. If less numerous in the flower garden than elsewhere, as perhaps they are, aphides are quite plentiful enough to give the gardener trouble. It is unnecessary to enter extensively upon their general history, but I may mention one or two facts of recent observation. The rostrum, sucker, or proboscis, with which aphides are furnished is, while they are feeding, pressed against the leaf, but the lancets arranged round it alone puncture the plant. Sometimes when not feeding these lancets are briskly vibrated by the insect; a sort of digestive exercise it may be. In the case of many plants it has long been felt that the injury they seemed to sustain from aphides could hardly be explained by the loss of sap, and naturalists concluded that the pores of the plant were probably clogged, and it was made sickly by their sticky secretion. The presence of the lancets, and the freedom with which they are used by aphides, suggests that the multitude of tiny incisions they make must have a weakening effect upon plants. Another way by which these insects are distributed has been noted lately. Their habit of migrating on the wing conveys them both long and short distances; it is now found that they are carried about in the egg state. Though aphides generally place their eggs on the twigs and stems of plants they also, it seems, sometimes deposit them on leaves during the autumn. The leaves fall off, and are often wafted by the wind to a distance, and when hatched the young aphides manage somehow to start a new colony; and, though the work of the autumn or last winged brood is this egg-laying to carry on the race to another year, it appears not to be entirely dependant upon this, since investigation shows us in the winter straggling females of many species, which live on, some of them in our houses, and produce young at intervals if the weather is mild.

Examples of such common aphides as that which infests the Bean, or the as abundant species haunting the Plum, may be seen now and then on the plants in our beds; but flowers have their species peculiar to themselves. The queenliest of our flowers, the Rose, suffers much from this, as it does from other insect enemies.

More than one kind of aphid frequents the Rose. The principal pest is *Siphonophora rosæ*. Subject to variation of colour, as many aphides are in the same species, it is either shining green or a brownish red; occasionally we see a party of them bright red, antennæ and legs long, the eyes red. Each female, when bringing forth alive, produces from thirty to fifty young, and on Roses, both indoors and without, we may often find some of them lively enough in winter. Eggs are, however, laid during the autumn, large for the size of the aphid, so the number from each female is four, five, or six. At first yellow, they are afterwards black, and they appear to be usually placed in a fold of one of the leaf buds. Evergreen or Perpetual Roses have been noticed to suffer least from aphid as a rule, but the worst victims are Sweetbriar and Moss Roses.

On Geraniums and Pelargoniums we have seldom any difficulty to discover specimens of *Siphonophora pelargonii*. This is a long-bodied aphid, the antennæ and legs also long; the body, if magnified, is seen to be curiously punctured and wrinkled in colour; it is entirely green, or yellowish-green. When winged the females are still green; but the head is brown, with red eyes and long antennæ, the abdomen transparent, and the light green wings are veined with brown. As in other species the winged form appears in May or June, and again in autumn. We find this not only on Pelargoniums, but on Calceolarias, sometimes on Chrysanthemums. From its having been first observed in houses some have supposed that this was an imported species; if so, it has now become hardy in habit, breeding all the year round, and probably small companies of them frequently lodge during winter near the stock or crown of Chrysanthemums just under the soil.

Siphonophora convolvuli infests plants of the genus from which it takes its name, occurring also on *Nemophila* and some other annuals and biennials. This is a large aphid of a dull green, but the antennæ and legs are black; its body is transparent and punctured. When winged the insect is a brighter green, the body spotted and striped, legs short, and wings marked with yellow. The Honeysuckle is a plant offering special attractions to *S. xylostea*, which breeds upon it in thousands in June unless precautions are taken. It is a long-bodied aphid, green, furnished with a yellow tail and having the body ringed. At its time of flight it is furnished with greenish wings marked with brown, the head, thorax, and antennæ being black. Some Ferns, especially *Cystopteris*, are visited by a large aphid, green and transparent, having a mottled appearance and long antennæ. It is commoner some years than others. *Pemphigus lactucarius* is a species linked to the American blight, as it produces long threadlike fibres of pale yellow. In the unwinged state it lives underground, close to the roots of Wallflowers and some other cruciferous plants. The young look at first like tiny centipedes, and have no eyes; as they grow these organs develop, and they assume the aphid form.—
ENTOMOLOGIST.

CLEANING GRAPES OF MEALY BUG.

GARDEN literature abounds in detailed instruction for ridding our Vines and vinerias of mealy bug, and yet it is questionable if ever it was more prevalent than it is to-day. The fact is, there are few gardens where the vinerias have not also to do service as plant houses, and many plants requiring protection and heat have often to be grown in them; in this way bug is often introduced into vinerias at seasons when it is impossible to deal with it. After long and desperate contests with mealy bug in vinerias my conclusions are, that so long as they are vinerias and nothing else it is by no means difficult to rid them of the pest. But if they have to be plant houses also, and if the plants grown in them have to do service in a conservatory, the construction and arrangement of which is such as to make it impossible to clear them of the enemy, then you must ever be on the alert, and even then can only hope for partial success.

From causes such as these and numerous others over which the gardener has no control, he often finds that notwithstanding all his efforts the bug has managed to establish itself in his Grapes and rendered them quite unrepresentable. It may be welcome news to some of the Journal readers to know that such Grapes need not be thrown away, as they can be thoroughly and quickly cleaned and be none the worse in flavour and very little in appearance. The chief factors in the operation are pure soft rain water, a syringe or hydrant, and two careful men. Let one man take a bucket of water and a hydrant, which is better than a syringe, because it gives a continuous stream; and the other should have an empty bucket to hold the Grapes over so as to catch the mealy bug that is washed out. To preserve the bloom on the Grapes they must be carefully handled, and this is best accomplished by looping a strand of bass round the stalk at the lower part of the bunch; by this means the bunch can be turned at a sufficient angle to expose the stalks of the berries to the action of the water. The man with

the hydrant must direct the stream of water into the stalks of the berries with sufficient force to wash out all the mealy bug; and the man with the bunch must keep turning it so as to bring all parts into direct contact with the spray. When the bunches are clean hang them in a dry airy house a little distance from the heated pipes, and occasionally give them a gentle shake, when in about twenty-four hours they will be dry.

Any water will wash off the bug, but if clean soft water be used there will be no sediment on the berries or traces of syringing. I have often kept Grapes in winter for two months after treating them as above without losing a berry, but it is generally best to wash them a few days before they are wanted for use. When from any cause there is a possibility of mealy bug infesting Grapes the bunches should be extra well thinned, for crowded bunches offer a good nidus for them. Moreover, they are more difficult to clean.—J. H. W.



M. E. A. CARRIÈRE.

THIS Japanese variety, which I saw once or twice last season, has fulfilled the promise it then gave. It is, I believe, of French origin. When in its best form the blooms are large, florets wide and incurve in quite a loose manner at the points, not close enough to form a ball. The colour is creamy white, heavily blushed, and in favour with ladies. I call special attention to this variety, however, now on account of the splendid pure white flowers the plants afforded at Christmas time. Instead of cutting off the stems close to the soil after the main blooms were removed, signs were visible of other flowers appearing, for 2 feet down the stem; therefore the plants were left as they were. We have been able to-day (24th December) to cut numerous pure white blossoms, quite reflexed in form, each having a full centre. They were used for church decoration, and associated so well with dark coloured evergreens that we wished our stock of this variety were three times as large. Another of last year's varieties *Léon Franche*, a silvery white, shaded rose toward the centre, has also produced a welcome supply of blooms. This late and double-flowering propensity of these new Japanese varieties, I consider a step in the right direction.—E. M.

CHRYSANTHEMUM JOHN LAMBERT.

MR. MOLYNEUX avoids the one question I put to him on page 457. If he refuses to call a variety by the name it was certificated under, the least he could do would be to call the variety in question Improved Golden Queen of England when he acknowledges it to be an improvement, and at the National I see it is reported as 100 per cent. in advance of the others. This is not a bad proof that it merits something to distinguish it from the old variety. "West Riding," like myself and plenty of other growers, can only find time and room to grow the best of each variety. This is acknowledged to be the best by Mr. Molyneux himself, as shown in my last letter, and as the "National" saw fit to distinguish it from others by giving it a certificate as J. Lambert, why should it not go in that name? Is not the N.C.S. a sufficient authority? I have not yet advised anyone to show it in the same stand with Golden Queen of England or Emily Dale, although it has been so shown this year in a first prize stand. Similar remarks apply to John Doughty and Bronze Queen. Mr. Molyneux would not recommend anyone to show these two in a stand of twenty-four blooms distinct, yet John Doughty has been adjudged distinct. I feel sure it will prove a good built flower next season as raised from stronger cuttings. I thank Mr. Molyneux for his congratulations, and feel sure he will find more John Lamberts to judge next November, if it is not such an illustrious name as the one he prefers—Golden Queen of England.—JOHN LAMBERT, *Onslow, Salop.*

CHRYSANTHEMUMS FOR DECORATION.

MUCH has been written from time to time on Chrysanthemums for exhibition, which has caused many amateurs to discard varieties most useful for decoration, and cultivate those which they have seen grown to so great a size at the various exhibitions. Cut blooms at an exhibition are very misleading to those in search of good varieties for decoration, as in many instances the bloom shown was the only one on the plant fit for the show table, the others being deformed and of no use.

For usefulness and effect there is nothing better than bush plants with from one to two dozen fair-sized blooms, every one of which is suitable for cut work in vases. When plants are grown on the three or four bloom system the individual blooms are too large for house decoration, and likewise do not last in flower so long as the bush plants with their smaller blooms. Giving large money prizes by Chrysanthemum societies for cut blooms and groups of plants with large flowers, has induced many growers to dispense with bush plants to make room for plants grown for exhibition purposes. That such should have been the result every lover of this beautiful flower will deplore, for it is

only when grown as bush plants that their usefulness is made apparent. A few societies have lately tried to revive the growing of bush plants by offering prizes for groups of cut-downs, and if other committees were to copy the example it would, without doubt, be the best means of showing amateurs and others interested in the Chrysanthemum the best varieties to grow for decoration.

I will enumerate a few of the varieties which I have found most suitable as bush plants. Early varieties: Madame C. Desgrange and Gustav Wermig, to be followed by Lady Selborne, Marguerite Marrouch, Avalanche, Mdle. Lacroix, Edwin Moilyneux, Hamlet, Jeanne Délaux, Madame J. Laing, Sarah Owen, W. Holmes, Val d'Andorre, Stanstead White, Cullingfordi, Mrs. Dixon, and Mrs. Rundle. Late varieties: Meg Merrilies, Ralph Brocklebank, Hero of Stoke Newington, Princess Teck, Charles Gibson, Ethel, and Virginale. The above list contains the most suitable, and will give a succession of blooms from the middle of August till the end of February.

The end of November is the best time to propagate, procuring short stout cuttings from the base of the plant, and insert them singly into thumb pots, using a light sandy compost. If placed in a cold pit and kept close for a few weeks they will quickly form roots. Care must, however, be taken to keep the foliage dry, or many will be lost through damp. When rooted plenty of air must be given on all suitable occasions, and if the pit can be kept at about 40° the plants will pass the winter safely, and be in good condition for transferring into 48-size pots early in March, this time using one part leaf mould to two parts loam, with the addition of a peck of horse droppings slightly dried and broken up fine, to every 2 bushels of soil, and sufficient silver sand to keep the compost open.

The final potting of the early varieties should be done early in May, and the autumn and winter varieties early in June, using the same compost as before, with the addition of 7 lbs. of Thomson's Vine and plant manure to every 2 bushels of soil. Sixteen and twenty-four sized pots will be found sufficiently large, and are most suitable for plants used for decorative purposes. Pot moderately firm, as it induces a well ripened growth and subsequently an abundance of well developed blooms.

Watering is an essential point, and must be well attended to, never allowing a plant to become dry, or disastrous results will follow. Liquid manure may be given once a week during the growing season. After the buds are set it may be given every second watering, with an occasional dusting with some artificial manure. When the flowers are partly expanded all supplies of manure must be withdrawn, because the ammonia in the manures acts too strongly on the flowers, causing them to decay quickly.—J. P.

NEW VARIETIES OF CHRYSANTHEMUMS.

MR. DOUGHTY'S suggestion that cultivators of the Chrysanthemum should exchange experiences with reference to the "novelties" which they may have tried during the past season is a very practical and useful one. Considerations of space render it impossible adequately to test all of the vast array of "novelties" which each season brings to us, and unfortunately the glowing descriptions which oftentimes accompany them are not always to be strictly depended on. Besides, when we consider how very small a per-centage of these introductions prove of sufficient merit to supplant existing show varieties, it is obvious that, unless space and labour are unlimited, indulgence in the undoubtedly interesting task of proving novelties in any quantity must be at the expense of the general "showing power" of the collection. It is very desirable, therefore, by way of mutual assistance, that those in a position to do so should follow Mr. Doughty's excellent example and contribute their experiences of new varieties to the common stock of knowledge on the subject.

Here, then, is my contribution. I have followed the lines suggested by Mr. Doughty. In considering the dates given allowance must be made for locality and situation. My garden is twelve miles south-east of London, in a valley, and exposed to severe frosts, early and late. As I write (10 P.M., December 22nd) my Negretti and Zambra thermometers (certificated at Kew) show 8° above zero at 4 feet above the ground, and 2° only exposed on the hard snow. But to the "new varieties."

I have divided them into four sections—namely: Section 1, Those which, in my judgment, are likely to prove of high value for show purposes. These are:—

A. H. NEVE (Japanese).—Very large; long drooping petals somewhat after the style of Belle Paule; silvery bluish. Height to crown bud, from pot, 5½ feet. Fairly strong grower. Plants rooted February 28th. Showed early bud, June 24th. Crown buds taken August 27th. Flowers fully out, November 8th. Last well. Time correct.

ANNIE HARTSHORN (Japanese incurved).—Waxy white; petals of great substance, symmetrical, and bold, incurving; 4 feet; good grower; struck 31st December; showed early bud 31st May; showed second buds 20th June; these removed, crown buds taken 14th August; out 15th October *et seq*; fine flowers, but taken rather too early. This variety is remarkable for the persistence with which it shows buds. The whole of the early cuttings, even those remote from the stem, show buds. Late cuttings probably best for many reasons.

PURITAN (Japanese incurved).—Early blooms white, later blooms peach; petals incurving, broad, and regular; large flower; 5 feet; strong grower; first plant struck 21st January; showed early bud 23rd April; crown buds first visible 25th July; taken 10th August; flowers out 31st October; pure white, very full and fine; second plant struck

14th December; stopped at 4 inches; showed first buds 15th August; taken 22nd August; flowers not quite so full centres as last plant, but strongly tinged with peach; out 12th November; a terminal bud on a third plant showed an eye.

DANAE (Japanese).—Bronze or amber yellow; very large and massive, but somewhat rough in character; florets drooping, long, and twisted; 5½ feet; strong grower; struck 17th November; early bud 22nd May; crown buds visible 4th to 11th August; taken 11th to 15th August; out 11th to 20th November; time correct.

MRS. A. WATERER (Japanese).—Early flowers dull white, with petals after Meg Merrilies; later blooms petals very broad, resembling a bunch of white ribbons tinged or striped with rose on the exterior; first plant struck 30th January; crown buds 16th August; out 20th October, rather too early; second plant struck same date; pinched 1st June; late crown buds taken 7th September; out 28th November, too late, 20th to 25th August probably best time.

M. E. A. CARRIÈRE (Japanese).—Creamy blush tending to white; long drooping petals; large, 6½ feet; strong grower. Two plants struck 5th December; both showed early bud 15th June. The next buds, terminals, appeared 10th, and were taken 14th September; out 20th to 25th November; fine flowers, but rather too late.

GEORGE ATKINSON (Japanese).—White, something after the style of Madame Louise Leroy; very large, and when well grown very deep and full; flowers from late crowns or terminals show an eye and have wide flat petals; 4½ feet; strong grower; struck 31st December; crown buds taken 20th August; out 15th November. Second plant, one crown bud taken 28th August and two terminals 12th September; probably about 14th August correct time.

W. W. Coles, superb; Mrs. E. W. Clarke, scented; R. Crawford, very large, but somewhat ragged; Volunteer, certainly distinct from, and superior to, Mrs. Irving Clarke; Léon Frache, best on rather late bud; and Mrs. Alpheus Hardy, with me a strong grower, but marvellously brittle, have already been dealt with by Mr. Doughty and others.

I have not included Sunset, as, although we are told that it will come double, the experience gained from four plants with varied experimental culture has not, so far, led me to that conclusion. At present I must class this variety as semi-double, and, although unquestionably a magnificent variety, useless for show purposes.

Section 2.—Varieties which require a second season's trial but appear likely to prove show varieties of more or less value. I give them in order of merit as I have found them, but as they are with me still on trial, I do not propose to trespass on your space by giving cultural notes. These, however, I can supply to anyone wishing for information concerning any particular variety named. All the following are Japanese:—George Maclure, very promising; C. Pratt, late, very promising; L. Canning, white, after Avalanche, good for late work; Mont Blanc (Waterer); M. A. de Leau, very like Mdle. Lacroix; Coronet; Lucrece; Mont Blanc (Délaux) not strictly a novelty; L'Automne, very attractive colour; Vieil Or, very late, must have bud by 1st August; Mrs. Irving Clarke; Eynsford White and Maribol.

Section 3.—Varieties worthy of a further trial, but not, so far, showing clear evidence that they will ultimately prove of real value for showing purposes:—Mrs. J. C. Price, Cécile, Sokoto, Mrs. Langtry, J. R. Pearson, Mdme. V. Menier, Mrs. Spaulding, Meto, Sunnyside, Honourable Mrs. Carnage, Mrs. A. J. Drexell.

Section 4.—Varieties which, so far as my experience of them goes, are not likely to prove of lasting or perhaps any value for show purposes, although many of them are very novel and pretty, and valuable for decoration. The experience of others may lead to a different conclusion, but I give the list for what it is worth:—Little Tycoon (early), Madame Prunac (very pretty contrast of tender colours), Miss Esmeralda (colour too dull), M. Jules Le'ebvre (very beautiful), Madame Lay, M. J. Collins (very pretty, colour quite unique), Kioto, J. Thorpe, Seebard, Neptune, Superbe flore (early), Baronald (too like G. F. Moseman), Gladiator (identical with C. Sharman), Alcyon, Grand Mogul (too late), Gold, President Hyde (telling colour, but too small), Mrs. J. B. Bailey (very late), Dr. John Tanner (pretty, but lacks size).

As I can "house" but 450 plants all told the trial of the foregoing, from one to four plants of each, trenched very greatly on my general show collection. The results are at the service of your readers.—C. E. SHEA, *The Elms, Foots Cray, Kent*.

[We are very much obliged to Mr. Shea for his interesting communication.]

CUTTING DOWN CHRYSANTHEMUMS.

Now that the busiest part of the Chrysanthemum season is past growers will be comparing the past season's work with the previous year's doings. As my subject is cutting down, I must confine my remarks to that portion of the work. In making out the following list I have confined myself to varieties that may be depended upon to produce good results. I have omitted many which I consider are not constant under the cutting-down system, though they sometimes do well. To make my remarks as clear as possible I have classed the varieties into three groups. Those to be cut down early should be operated upon about the middle of May, though, as will be seen, there are but few which require to be cut down so soon. We have had Mdle. Paul Dutour grand when cut down then, but it is not included in the list, as two blooms are sufficient for one plant to bring to perfection. Mrs. F. Jameson is omitted for the same reason. The midseason kinds should be cut down the first week in June, and the middle of the month is early enough for those classed to be cut down late. I have

also given the height of the plants above the pots, which are within a few inches of their exact height this season :—

					feet	in.
<i>Varieties to be cut down early—</i>						
Guernsey Nugget (very fine)	3	6
Boule d'Or	3	6
Marta	4	0
<i>Midseason—</i>						
A. Salter	3	6
Queen family	3	6
Barbara	1	6
M. Bernard	2	6
Neptune	3	0
Amy Furze	3	6
Comte de Germiny	3	6
Coquette de Castille	2	0
E. Molyneux (late bloom unsatisfactory)	3	0
Hamlet	3	0
Mdlle. Lacroix	2	6
Mr. Garnar	2	0
Meg Merrilies and R. Brocklebank	3	0
Puritan (produced eight good blooms)	3	0
Maiden's Blush	3	6
George Atkinson (flowers fuller than when grown on the orthodox system)	2	6
W. W. Coles	4	0
Madame Baco	3	0
Mrs. F. Thomson	3	6
Mrs. J. Wright (fine form)	3	6
Soleil Levant	3	6
Cullingfordi	2	0
Massalia (good colour and form)	2	6
Mrs. Irving Clarke	3	6
Sunflower	4	0
<i>To be cut down late.</i>						
Beverley family	3	0
Rundle family	3	6
Aureum multiflorum	2	6
Avalanche (very fine)	2	0
Florence Percy	2	0
C. Wagstaff (good)	2	0
Etoile de Lyon (very fine)	3	0
Mdme. Louise Leroy (very pretty)	3	0
Elaine	4	0
Agréments de la Nature (very pretty)	4	0
J. Délaux	4	6
La Triomphante	4	0
Martha Harding	3	0
Mdme. de Sevin	2	6
M. J. Laing	3	0
M. Freeman	1	6
Othello	2	0
Mdme. J. Laing	2	6
Sarah Owen	2	6
Wm. Holmes (very fine)	2	0
Wm. Stevens	2	6
Wm. Robinson	3	6
Miss Gorton	3	6
Marvel	3	0
Triomphe du Nord	1	6
Gorgeous	3	0

The Teck family have succeeded well this season, but I do not consider them reliable. Ours were cut down at midseason and late. Both gave fair blooms, especially Lady Dorothy and Mrs. Norman Davis from the midseason plants. The Christine family generally succeed, and should have been placed in the midseason list; also Cloth of Gold, though these varieties are not so desirable for grouping; the blooms are produced on weak stems, therefore require support. There are other kinds addicted to the same habit, though included in the list, notably Elaine, the Beverley family, and the Rundle family. Some growers recommend Lord Wolseley, Jeanne d'Arc, and many other large flowering kinds to be cut down in order to dwarf the plants, but I have not found it answer so well as cutting back later to just below the summer bud. Perhaps these remarks may induce some of your numerous readers to give their experience on the subject.

I have tried Guernsey Nugget stopped the last week in April, but it was rather coarse. Last year it was very fine, carrying six good blooms on a plant. I consider this variety very desirable, for when done well it makes a splendid and formidable plant for grouping, the foliage and flower lasting for a long time.—J. PITHERS.

LETTUCES.

THE note from M. Schaettel, stating that the "Blonde Géante" is synonymous with the "Blond Blockhead" confirms the impression I was under when I wrote the inquiry he has so kindly given an answer to. "Géante," of course, means giant or gigantic, and it does seem strange that such a mistake should have been made in translating the name into English. My experience with continental

nurserymen—Belgian and French in particular—is that they know how to write English better than some of their confidères on this side of the channel. At any rate, the Lettuce under discussion ought to be made a note of, especially by those who wish a good exhibition dish, for which purpose I am pretty certain from what has been written it will hold a high position.

I imagine Mr. Harding, who writes so fully on Lettuces on page 532, last volume, would succeed better with midwinter Lettuces were he to transplant them earlier than the time he recommends—November, and also were he to make use of plants in a less advanced stage of growth. At the best they are a rather uncertain crop, as for instance last year the weather was so abnormally mild that our stock bolted and had to be replaced with younger plants from the open quarters. This year we have them just right. I find it is also unsafe to depend on one sowing. This season the sowing made ten days after the one which was intended for the winter plants proved to be a very fortunate one, as the mild autumn brought the crop forward so rapidly that we had to use these for the frames. Of course it places us at a disadvantage for the crop expected in early summer, but the little cabbage sort, Tom Thumb, is so amenable to forcing treatment that there is no difficulty in procuring an early supply of these.

With regard to winter Lettuces I think the following points need to be specially considered in order to succeed. Not to depend on one sowing, but to make a planting of each sowing made ten days earlier, and ten days later than the one which generally comes in to time. Hicks' is the one I find satisfactory. I have had it for the past eighteen years, and have never found it fail. During the summer and autumn it grows a large size, but for winter supply it is grown on soil which is sufficiently poor to keep the heads small. Our Lettuces are invariably transplanted. In some seasons when growth is too robust the plants are partially raised a week before their removal to frames. The middle of October is quite late enough to remove them, and the plants should not be fully grown. They are selected in different stages, but, of course, all good plants. To each 6 by 4 light one barrowload of leafy soil is employed, and is all placed round the balls. Water is never given, but care is taken to have soil and plants in a proper state of moisture. If the weather continue dry the sashes are kept off, but on the other hand, should a period of rainy weather set in the sashes will do no harm if left on continually, taking the precaution, however, of raising them at the top and bottom about a foot above the frames. Slight frosts do no harm, but directly it is seen that a severe frost is imminent the sashes must be closed and kept matted until the frost is out of everything.

Endive is given much the same treatment, but is much easier to manage than Lettuce. If very hard frost sets in it is a good plan to fill the inside of the frames with bracken—clean Wheat straw being a good substitute. Our frame snpply lasts as rule until April. March almost invariably proves the worst time. The increased power of the sun starts the plants, and the winter treatment seems to have so thoroughly deteriorated their constitution that numbers damp directly growth is made by the plants.

EARLY LETTUCES.

Now is the time to begin the preparation for these. A sprinkling of Tom Thumb seed should be sown in a box filled with light soil. As soon as the plants are large enough prick them into boxes; those which are to finish in the boxes at 3 inches apart, the others at 2 inches. The great merit of this as an early variety is that it forms close little heads at an early stage, and can be cut much smaller than any other sort. If left uncut it continues to grow, but those in boxes should be cut as soon as they fill the spaces allowed. The others in due time are transferred to frames, a late Peach house, or the foot of warm walls. In the third week of January a further sowing should be made. Tom Thumb, Hicks', and All the Year Round, or any of the new varieties which are continually appearing. Some of the Tom Thumbs should be transplanted in frames, the others going to the garden. From the middle of March to the beginning of April is the period to transplant these. About the same time these are sown, though sometimes we have to wait until February, a sowing is made at the base of a south wall, and we generally have some useful heads from these positions.—B.

IRON.

ITS USE IN CONNECTION WITH FRUIT CULTURE AND DISEASES.

ON page 511, December 11th, 1890, I concluded with a statement by Dr. Griffiths in reference to the efficacy of sulphate of iron in the Cucumber root disease. Ammonia is necessary for Cucumbers, yet practically useless without iron. Soot contains the essential iron. I found it transform Gardenias from small sickly

leaved and bud-casting plants into specimens with Laurel-like foliage and flowers like Camellias; also *Cianthus Dampieri* from a pale hue into a deep green healthy state. These have root nodules, tubercles of a fungoid character. Mere watering with soot water was enough, but Dr. Griffiths states iron sulphate is "a means of destroying fungoid germs which may be present in any cultivated soil." That is good news. From half to three-quarters of a cwt. of the iron sulphate is enough per acre; and, therefore, 6 to 8 ozs. per rod may be taken as a minimum and maximum quantity respectively, or a quarter oz. per square yard. This very small quantity, therefore, would be sufficient to mix with 7 bushels of soil for Cucumbers, Melons, or Tomatoes, to save them from disease.

There is another point. We throw the remains of Cucumber, Melon, Tomato plants, &c., with their soil on rubbish heaps, and thus spread the disease wholesale. A little sulphate of iron sprinkled over these heaps would in all probability save the plants from their enemies. Sprinkling rubbishy leaves and partially decayed refuse of all sorts with a solution of iron sulphate, just damping them in using for hotbeds, would certainly be beneficial, or even sprinkling the bed before putting on the soil would help in keeping down this Cucumber plague, but it is well also to impregnate the soil.

"Iron sulphate is composed of iron, sulphur, and oxygen. The active manurial ingredient in this compound has been given by some to the iron, and by others to sulphur. We believe that both ingredients are important plant foods, and that iron sulphate is one of the, if not the, most important sulphates used in scientific agriculture. Professor A. Müntz (L'Institut National Agronomique, Paris) says:—'With any sulphate (ammonium sulphate is not excluded) there is an increase of 13.54 per cent. in the growth of crops, but with iron the increase is 30.2 per cent.' M. Müntz also obtained an increase of 9.6 per cent. of chlorophyll in those crops grown with iron sulphate."—(Manures and their Uses, page 143).

As iron increases phosphoric acid increases, and potash decreases, also sulphuric acid. Phosphoric acid is essential as a food for protoplasm. Iron hastens the decomposition of organic matter in order to seize on the ammonia. What more is needed? Only this. Dr. Griffiths states:—1, "Iron sulphate may be sown broadcast by hand as a top-dressing when the crops are a few inches above ground or mixed with two to ten times its weight of sand or soil. Iron sulphate may also be used in solution and distributed by means of a water cart or water pot. 2, It is essential to bear in mind that from half cwt. to 1 cwt. of iron sulphate per acre are the only proportions that give good results. 3, Iron sulphate must always be used on wet ground."

What of iron with relation to canker in trees? Well, I do not believe in iron having anything whatever to do with it except to cure it. I will go further, and say that whether it is the cause or effect fungus is inseparable from it. There is no cause of the evil in an east wind; the cause is in the tissue of the plant affected by that wind. Cold, it is said, produces blister in Peach leaves. It does nothing of the kind. It only produces a condition of the host suited to the fungus—the fungus causes the blistered leaves; no east wind or cold will cause them to become distorted to the millionth of an inch. Pay strict attention to warmth, and there will be no "blister." Keep the east wind back, and there is no need of the warmth. The fungus is there, and it causes the blistered leaves. Prevent it by all means, as a physician stamps out fever by removing impurities of water and air. These foster the germs of disease; get rid of them, and what? There is no disease! The east wind, it is said, bring caterpillars innumerable. Yes, whatever weakens a fortress causes it to be easier taken; but kill the caterpillars, What then? The winds may blow as they list. I do not believe in any savant's assumption of knowledge of first causes. Three out of five Apples and Pears I have seen this year were scabbed with *Cladosporium dentriticum*; similarly both fruits were pierced by the Codlin moth grub (*Carpocapsa pomonella*). Kill the spores of the first and the moths or eggs of the latter, and we shall put as clean fruit in the market as the importers. Act like the physician; destroy the germs.

In the *Journal of Horticulture*, vol. xxvii., new series, page 299, Mr. Robson states in a description of Seacox Heath, "Decomposed sandstone is the basis of the surface soil. . . . The soil is generally of a pale yellow colour, and contains few stones, and these generally soft, but it is very fertile, and most crops attain great perfection, notably many kinds of fruits, and it is a singular feature of the district that Apples grown here produce a different kind of cider from that which is made from the same variety grown in the neighbourhood of Maidstone, the latter being an inferior liquor, although the fruit appears to be finer, thus showing that certain soils supply food of a different kind to what others do. An absence of calcareous matter (that is worth remembering), and

a corresponding preponderance of iron cause much of the difference, and iron works existed in the neighbourhood, and was worked to advantage long before the present seats of the important iron trade in the northern counties were ever thought of. Lamberhurst, a village a few miles to the east of Tunbridge Wells, supplied the iron from which the railings that surround St. Paul's Cathedral were made, but the furnaces have long ceased to be worked, and the neighbourhood is as exempt from the smoke of iron foundries as it was in the days of Julius Cæsar. But the loss of the iron trade is amply compensated by the improved cultivation of the land," &c. The bottom iron became mixed with the top sandstone, both weathered into a favourable fruit soil, rivalling Maidstone in its products. Two things that deserve note, irony sand "improved cultivation."

Turn to page 358 of the same volume, where "G." writes, "I observed in my previous notes upon the fondness for gardening in some of the Sussex nooks, but I should have included orcharding. No nooks of any other county contain more old (note that) fruit trees, &c. In these nooks are to be recognised dog-irons and fire-place backs, used when fires were kindled on the hearth, and manufactured two centuries ago, when iron-smelting was an extensive operation in Sussex. There the ore (iron) is part of the subsoil."

That is conclusive. Apples thrive on heavy soil, even Duck's Bill, the oldest Apple in existence. Mr. Douglas tells us in the "R.H.S. British Apples Report," page 47, how he cured Apple trees of canker on a light soil over a gravel subsoil by bringing in clay. There is the iron and alumina, for they are inseparable from clay, and both prevent bleaching because they lay hold on ammonia. Mr. Douglas' good cultivation did it—freed the trees of canker.

Mr. Cheal works on a heavy soil, he mixes the iron with the soil, stirs it up with a subsoil plough. "One of the best preparations for fruit planting is to grow a root crop on land that has been deeply cultivated and well manured." That is the way to do it, bring in ammonia for iron to ammoniate. Call it good cultivation if you like, none of those panaceas are a particle of use without iron. It comes in everywhere. Even Mr. Tonks applies it direct, and Mr. Wright stands sponsor. He tells us the soil was heavy, and Mr. Tonks "having ascertained what the soil lacked and what Apples needed, the necessary ingredients were obtained and applied." The soil was heavy, there was iron in it, yet the trees were as if devoured by canker. The soil had not been sufficiently worked—ameliorated, and the iron would corrode the roots for the simple reason that it got no ammonia, for iron is like everything else liable to rust for want of using, and it never acts on itself for any good.

Mr. Wright tells us what Mr. Tonks used—namely, superphosphate, lime, phosphoric acid, sulphuric acid, nitrate of potash—nitric acid (equal to 13.8 per cent. of nitrogen, 46.59 per cent. potash)—(Griffiths). But who can afford to use saltpetre? (There is no sign of its less need for making gunpowder). Salt, of which little is understood, chlorine, sulphate of magnesia or Epsom salts, sulphate of iron. Let us examine these physically. 1, Superphosphate-phosphoric acid, the energiser of the protoplasm. The trees were given new life, of "special importance on clayey and stiff calcareous or damp soil." Nitrogen:—1.76 per cent? Not a very powerful fertiliser on that score. 2, Nitrate of potash, growth and development of plant, and a corrector of the burning of phosphoric acid in a dry season, hence perhaps its liberal use in this case, and nitrate instead of chloride or muriate of potash for a similar reason. Of course, lime in the superphosphate (50 per cent.) will economise the potash. There is also the 13.8 per cent. nitrogen. 3, Salt, dissolved silica, this is found in Apple fruit, 4.32 per cent., wood 2.06 per cent.; but what of the bark? There is reason to believe it obtains largely in the bark of the Apple kept clean. 4, Magnesia, sulphur, aids formation of tissue. 5, Iron, sulphur protoplasmic. 6, Gypsum, another fixer of ammonia, a liberator of potash. Lime is the great thing used. The consensus of opinion favours the antiseptic properties of lime. It is found in all cankered wounds—*i.e.*, at the edges, for canker is a dry gangrene—the effects of a fungus.—G. ABBEY.

(To be continued.)

LETTUCES AND ONIONS.

LETTUCES.—This is an excellent time for the gardening fraternity, amateurs and professional, to discuss their favourite vegetables when the pressure incidental to showing is removed, and when 12° of frost in the south of Ireland and 24° at London—*vide* last issue—compels the most active to find indoor occupation. I am reminded of the above by seeing the references by Messrs. Harding and Easty, last number of all gardeners' favourite Journal, which generally manages to bring before its readers the right subjects at the right time. A rough division of Lettuces would be into Cos varieties, represented by, say, Carter's Giant White, Bath Cos, and Hicks' Winter Cos, and Cabbage varieties represented by All the Year Round, Nonpareil, and Hamnersmith. If only

two good varieties are wanted, as by amateurs and small establishments, the first of each section will suit admirably; and if a hardy Lettuce is required the last in each case is the most suitable. In the ordinary acceptation of the term no Lettuce is hardy, nor is it of much palatable use except growth is completed before November. Once a thaw sets in the soft tender growths begin to rot, and afterwards, during the early spring months, it is difficult to render them inviting. I have tried on a former occasion like the present to preserve Cos varieties by covering them with dry hay; but when rain and thaw came the last state was worse than the first. An empty frame full covered with hay, and to which air and sunshine is admitted by day, is an excellent system of preservation for those requiring this tender vegetable during winter.

ONIONS.—I rather agree with Mr. Easty in preferring globular Onions such as Tennis Ball to flat-shaped varieties such as Golden Globe or the Holborn Onion; and at all the shows at which the question came for consideration my brother judges agreed with me, one of the reasons being that they keep better; but I admit much of this property depends on the time of sowing, position, and the season. If too late, say in April, and with a sunless aspect, followed by a moist season like the last, the best varieties will be almost impossible to ripen, and consequently to keep. Now, Silver Ball or Tennis Ball, very much similar, is my favourite Onion, and such a moist sunless summer comparatively, as the last, it would be almost impossible to keep well through the winter in an out store or implement house. Believing this I got my garden boy to bank a quantity, especially those that did not seem quite firm at the neck, and had them suspended in my kitchen and pantry; and so far not one has rotted, while they come dry, silvery, and hard off when required for kitchen use. I know of no other Onion so mild, tender, and well flavoured for the winter and spring months. With me the crop was about double in quantity the well known Deptford and Strasburgh. Unfortunately, except from the most respectable firms who have reputations to lose, reliable varieties, true to name, and fresh seed of last year's sowing, a high per-centage being likely to grow, is not to be expected.

All my gardening friends agree with me, a very good thing among very good seed cannot be expected very cheap.—W. J. MURPHY, *Clonmel*.

ACHIMENES ROSY QUEEN.

ACHIMENES rank amongst the most pleasing of summer flowering greenhouse and conservatory plants, and one of the most charming of the family is the appropriately named Rosy Queen, raised by Messrs. Sutton & Sons of Reading, and certificated last year. The illustration with which we have been favoured appears in the "Amateurs' Guide" of the firm mentioned, and faithfully portrays the plant. It is sturdy in growth, with rosy tinted flowers softening to white in the centre, and they are displayed to advantage by the dark foliage. As the time for potting Achimenes tubers is approaching the variety in question is well worthy of a place in all collections, for it is distinct from all others of the genus and decidedly attractive.

AS OF A DREAM.

(Continued from page 570.)

I FELT, and still feel, that the objects on my stand were worth more notice than they received. Imported productions and the produce from large manufacturers, elaborately embellished for purposes of commerce, which claimed their importance at the show, will always command the rich and well-to-do inhabitants of large towns; but for the million with moderate means, such as small holders and cottagers, the growth and utilisation of fruits in common preserves, &c., must be undertaken by themselves if they hope to live upon and make the most of their land. I could have brought up a greater variety of startling fruits, but my object was to explain a means to the end with as few good sorts as possible, and of those which can be depended upon for quality, and are hardy and bountiful for general cultivation. It is a great mistake to aim at huge fruits for home consumption, or to become encumbered with too many kinds. Leave the monstrous show fruits for those who are rich enough to make them so to take prizes, or whose business it is as nurserymen to supply the demand.

I will touch upon the Gooseberry first. My wife's exhibit of this was jam, because she found a customer for all she had for early bottling whole, and there is no better sort for this purpose than the Whinham's Industry—every one of them, as it is of poor quality when ripe. The Warrington is the best for preserving and for eating in a ripe state. I have many seedlings and sorts of high and low degree, but the first two mentioned are all that is necessary for the purposes mentioned.

Red Currant Jelly.—I pride myself upon my Red Currants. They are two varieties, presented to me by old friends, Mr. Collard, Minster, near Ramsgate; and Mr. Ross, Welford, Berks. The first, called Ver-

saillaise, is excellent for bottling, and when ripe for either eating or preserving with Raspberries. Mr. Ross's is a late ripener and excellent for jelly. I call it the Welford Red.

Black Currant Jam and Jelly.—I call mine the Collard Black for the reason given above. When visiting me last season Mr. Collard brought some berries in a box. He had measured them, and he said each of them had a circumference of 3 inches. I thought, perhaps, they might have shrunk just a little; but it is an excellent Black Currant.

Carter's Early Prolific Raspberry is all that is desired for a cottager. It and the Versailles Currant, which united composed No. 5, cannot be disapproved of.

Rivers' Early Prolific Plum Jam.—This is as its name implies: it is also a good Plum to eat in an uncooked state, and it may be termed a good all-round Plum. I have heard it disapproved of as not being large enough for the market. Then, for my part, the market would have to go without Plums. Nevertheless, Plums for market purposes must be

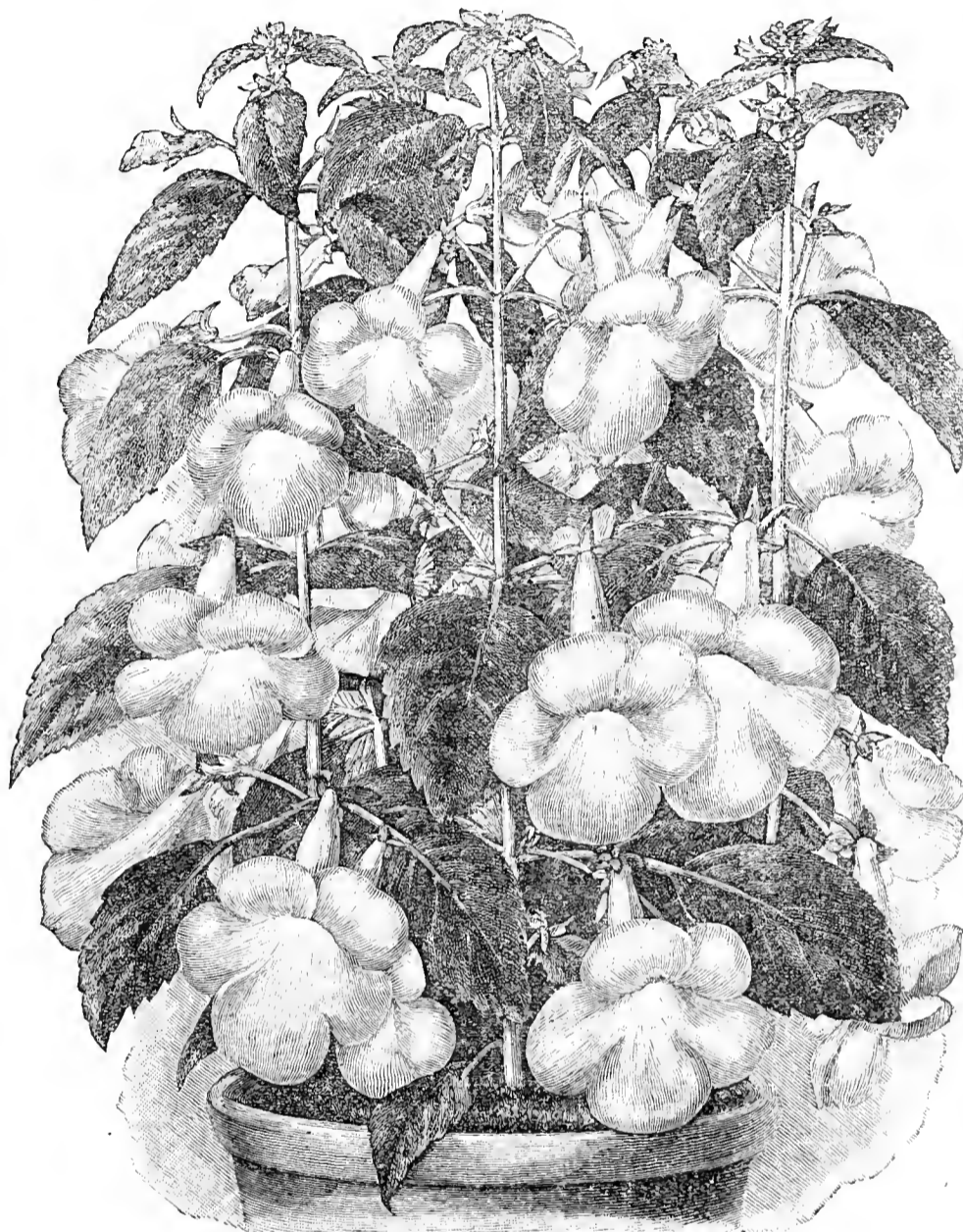

FIG. 4.—ACHIMENES ROSY QUEEN.

had, and the immense-bearing large inferior Victoria is to be recommended.

I have many seedling Plums here which have not yet gained sufficient favour. But I have some large old trees of a common Berkshire Plum which is a great favourite with the authorities of this household, and the jam exhibited. I find, too, these old trees, which overtop all their compeers, are preferred first of all for their early plump buds by the bullfinches, &c. They will, moreover, bear firing into without compunction of conscience, which the smaller and choicer varieties will not admit. So much the worse for the finches, and so much the better for the fruit.

Strawberry Jams and Syrup.—Keens' Seedling, Sir Joseph Paxton, and Knight's Elton Pine are my three Strawberries here; Black Prince might be added as an earlier kind than Keens', and Frogmore Late Pine as a better bearer than the Elton, and in fact the gamut on the Strawberry might be pioucted to in endless shifts, but the three mentioned above are what I grow, if I cannot recommend them dictatorially. Elton Pine is in fact the Strawberry to convert into jam, but the above exhibited, and which gained the missus a first-class certificate of merit, was made from Sir Joseph Paxton. The Strawberry syrup we consider a grand invention; we use it instead of sugar over our light batter and suet puddings.

Rhubarb and Vegetable Marrow Jams, plain and flavoured with

lemon juice, my wife makes as a sort of stop-gap in cases of being run out of better things. They come in useful too for children who occasionally have to "wait till the cows are milked," spread upon bread, or, what the youngsters like still better, upon bread and butter. These two jams and the Strawberry are all that the Judges condescended to adjudicate upon at my stand.

Apple Jellies, both plain and flavoured with lemon juice. The sourer the Apples the better they are for this purpose. I never used to grieve about the early windfalls or grub-eaten fruits. When the Apple jelly is under weigh, plus the pulp, after the juice is strained off, is more than an equal to Vegetable Marrow juice when sweetened and made into a pic.

The humble Blackberry in jam, either by itself or mixed with Apples, we find very acceptable, and the juice when extracted and made into jelly is "equal to Guava" of that ilk, I have heard people say.

Jelly made from the fruit of the *Berberis Aquifolium*; I grow a quantity of this shrub both for ornament and use. The beauty of its flowers in the early spring, and the pollen comes in so handy as bee bread directly the Crocuses are over. I think this jelly is equal, and to my palate even better than Currant, with roast mutton, say venison, in all probability. I use the ripe rich coloured fruit in the manufacture of some made wine. I crushed nearly a busbel of the berries along with my omnium gatherum fruits this season.

Now I arrive at the Damson jam. This, the last, must not be considered as least, for who in civilisation do not like Damsons preserved? I grow two kinds, the Farley or Crittenden and the Prune or Shropshire. It would be difficult to improve upon these two.

Thus ends the eventful history of my wife's jams. In the order of season my fruits should have been given precedence. It would never do for the *J. of H.* to forget the amenities, to let it be whispered even that gallantry has escaped from its pages; but the fruits named in connection with the preserves will not be mentioned again.—
ROBT. FENN.

(To be continued.)

ALOCASIAS.

THIS interesting group of stove Aroids includes a considerable number of distinct species and varieties, some of the latter of garden origin being among the finest warm-house foliage plants, while several of the original types are equally desirable. There is much diversity in the form and marking of the leaves of the various sorts, so that most of them are readily recognised.

They are natives of the East Indies and various portions of the Malay Archipelago, though probably not at any considerable altitude, and therefore enjoy warm-house treatment and plenty of moisture during the period of growth, and these conditions will be found essential to their well-being. At the same time it should be remembered that during the winter most of the Alocasias make but little growth, and therefore require but little water; in fact, some of them grow better after a season of entire rest, *A. Jenningsi* and *A. Marshalli* being among this class.

In regard to soil, the Alocasias prefer a light, open compost, as their thick, fleshy roots will not make much headway in a heavy or sodden soil, and for varieties such as *A. metallica*, *A. Sedeni*, *A. Veitchi*, *A. Sanderiana*, and *A. Thibautiana*, and others of like characteristics, a mixture composed of rough fibrous peat, with perhaps one-fourth of chopped sphagnum and some sand, will be found most suitable, while *A. macrorhiza*, *A. zebrina*, *A. Jenningsi*, and others of this class make most satisfactory progress when potted in a compost formed of the above ingredients, with the addition of a third part of coarse turfy loam and some dry cow manure, these species being comparatively gross feeders. These plants should in all cases have good drainage, for while they enjoy copious waterings when in full growth, they soon lose vigour when exposed to stagnant moisture. In bright weather they may be syringed freely, especially underneath the leaves, to keep away the red spider; otherwise the Alocasias are but little subject to the attacks of insects.

Prominent among the older varieties may be mentioned *A. metallica* (which is also recognised under the name of *A. cuprea*), a handsome kind, with large bronzy green leaves, which are purplish on the under side and strongly outlined by the prominent veins. This species was introduced from Borneo some thirty years ago, and will still bear comparison with some more recent introductions. *A. Sedeni* is somewhat similar in form and ground colour to the preceding, but is improved by the addition of ivory white veins. This variety is one of the finest for exhibition purposes, producing very large foliage and also being of rapid growth.

A. Sedeni was the result of a cross between *A. Lowi* and *A. metallica*, and has been in cultivation for a number of years. *A. Veitchi* is another effective species when well grown, its leaves being of rather different form from those above mentioned, and standing up well on long foot-stalks. They are deep green on the upper side, with whitish veins, and of a peculiar slaty hue on the reverse side. This is also a native of Borneo, and has been long in cultivation. But probably the most striking in appearance of the whole genus is *A. macrorhiza variegata*, which forms immense leaves of bright green, more or less marked with pure white variegation. The variegation is somewhat irregular, frequently appearing in large patches, while on other leaves it will be so mixed with the green as to give a marbled effect. *A. macrorhiza varie-*

gata is one of the strongest growers in the family, and enjoys plenty of heat and an occasional watering with liquid manure. It is said to have originated under cultivation in the island of Ceylon, and may certainly be considered one of the many botanical prizes received from that favoured home of tropical vegetation.

Among the smaller growing sorts may be mentioned *A. Jenningsi*, which has leaves about a foot in length, bright green in colour, with the spaces between the chief veins occupied by large blotches of dark chocolate colour, sometimes almost black. This species is of quick growth, and produces a large number of offsets from its bulbs, which render it of very easy propagation. Of similar character is *A. Marshalli*, though possibly more ornamental, its foliage having in addition to the dark markings of *A. Jenningsi* a central band of greyish white. These two species are natives of India, and have been known in our gardens for more than twenty years.

Another fine species, and one that is not very common in American collections, is *A. zebrina*, which produces almost erect, sagittate leaves of dark green, these being supported by strong footstalks that are light green in colour and banded zebra fashion with a much darker shade.

The later additions to the Alocasia family have also been numerous and valuable, many of them being hybrids of great beauty, while a number of remarkably fine species have also been introduced.

One of the newer sorts that should not be overlooked is *A. Sanderiana*, a remarkably fine species with sagittate leaves, the margins of which are deeply sinuated and marked with white, as are also the ribs.

Other fine species are *A. Cbantrieri*, a hybrid from *A. metallica* and *A. Sanderiana*; *A. Thibautiana*, a species from Borneo; *A. Luciani*, the result of a cross between *A. Thibautiana* and *A. Putzeysi*, and *A. Lindenii*.—W. H. TAPLIN (in *Garden and Forest*).



FRUIT FORCING.

VINES.—Earliest Forced.—Severe frosts and sunless weather are against the early forcing of fruit trees, and necessitate great care in avoiding chills, particularly such as those resulting from injudicious ventilation, or admitting air too freely after a dull, cold period. Supplying borders with cold water also adverse to root action and free growth; therefore, now root action is being excited, encourage it by supplies of tepid water or liquid manure at a temperature not less than the mean of the house nor more than 90°, but not if the soil is already sufficiently moist. If fermenting materials are used do not allow them to decline in heat at this critical stage. It is a good plan to keep a heap of leaves and stable manure in reserve, from which the supply may be drawn as required. Disbud and tie down the shoots before they touch the glass, but do not hurry about that or stopping. In stopping two joints should be left beyond the show of fruit, but three or four are better, as a good spread of foliage aids food absorption and its elaboration, but it is essential that the foliage be well developed, having full exposure to light, avoiding overcrowding. Remove superfluous bunches as soon as the best can be selected, which will assist those retained to form more perfect flowers and set better. Afford a night temperature of 60° to 65°, and 70° to 75° by day artificially as the flowers open, maintaining a rather drier condition of the atmosphere.

Vines in Pots.—As soon as the fruit is set these should be well supplied with liquid manure, and have surface dressings of rich compost, maintaining a moist atmosphere. Let the berries be thinned as soon as they are fairly set, removing the smallest, but remember they usually do not swell so large as those of Vines planted out. Damp the paths two or three times a day, and occasionally with liquid manure, keeping the evaporation troughs charged regularly.

Houses to Afford Ripe Grapes in June.—The Vines that are to supply these should be started at once. The outside border being protected with a thickness of leaves, fern or litter, fermenting materials may be dispensed with, and if wooden shutters or glazed lights are at command for throwing off rain or snow it will be an advantage. Fermenting materials, however, are advantageous in promoting activity at the roots and keeping them near the surface, but soapy cold material is more injurious than beneficial. Supply the inside border thoroughly with water at a temperature of 90°, and economise fuel by the free use of fermenting materials inside the house. Leaves and stable manure in equal parts are better than the latter alone. Damp the house and Vines two or three times a day when the weather is bright, but in dull weather once, or at most twice, a day will be ample. The temperature should be 50° to 55° by artificial means and 65° from sun heat.

Succession Houses.—Vines from which the Grapes have been cut may be pruned now. Cut to a plump bud as near the main stem as possible. There may be two eyes or more, which will cause the spurs in course of time to become long, but it is easy to train up young canes for

displacing any that have the spurs too long. Remove loose bark only, avoiding the peeling and scraping usually practised. Wash the rods with softsoap and water, and then apply, if necessary, an insecticide, avoiding the pigments which leave a deposit on the Vines calculated to interfere with their power of respiration. Remove the surface soil or mulching down to the roots, and add fresh material. Keep the house cool, but if utilised for plants the temperature artificially must not exceed 45°.

Late Houses.—Vinerics in which Grapes are hanging should have a dry atmosphere, with a mean temperature of 45°. Examine every bunch frequently, and remove all decayed berries. Ventilate the house on fine mornings, keeping it closed when the weather is damp. Where late Grapes were ripened comparatively early, and it is desired to start the Vines soon after the middle of February, the Grapes may be cut, the ends of the stems being inserted in bottles of rain water with a small piece of charcoal in each, securing it in an inclined position so as to admit of the fruit hanging clear of the bottles. Any dry room will be a suitable place where an equable temperature of 40° to 45° is maintained. This will admit of the Vines being pruned, the house cleaned, and kept cool and dry to assure a few weeks' rest before starting time.

KITCHEN GARDEN.

THE WEATHER.—It is many years since our vegetable crops have had to contend with such severe weather as that experienced lately. The frost has been excessive, the north wind most cutting. Snow has fallen frequently, and this has afforded some protection; but altogether vegetable crops are in a very unprofitable condition. Broccoli have ceased forming heads. It will take them some weeks to do so after the frost departs, and the plants are very much injured, especially the midwinter varieties. The spring and early summer varieties are better. Winter Spinach has shrivelled greatly, and it will be a long time before it becomes luxuriant; but, judging from past experience, the roots will be sound, and should be retained to give a supply in spring. We are always much troubled with birds in summer, but generally escape them in winter. Only at present the larks are picking the tops of the spring Cabbage, so much that we have had to net them to prevent the whole being destroyed. The root crops under cover are well protected, and are becoming more valuable than ever. Parsnips, Salsafy, and such like under the soil are sound, but a quantity of each have been lifted to meet the demand until the frost ceases. Unfortunately vegetables were not so well ripened last autumn as they always are in a bright warm summer and autumn, and they will consequently suffer all the more. At the proper time in the spring we suggested planting a large quantity of Leeks and Curly Greens as vegetables that would become most valuable in a severe winter or afterwards, and those who acted on this advice will now find the advantage of it.

FORCING.—This will have to receive extra attention. The deficiency of supplies out of doors must be compensated for by extra quantities here. Asparagus, Seakale and Rhubarb will force more readily now than in November, and roots should be lifted and introduced to the forcing quarters. Cucumber pits may be utilised in this way for the next two months, when hotbeds and odd corners everywhere with the necessary amount of heat may be turned to account.

KIDNEY BEANS.—Those showing flower are not likely to bear heavily. They have had little or no sun, and the severe weather is against them, but if scarce now they will be equally valuable in February and March, when the open air vegetables are sure to be scarce, and all who can should sow seed at once. The Ne Plus Ultra type are the best. The long-podded varieties are useless at this time. In April and May they will grow and fruit freely under any condition so long as they have a little heat, but at present they require more care. A good mode of raising the plants is to sow from six to ten seeds in a 3-inch pot, and grow them in these until they are ready for 6 or 7-inch pots. Place a little drainage in the bottom of each small pot, half fill them with a light rich soil. Place the seed on the surface and cover to near the top with more soil. From 100 to 200 pots will afford a useful supply, but where the glass accommodation is extensive double this quantity may be introduced at once. Do not give much water until the young plants appear, as too damp soil may cause the seed to decay. If they are placed in a temperature of from 60° to 70° they will make satisfactory progress. If not overcrowded at any time they will remain dwarf and robust, and when fruited in a light position it is astonishing the quantity of pods each pot of plants will produce.

MUSHROOMS.—Like everything else the Mushrooms have felt the cold. Our open air beds are not very prolific at present, and those in cool sheds are slower in forming than they were a month or more ago. We have none in a heated place, hence our reason for anxiously trying to induce the cool beds to continue bearing. This we have little fear of accomplishing, and our principal aid is to increase the amount of hay or straw covering on the surface, and cover all over with mats or oilcloth. In mild weather a layer 6 inches deep of hay is sufficient, but when the thermometer is below 32° this should be doubled or more, and the whole kept dry. No one should make an excuse that they have not a hothouse as a Mushroom place, and cannot, therefore, grow Mushrooms, as a shed or stable is ample to produce fine crops at all seasons.

SALADING.—Lettuce and Endive are now very scarce. The frost has destroyed all that were exposed, and those in cold frames are somewhat withered. Forced salading must be chiefly depended on.

Lift quantities of Chicory or Witloof roots. Place from eight to a dozen of them in a 10-inch pot, and plunge them in a dark place in a bottom heat of about 80°. They will quickly produce a large head of tender cream-coloured leaves invaluable for winter salad. Sow a quantity of Mustard and Cress weekly according to demand. They may be raised in shallow boxes, and with a temperature of 60° will be ready for cutting in a week.

PROTECTING CELERY.—We have all our Celery covered with bracken which was harvested like hay in September. This is a good protection, but no Celery covering should be taken off too soon after the frost departs, as it is by exposing it too soon then that much of it becomes pulpy and is spoiled.



APIARIAN NOTES.

WHAT GUIDES THE BEE IN FLIGHT?

I PUT the question because I believe the movements of the bee are as yet but imperfectly understood. I am convinced they possess senses unknown to man. They recognise colour, and the position as well as form of their hive, and undoubtedly the odour, but whether it is from the sense of smell I am not prepared to say. Sounds they do recognise. Repeatedly have I brought the bees to the outside by tinkling sounds when about to feed, and the hum at swarming and hiving time cannot fail to strike the most casual observer that it is for the sole purpose of collecting the myriad of bees that form the swarm. Remove a hive a short distance from its original stand; at first the bees fly directly to the original site, then shortly they spread in a seeking direction until one bee finds it, when immediately the hum draws others, until in a short time the whole of the bees are on the right track, the humming increasing as the bees enter. But this is not all; the humming has another purpose to serve than gathering the swarm. If that hum is raised by any other means the hive may be removed without fear of any of the bees returning if it should be but a few yards. In order to prevent fighting and loss of bees when setting bees at the Heather the skill of the bee-keeper is sometimes sorely taxed. To lead the bees to their proper hive coloured devices properly arranged are the best means to adopt, but the bees must have been accustomed to them at home. It may be safely said that sight is the sense that guides the bee in that respect.

But again in an open space. If a row of hives is extended by new ones being placed alongside the bees of the first set ones become puzzled, and for a time enter the other hives, which strikes one forcibly that it is not sight alone that guides the bee. Think over it as I may can discern no difference in this trait of the bee from that in blind persons. Often have I when accompanying a blind person caused him to deviate from his course by similarly obstructing him, and have known the same individual wander when there was a mist or a fall of snow which prevented his "seeing where to go."

When a hive is so placed that the light of day is upon it the bee flies directly to the entrance; but place it in a dark retreat some distance from the light, the bees will only fly as far as the light penetrates, creeping towards the hive through the darkness without error. But remove what has obscured the hive, and the bees will for a time be puzzled to reach the hive. In this instance something more than sight has been at work guiding the bees. It would be easy for me to go over a great many interesting cases of bees being puzzled and the methods they took to find their home, which were always in a uniform manner, as regular as is performed in all the internal economy of the hive, but limited space forbids detailing at present. I have at various times expressed my opinion of the magnetic influence in bees, and the more I think of it the more I am convinced that it has much to do with the guidance of the bee in her aerial flights as well as inside the hive. I have seen a number of hives in the centre of a clump of trees which were removed before the bees were aware, and yet I could not observe

any movement in the bees to indicate they felt or heeded the change. In this case had it been by mark they distinguished their site why did they not fly towards the next clump of trees almost similar to the one felled? The plan of sticking a branch of a tree in the ground near a hive for a mark to the bees would have not been heeded by those mentioned above, nor do I believe any bees would.

Some writers affirm that bees always fly to their gathering ground against the wind, so that on the homeward journey the wind helps them home more easily with their load; besides that, bees can only detect the presence of honey in the flower when the wind blows towards their hives, theoretically meaning that the bees will never seek honey in the opposite direction from that which the wind blows! A great mistake. I could give many instances disproving that theory, but will content myself in giving one instance which occurred this year.

The day on which we took our bees to the Heather a strong east wind was blowing. Immediately the bees were let loose many of them flew direct west ahead of the wind, and in a few minutes they were observed at a distance of two miles in thousands working upon the Wild Thyme, and had to return home against the strong east wind.

Now, if the odour of anything can only be detected by the sense of smell with the wind, how was it that the bees went in the opposite direction? There are many things connected with bees and bee-keeping difficult of explanation, but if it is true that no odour is carried against the wind, then it cannot be said that it is the sense of smell that attracts the bees to the honey-yielding flower so far from the bees ahead of the wind. Odours reach the nostrils of man when the wind carries it towards him, but the bee appears to have greatly developed senses man knows nothing about. Just as the compass points to the north, so as unerringly do bees fly to the honey-yielding flowers, whether the wind is with or against them, no matter what the direction may be.

Nor is this all. The rapidity with which bees raise the heat, and to such a degree, without an additional consumption of food, is something astonishing, and points directly to that of electricity being the direct cause, and what else is it that directs the bees to their duties immediately one or more quit them? Will someone answer these queries to the satisfaction of more than—A LANARKSHIRE BEE-KEEPER.



All correspondence should be directed either to "THE EDITOR" or to "THE PUBLISHER." Letters addressed to Dr. Hogg or members of the staff often remain unopened unavoidably. We request that no one will write privately to any of our correspondents, as doing so subjects them to unjustifiable trouble and expense.

Correspondents should not mix up on the same sheet questions relating to Gardening and those on Bee subjects, and should never send more than two or three questions at once. All articles intended for insertion should be written on one side of the paper only. We cannot reply to questions through the post, and we do not undertake to return rejected communications.

Gardeners' "Providential" Society.—(J. Russell).—Perhaps the address you require is Mr. W. Collins, 9, Martindale Road, Balham, London, S.W.

Chrysanthemum Bloom.—We have received from the postal authorities a crushed and withered Chrysanthemum bloom which must have escaped from some parcel. The bloom appears to resemble Boule d'Or, but we have no letter pertaining to it, nor anything to indicate the district from which it was sent.

Missing Parcel (Wakefield).—We have received a direction label that has become detached from some parcel in the post office which has not reached us, and will probably never be delivered. This is only one of several instances of the same kind that have occurred from time to time, but the post mark is not clear on some of the labels, and therefore we cannot usefully make any reference to them.

Gardening Appointment (H. H.).—Through your mistake in the first instance and subsequent delay in writing, the notification can no longer be regarded as "news" suitable for publication.

Lilliums for Exhibition (An Old Subscriber).—The most useful for your purpose would be the varieties of *Lilium speciosum* (*lancifolium*), of which several distinct forms are now included in nurserymen's collections. The varieties *album*, *rubrum*, and *punctatum* are well marked. *L. auratum* could be grown for the same purpose, the varieties *virginale*, *platyphyllum*, and *rubro-vittatum* being very handsome both as regards size and form of the flowers.

Planting Passiflora (Mum).—A good time for planting a *Passiflora* is when spring growth commences. If your Vine border is outside and you wish to train the plant outside too, as your letter suggests but does not explain, only a hardy species or variety will be suitable, and it will probably require the protection of a mat during winter in your district. If the plant is to be brought inside similar to Vines the outside stem must be well protected with haybands or something equally suitable for preserving it from frost.

Border Carnations and Picotees (Hull).—Strong plants obtained in pots and planted as soon as the weather is favourable, towards the end of March or early in April, produce the finest of flowers the first season, and then in such abundance as to need thinning, or the buds do when swelling. The best growers of Carnations raise young plants annually, and seldom rely on them for flowering a second season; but, as above stated, they are stout and sturdy to begin with; small and so-called cheap plants, with one spindly stem and no side growths, being of little use. The "best" varieties is a question of taste, many persons preferring self colours in border Carnations to the variegated forms. Good selfs are W. P. Milner, white; Rose Celestial, rose; Celia, pink; Belle Halliday, yellow; Purple Emperor, and Scarlet Gem. Variegated—Robert Lord, Rifleman, Matador, James Douglas, John Keet, and Sarah Payne. Picotees—J. B. Bryant, Mrs. Payne, Mrs. Chancellor, Mrs. Gorton, Favourite, and Clara Penson. While those are good you had better leave some latitude to the nurseryman, stipulating for strong plants, as there are plenty of other good varieties which he may be able to substitute in the form of better plants than some of those you may order.

Eucalyptus globulus (F. J.).—We have seen many trees from 15 feet to 20 feet high in Surrey after a series of mild winters, but they have all succumbed to the first severe and prolonged frost, such as we are now experiencing. "Whether there are any trees now growing in any part of England without protection" is an open question for those of our readers to answer who may be in a position to do so. We can say generally that the tree in question is not hardy in this country. In Vol. xxxvii., New Series, *Journal of Horticulture*, page 151, the issue of August 21st, 1890, a flowering spray is figured from a tree in Guernsey, but we do not know whether the tree is still alive or not. We have also figured a flowering spray of *Eucalyptus coccifera* from the pleasure grounds of Powderham Castle.

Young Vines (H. P.).—The samples of canes and laterals are very good, showing that there has been no mistake in your management. We do not see how we can make any reference to those not pruned, as they are not numbered, nor does there appear any necessity, as the pruned cane is fairly representative of the whole. It is pruned correctly, and you may expect that all similar buds on equally good wood will produce fruit-bearing laterals in the spring, always provided the buds break uniformly, and there is no reason why they should not do so with the good attention we apprehend you are well capable of giving. Vines growing in a good border will support two rods as well as one so long as there is ample space for the development of the foliage. You must guard against overcrowding the laterals by disbudding to the extent desired. We think you may safely allow each cane to carry two bunches, not necessarily retaining the largest, but giving preference to those on the strongest laterals. Bunches weighing from 1 lb. to 1½ lb. each would be more satisfactory than those of twice that weight, both in the quality of the fruit and the interest of the Vines.

Fruit for Market (South Devon).—If the soil and district are well adapted for fruit culture, and the trees are well managed, also the fruit well marketed, the amount you name ought to be realised in seven years after planting. It has been considerably exceeded this year in more than one instance well known to us six years after planting, but the variety you name, good as it is, was not the most profitable. We do not think many persons would rely on one variety of Apple in planting three hundred trees. Some of the early Apples are quite as profitable as the late, sending them direct from the trees to the market, because, as a rule, the former afford good crops of fruit sooner than do the midwinter and spring sorts. Nor is it wise to rely on one variety of Gooseberry, and good as the one you name may be, it is not found the most profitable by one of the largest growers of this fruit; but as his best (Crown Bob) might not be the best with you, and we know is not the most profitable in some districts, we do not

advise you to substitute it, but only suggest the risk of a failure by putting all your eggs into one basket. If you have not perused the Essay of the Fruiterers' Company you might do worse than send 1s. 3d. to this office for a copy, and you will find short and good lists of the most profitable varieties of fruit for planting, besides a good deal of useful cultural information.

The Neilgherry Lily (*T. O.*).—The botanical name of this Lily is *Lilium neilgherrense*. It belongs to the longiflorum type, but flowers in the autumn. It is a noble Lily, with very large buff trumpet-shaped flowers. It is grown in the same way as *L. auratum*, either in pots or planted out. It is believed to be quite hardy, and has been flowered by the late Mr. James McIntosh in the open ground in his garden in Surrey.

Perpetual or Spinach Beet (*S. T.*).—The following note was published, and it is to that you probably refer. "The Perpetual is not considered so good flavoured as the ordinary Spinach, but if a little extra attention is paid to the cooking it would go unnoticed at the table by many of the less keen judges. It appears strange that such an easily grown plant should be so little known amongst gardeners, as many have exclaimed when passing through the garden here, 'What is that you have there?' when the reply given was Spinach Beet. Here Spinach is most appreciated in early spring and in the autumn and winter. When other choice vegetables are plentiful in summer Spinach is overlooked; that is to our advantage, as the ordinary varieties behave very indifferently on our soil, and I have known the same to be the case in other gardens. It is common in many places to see this vegetable assuming wonderful size, requiring much thinning to do it justice, but it is not so with us. We have tried artificial manures, lime, salt, wood ashes, soot, horse and cow manures, but all to no purpose in obtaining a luxuriant crop of Spinach. In future it is our intention to sow the round variety for early spring crops, and the Perpetual for autumn and winter supplies. Our seed of the latter variety was sown from the second week in May to the middle of June, and we could have picked all the summer had the demand rendered it necessary. When this variety is grown strongly the stems can be cooked and used like Seakale; but I have only known it used as such in one or two instances, yet I see no reason why it should not become an established rule."

Making Vine Borders in Natural Soil (*A. A. B.*).—Your soil being light and shallow on a gravel bottom, which we presume is free from water lodging within several feet of the surface, would be best improved permanently by a dressing of clay marl, a cartload per rod (30 1/2 square yards), mixed with the top 2 feet of soil, having it in finely divided parts, and incorporated evenly through the soil. It would render it more retentive of moisture, therefore saving labour in watering, and at the same time keeping manurial matters from being so freely washed out of the soil, in that sense increasing their value considerably. The chalk you have will act similarly in conserving moisture, but it is one of the greatest wasters of ammonia, the carbonate of lime causing ammonia to escape into the atmosphere. Nitrogenous manures, however, can be used in small quantities as top dressings without much loss, and for soil that contains more than 10 per cent. of lime nitrate of soda is the nitrogenous manure to be used. You may employ the chalk at the rate of a cartload per rod, mixing it with the soil as advised for clay marl. Chalk is better than fresh lime in your case, and will to some extent make the soil closer, but not more so than lime, which on light soils is of a binding nature, whereas on heavy soils it acts in an opposite manner, making them more open. For the quarter of an acre you may use the full quantity named or forty cartloads. It will do good rather than otherwise to the Tomatoes. The burnt rubbish is an excellent dressing for light soils, and besides its value as manure is a binder as well as a great absorber and retainer of moisture. Mixed with the loam it may be used on the surface, pointing it in lightly. The old mortar rubbish may be treated in a similar manner. We should use all the staple materials as a rooting medium, reserving the bonemeal and potash for surface dressings, not wasting any money in half-inch bones. What is wanted is a medium into which the roots can push and form abundantly, then supply food to the Vines. The bonemeal and muriate of potash may be mixed with the soil, but in your soil manures that act quickly would be best, such as superphosphate of lime and muriate of potash. Use them in the proportion of 5 lbs. superphosphate and 3 lbs. muriate mixed, applying at the rate of 4 ozs. per square yard. Steamed bonemeal and kainit are excellent for light soils; 3 ozs. of steamed bonemeal and 1 oz. of kainit is a proper dressing per square yard.

Names of Fruits.—The names and addresses of senders of fruit to be named must in all cases be enclosed with the specimens, whether letters referring to the fruit are sent by post or not. The names are not necessarily required for publication, initials sufficing for that. Only six specimens can be named at once, and any beyond that number cannot be preserved. (*E. H.*).—Beurré d'Artemberg, a free and good midwinter Pear. It is sometimes confused with Glou Morceau, but they are perfectly distinct, the former being mottled and the stalk obliquely inserted, the latter comparatively clear and the stalk straight. (*S. D.*).—1, Napoleon; 2, Beurré Diel; 3, Nec plus Meuris. The Apple is Wyken Pippin.

Names of Plants.—We only undertake to name species of plants, not varieties that have originated from seed and termed florists' flowers. Flowering specimens are necessary of flowering plants, and Fern fronds should bear spores. Specimens should arrive in a fresh state in firm boxes.

Slightly damp moss, soft green grass or leaves form the best packing, dry wool the worst. Not more than six specimens can be named at once, and the numbers should be visible without untying the ligatures, it being often difficult to separate them when the paper is damp. (*T. B.*).—1, *Brainea insignis*; 2, *Cyathea dealbata*; 3, *Anemia collina*; 4, *Adiantum decorum*; 5, *Hypolepis distans*. (*M. O.*).—1, *Zygopetalum maxillare*; 2, *Zygopetalum erinitum*.

TRADE CATALOGUES RECEIVED.

- Robert Sydenham, Tenby Street, Birmingham.—*List of Vegetable and Flower Seeds.*
- C. Sahut, Montpellier.—*List of Fruit Trees and Shrubs.*
- Dicksons, Chester.—*Catalogue of Vegetable and Flower Seeds.*
- Ireland & Thomson, 81, Princes Street, Edinburgh.—*Catalogue of Vegetable and Flower Seeds.*
- Harrison & Son, Leicester.—*Annual Catalogue, 1891.*
- John Walker, 7 and 8, High Street, Thame, Oxon.—*Catalogue of Garden and Flower Seeds.*
- C. Fidler, Reading.—*Catalogue of Seeds and Potatoes.*
- Stuart & Mein, Kelso.—*Amateurs' Gardening Guide, 1891.*
- Robert Veitch & Son, Exeter.—*Catalogue of Kitchen Garden and Flower Seeds.*
- Armitage Brothers, High Street, Nottingham.—*Seed Catalogue.*
- Diekson, Brown, & Tait, 43 and 45, Corporation Street, Manchester.—*Catalogue of Vegetable and Flower Seeds.*
- Charles Sharpe & Co., Sleaford.—*Illustrated Catalogue of Garden and Flower Seeds.*
- Thomas Laxton, Bedford.—*List of Seeds, Potatoes, &c.*

COVENT GARDEN MARKET.—DECEMBER 31ST.

No alteration in prices. Business somewhat better. Hothouse goods in fair supply

FRUIT.

	s.	d.	s.	d.		s.	d.	s.	d.	
Apples, 1/2 sieve	1	6	to	6	0	Lemons, case	29	0	to 28	0
" Nova Scotia and						Melons, each	1	0	2	0
Canada, per barrel	15	0	25	0	0	Oranges, per 100 ..	4	0	9	0
Grapes, per lb.	0	9	3	0	0	St. Michael Pines, each..	2	0	6	0
Kentish Cobs	65	0	70	0	0	Strawberries, per lb. ..	0	0	0	0

VEGETABLES.

	s.	d.	s.	d.		s.	d.	s.	d.	
Artichokes, dozen	0	0	to	0	0	Mushrooms, punnet ..	1	6	to 2	0
Beans, Kidney, per lb. ..	0	6	0	0	0	Mustard & Cress, punnet	0	2	0	0
Beet, Red, dozen	1	0	0	0	0	Onions, bushel	3	0	4	0
Brussels Sprouts, 1/2 sieve	1	9	2	0	0	Parsley, dozen bunches	2	0	3	0
Cabbage, dozen	1	6	0	0	0	Parsnips, dozen	1	0	0	0
Carrots, bunch	0	4	0	0	0	Potatoes, per cwt.	3	0	4	0
Cauliflowers, dozen	2	0	4	0	0	Rhubarb, bundle	0	2	0	0
Celery, bundle	1	0	1	3	0	Salsafy, bundle	1	0	1	6
Coleworts, doz. bunches	2	0	4	0	0	Scorzoneria, bundle ..	1	6	0	0
Cucumbers, doz.	2	0	3	6	0	Seakale, per bkt.	2	0	2	6
Endive, dozen	1	0	0	0	0	Shallots, per lb.	0	3	0	0
Herbs, bunch	0	2	0	0	0	Spinach, bushel	1	0	2	0
Leeks, bunch	0	2	0	0	0	Tomatoes, per lb.	0	4	0	8
Lettuce, dozen	0	9	1	3	0	Turnips, bunch	0	0	0	4

CUT FLOWERS.

	s.	d.	s.	d.		s.	d.	s.	d.	
Arum Lilies, 12 blooms ..	4	0	to	8	0	Mimosa (Fuch.,) per bnch	0	9	to 1	0
Bouvardias, bunch	0	6	1	0	0	Narciss (Paper - white),				
Carnations, 12 blooms ..	1	0	2	0	0	French, doz. bunches ..	4	0	10	0
Chrysanthemum, 12 blms.	1	0	3	0	0	Do. Do. English,				
" 12 bunches	3	0	9	0	0	per bunch	1	0	1	6
Epiphyllum, doz. blooms	0	4	0	6	0	Pelargoniums, 12 trusses	1	0	1	6
Eucharis, dozen	3	0	6	0	0	" scarlet, 12 bnchs	4	0	6	0
Gardenias, 12 blooms ..	6	0	9	0	0	Poinsettia, dozen blooms	4	0	9	0
Hyacinthus (Roman), doz.						Primula (double) 12 sprays	0	6	1	0
sprays	0	6	1	3	0	Roses (indoor), dozen ..	0	6	1	6
Lapageria, 12 blooms ..	2	0	4	0	0	" Red, 12 blooms ..	1	0	2	0
Lilac (French) per bunch	5	0	7	6	0	" Tea, white, dozen ..	1	0	3	0
" longiflorum, 12 blms.	4	0	6	0	0	" Yellow	3	0	5	0
Lily of the Valley, dozen						Tuberose, 12 blooms ..	0	4	0	9
sprays	3	0	6	0	0	Tulips, per dozen	1	0	2	0
Maidenhair Fern, dozen						Violets (Parme)	3	0	4	6
bunches	4	0	9	0	0	" (dark)	1	6	2	6
Marguerites, 12 bunches	2	0	6	0	0	" (English), doz. bnch	1	0	2	0
Mignonette, 12 bunches..	3	0	6	0	0	Wallflower, doz. bunches	3	0	6	0

PLANTS IN POTS.

	s.	d.	s.	d.		s.	d.	s.	d.	
Aralia Sieboldi, dozen ..	6	0	to	12	0	Hydrangea, doz. pots ..	9	0	to 18	0
Arbor Vitæ (golden) doz.	6	0	8	0	0	Lilium lancifolium, doz.	0	0	0	0
Chrysanthemum, per doz.	6	0	24	0	0	" longiflorum, doz.	0	0	0	0
Climbing Plants, various,						Lily of the Valley, per pot	4	0	6	0
dozen pots	4	0	9	0	0	Lobelia, per doz.	0	0	0	0
Dracæna terminalis, doz.	24	0	42	0	0	Marguerite Daisy, doz.	6	0	12	0
" viridis, dozen ..	12	0	24	0	0	Mignonette, per dozen ..	4	0	6	0
Epiphyllum, per dozen ..	12	0	30	0	0	Musk, per dozen	0	0	0	0
Erica, various, dozen ..	12	0	18	0	0	Myrtles, dozen	6	0	12	0
Euonymus, var., dozen ..	6	0	18	0	0	Nasturtium, dozen pots	0	0	0	0
Evergreens, in var., dozen	6	0	24	0	0	Palms, in var., each ..	2	6	21	0
Ferns, in variety, dozen..	4	0	18	0	0	Pelargoniums, per doz. ..	0	0	0	0
Ficus elastica, each ..	1	6	7	0	0	Poinsettia, per doz. ..	9	0	15	0
Foliage plants, var., each	2	0	19	0	0	Rhodanthe, per dozen ..	0	0	0	0
Fuchsia, per doz.	0	0	0	0	0	Stocks, per doz.	0	0	0	0
Geraniums Scarlet, p. doz.	2	0	6	0	0	Tropæolum, various, per				
Hyacinths (Roman), doz.						dozen	0	0	0	0
pots	8	0	10	0	0	Tulips, dozen pots	8	0	12	0



PRIZE ROOT CROPS.

THIS is certainly a suitable subject for our first article in the New Year, pointing as it does to that desire to excel which should enter into plans now being made for another twelve months' span of time. That roots are an expensive crop is true enough, but we can assure our correspondent "H. R. W." that his desire to win a prize or two regardless of cost need not involve an unprofitable outlay, and before entering upon cultural details it may be well to see something of the cost of growing an acre of Mangolds.

A recent computation has shown the entire cost involved for tillage, seed, manure, and every process of cultivation, inclusive of the final clearance and clamping of the crop, as well as rent, rates, and taxes, of an ordinary crop is about £8. If to this we add another £4 for the additional manure required for the production of a crop suitable for a prize competition, we have a total of £12 as the maximum cost of the crop per acre. As tending to show what may be done by the use of good seed in conjunction with high culture we quote from a report of Messrs. Webb's recent root competition. "Crops of 63 tons per acre, grown by Mr. J. Harvey, Darlaston Grange, Stone; 58 tons 10 cwt., by Mr. J. W. Pocock, Twigworth Farm, Gloucester; 54 tons 8 cwt., by Mr. R. Smith, High Bank, Spalding; and 36 tons 1 cwt., by Mr. T. Almack, North Milford Grange, Tadcaster," which shows an average of 53 tons per acre, even with Mr. Almack's comparatively small crop, small be it remembered by comparison with those grown in a more southern climate, but undoubtedly large for Yorkshire.

Of Swedes grown for the same competition, the first prize crops in different localities were 41 tons 17 cwt. per acre, by Mr. J. Harvey of Stone; 39 tons 10 cwt., by Mr. W. H. Evans, Radyr Court, Cardiff; 37 tons 4 cwt., by Mr. A. Callwood of Northfield, Birmingham; 44 tons 2 cwt., by Mr. J. Trickett, The Moss, Sandiway, or an average of about 40 tons per acre, the average of more northern districts being about 33 tons per acre.

Under ordinary circumstances land coming in due rotation for roots is low in fertility, and more or less foul with such weed pests as Couch Grass, Charlock, Coltsfoot, Thistles, and Docks; its cultivation for the crop is termed a half fallow, and a crop suitable for a prize competition can hardly be expected from such land. We mention this by way of precaution as a thing to avoid. After the recent exceptionally fine autumn there ought to be plenty of clear land on every farm, we would choose some of this that is fairly rich in fertility, and preferably that which is now in ridges for the winter. This, however, is not imperative, and it may be best to assume that "H. R. W." has a field that was cleared and ploughed in autumn, and so left in readiness for spring cultivation. As soon as the soil is dry enough next March, it should be stirred with a duck-foot harrow, or light cultivator, across the furrows, and then thrown into ridges 26 inches apart with a double-breasted plough, and the furrows half filled with rich farmyard manure. Then sow broadcast over the ridges and farmyard manure a mixture of chemical manure, consisting per acre of 1 cwt. muriate of potash, 2 cwt. nitrate of soda, 2 cwt. steamed bone flour, 1 cwt. superphosphate, and 4 cwt. common salt. Let the double-breasted plough follow at once to split the ridges so as to turn back the soil over the manure, and then the new ridges so formed will be ready for the seed. Arrange the work so as to have the manure of both sorts on the land by the last week in March, not sooner, and then sow the Mangold seed early in April. To be quite safe use 8 lbs. of seed per acre, pressing the tops of the ridges before and after the seed drill with a light Barley roller, and drilling in the seed along the top of each ridge right over the farmyard

manure, in view of having the roots of the young Mangold plants established in it as quickly as possible, in order that there may be no check to the growth from drought, a matter of vital importance, having much influence upon the final result.

Annual weeds are certain to spring up more or less thickly with the Mangold plant, and the horse hoe must be at work between the rows quickly after they appear, and again from time to time till the spreading leaves of the Mangold crop render it impossible to use horses among them. Hand hoeing must be done close to and among the rows for keeping down weeds and chopping out plants before the singling is done by hand. Pay no heed to any rule about the number of times to hoe, but see that weeds are kept under altogether, so that the legitimate crop may have full benefit from the manure. The tillage, manure, early sowing, careful singling, and persistent hoeing are each and all indispensable to ensure a full crop of at least forty tons. The plants should be 18 inches apart in the rows.

The culture for Swedes is precisely similar to that for Mangolds, only the sowing should be a fortnight later, and the chemical manure mixture should consist of 1 cwt. muriate of potash, 1½ cwt. nitrate of soda, 2½ cwt. steamed bone flour, and 2½ cwt. mineral superphosphate, with plenty of rich farmyard manure.

WORK ON THE HOME FARM.

Frost and snow have brought work on the land into a very narrow compass, carting and draining being about the sum total of what can be done now. The value of a well arranged lambing yard will certainly be felt this season, but an ordinary fold can be made very snug indeed by means of an unlimited supply of straw and hurdles. See that the shepherd has also ample supplies of pea and oat straw, chaff, crushed oats, bran, and mangold delivered to him at the fold, and avoid taking him away from the flock at all now to procure such things. If he is to care for his charge in the right way he must have such assistance. See also that no lambs run any risk from exposure to cold cutting winds. Shelter and nourishing food must be had if we would save the lambs and rear them in lusty condition. Better be without a flock at all than to neglect it in any way, and we certainly consider it negligence to leave pregnant ewes to pick up a scanty subsistence on pasture, and to fall off so much in condition as to seriously affect the health of the lambs.

Where cream of more than ordinary richness is cared for some addition may now be made to the cows' food with material advantage. A change of food is always desirable, and a mixed dietary invariably answers best. We shall now begin to use Mangolds sliced or minced for the cows, and the mixed food consists of bran, crushed oats, decorticated cotton cake, and Smith's palm nut meal in equal parts, 3 lbs. of the mixture being given twice daily at milking time. The bulk of the cows' food continues to be the best meadow hay throughout winter, and to those of our readers who have hitherto been content to give only a very moderate quantity of hay, and have not kept in the cows off the pasture, we say, try the effect of the mixed food, with a full allowance of hay, and thorough shelter in the form of a clean littered shed or hovel. Note carefully the result, and we are very confident you will have reason to feel pleasure in having followed our advice. It is easy enough to have rich milk at midsummer, but it is not so easy to have it in midwinter, but it is quite possible, and, too, the extra outlay for food is well repaid by the superior milk yield which so quickly follows the regular use of it. Remember, also, that thorough shelter is, in its way, actually nourishing to the cows, as it prevents that exhaustion arising from exposure which has to be made good by food.

METEOROLOGICAL OBSERVATIONS.

CAMDEN SQUARE, LONDON.
Lat. 51° 32' 40" N.; Long. 0° 8' 0" W.; Altitude, 111 feet.

DATE.	9 A.M.					IN THE DAY.				Rain
	Barometer at 32° and Sea Level.	Hygrometer.		Direction of Wind.	Temp. of soil at 1 foot.	Shade Temperature.		Radiation Temperature.		
		Dry.	Wet.			Max.	Min.	In sun.	On grass.	
1890. December.	Inches.	deg.	deg.	F.N.E.	deg.	deg.	deg.	deg.	In.	
Sunday	30.309	33.2	32.4	F.N.E.	34.1	36.2	21.4	41.2	23.4*	
Monday	30.338	17.2	16.6	N.E.	34.0	28.6	14.9	29.1	5.6	
Tuesday	30.051	28.4	28.3	S.E.	33.9	31.9	15.7	31.9	5.5	
Wednesday	30.335	28.9	28.8	E.	33.9	33.0	23.0	36.0	27.8	
Thursday	30.353	26.6	26.1	S.W.	34.0	31.2	21.6	31.7	14.9	
Friday	30.347	30.3	30.2	S.E.	33.8	36.2	23.2	39.8	14.3	
Saturday	30.333	31.6	30.6	N.E.	33.9	33.4	29.4	38.2	24.0	
	30.301	28.0	27.6		33.9	32.9	22.8	35.4	16.8	

* Covered by fresh snow.

REMARKS.

21st.—Overcast morning and thaw; fair afternoon; cold clear night.
22nd.—Severe frost; fog all day, rather dense in the evening.
23rd.—Gloomy throughout, with fog at times. 24th.—Overcast, but free from fog.
25th.—Fine, with an hour's sunshine at midday. 26th.—Overcast all day.
27th.—Fine early; occasional sprinkles of snow in morning, and a slight fall in afternoon and evening.
Another exceptionally cold week, the most remarkable feature of the frost being its duration, for on Christmas Day, 1830 and January 4th, 1837, the temperature fell to 67°, while the lowest recorded this month is 14°.—G. J. SYMONS.



THE BEGINNING.

ON the principle that the looker-on is said to see most of the game, I may perhaps be allowed to refer to a few things which arrested my attention in the new year's issue of the *Journal of Horticulture*. The idea which moved me to make this attempt followed on the remark of a no mean judge of gardening and journalism. The observation was not intended for publication; indeed, not intended for me to hear, for it was just the "thinking aloud" of the reader who had been scanning the pages, and on closing the number put his thoughts into these words, "Not a bad beginning auyhow."

The "anyhow" in the sentence may possibly be considered a superfluity, one of the Americanisms I am told that are becoming established among us, and which do not add either precision, dignity, or euphony to the mother tongue. I feel, however, that I ought to reproduce the remark with fidelity. It induced me probably to read the several articles more carefully than I might otherwise have done, and on concluding I was impelled in a sort of unconscious way to almost repeat the verdict, for my opinion was condensed in the formula, "A good beginning decidedly." This is the old English style, and I like it better than that of my friend who had been in the "States." The word "anyhow" that forms a tag to so many sentences in these latter days is to me unmeaning, and sounds half apologetic, but there is nothing hesitating in the homely substitute "decidedly," for it gives emphasis to the expression. Let me say I am an advocate of good workmanship in everything, including the literature of horticulture. Even a clumsy man enjoys the finished work of experts. Dabblers in paint crowd to admire the works of the "masters" at the Academy, and the most unaccomplished growers of plants, fruits, and vegetables rejoice over the superior productions at horticultural shows, thus we may hope, becoming inspired to strive for equal skill in the noble work of cultivation.

We admire bravery and endurance on the part of those who succeed in great enterprises, and also in those who fail after strenuous endeavour, even if engaged in war and making the world poorer by the waste of life and wealth. I am not disposed to quarrel with that, but I do think that those who engage in work that beautifies and enriches the world by their intellects and hands, as in gardening, are not estimated by the world at their proper value. Writing not as a gardener or a *littérateur*, but as a simple member of the community—a looker-on at the work of others—I feel sure we cannot hold in too high esteem those who co-operate in producing such a good beginning as is made by the *Journal of Horticulture* in the year 1891. Their influence for good is greater than they imagine. They afford pleasure and disseminate instruction, also encourage and stimulate those who engage in gardening as a vocation or as a delightful pursuit, and incite others to do the same. Thus is the world made better and homes brighter, and all who labour to that end are benefactors of the nation.

A short time ago a correspondent appeared to be wishing for a return of past times and old writers. It so happens that at least two of the "ancients" had a share in the "beginning" of another year's work in the pages which they have so long enriched. It is gratifying to observe their brisk vitality, for one of them looks "hopefully forward," closing with cheery wishes; and the other

grumbles like a young boy, yet so pleasantly that he makes himself as enjoyable as if he were singing praises of satisfaction. By the way, a little rivalry almost seems to exist between the two veterans, for claims have been advanced either by or for both to the honour of being the "oldest contributor" to the *Cottage Gardener*, which developed into present form, and extended its title accordingly. Would it not be interesting if the dates could be given when the first contributions appeared from them for establishing the position of priority? The long labours of both in their respective spheres as clergyman and gardener—both being alike zealous as horticulturists—show how conducive is the occupation of gardening to health of body and mind. Statistics tell us that clergymen head the list in longevity, and that gardeners come next in the several professions and vocations under which the community is grouped, and I am sure all must rejoice that two such excellent types of these are so intimately connected with the *Journal of Horticulture*. While the writings of the young are fresh and welcome, and the optimism of enthusiasts stimulating to thought and effort, the weight that is imparted by long experience steadies the ship, contributing, as it were, to her stability and safety. This, after all, is the great desideratum. Express races to the north and "greyhound rushes" across the Atlantic excite for the time, but the common sense of the public asserts itself, and is guided to a conclusion by the reasoning of experienced men of sober minds.

"D., Deal," in his article last week, makes well timed reference to the subject of fruit culture, and utters words of wisdom in connection therewith. "If growers do not expect unreasonable things the proper cultivation of approved hardy fruits cannot but be of benefit to growers and the good of the community." The words "proper" and "approved" in that sentence cannot be kept too well in mind, because there can scarcely be a doubt that thousands of trees have been planted which will yield, as many have already done, little beyond disappointment. Persons of limited means and no cultural experience have been induced to "expect unreasonable things" in the form of great and certain profits arising from fruit culture, and invested their stored earnings in it. Others have relinquished permanent positions and situations and embarked in the same enterprise in the race for wealth. They did not foresee the difficulties in which they have found themselves, and from which they are struggling to be free. The barren fruit year of 1890 will have been a boon to many if it puts a "wholesome check on extravagant expectations," which have undoubtedly been too largely indulged in. It is only by the exercise of the soundest of judgment both in the choice of varieties and soil, coupled with practical knowledge, or working under the guidance of experienced men, that the hopes of planters of fruit trees can be realised, and the less "extravagant" these hopes are the greater will be the satisfaction.

Every home with suitable land attached should be supplied with home grown fruit as far as the seasons permit, and the better the surplus the more acceptable it will be to the landless; but this home culture should be regarded as an "extra" to other means of livelihood, not as a substitute for them, or at least till actual experience and adequate resources justify the extension. The public has been misled by false statements on the subject of fruit, the maximum profits arising from an exceptional crop grown under special circumstances having been dangled before the world as every year attainable by all who plant trees. Nothing can be more utterly, and it may be said cruelly, false than that, as many have found, and some too late, by the experience of the past year. The better the varieties and the healthier the trees the more valuable will the crop of necessity be, and therefore all reasonable endeavour should be made to prepare for their production, but the best of fruit trees grown by the most competent of men were barren last year, and will be again when the climate again proves master. The rich and the competent can take care of themselves, but the comparative poor and quite inexperienced in the work should be told of the

risk they incur in investing too freely in fruit culture as a means of livelihood.

Fruit culture as a home pursuit in which persons can afford to indulge, apart from deriving profit therefrom, is very delightful, and especially when the results are so satisfactory as described by "A Herefordshire Incumbent." It is apparent from the communication of this gentleman that he is an expert cultivator, and his remarks on soil improvement in texture and fertility, also in the important matter of cleanliness of the growths from the first, are worthy of the most attentive consideration. He tells us he is his own "head gardener," and it would be well if all men who are included in that honourable category acted on the same intelligent lines, for if they did there would certainly be less failures with Peaches on walls, while Apples and Pears would be finer.

Mr. Baillie's paper on fruit production is altogether excellent. He wishes to encourage the extended use of fruit as food, and judging by his remarks, as well as by his "noble presence," it is not conceivable that anyone can act more effectually in the matter than himself. When the supply of fruit is improved and cheapened, or in other words when fruit of the best quality can be obtained at the current prices of the untempting and inferior, then will fruit have a larger share in the diet of the nation, and children especially will not be debarred from an adequate supply of what their instinct suggests to us is, to a large extent, their natural food. Nor need what is sure to come—the cheapening of fruit—frighten planters; for though all men may not know it, it is all the same true that the cost of growing fruit of the first quality is less than that incurred in growing trash, of which the rind, core, and seed form the greater part, the juicy flesh the least. Improvement and cheapening of supplies is the first condition for extending the use of fruit as food. This Mr. Baillie knows very well, and also knows that the fruit he longs for in abundance cannot be grown by anyone and anywhere. He does not mislead; sounder doctrine was never taught than this. "In growing fruit there must be due provision of intelligent labour, directed by skilful supervision. In newly formed gardens and orchards, planted with young trees, judicious planning in the arrangement, and careful regard to right principles in the execution of the work as it progresses, and to the trees as they grow, are essential, otherwise a waste of land, time, and labour will readily result." Teaching such as that cannot be too widely disseminated. It is the truth in a nutshell. Go on, Mr. Baillie, in your beneficent crusade, and if you lead to a fiftyfold increase in the consumption of fruit as food you will deserve well of your country.

I had intended alluding to other matters that impressed me in reading the New Year's number, and which I marked for the purpose, but I must not trespass unduly, as I am conscious that better men are at work, and I have no right to press my claims on space that they can occupy more usefully. For instance, I had margined Mr. Bardney's article on "Continuous Potting," as plants need it in winter with—"Yes, conditions being favourable, and the attendants capable of exercising sound judgment in the application of water." Nurserymen and their responsible foremen have told me, in answer to inquiries on the subject, that very few men indeed who enter nurseries for awaiting situations can be trusted to water valuable plants, and especially those recently repotted. Watering plants appears to be a very simple matter, but I am assured it is not so simple as it seems.

Mr. Burberry writes well on Masdevallias. I happen to know a little about these plants and how easy they are to grow and how easy to spoil, and there is sufficient in the paper in question to show that the author of it is not a "spoiler." Mr. S. T. Wright appears to have proved what many persons suspected, and several denied, that the wingless winter moth can be assisted into fruit trees by her winged mate for depositing eggs, to be followed by a scourge of caterpillars which devour the blossoms and defoliate the trees. Mr. Shea communicates what may be fairly termed a model article on Chrysanthemums, the information conveyed being precise,

concise, and just the kind wanted in respect to many other varieties besides those named; and Mr. Pithers gives very practical information on cutting down plants.

Mr. Abbey is almost too much for me in his philosophising on iron, but his article sets one a thinking, and that is something, and it may be as well to wait for the end before saying more about it, though a gardener who is troubled with iron soils, which he says makes his fruit trees canker, has already given his verdict. He is rather a rough diamond, and thus summed up the subject, "Iron for feeding plants, what next? Why the man who 'writ that screed' ought to be a blacksmith!"

As I cannot hope to make a better finish than that I close with apologies to the Editor, and to Mr. Abbey, and retire.—
A LOOKER-ON.

[The Editor desires no apologies for such articles, but rather likes them, and Mr. Abbey can take care of himself.]

USEFUL VEGETABLES.

It is somewhat surprising to find that some good and by no means uncommon vegetables are little known to many who might be expected to have been acquainted with their merits, and are absolutely unknown to others. One such is the Rosette or London Colewort, which I find many gardeners to be rather in the dark about. Why I do not know, for it is so useful and good a vegetable that it should undoubtedly find a place in every garden. I use it only in autumn and the early part of winter, and while it lasts it forms a standing dish for the dining room. June is quite early enough to sow, and it should be transplanted when ready in ground not by any means rich. The plants fill a space of 1 foot each way, but if ground is limited 1 foot by 9 inches will do very well. The plants left in the seed bed if thinned properly will provide a supply earlier than those transplanted.

Another instance of a good vegetable very much neglected is to be found in Sprouting Broccoli. The old purple is good, but much superior in appearance is the white form. This provides a capital dining room vegetable in spring when there is often a scarcity. I think it of better flavour than ordinary Broccoli, and in appearance if properly prepared it is quite as good. We sow at the same time as the ordinary Broccoli, allow them 3 feet by 2, and secure strong plants.

SCOTCH KALE.

Curly Greens and Green Kale this distinct vegetable is called in Scotland. As a spring vegetable there is nothing more delicious, at the same time it proves of great value as a change when choice vegetables are not plentiful. Possibly the term "choice" may be objected to, but always provided a proper strain is secured, and other items of culture and cooking are attended to, the term is perfectly correct. For one thing the seed is as a rule sown much too early. For the south of England the second week in June would be as early as necessary. In the north ten days or a fortnight earlier would be nothing too late. It is essentially one of those vegetables which a sharp frost improves, and therefore should be made use of either in a winter or spring—preferably the latter. Then it is a great mistake to apply manure heavily, as I have seen it advised. Ground in good condition should have no manure added. The plants do not grow so large under these conditions, but they become quite large enough for every purpose, and are less liable to be damaged in severe weather. Two feet between the rows by 18 inches asunder is enough space. Stocky plants will fill that by winter. The difference in the strain is as marked as one sees in Parsley. A good strain is of a light green colour, and the "curling" of the foliage close and fine. A few of the leaves make a dish, as they are bulky and go a long way.

LEEKES.

Leeks are commonly grown, but like the last their cultivation is not well understood. Of late years the demand in our own case has increased to a great extent. A well grown succulent Leek is most acceptable, and is not so much a substitute for mild Onions as some people use it, but is in itself a distinctly flavoured vegetable, and well worth growing. I think that the Lyon is the best of Leeks, though perhaps a little tender. As in the case of Scotch Kale I save seed for my own use, and I have a strain of a much hardier Leek with no lack in length or flavour. In cultivating Leeks it is to be borne in mind that the larger they are the finer the quality. This test is absolute. Then they must have a long season of growth, the seed being sown as early as possible in February or not later than the beginning of March. High culture from the outset is another point of absolute necessity. It is not of course

advisable to enrich the ground for raising seedlings by means of raw and strong manure, but it is of importance to point in some light flaky semi-decayed manure, keeping it within 6 inches of the surface. A thick dressing of soot judiciously applied during genial weather in April or early May will have a good effect. The ground for the quarter of Leeks has a 6 inch layer of manure dug in some time in spring, or at any time when the work can be conveniently done. The best Leeks I ever had were placed out in ground which was dry, and manured just previous to transplanting, but generally other work is so pressing at this time (June) that if not manured earlier in the season the crop might have a less liberal dressing than is essential to its wants. We choose a dull or drizzling afternoon to transfer the seedlings to the prepared ground. Deep drills are drawn, in the bottom of which holes are made with a common dibber. The plants are set in, watered, and so far that part of the work is finished. By-and-by as the plants make way the ridges are lowered to the general level, and if a deeper blanch is wanted the soil is drawn up to the plants on each side. The crop is in use from September to April. Where cow manure is scarce a liberal dressing of superphosphate of lime dug in just before planting will work wonders in the way of size. It may be added that by lifting what remain during February, and laying them in on a north border the Leeks keep in good condition much later.—N. B.

CALLIANDRA TWEEDIEI.

THIS beautiful stove shrub is seldom met with in gardens, partly because it is so little known and not readily obtainable. It is a native of Brazil, where it is said to attain a length of 8 to 10 feet. Confined to pots under glass it rarely exceeds 5 feet.

Few plants are more sensitive to the careless application of water, especially during cold sunless weather like the present, than this *Calliandra*. Being evergreen, with small somewhat tender leaves, it also does not bear drought. I have known it to lose nearly the whole of its leaves and flowers through having too much moisture at the roots; care should therefore be observed in watering until the flowering season is over, which is not usually the case until March or April, though some plants may flower more or less from November onwards. When the flowers are past remove the remaining peduncles and dead leaves, and clean the plants thoroughly, using clean water or mild insecticide for the latter purpose. Any potting that may be required must be attended to before new growth commences, which is usually produced sparingly. The usual compost for Gardenias suits them well. Young plants make a good display when cuttings are rooted sufficiently early, though two-year-old plants are much the best.

We have obtained good results from plants raised from cuttings rooted in the usual way early in January, potting them as soon as rooted and growing them in moist heat, pinching twice or three times, according to the state of the growth, until dull weather and short days necessitate a reduction of atmospheric moisture. Through December and the two following months give only enough water to keep the soil moderately moist, and do not syringe them, the moisture of the house being ample for their requirements until they begin to expand their globose heads of gaudy, filamentous flowers. The plants may then be safely removed to an intermediate house until flowering is over.

Where young plants are required, it is desirable to cut back one or more plants at the end of August, which will furnish ample stock for propagating, cuttings being difficult to obtain from flowering plants. *Calliandra Tweediei* is a very desirable addition to the inmates of a warm conservatory, but is of little use for cutting or room decoration.—W. R. WILLIAMS, *Great Marlow*.



SARCOPODIUM GODSEFFIANUM.

THE Sarcopodiums and the Bulbophyllums include some of the floral curiosities of the Orchid world, and many of the species are so nearly related that they are variously assigned by different writers to both

genera. This is the case with the Orchid which was shown by Messrs. F. Sander & Co. at the Royal Horticultural Society's meeting on June 24th last year, under the name of *Sarcopodium Godseffianum*, when a first-class certificate was unanimously awarded for the plant by the Orchid Committee. It is related to *S. Lobbi*, also known as *Bulbo-*

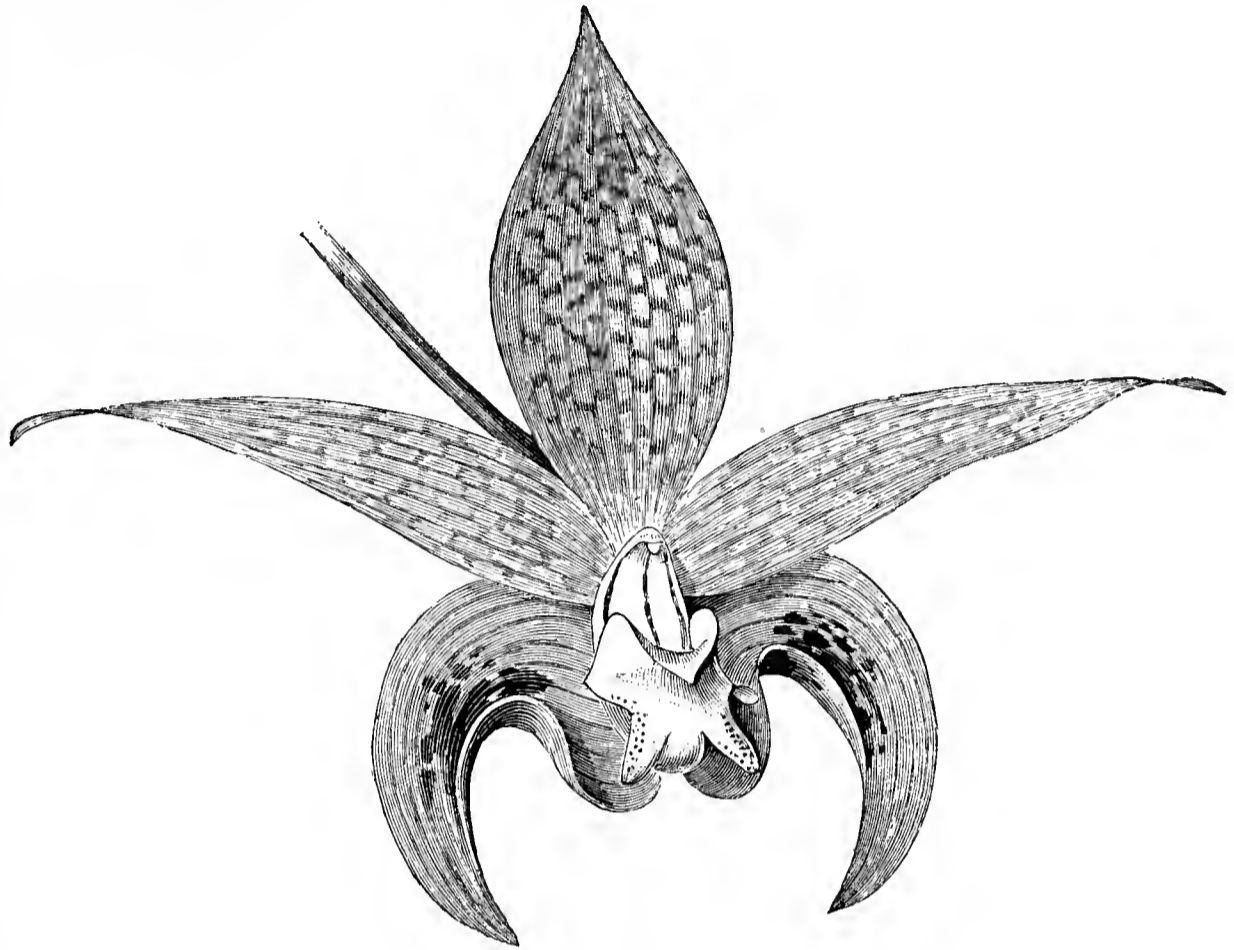

FIG. 5.—SARCOPODIUM GODSEFFIANUM.

phyllum *Lobbi*, and has unusually large flowers for the group to which it belongs. It is said to be a native of the Philippines, and somewhat resembles *S. Deari*, which comes from Borneo. The pseudo-bulbs are small and conical, the plant altogether being of diminutive growth. The dorsal sepal is about an inch broad, oval, or tapering; yellow, of a semi-transparent texture, and reticulated with a darker reddish orange colour. The two lower sepals are curved forwards and stained with deep crimson. The petals are pale yellow, narrow, tapering, spreading, or slightly deflexed, and the lip is ivory white, dotted with purplish pink. The plant bears the name of one of the most experienced and successful Orchid cultivators in Great Britain, Mr. Joseph Godseff.

MASDEVALLIAS AND DISAS.

[A paper by Mr. E. BURBERRY, Orchid Grower to the Right Hon. J. Chamberlain M.P., Highoury, Birmingham. Read at a Meeting of the Birmingham Gardeners' Association.]

(Continued from page 4.)

THE *Chimæra* section are best grown in shallow baskets suspended from the roof, no crocks being used for these, so that the flower spikes may have a free passage, coming as they do through the bottom and sides of the basket, while the smaller members of this remarkable genus are best grown suspended in small pans.

Important as the material and potting may be, the atmosphere is the most important subject in regard to the cultivation of Orchids, for it is this upon which they live. I am far from being an advocate of excessive heat, especially fire heat, but I do like to have enough. We have heard much about the cold treatment, and depend upon it many a good plant has been lost through being too cold, and others it has left in an unsightly and maimed condition. We are told by some that the *Masdevallia* house may fall as low as 35° in the winter without any injury taking place. I quite believe that it may sometimes go as low, and even lower than that in their native habitat, but for how long? A few minutes only before sunrise. The difference between that and our own long winter nights should be apparent to everyone. I grant that in some instances the plants may exist under this cold treatment, but I maintain that they will not grow, and we need not feel surprised if the tips of the leaves die and the under surface turns black. These are signs of being too cold, and consequently too wet. Under our artificial treatment we cannot imitate the natural surroundings of these plants. It is impossible. Yet a good knowledge of the conditions under which they grow is invaluable, that can be taken as a general

guide. But I consider it inadvisable to imitate too closely in some instances, if it is not in harmony with the others.

I find by experience that the *Masdevallia* will grow best if the thermometer does not fall below 50° at night, and not rise above 60° by day, this to be maintained with a circulation of air, unless it is very cold and much fire heat is wanted; then with the house closed it may fall a few degrees lower for once in a way. This is the winter temperature. In the summer the difficulty often arises in not keeping the house cold enough, from 55° to 60° by night and 60° to 65° by day, without sun. Of course, in hot weather the thermometer will rise higher than this. It cannot be avoided and it does no harm, always provided you have air and moisture, and keeping it as low as possible; and to do this it will be found necessary to damp the house at least three times a day, and by having the open stages it is well nigh impossible to damp too often. There is a better and quicker circulation of air playing around the plants, and if they are to be grown well they must dry quickly.

To secure a buoyant, even, and genial atmosphere when it is very cold and frosty out of doors I cannot too strongly recommend the use of some kind of covering for the glass roof, and I have also used it in very bad weather for the greater part of the day, preferring to rob the plants of a little light rather than to have too much fire heat. The best covering is a mat which is manufactured for this special purpose, and very largely used by gardeners in some places. They are made of a kind of reed tied together with string, and fitted to the roof from top to bottom in lengths of about 6 feet. They rest upon the roof at intervals, and are simply rolled up or down as required. I have known this make fully 10° difference, and this is a consideration not only for the plants but for economy also, for it is a decided saving of fuel.

We must not keep a *Masdevallia* dry at the roots at any season, for it is a plant that will persist in growing if the right treatment is given all the year round; yet it is possible to give too much water, the results of which are serious in the dark days of winter. This will cause the same disease to occur as insufficient ventilation or exposure to cold. A plant that has just been repotted should be watered very carefully and kept just moist till it has fairly recovered and is rooting well, then it may be treated as usual. I made it a practice never to water till the compost in which it is potted begins to show white or dry on the surface, then I give a thorough soaking, and no more till it is dry again. Some writers are most misleading in this respect, and would have us believe that we have simply to give water in abundance and all will go on merrily; but I find from experience that this is not correct.

The *Chimæra* section and other allied forms, together with *M. tovarensis* and *M. trochilus*, are best during the winter if placed at the warmest end of the house or taken to the intermediate house.

I have tried various manures on the *Masdevallia*, but can only recommend one—that is liquid manure from the farmyard, and much diluted for plants only which have their pots well filled with roots. The best shading I know, and which I can highly recommend for Orchid houses, and for cool Orchids in particular, is made of wood—simply quarter-inch boards cut down in strips 1 inch wide, and the same length as the roof; these are tied together with string, leaving a space of from a quarter to three-quarters of an inch between the strip, and made in lengths of about 6 feet. Three stronger strips of wood are run lengthways along the roof, and raised about 6 inches from the glass; on this the rolls of lattice-like shading are laid at intervals, and simply unrolled and rolled back as required. This forms at once a cheap, simple, and effective shading, and will last a number of years if stored dry when not in use. I know of no other shading so beneficial to the plants, admitting, as it does, light and air, and giving a most natural shade.

Of the insects which attack the *Masdevallia* green fly and thrips are the worst, and the latter is a most destructive enemy if not kept in check; it soon disfigures the foliage by causing it to become crippled, and also causes brown marks to appear on the leaves. Both thrips and green fly are easily kept down by the free use of the sponge and fumigating; if with tobacco it must not be very strong. I find the *Lethorion* vapour cones or Campbell's fumigating insecticide are the safest and at the same time most effective.

(To be continued.)

WANDERINGS.

I FIND the Christmas word-puzzles I set to our young friends who enjoy a little mental diversion have caused some amusement amongst them. I am sorry to say more than one seems to think, as an incredulous youngster says, that I have been "having a game with them in

just putting the letters together anyhow, and then pretending they make real words with sense in them." Another observes:—"It is all very well to tell us that English can be made out of Dutch; but that won't do, as there is not a word in the English dictionary that ends with "j." I was not aware of that, so it seems I have learned something in trying to teach, as many a better man has done before me. But serious attempts have been made to win the offered prize, yet without success. One translator, however, I think deserves something for his ingenuity in dealing with at least one of the two words. The first, "Indeniewepellicaan," he renders as "Indian Pelican." He is just half right. The word represents the sign of a tavern, the "New Pelican," and the passer-by is invited to go in, hence In-the-new-pelican, but all in one word as above printed. It is delightfully simple after all. It is the next word, however, for which the young linguist ought to have a prize, because the result is rather comical, yet, phonetically considered, perhaps excusable. "Gebreveteerde suikerbakkerij" must have something to do with tobacco, was the bright idea which seems to have occurred, and therefore as he could make nothing else out of the word he sent as his solution "Get here a bit of tobacco!" Yes, the young man must have something. A patent sugar plum would perhaps be as appropriate as anything seeing the last half of the word refers to the business of a sugar bakery, and the first half informs us that the process adopted is patented, or, as represented by the continental equivalent, Breveted, hence Breveted Sugarbakery, so we have really a similarity between Dutch and English when the words are "looked at a few times." The terminal "ij" in Dutch simply means "y" in English, and if the "Dictionary" young man will write that word and put two dots over the last letter he will find how easily the transformation is effected, for he will have ij in two ticks. I intend sending the "Tobacco" youth a present, which I hope he will appreciate, and continue to grapple with the difficulties he may meet with during his path in life. His name will not be published against his wish, as it might possibly lead to his being too familiarly known by another. Let me, however, impress on all young gardeners that they will never be the worse if they confine the use of tobacco to the prevention of insects on the plants they cultivate, for the prevention of an evil is better than its destruction always.

We will now wander over other ground. I had not been in Belgium many days before I found signs that the summer had been warmer than with us, though it appears to have been duller and wetter all over the Continent than usual. Still the wood of the trees was riper and the leaves more changed early in September than they were in England at the end of the month. In Belgian gardens Scarlet Runners were ripening, and the leaves quite yellow, while at home the plants were in active growth and bearing for more than a month afterwards. In the fields it was rare to find any Potatoes still growing, and for miles the stems were leafless and the crops ripe. The varieties grown may be earlier than ours, yet *Magnum Bonum*s—for this variety has found its way there—were withering, while in England they were in luxuriant growth in October. Some cobs of Maize were firm in Mr. Everaert's garden, while scarcely any were formed at the same time on plants from seed sown in the open in the vicinity of London. Many fields, or rather scores of plots in them, were not only cleared of corn in the Belgian campagne, but the ground had been turned over and sown with Turnips, acres of which were large enough for thinning, and some were being thinned. The crops removed I was told were of Barley, a variety being grown that is sown in the autumn, or at the same time that Wheat and Rye are sown in England. I have wandered into the fields for evidence, showing that last summer was warmer on the eastern than on the western side of the North Sea, for a visitor might be misled on this point by the appearance of the trees in Antwerp.

The site of the old fortifications which enclosed the ancient city as in a horseshoe, resting on the Scheldt, is now marked by broad and beautiful boulevards. The trees are chiefly Planes and Elms, and the former were casting their leaves freely at least six weeks before the trees do in London; but a closer examination of the Belgian Planes disclosed the fact of their being in very far from a healthy state. The leaves were small, pale, and blistered, and had been so all the season. It would be little short of a calamity if these trees, which have been planted about twenty-five years, should quickly collapse. Their unsatisfactory condition is a matter of concern in the city, and perhaps not the less so since the cause is not determined. By some authorities it is attributed to a severe frost occurring when the trees had made a little growth, and the consequent rupturing of the sap vessels in the then tender shoots. If the whole of the trees were alike enfeebled that explanation would be more conclusive. The great majority of those first planted are unquestionably in a bad state; but a few of them were fairly vigorous, while every young tree that had been put in the place of an old one that had been removed was apparently in the best of health. Now if, as we may suppose, new soil was introduced for planting the new trees in, may not this account for their comparative vigour? Should that be so, does it not suggest that the older trees have impoverished the soil, and that the roots can no longer find what is requisite for their support? Plane trees appear to need very much water. Can the site of the old ramparts be dry? In most cities very little of the rain that falls passes into the earth in a natural manner, but is conducted away by drains, and pouring water round the stems of large trees only does a small measure of good. When I have stopped to admire exceptionally large Plane trees in England I have observed that a plentiful supply of water was within reach of their roots. The grandest specimen I can call to mind is on the estate of Mr. Smee at Hackbridge, Surrey, in a field which contains a few acres of Watercress beds. It is a veritable giant in luxuriant growth, and I suspect half of

its roots are in water at least for half a year, and probably all the year round. When I remember how much enfeebled fruit trees have been improved by saturating the ground with liquid manure, that suggests their former condition was due to poverty and drought at the roots. Ornamental, deciduous, and evergreen trees that appeared to be wearing out have been made as if young again by enriching the soil in that and other ways. While I think it very likely the Antwerp boulevard Planes may have sustained injury by frost, I cannot refrain from expressing my conviction that they are also suffering from semi-starvation. I should like to have an opportunity of experimenting with a few of them by driving holes 2 feet deep and 1 foot asunder from near the stems, outwards as far as practical, flooding these time after time with liquid manure, then filling up with a rich, free, root-inciting compost, compressed as firmly as possible. This done during the first favourable weather in spring would probably double the root-foraging power of the trees during the summer, and the following year better growth might be expected.

In a similar way Mr. William Paul of Waltham Cross transformed a sickly and apparently dying tree of a Golden Queen Holly on his lawn into one of the finest and most richly coloured specimens to be seen anywhere, and the improvement was permanent; as when I examined the tree some years after it had been treated as described it was in the best of health. Mr. Paul's account of his method of tree restoration, published in the *Journal of Horticulture*, led to the restoration to health of some old Pyracanthas that covered the front of a mansion from the ground to the roof. For years they were admired for their size and beauty, the deep green of their leaves and rich colour of their fruit; but a change set in, the leaves becoming paler each year, and eventually most of them fell, and the once beautiful surface of green and coral red became unsightly. An experiment was made as above suggested with liquid manure and rich soil. The effect was quickly seen, and in two years the front of the mansion was as green as ever with healthy growths of the once nearly dead and condemned Pyracanthas. They were dying through starvation, and an abundant supply of nourishment effected their restoration. Many unhealthy trees have been improved in the same way, and more may be when their degeneration is the result of soil impoverishment and not frost. I have wandered from Belgium to England, and now wander back again to the Avenue des Arts, I think it is, in Antwerp, where the condition of the Planes was sad to see by one who had seen them before in luxuriance. Thus I began with a puzzle trivial and end with a puzzle serious—the real cause of trees degenerating on lawns or in streets, and where this, as is often the case, is traceable to dry and impoverished soil, the remedy proposed, if not deferred too long and thoroughly applied, may have the most satisfactory results.

We have yet to pass in memory up and down different avenues of different trees with my guide, philosopher, and friend Mr. Van Geert, and through the extensive, diversified, and enjoyable garden of the great Belgian amateur Mr. Everaets, the "we" in the case being the old song characters or typical English rustics "thoroughly domesticated."—DARBY AND JOAN.



EVENTS OF THE WEEK.—The principal meetings of the current week are as follows:—January 8th, Royal Society at 4.30 P.M.; January 10th, Royal Botanic Society at 4 P.M.; January 13th, Royal Horticultural Society's Fruit, Floral, and Orchid Committees at 12 noon; January 14th, Society of Arts at 8 P.M.; January 15th, Gardeners' Royal Benevolent Institution, annual meeting, at 3 P.M. at "Simpson's," 101, Strand, and dinner at 6 P.M., when presentations will be made to H. J. Veitch, Esq., and Mr. E. R. Cutler. The usual monthly dinner and conversazione of the Horticultural Club will take place at the Hotel Windsor on Tuesday, January 13th, at 6 P.M. The subject for discussion will be "The Germination of Seeds, their Vitality and Distribution," to be opened by Mr. G. Bunyard.

— THE SEASON'S GREETINGS.—Although emanating from what may be called the cloisters of gardening—viz, the nursery, the hard fare of which only enables me feebly to raise my pen, I would like to respond to the cheering words so kindly written by Mr. Pownall in the concluding number of last year. Doubtless they were intended more for those in harness than for the unfortunates who, through force of circumstances, are undergoing the privacy and seclusion of nursery life. But even there the eagerness with which the clubbed-for Journal is read, and its merits discussed, is evident proof that although the "Work for the Week" columns are, under the circumstances, passed with a sigh, there is no lack of interest in the general affairs of gardening,

and when anything hopeful is written it strikes home with greater force than in better times. Words of counsel and advice from those grown grey in gardening are revered by the younger members of the craft, who, although they have the benefit and guidance of aged experience, and a long legacy of useful results, they have also the disadvantages which are only too well known to require repetition. As we strive to be useful in our day and generation, it is with no desire to supplant our honoured pioneers, and we hope the day is yet distant when their pens shall be laid aside, and if "crabbed age and youth cannot live together," yet pleasant age and youth can, and my experience of gardeners is that far more belong to the latter category than to the former.—J. M. D.

— THE WEATHER IN THE LONDON DISTRICT gave indications of a decided change on Saturday and Sunday last. A sudden thaw commenced, and it appeared that the winterly period was coming to an end. The thaw was, however, only partial; it was followed on Monday and Tuesday by sharp frosts, and except that the snow was slightly diminished there was little result from the change. Fortunately, however, the days have been clearer, and, after such dense fogs as prevailed last week, this was most welcome. Signs are already visible of the damage the frost has caused to tender trees and shrubs, and when the thaw really does come it is feared the injury will be found to have been unusually severe.

— THE WEATHER IN THE NORTH.—During the last two weeks the weather has been quite seasonable without extremes of any kind. Towards the close of the year alternate thaw and frost rendered the roads difficult to drive or walk on. The beginning of the year—the 1st was a beautiful winter day—saw the snow disappear from the low grounds, but the last two nights with frosts of 5° and 7° promise a return of severer weather.—B. D.

— A PECULIAR and very distinct Amaryllidaceous plant—CALLIPSYCHE MIRABILIS—is now flowering in the T. range at Kew. It has a long fleshy scape like the Hippeastrums, and is crowned with an umbel of about twenty small yellowish flowers, the segments tipped with green. But the peculiarity consists first in the long drooping stamens, and secondly in the long polished white styles radiating equally round the umbel; these are over 4 inches long, regularly curved downwards, and just as evenly turned upwards at the apex, presenting a unique floral appearance. Mr. J. G. Baker says the plant is a native of the Peruvian Andes, and that it was first described from a specimen which flowered in Mr. Wilson Saunders' garden at Reigate about 1870, received from M. Linden. Specimens were also subsequently sent to Kew by Sir C. W. Strickland and Messrs. Sander and Horsman. It is recorded as flowering in July and August, so that its present midwinter flowering may be regarded as an accidental occurrence.

— THE deepest sympathy and regret is experienced in Rock Ferry and the neighbourhood, and will no doubt be shared by many readers of the Journal, at the great bereavement with which Mr. T. B. Hall, the celebrated Rose exhibitor, and Mrs. Hall have been plunged through the death of their eldest son, Mr. Henry Sproston Hall. The deceased gentleman was engaged on December 27th cleaning a revolver, when it accidentally exploded. Deceased, who was only thirty-five years of age, was interred at Higher Bebington Church last Tuesday afternoon.

— EUCALYPTUS.—Perhaps it may interest some of your readers to know that at Westhill, Freshwater, Isle of Wight, there are eleven Eucalyptus trees, varying from 30 to 40 feet in height, with large spreading branches. The girth of the largest (one foot from the ground) is 2 feet 7 inches. I brought the seed from San Remo in 1879. Many of the trees flower freely and have seed pods, though I have never been able to save any seed. They never appear to have been affected by the cold till this winter, but the first hard frost after such very mild weather seriously damaged them, the bark in many cases having been split right down to, and away from the wood, and I fear they will not recover.—R. P. C.

— DEUTZIA GRACILIS IN THE SHRUBBERY.—I can corroborate all that "W. B." says in favour of this deciduous shrub for outdoor cultivation. It grows freely and flowers in profusion. Nothing could surpass the masses of blossom which our plant produces every year. Our specimen is now from 3 feet to 4 feet in diameter and of uniform shape, being a round bush. It cannot be said that the plant occupies a

favourable position, being on the north side of a shrubbery border, much shaded by tall evergreens. "W. B." says this *Deutzia* "grows freely in good soil where lime does not abound." In our case chalk is very freely mixed with the soil. Chalk, I am told, contains 80 per cent. of lime, therefore it cannot be said that lime is at all injurious to the *Deutzia*. The plant has not received any manure for the last ten years. I question if any was given at planting time, yet still it flourishes.—E. M.

— MR. JOHN CLARK, LATE GARDENER AT BRODIE CASTLE, MORAYSHIRE, died at that place on Christmas Day, after over a quarter of a century of faithful and valued service.

— THE WEATHER IN DECEMBER.—This was a dull month, with much fog, and a low temperature, with a very severe frost on 22nd, and the ground covered with snow from 14th to the end of the month. We had only two bright days. Wind was in an easterly direction twenty-five days. Barometer, highest 30.36 on 27th at 9 A.M.; lowest, 29.27 on 19th at noon; average height, 29.93. Highest shade temperature, 44° on the 4th; lowest, 5° on the 22nd; lowest on grass, 7° on the 22nd. Mean temperature of the month, 29.53°. Total rainfall, 0.51 inch, which fell on twelve days. The greatest daily fall was 0.11 as snow on the 19th. The garden spring ran 9 gallons per minute on the 31st.—W. H. DIVERS, *Ketton Hall Gardens, Stamford.*

— THE WEATHER IN NORTH-EAST LINCOLNSHIRE has been the most severe recently that has been known for many years. On December 19th there was about 15° of frost, followed by about 3 inches of snow. On Dec. 21st the thermometer registered 7°, on the 22nd 4°, and the thermometer has never risen above 33° during the past ten days, and there are not the least signs of any change in the weather yet. The east winds (which are so prevalent and disastrous here), and the frost, have done great harm to all kinds of garden produce in the open ground.

— IN the December number of the "Botanical Magazine" an excellent illustration is given of *RHODODENDRON BOOTHI* (t. 7149). This is one of the most handsome yellow-flowered species from the Bhotan Himalayas we have yet seen; the flowers are large, the petals broad and rounded, bright clear yellow, with which the rich crimson anthers contrast admirably. The flowers are borne in a compact head at the points of the branches, the leaves being green with a few brownish hairs on the upper surface and lighter beneath. *R. Boothi* was found in Bhotan at "an elevation of 5000 feet epiphytic on Oaks, and is described as a straggling shrub 5 to 6 feet high."

— OTHER plates in the same issue of the work named above represent the following—*Rhodostachys andina*, a strong growing Bromeliaceous plant from Chili with dense heads of pink flowers; *Arisæma fimbriatum*, an effective species from the Malay Islands, with reddish brown and white striped spathes, the spadix long, slender, and drooping, and strongly filamentous. *Scaphosepalum pulvinare* is a small brownish flowered Orchid of the *Pleurothallis* family chiefly remarkable for the length of time it continues in flower; and *Thalictrum Delavayi* from the mountains of Yunan, the flowers pale purple in loose panicles.

— OLD PEOPLE'S GATHERING.—On New Year's Day a most interesting gathering took place at Astwood Bank, in connection with the Astwood Amateur Gardeners' Society, when about a hundred persons, in spite of the severe weather, met to tea and an entertainment. Mr. J. Hiam, the President of the Society, was elected to the chair, and gave a five-minutes opening address, after which an enjoyable evening was spent, and many a wish was expressed for similar annual gatherings.

— THE WINTER MOTH.—Just a line to thank Mr. S. T. Wright for his note on page 4, which I have read with much interest. If we only differ on one point in our extensive researches and observations we will not quarrel. I only wanted to prove that the egg-laying insect was "assisted" into the trees by actual observation, but this I have never been able to do, although I have burnt many a pound of dips. I have certainly made a hundred visits at night in hopes of satisfying myself on the point. I heartily reciprocate the good wishes for the coming season.—J. HIAM.

— PRODUCTIVE STRAWBERRIES. — A Wicklow correspondent writes:—"I forced about sixty Strawberry plants last year and they fruited well; I afterwards turned them out of the pots in good soil,

and I had a good crop on them in autumn. I lifted some, placed them in boxes in heat, and I have had ripe fruit up to a week ago. There are many green fruits on the plants, which I daresay will ripen when I start forcing again. I must thank you for good advice, as I am indebted to the Journal for my success."

— REPORT OF THE WEATHER DURING DECEMBER, 1890.—The weather during the past month was of unusual severity, only two nights without frost, whilst 12° to 17° of frost have been registered each morning. The days for the most part have been very dull and cold, particularly the 29th and 30th. During eighteen days the temperature did not rise above freezing point, and during most of the eighteen days it remained many degrees below. Very little rain has been registered. In fact, rain fell upon only one day throughout the month, whilst sleet has fallen frequently. On the 19th 3½ inches of snow fell, which is equal to 0.33 of rainfall, and on the 26th another slight fall was experienced which produced water equal to 0.10 of rainfall. The total amount of snow and rainfall combined for the whole month was equal to 0.53, thus making December here a very dry month. Total amount of rainfall for the past year 23.17 against 27.81 of 1889.—E. WALLIS, *The Gardens, Hamels Park, Buntingford, Herts.*

— CHRISTMAS ROSES.—This has been a bad season for having these plants in flower by Christmas, though generally we are enabled to cut abundance of charming flowers fully a week before that day from plants growing on an east border, having no protection beyond what is afforded by a cold frame placed over the roots at the end of October. At the present time there are hundreds of buds on the plants of *Helleborus niger*, but not one has yet opened, and not many have been gathered from the maximus variety, which is generally so much in advance of the ordinary *H. niger*. The severe frosts experienced this winter are no doubt the cause of the backward flowering of these plants this season. By lifting the roots and placing them in a warm temperature we might have had a quantity of flowers, but this plan does not commend itself where but limited numbers of roots are available, and from which a full supply of flowers is expected every year. Plants of either of those named that are lifted and forced ever so gently do not recover from the check for two or three years afterwards, therefore if flowers are expected every year from a few roots the best means must be adopted. Our roots of *H. niger* are fifteen years old, and it is ten years since they were divided and planted on the border, so that a cold frame would cover them. To a strong soil peat and leaf soil were added, in which the plants grew well.

— WHEN ALL THE FLOWERS ARE GATHERED early in March the frame is removed, the soil is pricked up; after removing the seed pods, which are freely produced, a mulching 2 inches thick of partly decayed horse manure is spread on the soil about the plants and allowed to remain there until the following October, when the strawy parts are raked off. The plants while growing in the spring are well supplied with water, and occasionally with liquid manure, which induces plentiful foliage, without which it is useless to expect a full supply of high quality blooms. The manure laid on the surface is by the continual waterings partly washed into the soil, the roots receiving the benefit from the manure in this way. During dry weather *Hellebores* quickly suffer if not supplied with moisture; it is injurious to the plants if the foliage flags severely when growth is in progress. By following the few cultural hints as detailed anyone may make certain of plenty of flowers every year with but little trouble.—S.

COTONEASTER FRIGIDA.

IN passing through the public gardens at Bournemouth in November last, which extend to the length of a mile or two along what may be termed a beautified dell, many standard trees of this *Cotoneaster* growing amongst shrubs on the southern slope arrested attention. These trees were from 10 to 20 feet high with heads about half that diameter or less, as they were more upright than spreading, and densely laden with large pendant clusters of reddish crimson fruit. Strikingly effective were these glowing masses of colour, and it is not conceivable that they could be equalled by any other tree in the winter months. This *Cotoneaster* is of robust upright growth with leaves 3 or 4 inches long and half that in width, and many of them remain through the winter. The sheltered position the trees occupied no doubt favoured their growth and fruitfulness, but it may be reasonably expected there are many other gardens in which this distinct *Cotoneaster* would

succeed, but where it now has no place. In the north of Ireland it seems to be particularly at home, for it may be seen flourishing in several gardens. At Langford Lodge, the residence of the Rev. A. H.

tions that its specific title "frigida" was bestowed upon the plant "on account of the coldness of the locality in which it was found." It is a native of the mountains in the northern part of Nepal, and was



FIG. 6.—COTONEASTER FRIGIDA.

Pakenham, near Crumlin, in the County of Antrim, it constitutes a large proportion of the extensive shrubberies, and produces its berries in great profusion.

It is said to bear severe frosts without suffering, and Loudon men-

introduced to this country in 1824, but is by no means common in our gardens, although it has been known so long. For this reason we call attention to it here. The shoot represented in our engraving was forwarded to us by Mr. Stevenson, Superintendent of the gardens at Bournemouth.



STOPPING OR CUTTING BACK CHRYSANTHEMUMS.

IN some places I have seen single stemmed plants for cut blooms and groups reaching the inconvenient height of 7 to 8 feet and much higher, and it may be asked, Is this mode of growing a step in the right direction? At the Chrysanthemum Show at Sutton Coldfield, near Birmingham, a very fine group of cut-back plants took the first prize, each having from three to five shoots with excellent thick dark green foliage to the pots, and truly fine blooms, but not so large as some grown on a single stem. Then I saw on two or three occasions fine plants grown on the cut-back system in the gardens of A. F. Osler, Esq., Edgbaston, Birmingham, where Mr. J. Hughes, the Secretary of the Birmingham Chrysanthemum Society, is gardener. I did not count them, but there were fully 200 plants not one more than 4 feet, many at 3 feet, bushy, with wonderfully stout leathery dark green foliage to the pots and well flowered, and Mr. Hughes sees no reason why exhibition blooms cannot be easily grown from cut-back plants. Certainly for grouping or conservatory decoration such plants are much to be preferred to the very tall unsightly plants so often seen. Chrysanthemum Committees, why not encourage such yearling cut-back plants? Those I have referred to were "winter struck," and cut back about the middle of May. Mr. Falconer Jameson, in writing on "cut-back Chrysanthemums" at page 525 of the Journal of December 11th, says, "One of the great objections to the majority of the Chrysanthemums when grown with exhibition blooms is the great height to which they grow. Why should not societies encourage the system of cutting back by offering prizes for them?" And he alludes to a group of cut-back plants at the Hull Show, and I am very pleased to see he is strongly advocating the cutting-back system for exhibition plants. Our system of growing either purposely for large blooms or for trained exhibition plants is so general that at exhibitions we do not see as we ought examples of how to grow smaller plants for conservatory or room decoration, especially for small greenhouses.

SINGLE CHRYSANTHEMUMS.

I predict for these a considerable amount of popularity for decoration work when their beauty and value is more known. Mary Anderson is well known as a white variety of excellent form. Miss Rose is another very pretty variety of a pale rose colour and fragrant. Scarlet Gem is a charming variety, so also is Mrs. Langtry, pale pink; and Gus Harris, deep pink with lighter base, and bright yellow centre, and very fragrant. I wish to see them encouraged at exhibitions as specimen plants, and I should like to see prizes offered for, say, a dozen or half a dozen plants in not larger than 32-pots, to show what can be done with them as decorative plants. I have repeatedly seen large plants in conservatories, and glorious specimens they are with such masses of flower, and so good for cutting, and the fact that some of them possess a most pleasant fragrance is a sufficient reason why they should be more promptly acknowledged as autumn decorative plants, and there are other desirable varieties besides those I have named.—W. D.

LARGE VERSUS SMALL PRIZES.

SINCE the day when large prizes for cut blooms of Chrysanthemums was offered, many remarks have been made by gardeners and others expressing astonishment at the large amount of money offered for just a few cut blooms of a plant which can be grown to perfection in rather less than a twelvemonth. The saying is, "Why should not equally as good prizes be offered for other classes of plants and flowers?" Now that the Chrysanthemum has reached its perfection as exhibited in a cut state, why not offer equally as good prizes for the best dwarf Chrysanthemum plants with largest number of first-class blooms? It is well known many ladies and gentlemen would much more appreciate their gardeners having some good dwarf bushy plants of Chrysanthemums, rather than a number of tall plants grown to display about two or three large blooms. I have lately heard several ladies remark that they fail to see any usefulness in such large flowers.

However, my object in writing is, not to call the attention of readers altogether with regard to large amounts offered from year to year for cut blooms of Chrysanthemums, because it is known to all, but to point out what paltry prizes are offered for classes of plants which require a greater amount of skill to grow than Chrysanthemums. Observe the difference in prizes for stove and greenhouse plants in comparison to the large amount for blooms of Chrysanthemums. As a rule £5 is offered for nine good specimens, and that too for plants which take years to grow. I am aware there are one or two shows that offer £20 for a collection of stove and greenhouse plants—even this is a small sum compared with a few cut blooms of Chrysanthemums having the same amount.

Again, look at the noble Azalea, what years it takes to grow a small Azalea into a good specimen; not only time but skill as well, then expect a man to show a dozen specimens for about £6 to £8. A £5 cup offered for nine large Fuchsias, certainly these are easy plants to grow compared with Azaleas or stove and greenhouse plants, at the same time the prize is small compared with what is offered for Chrysanthemums.

Independent of the time and skill required to grow the plants I have mentioned, observe the labour and expense required to convey such plants to the show as compared to a man running off with a box of Chrysanthemum blooms, and no doubt some can carry them under their arm. There is a time for most things, and I think the mania for growing large Chrysanthemum blooms ought to now pass away, and let something else have a chance. Gardeners must not be a one-sided class of men, but endeavour to promote what is fair and just among them; therefore I feel sure no sensible gardener, whether he be an exhibitor of Chrysanthemums or not, can admit that committees are at present acting fair in the way they offer prize money. The saying is, Pay a man according to his worth, then I say, Offer prizes proportionate to the worth of the plants required. Therefore, as a non-exhibitor, but as an observer of things in general, I trust growers of choice plants will soon have their due.—F.

IRON.

ITS USE IN CONNECTION WITH FRUIT CULTURE AND DISEASES.

(Continued from page 16.)

THE subject of canker, its cause and prevention, is so important that it appears to demand still further consideration. All the savants agree that canker is due to poverty. "Sickly trees are just the media for the development and growth of parasitic fungi," writes Dr. Griffiths, and "parasitic diseases 'take hold' through the crops being imperfectly nourished." Canker unfortunately does not confine its attacks to the needy, but is equally prevalent on the full fed, or perhaps we might say, not properly fed. The remedy is phosphorus, sulphur—stimulating the living substance—causing it (protoplasm) to build up the cellulose of the Apple and Pear instead of the micro-parasitic cellulose, animal or vegetable. It does not matter which, for "fungi live, like animals, upon organic food consisting of complicated combinations of carbon, which they assimilate, and, like animals, they inhale oxygen and give out carbonic dioxide." It seems a principle of protoplasm of interchanging some of the fundamental attributes of the two kingdoms—plants and animals. If the protoplasm is weak the growth corresponds, and if strong the growth is luxuriant. It depends on the food and power of assimilation. There is poverty at the root. Want of material to build with in case of the weak—too much, more than the foliage can elaborate and assimilate in the strong—there is poverty of sap, result canker. Unfortunately the full fed tree is equally liable to the dry gangrene. It is the nature of the disease. The Elm similarly affected oozes gallons of fluid as a ferment. That, however, is not canker, but gum, for canker in trees is analogous to cancer in animals, most frequent amongst the underfed, overworked, and badly sanitized. Treatment: Active caustics, good food, warmth, air, exercise—in a word, expulsion. For canker in Apple and Pear trees, careful cultivation, favourable circumstances of soil, drainage, temperature, and good living. Of course hereditary tendency does not admit of entire prevention or great modification of the disease. Indeed canker may be defined as a loss of vitality in some part from some latent disease, and in the case of the Apple and Pear a remedy is found in much the same way as in canker in animals. For canker in Cucumbers and Melons we cauterise with quicklime; for infected Auriculas, believed to be infectious, yet caused by superabundant nourishment, we apply charcoal, and prescribe a less luxurious regimen. For Parsley grown in a poor soil Mr. Barnes found no remedy equal to "soot and slaked lime thrown over the plants. The cure is complete in a few days, and the vigour of the plants restored, indicating that this species of ulceration arises from deficient nourishment."—"Cottage Gardeners' Dictionary," page 169). Wherever a cure for canker obtains iron comes in; even scab in Potatoes is a canker, bearing a great analogy to canker in Apple trees. It is sometimes accompanied by a fungus (*Tubercinia scabies*), and sometimes no trace occurs of the "action of fungi, and it has been conjectured that the cracks followed by scabbing are due to contact with irritant or corrosive substances in the soil, and that the scabs are due to efforts at healing the injury, but new cracks form in them, and so the mischief goes on."—(Nicholson's Dictionary of Gardening, div. vi., page 207). Why should new cracks form or the tubers scab after they are stored? Where is the "irritant or corrosive substances" then? In the spore of the fungus of which "there is often no trace at harvest time, but during the winter it develops, and the spores form a layer beneath the skin, often extending over a great part of the tuber. After a time the spores are set free by the bursting of the skin." Iron sulphate destroys this fungus.

The analogy between canker in Parsley roots and scald in Potatoes is that it begins with a swelling—the seat of the fungus is between the bark and alburnum. "The swelling is caused by a rupture of the sap vessels by frost," say the believers in cold causing canker in winter trees, but wherever sap vessels are ruptured by frost there is immediate shrinking of the bark after a

thaw. Frost bites are very different from canker. Compare wood destroyed by frost, or a bruise, with canker. The first is dry, the bark hardens, loses none of its elasticity, and comes off stringy. A cankerous wound is first moist, raised or swelled, then loses its

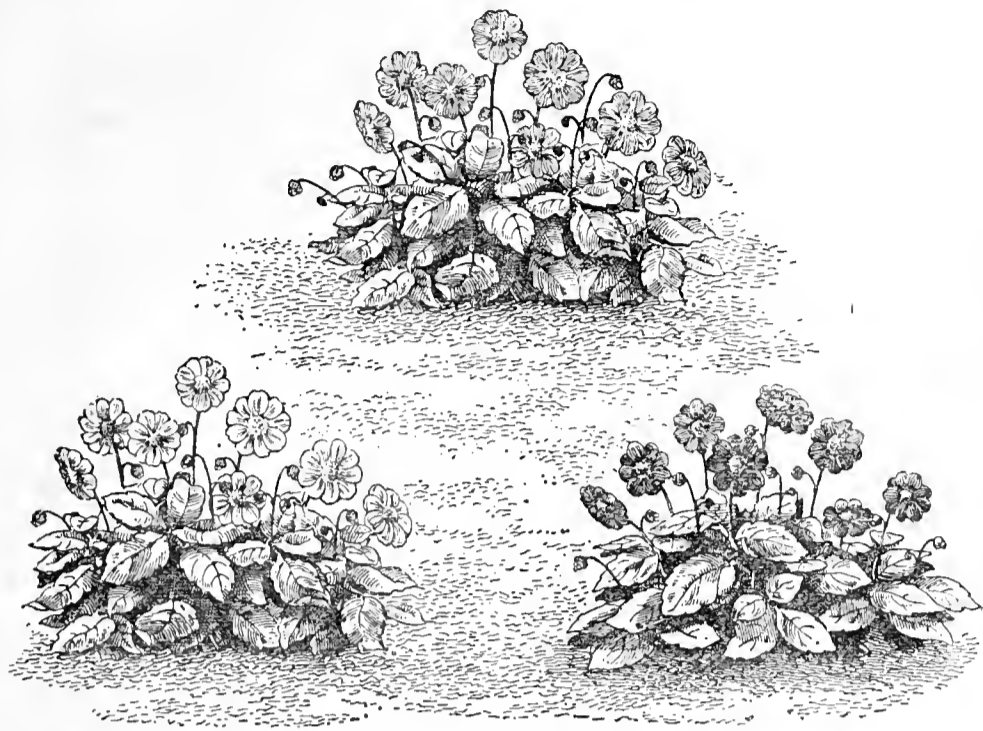

FIG. 7.—TOM THUMB DAHLIAS.

elasticity; instead of stringy, it becomes granular, and a gaping scar appears. What has become of the matter that once formed the bark, where there is a gap clear down to the wood? It has gone, but the frost-wounded, mechanically inflicted scar retains the old bark in strips. Its tissue was not destroyed but injured, and decortication sets in of a different character. There is no carbonate of lime on the edges of the wound as invariably accompanied the morbid product of canker. A tree may have wounds entirely innocent of canker. No wound would produce it. Cut a weakly tree hard and it will outgrow canker; wound a strong growing barren tree and it will produce fruit abundantly, in neither does canker result from the cuts or the bruises. The frost doctrine will not bear examination, and is founded on guess work. We want to implant in the Apple and Pear tree means to destroy or make latent the "fungus (or microbe) which obtains its nourishment from the protoplasm of the cells of its host, thereby destroying or greatly impairing its vitality." This Mr. Tonks seems to have effected with phosphorus and sulphur within, energising the protoplasm, and by lime, silica, and iron strengthening the cell walls and external surfaces, so as to render the trees proof against disease. Lime, Mr. Fish says, destroys fungi. Mr. Tonks' remedy is more than half lime. Dr. Griffiths says iron sulphate in small quantities destroys parasitical germs. Mr. Tonks uses iron sulphate in small quantity. Mr. Tonks uses sulphates. M. Müntz says any sulphate increased the growth of crops 13.54 per cent., and iron sulphate 30.2 per cent., with an addition of 9.6 per cent. of chlorophyll. Mr. Wright states that Mr. Tonks' mixture and soil amelioration cured Apple trees of ten thousand cankered wounds. It is the physician's plan—eliminate the virus or render it latent, for there is no disguising the fact that canker is a disease caused by microbe or micro-fungi. Poverty is not a disease but a misfortune, plethora is not a disease but an abuse. Disease fastens on both. Bad management undermines the constitution, prepares the way for the real enemy to seize its victim.

Science will some day seize the destroyer—in fact, it has found *Nectria ditissima* to be associated with canker, and it is not settled whether it will or will not result in the production of canker by inoculation; but it is perfectly clear that iron is always associated with successful Apple culture. Pears do not require so much iron by half as the Apple, only one-third the silica, one-sixth less sulphuric acid, one-seventh more phosphoric acid, nearly half as much more lime, a quarter less magnesia, only one-third the soda,

and two-ninths more potash. Potash and nitrates benefit most on light soils. The Pear or Quince in damp heavy soils affords the finest fruit, from the circumstance that the Quince is a great consumer of phosphoric acid, and phosphoric acid is most potent on heavy soils; yet the Pear succeeds on light soils on that stock where the Apple cankers to death. The Cherry loves sand—fishes iron out of subsoils; Plums delight in iron and potash; but Strawberries appropriate more iron than do any other fruit, and come second only to the Cherry in the demands for sand. Gooseberries take iron next to Strawberries, and the last, with Apples, need the most salt. Iron is the most important of all the metals, and prevails abundantly for good in the earth's crust.—G. ABBEY.

TOM THUMB DAHLIAS.

DAHLIAS have received much attention from cultivators for a long series of years, but though so many hundreds of varieties have been produced, distinguished by great diversity in the form or colour of their blooms, but little alteration has been effected in their habit. It has apparently been reserved for Mr. T. W. Girdlestone, of Sunningdale, to secure a new race of Dahlias remarkable for their dwarf habit, and therefore especially adapted for bedding purposes. To these the appropriate name of Tom Thumb Dahlias has been applied in the same way that several other dwarf types of bedding plants have been denoted, and it is very probable that the group will become extremely popular, as their usefulness for the margins of the beds and borders in the flower garden cannot be over-estimated.

The plants are from 9 to 12 inches in height, compact bushy little specimens, producing their single flowers freely, and twelve distinct colours have been already "fixed." Messrs. J. Cheal & Sons of the Lowfield Nurseries, Crawley, who have paid much attention to Dahlias generally, and have added many handsome novelties to the single and Caetus sections, have procured the stock of these Tom Thumb Dahlias for distribution, and the plants have been proved to test their characters. The engravings (for which we are indebted to Messrs. Cheal & Son) have been prepared from photographs. The illustration (fig. 7) shows three plants, and fairly represents their chief features. The other illustration (fig. 8) affords a good idea of the true height of the plants, amongst which stands their raiser, Mr. Girdlestone, who is the Hon. Secretary of the National Dahlia Society,

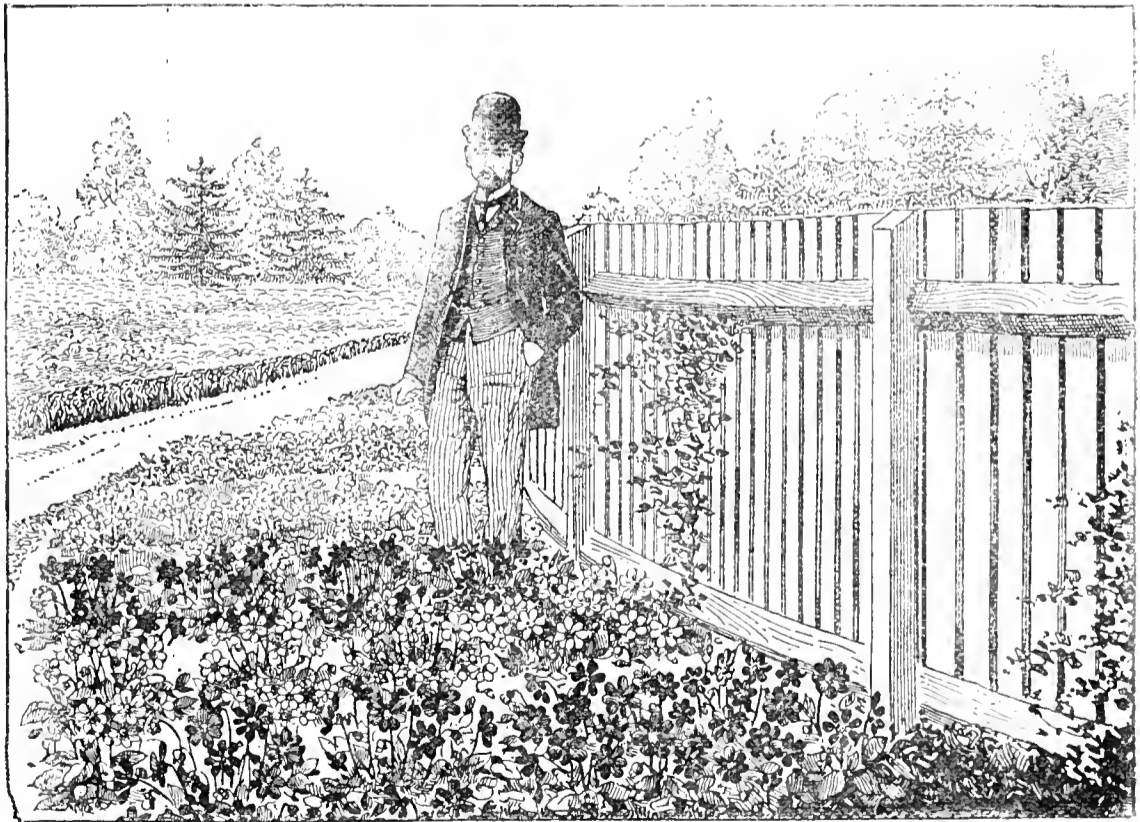

FIG. 8.—TOM THUMB DAHLIAS AND THEIR RAISER, MR. T. W. GIRDLESTONE.

and a member of the Floral Committee of the Royal Horticultural Society. These Dahlias are unquestionably valuable additions to the lists of bedding plants.



FRUIT FORCING.

PEACHES AND NECTARINES.—Earliest Forced House.—Maintain the night temperature at 50° to 55° , the latter only when the nights are mild, 55° by day as a maximum in severe weather by artificial means when the sky is overcast; 65° by day from sun heat, and if the air be mild a few more degrees may be allowed. Syringing must cease as regards the trees, but damping the floor and border on bright days in the morning and early afternoon should be practised. Lose no opportunity of ventilating freely when external conditions are favourable, and when the pollen is dry choose the warmest and driest part of the day for aiding its distribution by shaking the trees or trellis, or taking a camel's hair brush applying the pollen to the stigmas. A feather brushed over the blooms will serve the same purpose, also a small plume of dried Pampas Grass, or a rabbit's tail tied to the end of a small stick. If there be a deficiency of pollen of any variety some should be taken from those that afford it plentifully, and applied to the stigmas of the flowers. Inside borders must not be neglected for water; outside borders must be protected with litter or some other protective material, avoiding fermenting material.

Second Early Forced House.—To have ripe fruit in early June of such varieties as Early Alfred, Hale's Early, followed by Royal George, the house must be set to work at once. Damp the trees and house in the morning and early afternoon, turning the heat on in the morning so as to raise and maintain through the day a temperature of 50° , taking care that it does not exceed 50° by artificial means, allowing the heat to rise to 65° with sun heat and free ventilation from 50° . When the buds swell maintain a night temperature of 40° . Bring the borders, if at all dry, into a thoroughly moist state by repeated waterings. Protect the outside border with litter or leaves, but not of a depth to cause a warmth over 60° to 65° , for excitement at the roots causes growth, and wood growth before the setting of the blossoms are effected often causes the incipient fruit to fall. All that is needed for protection of outside borders is a covering to prevent chill from frost and snow.

Succession Houses.—Lose no time in putting the houses and trees in order. It is not sound and safe to defer pruning and dressing the trees until the buds begin swelling. Insecticides then are more likely to do harm than good. If any trees are swelling their buds more rapidly than is desired, as occurs where the houses have been used for plants, a covering of mats over the lights will prevent the temperature being raised by sun heat to a prejudicial degree, retarding the flowering considerably. Late flowering is mostly a sign of a good set, the sap is less active because the wood is riper and does not evaporate, thereby not exciting root growth unduly.

Late Houses.—Let the lights remain off these until the flower buds swell. Complete, however, the pruning and dressing of the trees and cleansing of the house, as favourable weather for such work offers. The buds take no harm until they commence swelling, and even then are proof against frost until the flowers show clear of the scales of the buds. Then the lights must be put on, for which there usually is no necessity until middle February or early March.

CHERRY HOUSE.—Having been closed last month, as advised, and frost excluded from the house, gentle excitement will have taken place, and fire heat may now be applied so as to maintain a temperature by artificial means of not more than 40° at night and 45° in the day, advancing 10° from sun heat, ventilating at 50° and closing at that point. Ventilate very freely in mild weather, and avoid hasty treatment in the early stages of growth. Make sure that no deficiency of moisture exists in the soil, and see that trees in pots or tubs are not neglected for water. Sprinkle the trees and house occasionally in the morning and afternoon in bright weather, but avoid keeping the trees dripping with moisture, and ventilate a little constantly, as a close atmosphere weakens the blossoms even when they are enveloped in the scales of the buds. Cherries can hardly be brought on too slowly in the early stages of forcing.

MELONS.—Seed should be sown at once for the first crop. The seeds are best sown singly in 3-inch pots, or a dozen or more may be placed round the edge of a 6-inch pot, the seedlings to be transferred singly into 3-inch size. Whichever method is pursued the pots should only be about two-thirds filled with soil, covering the seeds about half an inch deep, plunging the pots in a bottom heat of 80° , placing a square or squares of glass on them to bring up the seeds quickly, and removing it directly the cotyledons lift the soil. Good fibrous loam and leaf soil in equal parts gently pressed down form a porous compost for the young rootlets, the pots being efficiently but not excessively drained. Keep the plants near to the glass, not permitting them to become drawn. Ripe fruit from a sowing made at this time may be expected at the close of April or early in May. A temperature of 65° to 70° at night, and, 70° to 75° by day artificially, is suitable. Varieties are endless, every grower has his special favourite. Blenheim Orange and Scarlet Premier are good scarlet-flesh varieties; Eastnor Castle,

Hero of Lockinge, and Longleat Perfection of the green and white-fleshed sections are good and free.

CUCUMBERS.—Be cautious in cropping young plants just commencing to bear; assist them to swell their first fruits by removing superfluous fruits and staminate blossoms as they appear; trim up plants in bearing twice a week, removing all weakly and exhausted growths, reserving as much of the young growths as can have space for expanding their foliage, but overcropping tends to certain disaster, inasmuch as it must end in denuding the plants of a large extent of foliage. Stop the shoots at one or two joints beyond the fruit, but young plants should be allowed more freedom, avoiding overcropping. The temperature by night should be 65° to 70° , 70° to 75° by day, with a rise of 10° or more from sun heat, admitting a little air at 80° if the external air be warm and soft; but if cold and sharp it is better to allow the temperature to advance a little higher than admit too much cold air, even when the sun is powerful. Canker putting in appearance rub affected parts with quicklime, maintain a drier atmosphere, and sprinkle a little superphosphate of lime over the bed, with a dusting of soot. A little sulphur, brought to the consistency of cream, brushed on the hot-water pipes will keep down red spider and annihilate mildew. It must not be overdone, just a little coating being sufficient; but mildew appearing dust flowers of sulphur over the affected parts. Avoid syringing, but damp the floors and other available surfaces in the morning and early afternoon, using a little weak ammoniated water occasionally. The drainage of stables is excellent for this purpose diluted with five or six times its bulk of water.

To secure plants for growing in frames or pits heated by fermenting materials seed should now be sown for February plantings, the materials for which should now be in process of sweetening for making up the beds. Where no convenience exists for raising plants a bed of leaves and stable manure should be made up forthwith, the seed to be sown as soon as the bed affords a suitable temperature—viz., a bottom heat of 90° and top heat of 70° to 75° . A sowing made at this time will yield plants to afford a late spring and early summer supply of fruit. There is not so much variety in Cucumbers as obtains in Melons. We find everything necessary in Telegraph when had true, both as regards size and cropping, but the quality is not always sweet. Cardiff Castle is an everyday throughout the year variety, good in crop, useful in size, and excellent as well as uniform in quality. Tender and True has size as well as quality.

STRAWBERRIES IN POTS.—Proceed steadily with plants that are not required to give fruit at a particularly early stated time, especially in severe weather; 50° to 55° is ample at night for those started in December, and 60° to 65° by day, erring if at all on the safe side—the low; therefore 5° less in cold weather and the absence of sun is advisable. Ventilate whenever there is a chance. The trusses rise boldest and the flowers are strongest when the plants have the foliage well elaborated. Close atmosphere induces soft tissues, weakly organs of fructification, imperfect sets, and deformed ill-shapen fruit. Introduce more plants to shelves in Peach houses or vineries started about this time. Rectify the drainage of the pots, remove moss or other matter from the surface of the soil, and wash the pots clean. Surface dress with an approved fertiliser mixed with a little fine soil, or steamed bone-meal and soot, a quart each to a bushel of fibrous loam, stirring the surface lightly. If the plants do not push freely use a little nitrate of soda or nitrate of potash (saltpetre). They wake up sleepy plants because their sluggishness arises from a deficiency of sodic or potassic elements, but be careful against excess; half an ounce to a gallon of water is ample. Soda is best for plants potted in light soil, potash for those in heavy. Noble is an excellent variety for introducing now to fruit in April, also Auguste Nicalse, the latter being the brighter fruit, equally large, prolific, and of better quality. President, Sir Joseph Paxton, and Sir Charles Napier may also be introduced, but to maintain the succession plants of La Grosse Sucrée or Vicomtesse Hericart de Thury must also be introduced at the same time.

THE FLOWER GARDEN.

Bedding Plants in Frames.—This is a very trying winter for bedding plants in frames, and in all probability many of those in charge of small gardens will lose the greater part of their stock of the more delicate kinds. It has been unsafe to uncover the lights for at least three weeks together, and in some instances they have been hermetically closed for fully one month. This blanching process must inevitably greatly weaken the plants, and unless more than ordinary precautions have been taken the frosts will also have penetrated to the interior of the frames. Anything in the shape of a sudden thaw would prove most ruinous to the plants generally, and it is not advisable, therefore, to uncover frames directly there is a change in the weather. The better plan is to leave them closely covered up for one or two days or till it is seen all are properly thawed, when they may be gradually uncovered and given air when it is warm.

Plants Injured by Frost.—Once they have been injured or much pinched by frosts tender plants become even more tender, and consequently will require very close and good attention to keep them alive. The heavy snow which fell in many parts of the country will have done much towards excluding frosts; but more of the latter may be experienced without a covering of snow to moderate its effects. In anticipation of this all frames and pits from which frosts must be excluded ought to be heavily surrounded with either dry strawy litter, bracken, or leaves enclosed by hurdles. Much of what may have previously been used in a similar matter would, after the snow has

thawed, be far too wet to be of any service, this conducting rather than excluding extreme cold. More of the dry litter to be in readiness for covering the mats or old carpets that are thrown over the lights. Keep the plants as dry as possible, and remove all decaying stems and leaves whenever discovered.

Preparing for Possible Failures.—Although Zonal Pelargoniums, Calceolarias, Verbenas, and other tender plants are not nearly so much used in the flower garden as in former years, there is yet a considerable number required in most places, and should there be a possibility of a scarcity substitutes must be found. Neither Pelargoniums nor Calceolarias fit for bedding out can be raised from seed, and the cheapest substitute for the former will be found in dwarf Tropæolums, of which there are several very showy compact varieties that come true to name from seed, and if not unduly crowded are very effective. Tuberos Begonias are superior to either these or Pelargoniums, and it is possible to raise a stock of these from seed ready for bedding out next June. Dwarf French Marigolds and *Tagetes signata pumila* are perhaps the best substitutes for Calceolarias, though *Gaillardias picta* and *Lorenziana* are easily raised from seed, and present a gay appearance in flower beds or borders. Verbenas are not difficult to raise from seed, and beds of mixed seedlings are pleasing. So also are beds of Phlox Drummondii, either in separate colours or in mixture. Antirrhinums if strong plants are put out are very showy in beds and borders, as also are Stocks, Asters, Zinnias, Godetias, Sweet Sultan, Petunias, and a few other annuals and biennials. *Nicotiana affinis* is very effective in borders, and so also is the variegated Maize or *Zea japonica variegata*. Dahlias also can be raised from seed, but plants raised from cuttings of named sorts are preferable. Centaureas can be raised from seed in time to be out this season, and a stock of seedling plants of the silvery-leaved *Cinerarias maritima* and *aconitifolia* might prove very serviceable. The new *Dracæna* or Croton-leaved Beet is the best substitute for Iresines, while for edging purposes hundreds or thousands of Golden Pyrethrum, dwarf Lobelias and Ageratums can each be had from single packets of seed. Some or all of the foregoing ought then to be ordered with the other seeds now, in order to have them in readiness when the proper time for sowing arrives.

Starting Stock Plants.—Where there is only a moderately large stock of old plants wintered for the purpose of affording cuttings these might well be introduced into gentle heat shortly. A newly started vinery or Peach house is particularly well adapted for this purpose, the plants producing better cuttings, and are less liable to be infested by red spider and thrips than is the case if they came into contact with a variety of stove plants. Zonal Pelargoniums, Heliotropes, Verbenas, Abutilons, and Fuchsias are principally started into active growth at this early date. Matured tops of the former will not strike with any certainty unless first subjected to gentle heat for a few weeks. After these are taken off and rooted there will yet be good time for a number of side shoots to form and be propagated. Large boxes or pots full of old plants of either flowering or variegated varieties, and which were cut well back when lifted, ought now to be started in heat. They will soon yield a number of cuttings, the plants obtained in this way frequently proving very serviceable.

Rabbits in the Flower Garden.—Rabbits appear to be unusually plentiful this winter, and never before has greater destruction among shrubs and flowers taken place. Long-continued severe frosts and much snow has deprived the rabbits of their ordinary means of sustenance, and as a consequence trees, shrubs, and flowers have been badly preyed upon by them. They appear to prefer the bark to foliage, the former probably being the least bitter, and if many thousands of trees and shrubs are not completely ruined they must, at any rate, be sadly crippled. Galvanised wire netting sunk well into the ground will usually exclude rabbits and hares from the pleasure grounds, but with snow banked against this they can walk over easily enough. Stems may also be enclosed either with strips of bark, thorn bushes, or a coating of cart grease with which gas tar has been freely added. They do not like the smell of petroleum, but hunger soon forces them to face this. In order, therefore, to save the shrubs, Roses, Carnations, and such like, it is advisable to feed the rabbits with Swedes, Turnips, and Mangold Wurtzel roots. That is the best preventive.

THE BEE-KEEPER.

APIARIAN NOTES.

THE LATE ALFRED NEIGHBOUR.

I HAVE but lately received an intimation to the effect that Mr. Alfred Neighbour died at 1, Accl Road, West Hampstead, on the 19th of December, 1890, aged sixty-five years. Coming near the end of the year, and being but one of many intimating the death of many old associates and intimate friends, brought sadness and reflection. It is nearly thirty years since I became acquainted with Mr. A. Neighbour. His first letter to me imbued me with

confidence that he was a gentleman of sterling worth, and many business transactions proved him to be so in deeds as well as in name. Honourable in every transaction, at all times anxious to have the "best material and workmanship," always glad when he had been the means of assisting those in distress, "never letting his right hand know what his left hand did." As an apiarian no person has done for bee-keeping what he has. He was the pioneer in all improvements, and the introducer of the foreign races of bees that have been the means of raising the honey yield of this country. If comb foundation was not first made by him it is to him that we are all indebted for its introduction and manufacture in this country. He supplied friends and foes alike with plates, and instructions how to make them, both to Britishers and Americans.

Although a quiet and unassuming man he yet possessed considerable humour, and that in addition to his other qualities made him a very agreeable companion to ramble with. His articles were always well written and to the point, free from exaggeration, but always truthful. Possessing a large library of works on bees and being a practical bee-keeper, he possessed much knowledge on bee matters. As author of "The Apiary" he gained much confidence with many ladies and gentlemen throughout the empire. He has left a widow to mourn the loss of a loving and faithful husband.

THE WEATHER.

We have had a long, but not severe, frosty weather, and without snow. Since January 1st a mildness has set in, but has become foggy, with indications of a renewal of frost. The change has enabled the bees to make a movement inside the hive, which will be to their advantage, but very few bees flew.

FLOWERS INTOXICATING BEES.

Mr. Arnott mentioned lately that bees become intoxicated when working upon *Sedum Fabaria*, a thing at that date unobserved by me, but shortly after, while watching for the phenomenon, I noticed one bee alight, and almost instantly appeared drowsy, but on my approach it flew off. This bee, if it was under the influence of any somniferous agent, it must have been from the odour, and not from the nectar which it had not tasted. Some flowers affect people in a similar manner, and if I am right in my conjectures, a field for investigation is opened up. Thistles and other flowers possess the same peculiar influence, and I trust Mr. Arnott will give the subject due attention when the time comes round, and let us all know the facts.

FEEDING BEES.

I have only seen my hives once since the first day of December, on which the bees were flying and carrying pollen, and I was putting some little matters right, when I accidentally touched and moved a hive, the heaviest I had. I was surprised how light it seemed from what it was two months previous. The mild weather in December contributed largely to the decrease in weight. It was too late to feed or disturb them in any way, but on the first opportunity, after the bees have aired themselves, I shall give a little syrup in tin scoops holding from 3 to 6 ozs. These scoops are pushed underneath the combs from the front or other parts, and have a spale of wood as a float, and are kept flush with the hive, so that bees are not marred on their return. This method is the speediest, safest, and best of any for feeding in the spring. Crown feeding is troublesome, for it causes a draught, cools the hive, and brings on dysentery. Giving candy on the top of the hive is not advisable, although its advocates say the vacuum formed by the quilt going over it, together with its consumption, gives a warm retreat for the bees. This entirely falls through when we are told by one of its advocates in replying to a correspondent, who complains of the absence of heat on the crown of a hive, says, "You will find the warmth very perceptible when breeding begins."

Unless the heat of a hive is kept up during the winter months, so that it can be felt when the hand is placed upon the crown of the hive, there is something wrong, and the best thing to maintain warmth is dried grass, not woollen fabrics that become damp.

The mouse's nest is the best example to take for the covering of a hive. Very often when the question is asked why there are so many dead bees about, the answer is almost invariably, "They are the old bees." I do not believe that; they are dead bees through some fault of the apiarist. "Bees only live forty-five days in summer," is another modern mistake, but not an invention of mine.

Owing to the untoward season of 1890, few, if any, bees were hatched after the middle of August, but the bees had a busy time of it from the 1st of September, and continued more or less working till the first day of December, yet our hives are formed of the same bees, with but little exception, that were alive in June and July, and will continue, I hope, till summer comes.—A LANARKSHIRE BEE-KEEPER.

TRADE CATALOGUES RECEIVED.

Dobbie & Co., Rothesay, Scotland.—*Catalogue and Competitors' Guide.*

G. Bunyard & Co., Maidstone.—*Catalogue of Seeds.*

J. R. Pearson & Sons, Chilwell.—*Catalogue of Chrysanthemums.*

Hooper & Co., Covent Garden and Maida Vale.—*Seed Catalogue, 1891.*

H. Cannell & Sons, Swanley and Eynsford.—*Catalogue of Seeds, 1891.*

Biddles & Co., Loughborough.—*Catalogue of Seeds, 1891.*

E. P. Dixon & Sons, Hull.—*Catalogue of Garden Seeds.*

J. Cheal & Sons, Crawley, Sussex.—*Catalogue of Garden Seeds and Sundries.*

Little & Ballantine, Carlisle.—*List of Garden Seeds and Sundries.*

Barr & Son, 12, King Street, Covent Garden.—*List of Flower and other Seeds.*

William Etherington, Swanscombe, Kent.—*List of Chrysanthemums.*

Alex. Lister, Rothesay, N.B.—*List of Vegetable and Flower Seeds.*



* All correspondence should be directed either to "THE EDITOR" or to "THE PUBLISHER." Letters addressed to Dr. Hogg or members of the staff often remain unopened unavoidably. We request that no one will write privately to any of our correspondents, as doing so subjects them to unjustifiable trouble and expense.

Correspondents should not mix up on the same sheet questions relating to Gardening and those on Bee subjects, and should never send more than two or three questions at once. All articles intended for insertion should be written on one side of the paper only. We cannot reply to questions through the post, and we do not undertake to return rejected communications.

Appliance (*Constant Reader*).—What you suggest is not contrary to our rules, and you are quite at liberty to carry out your proposition.

Strawberries in Pots (*S. J. B.*).—You cannot do better than carry out your proposition, and plunge the pots in which the plants have not rooted freely in a bed of leaves where there is a gentle warmth, but not until the growth which is thereby started can be steadily continued, or not subjected to any check. You are wise in not attempting to force the plants early. If after potting they make no fresh roots whatever in the new soil it might be advisable to remove this soil, which must be more or less soddened, and place the plants in a free root-inciting compost, such as loam, leaf mould, and wood ashes, with a dash of superphosphate of lime, if you have any—say a 5-inch potful to a bushel of the compost, mixing well. The chemical manure named is very useful in gardens.

Winter-flowering Carnations (*Idem*).—Miss Joliffe is one of the most floriferous, and other good varieties are A. Alegatière, Anda-

lusia, Irma, Ruby, Rufus, La Perle, Mdle. Carle, Vulcan, Winter Cheer, Empress of Germany, La Belle, and Prince of Orange.

Gesnera cinnabarina (*B. S.*).—This is one of the most brilliant and beautiful of stove plants for flowering in the winter. Those which you have seen and admired were probably started about midsummer. We have potted tubers at that time, and started them in a frame, and have grown the plants in it till September, or as long as the weather was warm enough, then placed them on a shelf in the stove. They usually commenced flowering in January, or when the Poinsettias were nearly over, producing an effect not surpassed by those plants during a period of two months. Fine plants may be grown in 6-inch pots, forming dense pyramids of orange-scarlet flowers and handsome velvety leaves, which contribute materially to the beauty of the plants.

Stakes for Trees (*G.*).—The best we have used are of Larch, the young trees or the tops off them thinned from crowded plantations and divested of their side growths. We have found these to last longer than Oak, or any other wood, probably because of the turpentine in the Larch. Cresote is a good preserver of wood. It can be had from chemists, and should be used hot, the end of the stakes being placed in an iron vessel containing it over a fire and boiled. Some persons dip stakes in molten pitch, and others char them by inserting their ends in a fire for a time, then withdrawing them and slaking with water. This is a simple and good plan when well carried out; but whatever method may be adopted of preserving the wood, it must be applied not to the points of the stakes alone, but 3 inches above the part inserted in the ground. Stakes decay more rapidly quite close to the surface of the ground than several inches below. We have been told that stakes soaked in petroleum are rendered additionally durable, but we have not tried it.

Violets in Frames (*J. Evans*).—The method of culture in preparing Violets for flowering in frames in the winter is practically the same as that adopted in growing Strawberries, only rooted runners of Violets can be had in April, while Strawberries cannot be layered before June. In soil prepared as if preparing for Strawberries, and in an open position, plant rooted runners or offsets of Violets during showery weather in April. Compact growers, such as Devoniensis, a very useful single, and Marie Louise, a valuable double variety, may be inserted a foot apart in rows 18 inches asunder; but such strong growers and fine varieties as Victoria Regina and Prince Consort need more space, and the plants should be 18 inches apart, in rows 2 feet asunder. Those named are excellent varieties, and if Argenteæflora is added you may have abundance of flowers in different colours from September onwards throughout the winter, provided you can maintain a night temperature in the frames of 40° to 45°, not otherwise, as Violets must have a certain amount of heat for insuring a continuous supply of flowers. Violets can be had in winter by taking stout runners and dibbing them an inch or two apart in boxes of good soil—loam and leaf mould—as if inserting cuttings, keeping them constantly moist, and placing the boxes in a light position in a warm greenhouse. Boxes thus filled at the present time and treated as directed will shortly afford quantities of flowers, and young plants of the best character will be provided for future plantations.

Repotting Marantas (*C. M.*).—If the plants require attention in the way you suggest, it should be done during the present month, so that they will have a chance of establishing themselves again before the sun has much power. If they are left till about the middle or end of the following month the sun often proves too strong for them, and they flag severely. These plants will do in the same pots for years provided the drainage is good and the soil about their roots in a sweet condition; but the liberal supplies of water needed during the growing season soon renders the soil unfit for them. They unquestionably thrive best when they are repotted annually. When turned out of their pots and the drainage removed the old soil should be worked from amongst the roots by washing it out in a tank of tepid water. This necessitates the plants being allowed to drain for some hours before they can be repotted. Many of the varieties do well in a compost of fibry loam, one-seventh of manure, charcoal broken according to the size of the plants and pots, with an addition of coarse sand. Others do better in rough peat, the fibrous portion of loam only, and charcoal in lumps. After potting plunge the plants where a night temperature of 65° can be maintained, syringe them freely, but water with great care until the roots are active. The pots used should be liberally drained.

Cattleyas Diseased (*Mal*).—We are always willing to assist inquirers with information upon any subject within the scope of this Journal, but we have also repeatedly stated how desirable it is that those who seek advice should furnish as many particulars as possible respecting the difficulty which is to be overcome. This you have not done, for though you send specimens of leaves, pseudo-bulbs, and roots you do not mention the conditions under which the plants have been grown, the character of the house, the temperature, or indeed anything that could guide us in suggesting a remedy. Beyond this, however, you say that "it is only plants in the best of health that become affected." If the specimens sent are samples of what you consider "the best of health" this is no doubt correct, but we do not regard their condition, apart from the disease, as at all satisfactory. The leaves are comparatively soft, the texture immature, sappy, and exactly such as would at this time of year invite the attacks of fungoid and other diseases. This may be due to several causes—excessive moisture with too low a temperature, insufficient ventilation earlier in the season, and undue shade. Cattleyas will endure much more exposure to sun than is ordinarily supposed, and while direct exposure to the sun in hot weather

undesirable the ripening effect produced by abundance of light and the careful avoidance of heavy or prolonged shading is a great advantage to the plants. Well-grown Cattleyas that completed their growth before winter have leaves as firm as leather, and are therefore better prepared to resist the trials of a winter in this climate than those with soft and fleshy foliage. The roots of your plants, too, indicate that all is not well with them. Possibly the peat in which they are grown is unsuitable, or water may have been too freely supplied under the conditions named. We have seen important collections partially ruined by excess in this matter, and it is one of the dangers that have to be contended with under the "non-shading" system some have advocated and practised. Whenever plants of any kind are weakened in constitution they are liable to be attacked by fungoid diseases. Orchids are subjected in this way to the evil influence of several species of minute fungi. One of the principal, however, to which spot in Orchids has been attributed is *Protomyces concomitans*, which spreads very readily, and it is probable that this, with others, has helped the ill effects produced on your plants. The spots and black blotches extend, and a good portion of the leaf and sometimes of pseudo-bulb is destroyed, and though the term "rot" is applied to the more extensive injury they seem to be of similar origin. Cutting away the diseased portions before they are too far advanced and applying sulphur to the wounds has been proved to be advantageous in arresting the progress, but if the plants are badly affected the best plan is either to destroy them or place them where they can be completely isolated from all healthy stock. We suggest that you adopt this course at present, maintaining a temperature of 55° to 60°, giving comparatively little water, either in the atmosphere or to the roots; but do not allow the leaves to shrivel in the slightest. Allot them a light position, not too near the glass, and where they will be safe from drip; then, when they are potted, see that the material is good, free from decaying substances, and cut away all bad roots. Employ clean well-drained pots, and give the plants another trial under the conditions advised—*i.e.*, plenty of light, a good temperature rising to 70°, and more with sun heat, and liberal ventilation in fine weather, but avoiding cold draughts and chills. If this treatment produces no satisfactory results your only course will be to procure a fresh healthy stock, and follow the system advised from the first. If you wish to have the stamps returned please supply your full postal address. We cannot be made the medium of forwarding anonymous letters to anyone.

Names of Fruits.—The names and addresses of senders of fruit to be named must in all cases be enclosed with the specimens, whether letters referring to the fruit are sent by post or not. The names are not necessarily required for publication, initials sufficing for that. Only six specimens can be named at once, and any beyond that number cannot be preserved. (*Lieut.-Col. Thomas*).—The Apple is in all probability a local seedling, and has no generally recognised name. (*F. L.*).—1, Bramley's Seedling; 2, Lane's Prince Albert; 3, Mère de Ménage; 4, Blenheim Pippin; 5, Dumelow's Seedling; 6, Court Pendù Plat. We only name six varieties, according to rule.

Names of Plants.—We only undertake to name species of plants, not varieties that have originated from seed and termed florists' flowers. Flowering specimens are necessary of flowering plants, and Fern fronds should bear spores. Specimens should arrive in a fresh state in firm boxes. Slightly damp moss, soft green grass or leaves form the best packing, dry wool the worst. Not more than six specimens can be named at once, and the numbers should be visible without untying the ligatures, it being often difficult to separate them when the paper is damp. (*A. B.*).—1, A small and pale variety of *Maxillaria picta*; 2, *Polypodium aureum*. (*W. R.*).—1, *Adiantum cuneatum* var. *deflexum*; 2, *Adiantum mundulum*. (*H. S.*).—*Trifolium arvense* (the Hare's-foot Trefoil). (*J. H. B.*).—The *Cypripediums* are as follows:—1, *C. Sedeni*, a hybrid between *C. Schlimi* and *C. longifolium*, one of the most useful Orchids grown, as it is nearly always in flower; 2 is a good variety of *C. insigne*; 3, *C. villosum*.

COVENT GARDEN MARKET.—JANUARY 7TH.

THE long-continued frost is seriously checking business in this market, and with foreign goods arriving in poor condition prices of sound goods are high.

FRUIT.

	s.	d.	s.	d.		s.	d.	s.	d.		
Apples, ½ sieve	1	6	to	6	0	Lemons, case	20	0	to	28	0
" Nova Scotia and						Melons, each	1	0		2	0
" Canada, per barrel	15	0		26	0	Oranges, per 100 ..	4	0		9	0
Grapes, per lb.	0	9		3	0	St. Michael Pines, each..	2	0		8	0
Kentish Cobs	55	0		60	0	Strawberries, per lb. ..	0	0		0	0

VEGETABLES.

	s.	d.	s.	d.		s.	d.	s.	d.		
Artichokes, dozen ..	0	0	to	0	0	Mushrooms, punnet ..	1	6	to	2	0
Beans, Kidney, per lb. ..	0	6		0	0	Mustard & Cress, punnet	0	2		0	0
Beet, Red, dozen	1	0		0	0	Onions, bushel	3	0		4	0
Brussels Sprouts, ½ sieve	2	6		3	0	Parsley, dozen bunches	2	0		8	0
Cabbage, dozen	1	6		0	0	Parsnips, dozen	1	0		0	0
Carrots, bunch	0	4		0	0	Potatoes, per cwt. ..	3	0		4	0
Cauliflowers, dozen ..	2	0		4	0	Rhubarb, bundle	0	2		0	0
Celery, bundle	1	0		1	3	Salsafy, bundle	1	0		1	6
Coleworts, doz. bunches	2	0		4	0	Scorzoner, bundle ..	1	6		0	0
Cucumbers, doz.	2	0		3	6	Seakale, per bkt. ..	2	0		2	6
Endive, dozen	1	0		0	0	Shallots, per lb. ..	0	3		0	0
Herbs, bunch	0	2		0	0	Spinach, bushel	5	0		6	0
Leeks, bunch	0	2		0	0	Tomatoes, per lb. ..	0	4		0	8
Lettuce, dozen	0	9		1	3	Turnips, bunch	0	0		0	4

AVERAGE WHOLESALE PRICES.
CUT FLOWERS.

	s.	d.	s.	d.		s.	d.	s.	d.		
Arum Lilies, 12 blooms ..	4	0	to	12	0	Mimosa (Fench.) per bunch	0	0	to	2	0
Bouvardias, bunch	0	6		1	6	Narciss (Paper - white),					
Carnations, 12 blooms ..	1	0		2	6	" French, doz. bunches ..	4	0		10	0
Chrysanthemum, 12 blms.	1	0		3	0	" Do. English,					
" 12 bunches	3	0		9	0	" per bunch	1	0		1	6
Epiphyllum, doz. blooms	0	4		0	6	Pelargoniums, 12 trusses	1	0		1	6
Eucharis, dozen	3	0		6	0	" scarlet, 12 bunches	4	0		6	0
Geraniums, 12 blooms ..	6	0		9	0	Poinsettia, dozen blooms	4	0		9	0
Hyacinths (Roman), doz.						Primula (double) 12 sprays	0	6		1	0
" sprays	0	6		1	6	Roses (indoor), dozen ..	0	6		1	6
Lapageria, 12 blooms ..	2	0		4	0	" Red, 12 blooms ..	1	0		2	0
Lilac (French) per bunch	5	0		8	0	" Tea, white, dozen ..	1	0		3	0
" longiflorum, 12 blms.	4	0		6	0	" Yellow	3	0		5	0
Lily of the Valley, dozen						Tuberoses, 12 blooms ..	0	4		0	9
" sprays	3	0		6	0	Tulips, per dozen	1	0		2	0
Maidenhair Fern, dozen						Violets (Parme), per beh.	0	0		8	0
" bunches	4	0		9	0	" (dark), per beh. ..	2	0		3	6
Marguerites, 12 bunches	2	0		6	0	" (English), doz. bunch	1	0		2	0
Mignonette, 12 bunches..	3	0		6	0	Wallflower, doz. bunches	3	0		6	0

PLANTS IN POTS.

	s.	d.	s.	d.		s.	d.	s.	d.		
Aralia Sieboldi, dozen ..	6	0	to	12	0	Hydrangea, doz. pots ..	9	0	to	18	0
Arbor Vitæ (golden) doz.	6	0		8	0	Lilium lancifolium, doz.	0	0		0	0
Chrysanthemum, per doz.	6	0		24	0	" longiflorum, doz.	0	0		0	0
Climbing Plants, various,						Lily of the Valley, per pot	4	0		6	0
" dozen pots	4	0		9	0	Lobelia, per doz.	0	0		0	0
Dracæna terminalis, doz.	24	0		42	0	Marguerite Daisy, dozen	6	0		12	0
" viridis, dozen ..	12	0		24	0	Mignonette, per dozen ..	4	0		6	0
Epiphyllum, per dozen ..	12	0		30	0	Musk, per dozen	0	0		0	0
Erica, various, dozen ..	12	0		18	0	Myrtles, dozen	6	0		12	0
Euonymus, var., dozen ..	6	0		18	0	Nasturtiums, dozen pots	0	0		0	0
Evergreens, in var., dozen	6	0		24	0	Palms, in var., each ..	2	6		21	0
Ferns, in variety, dozen..	4	0		18	0	Pelargoniums, per doz. ..	0	0		0	0
Ficus elastica, each ..	1	6		7	0	Poinsettia, per doz. ..	9	0		15	0
Foliage plants, var., each	2	0		10	0	Rhodanthe, per dozen ..	0	0		0	0
Fuchsia, per doz.	0	0		0	0	Stocks, per doz.	0	0		0	0
Geraniums Scarlet, p. doz.	2	0		6	0	Tropæolums, various, per					
Hyacinths (Roman), doz.						" dozen	0	0		0	0
" pots	8	0		10	0	Tulips, dozen pots	8	0		12	0



DAIRY AND FRUIT FARMING.

In his address to the pupils of the Aspatria Agricultural College, at the prize distribution in December, Sir James Whitehead called particular attention to these two branches of farming, pointing out in clear and forcible terms how much both were neglected, how speedy improvement was possible, and how profitable such improvement would prove as an adjunct to the usual round of crops, and thus furnish that margin of profit which is required for the provision of a just rent for the landlord, a comfortable living for the tenant, and fair wages for the labourer. To the pertinent inquiry why in our large towns butter from Denmark and Brittany sells at higher prices than our own, Sir James was undoubtedly quite right in answering that it was owing to the careless and unscientific preparation of our own dairy produce and the skilful and intelligent treatment of it in those countries. He also explained how dairy farming had been taken up by the Danish Government as a matter of national importance, how skilful instructors were sent to all parts of the kingdom, and inspectors kept in every market, so that if any dairy is found to be sending out butter of an inferior quality an inquiry is instituted and the defects remedied, and how this judicious combination of practice with science accounts for the high reputation which Danish butter has in the London market for uniformity and excellence.

Brief, but pithy and forcible, remarks on poultry came next. "Why," it was asked, "do we need to import millions of pounds worth of eggs and poultry every year? There is but one answer. It is simply from lack of enterprise and information." As a lesson in enterprise the recent action of Canadian farmers may be cited. The heavy blow dealt them by the McKinley Tariff, by which their trade with the United States was practically ruined, induced them to look elsewhere for a market. The fact that we annually import about 1,200,000,000 eggs impelled them to try once more the experiment of sending eggs to the English market. The first consignment arrived in excellent condition, and the eggs met with

a ready sale at from 9s. 6d. to 11s. 6d. per ten dozen. Other consignments followed promptly, and nearly 2,000,000 eggs have arrived in Liverpool since the McKinley Tariff became law. After paying freight and commission the sellers find their profits are better than when they supplied the United States markets, and so the trade is likely to attain enormous proportions.

Turning to fruit culture, the speaker dwelt at considerable length upon the enormous importations of fruit into this country, much of it coming from countries where the climate is no better than our own, which gave force to the assertion that we can and ought to grow much of it for ourselves. A quotation from Mr. J. Wright's prize essay on "Profitable Fruit Growing" showed that the obstacles which stand in the way are "lack of knowledge on the subject, of enterprise in producing fruit in its best form, and of art in placing it before the public." Examples of successful fruit culture were given from the same work, and mention was also made of the remarkable fact that the fruit from Lord Sudeley's fruit farm of 500 acres realised £10,000 last year. We entirely agree with the suggestion that landlords should not only find fruit trees for their tenants, but also have the planting and pruning done by their gardeners. Farmers generally are entirely ignorant of the art of pruning and planting fruit trees, as well as of the best sorts to plant. The landlord has a vested interest in this work, for it unquestionably eventually augments the value of the land very considerably, and, therefore, it is for him to have it done in the best manner.

There can be no doubt that a gradual change is being made in our farm management, but farmers are slow to change; and although Sir James Whitehead's address is altogether admirable and well timed, and is calculated to act as an incentive to increased exertion, it must not be forgotten that almost up to the eighties corn growing was the most profitable occupation on farms, and that when corn fell in price it was difficult to realise the fact of the permanent and serious character of the reduction. That action was taken in the right direction the following summary, made in 1888, of the average annual amount realised by the sale of the farm products of the United Kingdom, calculated upon the average of the seasons of the three previous years, will show:—

Corn crops	£36,763,834
Green crops	17,441,555
Hay, Flax, Hops, Orchards, and Market Gardens	20,701,274
Meat, Hides, Skins, and Wool	84,885,492
Horses	5,197,500
Dairy produce, &c.	42,043,912
	£207,033,567

The &c. in dairy produce is £7,000,000 for poultry, pigeons, and eggs, so that dairy produce then compared favourably with corn crops, and it is certain that accelerated progressive reform in the same direction has been going on in the last two years.

The agricultural returns for 1890 show a remarkable increase in the average of orchards, market gardens, and small fruit. For small fruit alone—that is, Strawberries, Raspberries, Gooseberries, Currants, &c., there were 4300 more acres employed than in 1889, and there never were so many acres of orchards recorded before. In 1873 there were not 150,000 acres of orchards in Great Britain, now there are 202,305. These returns were made last June; those of next June will probably show a still more remarkable advance in both branches of agriculture, and at the end of another decade the balance of farm crops will have become fully adjusted, the corn area will have reached its minimum of contraction, much faulty permanent pasture will have been brought under a course of alternate husbandry, and the land thus rendered far more profitable for dairy farming than it is now. Old orchards of worthless fruit will have been destroyed or grafted with really good sorts, new orchards will be in full bearing, and the efforts of Sir James Whitehead, as Master of the Fruiterers' Company, and his co-workers of the British Fruit Growers' Association will, we con-

fidently predict, be crowned with that large and full measure of success which they so richly deserve.

WORK ON THE HOME FARM.

To the home farmer this severe weather offers an opportunity to push forward much of the estate work which so frequently proves a hindrance to him at busy seasons of the year. The carting of timber, faggots, gravel for roads, building materials and drain pipes should now be pushed on. If the estate owns a traction engine the agent should be asked to allow it to be used for timber haulage, and horses be kept to lighter work. An order for horses to be sent from the home farm for timber work is never a welcome one, especially when roads are slippery, for however carefully horses are roughed there is much risk of injury from falls in hauling heavy timber logs. The harness suffers so much damage too, that extra chain traces and straps are always taken out for such work. If it is unavoidable make the best of it, and send old and steady horses and experienced men accustomed to the work, as that makes all the difference between smooth progress and much blundering and unnecessary straining of tackle.

This cessation of work on the land also affords a favourable chance for repairing yards. We are carting gravel and chalk on an off-hand farm to the rick-yard which has long been in an unsatisfactory condition, and we now hope to make a thoroughly hard, firm surface to it, sufficiently raised to throw off rain water quickly to the delight of our bailiff there, who has repeatedly called our attention to it—so frequently that he must have lost faith in our promise to bear it in mind. But under the unfavourable conditions of farming in recent years expenses have had to be curtailed in every way. The hardening of soft roads, too, should also be done, and we are doing this at another farm, which though an old part of the estate has never had a hard road from the public road to the homestead. There, also, the horse yard much required a coating of hard materials, and we hope to finish all such work now, even to hardening the margins of the horse and cattle ponds as we recently explained.

How anyone can keep horses out on pasture in this severe weather passes our comprehension. We recently saw about a dozen large trees in a conspicuous clump in a park off which the horses had eaten every particle of bark from the ground up as high as they could reach; nor could we wonder, for with pasture covered with frozen snow, and only a bite of hay once a day, the poor brutes must be ravenously hungry. The trees will die, and we should not be surprised if the horses died too, after such exposure.

OUR LETTER BOX.

Prize Roots (H. R. W.).—To have roots of an extraordinary size the soil must be worked deeply, manured extravagantly, and kept full of the best plant food and moisture throughout the period of growth. To this end keep to the spade culture in which you have been so successful, work in as much rich farmyard manure as you can cover well in a wide trench, sow the seed so that the plants may be from 30 to 36 inches apart every way, then saturate the soil with liquid manure. When the plants are well up and are singled apply a surface dressing of the chemical manure mixture we gave on page 22. Wash it well into the soil with sewage or other liquid manure, and at once follow with a surface dressing of 2 or 3 inches of farmyard manure, taking care to afford the plants ample space in it. Continue using liquid manure freely twice a week, watch the progress of growth closely, and give any fillip to it as becomes necessary by surface dressings of nitrate of soda before using the liquid manure. Take especial care that the leaves sustain no injury when the liquid manure is used, as damaged foliage really means checked growth. If the soil is well drained and you have plenty of liquid manure some may be advantageously applied three weeks or a month before sowing, and it may then be given much stronger than afterwards.

METEOROLOGICAL OBSERVATIONS.

CAMDEN SQUARE, LONDON.

Lat. 51° 32' 40" N.; Long. 0° 8' 0" W.; Altitude, 111 feet.

DATE.	9 A.M.					IN THE DAY.				Rain
	Barometer at 32° and Sea Level.	Hygrometer.		Direction of Wind.	Temp. of soil at 1 foot.	Shade Temperature.		Radiation Temperature.		
		Dry.	Wet.			Max.	Min.	In sun.	On grass	
1890-91. December and January.	Inches.	deg.	deg.		deg.	deg.	deg.	deg.	deg.	In.
Sunday	30.205	30.8	30.2	N.E.	34.0	32.3	27.9	32.9	23.8	—
Monday	30.259	28.1	27.7	N.E.	33.9	28.4	27.6	29.8	27.2	—
Tuesday	30.274	24.7	24.2	E.	33.9	26.3	23.7	30.3	23.3	0.010
Wednesday ..	30.206	26.8	26.2	E.	33.9	34.9	19.7	36.3	22.3*	—
Thursday	30.201	34.7	34.1	F.	33.9	37.3	28.4	41.0	25.6	—
Friday	30.224	26.8	26.8	N.E.	33.9	30.3	24.1	30.2	19.2	—
Saturday	30.281	29.3	29.3	N.E.	33.7	35.2	24.2	37.0	19.9	0.052
	30.236	28.7	28.4		33.9	32.2	24.8	33.9	23.0	0.062

* Covered by fresh snow.

REMARKS.

28th.—Fine, but without sunshine.
29th.—Overcast, with frequent slight showers of sleet.
30th.—Overcast, with low temperature and biting east wind; snow in afternoon.
31st.—Overcast throughout; slight sprinkling of snow in afternoon; thaw in the evening.
1st.—Dull morning, fine afternoon with some sunshine.
2nd.—Fog all day, dense in the morning.
3rd.—Fog generally dense in the morning, dull afternoon, with thaw and sprinkling of rain.
Barometer remarkably steady, temperature very low, but not quite so severe as in the previous week.—G. J. SYMONS.

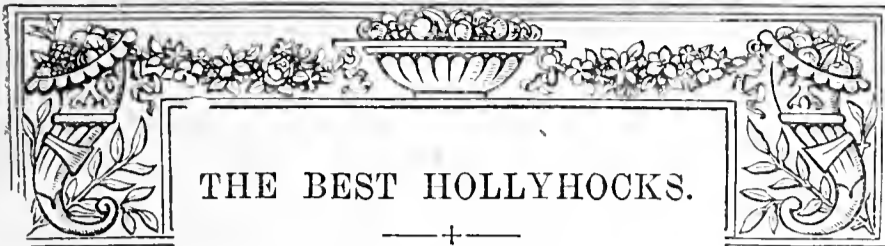

FEW if any subject just now is meriting so much public attention as that which heads this article. It is interesting to review the gradual progress of the revival and improvement of the Hollyhock. About forty-five years ago the first selection of improved and named varieties were introduced to the public by the late William Chater of The Nurseries, Saffron Walden. There were very few growers of the Hollyhock at that time. Mr. Charles Barron, also of Saffron Walden, had a passion for the flower, and by following a course of culture dictated by his own observation and experience originated those flowers which laid the foundation for other cultivators to work upon. From 1846 to 1874, a period of nearly thirty years, the Hollyhock advanced by leaps and bounds until it reached the ideal of perfection, when, unfortunately, the darkest cloud in its history appeared in the form of a parasitic fungus known to mycologists by the name *Puccinia malvacearum*. In some places the attacks of this fungus were so severe and its ravages so great that the cultivation of Hollyhocks was abandoned altogether, and for a period of nearly fifteen years the plant has been practically lost to cultivation. There has been, however, a little knot of enthusiasts who have stood faithfully by the Hollyhock during the term of its eclipse, and now that it is emerging from the darkness they are more enthusiastic than ever. These men have not spent all their time in nursing their favourite flower. They have been equally busy in raising new and improved varieties, and although many of the grand old sorts have been destroyed, these later introductions are equally fitted to fill their place; indeed, some of those raised in the north are a great advance on anything we have ever seen. But no sooner are we raising the Hollyhock to its former popular position than we find others ready to throw cold water on the work.

Of all the florists' flowers we are acquainted with the Hollyhock is perhaps the most abused, and I am sorry to record the fact that trade growers seem to be the least aware of it. They do not seem to take any trouble in their selection. Quantity, not quality, is the ideal. This has led to a great confusion of the sorts in cultivation, the majority of which are of no use for exhibition, although sent out with a wonderful recommendation. It is with the object of raising the Hollyhock to a higher position, and representing it in its true character, that I have taken in hand an election of varieties; and it is not without much trouble that I am able to place before the readers of this Journal a revised list of the best exhibition Hollyhocks now in cultivation. I have admitted nothing but what can be authenticated by the raiser's name, and for the cordial assistance I have received in getting this information I avail myself of this opportunity of tendering my warmest thanks.

In the returns and lists before me I have over 400 varieties of named Hollyhocks, a fact which I daresay will astonish most of the growers at the present day, as very few indeed seem to grow more than three dozen varieties which are considered by them admissible for exhibition. There will be undoubtedly a few more good sorts in cultivation which I am not yet acquainted with. These will be admitted as soon as they have been proved here. The majority of Hollyhocks enumerated in trade lists and sent out at the present time are a disgrace to the trade. Where or by whom they have been raised it will be difficult to know, as so many of them are also under wrong names. It is, however, interesting to notice so many of the fine varieties raised by the late Mr. Chater still to the front. How these have been preserved it is difficult to

say, while those of equally fine quality, raised by such noted growers as Messrs. Paul, Pearson, Bircham, Bragg, Roake, Downie & Co., and others have been lost. We have, however, two or three of Downie & Co.'s still in cultivation, notably F. G. Dougall, one of the very best where the true variety is to be had. To place the varieties enumerated in this list in order of merit would be invidious on my part. I have therefore placed them in position according to the number of votes received; some of the new varieties will undoubtedly take a higher place when more largely distributed.

Grace Darling, which heads the list, is first favourite in nearly all the returns, followed closely by Robert Ryle, another grand flower, with every good property. John Finlay, sent out last year, is already a great favourite, and a decided acquisition. Lord Decies, a seedling from Sanspareil, is of equally fine form and distinct in colour. Maggie Bain is a magnificent variety, a colour by itself, so to speak, of a most pleasing shade. Of pure whites we have no advance on Alba Superba, and for a bright yellow we have seen nothing to equal Queen of the Yellows or Golden Drop. The same may be said of F. G. Dougall as a purple; we have as yet nothing to take its place. Cheer is a fine variety and distinct in colour, a leading characteristic in all Mr. Thompson's seedlings. Indeed, the first three dozen at least are all of the finest quality. To preserve these and raise new and improved varieties is a work which I hope will be taken up by many who have hitherto been led to look upon the Hollyhock as a thing of the past.

Seedling raising is undoubtedly one of the greatest pleasures in floriculture. The daily hope of the unfolding of some inestimable gem is always stronger than the constantly recurring disappointment as some fair bud of more than average promise slowly reveals its fault. The Hollyhock, like many other florists' flowers, is a plant that has been taken into high and special cultivation, because of the tendency it exhibits to vary from the seed in form, colour, size, and habit; and although it is often asserted that the flowers represent themselves true from seed I have never been able to verify this assertion. Some trade growers raise a quantity of their stock from seed, believing that both colour and form will be retained. This has undoubtedly led to so many varieties being under wrong names. Last year, for instance, I had seedlings from Purple Prince not one having any resemblance to the parent; the majority were pure white, blush, &c. I merely mention this to show what variety may be expected from the thoughtful selection by cultivators out of the countless types and offers of variety constantly afforded. The Hollyhock has gradually become endowed with nearly every delicate shade and point of beauty which it does so richly possess. It may appear ungrateful to assert that in connection with colour the florist's requirements are as yet far from being satisfied. It is true that, taken in the aggregate, flowers present us with every colour and shade of colour which can be found in nature; but are there not some amongst us who would fain discern each and every of these lovely tints exemplified in each and every species of flower? So much has already been achieved by industry that we must not fix a limit to the results of zeal, patience, and perseverance.

The nearest approach to scarlet shows at once how much a Hollyhock of that colour would be prized. Seed saved from flowers of the most advanced properties fertilised with pollen from flowers possessing such characteristics as we desire to develop or perpetuate is sure to throw out some novelty. I would impress upon all, especially amateurs, the necessity of saving their own seed. The best flowers are invariably saved from home-saved seed. Flowers produced from foreign seed are very coarse and thin as a rule. It is from gardeners and amateurs that we have got the finest flowers in recent years, and to them we must, I am afraid, be still indebted, for very few trade growers indeed seem to take an interest in the Hollyhock, at least with the view of improving the flower.

The disease no doubt frightens many from investing in the work, but we now have this pest so much in hand that plants are grown comparatively free from fungus. Because the fungus

still exists, and probably ever will exist to a certain extent, it is no worse than any other fungoid pests which florists have to contend with. Nor does it attack the plants in the same virulent manner as it did when first introduced. Soot is valuable; quicklime is also a great enemy to all the fungus tribe; and when the ground is thoroughly dressed with these it will kill any spores of fungus that may be resting in the ground; and where plants are treated as advised in a recent issue of the Journal I think there will be no fear of success.—GEO. STEEL, F.R.H.S., *Heatherslaw, Cornhill-on-Tweed.*

EXHIBITION HOLLYHOCKS.

Position.	Name.	Raiser's Name.	Colour.
1	Grace Darling ...	Thompson & Sons	Rosy salmon.
2	Robert Ryle	Oliver	Carmine red.
3	Maggie Bain	Thompson & Sons	Rosy peach.
3	F. G. Dougall ...	Downie & Co. ...	Rosy purple.
4	Le Grand	Chater.....	Salmon flesh.
4	John Finlay	Finlay.....	Vivid crimson.
4	Lord Decies	Geo. Rogerson ...	Dark crimson.
5	Mrs. Geo. Steel...	Steel	Peach, shaded rosy salmon.
5	Agnes Ryle	Oliver	Yellow, stained carmine.
6	Perfection	Chater.....	Silvery flesh.
7	Queen of Yellows	Chater.....	Bright yellow.
7	Alba Superba.....	Chater.....	Pure white.
7	Leviathan	Chater.....	Rosy red.
7	Cheer	Thompson & Sons	Deep pink.
8	Nobilis	Chater.....	Apricot.
8	Ruby Queen	Hawke	Ruby crimson.
8	Favourite	Chater.....	Rosy lilac.
9	W. E. Gladstone	Finlay	Buff, shaded rose.
10	Mrs. Maynard ...	Finlay	Pink, shaded fawn.
11	Mrs. Jos. Oliver...	Steel	Pale flesh, shaded lilac.
12	Hercules	Chater.....	Pale yellow, shaded rose.
12	Peri.....	Chater.....	Creamy white.
13	Mrs. Coddling ...	Coddling.....	Deep salmon.
14	Venus	Chater.....	Rosy flesh.
14	Pride of Layton...	Finlay.....	Salmon flesh.
14	Fire King	Chater.....	Bright crimson.
15	Incomparable ...	Chater.....	Apricot.
15	Walden Queen ...	Chater.....	Flesh, flushed with rose.
16	Conquest	Chater.....	Rich crimson.
17	Majestic	Chater.....	Deep red. [purple.
18	Formosa	A. Rogerson	Blush white, suffused with
18	Acme	Chater.....	Shaded peach.
19	Golden Drop	Chater.....	Deep yellow.
20	Joy	Chater.....	Delicate flesh.
21	Revival	A. Chater	Pale yellowish buff.
22	La Perle.....	Steel	Pale sulphur yellow.
22	Cremorne	A. Rogerson	Buff, shaded rose.
23	Sanspareil	Chater.....	Bright rosy red.
24	Empress of India	Thompson & Sons	White, suffused with purple.
24	Walter Scott	Steel	Buff, suffused with rose.
25	Thos. Fenwick ...	Finlay.....	Shaded pink.
26	Standard Bearer	Chater.....	Cream, stained with rose.
27	Wm. Dean	Downie & Co. ...	Light rosy salmon.
28	Crown Prince ...	Blundell	Rosy carmine.
29	Exultim	Chater.....	Rich shining maroon.
30	Gem of Yellows...	Chater.....	Bright yellow.
30	Carus Chater.....	Chater.....	Dark crimson.
31	Marvellous	Chater.....	Deep orange buff.
32	Talisman	Chater.....	Pale creamy flesh.
32	Ariadne	Chater.....	Pale yellow, stained carmine.
33	King	Chater.....	Orange buff.
34	Champion	Chater.....	Heavy crimson. [mine.
35	Lady Decies	Thompson & Sons	Pale flesh, deepening to car-
36	Princess Beatrice	Blundell	Lemon, stained with rose.
37	Edward Allan ...	Smith	Deep claret.
38	Vesta	Chater.....	Clear flesh.
39	David Low.....	Harrison	Crimson, shaded salmon.
40	Wm. Archer	Webb & Brand ...	Crimson, shaded salmon.
41	Cygnat	Chater.....	Pure white.
42	Dulwich Queen...	Blundell	Pale yellow, stained with rose
43	Princess	Thompson & Sons	Orange buff.
44	General Gordon...	Thompson & Sons	Bright crimson.
45	Ethel Blundell ...	Blundell	Cream, shaded pink.
46	Scarlet Gem	Webb & Brand ...	Reddish crimson.
47	Dreadnought.....	Mann	Deep salmon.
47	Autumn Queen...	Chater.....	Rosy salmon.
48	Job Horsley	Thompson & Sons	Bright rosy red.
49	Merry	Phipson & Sons...	Pinkish rose.
50	Mrs. Sharp.....	Thompson & Sons	Carmined flesh.
51	Hebe	Chater.....	White, stained lilac.
51	Purity	Blundell.....	Delicate pale blush.
52	Henry Irving ...	Blundell.....	Rosy purple.

AN EMIGRANT'S ENTERPRISE.

I ENCLOSE herewith a copy of a letter just received from Mr. Burnett, late of Deepdene, Dorking, which I thought might be of interest to his late colleagues and gardening friends. He writes from Rosedale, Bakersfield, Kern County, California.—J. CHEAL.

"I have settled down here, and taken up 40 acres of land, and had a house built. I have planted 27 acres with Muscat Grapes for raisins, also planted a few acres with Peaches and Pears. The country here is a vast plain, running 400 miles N.W., and from 50 to 100 miles wide, and nearly surrounded by lofty mountains.

"The soil is a kind of decomposed granite of great depth, and with water applied, is apparently very productive. Grapes grow splendidly, and, owing to the absence of rain, raisins can be made of very high quality. My Vines have made remarkably good growth, and I hope to have a sufficient crop next year to pay expenses. In two years they will pay well, and increase in annual value up to five years, when they ought to be worth about £35 per acre per annum net profit, after paying all expenses. The Vines are planted 8 to 10 feet apart, and are kept pruned very low, the Grapes, in fact, lying on the ground; but owing to the extremely dry weather they are never spoiled by the soil.

"The country here, before the introduction of canals for irrigation, was a barren wilderness. But the effect of water on the soil seems like magic. The Company from whom I bought the land own between six and seven hundred thousand acres, and they have only just begun to sell it; and myself and two others were the very first to settle on the desert lands here. The people are coming in to settle very fast. The land is cut up into square miles, which are again cut up into 32 and 20-acre lots, and you can have any quantity that you are able to take.

"There is not much good for any man without money coming here. It requires a capital for a man coming here to take 20 acres of at least £600 or £700. Wages are good, and if work was steady a man would soon make money, but the working men are so numerous that numbers of them are idle.

"Peaches grow and bear remarkably well, and pay well. I have seen some fruit of what is called the Orange Cling, weighing from 1 lb. to 23 ozs. Some of the Peach growers have cleared as much as £60 per acre. Figs and Apricots also do extremely well. It is a little too hot for Apples, but Pears do splendidly. Oranges do very well, but are not grown here for exporting. There seems a market in the Eastern States for any quantity of fruit that can be grown here, and the prices, so far, are much in advance of what they are at home.

"The climate is very hot in summer, but with always cool nights. The autumn months are very pleasant, but now it is chilly and raw. We have not seen much of the sun this month, but all through November the days were bright and warm, with cool, frosty nights and mornings. I do not think we are likely to regret coming here, as there seems every likelihood of making an independency, but still there is no place like home. I miss the Royal Horticultural Society's Meetings, and should like very much to be able to drop in for an hour or two at James Street, or wherever the meetings are held. I am very sorry to see by the Horticultural press that you have lost two prominent horticulturists, Shirley Hibberd, and William Holmes, the Chrysanthemum Secretary."

AN ATTRACTIVE WINTER GARDEN.

A COLD drive was that which I had from Ashby Folville to Syston Junction with worthy farmer Smith on a dark December morning. Fog and frost had clothed every spray of tree and hedgerow with rime, and the first glimpse of the tree beauty, of which I was to see so much that day, came in the guise of a belt of Austrian Pines and Birch trees, with the slender pendant branches all silvered o'er by the hoar frost, imparting an air of wonderful grace and beauty to the heavy dense mass of the Pines. Beyond them the tall spire of Gaddesby Church was only just visible in the mist, which concealed from view most of that famous old building of the Knights Templars, so rich in its elaborate stone carvings and architectural beauty—fit shrine for the tomb of grim old John of Gaddesby, a veritable Red Cross Knight, from whom the village takes its name.

Day was only just breaking as we drove through Gaddesby, and we could only perceive the Birches indistinctly, yet the effect was so striking that it will cling to the memory as another of the many aspects under which this most graceful of native trees presents

itself. It is indeed "a thing of beauty" at every season of the year. Many a time have I gazed with pleasure at its spray, laden with thousands of tiny globules of water, accretions from the fog of a murky November day, so that it literally glistened with brightness amidst its gloomy surroundings. Again in spring time how lovely it is as the first tinge of green from the bursting buds becomes perceptible, in charming contrast with the white barked stem and bright ruddy hue of the branchlets; and again in autumn, when its wealth of summer foliage changes from the soft rich greenery into the bright fleeting glory of autumnal tints it is even more picturesque.

Tall, gaunt, and weird in the mist was the aspect of the Black Italian Poplars which line the road between Gaddesby. There was nothing picturesque about them, nor could one regard them with approval in such a position, for the roots spread so far and wide near the surface as to rob the soil of its fertility, and render a full crop of grass or corn practically impossible. To dwell upon them further here would be foreign to the purpose of this article; but I like to record such notes by the way, and one is always picking up crumbs of knowledge at every turn. And so on to Syston; I to take train for London, and my friend to drive on to Leicester cattle market to purchase some calves.

Not direct to London by fast train this time, for by Mr. J. Wright's kindly advice it was my intention to break my journey at Peterborough to see the trees at Orton Hall. A more unfavourable morning for such a visit could not well be. The fog grew in density, the carriage windows were coated with ice, and when I reached Peterborough one could hardly see clearly across the streets. Through the fog came the sound of the Cathedral bells chiming for morning service, but the Cathedral itself was entirely hidden from view. Yet as I left the town the fog lifted, the sun shone out, and my walk to Orton Longueville was most pleasant. What a pretty village it is! The snug cottages, neat gardens, the church hard by the Hall, open to the village, yet set in thickly clustering timber, the general air of order and comfort, all impressed me favourably, and that impression was certainly strengthened by the hearty welcome I received from Mr. A. Harding, whose contributions to the Journal are so characteristic. Quite sound and sensible, they convey a just impression of a good man and true, who, as I was led to expect, evidently has much more in him than appears on the surface.

Very soon were we among the trees with which the old garden of Orton Hall abounds, and not only did I see hundreds of specimens rich and rare, but much picturesque beauty of grouping that had developed with the growth of the trees, a sure indication of the hand of a master in the planting. Marvellous examples were there of *Thuja gigantea*, every one of them most lovely tapering cones of rich greenery, models of symmetrical growth, of which self-sown seedlings are common enough there, for Coniferæ are evidently at home in the soil and climate of Orton. *Libocedrus decurrens* was even finer than I have seen it in Suffolk, and *Thujopsis borealis* was of one distinct habit and character right down to the ground, and not of two kinds of growth as is so often the case. *Cupressus Lawsoniana* was equally remarkable, the lofty specimens being as fully furnished with growth as I have ever seen its variety *erecta viridis*. And then the *Piceas*! marvellous examples were they of tree beauty, some of the specimens alone being worthy of a special journey to see. But perhaps the most remarkable were the long-leaved *Pinuses*, such as *longifolia*, *ponderosa*, *Benthiana*, and others, all which had grown as freely as other Conifers. My object is not an enumeration of sorts, size, and numbers, that is a thing which could be done with far greater accuracy by Mr. Harding, and I am sure he would interest your readers greatly by doing so; rather do I seek to convey some idea of the beauty and attractions of the garden generally at a season of the year when so many gardens have so little that is worth seeing.

Of such features the old Elms with their Ivy-clad stems springing out of an undergrowth of common Laurel were singularly picturesque. May the hand of no "improver" ever be suffered to approach them, for the scene is unique, and does honour to the good taste of its noble owner, who will not suffer the Ivy to be touched. The Laurels too, are so admirably in keeping, anything like heaviness or monotony being lost in the general effect, and certainly one looks for them in an old garden if anywhere, where at one time they reigned supreme, and were regarded as the choicest of all shrubs. Witness the rhapsody of a contemporary of Spenser in the days of good Queen Bess.

"What might I call this tree? A Laurel? O bonny Laurel!
Necesses to thy bowes will I bow this knee, and vail my bonnets!"

Thuja gigantea is evidently a favourite here, for it has been planted in considerable numbers in distinct groups in several parts of the extensive shrubberies. Near the Alpine garden and fernery

several fine specimens with a fine Holly tree in front heavily laden with rich scarlet berries formed a lovely picture, that glistened with beauty in the bright sunshine. The *Thuja*, too, had been introduced with excellent effect along the sides of the sunken walks of the fernery, its growth being admirably in keeping with the carpeting of Ferns out of which it sprang.

There is nothing monotonous in any part of the garden, where one may ramble for miles among magnificent Yews, along living arcades all arched with mingled evergreen and deciduous growths, with a carpeting of fallen leaves which had been happily left awhile to lend the warm rich tints of red, brown, and yellow to many a half wild scene of beauty. Was it the coming from them out into the Wellingtonia avenue that rendered it so exceptionally impressive? It may be so: one thing is certain, and that is I had never before been so sensible of the unique beauty of this tree, and I have seen it under almost every conceivable guise. The avenue is of considerable length, and contains some hundreds of trees, most of them being perfect specimens, pictures of health and beauty, and so lofty that the sun's rays only touch the upper part of the trees on the north side at this season of the year. That they revel in the deep rich soil is evident from the healthy hue of the foliage, the vigorous leaders, and the large size of the trees, which must rank amongst the earliest that were planted in this country. Clusters of cones and male blossom were plentiful enough too. Mr. Harding has already done something by the removal of trees planted in the Wellingtonia rows, and I venture to suggest that in due course it will be desirable to clear entirely away all tree growth for some distance outside the avenue, so that it may have every possible advantage of soil as well as climate, and no roots of other trees be suffered to approach it.

It is matter for congratulation that this fine place is under the care of so able and intelligent an arboriculturist as Mr. Harding undoubtedly is. I hope I have made evident something of the rich treat I had, and also how possible it is to plant a garden so as to render it always attractive. Taken in detail it has many more features upon which I cannot dwell. I parted from Mr. Harding with a glow of kindly feeling, and much pleasant food for thought in that Great Northern express in which I travelled back to London once more.—EDWARD LUCKHURST.

VARIEGATED FOLIAGED PLANTS FOR DECORATIVE PURPOSES.

At this season of the year, when decorative plants are in great demand, gardeners are often puzzled to supply suitable specimens for table and general house decoration to satisfy critical eyes. For the embellishment of the dining and drawing-room tables, mixing with evergreen plants in groups, in fact for all decorative purposes, no plants can supersede those with variegated or ornamental foliage, and I propose to give a selection of the most suitable, together with a few details respecting the propagation and subsequent cultivation. I offer these remarks not to men who have had great experience in the form of work under notice, but to the younger members of the profession who may this year take upon themselves the title of gardener with all the attendant responsibilities.

To prevent as much as possible deficiency and confusion the best plan is to start propagating at once, and continue the work at intervals throughout the year, say every three months, as where a supply of plants for house decoration is required it is necessary to always have a stock of young plants ready to take the place of old ones that have done their best, and to make good any losses that may occur through injury by gas and cold draughts. I would impress upon all who have not proper house room for a large collection to be satisfied with a small one, for overcrowding the plants will soon spoil their shape, and their beauty is gone for ever; moreover, a few plants grown well are far more creditable than a large quantity grown indifferently.

For a small collection the plants marked with an * will be found adequately adapted for all purposes pertaining to house decoration, and for those that have facilities all those mentioned will be worth growing. **Aspidistra variegata*. **Aralias* **Chabrieri*, elegantissima, **filicifolia*, gracillima, and **Veitchi*. *Crotons angustifolius*, *Chelsoni*, **elegans*, gloriosus, **Johannis*, *Veitchi*, **aigburthensis*. **Dracenas* *Goldi-ara*, *marginata*, *albicans*, *augusta*, **Cooperi*. **Pandanus Veitchi*. **Colcus Ada* Sentence, Allen Chandler, Mr. G. Simpson, **Pompadour*, **Duchess of Edinburgh*, *Shah*. *Acalypha macrophylla*, **Ficus elastica variegata*, **Panicum variegatum*, *Ananassa sativa variegata*, *Tradescantia zebrina*. **Caladiums* **argyrites*, **Verschaffelti*, E. G. Henderson, *Laingi*, **Madame Heine*, *Murillo*. **Ophiopogon variegatus*.

The *Aspidistra* is an invaluable plant for standing in halls or corridors, or for arranging in mixed groups. The easiest method of

propagation is to split up an old plant into as many pieces as required, place the divisions singly in 4-inch pots, and transfer them to a temperature 60° to 65°, where they will soon become established, when they may be used for decoration. They may be placed into larger pots according to requirements. A suitable mixture is two parts fibry loam, one part leaf soil and sand. When they are well established they will require abundance of water at the roots, especially in the summer, when they may also be syringed freely. They will thrive admirably in a temperature ranging from 55° to 60°.

Aralias, Crotons, and Dracenas are perhaps three of the most useful and beautiful of our ornamental foliage plants, their varied markings and pleasing colours always ensuring for them a high position in general favour. For the dining-room they are indispensable; being of a light graceful habit, they do not block the view across the table, a consideration which should not be overlooked by those who have to arrange plants in the house.

Cuttings may be taken from the tops of old plants that have grown too bad for use. They should be taken with a soft stem if possible, as they will root quickly and without losing any of their leaves; if cut with a hard stem they take much longer to root, and often lose their lower leaves. They may be inserted singly in 3-inch pots, using light sandy loam with a few decayed leaves. The pots may be plunged in a stove pit, with a bottom heat of 75° to 80°, and left till well rooted, when they may be removed to a shelf in the stove. Old plants that have been topped may be used as stock plants, and should be plunged in a brisk bottom heat, and the stems syringed daily, they will then throw out shoots, which as they become large enough may be taken off and inserted as cuttings. When the young plants have filled the small pots with roots they should be transferred into 5-inch pots, the most serviceable size for table work. A good compost is two parts fibry loam, one part leaf soil and dried cow manure, and enough charcoal and silver sand to ensure porosity.

The after culture consists chiefly in keeping the plants perfectly clean and free from insect pests, and transferring them into larger pots if desirable. A high temperature with plenty of atmospheric moisture, abundance of light, and water at the roots are essential to bring out their markings to perfection. A very dry atmosphere must be studiously avoided, as being conducive to red spider and thrips, which insects soon take all the vitality out of the leaves, causing them to assume a sickly appearance which mars their beauty considerably. Aralias and Crotons may be syringed vigorously all the year, especially directing the water on the under surface of the leaves, which will dislodge any of the pests named, and maintain a clean, fresh looking appearance. In winter the syringing should be done in the early part of the day to allow the foliage to become dry again before night.

Dracenas may be syringed freely in hot weather when air can be admitted, but should not be done in winter on account of the water lodging in the axils of the leaves, which causes them to "damp." We use these plants entirely for the dining and drawing room tables, and to ensure a perfectly symmetrical growth we give them a position on a narrow shelf suspended 3 feet from the roof in the stove. This gives them an equal amount of light on all sides, as they are placed about 1 foot apart, it also gives the advantage of being able to reach the under side of the leaves when syringing. No fixed rule can be laid down as to the height of the plants, but we usually have them from 9 to 18 inches, which we find quite tall enough for table work.

The bold variegation and long graceful foliage of Pandanus Veitchi renders it one of the best for decorative purposes; it will stand a long time in rooms lighted by gas, and is very easy to keep clean, being almost proof against insect pests. No collection is complete without it. Propagation is effected by rooting suckers which are generally plentiful at the base of old plants. These should be taken off close to the soil and inserted singly in small pots, or if good sized suckers can be obtained they may be placed in 5-inch pots, using a compost of two parts loam with a small quantity of decayed leaves and silver sand. They root readily in a stove pit, and if grown in a high moist temperature soon make useful plants. When the pots are full of roots plenty of water should be given, and they should be syringed freely during the summer months. Weak liquid manure will be found beneficial in maintaining a good colour.

Coleuses are extremely useful for indoor work, but as they will not stand very long in hot rooms without injury they will require changing frequently. A stock of young plants may be easily kept up to supply any losses that may occur, as cuttings strike freely at any time of year if placed in a brisk heat. They may be inserted either singly or several in a pot, taking care that the base of the cutting reaches the bottom of the hole made for it, for if they "hang" in the soil they will most likely damp off. When well rooted they may be potted singly or shifted into larger pots, as the

case may be. They thrive in a mixture of fibry loam, leaf soil, and charcoal and silver sand. As they grow freely they require abundance of water at the roots; an occasional dose of weak liquid cow manure will help them considerably. The leading shoots should be pinched about twice to cause them to form good bushes, which they will do in moderately small pots. Plenty of light and a stove temperature will be essential to obtain good plants in winter, but they will do well in a greenhouse during the summer months. The flower spikes should be removed as they appear.

Acalypha macrophylla with good culture is excellent for mixed groups, its handsome brown foliage when coloured being very effective. It is propagated by cuttings, which, if taken with a soft stem, root freely in a stove pit. A mixture of equal parts of loam and peat, with a sprinkling of sand, will suit them well. Several may be inserted in a 5-inch pot, and when well rooted they may be transferred singly into 4-inch pots, and as they increase in size may be moved into larger pots as desired. The after culture consists mainly of a plentiful supply of water (rain water if possible), syringing freely in hot weather, and sponging the leaves frequently with soapy water.

Ficus elastica variegata makes a splendid plant for all decorative purposes. Propagate by cuttings taken from the tops of plants that have grown too tall, insert singly in 5-inch pots, using a compost of fibry loam and charcoal, and place in a brisk heat. They are best restricted to one straight shoot, and may be kept in moderately small pots. Syringe freely in fine weather, and sponge occasionally to keep the leaves clean and bright. The plants will do well in an intermediate temperature, but the colours will be more distinct if grown in a stove.

Panicum variegatum and *Tradescantia zebrina* are graceful trailing plants, specially adapted for mixing in groups and for standing in small vases in the drawing room. They are easily increased by cuttings, which may be laid on the surface of the soil, and a few crocks placed on them to keep them down. They very soon cover the pot if grown in a stove temperature. A shady position suits them better than too much exposure and light. Plenty of water at the roots will be essential at all times.

Ananassa sativa variegata is extremely serviceable for table-decoration, and it will stand gas better than most stove plants. It is best increased by suckers, which may be obtained from the base of old plants. These may be inserted singly in 5-inch pots, and plunged in a bottom heat of 75°. When well rooted they may have a position on a stove shelf where they can obtain abundance of light. They thrive in a compost of light fibry loam and a proportion of charcoal and silver sand, and require watering carefully during the winter months, but copious supplies may be given with frequent syringings in summer.

Caladiums are ornamental plants for table work during the summer months, but owing to their delicate foliage must not be left in hot rooms more than one day, nor exposed to draughts. We propagate them by dividing large tubers into about four parts, inserting each part separately in small pots, and place them in a temperature of 65°. This should be done about March, and in a month or six weeks they should be potted on into larger pots and be brought into a somewhat higher temperature. A good mixture consists of equal parts of loam and peat and a small quantity of charcoal and silver sand. Perfect drainage must be ensured, as they require abundance of water when in an active condition; weak liquid manure may also be supplied frequently. They should be shaded for a few hours when the sun is very strong, but should have all the light possible to perfect the colour of the leaves. A moist atmosphere is essential from the time they commence growing until the foliage fades, then they may be removed to a lower temperature and the supply of water gradually reduced. After the foliage is quite withered they may be placed under the stage in a warm greenhouse, kept moderately dry, and rested until the time comes round for starting them into growth.

Ophiopogon variegatus is a very desirable little plant for arranging in groups, its green and yellow variegated foliage having a pretty effect. It is increased by dividing old plants and inserting each division in small pots, placing them in a brisk heat of 75°. After roots are formed give them a position on the stove shelf, and remove into larger pots as they develop, using a mixture of equal parts of loam, peat, and leaf soil, with a sprinkling of sand. An ordinary stove temperature will suit them, and well established plants can remain in the same pots for a number of years with little attention beyond an occasional sponging and frequent watering with liquid manure to ensure a good colour, and keep the foliage clean and bright.

A great detriment to plants used for house decoration is the injury inflicted on them by gas and cold draughts. Most of our beautiful variegated foliage plants require for their successful growth a high moist temperature, and to take them out of such a temperature and subject them to either of the above evils means in

some cases a severe check, or perhaps certain death. The plants then to keep them in perfect health should be changed frequently, and a sharp look out must be exercised to avert as much as possible these evils, which render our most beautiful plants comparatively worthless. The best gas-resisting plants we have are the *Aspidistra*, *Pandanus*, and *Ananassa sativa* var.—the first named especially, for we have kept it in the house for two weeks without doing it the slightest perceptible injury. But it is not advisable to leave these plants in too long, as they are all the better and last longer if changed often. An important point in the management of decorative plants is thorough cleanliness, and the constant use of the sponge and syringe will be essential for keeping them in perfect health. They should always be carefully examined before taking them into the house, and any insects or dirt at once sponged off. The pots should also be washed on the outside, and all stakes, ties, labels, &c., be carefully hidden by the foliage. If the pots are placed in vases the labels must be either taken out altogether or laid flat on the surface of the soil, which should be covered with damp moss or the trailing *Selaginella*; the latter, however, though more effective, robs the plant to a large extent of its due nourishment; and the former, where it can be obtained fresh from the woods, will be found to answer the twofold purpose of hiding the soil and rims of the pots, and in retaining moisture at the roots. Failing this the moss sold by nurserymen in bundles if wet will be quite as useful, and if this is considered too expensive fresh green Ivy leaves laid over the surface will conceal any unsightly objects. Perhaps I ought to have mentioned before that in potting all soils should be warmed to the temperature of the house the plants are in. All pots used must be perfectly clean and dry, and the water supplied should be the same temperature as that of the house.—F. ATKIN, *Aigburth*.



DENDROBIUM SIGNATUM.

A PLANT of this little *Dendrobium* was shown from the Burford Lodge Gardens at the R.H.S. meeting in March 11th last year, when a certificate was awarded for it by the Orchid Committee. The clear yellow flowers are comparatively small and suggestive of *D. luteolum*

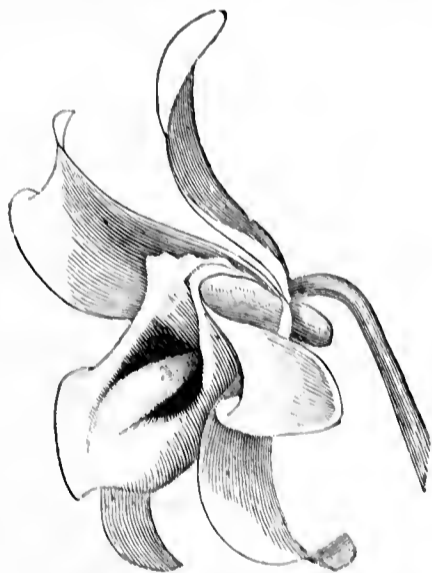

FIG. 9.—DENDROBIUM SIGNATUM.

in their shape; the sepals and petals recurve, are of nearly equal size, but the lip is much broader, with two dark bars converging towards the centre.

ONCIDIUM HETERANTHUM.

THIS is one of the many Orchids that cannot be said to possess much beauty, and yet which are of such singular formation that they are well worth including where Orchids are studied as well as grown. At Kew it has often attracted attention when in flower, and specimens may now be occasionally found in amateurs' collections, and amongst others at Mr. A. H. Smee's garden, The Grange, Carshaltou, from which place it has been shown at the Westminster Drill Hall meetings. To a casual observer, indeed even to those familiar with the appearance of Orchid flowers, this *Oncidium* is

rather puzzling, for at first glance the inflorescence seems to have lost nearly all its flowers, a few only remaining at the points of the panicle branches. Closer examination, however, reveals the fact that there are two distinct forms of flowers, one series (the most numerous) small, with greenish-yellow equal linear divisions, and quite un-Orchid-like, the others of the prevailing *Oncidium* character, yellow and brown, resembling many others of the small-flowered species.

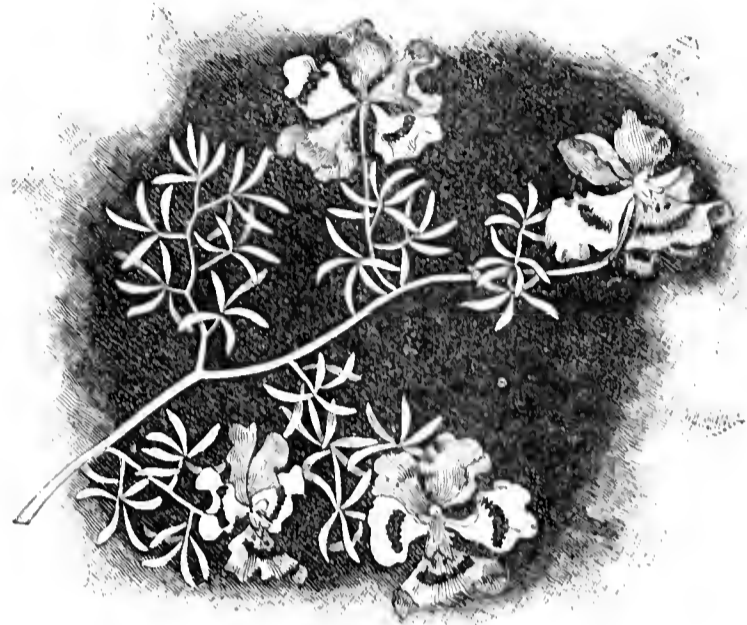

FIG. 10.—ONCIDIUM HETERANTHUM.

The woodcut (fig. 10) gives an idea of the respective size and forms of these diverse flowers, from which peculiar character the species has gained the title "heteranthum."

MASDEVALLIAS AND DISAS.

[A paper by Mr. E. BURBERRY, Orchid Grower to the Right Hon. J. Chamberlain, M.P. Highbury, Birmingham. Read at a Meeting of the Birmingham Gardeners' Association.]

(Continued from page 26.)

DISAS.

DISA grandiflora, "the Flower of the Gods," if once seen well grown and flowered is not easily forgotten, for it is one of the most handsome and useful cool Orchids we have. This, if the stems are strong, produces flowers very freely, which are most valuable, especially as it can be grown in a cold frame, the temperature not falling below 40°, and its large striking crimson flowers are most useful for bouquets. The *Disa* is a terrestrial Orchid, a large genus, its native habitat being the Table Mountains at the Cape of Good Hope. There are many varieties of exquisite colours and fantastic shapes, and my remarks upon the *Masdevallia* as an interesting family apply fully to this. But *D. grandiflora* is the best, and at the same time most common, therefore to this I will confine my remarks, all the others requiring the same treatment. It is best grown in a cold airy house, with sufficient fire heat only to keep the thermometer from falling below 40°. The house should stand in a cold and shady position. If this is not available a frame or pit will grow them nearly as well. Abundance of air must be given when the outside temperature will admit—that is, when it is above 40°. They should never be allowed to become dry, and if properly potted it is almost impossible from March to August to give too much water if the principle of watering is understood in the least. During this time they enjoy to be syringed three or four times a day. They usually flower in August, after which they should be kept a little drier and given all the air possible, if the nights are not too cold. Root action soon commences, and I prefer to repot them in September. This should be done every year, giving them all new material, and keeping it moderately damp till the plants have formed new roots and its new growth is strong, when water may be increased gradually.

The best potting material is peat, not very fibrous; this should be broken to pieces about the size of walnuts, and well mixed together with one-third of its quantity of coarse, sharp, silver, or river sand. They are sometimes grown a number together in one large pan, but the best way is to grow them singly in pots. The pots should not be too large; a 48 is large enough for one strong-flowering stem. If the stems are weak use pots corresponding in size. I find the best plan to grow small plants on is to plant them in thumb pots, and pot each on as they require it during the season, taking care not to break the ball or otherwise injure the roots.

In addition to the main growth there are numbers of suckers or

offshoots spring up ; these should all be removed, leaving the one growth only ; by doing this the stem has a chance of becoming strong, and will flower ultimately. These offshoots will propagate very freely, but if wanted for this purpose it is best to leave them a little longer, when they will have a root or two, and consequently will grow more freely.

The pots should be filled one-third with crocks, and the bulbs potted rather firmly about 1 inch beneath the surface of the soil, which should be up level with the rim of the pot. Potted in this way and placed in the position I have mentioned and with the proper treatment the Disa can hardly fail to grow, although it is said by some to be difficult to manage.

Of the insects which are troublesome red spider will soon take advantage if the atmosphere is dry, but green fly can easily be kept down by the usual means of sponging and fumigating. As regards feeding, I find liquid farmyard manure is decidedly beneficial to these plants if given not too strong about once a week during the growing season. This is as near as I can explain the treatment which I adopt, and which I think is the best for the Masdevallia and the Disa.

THE BRITISH FRUIT GROWERS' ASSOCIATION.

THE annual general meeting of the above Association was held in the Hotel Windsor, Victoria Street, S.W., on Thursday, January 8th, at 6 P.M. There was a good attendance of members, but several were unable to be present owing to the severe weather, and the President, Lord Brooke, telegraphed, expressing his regret that he could not attend, as he was unwell and not allowed to leave the house. In his absence one of the Vice-Presidents, Dr. Maxwell T. Masters, took the chair. The principal business was to receive the Committee's report and financial statement for the last year, to elect officers and Committee for 1891, and to consider the programme and work of the Association. After the minutes of the previous general meeting had been read and confirmed the report as follows was read by Mr. J. Cheal :—

REPORT 1888—1890.

In presenting their report for the year 1890, the Committee of the British Fruit Growers' Association consider it desirable to briefly review the history of this organisation, the progress that has been made, and the effects resulting from its action in the promotion of fruit culture, as important changes have occurred.

When it was publicly announced, early in May, 1888, that a Conference of fruit growers would be held at the Crystal Palace in September of that year, the project was most favourably received. Hundreds of approving and suggestive letters were forwarded to those entrusted with the arrangements, and it became at once apparent that the proposed meeting was exactly in accordance with the wishes of fruit growers generally. A large and representative Committee was formed, and a full programme was prepared and published. This was carried out in its entirety on September 7th and 8th, under the presidency of T. Francis Rivers, Esq. The meetings were exceptionally well attended on both days, and the proceedings were fully reported in most of the leading daily and weekly papers, articles also being devoted to the subject in some of the more important organs. A considerable amount of publicity was thus afforded to the matter, such as is very rarely accorded to special or technical subjects in the daily press.

Recognising the importance of the gathering and of the information adduced, a number of those present suggested that an organisation should be formed, to be devoted to a continuation of the work thus commenced. This was proposed at the conclusion of the business, and a resolution "That a Society of Fruit Growers be instituted," was duly seconded and carried unanimously. The Executive Committee of the Conference was entrusted with the preparation of a scheme for carrying this into effect, and at a meeting held in London a few days after a draft was prepared as the basis upon which the British Fruit Growers' Association was organised, and this was published, together with the names of officers and Committee. Another Conference was held in the Crystal Palace on October 11th, which was well attended, "Profitable Fruit Culture" being the subject under discussion.

Numerous promises of support for the Association were received, and at a subsequent meeting of the Committee it was resolved to hold a Conference on railway rates at Westminster. This took place on November 8th, 1888, and evoked many interesting and important facts, most of which were published at the time in the horticultural papers. It was proposed that the Association should collect as much information as possible bearing upon the subject, with a view to subsequent publication. The business of the year concluded with the re-election of officers and Committee, with a few alterations for the following year.

The progress up to this point had been rapid and satisfactory, but owing to the prolonged illness of one of the officers in 1889, no action was taken with regard to the work of the Association until October of that year, when a Conference was arranged to be held at the Crystal Palace on October 10th at 3 P.M., when excellent papers were read dealing with fruit culture generally, and with Peaches and Nectarines specially. Several meetings were also subsequently held with the object of extending the usefulness of the Association, and at the annual meeting of that year the rules were more fully elaborated with some altera-

tions in the constitution of the Association that were considered necessary, and an important programme was prepared.

Vigorous action was taken early in 1890 ; the report, programme, rules, and objects of the Association were widely circulated, with the result that the number of members rapidly increased, and the work of the Association was again brought into prominence. The first important meeting of the year was occasioned by an invitation from Brownlow R. C. Tower, Esq., agent for Earl Brownlow at Ellesmere, Salop, and Hon. Secretary to the local Horticultural Society, for the Association to send a lecturer to discourse on "Profitable Fruit Culture," at a public meeting in the town named. The meeting was held in the Town Hall, Ellesmere, on Saturday, March 22nd, and was attended by a large and appreciative audience. An exhaustive practical lecture was delivered by Mr. John Wright, which was followed by excellent speeches by Mr. E. J. Baillie of Chester and Mr. G. Bunyard. Mr. Tower subsequently wrote expressing the greatest satisfaction with the proceedings generally, and thanking the Committee for their assistance.

On Friday, June 27th, a Strawberry Conference and Exhibition were held at Westminster, when papers were contributed by Messrs. T. F. Rivers, Shirley Hibberd, J. Wright, G. Bunyard, and T. Laxton. The exhibits comprised 160 dishes of Strawberries from nineteen exhibitors, representing nine counties—namely, Kent, Surrey, Bedford, Cambridge, Herts, Hants, Sussex, Middlesex, and Herefordshire. Forty varieties of Strawberries were included, and many very handsome fruits were shown, especially those from Mr. T. Sharp of the Royal Strawberry Gardens, Knowle Hill, Virginia Water. So much valuable information on the history and culture of Strawberries, both under glass and out of doors, was included in the papers read, that it was subsequently resolved to re-publish them as a complete report, which was issued free to all members, and is now sold to the general public at 6s. per copy.

A conference was also held at Leicester on August 5th, in conjunction with the local horticultural Exhibition, in the Abbey Park. James Ellis, Esq., M.P., occupied the chair, and papers were read by Messrs. Rivers, Ingram (Belvoir Castle Gardens), A. H. Pearson, and G. Bunyard. The Chairman was supported by the Mayor, Dr. Lankester, and several gentlemen in the district, and there was a good attendance. The members of the Association who were present to read papers or take part in the discussion were entertained by the Mayor and Corporation, and much local interest was excited in the subject of fruit culture.

Somewhat earlier in the season Messrs. Gordon and Castle, having announced their intention to spend a holiday in Ireland during the autumn, with a view to investigating the condition and prospects of fruit culture in Ireland, were unanimously appointed delegates of the Association, and desired to prepare a report upon the subject, to be submitted at one of the London meetings. Leaving Leicester on the evening of August 5th the delegates proceeded to Belfast *via* Stranraer and Larne ; investigations here commenced in the counties of Londonderry and Antrim, and continued thence south to Cork and Kerry, taking all the principal districts in the way. They also proceeded to Limerick and returned to Dublin, where they were received by the Council of the Royal Horticultural Society of Ireland, who promised every assistance in obtaining further information, and forwarding the special objects of the Association. The delegates experienced much courteous attention during the journey, and most cordial readiness to help in every way.

At the Crystal Palace Conference, on September 5th, an outline report of the Irish tour was presented, a full description of the journey and its results being reserved for separate publication. Papers were also contributed by Mr. Rivers, Mr. J. Smith of Mentmore (read by Mr. Joseph Cheal), and by Mr. Bunyard. On this occasion the chair was taken by G. T. Rait, Esq., one of the Directors of the Crystal Palace. There was an excellent attendance, and a brisk discussion followed, in which many cultivators took part. In conjunction with this meeting an exhibit of Irish Apples and Pears was provided, representing the varieties chiefly grown, and showing the poor quality of old orchard fruit as compared with that from gardens.

The next meeting was at Brighton, on September 11th, and in journeying thither the members took advantage of the opportunity to visit Messrs. J. Cheal & Sons at Crawley, where several extremely pleasant hours were spent, and after partaking of Messrs. Cheal's generous hospitality the visitors proceeded to Brighton. There arrangements were made for holding the Conference in the King's Room of the Royal Pavilion. The Mayor, G. Manwaring, Esq., took the chair at 4 P.M., and the meeting was addressed by Mr. Rivers and Mr. Gordon, papers also being contributed by Mr. J. Roberts, Mr. W. Iggulden, Mr. J. Cheal, Mr. A. Cheal, and Mr. R. Smith. The attendance was good, and the meeting was fully and favourably reported in the local papers. Some members remained in Brighton until the following day, when they visited the market gardens and fruit-growing establishments at Worthing. They were courteously received by all the growers, and had a most interesting and extended tour of inspection, chiefly under the guidance of Mr. A. Cheal and Mr. W. G. Head, who are familiar with the district.

The Fruiterers' Company having resolved to hold an Exhibition of hardy fruit in the Guildhall, invited the assistance of several members of the British Fruit Growers' Association. An elaborate schedule was prepared, a large amount being offered in prizes, and though the season was a bad one for fruit generally, an excellent show was provided on October 6th, 7th, and 8th. To this members of the Association contributed a non-competitive exhibit of 300 dishes of Apples and Pears, comprising at least 1800 fruits. These came from thirty exhibitors in-

fifteen counties, as follows:—Northern: Northumberland, Cheshire, Salop, and Lincoln. South-Western: Wilts, Gloucester, Hereford, Worcester. South-Eastern: Surrey, Sussex, Kent, Middlesex, Bucks, Essex, and Herts. A special framed certificate was awarded for the exhibit, together with several certificates of merit, and some of the fruit was selected for presentation to Her Majesty the Queen.

Fruit was also exhibited by the Association at the Crystal Palace on October 9th, 10th, and 11th, and at Westminster on October 15th, 16th, and 17th. On October 15th at the place just named Mr. G. Hammond read a brief but admirable paper on Apple culture, which was followed by an animated and interesting discussion. Mr. G. Gordon presided, and the meeting was one of the most satisfactory held during the season.

Meetings have also been held at Falmouth, Croydon, Ealing, and elsewhere, when papers have been read by members of the Association; but several invitations were received to provide lectures that could not possibly be accepted in the past year.

Since the work of the Association was commenced thirty-six papers have been read at its meetings by twenty-two of the leading fruit cultivators and authorities in the kingdom, dealing with the following subjects:—Apples, Pears, Plums, Cherries, Strawberries, Gooseberries, Peaches and Nectarines, Grapes, soil and general culture, pruning, packing, fruit distribution, fruit as food, and fruit preserving.

The meetings have been reported in over 200 daily and weekly papers, with an aggregate circulation exceeding 2,000,000, and in addition most of the papers read have been published in the gardening periodicals. The information obtained has thus been most widely diffused, and some idea is afforded of the interest excited by the fact that over 2000 letters of inquiry were received during the past year, ranging from Dundee to Falmouth.

The greatest care has been exercised in the appointment of lecturers and in the revision of the papers to avoid extravagant or misleading statements, and to supply what intending cultivators need—practical reliable information respecting the best methods of rendering land under fruit culture a profitable employment for labour and capital. That some effect has been produced is shown by the agricultural returns. In 1888 there was a decrease of land under orchards of 3056 acres; in 1889 an increase of 719 acres is recorded; in 1890 the increase was 2408 acres. The increase of acreage under small fruit in 1889 was 5209 acres; in 1890 it was 4301 acres, showing a total increase under fruit for 1889 and 1890 of 12,637 acres.

Such a rapid increase as this renders the dissemination of reliable information and the guidance of an association of practical men, the more necessary to counteract the effects of incompetent advice and excessive estimates of the profits derivable from this important industry. For good British grown fruit there is an unlimited demand, and a high authority in Covent Garden Market states that they can never procure sufficient first class fruits; for inferior samples there is no demand, except at very low prices. The points cultivators have to bear in mind, therefore, are to select the best varieties adapted to their districts; plant and treat the trees well, gather, sort, and pack the fruit carefully, send it to the best markets, and they may safely count on fair returns.

Numerous encouraging letters have been received during the year respecting the work undertaken by the Association, and from them the following, by the Earl of Fortescue, has been selected as fairly representative of the opinions expressed by scores of friends. "I heartily wish you success in your work. I have long been of opinion that fruit culture may be largely extended in Great Britain and Ireland with advantage to owners and occupiers of land, and to the general public. Your Association has been rendering a real public service, both by directing attention to fruit culture for profit in this country, and by helping to dispel the erroneous ideas too freely circulated respecting the enormous returns obtainable from a small capital employed in fruit cultivation. Your report truly observes that much harm has been done by ill-informed advisers, for fruit growing cannot be made to pay a fair profit without practical knowledge of the work, starting with a carefully considered scheme, and sound judgment in carrying it out."

The Committee have also had other satisfactory assurances of confidence in the course adopted, as handsome donations to the funds of the Association have been received from His Grace the Duke of Bedford and from Sir Edwin Saunders, while no less than 150 new members have been elected since January, 1890. It is, however, the painful duty of the Committee to record the loss by death of three well-known and widely respected horticulturists—namely, Mr. W. Wildsmith, Mr. W. Holmes, and Mr. Shirley Hibberd, all of whom were members of the Association, and had taken much interest in its work.

Reverting to the financial results of this year, the Committee report that the total receipts were £68 15s., the total expenditure £66 19s. 2d., leaving a cash balance of £1 15s. 10d., and 800 copies of the Strawberry Report in stock estimated at £15. After a season of active work it is therefore doubly satisfactory to be able to start another year in such a good condition, and the Committee accord their best thanks to all who have assisted in the work as officers, lecturers, and exhibitors.

The programme for the present year comprises conferences on fruit culture at Cardiff in August in conjunction with the Horticultural Society's Exhibition; at Edinburgh in September in conjunction with the Royal Caledonian Society's International Exhibition; at the Crystal Palace, Sydenham, in the same month; and arrangements are also being made for holding a conference at one of the meetings of the Royal Horticultural Society of Ireland in Dublin during the year. Committee meetings will be held as usual in the Horticultural Club room, Hotel Windsor, Victoria Street, at 5 P.M. on Thursdays, January 8th, February 5th

March 5th, April 2nd, May 7th, June 4th, July 2nd, August 6th, September 3rd, October 1st, November 24th, and December 17th.

The preparation of "A Report upon the Present Condition and Prospects of Fruit Culture in Great Britain and Ireland" has also been commenced, but as the work will be a large one it has been decided to divide it into sections, the first of which is now in hand. A list of thirty qualified lecturers has been prepared, and the Committee undertake to make arrangements with local horticultural societies or other bodies requiring practical lecturers or demonstrations of fruit culture in any part of the kingdom. In response to the wishes of correspondents meetings will be held in as many country districts as possible during the year.

The hearty co-operation of all interested in fruit culture is earnestly invited, and if this be freely accorded the Committee will have the pleasure of recording at the end of 1891 an even greater advance than has taken place in the past year.

After some comments upon the highly favourable character of the year's proceedings, Dr. Masters said that it was remarkable so much had been accomplished for such a small expenditure, and had much pleasure in moving the adoption of the report and financial statement. This was seconded by Mr. Cheal and carried unanimously.

The election of officers was next proceeded with, the result being that Lord Brooke, M.P., was unanimously re-elected President, with the following gentlemen as Vice-Presidents:—The Duke of Bedford, Sir Charles Barrington, Bart., Sir Edwin Saunders, the Hon. A. L. Pelham, Robert Hogg, Esq., LL.D., Maxwell T. Masters, Esq., M.D., Dr. J. Stanislaus Makovski, W. B. Waterlow, Esq., G. T. Rait, Esq., J. F. Lambard, Esq., J.P., W. H. B. Hall, Esq., C. de Laune Faunce de Laune, Esq., Charles Whitehead, Esq., Philip Crowley, Esq., F.R.H.S., E. J. Baillie, Esq., F.L.S. The other officers remained the same as last year, and only a few names were added to the Committee.

Cordial votes of thanks were accorded to the officers, Committee, lecturers, exhibitors, and to the Hon. Secretary, Mr. Lewis Castle, for his work during the year, a similar recognition being unanimously accorded to Dr. Masters for presiding, and this concluded the business of the evening. At a Committee meeting held before the annual meeting fifty-nine members were elected, the largest number elected at one meeting, and affording substantial indication of the increasing popularity of the Association.

EARLY TURNIPS.

IN No. 2201 of your Journal Mr. Easty cites a very early Turnip, of which he received seed from Messrs. Vilmorin, Andrieux & Co., Paris, and of which he does not remember the name. It may interest some of your readers to know that the new variety alluded to is sold under the name of Half-long White Forcing Turnip (Navet à forcer demi-long blanc). It is in shape intermediate between the white Carrot-shaped and the Half-long Early White Vertus or Jersey, also known in England under the name of Earliest French Forcing Frame, but is much earlier, smoother, has fewer leaves, and is a great improvement on those varieties. It is an excellent forcing Turnip, and succeeds best when sown in the spring under glass (frame). The leaves are very small, divided, and the roots grow remarkably fast. It is also slower in running to seed than other early Turnips if grown without any check, producing handsome roots at the beginning of the summer when Turnips are scarce, and fetch a good price.

While writing of that Turnip I may as well say a few words on some other valuable forcing varieties, which are usually sown in the month of February in a cold frame by the French market gardeners. Any market gardener forcing Turnips, if the term "forcing" may strictly be applied to that plant, most probably knows the extra early purple-top strap-leaved Milan Turnip, which is one of the earliest varieties, well adapted for forcing, and which has almost superseded the old Munich, being more regular in shape and of better quality than the latter. The old round early white Vertus or Croissy Turnip continues in much favour with the Parisian market gardeners for forcing, and it is indeed one of the best suited for that purpose.

The Half-long Early White Vertus or Jersey Turnip, which must have been noticed by whoever has gone through our central market (Halles Centrales) at almost any time of the year, is still one of the sorts most grown around Paris for forcing and in the open ground, and well it deserves the preference often given it, the root being formed in the open ground in two months or thereabouts, and quality being good when the roots are not overgrown. Its root is of about the same shape as the China Radish, but the colour is pure white instead of scarlet, as in the latter. I remember an intelligent American grower, with whom I one day went through the "Halles Centrales," asking, on seeing a carload of that Turnip from a little distance, what was the name of that handsome, smooth Radish.

There is another sort, the Half-long Red-top Vertus, differing from the ordinary White only by the colour of the top, which is purplish-red about one-third above ground, and, on account of its agreeable colour, is sometimes preferred to the White Vertus.

If agreeable to some of your readers, I will give you on a future occasion the names of the Lettuces most grown for forcing by the Parisian market gardeners, as also some hints regarding that culture.—E. SCHÆTTEL.

[Many of our readers would no doubt be glad to have details of the Parisian market gardeners' methods of growing early Lettuces.]



EVENTS OF THE WEEK.—To-day (Thursday) the annual meeting of the Gardeners' Royal Benevolent Institution will be held at 3 P.M., at "Simpson's," Strand, and the annual dinner at 6 P.M., N. N. Sherwood, Esq., in the chair, when presentations will be made to H. J. Veitch, Esq., and Mr. E. R. Cutler. The Royal Society also meet at 4.30 P.M., and the Linnæan Society at 8 P.M. On Friday, January 16th, the Quekett Club meets at 8 P.M., and the 21st inst. the Royal Meteorological Society have a meeting at 7 P.M.

— THE WEATHER IN THE METROPOLITAN DISTRICT has continued very severe during the past week, and the slight thaw noted in our columns in the last issue of the Journal was of very short duration. Upon several days 20° of frost has been registered, and on Saturday and Sunday 22° was reached, accompanied by dense fogs. On Monday 9° only was registered, and it has been strange what rapid fluctuations in temperature, ranging over 12°, have occurred within a few hours late in the evenings. A thaw commenced in the course of Monday, the temperature rising to 40°, with a west wind. This was continued on Tuesday, the snow and ice disappearing rapidly. All outdoor work has been completely at a standstill, and it is feared that much damage has been effected amongst the Tea Roses in some nurseries and gardens.

— THE WEATHER IN THE NORTH.—January 5th to 12th.—During the week we had in S. Perthshire fine seasonable weather from the 5th; about an inch of snow covered the ground, and the frost increased nightly from 7° to 18° on the night of the 9th. On Saturday the wind veered into the W., and during the night winter's forces sustained, for the present, utter rout. Never was thaw more complete. By the morning of Sunday, 11th, snow had disappeared from both high and low grounds, and to-day (12th) the thermometer stands at 47°.—B. D.

— B. S. WILLIAMS' MEMORIAL FUND.—The Committee having decided on closing this Fund on Saturday, 17th inst., they beg that any still intending subscribers will kindly remit the amounts at once to either of the Hon. Secs, Mr. J. A. Laing, The Nurseries, Forest Hill, S.E.; and Mr. A. Outram, 7, Moore Park Road, Fulham, S.W.; or to the Hon. Treasurer, Mr. H. J. Veitch, 544, King's Road, Chelsea, S.W.

— THE HIBBERD MEMORIAL.—As will be seen by our advertisement in another column promises of support to the amount of about £100 have been received by the Committee, in sums varying from 2s. 6d. to £25, for providing a portrait of the popular horticulturist who was so suddenly called away, the residue to be invested for his orphan daughter. All who would like to share in the Memorial are invited to send contributions, large or small, to the Secretaries of the Fund, 117, Victoria Street, Westminster. As we have previously stated we should like to see a large number of subscribers to both these Memorials.

— HARDY FRUIT EXHIBITIONS.—As secretaries are now arranging their programmes for 1891, will you allow me to suggest that, in collections of Apples and Pears, only five fruits should be shown in a dish? This is rendered necessary by the great increase in the size of the fruits, and they also look better when set up in this form. Special note should also be made to exclude orchard house grown fruit from exhibits of hardy kinds; a separate class for them is most desirable, as these monsters are apt to mislead the public.—GEO. BUNYARD, *Maidstone*.

— CUTTING DOWN CAMELLIAS.—This is an operation which may be performed with the most beneficial results on Camellias which have become too large, or which have lost a greater portion of their lower branches, or those which are crowded with a great amount of thin useless wood. The present is a good time to examine the plants to see if there are any with the above indications with a view to their being made more useful. By those possessing a number of plants many such will be found, and the best possible way so as not to sacrifice all the flowers for a season is to cut back a few each year as soon as the blooming is over, commencing with the worst plants first. Provided the roots are in a fair state of health there is no need to be afraid of cutting well back into the old wood, for by this means only can a good basis be formed for the future training of the plants. After being cut down

place the plants in a warm house, keep them well syringed; in a short space of time new growths will be seen pushing in all directions, and in a couple of seasons the plants will be completely renovated. Not only will the growth be more vigorous, but flowers of the first quality may be expected. For Camellias, in pots especially, this system is to be recommended, and anyone trying it will be astonished with the excellent results which may be attained.—R. P. R.

— BOLTON AND DISTRICT CHRYSANTHEMUM SOCIETY.—Kindly announce that the Show of this Society will be held on November 13th and 14th next.—JAS. HICKS, *Sec.*

— ON page 167 of the "HORTICULTURAL DIRECTORY FOR 1891," issued at your office, Mr. Burberry's name appears as gardener at Highbury. I should be glad if you will rectify this in the horticultural press, as I have been head gardener to the Right Hon. J. Chamberlain for sixteen years, and still hold that position. Mr. Burberry is the Orchid grower.—E. COOPER, *Highbury Gardens, Birmingham*.

— WOLVERHAMPTON HORTICULTURAL SOCIETY.—At a meeting of the Committee of the above it was announced that the profits of the last Show amounted to £558 15s. 7d., of which it was determined to invest £500 as a reserve fund and the balance to improvements in the park. The Committee have now £900 invested as the results of their first two Shows. The next Fête will be held on the 14th, 15th, and 16th July, 1891.

— THE "Botanical Magazine" for January is devoted to plates of AMORPHOPHALLUS TITANUM and DIPLADENIA ILLUSTRIS VAR. GLABRA. Three illustrations are given of the remarkable Aroid, of which a woodcut was given in this Journal, page 7, July 4th, 1889. The plates in the "Botanical Magazine" show the plant, spathe, and spadix in different stages of development, and a long description, together with particulars respecting the culture and dimensions of the plant, is also given, the principal points in which have already appeared in these pages. The Dipladenia is a handsome variety with large rosy blooms having a deeper crimson central zone, and a light throat. The leaves are broad and distinctly ribbed.

— "PEACH CULTURE UNDER GLASS AND ON THE OPEN WALL."—This was the title of an excellent paper read by Mr. W. Tunnington, Calderstones, before a good number of members of the Liverpool Horticultural Association at the Free Library, William Brown Street, Liverpool, last Saturday evening. Mr. White presided. The paper was thoroughly to the point, and greatly appreciated. An interesting discussion was entered into by Messrs. White, Simpson, Ranger, Smetham, Stoney, Cox, Glover, Tunnington, and Carling. The subjects forming the discussion were pot Peaches, varieties, insects, loss of buds, stocks for Peaches, pale v. high-coloured Peaches, &c. A vote of thanks to Mr. Tunnington brought the meeting to a close.

— DEUTZIA GRACILIS.—Though rather late, may I be allowed to add a few remarks to those of your correspondents, "W. B." and "E. M.," in favour of the above named shrub for outdoor planting? Some seven years ago I turned out of a 12-inch pot a large plant of this Deutzia, and planted it in the front part of a plantation having a north aspect. The soil is heavy clay, and in planting there was not a particle of any other compost mixed with it. Here the plant is quite at home, having grown into a handsome spreading bush, and it is doubly welcome, flowering as it does each year when the forced plants are all over. What the plants would do under more favourable conditions can be imagined, and I intend planting out another dozen plants in a good bed of prepared soil.—R. P. R.

— ROYAL METEOROLOGICAL SOCIETY.—The annual general meeting of the Society will be held at 25, Great George Street, Westminster, on Wednesday, the 21st inst, at 8.15 P.M., when the report of the Council will be read, and the election of officers and Council for the ensuing year will take place. The above meeting will be preceded by an ordinary meeting, commencing at 7 P.M., at which the following papers will be read:—"Note on a Peculiar Development of Cirrus Cloud Observed in Southern Switzerland," by Robert H. Scott, M.A., F.R.S.; "Some Remarks on Dew," by Col. W. F. Badgley, F.R.Met.Soc. The Council have also arranged to hold, on March 17th and 20th next, an exhibition of rain gauges, evaporation gauges, percolation gauges, and kindred instruments. The Committee will also be glad to show any new meteorological instruments or apparatus invented or first constructed since last March, as well as photographs and drawings possessing meteorological interest.

— LEE, BLACKHEATH, AND LEWISHAM HORTICULTURAL SOCIETY.—The annual Exhibition of the above Society (to which will be added this year a Rose section, with prizes of about £20) will be held at The Cedars, Lee, on Wednesday and Thursday, July 1st and 2nd.

— UNITED HORTICULTURAL BENEFIT AND PROVIDENT SOCIETY.—The quarterly meeting of this Society was held at the Caledonian Hotel on Monday evening last. Mr. Nathan Cole presided. Nine new members were elected, making a total for the year of seventy. Mr. W. Gunner of Croydon and Mr. George Dixon were elected as auditors of the past year's accounts. Mr. James H. Veitch has kindly consented to preside at the annual meeting at the Caledonian Hotel on Monday, April 9th, at 8 P.M. The usual business having been transacted, a hearty vote of thanks to the Chairman ended the meeting.

— SEED ORDERS.—The Editor will do an immense service to the larger body of seedsmen's assistants in London and the provinces if he will be kind enough to urge upon his readers the desirability of not waiting for severe weather to disappear before sending their annual seed orders to their seedsmen. In the most favourable seasons the occupation is of an arduous description, and the seedsman's staff is engaged for long hours to keep the work under; but in a year like the present, if purchasers delay sending their orders until the frost goes, it means a still further pressure upon the workers.—RETAIL SEEDSMAN.

— THE TOTAL RAINFALL AT CUCKFIELD, Sussex, for December was 0.56 inch, being 2.18 below the average. The heaviest fall was 0.17 inch on the 20th. Rain or snow fell on six days. Total for the year 26.80 inches, which is 3.85 inches below the average. The highest temperature was 41° on the 4th, lowest 15° on the 31st. Mean maximum in the shade 33°, mean minimum 24°, partial shade readings 10° below average. A very wintry month for the "sunny South." There were fourteen days on which the temperature did not rise above 32°, and with the exception of three nights, 4th, 5th, and 6th, the temperature registered below that point on all the other dates. On nine occasions it fell to 20° or below it. Thermometer 2 feet 6 inches from the ground, and shaded in double walled cases. Snow fell on 18th, 19th, and 20th, and on various dates since, and is still on the ground, January 2nd.—R. I.

— PRUNING.—By visiting a number of gardens at any season different styles and methods of culture are seen, and something can be learned even in the smallest places. While visiting a garden the other day I was struck with the way in which the Apple trees, Gooseberry and Red and White Currant bushes were pruned. The Apple trees were trained in pyramidal form, and were thick and bushy in appearance, and all the pruning they received was to cut out the branches which crossed each other badly, even the strong sappy growths from the main stem of the tree were allowed to remain uncut. I can say nothing about the crops or the quality of the fruit produced by these trees, but they had a luxuriant growth of lichens on their stems and branches. Gooseberry and Red and White Currant bushes were pruned very little, and instead of spurring the shoots starting from the principal branches, as is usually the case, they were ruthlessly torn off with a large heel to each. I can understand pulling off a strong shoot or two from the bottom of the main stems where they are not required, and to prevent their throwing out shoots again, but the system of tearing off all the shoots of Gooseberry and Currant bushes, instead of spurring them with the knife, is certainly new to me; and I do not think the system is beneficial to the production of good crops when practised in this wholesale manner.—K.

— INDIAN CORN is suggested by His Excellency the Governor as a product that ought to be freely cultivated in Ceylon, in his remarks to the people of Matale. This is a very natural thought to an administrator who has seen how largely Indian Corn forms the food of the people in the West Indies as it does in Brazil and other American States. And even in Ceylon, Sir Arthur Havelock will learn that Maize or Indian Corn is grown to a limited extent; and as we have repeated time after time in our "Agricultural Review" a great deal more should be done with it here in suitable localities. It requires, however, a moist good soil, although it has the widest range of all cereals. Bertolaeci so far back as 1816 reported that Turkish Corn or Maize had been proved to succeed well in Ceylon; it was then grown freely in the Matara and Batticaloa districts and exported to other parts of the island. He hoped to see culture extend to the supersession of dry grain. There can be no doubt that much might be done in

Ceylon to increase the production of Maize, more particularly if better means of communication were established northwards and eastwards.

— "WE have received," says the *American Garden and Forest*, "from Mr. P. J. Berckmans, of Augusta, Georgia, a flowering branch of *LEUCOPHYLLUM TEXANUM*, a shrub which has rarely if ever been seen here in cultivation. Mr. Berckmans writes that he tried for years to propagate this species with living plants, cuttings, and seeds; but he never succeeded until some five years ago, when two plants were started. These are now 4 feet high, and with their ashy white foliage and abundant purple flowers they are very conspicuous. They endure the warmest and driest weather well, since their large roots penetrate the soil to a great depth. The foliage, which is evergreen in its native habitat, stands without injury a temperature which does not fall below 15° Fahrenheit, and these plants have lived through a freeze of 5° above zero. In writing of the forest vegetation of the Lower Rio Grande Valley, Mr. C. G. Pringle speaks of this plant (see vol. ii., p. 394) as the most striking shrub of the region, and calls it 'surpassingly lovely, with a profusion of purplish bloom surmounting the velvety white foliage.' No doubt it will prove a great addition to our list of shrubs for southern latitudes, and it may survive winters much farther north if slight protection is given to it."

— GERMINATION OF SEED.—It is a common mistake to suppose that in order to produce a mature plant we must allow the seed to germinate, and the resultant plantlet to fix itself in a soil and draw nutriment by means of roots from Mother Earth. Any plant will grow as well in water if it contains the proper food stuffs in the proper quantities, as it will in soil of the very richest and most fertile kind. All that has to be done is to germinate the seed on a piece of moist flannel, and then transfer it to a jar containing to every litre (about 1¼ pint) of water the following quantities of the following substances:—1 gramme of nitre; half gramme of each of the following—sulphate of lime (plaster of Paris), sulphate of magnesia (Epsom salts), and phosphate of lime. An iron nail must also be kept in the water to give to the plant the almost infinitesimal amount of iron which it requires. This mixture of water and salts must be renewed about once a fortnight. Of course the root portion only of the plantlet is to be immersed in the water; the stem part which bears the green leaves must be allowed to stand out freely in the air. In Germany it has been the custom for many years to set aside some portion of the botanic garden for the growth of plants of all kinds, from the smallest herbs to the loftiest trees, in food solutions of the kind described above—*i.e.*, by what is commonly known to botanists as the system of water culture.—(*Indian Agriculturist.*)

— SUMMARY OF METEOROLOGICAL OBSERVATIONS AT HODSOCK PRIORY, WORKSOP, NOTTS, FOR DECEMBER, 1890; 56 feet above mean sea level.—Mean temperature of the month, 30.4°. Maximum on the 4th, 44.2°; minimum on the 22nd, 10°. Maximum in the sun on the 6th, 75.5; minimum on the grass on the 22nd and 30th, 6.1°. Mean temperature of the air at 9 A.M., 30.2°; mean temperature of soil 1 foot deep, 36.6°. Nights below 32°, in shade twenty-six, on grass twenty-eight. Total duration of sunshine, eleven hours, or 5 per cent. of possible duration. We had twenty-four sunless days. Total rainfall, 0.60 inch; rain fell on thirteen days. Average velocity of wind, 5 miles per hour; did not exceed 400 miles on any day, and fell short of 100 miles on thirteen days. Approximate averages for December.—Mean temperature, 37.2°. Sunshine, thirty-two hours. Rainfall, 2.03 inches. A very cold, dry, dull, and calm month. The mean temperature is lower than in any December during the last fifteen years, though nights were colder in both 1878 and 1879.

— THE SUMMARY OF THE YEAR 1890 at the same place is as follows:—Mean temperature, 47.7°. Maximum on the 5th of August, 77.7°; minimum on the 22nd of December, 10°. Maximum in the sun on the 26th of July, 134.4°; minimum on the grass on the 22nd and 30th of December, 6.1°. Mean temperature of the air at 9 A.M., 48.3°. Mean temperature of the soil 1 foot deep, 48.5°. Nights below 32°, in shade sixty-one, on grass 152. Total duration of sunshine, 1236 hours, or 28 per cent. of possible duration. Maximum duration in one day on the 24th of May, 14.6 hours. We had seventy-eight sunless days. Total rainfall, 21.19 inches. Maximum rainfall in twenty-four hours, on 12th of May, 0.78 inch. Rain fell on 174 days. Wind.—Number of observations from the following points, 9 A.M. and 9 P.M.;—N., 44; N.E., 47; E., 21; S.E., 40; S., 41; S.W., 159; W., 117; N.W., 62; calms, 199. Average velocity, 9.4 miles per hour. Velocity exceeded 400 miles on forty-two days, fell short of 100 miles on sixty-five days.

Approximate averages for the year.—Mean temperature, 48.2°. Sunshine, 1227 hours. Rainfall, 25.1 inches. A dry and rather cool year, with about average sunshine. The principal features have been a slight deficiency of rain throughout nearly the whole year; a mild and open winter and early spring; a cool and dry April; a fine and mild May; a very dull and rather showery summer, with a total absence of any warm summer weather; a very fine, dry, and warm September and October; a rather wet November, with a very sharp frost, and an exceptionally heavy fall of snow; and a very cold and dull December. The cold in the latter month was more remarkable for the low day temperature than for particularly cold nights; in fact, the mean minimum was lower in December, 1878 and 1879, as well as in January, 1879 and 1881, but we have had no month during the last fifteen years with so low a mean daily maximum. The absolute minimum 10° has also often been beaten, so that no damage seems to have been done to shrubs and plants.—JOSEPH MALLENDER.

— THE CATERPILLAR PLAGUE IN CHESHIRE.—If census taking in the case of humanity has its difficulties, attempts to estimate the numbers of insects appear to be even more liable to error. Thus we have an observer in Cheshire, who "from personal investigation and exhaustive inquiry," declares his conviction that caterpillars in that county were not more abundant than usual in 1890, while an entomologist of high standing inclines to the opposite view, and adduces what seems satisfactory proof. In the current month's "Entomologist" Mr. Newstead, of the Grosvenor Museum, Chester, records that he found *Nematus Ribesi*, the sawfly of the Gooseberry, abundant in one district, rendering the crop of fruit small, and also damaging the buds of next season. It occurred in various places beside, but as he remarks, it may be kept under by watchfulness against their first appearance. This gentleman has noticed that the cuckoo is a bird partial to this nauseous caterpillar. The winter moth caterpillar he never remembered having seen so abundant, infesting a variety of fruit trees, but doing most harm to the Apple. But one explanation of this is, that measures are seldom taken for the destruction of the females during the winter by people in that county. The caterpillar of the small ermine (*Hypomomeuta padella*) was out more plentifully than usual, though it is generally complained of as a very troublesome insect. About Chester many bucketsful of them were collected and burnt. Aphides were excessively numerous, specially Rose and Currant.—ENTOMOLOGIST.

— THE GRAND YORKSHIRE GALA.—The annual meeting of the members of the Council, together with the guarantors of the Grand Yorkshire Gala, was held at Harker's Hotel recently, Sir Joseph Terry presiding. There was a good attendance. Letters were read from several members regretting their inability to be present. The Gala had now, said Sir Joseph, existed for a great number of years, and on the last occasion it was an unprecedented success. It was very gratifying that the original objects of the Gala were fulfilled, and that in consequence of their annual successes the Committee were in a position to contribute handsome sums to local charities. Doubtless much of their popularity was due to the fact that these donations were always forthcoming, and he hoped that in the coming year the public would support them with equal liberality. All present would agree with him that in a great measure their success was due to the untiring labours of the Secretary (Mr. C. W. Simmonds) and the Committee who had so ably supported him. The Chairman moved that the Lord Mayor (Alderman Matthews) be elected President of the Gala. When in the office of Sheriff his lordship undertook and satisfactorily discharged the duties of a similar position, and he (the Chairman) had no doubt that in the coming year they would be more than satisfied with his conduct as President. Mr. Kirby seconded, and the Lord Mayor, in replying, expressed a wish that this year's Gala would be as prosperous as any of its predecessors, and as one he would do his best to make it so. On the motion of Mr. G. Browne, seconded by Mr. Anderson, Sir Joseph Terry was elected Chairman of the Committee. Both the proposer and seconder passed high eulogiums on the work and character of the Chairman. The following were also re-elected:—Treasurer, Mr. Joseph Wilkinson; Secretary, Mr. C. W. Simmonds; and Auditor, Mr. Pearson. The following gentlemen, with the Lord Mayor and City Sheriff (Councillor Milward) were elected on the Committee for the ensuing year:—Mr. R. Anderson, Mr. G. Balmford, Mr. William Bland, Mr. J. Blenkin, Mr. S. Border, Mr. G. Browne, Mr. J. W. Craven, Mr. A. Dunkley, Councillor L. Foster, Mr. G. Garbutt, Mr. T. G. Hodgson, Mr. G. Kirby, Mr. T. M. Lambert, Alderman McKay, Mr. J. Rotherford, Mr. H. Scott, Mr. G. Sellar, Mr. W. Stowe-Sharp, Mr. M. Cooper and Mr. J. E. Wilson. Grants of £550 to the Floral, £110 to the Music, £70 to the Balloon,

£100 to Fireworks, and £150 to the Amusements Sub-Committees were made during the evening. Votes of thanks to the retiring President (Councillor Clayton) and the Chairman concluded the meeting.

THE GARDENERS' ROYAL BENEVOLENT INSTITUTION.

WE have pleasure in drawing attention to the following highly satisfactory statement of accounts, which will be submitted to the annual meeting of this admirable Institution on the date of the present issue of the *Journal of Horticulture*. It will be seen that no less than £25,000 are invested in consols. It is doubtful if there is a charity in the kingdom more solidly and soundly established than this is, and it has done, and will do, an enormous amount of good. The weakest item in the balance sheet is that of a little more than £1400 in annual subscriptions, seeing that nearly twice the amount has been expended in pensions and gratuities. The Institution is certainly deserving of the support of all gardeners who can spare a guinea a year, and all the better if neither they nor their widows should ever need the pensions that are such a boon to the aged who have not been able to provide for homely comfort in the eventide of life. The preponderance of the disbursements alluded to over the subscriptions, however, brings out the gratifying fact that gardeners have good friends who are willing to help them, as well as demonstrates the strength of an Institution to which they should feel proud to belong.

STATEMENT OF THE RECEIPTS AND PAYMENTS OF THE GARDENERS' ROYAL BENEVOLENT INSTITUTION FOR THE YEAR ENDING DECEMBER 31ST, 1890.

	DR.	£ s. d.	£ s. d.	£ s. d.
To Balance 1889				753 10 6
" Annual Subscriptions		1463 12 0		
" Donations at and Consequence of Annual Dinner		2144 9 6		
" Collecting Cards		876 2 7		
		£4484 4 1		
" Advertisements		67 14 6	4491 18 7	
" Dividends on Stock		£619 1 3		
" Interest on Deposit		114 9 1	743 10 4	
				5235 8 11
				£5988 15 9

Stock in 3 per cent. consols, standing in the names of the Trustees—viz., Dr. Hogg, John Lee, and N. N. Sherwood, Esq., £25,000.

	CR.	£ s. d.	£ s. d.
By Pensions and Gratuities			2648 13 4
" Secretary's Salary and Honorary		212 10 0	
" Rent of Offices		75 0 0	
" Stationery		40 11 1	
" Book of Cheques		3 6 8	
" Printing		155 14 11	
" Expenses of Annual Dinner		94 16 0	
" Irvine & Co. Addressing Circulars and Printing of Name		91 11 0	
" Postages, Wages, and Sundry Petty Expenses		74 11 8	750 1 4
			£3394 14 8
" Purchase of £2000 2½ per cent. Consols			1897 19 0
			£5293 13 8
Balances—viz.,			
With Treasurer at Bankers		663 13 9	
With Secretary		23 8 4	692 2 1
			£ 983 15 9

Audited January 9th, 1891.

JOHN LEE
J. WEBBER
J. WILLARD } Auditors.

A GARDENING TOUR IN IRELAND.

(Continued from page 557.)

It is unnecessary to detain the reader in the northern portion of Antrim any longer; it will suffice to say that Coleraine and the neighbouring districts were visited, to investigate the condition of the small fruit industry there springing up, and promising to assume a much more important position in a few years' time. The neighbouring counties of Londonderry and Donegal were inspected, but as nothing of any especial gardening character has to be recorded we hurry on to the county town of Antrim, where two days were spent most profitably and enjoyably. Antrim itself is a quaint, quiet, little town with wide streets, and no business of any great importance except what arises from its agricultural surroundings. It is, however, chiefly notable for its situation almost on the borders of the great Lough Neagh, and really on what is termed the Six-mile-water, an arm, as it were, of the sea-like expanse of fresh water which covers so large a space. It is an historic site, and in and around the town are several gardens and estates occupied by old families that have taken a prominent part in the history of Ireland for centuries. Within the town itself is Antrim Castle, the residence of Viscount Masserene, and the entrance facing the principal street has an imposing castellated appearance. Beyond this is the beautiful estate of Shanes Castle, with its massive ruins of the old castle and its interesting garden, but to these we must return, as for convenience sake we will briefly relate a journey in another direction from Antrim first—namely, amongst the orchards towards Crumlin, finishing at the garden of Langford Lodge.

Although the greater part of the district around the town seems to be fairly well cultivated, and farmers who have gained a comfortable competency from the land are by no means so scarce as might be imagined, yet it cannot be said that fruit culture has come in for an adequate share of attention, though this is reputedly one of the old fruit-growing portions of the county. Something like sixty or seventy years ago there seems to have been a general stir in fruit planting, especially Apples, for nearly all the orchards are fully that age, and some probably older. Judging by report these trees when in their prime brought ample returns to the tenants, and it was apparently expected they would always continue to do so, for in the majority of cases they have been left to themselves to become hoary antiquities, laden with moss and lichen, picturesque in the extreme, and fine artistic studies, but

thing in the way of renovation or replanting has been adopted the results are all that could be wished. In most of the establishments visited excellent examples have been set for the farmers to follow, and some of these are slowly awakening to the fact that much of their ground, at present occupied with old exhausted trees, is useless.

In the course of a drive from Antrim to Langford Lodge, the residence of the Rev. A. H. Pakenham, an idea is formed of what has been lost by neglect, and upon reaching the garden and orchard there it can at once be seen what could be effected by the expenditure of money and labour even under more unfavourable circumstances in some respects than prevail generally in the district. Fruit trees are there made to yield a good return both on the walls as standards and in other forms, and from the experiments being

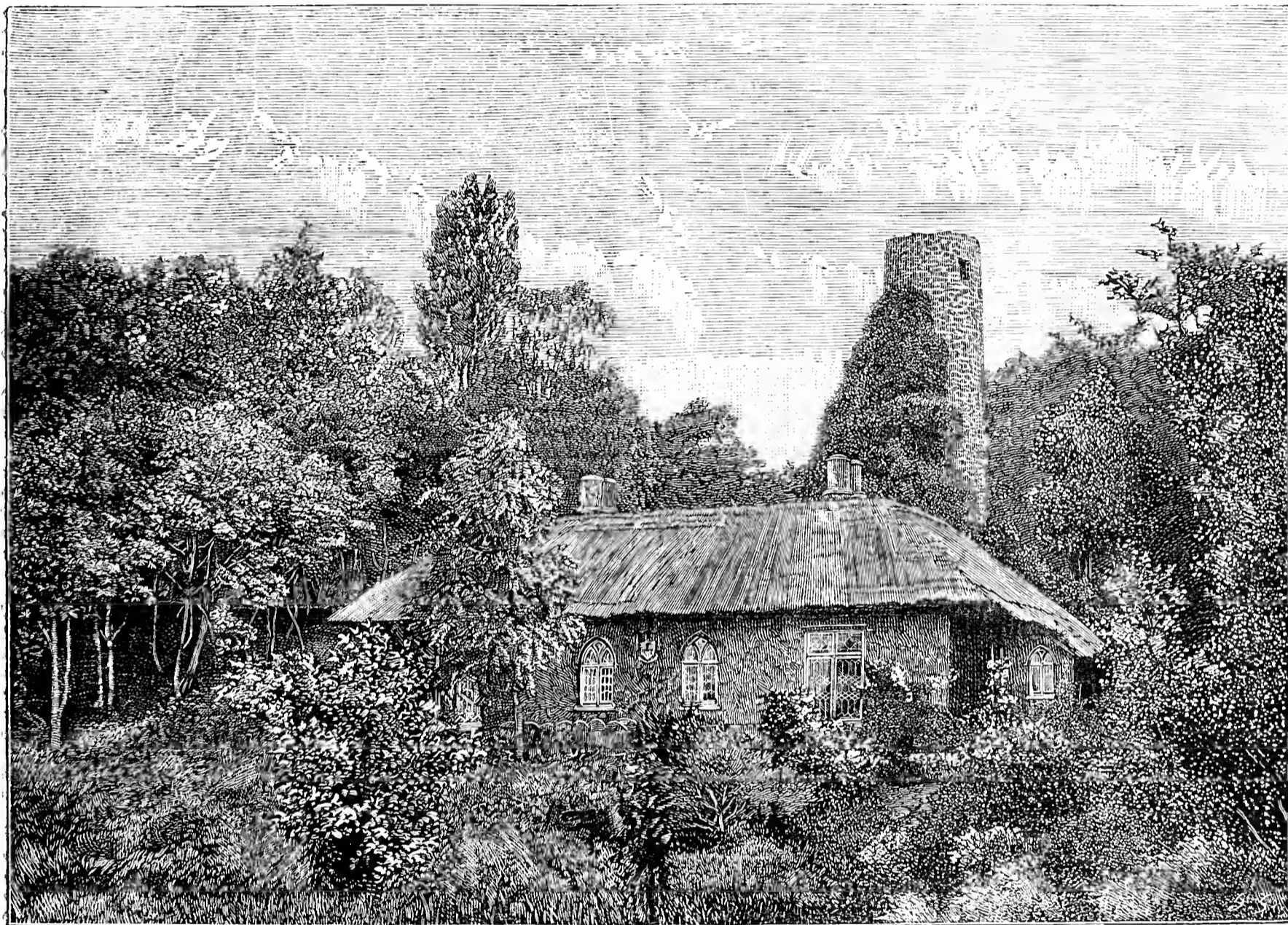

FIG. 11.—AN IRISH COTTAGE GARDEN AND OLD ROUND TOWER.

melancholy monuments when viewed from a prosaic commercial standpoint. Their owners now are apparently content to secure an occasional crop of small fruit, quite unfit for sale, except in a most unremunerative market. In favourable seasons it is said that large crops are obtained from some of these ancient trees, and it is thought better to have these than to incur the cost of replanting and wait for better returns. Probably only a few of the tenants could afford to undertake such work, but it might be a profitable investment for the landlords under judicious management. To a great extent the origin of the general fruit-growing around Antrim appears to have been due to an action of this kind early in the present century, for it is said that one of the gardeners at Shanes Castle was instructed to raise large numbers of fruit trees, which were distributed amongst the tenants and neighbours for a long distance. Many of the decrepit specimens remaining were no doubt obtained in this way, and it would be a very good plan if a similar system were adopted again. It is evident that fruit-growing can be conducted successfully, for the gardens prove that, and wherever any-

undertaken it is probable that still more important results will be achieved ultimately. The fruit department is, however, only one of the attractions of Langford Lodge, for the garden itself is one of the most delightfully old-fashioned snuggeries imaginable, furnished with hundreds of interesting trees, shrubs, and hardy plants; some of the former of great age and corresponding dimensions. Report has it that a garden was first formed there in 1706, and it can be imagined that 184 years would produce substantial tree growth in such a climate. One of the most charming features is the Rose garden, for Roses are first favourites with Mr. Pakenham, and there we see them in their natural and unrestricted beauty. Spacious beds and borders are massed with all the best varieties, while numerous arches are covered with the trailing varieties and other climbing plants, such as Clematises, which give a very artistic appearance to the scene. Near this is a curiosity in the shape of a huge petrified tree stem taken from Lough Neagh, and believed to be the largest example in Europe. It is 6 feet high, 9 feet 6 inches in circumference at the top, and 14 feet at the bottom, the grain is

perfectly preserved, and it seems as if it has been formed by the infiltration of mineral matter into the cells of the wood, for the structure appears unaltered.

From several points extensive and picturesque views are afforded of Lough Neagh and Ram's Island, which is only a short distance from the garden, and owing to the luxuriant vegetation it supports it affords some pleasing views. One of these is depicted in the woodcut (fig. 11), prepared from a photograph kindly sent by Mr. Pakenham, and it is doubly interesting, as besides showing an Irish cottage and garden of the most comfortable style, it also includes one of the remarkable old round towers that are scattered about in Ireland, and concerning the origin of which so much has been written.—L. CASTLE.

(To be continued.)

AS OF A DREAM.

(Continued from page 18.)

STILL referring to my exhibit at the Drill Hall last year, I have some more varieties to mention, and will therefore proceed with them in the order of their numbers.

Nos. 21 and 22 labelled "Walnuts young and Walnuts old." I happen to have four old trees, therefore pickled Walnuts naturally chime in with our store-closet arrangements. To those who like pickles Walnuts generally become acceptable, and "Walnuts with the wine" is proverbial. Mine are the English variety, apparently chance seedlings, as no two of the trees are exactly alike; they are very good, and the produce is considered strictly as "pin-money." Do not plant Walnut trees, however, too near to a public road or a footpath, as they and other nuts are irresistible. I took up to the Drill Hall two sorts of the latter, Nos. 23 and 24, Webb's Prize Cob, and a medium-sized choice Filbert, a kind I found in 1847 growing in the old Rectory garden at Woodstock. The former originated with Mr. Webb, of Calcot, near here; and to make sure that no one should enjoy it with a glass of liquor he caused a deep pit to be dug in the garden, and the contents of his cellar bundled into it, which might or might not have been a wise proceeding. At any rate, Webb's Prize Cob is a very good Nut to grow. Dr. Mavor—he of the immortal spelling book—I judged by the age of the trees, must have been familiar with the Filbert at Woodstock, and I have often wondered that he never mentioned them, voluminous compiler that he was. For a connoisseur of Nuts it is desirable, but it is "not large enough for the market," Webb's Cob is.

I come now to the Apples. I will not say how many sorts I grow, but as I experience the evil of too many, I can advise in a prudent manner.

Friend Collard again. He presented me with some young trees of Mr. Gladstone Apple. I did not show it as its season was long over. I maintain it as my earliest. When these Apples are carefully gathered, and before they are fully ripe, without disturbing the dense bloom upon their skins, they will soon flush into colour and command the early market, or take their place in the dessert and for home cooking. It is not advisable to store it in heaps or keep it too long, as under these circumstances it becomes of an unpleasant clamminess to the touch. Neither is it necessary to store it, for the Keswick Codlin, which is also an early Apple (No. 25 on my stand), quickly follows the Gladstone, is one of the best of Apples, and most suitable for all purposes for quite two months. No. 26, Holland Pippin.—I suppose my tree of this to be quite seventy years old, and I carefully maintain it in life because of its excellency. Its season is just about over, and our last pudding of it is in the near perspective. Our next household Apple, No. 26, I have named Pay-the-Rent, because the old tree of it which I found in my orchard—about an acre—has paid the rent for me, in a great measure, consecutively for thirteen years. I took some fruits of it up to the Apple Congress at Chiswick, to seek a comparison, but could not. I brought it up also for the R.H.S. Fruit Committee to adjudicate upon, but by some chance a fruit spotted in its skin got into their hands, and "the gods have their laws." But its medium size and lack of colour, at any rate, I doubt, would have caused it to be "passed." In reality I merely wanted to find out if it was known. It is a famous house fruit, comes quickly into bearing, a second early, and good quite into the middle of January. The growth of the tree and its foliage are very near that of the Blenheim Orange, and the fruit is quite as good for dessert as that overpraised variety. I must now conclude it to be unique, and, if I did not possess it, I would give its place to the Golden Spire, No. 27.—My wife calls this her "mincemeat Apple," as being her best for this purpose. None of the American Apples can oust this for quality or surpass it for beauty; and this is saying a great deal.

No. 28, Lane's Prince Albert.—I sometimes think I have known this Apple a good many years, but however that may be it is an excellent household fruit, a good bearer, and a good keeper. If I was compelled to confine myself to six kinds I would certainly give the above a place to precede the Wellington. No. 29.—The same remark I made about the good looks of the Golden Spire holds in a still higher degree for the Wellington, and no American Apple can touch it in piquancy for cooking. But the trees are somewhat tender, which results in canker. The trees of the Bramley Seedling are hardier in constitution, and the fruit keeps as long as the Wellington, but the latter takes front rank, and must be considered as indispensable for our *chefs*. I am in a position to settle a question which I saw put but lately, as to whether there are two varieties of the Wellington, striped in colour and non-

striped. Amongst my Wellingtons—which I have planted largely—are two trees that came from the late Mr. Soden's Nursery, Barton, Oxon. The fruit comes striped from those two trees. I took some up to the Chiswick Conference, and Mr. Barron's dictum was "striped Wellingtons." Friend Ross, when on a visit to me, was so struck with the beauty of the fruit and their singularity as to think they might be a variety, and he begged me to send him a few grafts to Welford Park during the following winter. I did. Mr. Ross informs me the Apples produced on the trees which were grafted with my scions came, with him, of the usual suffused hue; not a striped coloured fruit appearing amongst them. Therefore, we may conclude these occasional divergences to be mere freaks of Nature.

As to dessert Apples I limited my collection to two varieties, Cox's Orange Pippin, and Wheeler's Russet, Nos. 30 and 31. Cox's Orange is too thoroughly well known to need any further praise; but Wheeler's Russet is a very old variety, which I knew under that name at Rushbrooke, in Suffolk; and trust a boy for not finding out the best Apple in the orchard, or that at the fag-end of the season in the fruit-room. And now that I am a boy of older growth I can return to my first love with all the ardency of my youth. I found a miserable looking, scraggy old tree growing here; but as chance would have it I deferred cutting it down, and, to my joy, the few fruits that it produced in the next season I found were my long lost Wheeler's Russet. After a liberal course of treatment the old tree threw me a young shoot, and then died. I perpetuated it by grafting the young shoot on to a young stock, and hence its representative at the Drill Hall. It was the means of introducing me to Mr. Roupell, who greatly admired the fruit, and questioned me about it. The above two Apples, purely and simply as dessert fruits, ought to satisfy the small holders, and if Wheeler's Russet cannot be had let Cox's Orange suffice. It may be questioned whether I should have recommended "Wheeler's Russet" at all under these uncertain circumstances, or the "Pay-the-rent" either. My apologies must be, then, because the Apple jelly exhibited was made from the latter, and I had hoped to catch the Judges' eyes and palates for both. I will make atonement. Should this meet the eye of Mr. Roupell, allow me to state how happy I should be to send him some scions of both the varieties in the hope of assisting him for his pomological disquisitions in the future.

Pears may now come under the same category as dessert Apples—two kinds only, on the supposition that a garden measures about half an acre of ground, and the two Pears I should choose would be Williams' Bon Chrétien for eating, and the Catillac for stewing. I will nevertheless mention the kinds which I grow, because my garden and orchard ground consists of two acres, which affords me to indulge in a list of six. My first early Pear is the Doyenné d'Été. Till within the last two years the tree grew in the garden, and we scarcely knew what it was to gather a fruit from it; the fat blossom buds offering such precocious temptation for the tom-tits. I moved the tree into my cottage yard, and now it produces fruit. The blossom devourers are now made cautious by consequence of the cats. As we do not allow these creatures to come into the house they are much in the yard on the look out for tit-bits, and the tom-tits into the bargain. This gift of summer Pears comes very acceptable to my family, as we are great fruit eaters. To encourage a full flavour it should be gathered before it turns yellow upon the tree. Williams' Bon Chrétien follows within a reasonable time, and it is a universal favourite. Beurré Clairgeau, an almost certain bearer, I grow as a "bush tree" in the garden. It is a very useful Pear, "quite good enough for the market," was rather contemptuously observed to me. Its flavour here is remarkably good. I happen to have in the orchard a very old tree of the Swan's Egg. I would not exchange its fruit for any of the best reckoned modern Pears. It is becoming so scarce as to be almost unknown, for which reason I took up a dish. No. 32, Bergamotte Esperen, failed me this year. It is, as a rule, a sure bearer with me as a standard, and it is our latest eating Pear. No. 33, Catillac, alias Pound, alias Iron Pear.—I have a large old standard which seems likely to endure another seventy years under good management. It rules as a stewing Pear, and never fails as a marketable commodity.

What about Cherries? Of these the blackbirds and thrushes are insatiable. The difference between mine and thine in the instance of Cherries does not count in the *feræ naturæ* vocabulary. I cannot harden my heart sufficiently to shoot the songsters, consequently I grow but one Morello as a bush tree, and even that so as to be under the command of netting. The rascals, I allow them full pasture amongst the Berberis, but their bird consciences would not leave me a Cherry. No, do not grow Cherries unless they can be well protected, and this must remain a consideration, more or less, for all the small fruits.—ROBT. FENN.

(To be continued.)

POTTING.

MY sole reason for taking this subject up is in the interest of young men who are in danger of being misled by Mr. Bardney's article. To advocate a wholesale potting and repotting of plants during the dull months, say November and December, is not likely to meet with support, although it may possibly be the means of many trying the experiment. Mr. Bardney says in the fifth line of his article, "It has occurred to me;" that is not sufficient testimony of experience to meet with general support; it has the ring of his being suddenly impressed with an idea not actually tested by experience.

The principle of potting accepted by men of experience, men who

have proved their skill throughout the country, has certainly much to commend it. I do not advocate non-potting for a space of five months, and few private establishments can be named where the majority of plants are allowed to remain undisturbed for five months. I claim that no gardener who uses forethought throughout the summer and autumn need have any necessity for repotting many plants during November and December, the two months when vegetation is the least active. I firmly believe, and practise, free root-room for plants, but scarcely ever find it necessary to repot many during the months named.

The risk attached to this midwinter potting is almost as great as moving shrubs in midsummer, the only difference being the midsummer shrubs are likely to suffer from lack of water, and the midwinter plants from excess of water. Plants repotted during midwinter do not take freely to the new soil, and the danger of over-watering is increased twofold. Of course where there is no lack of heat the danger is not so pronounced, but all are not so fortunate in that respect.

I attach no importance whatever to the examples named; they do not, in my opinion, strengthen the case. The paragraph containing a reference to Chrysanthemum cultivation still further weakens the article; in fact why the Chrysanthemum should be used to illustrate the case I am at a loss to understand, but when we look at the question asked at the close of the paragraph, "How is this?" it surely has not "occurred" to Mr. Bardney that the successful exhibitor of Chrysanthemums practise a wholesale repotting throughout the dull months. The Chrysanthemum, strictly speaking, makes its growth during the summer months, and scarcely ever needs much attention as regards repotting through the winter. Therefore I fail to see the force of the comparison.—F. D., *Oakleigh*.



NEW VARIETIES OF CHRYSANTHEMUMS.

MR. C. E. SHEA'S notes on the above are both interesting and instructive, as many varieties may have succeeded in some districts while in others they fail, not always through bad cultivation. In some cases the demand for novelties is so keen that the stock becomes somewhat weakened by propagation. In consequence the second or third cuttings cannot be so strong as those taken early in the season. I here give a few notes on some not mentioned in Mr. Shea's list.

Zillah proved a really good variety. It is an incurved Japanese, of fine form, deep and well filled in the centre; colour, buff yellow, flaked with chestnut red; height, 6 feet; very strong grower. The buds were taken early in September. The blooms were fully out the third week in November, rather too late. This may be accounted for by the cuttings being struck as late as the first week in March. I have heard little of this variety.

W. H. Lincoln has proved a splendid yellow of Stanstead White form, very dwarf in habit. Our blooms were produced upon plants not more than 2 feet in height. The crown buds were taken about August 4th, and the blooms were at their best by the middle of October. We should have left them for terminal buds or propagated later, February being early enough.

Mrs. W. Sargeant, another incurved Japanese, bright straw yellow, of fine form, quite up to exhibition form. A fine bloom was exhibited in the premier twelve at the Nottingham Horticultural Society's Show. It is, however, not so free in producing cuttings as many of the American varieties.

Mrs. Langtry is a pure white variety, a large spreading flower of graceful form. The outer florets quilled, the inner flat, and incurving towards the centre. Buds were taken the first week in September, and the blooms were in perfection the first week in November. It has been much admired.

Lilian Bird is of distinct colour and form, being of pale salmon pink, very long and quilled florets. This and Mrs. W. Sargeant arrived here late in the season, consequently I am in ignorance as to the proper seasons; but, however, these both flowered about the middle of November, which leads me to think the buds must not be taken too early. This variety suffered somewhat from damp, otherwise the blooms would have been fine.

Eynsford White is certainly one of the best that has yet appeared. Crown buds were taken early in August, which proved to be fourteen days too early, as the blooms were at their best by the third week of October. One plant was allowed to extend to the terminal bud, and from this the blooms were at their best by middle of November. The blooms from the crown bud were more weighty and larger altogether than from the terminal buds, which were quite as large as Avalanche, and to my mind quite as good, while the terminal blooms were all that could be desired, being full in the centre. This variety kept fresh with us much longer than Avalanche. I believe it will also be an acquisition for cutting, and will be tried here next season for this purpose.

Marvel was very fine but much too early, owing to our taking the buds too early, while terminals produced blooms too thin, also not having good centres.

Massalia is a grand colour. Crown buds produce bloom much after the form and colour of Mrs. Holmes, but deeper; but terminal blooms take more after the form of Cullingfordi. This variety may not be quite up to exhibition form, nevertheless invaluable as a decorative plant. It is later than Wm. Holmes and earlier than Cullingfordi.

W. W. Coles has been praised so much, though deservedly, that nothing need be said, only that it is one of the best. We had good blooms from the middle of October to the middle of December from buds taken at various dates. The same may be said of Mrs. J. Clarke.

Amongst the best and most promising from which something good may be expected are Geo. McClure; Edwin Lonsdale, rich dark purple; Flammula, crimson; Mrs. C. Harris; Miss Mary Wheeler, incurved Japanese, rosy purple; Mary Weightman, golden yellow, somewhat after the style of Jos. Mahood; Tacoma, incurved Japanese, creamy white, fine full blooms, medium size; Kioto was very fairly good, and I think this will prove useful another year, as also will Coronet (this is of good habit and constitution). We have many more, but owing to receiving the plants so late in season it is not possible to judge of their merits.—J. PITHERS, *Chilwell*.

SEEDLING CHRYSANTHEMUMS.

THE following Japanese varieties have been raised by Mr. Owen from English saved seed, the results of crossing well-known varieties of dwarf habit. Many of the new varieties do not grow beyond 3 feet high, which is a decided gain. The following are a few of the most noticeable:—

Masterpiece has a full bloom, partaking somewhat of the Madame Baco style of development, but considerably larger than that sort, especially in the breadth and length of the florets. I name Madame Baco simply to give an idea of the style of flower. The colour is most difficult to describe. I call it a pale magenta, lighter towards the centre, with a brown suffusion over the surface of the florets, the reverse cream, shaded silver.

William Kipps.—This variety belongs to the incurved Japanese section. The surface of the florets partakes of the colour of Edwin Molyneux, mottled with a lighter shade of colour and splashed with specks of gold. The reverse of the florets is gold striped with dull crimson, the tips while young being golden. The florets are of medium width. Altogether novel and distinct.

Mrs. Gladstone belongs to the reflexed Japanese section. The florets somewhat like Eynsford White, the points lance shaped, the extreme tips curl upwards. The colour is ivory white. A full flower, and of a promising character.

Henry Perkins is thoroughly incurved, reminding me of L'Automne. The florets are very pointed. The centre of the flower is golden amber, the outer part bronze or chestnut red, clearly striped with brown. Whether this variety can be classed as an incurved or a Japanese remains to be seen.

G. C. Schwabe has broad florets, promising to incurve somewhat. The colour is most remarkable, the surface being chestnut red, striped and suffused with gold, the outside the same, but with the gold tint in a less degree.

G. P. Lawson is of American origin, incurved Japanese; florets of medium width, bright orange yellow in the centre, the outer part of the flower and the base of the petals heavily striped with chestnut red. A very showy and distinct variety.—E. MOLYNEUX.

CHRYSANTHEMUMS FOR CHRISTMAS.

ON page 13 of the January number of the *Journal of Horticulture*, a new Japanese Chrysanthemum, M. E. A. Carrière, is mentioned by "E. M." as a variety which promises to prove useful, especially for Christmas church decoration. It is to be hoped the variety in question will be found upon further trial to maintain its reputation for the purpose stated; if so it will be a decided acquisition to the list of useful Chrysanthemums. It may be added also that such information as "E. M." has given is very much appreciated at all times by many who are interested in the decoration of churches for the various festivals of the Christian year. There can be no question that of all the flowers employed at Christmas the Chrysanthemum takes the first rank. It is a plant that is so easily propagated, and one that can be taken in hand with fair prospect of success by most amateurs, especially those who have well studied Mr. Molyneux's book on the subject, and who glean information weekly of a like nature from the *Journal of Horticulture*. The Chrysanthemum, moreover, has, besides the recommendations above stated, the following—it flowers abundantly, and can be depended upon as to the time of flowering; in fact the latter is, to a large extent, within the power of the cultivator to hasten or retard; that is to say, within certain limits. The flowers, too, last individually if cut and placed in water in a cool room, in some cases an astonishingly long time; so that, on the whole, the pure white and crimson Chrysanthemums, especially of the Japanese class, are unsurpassed as flowers for Christmas church decoration. Any hints as to good varieties for the purpose, as well as their cultivation, will always be appreciated.—GEO. HASLAM, *Brotherton Vicarage, Yorkshire*.

ETOILE DE LYON CHRYSANTHEMUM.

WHAT a wonderfully useful, as well as large Chrysanthemum, this is. I have some cut-down plants at present flowering freely in my greenhouse. They are not quite 2½ feet high, and have been flowering continuously in 10-inch pots since the first week in November, and if the blooms had any fault it was that they were too large. They are of great substance, and that may account for their staying power. They first come of the

most delightful rose pink, and are now shading off to pure white. A companion dwarf grower is Mrs. Falconer Jameson. If any of Mr. H. Cannell's recent introductions, such as Sunflower, Eynsford White, Robert Cannell, Louis Boehmer, &c., can come near those, and Avalanche especially, in their dwarf habit, he will deserve a still further higher niche in the temple of fame.—W. J. MURPHY, *Clonmel*.

ROYAL HORTICULTURAL SOCIETY.

JANUARY 13TH.

THE first meeting of 1891 was not largely attended by exhibitors, and this, no doubt, was due to the bad weather; but it is probable that the Floral Committee have never had less to do on any occasion than on Tuesday last, for their duties were performed in ten minutes. Orchids and Apples formed the bulk of the exhibits.

FRUIT COMMITTEE.—Philip Crowley, Esq., in the chair, and Messrs. John Lee, R. D. Blackmore, J. T. Saltmarsh, W. Bates, G. Wythes, J. Cheal, W. Warren, A. H. Pearson, A. J. Sutton, A. Dean, J. Hudson, H. Balderson, J. Smith, W. Denning, J. Penny, G. Reynolds, and J. Wright.

Mr. Crowley, Treasurer of the Society, in occupying the position as Chairman of the Committee, addressed a few words to the members, enlisting their support in conducting the work during the year, which he hoped would be well and carefully done. He also desired it to be made known to exhibitors that if they could stage their produce half an hour before the Committee assembled it would enable the necessary clerical work being done, and particulars regarding the specimens to be placed on the table with them for due consideration. Unanimous assent was given to the Chairman's observations, and we are sure he will receive the best support that can be accorded him in the honourable position in which he was cordially welcomed.

The only exhibit of fruit on this occasion, and it was a very excellent one, was a collection of nearly a hundred dishes of Apples from the Pomona Farm Nurseries, Withington, Hereford, by Mr. John Watkins. Nearly all the specimens were remarkable for their high colour, and many of them were of large size, no foreign fruit now on sale in the London shops equalling them. Particularly noticeable were Tyler's Kernel, Striped Beefing, Dumelow's Seedling (deeply flushed with red), Gloria Mundi, and Blenheim Pippin, while the following varieties were admirably represented:—Beauty of Wilts, Stoke Edith Pippin, Kirke's Fame, Golden Noble, Warner's King, Beauty of Kent, King of the Pippins, Mère de Ménage, Bedfordshire Foundling, Royal Somerset, Flanders Pippin, and Annie Elizabeth. Dessert varieties also were remarkably well kept and coloured. A silver medal was unanimously recommended for the collection, and a question arose relative to the desirability of providing some appropriate form of distinguishing such individual dishes in collections of fruit as may be noted for special excellence, and the suggestion does not appear unworthy of consideration.

FLORAL COMMITTEE.—Present: W. Marshall, Esq., and Messrs. Herbst, T. Baines, W. Furze, W. C. Leach, C. E. Pearson, G. Nicholson, R. B. Lowe, H. Turner, C. Jeffries, J. Bennett-Poë, J. Walker, C. Noble, G. Paul, C. T. Drury, Frank Ross, R. Dean, F. Fraser, and Rev. H. H. D'Ombraïn.

Mr. T. S. Ware, Hale Farm Nurseries, Tottenham, secured a cultural commendation for a pot and flowers of the white Narcissus monophyllus, very attractive at this time of year, and useful for culture in pots. Mr. W. C. Leach, gardener to the Duke of Northumberland, Albury Park, Guildford, showed flowers of American varieties of Chrysanthemums, but they were not in condition to permit an opinion being formed as to their merits.

ORCHID COMMITTEE.—Present: Harry J. Veitch, Esq., in the chair, and Messrs. D. B. Crawshay, Norman C. Cookson, F. Tautz, J. Dominy, H. Ballantine, H. Williams, E. Hill, J. Douglas, Lewis Castle, S. Courtauld, J. O'Brien, H. M. Pollett, and Dr. M. T. Masters.

Messrs. B. S. Williams & Son, Upper Holloway, contributed a handsome group of Orchids and fine-foliage plants. Cypripediums were represented by many handsome varieties and hybrids. Lælias and other choice Orchids were also contributed, together with a plant of Oncidium Phalenopsis having five flowers and buds. Cypripedium Salkieri aureum was especially noteworthy for the wax-like texture of the flowers and its soft golden tint. (Silver Flora medal.)

Messrs. Sander & Co., St. Albans, exhibited a group of Orchids comprising Lælia anceps Ballantineana (award of merit), a peculiar brownish Catasetum, a fine pseudo-bulb of Dendrobium Leechianum having numerous flowers, the pure white Lælia anceps alba, and a handsome hybrid Cypripedium named Kramerianum, from C. oenanthem and C. villosum, the dorsal sepal margined with white, and veined with rich purple, the petals and lip also tinted with purple and polished.

The Right Hon. J. Chamberlain, M.P., Highbury, Birmingham, showed four varieties of Lælia anceps, named oculata, Barkeriana, and grandiflora, the latter securing an award of merit. Messrs. Pitcher and Manda, Hextable, sent several new Cypripediums, one named Masereelianum resembling C. Leeianum superbum, and another notable one was named C. magniflorum, the lip and dorsal sepal green, the petals long, narrow, and tinted rose or green. From J. Charlton Parr, Esq., Grappenhall Heyes, Warrington, came a pale coloured Cypripedium under the vague name of "hybrida," and without any particulars as to its parentage. It was considered to be identical with C. Carnusianum from C. Haynal-

dianum and C. Spicerianum, of continental origin. G. F. Ebner, Esq., Horton House, Beckenham, Kent (gardener, Mr. W. Franklin), sent a plant of Cypripedium Savageanum superbum, with one neat purple tinted flower, the dorsal sepal rounded and margined with white.

Messrs. J. Veitch & Sons, Chelsea, sent a group of choice Orchids, comprising C. Niobe, C. Calypso (Spicerianum and villosum); Dendrobium euosmum roseum (nobile and endocharis) very graceful; Calanthe excellens, and C. Harrisianum superbum, also a hybrid between that and oenanthem superbum, which was greatly admired, but the flowers not being fully developed it was thought desirable to see it again before making any award. The dorsal sepal was rounded in form, of an extremely dark crimson purple colour, the veins running to the margin on a white ground. G. Burnham, Esq., 17, Paget Road, Stoke Newington, exhibited a large and well flowered plant of Cypripedium insigne, for which a vote of thanks was accorded.

CERTIFICATED PLANTS.

Begonia Winter Gem (J. Veitch & Sons).—A handsome winter-flowering Begonia, obtained from a crimson scarlet Tuberous Begonia and B. socotrana; plant dwarf, the flowers neat in form, very bright crimson, the leaves crimson, resembling B. socotrana.

Lælia anceps Ballantineana (Sander & Co., St. Albans).—A pretty variety with well-formed flowers, the petals broad, white, tipped crimson; the lip is small, tipped with intensely rich magenta, and veined with a similar colour in the throat.

PROGRAMME AND COMMITTEES.

The Council of the Society has issued a comprehensive programme and schedule for the year 1891, in which new features have to be noticed. In addition to the usual Committee meetings, lectures, and Conferences during the year, money prizes and medals are offered on several occasions for competition amongst amateurs. This is a commendable departure, and it is to be hoped will bring satisfactory results both in exhibits and attendance. Plants, flowers, and fruits are duly provided for, and there is some attraction for every meeting in the year.

The following is the programme, and upon each of the dates named the Fruit, Floral, and Orchid Committees will meet at twelve noon, except on May 27th (Temple Gardens), July 7th, and October 6th (Chiswick), when the meetings take place at 11 A.M. The lectures will commence at 3 P.M. each day:—January 13th, "Persian Cyclamen," Mr. W. Warren; "Hardy Cyclamen," Rev. W. Wilks, M.A. February 10th, annual general meeting at 117, Victoria Street, S.W. March 10th, "Snowdrops," Mr. James Allen; Mr. F. W. Burbidge, F.L.S. March 24th, "The Cultivation of Hardy Bulbs and Plants," Herr Max Leichtlin. April 14th, "Lachenalias," Mr. F. W. Moore; Exhibition of Daffodils. April 21st, "Cape Bulbs," Mr. James O'Brien; Primula and Auricula Society's Show. May 12th, "Hybrid Rhododendrons," Rev. Prof. Henslow, M.A., F.L.S. May 27th, 28th, Great Show in the Inner Temple Gardens. June 9th, "Alpine Plants," Rev. C. Wolley-Dod, M.A. June 23rd, "Tea Roses," Mr. T. W. Girdlestone; National Rose Society's First Show; Exhibition of Herbaceous Pæonies. July 7th, at Chiswick, Conference and Exhibition of hardy summer perennials. July 8th, at Chiswick, Conference and Exhibition of varieties of Strawberries, Raspberries, Currants, and other small fruits. July 21st, "Early Peaches," Mr. T. Francis Rivers; Carnation and Picotee Society's Exhibition. August 11th, "Ornamental Stove and Greenhouse Plants," Mr. J. Hudson. August 25th, "Gladiolus," Rev. H. H. D'Ombraïn, M.A.; Exhibition of Gladiolus. September 8th, "Hardy Water and Bog Plants," Mr. Geo. Paul. September 22nd, "Insect-Eating Plants—Nepenthes, Dionæas, Sarracénias, &c.," Mr. R. Lindsay; Mr. Lewis Castle. October 6th, at Chiswick, Conference and Exhibition of Perennial Sunflowers and Michaelmas Daisies (Asters). October 7th, at Chiswick, Conference and Exhibition of Conifers. October 27th, "Autumn Tints," Mr. Harry J. Veitch, F.L.S. November 10th, "Varieties of Soils," Mr. W. Ingram. December 8th, "Christmas Roses—Hellebores," Rev. Canon Ellacombe, M.A.

As several alterations have taken place, we also publish the names of the members of the three Committees:—

SCIENTIFIC COMMITTEE.

Chairman.—Sir Joseph Dalton Hooker, K.C.S.I., M.D., C.B., F.R.S., The Camp, Sunningdale.

Vice-Chairmen.—Dyer, W. T. Thicketton, C.M.G., F.R.S., Royal Gardens, Kew; Foster, Professor M., Sec. R.S., Great Shelford, Cambridge; Masters, Maxwell T., M.D., F.R.S., V.P.L.S., Mount Avenue, Ealing, W.

Hon. Secretary.—Rev. Prof. G. Henslow, M.A., F.L.S., F.G.S., Drayton House, Ealing.

Baker, J. G., F.R.S., Royal Gardens, Kew.

Blandford, W. H. F., M.A., F.E.S., 48, Wimpole Street, W.

Bonavia, Dr. E., 5, Harrington Mansions, South Kensington.

Burbidge, F. W., F.L.S., Trinity College Gardens, Dublin.

Church, Professor A. H., F.R.S., Shelsley, Richmond.

Clarke, Colonel R. Trevor, Welton Place, Daventry.

Darwin, Francis, F.R.S., Wychfield, Huntingdon Road, Cambridge.

Dod, Rev. C. Wolley, Edge Hall, Malpas, Cheshire.

Elwès, H. J., F.L.S., F.Z.S., Preston House, Cirencester.

Frankland, E., F.R.S., The Yews, Reigate Hill, Reigate.

Gilbert, J. H., Ph.D., F.R.S., Harpenden, Herts.

Godman, F. DuCane, F.R.S., 10, Chandos Street, Cavendish Square, W.

Llewelyn, Sir J. T. D., Bart., F.L.S., Penllergare, Swansea.

Lynch, R. Irwin, A.L.S., Botanic Gardens, Cambridge.

McLachlan, R., F.R.S., Westview, Clarendon Road, Lewisham, S.E.

Michael, Albert D., F.L.S., Cadogan Mansions, Sloane Square, S.W.
 Morris, D., M.A., F.L.S., 11, Kew Gardens Road, Kew.
 Müller, Hugo, Ph.D., F.R.S., 13, Park Square East, Regent's Park, N.W.
 Oliver, F. W., D.Sc., F.L.S., Kew Gardens Road, Kew.
 Pascoe, F. P., F.L.S., 1, Burlington Road, Westbourne Park, W.
 Plowright, C. B., F.L.S., 7, King Street, King's Lynn.
 Russell, Dr. W. J., F.R.S., 34, Upper Hamilton Terrace, N.W.
 Salvin, Osbert, F.R.S., Hawksfold, Fernhurst, Haslemere.
 Scott, D. H. Ph.D., F.L.S., The Laurels, Bickley, Kent.
 Symons, G. J., F.R.S. 62, Camden Square, N.W.
 Veitch, H. J., F.L.S., Royal Exotic Nursery, King's Road, Chelsea, S.W.
 Vines, Professor, F.R.S., Fairacres, Oxford.
 Ward, Professor Marshall, F.R.S., The Laurels, Englefield Green, Staines.
 Wilson, Geo. F., F.R.S., Heatherbank, Weybridge Heath.

FRUIT AND VEGETABLE COMMITTEE.

Chairman.—Crowley, Philip, Waddon House, by Croydon.
Vice-Chairmen.—T. Francis Rivers, Sawbridgeworth; John Lee, 78, Warwick Gardens, Kensington; R. D. Blackmore, Teddington.
Secretary.—Archibald F. Barron, Royal Horticultural Society, Chiswick, W.
 Balderson, H., Corner Hall, Hemel Hempstead.
 Bates, W., Poulett Lodge Gardens, Twickenham.
 Bennett, W., Rangemore Park Gardens, Burton-on-Trent.
 Bunyard, George, The Nurseries, Maidstone.
 Cheal, J., Crawley, Sussex.
 Cliffe, G., Shoreham Place Gardens, Sevenoaks.
 Coleman, W., Eastnor Castle Gardens, Ledbury.
 Cummins, G. W., The Grange Gardens, Wallington.
 Dean, A., Bedford, Feltham.
 Denning, W., Heathfield Nursery, Hampton.
 Dunn, Malcolm, The Palace Gardens, Dalkeith, N.B.
 Fairgrieve, P. W., The Palace Gardens, Dunkeld, N.B.
 Hogg, Dr., LL.D., F.L.S., 92, St. George's Road, Pimlico.
 Haycock, C., Goldings, Hertford.
 Hudson, J., Gunnersbury House, Acton.
 Lane, Fred, Berkhamsted.
 McIndoe, James, Hutton Hall Gardens, Guisborough.
 Miles, G. T., Wycomb Abbey, High Wycomb.
 Moss, A., 39, London Bridge, E.C.
 Norman, G., Hatfield House Gardens, Hatfield.
 Pearson, A. H., The Nurseries, Chilwell, Notts.
 Penny, C., Belle Vue, Salthill, Slough.
 Reynolds, G., The Gardens, Gunnersbury Park, Acton.
 Ross, Charles, The Gardens, Welford Park, Newbury.
 Saltmarsh, T. J., The Nurseries, Chelmsford.
 Smith, James, The Gardens, Mentmore, Leighton Buzzard.
 Sutton, A. W., F.L.S., Reading.
 Veitch, J. H., Royal Exotic Nurseries, Chelsea.
 Veitch, P. C. M., The Royal Nurseries, Exeter.
 Watkins, A., Exeter Street, Strand.
 Warren, W., Worton Gardens, Isleworth.
 Weir, Harrison, Sevenoaks.
 Willard, Jesse, Holly Lodge Gardens, Highgate, N.
 Woodward, G., Barham Court, Teston, Maidstone.
 Wright, John, 171, Fleet Street.
 Wythes, G., Syon House Gardens, Brentford.

FLORAL COMMITTEE.

Chairman.—Marshall, William, Auchinraith, Bexley.
Vice-Chairmen.—Masters, Maxwell T., M.D., F.R.S., V.P.L.S., Mount Avenue, Ealing, W.; Fraser, John, Lea Bridge Road, Leytonstone, E.; Paul, George, The Old Nurseries, Cheshunt.
Secretary.—Archibald F. Barron, Royal Horticultural Society, Chiswick, W.
 Bain, W., The Gardens, Burford Lodge, Dorking.
 Baines, Thomas, Fern Cottage, Palmer's Green, N.
 Bennett-Pöe, J. T., 29, Ashley Place, S.W.
 Burbidge, F. W., Trinity College Botanic Garden, Dublin.
 Brycesson, — Flora Villa, Plumstead.
 Cannell, H., Swanley, Kent.
 Castle, L., Hotham House, Merton.
 Dean, R., Ranelagh Road, Ealing, W.
 D'Ombraïn, Rev. H. H., Westwell Vicarage, Ashford, Kent.
 Drury, C. T., F.L.S., 25, Windsor Road, Forest Gate.
 Furze, W., Roselands, Broom Road, Teddington.
 Girdlestone, T. W., Sunningdale, Berks.
 Gordon, G., 1, Stile Villas, Gunnersbury.
 Goldring, W., 52, Gloucester Road, Kew.
 Herbst, H., Kew Road, Richmond, Surrey.
 Ingram, W., Belvoir Castle Gardens, Grantham.
 Jeffries, C., Boston House Gardens, Brentford.
 Kelway, W., Langport, Somerset.
 Laing, J., Forest Hill, S.E.
 Leach, W. C., Aldbury Park Gardens, Guildford.
 Lindsay, R., Botanic Gardens, Edinburgh.
 Lowe, R. B., Ashbridge Gardens, Berkhamsted.

May, H. B., Dyson's Lane, Upper Edmonton.
 Mawley, E., Rosebank, Berkhamsted.
 Molyneux, E., Swanmore Park Gardens, Bishops Waltham.
 Nicholson, G., Royal Gardens, Kew.
 Noble, C., Sunningdale Nursery, Bagshot.
 Pearson, C. E., Chilwell, Nottingham.
 Phippen, G., Victoria Nursery, Reading.
 Ross, F., Pendell Court Gardens, Bletchingley.
 Thomas, Owen, Chatsworth Gardens, Chesterfield.
 Turner, H., Royal Nurseries, Slough.
 Walker, J., Ham Common, Surrey.
 Watson, W., Royal Gardens, Kew.
 Williams, W. H. (Keynes & Co.), Salisbury.
 Wynne, B., 17, Catherine Street, Strand, W.C.

ORCHID COMMITTEE.

Chairman.—Veitch, H. J., F.L.S., Royal Exotic Nursery, Chelsea, S.W.
Vice-Chairmen.—Lawrence, Sir Trevor, Bart, M.P., 57, Princes Gate, S.W.; Douglas, J., Great Gearies, Ilford; Masters, Maxwell T., M.D., F.R.S., Mount Avenue, Ealing, W.
Secretary.—O'Brien, James, West Street, Harrow-on-the-Hill.
 Baines, Thomas, Fern Cottage, Palmer's Green, N.
 Ballantine, H., The Dell Gardens, Staines.
 Castle, Lewis, Hotham House, Merton.
 Crawshay, De Barri, Rosefield, Sevenoaks.
 Cookson, Norman C., Oakwood, Wylam-on-Tyne.
 Courtauld, Sydney, Bocking Place, Braintree.
 Dominy, John, 11, Tadema Road, Chelsea, S.W.
 Haywood, T. B., Woodhatch Lodge, Reigate.
 Hill, E., Tring Park Gardens, Tring.
 Kinleside, Rev. R. V. C., Sunbury House, Tunbridge Wells.
 Latham, W. B., Botanic Gardens, Edgbaston, Birmingham.
 Le Dout, G. R., Langton House, East Moulsey.
 Lindsay, R., Botanic Gardens, Edinburgh.
 Moon, E., Cassiobridge, Watford.
 Moore, F., Blendon Hall Gardens, Bexley.
 Philbrick, F. A., Q.C., Oldfield, Bickley Park.
 Pilcher, Charles, 84, Ringford Road, Wandsworth, S.W.
 Pollett, H. M., Fernside, Bickley, Kent.
 Sander, F., St. Albans.
 Schröder, Baron Henry, The Dell, Staines.
 Smee, H. J., Wallington, Surrey.
 Tautz, F. G., Dibdin House, Hanger Hill, Ealing.
 Williams, H., Victoria Nurseries, Holloway, N.



ROSELAND.—HYÈRES.

I CAN well understand that the ancients were at a loss to coin a word sweet enough for this enchanting spot. They called it Olbia, The Happy, and they named the new settlement Eros, or Love, and one of their poets, standing in the Palm groves under the warm shelter of the castled mountain that had resisted so many invaders, and looking out to the long islands of the Mediterranean glittering with bright rock and micaceous sand, called them the Isles of Gold! It is only early yet in the cold and cheerless month of January at home, but, as I write, the sun is streaming in to the tall French windows of our castellated hotel on the warm hill side. It is dancing and sparkling on the distant Mediterranean; it is cheering the hearts of the invalids, and there is not a red roof, or turret, or church spire, or Palm-divided avenue that, as I look over the smiling plain, is not literally bathed in sunshine as warm as any August at home.

I have been puzzled ever since I came here to account for the exquisite flower scent that perfumed the place and literally impregnated the air with varied sweetness. There are breezes that come to you softly and sweetly laden with Rose scents and Narcissus bloom, and deep undergrowth of Violets and Mimosa, for Hyères is the very headquarters of the flower-growing districts of the South of France. More cut flowers go to Paris and London from the nursery gardens in and about Hyères than from all the other favoured districts of the Riviera. They are all grown in the open and on the sheltered hillside. There is not a greenhouse or conservatory in the place. There they are, acres upon acres of sweet smelling Tea Roses, rows upon rows of variegated Anemones, Pinks, and Jonquils, Orange trees and Myosotis, Bluets, or Cornflowers—as we call them at home—interminable beds of Violets and the exquisitely scented Scilla, that perfumes the place for miles and miles around. Space fails me to describe what they really do grow in a district of four square miles. Most of the early vegetables, such as Artichokes and salads, go hence to the Paris market; but the sun-kissed tract of land over which I look from time to time as I write is wholly devoted to flower culture. I strolled over to visit one of the

largest flower gardens the other morning, and as I entered under a festooned arcade, weighed down with Gloire de Dijon Roses in full bloom, the kindly proprietor of the well-named La Rosière—M. L. Achard—one of the largest flower growers in the district, pointed with pride to his 50,000 metres of flowers undisturbed by a single vegetable. "Toujours les Roses, Monsieur! Toujours! Toujours! Pas de Legumes." And so it proved. I might have walked for hours on that sunny hillside amongst every variety of blossom, now brushing past bushes of Marguerites, now enjoying the scent of patches of monster Mignonette, now dazzled with the varieties of spring Pink and young Carnations, that are naturally attached to a corner of the world that has never known snow, and is unvisited by the curse of east winds and chill blasts of the cruel North.

Here then was a dream fully realised. Do you not remember, in the early days of the æsthetic movement, how the professors of that fantastic and self-conscious creed recommended the culture of "acres of Daffodils," and told us that flower farms would be established in our variable little England, where female attendants, in Kate Greenaway dresses fashioned in the artistic taste of Liberty & Co., would gather Lent Lilies and walk knee-deep in Hyacinths and sprawl under innumerable Sunflowers? In the sunny South of France the flower farm is no æsthetic dream, but a very important practical fact; and it is, at any rate, delightful to think that a district so specially favoured does not neglect its opportunities, but contributes very bountifully to the necessities of those who are destined to endure life as best they can in colder and more trying climates. In a few weeks' time the feathery Palm branches, on which the January sun glistens, will be gathered in abundance for the altars of Christian churches to be blessed by the priests on "Palm Sunday."

In this winter time, long before the sun has acquired its proper power, the mosquitoes are already busy with English visitors, as I found to my cost last night; the inhabitants hang about the street corners and lounge. But for all that it would be difficult to find a more courteous people than those born in the delightful land of Provence. What a charming life it must be, to dig in Rose gardens all day, and to live in a land that has never known snow. A merry, cheerful, contented, and delightful corner of the earth, where the sun always shines and the wind is ever soft, and the carriages and diligences come ringing through the village all day long from Toulon and the adjacent villages; where the hills are green with Pine and the plains are grey with Olives, and the gardens are full of rainbowed Roses—yes, of "Roses, Roses all the way," and the sea is of blue, and her islands of gold. A delightful spot is Hyères of the Palms.—(*Daily Telegraph*.)

A LESSON ON LEAVES.

[The following is the substance of a Report by Mr. THOMAS MEEHAN, Germantown Pa., Botanist to the Pennsylvania State Board of Agriculture.]

THE correspondence of this department has not been equal to that of former years, and has been for the most part confined to answering inquiries as to the names of plants—some of them being of weeds that have for the first time attracted attention. None of these have, however, been new to the State; nor does it appear that any noxious weeds are spreading more than usual. Inquiries are sometimes made as to the best method of destroying troublesome weeds. No plant can live if it is not permitted to make green leaves. If the land is full of something troublesome, there is nothing better than to put it in corn, and insist on continuous culture—not leaving the work till the weed to be destroyed has thrown out strong green leaves, but before it has had the chance to make any. Occasionally reports come to the botanist that weeds were not killed by this process. Failure could only come from neglect to hoe or cultivate, until the weed enemy has made some strong green leaves. It is a good lesson for a young farmer to give him some one stubborn weed plant—a Canada Thistle or Horse Nettle for instance, and let him try the experiment.

In like manner it is wholly healthy foliage that will give full crops. Whenever grain loses its leaves before the ears mature the crop is lessened. An excellent lesson can be had from two hills of corn. Commence to denude the plant of foliage before the silk or tassel forms, and watch the result on the crop. Even those who believe they understand the value of attention to these matters will be surprised with the force of lessons like these.

It has recently been placed beyond all doubt that the continual injury to the foliage of the Strawberry by the work of a fungus, which spots the leaves, is what proves the continual degeneracy of varieties. The hundreds of new varieties of Strawberries that have been introduced during the past quarter of a century have not given us in any respect better kinds than we then had, but they take the place of kinds that degenerate. When half the leaf blades are destroyed by the spot, the plant has only half the leaf surface it should have, and suffers proportionately. New seedlings are usually several years before they get the spot. The Sharpless is said to have resisted the attack longer than any one. The methods of culture, necessary though they be, lower vital power to resist the spot. It is said that the Strawberry in its wild state is able to resist the spot.

Another instance of the value of foliage is illustrated by the early fall of the leaf on the Pear or other trees, from the leaf fungus, from caterpillars, or from other causes. It is well known that the fruit will not then ripen well. Perhaps one of the best illustrations is by the loss of leaves on the Potato plant by the Colorado beetle, when all know no

crop is returned to us. It is impossible for a plant to continue long without healthy leaves. We can turn this principle to good account in the destruction of weeds—and to good account also, by doing all we can to keep the foliage healthy in the crops we grow.

A question was put to your botanist why trees with an abundance of fibrous roots often fail for all the best care in transplanting—while frequently the same trees with sprouting roots did well. It does not seem to be generally known that the fibres of a tree are the weakest part of the root system. It should be stated that the underground or root system of a tree is in many respects but the analogue or counterpart of the portion above ground. The two systems are founded on the same plan, but slightly modified. The young soft shoot becomes a trunk, while the same structure, pushing down, becomes a tap root. Side branches with leaves push from the trunk, the leaves performing an important part in feeding the tree. The side branches of the roots with fibres do just the same thing. The leaves work only one season and die, and just the same do the fibres. They die annually just as the leaves do. One may see how this is by looking at the fibres of an English Ivy, a Trumpet Vine or a Poison Vine, by which they are attached to something to climb by. None of them are over a year old. The living and dead fibres are all intermixed. Once in a while one of these fibres will get into a cleft of rotten mortar, or into a crevice of dead wood, and then instead of an annual fibre, it becomes a permanent root. We thus derive a double lesson. First, that roots are annual, and second, that a fibre that would, under ordinary circumstances, have but a year of life, becomes a permanent root, when circumstances favour a more than usual supply of nutrition. The same process goes on under ground as we see above. The fibres all die before the twelve months expire, a few only becoming permanent roots among the whole mass.

Another point is worth remembering. If we cut off a branch and place it in water, it will draw in some water, and live for a while, but unless it sends out new fibrous roots it will not live long. And just so with a tree. It can take in a little moisture through the surface of old hardwooded roots, but the roots have to make new active fibres before it can make much headway. It is indeed from the extreme white points of active growing fibres, that the tree derives its chief support. The old fibres, moved with the transplanted tree, have but little vital power. They make the white growing points only with difficulty, and hence are of little value. The fibres that have had vital power to go beyond their original annual condition and are destined to become the permanent roots of the plant, are the ones the tree planter should desire. And these are of value in proportion to their growth and vigour. If a mere annual fibre is of little value, so also are of little value old coarse hardwooded roots that are also sluggish as regards vital energy. If a planter can get a tree with a large portion of real roots of two, three or four years old, removal has the almost absolute certainty of success.

We see from these principles why large trees are often as great failures on transplanting as trees with a great mass of annual fibres and few vigorous real roots. There is little else than a mass of hard, old stubs that with difficulty push out growing white fibres. The endeavour to move such with a large ball is therefore often an expensive failure. We have saved a large ball of earth, but it contains little worth having. The two, three or four year old roots are usually cut off and left in the ground in order not to have too heavy a ball. Occasionally a large tree, so moved, will live and thrive fairly well, but then only because there has been a few young and vigorous roots among the older stubs. These large trees moved with a ball, but without vigorous roots, almost always put out leaves the first season, and so will some trunks of trees when chopped down and no roots at all to feed them. This comes mainly from feeding on the sap stored in the tree. They usually gradually die away completely within a few years. But if a large tree can be moved so as to carry with it a large number of comparatively young and vigorous roots, there usually follows the same success as follows the removal of younger trees.

BOMBAY GARDENS.

HAVING been a subscriber to your valuable Journal for several years, I do myself the pleasure of enclosing *The Times of India*, received by the last mail from Bombay, in which Presidency I have resided the best part of my life. On pages 16 and 17 is an interesting paper on "Bombay Gardens," read by Mr. G. H. Carstensen, the Superintendent of the Victoria Gardens, at a meeting of the members of the Bombay Natural History Society, thinking its perusal might be interesting not only to many who have retired from their active sphere of usefulness in the East to a well merited repose in their native land, but likewise to all interested in horticulture wherever they may be. Whilst, therefore, inviting your attention specially to Mr. Carstensen's very important suggestion, "that a most valuable service to gardening in Bombay in particular and to botany generally can be rendered by the exchange of the seeds of indigenous plants to and from all parts of the globe," I entertain the hope that you may be pleased to deem it desirable to reproduce the said article in your highly esteemed and widely read Journal.—J. A. GUÉRIN.

We are greatly obliged to our correspondent, and have much pleasure in giving the substance of Mr. Carstensen's lecture as follows:—

The object of the present paper is to give a general outline of gardens in Bombay, to point out the features by which they are principally remarkable, and the peculiar circumstances under which they have been formed and are kept up. All this is well trodden ground for most of the Bombay inhabitants, who, I hope, will forgive me in dealing

with the subject in a way more calculated to be of interest for those to whom Bombay gardens are not yet an object of daily enjoyment, than for those who are already familiar with their advantages and defects. Every European arriving in this country brings with him the memory of the perfection which the love of plants and vegetation has caused our gardens at home to attain, and with the natural and human constant desire for and belief in something better, he carries with him illusions of the beauty, glory, and wealth of the tropical vegetation in which he often believes to find a paradise on earth. He may be, and generally is, disappointed, or rarely the luxuriance of the vegetation may appear to him even greater than anticipated, so much depends on the season at which he arrives, or on the locality in which he settles down. In one respect, however, he is always sure to be disappointed—in the expectation of wealth of flowers. This question has been so excellently dealt with by the distinguished writer and traveller, A. R. Wallace, in that delightful book, "The Malay Archipelago," and other writings, that I shall not tire my audience by a mere repetition, though I may remark that this observation principally refers to the indigenous flora. Gardening, however, here comes to our recourse; and by the introduction of numerous exotic plants, chiefly inhabitants of tropical America and Madagascar, it has been made possible to ensure a constant supply of flowering plants in Bombay; and with care it is feasible to grow a great many plants, whose flowers are old friends from home. It is only human and natural that our impressions from childhood and youth should be so strong, that we will always retain a preference for those objects which in those happy periods of life have fixed themselves in our memory; and so it is with flowers. Even if we later on in life meet with the most gorgeous or splendid floral beauties, we cannot help admiring them; but still the memory of our homely flowers, which is often associated with thoughts of the clearest and happiest events of our life, will always overshadow the splendour of even the most dazzling flowers we come across. We will constantly miss the Violets, Anemones, Primroses, Cowslips, Bluebells, Lilies of the Valley, and other gems from meadow and wood, the Roses, Rhododendrons, Syringas, Laburnums, Hawthorn, fruits, trees, from the gardens; the Azaleas, Primulas, Ericas, Fuchsias, Pelargoniums, and numerous other plants from our greenhouses; and even if we succeed in producing some of these here, they are so inferior to what we used to see that we cannot help being disappointed.

It is natural, but doubtfully recommendable, for all Europeans arriving in a new, even distant country, to surround themselves, as far as possible, with the same moveable objects which in their home were their daily companions, to retain the same dress, the same fashions, the same distribution of working and leisure hours, and even to make no alteration in their diet. This may be a sign of the love for our homes, but may perhaps in many instances be attributed to a certain amount of pride, an unwillingness to submit ourselves to the influence of other customs, or even to the dictates of Nature; a feeling which, when strictly adhered to, is but too often punished by ill-health, uneasiness, discomfort, and often grave disappointments, which in many cases might have been avoided. As is the case with ourselves, so it is with the plants, which used to surround us at home, with this difference, though, that even when hailing from less distant countries, they are much more tender subjects, and have far greater struggles to contend with in a new country. Their dependence on temperature, rainfall, and other climatic agencies is so great, that the least change will, in many instances, seriously affect them; and we are, to a certain extent, ourselves to blame, when their cultivation causes us disappointments, which we by a bit of reasoning might have anticipated. It is, however, not my intention to argue against the cultivation of such plants, but only to warn against too sanguine expectations; while, on the other hand, I should advise everybody not to be discouraged by unsuccessful results, but to persevere in their efforts, guided by the peculiar local conditions more than by the requirements of the plants at home, by which means only it will be possible to eventually acclimatise such plants and obtain better results in future.

I have already dwelt too long on the disappointments of gardening in Bombay for Europeans; it is therefore only fair to notice the advantages. Then I have no hesitation, regardless of home associations, to pronounce Bombay as one of the most "highly favoured" localities for gardening. It is not only possible to have a magnificent display of flowers at almost all seasons of the year, but the luxuriance of an enormous variety of foliage plants, peculiar for the grandeur or gracefulness of their features, or for the brightness and variety of their colour, can hardly be surpassed in any other country in the world. The origin of the plants commonly met with in Bombay gardens speaks volumes of the keen interest and enterprise in the introduction of new plants, which has, for years after years, distinguished the inhabitants of this city, and to whom it is mainly due that we can now unflinchingly protest against the first statement of our old friend "Firminger," namely, this:—"Under the most favourable point of view it can hardly be said that horticulture has as yet made much advancement in India." It is a remarkable fact that comparatively few of our garden plants are of indigenous origin; but that by far the greatest and most effective proportion hail from tropical America, Madagascar, East Africa, the Malay Archipelago and South Sea Islands; a number from Ceylon, Northern India, Japan, and China; and a few from Australia, South Africa, and Southern Europe; but hardly any from extra tropical America, or even from the west side of South America. But as far as my experience goes, I do not think it improbable that by far the majority of plants, indigenous in tropical India, British Guiana, Brazil, Columbia, West Indies, tropical Africa, South Sea Islands, Java, Phillipines, Ceylon,

Malay Peninsula, Burmah, and Lower Himalayas, and perhaps tropical Australia, will have a good chance of success in Bombay. If this should hold good, it will be seen what a wide field there is still left for future introduction of plants, of which but comparatively few have hitherto been introduced to Europe. If, therefore, any member of our Society should happen to have friends resident in any of these countries, they would do a most valuable service to gardening in Bombay, and to botany generally, by requesting them to send them seeds of indigenous plants from such places, outlying districts in India not excepted. The peculiarities of the climate of Bombay must necessarily be known in order to enable us to form a judgment of the probable successful cultivation of plants from different countries. I shall therefore shortly summarise its main features.

It will then first be observed that the actual temperature is not so high as the geographical situation of Bombay might lead us to expect, the thermometer showing a range between a maximum of 93° and a minimum of 63°, while the average temperature of the year is 79·7°, figures that as nearly as possible coincide with the temperature generally maintained in our stoves or hothouses at home. The humidity of the atmosphere is at all times of the year very great, owing to the immediate neighbourhood of the sea, which, on the other hand, causes the air to contain a certain amount of salt or sodium chloride, which for certain plants is undoubtedly beneficial, but not improbably may be a disadvantage for other plants. Though the Bombay climate does not present such distinct variety throughout the year as that of our northern homes, which can easily be distinguished into four seasons, it is, however, usual to divide it into three seasons—the cold, the hot, and the wet season. The cold season generally lasts from November to March, and is characterised by fine bright weather with gentle N., N.N.W., N.W., W., or N.N.E., but in Bombay rarely E. breezes, a comparatively low night temperature (the difference between night and day temperature often exceeding 20°), which, as a contrast to the heat in the sun, which is often up to 50° higher than the temperature in the shade, will often prove very trying for plants. The heavy dew, which is caused by this great difference in night and day temperature, on the other hand acts as a natural protection against the sudden changes of temperature, by checking evaporation and at the same time supplying a certain amount of moisture to the soil. This season is generally considered the most satisfactory for our gardens. The lower temperature makes it possible to raise seedlings of annuals from colder climates, and to produce a tolerably good show of flowering plants. A great many tropical plants, trees, and shrubs produce their flowers during this season, while Roses, Geraniums, and other extra tropical plants produce better flowers at this season than at any other time of the year. Many plants will grow very rapidly, while others will be resting during this period. In March the weather commences to get hotter, the difference between night and day temperature decreases, the dew diminishes, the wind takes a more easterly direction, and the hot season sets in. The humidity of the atmosphere is rapidly decreasing, and strong winds assist the burning rays of the sun in preparing the rest for indigenous plants, which now in many cases shed their leaves, but often only a few days after are covered with brightly coloured flowers, or with new light green foliage. Though our gardens are least attractive during this season, they are yet not destitute of something beautiful to catch the eye, and even if many of our cherished plants assume a sickly or blighted appearance, this is not necessarily calculated to cause any fear, as in most cases the faded splendour is sooner an indication of rest than a sign of serious injury. In the course of May the wind loses its force, the air becomes sultry, the sky clouded, and the atmosphere intensely moist, until, generally preceded by a few heavy thunderstorms with heavy rain, the wind rises again, now blowing from the S.W. with slight vexillations to S. and W., and the monsoon or rainy season has set in, as a rule in the first or second week of June, and continues to the end of October. The average yearly rainfall of Bombay (Byculla) is 82·7 inches, or nearly 7 feet, which frequently fall very irregularly. Falls of 5-6 inches in a day are not at all unusual, and very often a heavy downpour lasts for several days in succession, while at other times the weather remains more or less cloudy, with occasional heavy showers, or a "break" of fine clear weather, which at times may last for a week or two, sets in. This season is the period in which the tropical character of the climate is most fully pronounced. The luxuriance and formidable growth of all foliage plants, the splendid colours of their leaves, and the profusion of choice and delightfully scented flowers of a great variety of plants, all combine to make an impression which, once experienced, will never be forgotten, and of which such common features as walls and wells covered with bright emerald green moss and graceful Maidenhair Ferns are but poor examples. At the end of October the monsoon generally terminates with heavy thunderstorms, the clouds gradually clear away, and the temperature for a short time increases, while the wind is gradually resuming a more western to northern direction, the humidity of the atmosphere is still very great, owing to the rapid evaporation from the ground, and the air is steamy until the cold northern winds again refresh us.

(To be continued.)

TOADS have been observed by some persons to feed willingly on bees and even wasps; and M. Hiron-Royer, who has noticed the fact, says that *Hyla versicolor* is positively frantic about wasps. He has seen one prefer them to every other kind of food, and devour them eagerly, although the sting does sometimes bring the creature to temporary grief.—(*Nature*.)



HARDY FRUIT GARDEN.

APPLE TREES.—A continuance of wintry weather will delay the work of pruning and nailing wall trees, but when not so very severe good progress might be made with Apple trees. Even this is cold work, the feet and hands suffering most. Both, however, can be obviated—the former by placing hay socks in the boots and wearing wooden clogs outside, and a strong pair of gloves will keep the hands fairly warm. Too free use of the knife is a mistake in many instances, but garden trees especially have to be kept within bounds.

Cordons must have all lateral growth shortened to the old spurs. Supposing summer stopping was practised as it ought to be, but not very closely, the first formed with second growth attached ought to be further shortened, being cleanly cut back to within about 2 inches of the old wood, leading shoots to be laid in to their full length.

Pyramids and bushes, if on a dwarfing stock, do not, as a rule, require much pruning, these often being too chary of forming young shoots. When shoots are principally produced at the points of main branches it is advisable to cut them rather hard back in order to promote growth where more needed, perhaps—viz., nearer the centre of the tree. Summer stopping will also conduce to the same end. Where more branches are required shorten the young growths freely, also cut back straggling growths; but where they can be left to their full length without disfigurement this should be done. Much the freest growth is made by trees on the Crab stock, and in this case even more judgment must be exercised in pruning, or the chances are not much fruit will be obtained. No attempt should be made to unduly confine the size of these trees, or nothing but wood growth will result. While they are being formed most of the leading branches must be cut to rather less than half their length; but when a good foundation has been laid the best placed shoots ought to be left to their full length and the rest well shortened. Unfruitful young trees and apparently worn out older ones can both be restored to good fruiting condition by simply leaving a number of young shoots at their full length. In one case this plan checks luxuriance, and in the other promotes vigour. To shorten these reserved shoots however slightly, as many are tempted to do, spoils the effect. Thus treated they would only break near the ends, the rest of the shoot being naked; but when left their full length, no matter how strong or how weak they may be, fruit buds would most probably form at every joint during the coming summer. Some young shoots on old trees will even bear fruit during the season following their formation.

PEARS.—Much that has been advanced concerning Apples also applies to Pears. The Quince or dwarfing stock has the same effect on the latter as the Paradise and Doucin stocks have on Apples. If miniature early productive trees are desired these only can be had with the aid of the Quince stock. Pruning rather freely in order to preserve or improve the form of any trees on the dwarfing stock will not greatly check productiveness, but the same tactics with those on the Pear stock will, as long as continued, unless lifting and root-pruning are resorted to, be followed by little but thickets of wood. If this close pruning is discontinued and the shoots merely thinned, those reserved being left to their full length, a complete change for the better will soon be apparent in the productiveness of the trees. Allowing the branches to extend in a natural manner is the simplest method of growing large profitable trees. The limbs for a few years may be somewhat slight, but if these are weighted down by fruit, as often happens, propping them up is a very simple and pleasurable occupation. Thinning superfluous inner growths must not be neglected, or otherwise the interior of the trees will not have sufficient light and air, and will be unproductive accordingly.

ORCHARD TREES.—It is a noteworthy fact that more orchard trees are being thinned this winter than usual, though probably this is due to a scarcity of other work and lack of firewood than from any other cause as far as farmers are concerned. The trees, whether the varieties are fit for cider making only or of some marketable value, ought not to have been so long neglected as to necessitate the removal of many faggots of wood from them, but late thinning better than none. Where much crowded a few of the innermost trees of the most worthless varieties might well be destroyed, letting more light into the rest. In any case all trees with crowded branches ought to be freely thinned, many of the underside branches also being cleanly sawn out. Straggling branches to be foreshortened or cut back to well placed inner branches, and a general freedom imparted to all. An improvement will most probably be observable in the quality of the crops next season, and it is a moderately heavy crop of large sound fruit that pays best, larger quantities of scrubby fruit being altogether unprofitable.

Other methods of improving orchard trees ought also to be adopted in many instances. Well liming the trunks and greater portion of the branches will usually clear them of moss and lichen, and when these are thus disposed of a healthier growth will soon be observable. Newly

slaked lime may be shaken over them when damp through coarse sacks or bags, or a moderate thick well strained limewash may be made and either syringed over them, or, better still, be distributed with the aid of a garden engine. A limewash is sometimes well brushed into the stems and principal branches, this, though the slowest, being also the most effective way of liming the trees, as it also destroys American blight and eggs and grubs of other injurious pests. Excessive damp is the most frequent cause of the spread of moss and lichen, and one or two rather deep drains taken through an orchard might correct much of this dampness in the atmosphere. The old drains are apt to become clogged by roots and other causes, and frequently would act better if the outlets were kept properly cleared.

IRRIGATING ORCHARDS.—Not a few orchards are comparative failures, owing to the poverty of the ground in which the trees are rooting. Freely dressing the surface of the ground with good farmyard manure acts beneficially, but often the moisture from this does not reach the greater portion of the roots, the latter in fact seldom having the benefit of any moisture from one end of the year to the other. Loosening the surface, or if this is not possible, forming numerous holes with a crow-bar at a good distance from the stem prior to emptying many loads of liquid manure among them, is a surer method of supplying the trees with both manure and moisture, and this is best done any time after the frost has broken up. Give enough to thoroughly moisten the ground round each tree to a good depth, dribbles being simply thrown away. The plan of laying a 3-inch common pipe drain to a depth of 18 inches midway between rows of trees, the lower end being blocked up, and the upper one given a turn so as to bring a pipe well out of the ground, is a good means of distributing liquid manure. Being freely poured down or pumped into the upper end the liquid manure will travel the full length of the drain, and percolate through to the ground on either side. Not a drop will be wasted, and a wonderful improvement in the vigour and value of the trees be quickly effected.

SAVING GRAFTS.—The advice to re-graft inferior varieties of fruit of all kinds with others worth growing has too often been given in these pages to need reiteration, and it is only alluded to here in order to remind readers that an important preliminary must not be lost sight of. It is useless to cut back trees for the purpose of being regrafted if there are no suitable scions available, and those, therefore, who are about to prune their garden trees ought to save bundles of the prunings of best varieties, more especially of Apples, Pears, and Plums. These being duly labelled should be bedded in behind a north wall or other cool moist position, the aim being to preserve them in a fresh yet dormant state as long as possible. If the sap of the scion or grafts is active before that of the trees or stocks to be operated upon, failure to “take” or unite will be the inevitable consequence.

FRUIT FORCING.

FIGS.—Early Forced Trees in Pots.—The growths being somewhat advanced the temperature should be increased to 60° at night and 65° by day by artificial means, and 70° to 75° with sun heat, commencing ventilation at 70°, and if the temperature rise 5° to 10° it will be an advantage, provided it is due to sun heat. Avoid a high temperature by artificial means, as the sturdier and shorter jointed the young shoots can be kept the greater will be the chances of a satisfactory early crop. Syringe the trees and house twice a day—in the morning, and again at closing; but if the days are dull damping will be sufficient, for a confined saturated atmosphere encourages soft growths, and those are fatal to fruit production. As the fermenting materials settle firm them well about the pots, add more fresh but sweetened leaves, bringing them nearer to the rims of the pots, taking care that the heat does not exceed 70° to 75°. Water the trees as required with weak tepid liquid manure, giving a thorough supply, so as to moisten the soil through to the drainage. Place some turves about 2 inches thick, grass side downwards, extending over the inside of the rims of the pots, filling the space to the stems with short manure, keeping the turves watered with liquid manure, so as to render them moist and encourage the roots to extend into the fermenting material.

Fig Trees Planted Out to Ripen Fruit in May or Early June.—To have fruit at the beginning of May trees in pots are most suitable, but for a supply of the finest fruit of the large varieties trees that have the growths trained near the glass are most satisfactory as regards the size and quality of their produce. The planted-out trees started at the new year will afford fruit at the end of May, or if not then started there must not be further delay. Thoroughly water the border, repeating it so as to moisten it through, after which the surface may be mulched with short manure about 2 inches thick, placing it rather thicker near the stems, to encourage the roots to extend from the collar, keeping the mulching well moistened. Syringe the trees and house occasionally, but avoid keeping the trees constantly wet, and the house close and saturated with moisture. Maintain a night temperature of 50°, and 55° from fire heat by day, advancing to 60° to 65° with sun heat, ventilating freely from that temperature.

VINES.—Early forced Vines in Pots.—Directly the fruit is set attend to thinning, beginning as soon as the berries are fairly swelling, watering copiously with liquid manure weak and tepid; keeping the evaporation troughs charged with liquid manure diluted with water, using some for damping in the afternoon, preferably after the customary syringing or sprinkling. Encourage growth above the fruit, yet only as much as can have exposure to light. Surface dress the soil with short

manure, and when roots are emitted freely from the collar some turves may be placed around the rims of the pots, extending about a couple of inches inside and over them, so as to lie on the fermenting material. The roots will take to the turves, and through them to the bed of leaves. Let the temperature range from 65° to 70° at night, 70° to 75° by day, and 80° to 85° by sun heat, admitting air from 75°, and closing early so as to raise (and maintain) the temperature at 85° or 90° with sun heat, damping available surfaces at closing time or early in the afternoon. Avoid syringing the foliage, as there is always danger of the water leaving a deposit on the berries, which spoils the appearance of otherwise well grown and finished fruit. There must not, however, be any deficiency of atmospheric moisture, for in a dry atmosphere the fruit does not swell freely, and there is a deficiency of juice as well as size of berry.

Early Houses.—The greatest care must now be exercised in ventilating, not admitting cold air, draughts being prolific of rust, crippling the foliage, which, unable on that account to perform its functions, does not allow food assimilation and its concentration in the fruit. Disbud and tie the shoots down before they touch the glass. In stopping allow two or more joints of growth beyond the show of fruit, or, where there is room, do not confine the stopping to any given number of joints beyond the bunch, but extend the growth so that an even and ample supply of foliage will be insured. Crowding, however, is a great evil, therefore allow no more foliage than can be fully exposed to light and air. Remove all superfluous bunches early, overcropping even of incipient bunches being inimical to a good set and prompt swelling of the berries. When the flowers are open maintain a temperature, night and day, of 70° to 75°, and a rather drier atmosphere, not going to the extreme of depriving the air of the needful moisture essential to the health of the foliage.

Houses Started at the New Year.—The inside border must be thoroughly moistened by repeated waterings or liquid manure at a temperature of 90°. This will induce a speedy and good break, accelerated by a fermenting bed of leaves and litter sweetened before being introduced into the house, the regularity of the moisture, the warmth and ammonia vapour being highly favouring vegetation. Outside borders must be well protected. If no fermenting materials are available afford a good supply of dry litter or fern so as to modify in some measure the chilling tendency of cold rains or snow. Sprinkle the Vines two or three times a day, maintaining a temperature of 50° to 55° at night, 60° to 65° by day, ventilating freely above 65°. The rods and canes of young Vines should be slung in a horizontal position to secure a regular break; those that have not previously been subjected to early forcing will start less freely than those long subjected thereto, therefore a little extra warmth will be necessary to induce activity.

Houses of Thick-skinned Grapes.—It is absolutely essential that Grapes hanging late be kept cool and uniform in temperature. This they can hardly have assured to them on the Vines after the sun gains power, besides their hanging is not good for the Vines, which to do well require starting in good time to insure a satisfactory finish of their crops. The Grapes may now be removed to a dry room, where they will keep quite as well as on the Vines. Cut the bunches with as much wood attached as can be spared, and place the stems in bottles filled with soft water, each containing a few pieces of charcoal. The bottles should be fixed in an inclined position so as to admit of the bunches hanging clear of the sides, and they may be as far apart as not to allow the bunches to touch each other. Keep the temperature of the room at about 45°, examining the bunches occasionally for decayed berries, which should be carefully removed. The Vines should then be pruned, dressing the cuts with styptic or patent knotting, thoroughly cleaning the house. Dress the Vines, avoiding the usual peeling, scraping, and scrubbing of the rods, merely removing the loose bark, being as careful of cutting the stems into the quick as of running the knife into the hands, and wash every part thoroughly with softsoapy water, 4 ozs. softsoap to a gallon of water, using it warm, then if necessary apply an insecticide, than which as an anti-insect and fungoid there is no better than bisulphide of calcium, which is made by boiling 1 lb. quicklime with an equal quantity of sulphur in a gallon of water for a quarter of an hour. Let it cool, then pour off the liquor, bottle it, and keep it well corked. When used mix half a pint with 3 gallons of water for syringing purposes; as a winter dressing for applying with a brush, dilute with six times the quantity of water. Air should be admitted freely in favourable weather, seeking to give the Vines as long and complete a rest as possible. Where the borders are not satisfactory lift the roots and relay them in fresh compost, and where the Vines have inside and outside borders the renovation may be accomplished without loss of crop by renewing the former one year, and the latter the next.



APIARIAN NOTES.

THE WEATHER.

ALTHOUGH the frost has not been severe we have had a long continuance of it, and through the absence of snow the verdure

of the fields in December is now changed, assuming a normal winter's grey appearance, the lowest temperature for the year being 17° Fahr., 2° less the lowest in December. Bees are quiet, neither dead nor living are to be seen, nor is there damp on the alighting board or about any of the hives, every one of them as yet showing a "clean bill."

DYSENTERY.

The old bees still alive, and all are free from dysentery. This is the result of proper management, as so often detailed in these pages, and having none now in double cased hives we do not expect to experience it. It appears that all apiaries have not the same immunity from this disease, if it may be so termed. Numerous letters from correspondents have been received within the past few days on the subject, and asking advice. If the causes of abdominal extension had been removed in the fall, and the hives otherwise provided for, and arranged as they ought, dysentery would not have developed itself so much as to cause anxiety.

It is a well-known fact, which cannot be disguised, that many of the good principles in bee-keeping have been ignored by modern teachers, and it does not surprise us when a more severe winter comes than we have been accustomed to of late to hear of bees suffering from such a malady as bad as or worse than the brimstone pit.

In numbers of the cases the bees are located in double cased hives without the proper means of ventilation, and having been fed the hives are thoroughly saturated with damp, and it is impossible for me with such weather to mention a cure, as any attempt during this frosty weather might do more harm than good.

I have frequently in past years saved bees by taking the hives indoors to an apartment with but one window, highly heated, and entirely free from dust and damp on the glass. Shortly after the hive was set in the apartment, the bees becoming comfortable and strengthened by the heat, flew, returning in a short time to their hive. While this was going on I was preparing a clean hive furnished with combs, some of which I had always on hand, all the preparation being to have them well heated, which I did over a stove—in fact I stored them there—then transferred the bees into it, taking care there was plenty of meat, then at dusk placed it on its original stand. It will be observed that only a few hives can be successfully dealt with by this method. Where there are a large number affected they would be difficult to deal with until genial weather sets in, when bees and combs ought to be transferred into a warm dry hive, after rejecting all the damp and foul combs. A very little warm syrup will give the bees spirit, and enable them to air themselves and be in condition for carrying on the internal economy of the hive. In most cases dysentery is the result of bad management somewhere, and as in many other things prevention is better than cure. There is a wide contrast of the weather for two months past to what it was a year ago, and if we get seasonable weather after this dysentery and other ills will disappear from the apiary, when bees and bee-masters will rejoice alike.

MOVING HIVES.

Our answer to "S. E." about a hive that is to be sent on a journey in summer is that it must be thoroughly ventilated. A common straw hive only requires a cheese cloth placed under the corners, tied at the top, and a cord wound round the body; the hive to be then inverted and carried by hand; or if sent it may be placed in a box having a piece of perforated zinc on the lid. If an ordinary frame hive is obtained a ventilating floor should be substituted for the common one and made secure. Whenever a hive reaches its destination give the bees their liberty; never close them in unless thoroughly ventilated, nor at any time unless for some particular purpose, which should be well understood.—A LANARKSHIRE BEE-KEEPER.

TRADE CATALOGUES RECEIVED.

- William Rumsay, Waltham Cross, N.—*Catalogue of Seeds.*
 William Barron & Son, Elvaston Nurseries, Borrowash, Derby.—*Catalogue of Conifera, Forest Trees, &c.*
 Charles Turner, Royal Nurseries, Slough.—*Catalogue of Kitchen, Flower Garden, and Farm Seeds.*
 Peter Henderson & Co., 35 and 37, Cortland Street, New York.—*Manual of Everything for the Garden.*
 Dicksons & Co., 1, Waterloo Place, Edinburgh.—*Catalogue of Garden Seeds.*
 William Baylor Hartland, 24, Patrick Street, Cork.—*Year Book of Seeds.*
 E. H. Krelage & Son, Haarlem.—*Catalogue of Bulbs, Plants, and Seeds.*
 Dobie & Mason, 66, Deansgate, Manchester.—*List of Reliable Seeds.*
 Wm. Cutbush & Son, Highgate.—*Catalogue of Flower and Vegetable Seeds.*
 B. Soddy, 243, Walworth Road, S.E.—*Spring Catalogue.*
 G. Elliott, Huddersfield.—*Catalogue of Seeds.*
 W. Piercey, Beadnell Road, Forest Hill, London.—*Descriptive List of Early Flowering Chrysanthemums.*



All correspondence should be directed either to "THE EDITOR" or to "THE PUBLISHER." Letters addressed to Dr. Hogg or members of the staff often remain unopened unavoidably. We request that no one will write privately to any of our correspondents, as doing so subjects them to unjustifiable trouble and expense.

Correspondents should not mix up on the same sheet questions relating to Gardening and those on Bee subjects, and should never send more than two or three questions at once. All articles intended for insertion should be written on one side of the paper only. We cannot reply to questions through the post, and we do not undertake to return rejected communications.

Report of Dinner (W. II.).—Had the report of the dinner on New Year's Eve arrived in time for insertion last week it would have been inserted, but it was not posted soon enough for that purpose. We cannot publish "news" of that character more than a fortnight after dates.

Shading Plant Houses (A Reader).—It is impossible for anyone to say "which of the various materials is the most suitable for shading plants." Some plants require all the sun they can receive, others a mere shadow cast over them, while several more—notably Palms, Ferns, and many ornamental-foliaged plants—enjoy a denser shade. It is necessary to know the kinds of plants to be shaded for indicating suitable material and methods. If you write again please send your name and address, not for publication.

Winter Dressing for Vines Infested with Red Spider (A. B.).—The Vines having been pruned and all loose bark removed, wash them thoroughly with a solution of softsoap, 4 ozs. to a gallon of water. Apply with a brush, reaching well into every crevice and angle, being careful not to damage the buds, but wash the rods or canes well about the "eyes." The washing does much good, especially if used tolerably hot, but not over 120°. After this the Vines may be dressed with Gishurst or other approved insecticides, which, to be safe and effectual, must be used according to the printed instructions accompanying them.

Scraping Vine Rods (Subscriber).—We have seen Vines seriously injured by excessive peeling and scraping, but whether there is "anything to be feared" in your case or not we have obviously no means of knowing. Safe methods of cleansing Vines have been published repeatedly, and most persons when in doubt seek advice before doing anything of a risky nature. We hope you have not done too much at your Vines, and refer you to a method of cleansing in reply to "A. B." For extirpating mealy bug lemon oil is found by many gardeners to be a good preparation. But every part of a house and everything in it should be cleansed, as well as the Vines where those insects abound, or the work of eradication will only be half done.

Frozen Mushroom Beds (W. B., Sussex).—If you have Wright's "Mushrooms for the Million," you will find on pages 52 and 111 that cold does not destroy the mycelium in Mushroom beds, but only arrests its growth, and delays the production of Mushrooms. Mushroom beds have produced excellent crops in spring after being frozen in

winter, but it is desirable to prevent their freezing when this can be done. Many outdoor beds are now covered 2 feet deep with litter, and affording fine Mushrooms. Protect the beds as well as you can, and as they have produced some Mushrooms they will perhaps yield plentifully in spring. If you do not possess the work named it can be had from this office post free for 1s. 2d.

Tomatoes in Winter (Idem).—As a rule a house in which different kinds of plants have to be kept healthy is not favourable to the setting of Tomatoes in winter, even if it is kept as dry as is practicable. Moreover, the weather has been of the most unfavourable character of late for the bursting of pollen cells and subsequent fertilisation. We suspect the failure is mainly due to a scarcity of pollen. You do not mention the temperature of the house, which should range from 55° to 65° by fire heat, and as high as possible with sun, but there has been scarcely any sun for a month or more to the great disadvantage of gardeners who are engaged in forcing operations. Tomatoes may be admirably grown against the back wall of the vinery, the upper half of the roof of which is unoccupied. Seed may be sown at once for your purpose thinly, growing the plants sturdily, and having them very strong for planting or shifting into large pots for fruiting when the temperature of the vinery is suitable for them. You will find Mr. Iggulden's work on "Tomato Culture" useful for reference, and it can be obtained from this office post free for 1s. 1½d.

Lime and Sulphur as a Dressing for Vines (G. H.).—The following, which is good as an insecticide and fungicide of many years' proved efficacy, is probably what you require. Take 7 lbs. of flowers of sulphur, and 7 lbs. of quicklime, boil together for fifteen minutes in 3 gallons of water, then add 2 lbs. of softsoap and 1 lb. of strongest shag tobacco, boiling all together for half an hour, adding 9 gallons of water, keeping it well stirred. Allow it to cool, then strain, and when settled take off the clear liquid, place in earthenware bottles, keeping them closely corked. In its pure state it may be used for dressing Vines and other fruit trees when at rest, applying it with a brush, taking care not to injure or dislocate the buds. For syringing Peach and other fruit trees during growth 1 pint to 3 gallons of water is a suitable quantity, and efficacious against insects and mildew. It must not be applied over Vines in growth, as it is apt to leave a deposit upon the berries similar to stain marks occasioned by using hard or lime water. If used over Cucumbers or Melons, as well as plants with hairy leaves, half a pint is a full quantity to add to 3 gallons of water.

Grafting Roses under Glass (S. S.).—Roses can be as successfully grafted with leaves on the scion as when the wood is leafless and dormant. More Roses are probably grafted in the former condition than in the latter, but dormant wood is much more largely employed than was the case at one time. Time is saved by so doing, which is an advantage when large numbers are required. The greatest success is attained when young half-ripened wood can be used as scions, as it unites quickly, and the small plants are soon ready for placing into larger pots. The young growths die after they have started in the propagating more frequently when dormant wood is used for scions than when comparatively young wood is employed. It is due to imperfect union of the stock and scion. The young growth has been forced out of the scion, and when the stored-up supply of food is exhausted it withers and dies. If the union was perfect supplies would be drawn up from the stock and all would go well. The secret in working Roses in large numbers is to have the stock and scion in the same stage of growth when grafting is performed. When young wood is employed the stocks should be started before they are grafted, so that the sap will flow freely. When this is done few deaths occur under good management.

Stocks for Roses and Fruit Trees (R. B.).—The Manetti stock is an Italian Briar of very free growth, hardy in this country, and increased by cuttings inserted in the open ground in the autumn. English Briar stocks for dwarf Roses are raised in the same way, also from seed. Before the cuttings are inserted the buds are carefully removed except two or three at the top of each cutting, these alone being above ground. The cuttings are inserted slantingly in ridges, and when the stocks are large enough for budding the soil is levelled down and the buds inserted close to the ground, one in each stem, below the branching growths. Quince stocks are raised from cuttings on the same lines as described for Briars, also by layers. Pear and Crab stocks are obtained from pips or seeds of those fruits sown in the open ground. Many stocks for Apples, and known as "free" stocks, are raised from Apple pips obtained in the process of cider making. Paradise stocks are raised both by layers and cuttings of dwarf precocious kinds of Apples, which are grown for that purpose. They are not employed for Pears, but only for providing Apple trees of compact growth and early productiveness.

Grapes, Peaches, and Figs Failing (One in a Fix).—These fail from other causes than "want of lime and potash." Both, however, are excellent dressings for soils derived from "reddish sandstone." You say "The Grapes shrivel up like raisins as soon as ripe; very sweet, but not fit to look at." Lime and potash, good as they are, will not prevent that defect. Good cultivation, mulching, liquid manure, or a due supply of nitrogenous manures, are absolutely essential to secure well developed and properly finished fruit. Lime half an inch pointed into the borders as deeply as the roots allow will act beneficially—liberating food and aiding nitrification—but it ought to be well mixed with the

soil. Do not trouble to wash it in, as in outside borders the rains will do that fast enough, whilst inside borders will not need more water than that culturally given. A good soaking of tepid liquid manure when the Vines are started would be more beneficial, repeating it so as to moisten the soil thoroughly down to the drainage. Watering the lime in would be likely to make the soil sodden and prejudice the early formation of roots. Lime is, nevertheless, important as a soil constituent, but for speedy action we should advise steamed bonemeal or superphosphate of lime, the former preferably. This would give the needful lime and the indispensable phosphoric acid. A quarter of a pound is a proper quantity to apply per square yard. This can be given in addition to the dressing of lime, in which case use superphosphate, which will afford sulphur as well as phosphoric acid, and combining with the lime will form sulphate of that substance, which assists in the formation of chlorophyll, and improves the fruit. The superphosphate may be given at the same rate as the steamed bonemeal. Potash is an essential food of Vines; the nitrate, perhaps, its most active form, but in some cases better results are had from commoner forms, which, though containing less potash, include other ingredients. Kainit, for instance, contains soda and magnesia, which are of particular benefit on light soils. In using nitrate of potash the greatest benefit accrues when other substances are present, and where there is reason to know potash is most needed. Half an ounce per square yard is ample. There is no need to wash it in, but it may be so treated in the case of inside borders, remembering that the more it is washed in the more is likely to run away. Disposed on the surface and left to rains or cultural watering it will be gradually taken down and become absorbed, after which there is little danger of washing it out of the soil. The Peach borders may be treated similarly to the Vine borders. Lime is essential for stone fruits, and in addition to the lime we should give a dressing of steamed bonemeal, and follow with a sprinkling of muriate of potash, at the rate of 1½ to 2 ozs. per square yard. These will not save the Peaches from non-setting, for it is due to imperfect development of the buds and lack of stored food, but it will assist those setting to swell and finish satisfactorily, forming better wood for future crops. The best cure, however, for non-setting and stoning unsatisfactorily is lifting and providing firmer soil with more phosphatic and less nitrogenous manure. The Figs will be assisted materially by curtailing their rooting area, which in width does not seem excessive, whatever it may be in length. Taking out the border as you propose and filling it with fermenting materials is an old plan and answers well where the wood of the Fig trees is well ripened, on which casting the fruit in a great measure depends, but many crops are lost through negligent and insufficient watering. Care must be taken not to heat the border too highly; a temperature of 60° to 65° will suffice for the roots in the early stages of growth. Too much heat forces growth unduly, then the fruit does not so much as attain the size of Walnuts. Plenty of light, air, and good feeding are the essential of Fig culture, and the firmer the soil, the more calcareous and gritty it is the better, provided feeding is well attended to.

Names of Fruits.—The names and addresses of senders of fruit to be named must in all cases be enclosed with the specimens, whether letters referring to the fruit are sent by post or not. The names are not necessarily required for publication, initials sufficing for that. Only six specimens can be named at once, and any beyond that number cannot be preserved. (*J. L. C.*)—1, Striped Beefing; 2, Court Pendû Plat; 3, Old Nonpareil; 4, Northern Greening; 5, Hanwell Souring. The Pear is Doyenné du Comice. (*Amateur*).—1, Ord's Apple; 2, Shepherd's Fame; 3, Dredge's Fame.

Names of Plants.—We only undertake to name species of plants, not varieties that have originated from seed and termed florists' flowers. Flowering specimens are necessary of flowering plants, and Fern fronds should bear spores. Specimens should arrive in a fresh state in firm boxes. Slightly damp moss, soft green grass or leaves form the best packing, dry wool the worst. Not more than six specimens can be named at once, and the numbers should be visible without untying the ligatures, it being often difficult to separate them when the paper is damp. (*J. R.*)—1, *Lælia anceps*; 2, *Odontoglossom Cervantesi*; 3, *Sophronitis grandiflora* (a good variety); 4, *Masdevallia polysticta*; 5, *Maxillaria nigrescens*. (*W. M.*)—1, *Selaginella Martensi*; 2, *Selaginella involvens*; 3, *Selaginella Kraussiana variegata*.

COVENT GARDEN MARKET.—JANUARY 14TH.

THE long-continued frost is seriously checking business in this market, and with foreign goods arriving in poor condition prices of sound goods are high.

VEGETABLES.

	s. d.	s. d.		s. d.	s. d.
Artichokes, dozen	0 0	to 0 0	Mushrooms, punnet ..	1 6	to 2 0
Beans, Kidney, per lb. ..	0 6	0 0	Mustard & Cress, punnet	0 2	0 0
Beet, Red, dozen	1 0	0 0	Onions, bushel	3 0	4 0
Brussels Sprouts, ½ sieve	2 6	3 0	Parsley, dozen bunches	2 0	3 0
Cabbage, dozen	1 6	0 0	Parsnips, dozen	1 0	0 0
Carrots, bunch	0 4	0 0	Potatoes, per cwt. ..	3 0	4 0
Cauliflowers, dozen ..	2 0	4 0	Rhubarb, bundle	0 3	0 0
Celery, bundle	1 0	1 3	Salsafy, bundle	1 0	1 6
Cleworths, doz. bunches	2 0	4 0	Scorzoner, bundle ..	1 6	0 0
Cucumbers, doz.	2 0	3 6	Seakale, per bkt. ..	2 0	2 6
Endive, dozen	1 0	0 0	Shallots, per lb. ..	9 3	0 0
Herbs, bunch	0 2	0 0	Spinach, bushel	5 0	6 0
Leeks, bunch	0 2	0 0	Tomatoes, per lb. ..	0 4	0 8
Lettuce, dozen	0 9	1 3	Turnips, bunch	0 0	0 4

FRUIT.

	s. d.	s. d.		s. d.	s. d.
Apples, ½ sieve	1 6	to 6 0	Lemons, case	15 0	to 21 0
" Nova Scotia and			Melons, each	1 0	2 0
" Canada, per barrel	15 0	26 0	Oranges, per 100 ..	4 0	9 0
Grapes, per lb.	0 9	3 0	St. Michael Pines, each	2 0	6 0
Kentish Cobs	55 0	60 0	Strawberries, per lb.	0 0	0 0

AVERAGE WHOLESALE PRICES.

CUT FLOWERS.

	s. d.	s. d.		s. d.	s. d.
Arum Lilies, 12 blooms ..	4 0	to 12 0	Mimosa (Fnech.) per bnch	0 0	to 2 0
Bouvardias, bunch	0 6	1 6	Narciss (Paper-white),		
Carnations, 12 blooms ..	1 0	2 6	French, doz. bunches ..	4 0	10 0
Chrysanthemum, 12 blms.	1 0	3 0	Do. Do. English,		
" 12 bunches	3 0	9 0	per bunch	1 0	1 6
Epiphyllum, doz. blooms	0 4	0 6	Pelargoniums, 12 trusses	1 0	1 6
Eucharis, dozen	3 0	6 0	" scarlet, 12 bnchs	4 0	6 0
Gardenias, 12 blooms ..	6 0	9 0	Poinsettia, dozen blooms	4 0	9 0
Hyacinths (Roman), doz.			Primula (double) 12 sprays	0 6	1 0
sprays	0 6	1 6	Roses (indoor), dozen ..	0 6	1 6
Lapageria, 12 blooms ..	2 0	4 0	" Red, 12 blooms ..	1 0	2 0
Lilac (French) per bunch	5 0	8 0	" Tea, white, dozen ..	1 0	3 0
" longiflorum, 12 blms.	4 0	6 0	" Yellow	3 0	5 0
Lily of the Valley, dozen			Tuberose, 12 blooms ..	0 4	0 9
sprays	3 0	6 0	Tulips, per dozen	1 0	2 0
Maidenhair Fern, dozen			Violets (Parme), per bch.	0 0	8 0
bunches	4 0	9 0	" (dark), per bch. ..	2 0	3 6
Marguerites, 12 bunches	2 0	6 0	" (English), doz. bnch	1 0	2 0
Mignonette, 12 bunches ..	3 0	6 0	Wallflower, doz. bunches	3 0	6 0

PLANTS IN POTS.

	s. d.	s. d.		s. d.	s. d.
Aralia Sieboldi, dozen ..	6 0	to 12 0	Hydrangea, doz. pots ..	9 0	to 18 0
Arbor Vitæ (golden) doz.	6 0	8 0	Lilium lancifolium, doz.	0 0	0 0
Chrysanthemum, per doz.	6 0	24 0	" longiflorum, doz.	0 0	0 0
Climbing Plants, various,			Lily of the Valley, per pot	4 0	6 0
dozen pots	4 0	9 0	Lobelia, per doz.	0 0	0 0
Dracæna terminalis, doz.	24 0	42 0	Marguerite Daisy, dozen	6 0	12 0
" viridis, dozen ..	12 0	24 0	Mignonette, per dozen ..	4 0	6 0
Epiphyllum, per dozen ..	12 0	30 0	Musk, per dozen	0 0	0 0
Erica, various, dozen ..	12 0	18 0	Myrtles, dozen	6 0	12 0
Euonymus, var., dozen ..	6 0	18 0	Nasturtiums, dozen pots	0 0	0 0
Evergreens, in var., dozen	6 0	24 0	Palms, in var., each ..	2 6	21 0
Ferns, in variety, dozen ..	4 0	18 0	Pelargoniums, per doz. ..	0 0	0 0
Ficus elastica, each ..	1 6	7 0	Poinsettia, per doz. ..	9 0	15 0
Foliage plants, var., each	2 0	10 0	Rhodanthe, per dozen ..	0 0	0 0
Fuchsia, per doz.	0 0	0 0	Stocks, per doz.	0 0	0 0
Geraniums Scarlet, p. doz.	2 0	6 0	Tropæolums, various, per		
Hyacinths (Roman), doz.			dozen	0 0	0 0
pots	8 0	10 0	Tulips, dozen pots	8 0	12 0



FRUIT FARMING.

SINCE writing the last farm article we have received our copy of the fourth quarterly number of the Journal of the Royal Agricultural Society for 1890, and find in the report of the farm prize competition in connection with the Plymouth meeting an account of Mr. J. W. Lawry's fruit farming near Saltmarsh, on the banks of the River Tamar, of such interest to prospective fruit farmers that we purpose devoting this paper specially to it, and show something of results for their guidance and encouragement.

The farm, we are told, comprises 60 acres of arable land, 9½ of pasture, and 30 of orchards and fruit gardens. The greater part is held under a yearly tenancy from the Earl of Mount Edgcumbe. Mr. Lawry was born and brought up on the farm, and succeeded his father as tenant twenty-four years ago. Since then he has converted a portion of the land into orchard and fruit gardens, and has built up a profitable trade in fruit. It came about in this way. When he was in London to see the Exhibition of 1862 he went to Covent Garden Market, and had his attention specially attracted by the prices asked for Strawberries. "Knowing," says the report, "that his father had in his little garden in Cornwall some fruit which was quite equal to that for which such high prices were asked, the idea struck him to have some forwarded to him to try to sell. He wrote his father accordingly, and all was sent him that could be found, but owing to ignorance in the art of packing the fruit on arrival was quite unsaleable. But Mr. Lawry was not disheartened, so instead of grieving at his failure and abandoning the project he set to work to overcome the difficulties, and with such success that shortly afterwards his fruit became the

earliest, and obtained the highest prices in the London, Manchester, Liverpool, Edinburgh, Cardiff, and other markets." In this he has undoubtedly been favoured by climate, as the district supplies the earliest out-of-door fruit in the kingdom; but the lesson of energy and perseverance is none the less valuable. This success soon led to general Strawberry culture in the district, so that now acres of Strawberries are grown where only small beds were once seen.

The success with Strawberries led to the planting of bush fruits and orchards, but we gather that Strawberries still hold the leading position. To show something of the magnitude of the fruit business on this small farm, we may mention the gathering and sending off of 3000 punnets of Strawberries in a day. Competition has brought down prices, and the time has gone by when Mr. Lawry was able to realise £1000 for the fruit of a single season. But the gross receipts on the whole farm on an average of seasons still amount to £15 per acre, and be it remembered that the fruit land is less than a third of the entire area of the farm. The labour bill for this farm of 99½ acres averages from £400 to £500 per annum, the difference being according to the abundance or not of the fruit crops, a good Cherry year entailing quite £20 a week extra during the picking season. The ordinary rate of wages is 15s. a week for nine months of the year, but in "picking" time it is raised to from 20s. to 26s. per week, with no limit as to hours. Cherries are found to be an uncertain crop, 18 tons being sold in 1887, and only 15 cwt. in 1889. In Strawberry and bush fruit time forty or fifty more extra hands, chiefly women and children, are engaged. School children also during the six weeks holiday earn from 6s. to 10s. apiece per week.

Strawberries, Raspberries, and Gooseberries, with other bush fruit, were all good last year. Plums were fairly good; Cherries and Apples almost failures, except one variety of Apple, which is being cultivated extensively as a reliable bearer, but of which the name is not mentioned. This result accords with Mr. Wright's caution in "Profitable Fruit Growing," to grow only reliable sorts of fruit.

Difficulties of all sorts occurred only to be overcome. The fruit when packed has hitherto been sent by road to Saltash station, a distance of nine miles, or by water to Plymouth, and special arrangements had to be made with the various railway companies to ensure the early delivery of the fruit at the great northern markets, and by such early delivery to command the top market price. The procuring of "punnets" was so difficult that Mr. Lawry often had to run up to London by night in the middle of the season to procure them. This led to the home manufacture of the punnets, and has given rise to quite an important local industry in the little village of Boetheric, near which the farm lies, women and children employing their spare time in the winter months in the work, and making quite a comfortable addition to the family earnings.

Instances of the healthy influence upon the surrounding district of Mr. Lawry's success, as it has raised up a host of imitators, and as the action of landlords in the extension of fruit farming has often been in question, we quote in full an instance of such action and its results in Cornwall. "Four or five years ago about 30 acres of coppice wood called Brent Wood was cleared and converted into Strawberry and fruit gardens. It was let off in plots of the proverbial 3 acres extent, and from being worth 8s. to 10s. an acre as coppice, is now let at £5 to £6 an acre on ten years' leases. The landlord sold the coppice; but the tenants, who in some cases were labourers, cleared the land, then limed it at the rate of 50 bushels per acre, took a crop of Potatoes, and afterwards planted Strawberries. The landlord has provided some fruit trees, and has the right to purchase any found by the tenants, who have to maintain trees and plants when once attached to the soil. Twenty-five two-horse cartloads of dung have to be applied to each plot yearly, for which there is a wharf on the riverside about three-

quarters of a mile away. The labour of clearing, which has been done mainly by the tenants themselves, and entirely at their expense, is estimated at £20 per acre, and the annual weeding is put at £5 per acre. In the first year of produce as much as £300 has been received for sales from some of the plots; but out of this must be deducted £50 to £70 for cultivation, picking, and something for railway and land carriage. Sometimes 100 and occasionally 200 persons may be seen gathering fruit on this reclaimed land. The first crops, however, have been in excess of all succeeding ones," which last fact, we take it, shows a probability of crowded growth among the Strawberries, and a lack of plant food in the soil. To prevent premature exhaustion in young Strawberry beds there is in our experience nothing like heavy soakings of sewage immediately after the fruit is cleared off in autumn, and again in spring from the commencement of growth onwards till the fruit begins colouring.

WORK ON THE HOME FARM.

Hedges and ditches ought certainly to be set in thorough order this winter during the enforced cessation of so much other work by the long frost. We do not advise the planting of young Whithethorn in the gaps of old hedges, as they seldom if ever answer, and prefer to plash the entire hedge, using sufficient stakes and binders to make all firm. Where new hedges are required the land may be got ready now, and the planting done immediately after the weather becomes open again. We do not hold with a slavish following of the old ditch and ditch mound for all hedgerows. By all means make ditches wherever they are required for drainage, but we otherwise altogether prefer planting on the flat in well trenched ground, using sturdy robust plants, and planting them in a single line from 6 to 10 inches apart, according to the size of the plants.

For general purposes Whitethorn makes an excellent hedge when really well managed, but neither it nor any other hedge will continue in good order long without regular attention. To have a dense lateral growth in a hedge we must clip it twice a year. A single annual clipping answers fairly well, but the result will not bear comparison with that from twice clipping, that is, after spring growth, and again in autumn. Plant well this season, leave the plants unclipped till the second winter after planting, then cut them down to within 6 inches of the ground. In the following spring they will send up plenty of vigorous growth, and the clipping must then begin. We have planted the Myrobalan Plum extensively for plantation hedges, and find it makes a thoroughly strong compact hedge of any height, from 5 to 10 feet or upwards if required. It must be clipped quite as regularly and carefully as Whitethorn, for its growth is so rampant that it soon gets out of bounds if left to itself for a season or two. It bears clipping perfectly well, and we have seen plenty of its pretty yellow fruit upon a closely clipped hedge. Owing to its singularly vigorous growth it forms a good hedge quickly, for which reason preference is given it for outer boundaries, yet we fail to see where it can be considered out of place if only due attention is given it after the planting. Gorse hedges are very pretty on raised banks, but they are so liable to suffer from frost that they are not to be depended upon for general purposes.

METEOROLOGICAL OBSERVATIONS.

CAMDEN SQUARE, LONDON.

Lat. 51° 32' 40" N.; Long. 0° 8' 0" W.; Altitude, 111 feet.

DATE.	9 A.M.					IN THE DAY.				Rain	
	Barometer at 32° and Sea Level.	Hygrometer.		Direction of Wind.	Temp. of soil at 1 foot.	Shade Temperature.		Radiation Temperature.			
		Dry.	Wet.			Max.	Min.	In sun.	On grass		
1891.											
January.											
Sunday	4	30.061	35.5	34.6	N.W.	33.8	37.2	38.0	43.6	25.2	—
Monday	5	30.210	28.8	27.7	N.	33.9	36.1	27.9	60.1	24.9	—
Tuesday	6	30.391	26.1	25.1	N.	33.9	30.7	23.3	45.6	19.2	—
Wednesday ..	7	30.292	25.3	24.9	N.	33.7	32.2	23.1	48.9	19.7*	0.070
Thursday	8	30.034	24.8	24.1	N.	33.2	33.7	22.3	44.8	22.3	—
Friday	9	30.118	28.9	28.3	S.E.	33.2	30.9	24.1	41.2	17.2	—
Saturday	10	30.505	29.3	20.1	N.	33.0	30.3	18.7	44.8	13.4	—
		30.230	27.1	26.4		33.5	33.0	23.9	47.0	20.3	0.070

* Covered by snow.

REMARKS.

4th.—Rain about 4 A.M.; fair day with some sunshine; thawing throughout.
 5th.—Sharp frost early; cloudless morning, and bright sunshine till 3 P.M., then one or two flakes of snow; brilliant cold night.
 6th.—Bright and cold.
 7th.—Bright sun till 11 A.M., then overcast; heavy snow showers at 3 P.M., and snow at night.
 8th.—Snow 1½ inch deep at 9 A.M.; fine with faint sunshine.
 9th.—Fine, with the sun shining through haze or slight fog.
 10th.—Slight fog, with the sun showing through early; bright afternoon.
 Another week of hard frost, but in ground covered by snow the temperature at 1 foot deep, is still 1° above freezing point. Barometer very high at the end of the week.—G. J. SYMONS.



IF not the most severe the present winter promises to be one of the longest that has been experienced during the present generation. At the time of writing a change is predicted by meteorologists, and it may come before these lines are in print, but like some other returns of mildness during the present winter may not last long. We earnestly hope, however, the frost will relax its determined, and indeed its deadly grip, for it has not only been fatal to vegetation to an extent that will cause great inconvenience, but to numbers of the weak and ill-fed members of the human family. It is sad to think that such should be the case, but so it is, while the privations and suffering that have to be endured by many are very acute. Outdoor work in gardens has been practically at a standstill for an unusual length of time, and little or no trade has been done in nurseries; and though we know that in many of these every effort has been made to find employment for men, even if not remunerative, the strain cannot much longer be borne. We are longing then for a permanent return of mild weather, whereby the land may be and remain unlocked, and trade resumed that has been paralysed so long.

The winter has now continued, with slight interruptions, for between eight and nine weeks, as it commenced on 24th of November. During the whole of that time there have only been ten days when the thermometer remained above the freezing point for twenty-four hours in London. A thaw set in on 3rd of December, and continued for three or four days, and there were fitful returns of mildness on the 3rd and 13th of the present month, but only for a day or two in each case, and the frost returned with little variation from its former severity. It has not, however, so far as we have observed, been so intense as during some past winters, though in Surrey thermometers have fallen below zero, but whether the instruments are correct or not we have no means of knowing. The severity, however, of the present winter appears to have been quite as great in the south as the north, if not greater; but this can only be determined by the returns from the various districts, which will no doubt be forthcoming in due time.

The past severe winters which we call to remembrance during a period of a little over thirty years were those of 1860-61, 1866-67, 1870-71, 1878-79, 1879-80, 1880-81. Of that series we think the greatest damage was done during the first and last mentioned periods, when the frost was extremely intense, thermometers in several districts registering from 5° to 10° below zero, and in a few localities much lower. For instance, in 1881 17° below zero were registered at Arkleton in Dumfriesshire, and 22° below zero at Blackadder House, as registered by what were believed to be accurate instruments, ordinary thermometers used in gardens being extremely variable, as may be proved in a few minutes by placing several in water. However, apart from such extraordinary records, Mr. D. Thomson of Drumlanrig found that from January 8th to the 17th inclusive (1881) "a mean of 24½° of frost each day," the greatest cold being on the day last named, 2° below zero. That low ten days' average sufficiently indicates the severity, and we are not aware of the cold being so great over a similar period during the present winter.

On January 20th, 1881, we have a record of a sheep roasted whole on the Thames near Twickenham, and we have heard that a similar roasting has been successfully conducted somewhere in the

upper reaches of the river this year. Be that as it may, though blocks of ice have been plentiful in that part of the broad stream which flows through London, in places almost covering it, they have not been piled and congealed in one great rugged mass as in 1881, and we have no desire for a return of that arctic scene in the City. Referring to the great frost just mentioned, Mr. J. G. Symons described the frost from January 12th to the 27th as one of the most remarkable cold periods of the century. But severe as it undoubtedly was, so far as our observations extend much greater damage was done to trees and shrubs by the frost twenty years before, but neither in 1860-61 nor 1880-81 was the winter so protracted as in 1890-91, and it is this which renders the present winter, end when it may, so remarkable, so difficult for gardeners and nurserymen, and to many poor people so disastrous.

Frost so continuous and severe causes not only present but future inconveniences in gardens, for not only in hundreds of these is almost every green vegetable killed that usually survives—Kales, Broccoli, Cabbages, Spinach and Lettuces—producing a famine in "green stuff," but it is difficult to curb the impatience as the year advances when awaiting the growth and maturity for use of spring sown crops. Gardeners feel as acutely the loss of the crops they have raised for winter and early spring use as can those for whom they were grown, and as it was beyond the power of man to prevent this loss the experienced and considerate will not intensify the disappointment by reminders of "scarcity" under the circumstances. Cooks, of course, will do so, as they know little of the ordeal that gardens have undergone, and if they did some of them would press their "wants" the more; but not all, for there are a few among the rulers of the kitchen who are reasonable. Gardeners also, or those of them who have not done so last season, will appreciate the necessity of providing a good store of such roots, apart from Potatoes, which are useful for winter use. Turnips, Carrots, Parsnips, and Artichokes are serviceable, Salsafy and Scorzonera often acceptable, while plenty of good Celery (which can be protected) for culinary purposes, also Leeks, are useful when frost destroys green vegetables, as during the present season.

Where means and resources are ample there is no difficulty in maintaining a supply of Asparagus and Seakale by forcing, with an occasional dish of Kidney Beans, but the absence of sun has not rendered the growth of these easy, nor the plants productive. Mushrooms, too, where suitable materials and conveniences for growing them are provided, can be had, and many are grown under greenhouse stages, or in sheds where a temperature of 45° to 55° can be maintained, as it may be under thick litter coverings in cool houses. But where all the requisite forcing conveniences in the form of light, well heated structures for Beans and pits for Asparagus are provided in one garden they are absent from a hundred; but more Seakale can be provided in many than is the case now by growing crowns where they cannot be bought, or buying them when they can and forcing them in pots in the dark, anywhere where there is sufficient heat for inciting growth. There has, we hear, been a great demand for Seakale roots and crowns for forcing of late, and in some nurseries more labour has been employed in packing these than all else put together, not even excepting seeds, on which we shall have a few words to say before closing this article. During a scarcity of winter vegetables it is, perhaps, not generally known how welcome is a good supply of the tender, cream coloured, succulent growths of Swedish Turnips, gently forced in a dark place. With good roots, topped, but not too closely, moisture, and a little warmth, nothing more is needed for producing dishes as a change from Seakale, liked by some persons quite as well, and by others better. It is true there is not space in all gardens for growing roots for this purpose, but where a cartload can be had from an adjoining farm the difficulty is removed; and after the young growths, as thick as a man's finger

and a little longer, have been forced and gathered, the roots are little the worse for cattle, though they would be if long clusters of useless growths were permitted to deprive the roots of their juices. It is a question of management, and the few gardeners who have managed them as suggested know what we have written is true.

As following on a vegetable destroying winter it seems desirable to make reference to the important subject of an early summer supply of vegetables from spring sown seed. We can do little more than direct attention to this matter, leaving some of our practical correspondents to describe the requisite cultural details. It is when the warm days of spring come and these pass to early summer that the disappointment is apt to be the greatest in waiting for vegetables. Weary waiting it is to gardeners who have no suitable glass structures and protectors in which they can raise and gradually harden such plants as Lettuces, Peas, Cauliflowers, Cabbages, and Celery for planting the moment the weather is favourable. In this way some weeks may be gained in the longed for supply, but for ensuring it on the earliest date the necessity for suitable appliances is absolute, and it is a simple fact that in small and moderate-sized gardens innumerable, especially in the suburbs of towns, they are not provided. Many of these gardens contain a conservatory, or one or more vineries or plant houses—regarded as supplying “glass enough for the place,” and the value and utility of moveable cold frames does not appear to be in the least appreciated. Some gardens in which a good deal of money has been spent on glass structures neither contain frames nor handlights; though they are absolutely necessary for affording a gardener a fair chance to do what is required of him, and in few gardens is the supply of these cheap and valuable cultural aids adequate.

Both in spring and summer lean-to and span-roofed frames are of very much greater service in gardens than the owners of those gardens appear to have any idea of, both for advancing early vegetables and flowers for planting out, for growing plants in summer for winter flowering in the conservatory, and for protecting Lettuce and Endive, for salads, also Cauliflowers in the autumn for use as far into the winter as possible. Moveable frames or glazed “boxes” are indispensable for preparing seedlings both of vegetables and flowers for planting out that may be raised in heated houses, for if the plants remain in these too long they will be drawn and spoiled, while if in their tender state they are transferred direct to the open air during the fitful weather of spring they may, and probably will, be ruined in a week. Boards affixed on edge, and the space between them bridged with large squares of glass, and made secure, are most serviceable sheltering aids; but even those are absent from gardens where suitable frames should be supplied. Gardens without a reasonable number of frames and handlights are insufficiently furnished, and never is the want of them so keenly felt as after a prolonged and destructive winter. With these simple garden necessities, and a mild heap of fermenting materials of leaves and a little suitable manure, much can be done that is otherwise out of the question; yet sometimes the impossible is expected by persons who are wholly unacquainted with the needs and methods of production. We are not writing in the interests of gardeners solely, nor yet mainly, but endeavouring to point the way in which gardens may be made the most productive at the time the produce is the most wanted in order that the results may be the most satisfactory to all.

A little remains to be said about seeds. We have received letters from managers and assistants thanking us for inserting the note of “Retail Seedman” on page 45, and indicating the extraordinary pressure that must inevitably occur in spring if seeds are not ordered till the time comes for sowing. This will involve the necessity of men working unreasonably long hours by gaslight, and even then the goods may not be despatched with the desired punctuality. It is a distinct advantage to gardeners and owners of gardens to have seeds in hand ready for seizing favourable

opportunities that may occur for sowing, and the seeds do not cost a penny more when ordered in midwinter than in spring. Alike in the interests of workers in gardens and seed stores we direct attention to this subject as meriting consideration at a time when seedsmen’s assistants as a body are insufficiently employed. Our desire is to see the difficulties of the protracted winter minimised as far as possible, and to suggest means whereby the disappointments which are more than possible in spring may be modified where they cannot be averted. Further references to the frost will be found on page 67.

THE ESSENTIALS OF CROTON CULTURE.

A CROTON may be only 12 inches high and confined to a 4-inch pot, or two or three times that height and in a pot slightly larger; or it may have assumed the proportions of a specimen. But in any case if well grown and coloured it will be beautiful, graceful, and useful. For the Croton, indeed, may well be claimed the leading position among plants cultivated for the beauty of their foliage. It must, however, receive the treatment which all first-rate plants demand, otherwise Croton culture will prove a great failure. A non-essential point is that of soil. A Croton may have any kind of soil—loamy, peaty, unmixed, or mixed, and failure will not follow on that account. I do not, of course, mean it to be inferred that where a good soil, such as a sandy, fibrous loam, can be obtained as the base of the compost that it should be lightly passed over; but I do mean that no one needs be deterred from cultivating Crotons on account of a meagre supply of good soil.

A matter of considerable moment has to be decided whenever a new sort is introduced. As a rule, we have to grow the plant for a season in order to determine its value, and after that to start afresh with the home-grown top as the parent of good decorative stock. This fact raises the question afresh, so pronounced in the case of many other bought-in plants, of the necessity of choosing personally any plants wanted, and not hesitating to pay a good price for a good article. A suitable time to buy is during autumn. If brightly coloured plants with well developed foliage are chosen they can either be grown the next year and good plants secured, or the tops may be struck in early spring, and any poor foliage near the base of the plant removed. It will thus be seen that a well coloured cutting with fully developed foliage is of great importance.

Then it is necessary to see that the part propagated is as slightly hardened as possible. For this reason it is much better not to be too hasty in spring propagation. It is not uncommon for a summer struck cutting of young current growth to overtake those rooted in early spring. Of course, if there is plenty of heat some latitude may be allowed, but as a rule it is safer to wait until April than to begin two months earlier. At the same time in cases where most of the preceding year’s growth is wanted in order to make tall plants the practice of layering may be proceeded with by the beginning of February.

We have now arrived at the really essential parts of Croton culture. These are light, heat, moisture, cleanliness, and good feeding. Light with as much sunshine as the plants will stand is so essential that it is impossible to colour Crotons well without its aid. The growing part should be kept all through within a few inches of the glass, and only when the youngest leaves push against it should the pots be lowered, and that but a few inches at a time; but light of itself and without heat is of no particular value. The plants winter well in a moderate stove temperature, and are neither particular as to light or to higher temperature than of 55° to 60° during the three colder months; but by February a higher temperature must be allowed, and all sunshine made the most of. If a little air is admitted from an early period in the season it can be increased during summer very advantageously and direct sunshine allowed the foliage without damage, and closing early in the afternoon with the best results following. Sunshine gives colour, and heat rapid growth; but the heat must be accompanied by a moist atmosphere, and during the season of growth it is hardly possible to give too much moisture. In early morning moisten everything about the structure and plants, and as the season progresses make repeated applications. Even when the ventilators are closed in sunny weather it will be necessary to apply moisture again about 6 and during the height of summer a second time about 8 to 9 P.M. The plants must on no account be allowed to become dry at their roots. Such a condition is fatal. The plants may not exhibit any bad effects at the time, but before long the loss of foliage will be sure to follow.

Having insured light, heat, and moisture in due proportions cleanliness is not so difficult to secure. If mealy bug is present

the conditions named will suit it exactly, and if it is once established some trouble will be experienced in expelling it again. Both as a preventive and as a cure hot soapy water freely and repeatedly syringed over the foliage and stems is perhaps as good as anything. Red spider and thrips follow a check from lack of moisture at root. Both are difficult to eradicate, and continued sponging is alone safe. Sponging is not a tedious process if properly undertaken. Most people now employ some favourite insecticide, and my method is to moisten a sponge with the mixture, squeeze most of the water out, and then draw the sponge over one leaf after another. It is a good plan to syringe the plant with soapy water a few minutes before sponging. In any case the foliage should have a moist sponge drawn over it from time to time during the season of growth.

The last point I have to note is that of good feeding. It may be accepted as a good rule that animal manure as a part of the compost of pot plants grown in a high moist temperature is productive of no good effect. On that account manure is as well left out of the compost employed for Crotons; but, at the same time, Crotons enjoy a strong diet just as much as the Leek or Cabbage. With the Croton we want neither flowers nor fruit, simply leaves, and therefore the importance of feeding to develop the foliage to its greatest limits. Liquid manure and soot often applied or weekly applications of superphosphate and nitrate of soda are means to this end. If the other conditions are fairly attended to it will be difficult to be too liberal with manures. I do not know any plant which is capable of absorbing a greater supply and thriving on it like this. Not only does this treatment produce foliage of good size, it moreover produces foliage of the best colour, which is the great desideratum.

For the benefit of those who are unacquainted with Crotons I name the following as useful varieties—Lady Zetland, a fine hardy red-leaved variety, good for decoration; Wiesmanni, still one of the best; anetieniensis, in the way of the above, well worth growing; Johannis, very fine drooping foliage; Sinnizianus, also a fine drooping sort; Countess, an invaluable variety; Mrs. Dorman, deep orange, narrow foliage, extra good, very hardy; aigburthensis, cream, narrow, fine; angustifolius, deeper shade than above, very fine; interruptus aureus, bright yellow, capital for room work; Queen Victoria, still one of the best; Evansianus, one of the best for room work, broad leaved, fine.

I have purposely omitted all twisted leaved sorts, as beginners will find them somewhat difficult to keep clean; also those of a rather tender nature, such as Hawkeri, Flambeau, and others. Anyone with two pairs in different sizes of those named to begin a winter campaign will find themselves very well placed indeed. It may be added that Croton foliage is of much value when cut for vase furnishing, but, of course we like to have a large plant or two to cut from. Specimen plants, it may be added, are most easily grown by keeping them in almost continuous growth. Two years will produce a fairly good specimen.—B.

POTATOES FOR IRELAND.

THERE is no gainsaying the fact that the Potato crop was a great failure in some parts of Ireland, and how best to tide over present difficulties and to avoid a recurrence of the same are questions exercising the minds of many well-wishers to the poor Irish peasantry. It has been decided—and very wisely, too, I think—not on this occasion to ship over so many tons of seed Potatoes for unscrupulous and improvident persons to do just what they please with, but rather to place at the disposal of competent authorities means whereby the requisite supplies of planting tubers can be had at a nominal outlay by all desiring the same. Presumably, every effort will be made to completely revolutionise the present very faulty systems of culture in vogue in the worst affected districts, it having been proved that the best of the disease-resisting varieties completely fail under what is known as the “lazy bed” method of cropping the ground. The ground in many instances, doubtless, is of an unsuitable character for Potato culture; but I hold that land that cannot be made to grow this crop is unfit for anything else. Nor does fairly good ground so soon become “Potato sick” as many would have us believe, one single crop in a year removing very little more from the ground than can be very cheaply restored each season—at least, such is my experience. We have now almost perforce grown Potatoes for ten years in succession on the same plot of ground, this being about one-half an acre in extent, and to all appearances the crop lifted last October was as good as any yet dug from this quarter. No fault can be found with either the weight or quality of the crop, yet the same varieties and nearly the same stock has been kept from the first. All the manure the ground has is a thin coating of decayed and charred garden rubbish, either soot or superphosphate of lime

being thinly sown in the drills when the Potatoes are planted. The position is very low, or almost on a level with a lake of water facing south-east, sunshine falling on much of it during the early part of the day only, while the subsoil is a cold solid clay. As a proof of the coldness and dampness of this position I have only to add that snow lies much longer on it than almost any other part of the garden, water weeds also flourishing on it.

Now if Potatoes can be had good year after year from this piece of ground, and we have never had a failure yet, surely equally good results ought to attend well directed efforts in the greater part of Ireland. I must repeat “well directed efforts,” for if all accounts are true, or even only partially so, the methods adopted by only too many poor Irishmen are not worthy of being termed efforts. The mere act, therefore, of placing abundance of planting Potatoes within their reach is only one step in the right direction. They want instruction, and should have it too if I had my way. It is generally admitted that Irish labourers work well under skilled foremen in this country, and in all probability would be equally amenable to a little instruction and guidance in their own homes. Nor need the providing of a staff of men competent to instruct the Irish labourer in the art of growing Potatoes be such an expensive or serious matter as might at first sight appear. The Government or other duly accredited authorities have only to announce the fact, and hundreds of British gardeners would most probably present themselves for employment. At the present time, and in fact at all times, it is only too true that there are large numbers of experienced gardeners out of permanent employment who would be very glad of an engagement in Ireland, say for a whole year. Allot certain districts to each man engaged, allow him reasonable expenses, pay him well, and depend upon it money would never be better spent. It is not merely at planting time when his services would be required, but he could be doing much good at all other times. Advice is greatly needed on the preparation of the ground, which ought to have commenced ere this. Then there is much that might be told those needing the information concerning the advisability of taking more care of the manure made on the place, as well as the ashes from the peat fires. The instructor could likewise try various experiments with special manure, and give good advice on the use of the same. Practical lessons on planting would naturally be a strong point in the educational process, and on the instructor would devolve the selection of suitable varieties for the purpose. Summer culture would follow in due course, and in the autumn good advice as to the selection and storage of both planting and eating tubers could be given, this being particularly needed.

Neither ought Potato culture be the only subject taken in hand by the instructor. By all accounts few of the poorer classes in Ireland think of growing any other vegetables, but I venture to think it would be much better for their health, and perhaps for their pockets, if they turned their attention to the cultivation of the same class of vegetables to be seen during the year in most cottagers' gardens on this side of the Irish Channel. With proper instruction, and a little further assistance in the way of seeds, plants, and bushes, the Irish might yet be equally as well situated as their more fortunate contemporaries in this country. In some instances, notably as regards climate, they have the advantage, and ought really to be in a position to supply our large towns with many early vegetables. This and much of what I have just advanced may be thought of a visionary character, but in reality is far less so than many much more expensive schemes tried in former years of scarcity, and which have completely failed to accomplish the good contemplated.

As before hinted, nothing has been decided upon as regards the best varieties for planting in Ireland, and upon this portion of the subject at any rate there is good room for a discussion. It is not merely reputed disease resisters that are required, it being altogether unwise to rely exclusively upon these. Scotch Champion was principally sent to Ireland in 1880, but though this suits them well as far as quality is concerned, containing as it does a greater per-centage of starch than most other varieties, it does not appear to be an unqualified success. It even failed under well conducted experiments in Ireland last year, and, all things considered, it is advisable to rely far less exclusively on the Champion than hitherto. Laxton's Reward, obtained by crossing Scotch Champion with Magnum Bonum, is a great improvement on the former. In its habit of growth and disease resisting properties it much resembles it, but the tubers are of much better form, the eyes being shallow, while the quality is excellent. The flesh is somewhat too yellow to please many people, but there is no mistake about its satisfying properties. Magnum Bonum is still a great favourite with us, and we had a capital crop on our low ground. The quality is good, and this Potato I would also strongly recommend for planting in Ireland. Sutton's Abundance again is admirably adapted for the same purpose, this being of

vigorous, disease resisting habit, very productive, and the tubers first rate in every way. Reading Hero, though not equal to Abundance, is yet well worthy of a trial; and Laxton's Bouncer, a cross between Reading Hero and Scotch Regent, though somewhat more expensive than any yet named, is well worthy of finding a place in most collections. Chancellor, which can now be bought cheaply in large quantities, is most productive and fairly disease resisting, the tubers being of good form and the quality good. Emperor is an enormous cropper and fairly disease resisting, but I am not greatly impressed with the quality. It is a good poor man's Potato though, and should be given a trial. White Elephant never did well with us, but is largely grown by cottagers who have good reason to be satisfied with the heavy crops usually obtained, and the quality is fairly good.

Some seasons are unfavourable to the growth of early and second early varieties, but in others exactly the opposite prevails, hence the advisability of avoiding putting all the "eggs in one basket." The summer of 1890, strange as it may seem, was very favourable to the growth of early and second early varieties of Potatoes, the crops being heavy, only slightly diseased, and of the best quality. I would, therefore, urge upon those responsible for the selections to include some of these in the Irish consignments. Of the Ashleaf the heaviest cropper will be found in Myatt's, and it ought always to be largely planted everywhere. Veitch's Improved Ashleaf is earlier, and worthy of a place in any selection accordingly. For heavy soils, or any position where disease often prevails, not one of the American varieties can be recommended by me, though if any exception could be made it would be in favour of White Puritan. Coles' Favourite, of English origin, has succeeded admirably with us for several years. It is of somewhat similar habit to the Ashleaf, and nearly as early, while the crops are heavy, the tubers well formed, and of excellent quality even if kept late. Sutton's Seedling, another good second early, would in many seasons prove a very profitable market variety. It produces heavy crops of large handsome tubers of fairly good quality, but the variety is not so disease resisting with us as could be wished. I have formed a very good opinion of Laxton's Victorious, a strong growing heavy cropping kidney with Ashleaf blood in it, but this, probably, is somewhat too expensive for Ireland this season. Carter's Surprise, another very heavy cropping, disease-resisting kidney, obtained by crossing Magnum Bonum with Myatt's Ashleaf, ought certainly to be given a trial, and so ought the same firm's King of the Russets, the latter being a very heavy cropper, the tubers round, good in form and quality. Lady Truscott can now be bought cheaply, and this is a very serviceable heavy cropping round, much the same remarks applying to Sutton's Satisfaction.—W. IGGULDEN, *Marston House Gardens, Frome.*

LILIES IN POTS.

WE cannot open any of the principal gardening papers without meeting some such announcement as the following issuing from the two great auction marts where horticulturists delight to congregate, and where the choicest plants and roots are from time to time sold:—"20,000 immense bulbs of *Lilium auratum*, just received in splendid condition from Japan, 200 *L. Krameri*," &c.; while another commences with announcing 15,000 grand bulbs of *Lilium auratum* and a large assortment of English-grown Lilies, &c. Now, these advertisements have gone on year after year for at least twenty years, and the great question comes, What becomes of the bulbs? Some answer to this I hope to give presently, but it may be that some of your readers may be tempted to stroll into these auction rooms, and may bid for and purchase some of these Lilies; they are to be had at a very reasonable rate. The purchaser takes them home, and is puzzled what to do with them. Of course it is utterly out of the question to plant them in the open, the ground is so wet and cold that it would imply certain death to plant them, and therefore they must be potted either temporarily or permanently. In the former case they must be placed in small pots hardly larger than the bulbs, and in tolerably stiff soil in which they can make roots, and then in the spring they can be planted out if it is wished to grow them thus.

But it is with the permanent culture of Lilies in pots with which I now have to deal. There are some of the hardier kinds which will do best in the open, while there are numbers which succeed better in pots in our variable climate, and I am convinced that mistakes are often made in their culture which lead to disastrous failure, while there are some mysteries in the cultivation of others we do not yet seem to have mastered. First, as to composts. It has been a generally received idea that the only soil for Lilies is peat. I am convinced that this is a mistake. There are some plants, such as Azaleas, Camellias, and other hardwooded plants, their roots being very fibrous, for which the Belgians use

what comes very near to this for that purpose, the thoroughly decomposed leaf mould found in the Belgian forests. But the roots of Lilies are fleshy, implying, I think, that they would like something more solid in the way of food, while we know that many of them come from habitats where strong loam abounds. I have, therefore, in the greater number of cases used one-third of good loam in the compost, and have found it answer very well.

It is also, I think, an error in culture to shake them out so completely as we are sometimes advised to do; in fact, they do not require thorough repotting every year, and if the outside portion of the ball is taken away they may be placed again into the same pots and the compost filled in. There are two sets of roots proceeding from the old bulbs—those which issue from the base and are thick and fleshy, these should always be carefully preserved, and those which issue from the base of the flower stalk, which are fibrous and of no use to the future nourishment of the bulb; in fact, in repotting it is a good plan to twist the remains of the flower stem out, when these roots will come with it.

It has generally been recommended to use a quantity of white sand in potting Lilies. Now, I seriously question whether this is good advice, especially when it is recommended to place a quantity under the bulb in potting. I have generally found that this becomes soddened, and even if it does not become sour I doubt very much whether it is of any use; it is far better I think to put a quantity of coarse sand and powdered charcoal in the compost, and so to have it free and open; this prevents its becoming close, and insures free drainage. And above all things it is necessary to avoid too large pots, especially with newly imported bulbs; before they have time to root sufficiently the soil becomes very moist, and hence decay is likely to set in.

When I have finished potting my bulbs I place them under a glass frame, open in front, and plunged in cocoa fibre refuse, being covered about 3 inches; this protects them from heavy rains, which are injurious, keeps them from frost, and allows a free circulation of air round them. When in the spring the pots are filled with roots they are taken out of this position and placed in a somewhat similar one facing the south, or in a cool greenhouse, and when they have started well they are again removed to a position where they are protected from rain and wind, but allowed abundance of air. Stakes ought to be supplied to them, and in placing them in care ought to be taken to injure the roots as little as possible. It may be thought that as the stems of Lilies are so stout they do not require any stakes. Of course they will hold themselves up well, but if an eddy wind catches them they may snap off, and it would be an unpleasant thing to lose the results of a year's care by neglecting this trifling matter. Where there is a greenhouse the plants may be brought in for flowering, and they will then form a very attractive feature in the autumn months.

There are many kinds of Lilies which are more suited for the open than for pot culture, although of late years we have seen the old *Lilium candidum* largely forced for the supply of cut flowers for indoor decoration. One of the earliest Lilies is *Lilium Harrisii*. This is a very curious instance of the influence of climate, for it is supposed to be none other than the old Japanese *L. longiflorum* introduced some years ago into Bermuda, where from being a single-flowered plant it has become so vigorous that imported roots will bear a couple of stems with eight or ten flowers, and very often will throw up a second growth blooming later in the season. Under ordinary cultivation it may be brought into flower without forcing early in the spring, whence it has received the name of Easter Lily. I have said imported roots, for my experience of it is that it does not retain this character in our climate.

L. auratum, the Golden-rayed Lily of Japan, is one of the most unsatisfactory of Lilies. Whether in pots or the open ground it seems almost impossible to keep it. Fine large fleshy roots are imported in tens of thousands every year, and yet the experience of nearly everyone who grows it is that it either breaks up into small bulbs, which are of no use, or else rots away altogether. Now and then one hears of success with it, but they are rare cases, and as a rule I believe disappointment is the issue. There are, however, two fine varieties of it which do not seem to follow the bad habit—viz., *L. platyphyllum*, a large broad leaved plant, much more nearly allied to *speciosum* in this respect, and with large broad petals, strikingly handsome; and *L. a. rubro-vittatum*, in which the yellow band on the centre of the petal is replaced by a red one. This I have found to do well, and the flower is very handsome.

Lilium Wallichianum superbum is, I think, one of the very handsomest Lilies grown, if not indeed *the* handsomest, at any rate, of the trumpet-shaped Lilies. It grows to the height of 4 or 5 feet, and bears three to five large white flowers about 8 inches long, with the interior suffused with the most delicate shade of

primrose yellow. It is a very fragrant and altogether a delightful plant.

Lilium speciosum.—This in its many varieties, from the pure white of *album* and *Krätzeri* to the deep crimson spotted *superbum* and *Melpomene* lends itself most readily to pot culture, and where three or four bulbs are placed in a large pot they make most admirable objects for adorning a conservatory or greenhouse in the early autumn months. I have never succeeded in growing it well in the open ground, and now entirely confine my culture of it to pots; it is one of the most beautiful of Lilies, and deliciously sweet scented, not having that overpowering perfume which makes *L. auratum* sometimes too much for the house. All the varieties are beautiful, but I think that *Krätzeri*, *Vestale* (both white), *Melpomene* (an American seedling), *superbum* and *atropurpureum* are the best, but as I have said all are beautiful.

L. Krameri.—I have never succeeded with this, and although it is very beautiful I would not advise anyone to try it unless they do not mind failure.

Lilium Browni is a very fine trumpet-shaped Lily, white in the inside with brown on the outer surface. At one time it was scarce, and thought to be difficult to grow; but it is now found to be of easy culture, and is certainly a very handsome Lily. Generally, it bears but one flower, but old-established roots produce two or more.

There are other varieties which are pretty and fragrant; but I think I have selected the best of those suitable for pot culture.—*D., Deal.*

THE GARDENERS' ROYAL BENEVOLENT INSTITUTION.

THE annual meeting of subscribers to the above Institution was held at "Simpson's" in the Strand on Thursday last, January 15th, at 3 P.M., when Baron Schröder presided, and was supported by Dr. Robert Hogg, Dr. M. T. Masters, Harry J. Veitch, Esq., John Lee, Esq., and other gentlemen. There was also a good attendance.

The business commenced by the Secretary, Mr. Roger Cutler, reading the minutes of the last annual meeting, which were duly confirmed, and this was followed by the Committee's report for the past year. The financial statement we published last week, but the chief items in the report and statement were as under.

The Committee congratulated the subscribers upon the continued and increased prosperity of the Institution. During the year thirteen pensioners died, four leaving widows, who had been placed on the pension list in succession to their husbands, in accordance with rule 7, and one pensioner had resigned his pension. Regret was expressed at the death of the late Mr. James McIntosh, one of the Vice-Presidents, and it was reported that Mr. J. F. Meston, one of the Auditors, had resigned his office on account of failing health. The fifty-first anniversary festival in June last, under the presidency of Mr. H. J. Veitch (the Treasurer), was a grand success, the amount realised being over £3000; and in connection with this dinner it was a noteworthy fact that, although the Institution had during the year sustained severe losses among its annual subscribers, the amount of the yearly subscriptions has risen from £1328 to £1403. The result of this success was that the Committee had not only paid away in pensions £300 more than in any previous year, but they had increased the reserve fund to £25,000. At the same time the increase in the working expenses had been exceedingly trifling, and twelve pensioners could be added to the list, making a total of 156. The statement of accounts showed that the year was commenced with a balance in hand of £753 6s. 10d. The annual subscriptions, the donations resulting from the annual dinner, and the sums obtained by means of collecting cards, amounted to £4491 18s. 7d., which, with the dividends on stock and interest on deposits, brought up the total receipts to £5235 8s. 11d., making, with the balance in hand, £5988 15s. 9d. By pensions and gratuities £2648 13s. 4d. had been expended, the working expenses amounted to £750 1s. 4d., which, with the purchase of £2000 2½ per cent. consols, brought up the expenditure to £5296 13s. 8d., leaving a balance in the hands of the Treasurer of £668 13s. 9d., and in the hands of the Secretary of £23 8s. 4d.

Baron Schröder remarked that all would agree the report and statement were most satisfactory, and their thanks were mainly due to Messrs. Veitch and Cutler, and the subscribers might well congratulate themselves upon having such excellent officers. Dr. Hogg moved that the report and statement of accounts be received and adopted, and stated that the Committee deserved the best thanks of the subscribers for their assistance during the year. He had been connected with the Institution for many years, and remembered when the first £1000 was invested, since which time substantial progress had been made, as seen by the £25,000 reserve fund, which he hoped would be further increased. The motion was seconded by Mr. Munro and carried unanimously.

Mr. Veitch stated that they had to deplore the loss of a great friend of horticulture in the death of Mr. McIntosh, and he proposed for election in his place as Vice-President, C. J. Brackenridge, Esq., The Grove, Bush Hill. This was carried, and Mr. Webber next proposed the re-election of Mr. H. J. Veitch as Treasurer, and that the thanks of the meeting be accorded him for his services during the past year. Dr. Masters seconded the resolution, which was carried by acclamation.

It was proposed by Mr. H. Turner, seconded by Dr. Hogg, and carried, that Messrs. Douglas, Denning, Wythes, and Sexby be re-elected members of the Committee, and that Messrs. Arnold Moss, and Pilcher be added in the place of Messrs. Ballantine and Bolton. Messrs. J. Lee, J. Willard, and J. Webber were elected Auditors, the latter taking the place of Mr. J. F. Meston, who had resigned owing to ill health.

Mr. J. Lee proposed the re-election of Mr. Cutler as Secretary, and remarked that it was unnecessary to say much in support of the resolution, as all know how greatly the Institution is indebted to him. Dr. Masters seconded the motion, which was carried by acclamation. The following were then formally placed on the list as pensioners under Rule 6 without election:—Christian Craig, James Shepherd, and Philip Wright.

Mr. J. Webber then moved a vote of thanks to Mr. H. J. Veitch for his service as Chairman at the Anniversary Festival on June 12th, 1890, and further proposed the resolution in the following form, to be illuminated on vellum, framed, glazed, and presented to Mr. Veitch at an early opportunity:—"At the fifty-second Annual General Meeting of the subscribers to the Gardeners' Royal Benevolent Institution, held 13th January, 1891, it was resolved unanimously that the best thanks of this meeting be presented to Harry J. Veitch, Esq., for his great kindness in presiding at the Anniversary Festival held on the 12th June, 1890, for the able manner in which he advocated the cause of the Institution, and the influence he brought to bear upon his friends for their liberality, and his own, on the occasion when the sum of over £3000 was realised."

Baron Schröder said he was proud to be able to second this resolution, for he had always found Mr. Veitch not only a good friend to the Institution, but ready to assist in any worthy cause. The resolution was carried unanimously, and Mr. Webber explained that by means of a subscription amongst private friends the testimonial had been prepared without any cost to the funds of the Institution. The proceedings then closed with a hearty vote of thanks to Baron Schröder for presiding.

The election of eleven pensioners took place later in the afternoon, the following being the result of the polling:—Henry Primmer (2657), Thomas Stevenson (2509), James Gage (2376), Susannah Davison (2127), David Innes (2033), William Newcombe (1910), George Hinxman (1875), William Bunn (1710), Joseph Henry Poole (1609), Isaac Gibbons (1539), Mary Ann Lane (1326).

THE DINNER.

At 6 P.M. on the same day as the annual meeting the customary "lark pudding" dinner of subscribers and friends was held in the large hall of Simpson's; about 100 attended, the Chairman (N. N. Sherwood, Esq.) being supported by Dr. Bennett and Messrs. H. J. Veitch and J. Lee. There were also present Messrs. H. Williams, H. Cutbush, J. Webber, G. Woodgate, W. Denning, J. Willard, G. Paul, A. F. Barron, F. Q. Lane, W. G. Head, P. Barr, J. & H. Laing, W. Poupert, H. Turner, and others.

The usual loyal toasts were proposed by the Chairman and responded to heartily, and he then proceeded to propose continued success to the "Gardeners' Royal Benevolent Institution," and remarked that the past season had been a very successful one, and it would be a good opportunity to review the progress the Institution had made. It was established in 1839, and in 1840 they had only one pensioner, in 1841 two pensioners, in 1842 four pensioners; in 1850 they paid away £492 in pensions, and they had £2250 invested. In 1860 they paid away £723, and had £5100 invested. In 1870 they paid away £787, and had £7800 invested. In 1880 they paid away £1074, and they had £12,000 in stock. In 1889 the sum paid away was £2345, and they had £23,000 in stock; and in 1890 the sum of £2648 was paid away, and they had £25,000 in stock. In 1891 the pensioners numbered 156 (cheers). The oldest pensioner was upwards of 103 years of age, and had subscribed £18 18s., while during the thirty-one years that he had been a recipient of the charity he had received £510. The number of pensioners who had been on the Society's books up to the present date was 559, and the amount of money paid, including expenses, was £56,288. They were indebted for much of the success of the past year to Mr. Harry Veitch (cheers). Many of those present were well aware of the excellent manner in which Mr. Veitch presided at the annual dinner of the Institution, and they were also aware of the magnificent sum collected through his exertions. Mr. Veitch's list amounted to £2000, the largest amount that had ever been collected in connection with any of the dinners with the exception of the Jubilee year. He was sure they would all agree with him when he said that Mr. Veitch was deserving of great respect and the cordial thanks of all present for the efforts he had put forward on behalf of the Institution. Their friend, who occupied a distinguished position in the horticultural world, was at all times ready to aid any cause of real distress that arose in connection with gardeners. At the urgent request of himself and their friend Mr. Cutler he (the Chairman) was permitted to tell them a great secret—a secret that was known only to himself and Mr. Cutler for some years. In 1885 there was a movement to augment the pensions, and at the annual general meeting held at the Bedford Hotel Mr. Cutler announced that with a view to enable the pensions to be permanently increased, a friend of the Institution had offered to contribute £500, provided the remaining £1500 was forthcoming by the end of the year. This was accomplished, and "the friend" wished his name not to be published. He had now, however, consented to allow his name to become known, having been assured by himself (the Chairman) that it might benefit the Institution. The name of "the friend" was Mr. Harry Veitch. (Cheers.) He was sure, therefore, that all would agree

with him in thanking Mr. Veitch for his kindness on that occasion, and for what he had done since. He had ever since his connection with the Institution taken the greatest possible interest in its welfare. He and his family had subscribed no less a sum than £1520 to the funds of the Institution. He was now about to ask Mr. Veitch to accept from a few friends "a thank-offering" for his services in connection with the anniversary festival, and for the good he had done to the Institution. In presenting the testimonial to Mr. Veitch, he expressed the hope that it would be a continuous reminder to him of his efforts on behalf of the Institution. The testimonial was that referred to in the earlier portion of this report, very handsomely mounted.

Mr. Veitch, who was received with loud cheers, responded in a brief but excellent speech, heartily thanking Mr. Sherwood and his friends for the testimonial and what had been said respecting his efforts. He remarked that he could add but little to the particulars given by the Chairman respecting the Institution, except to call attention to the fact that the expenses were very moderate, and this was chiefly due to their Secretary's energy and close attention to business. It had afforded him (Mr. Veitch) much pleasure to assist the Institution, and his best thanks were due to the Stewards who helped him so freely last year. He would like to see the number of annual subscribers increase considerably, as this would be an additional source of strength. (Cheers.)

Mr. Sherwood next proceeded to the toast of the evening, "The Health of the Secretary, Mr. E. R. Cutler," and remarked that as Mr. Cutler had been elected Secretary of the Institution for the fiftieth time it was considered a fitting time to recognise his great services. A testimonial had therefore been set on foot for presentation to Mr. Cutler that evening, and would consist of a purse of money. The subscriptions to the testimonial commenced at 1s. 6d. and went up to £50, pretty good evidence of the number of friends which their Secretary had, and the desire of everybody who knew anything about him to show an appreciation of his work. The total subscriptions amounted to £675 9s. 9d., and this sum the Chairman presented to Mr. Cutler amid prolonged cheers. Mr. Cutler replied in a short speech, expressing his great thanks for the kindness shown him on this occasion and throughout his term of office. Several other toasts followed, and then a programme of music and songs assisted in rendering the occasion a pleasant one.

VARIEGATED FOLIAGE PLANTS.

In your issue of last week (page 39 and 40) is an article upon the above, to which I wish to add a few remarks. It starts at this season of the year, and goes on to recommend *Coleus* and *Caladium*. The former would not stand but a few hours, and the latter I have never seen fit for decorative work, or only occasionally the old *Caladium argyrites* in winter. Then, again, for a table plant *Ananassa sativa variegata* is mentioned, but it is very stiff and prickly, though it stands the gas well. *Aspidistra variegata* is mentioned again as having stood the house work for two weeks, but I have in my possession good plants without spot or blemish in 4½-inch pots, and have never been repotted, that have stood well, and have never been out of the rooms longer than to be cleaned and syringed for upwards of three years. To the list of *Aralias* I should add *A. Sieboldi variegata*, one of the hardiest and best with grand noble foliage; also *A. reticulata* and *A. leptophylla*. Useful varieties amongst *Dracenas* are *terminalis stricta*, *gracilis*, *Fredericki*, and *hybrida*. In the place of *Caladiums* there are some good foliage *Begonias*. Then I should prefer in place of these *Arundo Donax variegata*, *Bambusa variegata*, *Cineraria maritima*, *Eurya latifolia variegata*, *Eulalia japonica variegata*, *Eulalia zebrina*, with *Phormium tenax variegatum* and *Colensoi* for large halls. There is a new variegated *Dracena*, *Doucetti indivisa variegata*, a grand plant for house decoration. Five useful old plants also are *Farfngium grande*, *Tussilago Farfara variegata*, now seldom seen, though almost hardy; *Cyperus alternifolius variegatus* must not be omitted.

I will mention also that amongst the many well known foliage plants, although not variegated, *Araucaria excelsa* and its varieties are plants that stand well. I have some about 18 inches high furnished to the pots that have stood in my rooms for upwards of three years. They do not grow fast, and are capital for such work; ornamental green foliage plants are most numerous. I have some *Kentias* that have also stood the time mentioned, and are perfect in shape and health.—**RUSTICUS.**

ROYAL HORTICULTURAL SOCIETY.

SCIENTIFIC COMMITTEE.—Dr. Masters in the chair. Present: Mr. McLachlan, Mr. Pascoe, Mr. Michael, Mr. H. Veitch, Prof. Marshall Ward, Prof. A. H. Church, Dr. Scott, Dr. Russell, Dr. F. Oliver, Dr. Bonavia.

Culture of Yeast.—Prof. Marshall Ward announced that he had succeeded in confirming Hansen's statement that yeast-cells, might be made to produce their endospores by cultivation on dry gelatine at a temperature of 25° to 27° C. (say 80° F.).

Proliferous Oranges.—Two specimens from Mr. Tharpe and Dr. J. Harvey Gibson respectively, were shown in which a second smaller Orange provided with its rind was enclosed within another. Dr. Bonavia, in commenting on these specimens, explained his views that the rind of the Orange is really the representative of an outer abortive row of carpels, and that the oil-cells of the rind are the modified equivalents of the pulp-cells.

Dr. Scott pointed out that, according to De Bary, the oil glands of *Citrus* were "lysigenetic," or the result of the breaking down of certain transitory cells; these cells are smaller than those of the rest of the leaf tissue and full of granular protoplasm, which is soon replaced by minute drops of ethereal oil. As the delicate partitions between these cells break down and disappear the small oil globules coalesce, so as to form one large drop.

Dr. Masters referred to Carnel's explanation of the analogy between the pulp cells and epidermal hairs.

Dr. Bonavia further referred in support of his views to the disc or outgrowth from the axis which characterises the flowers of the Orange and its allies, as also of the Moutan *Pæony* and other plants.

Professor Church commented on the development, in the absence of light, of the colouring matter as well as of the oily constituents as exemplified in these specimens.

Dr. Masters did not consider that the disc had anything to do with the carpellary whorl, though it was true that A. P. de Candolle had considered the rind of the Orange to arise from the development of the disc. An examination of the flower in the course of its development, and, indeed, in the mature state, is sufficient to show that this explanation is not correct. The specimens on the table were instances of "intra-carpellary proliferation," and the formation of a second whorl of carpels above and within the first. As the inner carpels had as perfect a rind as the outer ones, it was clear that the rind was neither a development of the disc, nor the representative of an outer and abortive row of carpels.

Cracking of Trees from Frost.—From Mr. C. Noble came a characteristic drawing, showing the effect of frost in splitting the bark and young wood of the Spanish Chestnut. The fissure was longitudinal, and of considerable length, and occurred on the north side of the tree.

Plant Diseases.—A letter from Professor Sorauer was read, suggesting the desirability of co-operation on the part of the Committee with an Association lately inaugurated in Germany for the purpose of studying the diseases of plants grown for agricultural purposes, and of instituting conjoint action in the matter of prevention or remedy. Professor Sorauer's proposals received the sympathy of the members present.



JOTTINGS:

MANY remember with pleasure the Orchid Conference and Exhibition held at South Kensington by the Royal Horticultural Society in 1886, and wishes have been frequently expressed that something of a similar kind would be again attempted. Ample evidence is forthcoming of the continued extension of Orchid cultivation, and though the large and sensational collections do not become more numerous, the real value of Orchids is more generally recognised now than it was some years ago. Still, it is strange that so few exhibitions are specially devoted to these plants, for though many societies make provision for them, I am not aware of any attempts in this country to provide an Orchid Show, except that at South Kensington already referred to, and another on a smaller scale at Birmingham subsequently. At Manchester, at York, at the Regent's Park, and at the Temple Show Orchids are important features, and are often admirably represented; but still there is not the same interest as would attach to a special Exhibition.

This subject has been brought to my notice by a schedule I have lately received from Heer Jhr. L. J. Quarles Van Ufford, Chairman of the Committee of the Hague Department of the Netherlands Horticultural and Botanical Society. This contains the classes and regulations for an Orchid Show to be held at the Hague, Thursday, May 28th, to Sunday, May 31st, this year. The twenty classes are in three divisions, the first for tender exotic Orchids, the second for hardy terrestrial Orchids, and the third for cut flowers. Gold, silver-gilt, and silver medals are offered, and it might be expected that a remarkable Show will be provided, as the classes with one exception are open to all exhibitors. Besides classes for general collections of Orchids, there are others for *Odontoglossums*, *Cypripediums*, *Cattleyas*, *Lælias*, and *Vandas*. The date will be a suitable one no doubt for Orchids generally, and as it follows the opening day of the Temple Show, many interested in Orchids in this country will take advantage of the opportunity to visit it.

The display of Orchids at the last meeting of the Royal Horticultural Society was a surprise to most of the Fellows and visitors,

for the weather was not such as to render it very safe for tender plants. Cyclamens were expected, and in their place Orchids were found, a rather peculiar change, and I do not remember ever seeing so many of these plants at a January meeting before. *Cypripediums* and *Laelias* predominated, and included several fine novelties, for there seems to be no limit to the variations obtainable, especially in the first named genus.

The varieties of the useful autumn and winter-flowering *Lalia anceps* are now very numerous, and range in colour from the pure white *alba* and the charming delicate *Dawsoni* to the extremely rich *Barkeriana*. There is also a considerable difference in the size of the flowers, and that shown by the Right Hon. J. Chamberlain at the meeting (*grandiflora*) is one of the largest, being equally notable for the breadth of the sepals and petals and the general fine form of the flowers. Another handsome variety was *L. anceps Ballantineana*, the sepals and petals tipped with crimson, and the lip with very rich magenta. Both these were deservedly honoured by the Orchid Committee.

Amongst the *Cypripediums* a hybrid named *Kramerianum* from *C. oenanthum* and *C. villosum* was noteworthy for its distinct colouring, good shape, and polished surface. The dorsal sepal was broad and rounded, boldly veined with rich purple on a white ground, and the deeply tinted veins were still further brought into relief by the pure white well defined margin. The petals and lip were heavily suffused with a purplish tint, and were notable for their shining polished appearance.

Cypripediums were also largely shown by Messrs. B. S. Williams & Son of Upper Holloway, who had an excellent group of these and other Orchids, with Palms and Ferns. Though many fine hybrids were included, one that attracted most attention was *C. Sallieri aureum*, a strong growing and free-flowering variety of the *C. villosum* type, with handsome flowers of a clear golden colour and wax-like texture that renders it extremely distinct. This was only one of many, however, and Messrs. Williams have no less than thirty-nine species, hybrids, and varieties in flower at the present time in their Holloway nurseries. The collection comprises nearly all the most valuable forms obtainable, and is in excellent condition, together with many others mentioned in the next paragraph.

As a list of Orchids in flower in midwinter, the following is so remarkable that it is given here in full:—*Calanthes bella*, *masuca*, *Sandhurstiana*, *Sedeni*, *Veitchi*, *vestita luteo-oculata*, and *rubro-oculata*; *Cœlogynes barbata*, *crinata*, and *speciosa*; *Cymbidium ensifolium estriatum*; *Cypripediums Amesianum*, *Ashburtoniæ*, *barbatum biflorum*, *barbatum Warnerianum*, *Boxalli*, *callosum*, *calophyllum*, *calurum*, *cardinale*, *chloroneurum*, *conchiferum*, *Crossianum*, *Dauthieri*, *Dauthieri marmoratum*, *Fitcheanum*, *Harrisianum*, *Harrisianum vivicans*, *hirsutissimum*, *hybridum*, *insigne albo-marginatum*, *Maulei*, i. o. *grande*, *Lawrencianum*, *Leeanum*, *Leeanum superbum*, *longifolium leodense*, *Measuresianum*, *Meirax*, *nitens*, *oenanthum superbum*, *politum*, *Sallieri*, *Sallieri aureum*, *Sedeni*, *Sedeni superbum*, *Sedeni candidulum*, *selligerum*, *venustum superbum*, and *vexillarium superbum*; *Dendrobiums bigibbum*, *endocharis*, *McCarthyæ*, and *superbiens*; *Laelias albida*, *albida superba*, *anceps*, *anceps Dawsoni*, *anceps Sanderiana*, *anceps Williamsi*, *autumnale*, and *Gouldiana*; *Leptotes bicolor*; *Limatodes rosea*; *Lycaste Skinneri*, and *Skinneri alba*; *Masdevallia tovarensis*; *Odontoglossums Alexandræ*, *Andersonianum*, *Inseleyi leopardinum*, *lingulare*, *Erstedii majus*, *Rossi majus*, and *vexillarium*; *Oncidium cheirophorum*, *Forbesi*, *ornithorhynchum*, *Phalenopsis prætextum*, and *tigrinum*; *Phajus grandiflorus*; *Restrepia antennifera*; *Sophronitis grandiflora*, and *grandiflora coccinea*; *Vandas Amesiana*, and *tricolor insignis*; *Zygopetalums crinitum roseum* and *intermedium*; and *Epidendrum Wallisi*.

Concerning one of these plants which was conspicuous in Messrs. Williams' group at the Drill Hall, though only a small specimen, something may well be said, for it is one of the most charming Orchids grown. This is *Oncidium Phalenopsis* (fig. 12), which is only too seldom seen in collections. The form of the flowers is well represented in the woodcut, and those who are unacquainted with the plants will be able to form an idea of its beauty when it is said that the dots, spots, and bars are of a peculiarly bright bluish purple or violet tint on a pure white ground. The plant is not of strong growth, but at Holloway it succeeds admirably in a cool house, and this is one of the recommendations of the species, as it can be

accommodated with the *Odontoglossums*, and any addition to the cool Orchids is most welcome.

The severe weather during the past month or six weeks has caused cultivators of Orchids much trouble, and the difficulty has been to maintain a suitable temperature without injuring the plants by excessively hot pipes. Plants in many instances are suffering to some extent, as must be inevitably the case, and all that can be done at present is to adopt every precaution to prevent the hot air passing direct from the pipes to either leaves or roots, and to hope for a change. It is almost tantalising to hear from a correspondent in San Francisco that "up to the end of December



FIG. 12.—ONCIDIUM PHALENOPSIS.

we used no fire for Cattleyas, and the temperature has not been below 40°. *Cattleya guttata* is in flower, and we have fresh green Peas and Tomatoes on the table."—LEWIS CASTLE.

THE CULTIVATION OF THE PEACH AND NECTARINE UNDER GLASS AND ON THE OPEN WALL.

[A Paper read by Mr. W. TENNINGTON, Calderstone, Aizburth, before the members of the Liverpool Horticultural Association, January 16th, 1891.]

It is unnecessary to take up any time with allusions to the history of the Peach, but before I proceed to the details of culture I may be permitted to remark upon the scarcity of matter relating to the culture of the Peach in the Horticultural Press, especially on the open wall, whilst week after week articles follow each other in rapid succession on the cultivation of the Vine. In many places the Peach is sadly neglected. This ought not to be, for I consider a good Peach scarcely second to any other fruit. It is indispensable in a collection of fruit for exhibition. The same may be said of a good dessert. And what a pleasing sight is a house or a wall of Peach trees in flower, the trees laden with bloom, some almost white, varying in colour to the deepest rose. In my opinion it is nearly as pleasing as a house of Orchids in bloom. Again, when the fruit is approaching ripeness, the leaves carefully drawn back, all fruit being exposed to the full sun, what a picture it is! Something to be proud of. But enough of this. I will now proceed to the cultivation of the Peach on the open wall.

In the first place I may say that out of doors the crop is rather a precarious one, late spring frosts and cold east winds being the greatest enemies. But these can to a certain extent be guarded against by the aid of blinds upon rollers firmly fixed to the coping of the wall. Ours are made of light canvas in 24 feet lengths, which can be readily raised or lowered by cords and pulleys. This is a substantial protection. They have been in use seventeen years, and even now seem little the worse for wear. Without such protection I think it would be useless to attempt the cultivation of the Peach outside so far north. I may say that during all those years we have never failed to produce a crop or a part of one, according to the weather which is prevailing in the spring when the trees are in bloom. It is generally on the open wall

that the trees are grown and prepared to replace any that are unsatisfactory under glass; therefore, it is always well to have young trees coming on. This also keeps all wall space fully occupied.

FORMATION OF THE BORDER.

This is the first point to be considered. We provide a good drainage with broken bricks or sandstone, over this we place old slates; these are of very great advantage when the soil has to be moved for the purpose of root-pruning; they prevent the soil mixing with the drainage, and also prevent strong roots striking down into the subsoil. We do not make our borders deeper than 18 inches under the base of the tree, sloping outwards to 24 inches. I strongly advocate shallow borders, as the roots are then within the beneficial influence derived from the action of the sun and air. In a dull wet season it is only from trees in such borders that fruit of good quality can be secured. The wood, too, made by trees in shallow borders is solid and short-jointed, therefore more fruitful, not so gross, and less liable to canker or get injured by severe frost, than wood produced by trees in deeper made borders.

THE SOIL.

Turf cut green from the field I prefer to that which has been cut and stacked for some months, as by the time the roots are in action the decaying grass and fibre cause the roots to move more quickly than would be the case in soil that is older. Our soil is too light for the well doing of the Peach, as the latter delights in a strong retentive soil. Therefore we add clay or marl in the proportion of one barrowload to four or five of loam with a couple of bushels of charcoal, which we make at home by charring the branches which fall from the trees, the dressings of pea-stakes, &c., a liberal dusting of bone-meal and a little old mortar rubbish are also added. When filling the border we do not use the orthodox sod turned grass side down, but fill in the mixture to the bottom. As the soil is placed in it is made firm by treading. Some judgment must be exercised in this, as if the soil is too damp this can be overdone, on the other hand if it is dry this is not easily accomplished. There is no doubt the best results are obtained from a border made sufficiently firm that a man can step upon it without leaving the impression of a footprint.

CHOOSING THE TREES.

The stock upon which the Peach is budded plays a very important part in the well-doing of the tree in after life. I prefer young trees with a smooth bark, and such as have the appearance of health and vigour, as it is well known to many what a drawback it is to have stocks that are bark-bound. Such stocks never swell in proportion to the scion. Thus, though the demand upon the roots becomes greater, the channels which convey the sap to the tree is not equal to the demand. The consequence is, root suckers are produced, the growth of the trees become stunted, and they do not produce such well-developed fruit. This can be relieved to some extent by making three or four cuts in the stock from top to bottom, right through the bark into the wood. This is best done in autumn. Although it, to some extent, relieves the tree for a time, it will not bring about a lasting balance between the stock and the scion.

Let us think for one moment. We have forced a foreign bead upon this stock. We do not allow one leaf or branch to be borne by the stock. I think this is wrong. If we allowed a branch of the stock to extend on each side along the base of the wall for a few feet, and keep it nailed and neat, the stock would be breathing through its own lungs. Many know what happens in the case of young Vines. If all growths are kept off the stem up to the rafter the top of the rod is the thickest. On the other hand, if young growth is allowed to extend at the base on each side then the rod is equal throughout. Does not this equally apply in the stock of the Peach? Therefore, I advocate the greatest care in choosing young trees; to get them from a good firm where the knife has not been too much used, as well as to have them true to name. Trees that have been subjected to much pruning whilst in a young state rarely ever prove satisfactory. They may grow well for a time, then the branches commence dying off one by one, until the whole tree collapses. This often happens under the strain of a full crop of fruit. To avoid this evil I prefer to plant maiden trees to begin with.

PLANTING THE TREES.

If the wall to be planted is a high one I should plant alternately standard and dwarf-trained trees. This may be done, if the trees that are to be removed are on the place, earlier than is often recommended—that is, as soon as the wood is ripe, just as the leaves begin to all, or even before. If the trees have to be obtained from a nursery

they should be procured in November. In either case the position the tree is to occupy should be made in readiness, so that it may at once be put into position without exposing its roots to the air a moment longer than is really necessary. Before planting cut off all the broken roots, and trim the ends of all the others with a sharp knife, as a clean cut soon heals. If a root is planted with a jagged or broken end there is no telling how far it will decay. After placing the tree in position lay the roots out straight, using some of the finer soil to cover them. Keep the roots near the surface, and plant the tree 6 inches from the wall to allow for the swelling of the stock. When the planting is complete secure the main branches to the wall temporarily, and allow time for the soil to settle before the final nailing takes place. Muleh the surface a little exceeding the radius of the roots with old spent manure; strong manure is not necessary at this stage, although it is of great benefit to older trees.

PRUNING AND TRAINING.

These are two very important points, and are closely allied, as by bad pruning no tree can be kept in good form, though a good crop may be obtained from a badly trained tree. It ought to be the aim of all cultivators to secure good crops from neatly and well-trained trees. We will begin with a maiden, that is a tree one year from the bud. Say we planted one last autumn; in the spring following when the pruning is done, cut it down to eight or ten eyes, choosing an eye that is situated in the front of the shoot to cut to. When the shoots push into growth select five shoots to form the foundation of the tree. If an upright leader is chosen this growth should be stopped when it has made five or six joints, or it would rob the side shoots or branches. On the other hand all the shoots may be trained in an oblique direction, which is known as fan-training, and is generally adopted. This equalises the strength of the growth, and always keeps the centre of the tree open until all wall space is occupied. At same time I prefer the method previously described, as by stopping the leading shoots whilst making growth the balance in the branches is secured in the early part of the season, when the weak branches are likely to receive an equal part of the sap. If one branch becomes strong out of proportion to the others it should be at once pinched in whatever part of the tree it may occur, as it is very difficult to restore an equal balance unless it is done in the early stages of growth, and thus prevent the use of the pruning knife.

Laying in young growth should be attended to as early as possible, for it is much easier and safer to do this before the wood gets firm than afterwards, as the growth is not so liable to be broken by winds, as well as having the full benefit of sunshine for a longer season. The following spring little pruning will be needed. Shorten the leader slightly. The other shoots, if the wood is ripe, lay them in full length. If not, cut them back to a point where they are ripe, taking care to cut back to a wood bud, and this bud should be on the upper side of the shoot. The growths that push from the branches will require thinning. Rub all from the under side and reduce those on the upper gradually to three on each branch, one at the base, one about half way along, and another at the end. A few of the intermediate growths may be allowed to grow, especially about the base of the tree, until they have formed two or three leaves. These form spurs and will be found handy to train a fresh shoot from if such should be needed. All lateral growths are to be pinched to one or two leaves as they appear.

The second year's training will be the same, only there will be no leader to shorten. The wall will be getting covered with the eight or nine primary branches. The tree will now be in bearing condition, and will have furnished a good space of the wall. The routine in the spring will be the same as that previously described, except the middle growth on the branch will not be required. The growth at the end, if there is not space to lay it in without crowding, may be pinched at the third or fourth leaf. This applies to trees that have filled their allotted space, but the shoot that springs from the base is to be left intact, as this is intended to replace its parent shoot, also to carry fruit the following year. When the fruit is gathered, if possible the same day, cut out all shoots that have borne it, and all others not required to furnish the tree. When laying in the young shoots sufficient space should be left, say 5 to 6 inches between them. The points will require nailing, whilst all shoots that are put into position in the body of the tree may be secured during the growing season, by pieces of split bamboo, or thin shoots cut from Privet hedges. This can be done more quickly than by nailing.

(To be continued.)



EVENTS OF THE WEEK.—To-day (Thursday) the Royal Society meets at 4.30 P.M., and the National Chrysanthemum Society's General Committee at 7 P.M., in Anderton's Hotel, Fleet Street. The Royal Botanic Society meets at 3.45 P.M., Saturday, January 24th. On Wednesday, January 28th, the Society of Arts meets at 8 P.M.

— THE WEATHER IN THE LONDON DISTRICT continued severe for several days after our last record, and on Sunday morning 20° of frost was registered. Monday was a clear, bright, sunny, and frosty day; but towards evening the wind changed to south-west with a rise in temperature, and on Tuesday morning the thermometer stood at 39°, the highest reading at 8 A.M. for some weeks. A rapid thaw continued throughout the day, completely dispersing the snow; but at night the temperature fell rapidly, and on Wednesday morning the thermometer reading was 27°, *i.e.*, 5° of frost. The River Thames is still full of ice, presenting quite an arctic scene.

— AT THE ROYAL BOTANIC SOCIETY'S GARDENS, REGENT'S PARK, a complete and careful series of meteorological observations is kept, and as Mr. W. Sowerby has courteously afforded us an opportunity of inspecting the records we are enabled to give the lowest readings of the thermometer during the past six weeks. It may be mentioned that the gardens have an altitude of 125 feet, and the observations are taken at 9 A.M., 3 P.M., and 9 P.M., but we have only given the minimum readings for 9 A.M., as these give the night, and therefore the lowest readings. The records are as follows:—December 10th, 27.7°; 11th, 23.5°; 12th, 23.5°; 13th, 23°; 14th, 17°; 15th, 18°; 16th, 22°; 17th, 27°; 18th, 23°; 19th, 25°; 20th, 15°; 21st, 30°; 22nd, 17°; 23rd, 23°; 24th, 28°; 25th, 24.3°; 26th, 26°; 27th, 29.5°; 28th, 28°; 29th, 27°; 30th, 24°; 31st, 19.5°. January 1st, 32°; 2nd, 25°; 3rd, 25°; 4th, 32°; 5th, 28.5°; 6th, 24°; 7th, 23°; 8th, 23.3°; 9th, 27°; 10th, 17.7°; 11th, 16.5°; 12th, 19°; 13th, 39°; 14th, 34°; 15th, 29°; 16th, 31°; 17th, 22°; 18th, 20°; 19th, 21.5°; 20th, 26°; and 21st, 31.5°. The ice on the lake has permitted skating during thirty days, and when measured recently it was 9¼ inches thick.

— THE WEATHER IN THE NORTH.—January 12th-19th.—The first two days of the week indicated were fine, with thermometer standing above 40°. Four days of pleasant weather followed, clear and generally bright, with frosts of from 2° to 6°. On the night of the 17th 12° of frost were registered. Sunday was dull with bitter east wind, and during the night a slight frost with a little snow returned. This morning the thermometer is at 32°.—B. D., *S. Perthshire*.

— THE DECEMBER TEMPERATURE AT LIVERPOOL FOR THE PAST TEN YEARS.—A correspondent sends us the lowest readings of the thermometer taken six miles from Liverpool for every day in December during the past ten years, from which we gather that the averages for the month each year were as follows:—1881, 33.0°; 1882, 31.8°; 1883, 34.0°; 1884, 32.4°; 1885, 30.9°; 1886, 29.0°; 1887, 28.9°; 1888, 30.6°; 1889, 32.1°; and 1890, 24.8°. The lowest temperature recorded in each month was—1881, 24°; 1882, 17°; 1883, 22°; 1884, 22°; 1885, 16°; 1886, 14°; 1887, 20°; 1888, 18°; 1889, 21°; 1890, 3°. The thermometer (Chadburn & Sons) was 2 feet 6 inches from the ground. Thus the severest frost was during last month, the last figure 3° on the scale representing 29° of frost.

— WEATHER AT GREENWICH.—At the Royal Observatory, Greenwich, the mean reading of the barometer last week was 30.29 inches; the highest reading was 30.53 inches on Sunday morning; and the lowest 29.90 inches on Friday morning. The mean temperature of the air was 30.9°, and 7.4° below the average in the corresponding weeks of the twenty years ending 1888. The mean was below the average on every day of the week except Tuesday, the deficiency amounting to 15.0° on Sunday and 14.3° on Saturday. The general direction of the wind was northerly, and the horizontal movement of the air averaged 11.2 miles per hour, which was 2.3 miles below the average in the corresponding weeks of sixteen years. Rain or melted snow was measured on four days of the week, to the aggregate amount

of 0.14 of an inch. The duration of registered bright sunshine in the week was 5.4 hours, against 7.4 hours at Glynde Place, Lewes.

— THE WEATHER IN YORKSHIRE.—On Sunday morning last, January 18th, we registered 34° of frost, or 2° below zero. During the day the highest temperature in the shade was 25°, though the sun shone brilliantly all day. By 3 P.M. the glass had fallen to 14°, at 9 P.M. 1°, and during the night fell to 1° below zero, or 33° of frost. On Monday, 18th, the wind veered round westward, and during the night got into the S.W., when rain commenced falling, accompanied by a stiff breeze. We have done nothing out of doors since December 15th. I am afraid the Broccoli are killed. Autumn sown Onions and Spinach have the appearance of having been boiled. Laurels are very much cut. The above is the most severe frost in the recollection of the "oldest inhabitant" in Ripley, a man over eighty, and who has been a keen amateur gardener up to the last few years.—J. TUNNINGTON, *Ripley Castle Gardens*.

— FROST IN ESSEX.—Just as preparing for press we receive from Mr. J. Perkins, The Gardens, Thornham Hall, a record of frost registered there during fifty-five days of the present winter, from October 25th to January 20th inclusive. We can only say now that on November 30th 23° of frost were recorded; on December 22nd and 23rd 24°, and on January 11th and 18th the same, but on the 10th of the month 26° are recorded. Mr. Perkins states the frost was 12° sharper at Thornham on December 25th, 1860, and 9° sharper on January 8th, 1861, than during the present winter.

— FROST AND VEGETABLES.—From Calderstone, near Liverpool, Mr. W. Tunnington writes—"We had 22° of frost here on Sunday the 18th inst. I think most vegetables are killed. Those who planted them thickly this year will learn a lesson. Even Carter's Late Broccoli, which in my opinion is one of the hardiest, planted at 2 feet 6 inches each way, seem crippled, as though half of the plants would not be of much service."

— FROST IN BELGIUM.—Mr. Charles Van Geert writes from Antwerp as follows:—"We have here now (19th inst.) a very severe winter, one of the longest I ever witnessed in my life, and the end of which is not yet to be perceived. The frost set in on the evening of 25th November with — 2° Reaumur (4½° Fahr.), and on the 27th we had — 12 R. (27° Fahr.) Since then the thermometer oscillated between — 2 R. and — 8 R., with short intervals of thaw and snow, keeping our gardeners on the alarm, between fear, hope, and disappointment. I believe a great number of plants and shrubs will be killed."

— MESSRS. WATKINS & SIMPSON have sent us a collection of seeds for "producing ornamental seed pods and berries for drying for winter," but we shall have to wait for some time before seedlings of all the kinds produce flowers and fruit, as some are rather slow in maturing, but not all.

— EAST ANGLIAN HORTICULTURAL CLUB.—The action of the above Club at their recent monthly meeting at the City Arms, Norwich, in resolving to hold a Show of Dahlias, &c., towards the autumn, establishes beyond a doubt that this youthful Society is very fittingly ambitious. The idea was proposed by Mr. Geo. Daniels, and seconded by Mr. Green of Dereham, being ably supported by the Chairman (Mr. Morris) and the whole of the members unanimously. Many new members were proposed.

— THE annual general meeting of the KENT COUNTY CHRYSANTHEMUM SOCIETY will be held in the class room at the Rink, Blackheath, on Tuesday evening, January 27th, 1891, at eight o'clock, to receive and pass the report of the Committee and Auditors, to elect the officers for the ensuing year, and to transact such other business as may be brought before the meeting in accordance with the rules.

— WE understand that the RICHMOND HORTICULTURAL SOCIETY will not hold a spring Show this year, but have decided to concentrate their strength upon the summer Show, to be held in the Old Deer Park on Wednesday, June 24th. This is a wise resolution, for the Richmond Show has long been the best of its kind round London.

— LIGUSTRUM OVALIFOLIUM.—I have never known this shrub to be so greatly injured by frost as it is this winter about Birmingham. Walking through the Victoria Park, I noticed that a great number of large, bushy specimens had the appearance of being scorched, and in the gardens in the neighbourhood the same appearance was general. In one of the nurseries I noticed a large number of the variegated variety scarcely injured. We cannot yet tell the extent of damage done generally, but it will be a longish record.—D. S. H.

— THE SHIRLEY HIBBERD MEMORIAL.—We notice in the advertisement of the above which appears in the *Journal of Horticulture* of last week that our name is not down as approvers and supporters of this memorial. At the invitation of the Royal Horticultural Society, sympathising with much of Mr. Hibberd's work, and wishing to put on record our sympathy and support, Mr. Wm. Paul attended the meeting that was held to initiate the movement, and is under the impression that our name was put down about fifteenth in rotation in the preliminary list of subscribers signed in the room. As there are thirty-four names advertised, nineteen after where we believe ours should appear, this omission seems to us, to say the least of it, irregular. Has this happened to any others of your readers present on that occasion? If so, it will not be strange if the result of the movement is not so good as might otherwise have been expected.—WM. PAUL & SON, *Paul's Nurseries, Waltham Cross.*

— THE annual Nursery dinner given by MESSRS. POPE & SONS, of the King's Norton Nurseries, Birmingham, took place at Mr. John Pope's private residence on the 15th inst., to which all the heads of departments in the various branch establishments were invited, and several horticultural friends were of the party. It is always a pleasant meeting, and tends to good will and pleasing recognition of services.

— THE annual general meeting of the BRIGHTON AND HOVE CHRYSANTHEMUM SOCIETY will be held to-day (Thursday), having been postponed from January 13th, and it is proposed that the next Show be opened on Monday afternoon, November 2nd, the judging to commence at 2 P.M., thus giving exhibitors extra time for staging. This is an innovation, but it is said the additional expense will be small, and there will be an extra afternoon and evening for visitors.

— EAST GRINSTEAD HORTICULTURAL SOCIETY.—Mr. F. Dunn, gardener to Sir Francis Wyatt Truscott, Oakleigh, has won the Royal Horticultural Society's silver medal presented for the highest number of points obtained during the year 1890 for general produce exhibited at the various meetings. Mr. W. Simmonds, gardener to K. R. Murchison, Esq., was second, securing the bronze medal.

— A CIRCULAR has been issued calling a meeting to consider the desirability of forming a FLORAL, FRUIT, AND VEGETABLE SOCIETY FOR BRIGHTON AND SUSSEX. The meeting is to take place to-day (Thursday) in the Odd Fellows' Hall, Queen's Road, Brighton, at 3.30 P.M., and many gardeners and amateurs are expected to attend, as it is generally felt that a well conducted and comprehensive horticultural society is much needed in Brighton.—M.

— DEUTZIA GRACILIS.—I had not noticed a mistake in my notes on this plant on page 564 until I read the remarks of "E. M.," page 28. On page 565 the word "Deutzia" has been introduced instead of Azalea. If "E. M." looks at the article again he will see that the first paragraph refers to *Deutzia gracilis*, the second to *Azalea amœna*, and the word *Deutzia* has been accidentally introduced by the printers or myself. The sentence "It grows freely in good soil (where lime does not abound)" refers to the *Azalea*, and not to *Deutzia gracilis*.—W. B.

— THE TEDDINGTON HORTICULTURAL SOCIETY, which has of recent years been noted in the metropolitan district for excellent summer shows, nearly collapsed this year owing to the unfavourable weather on the occasion of the last exhibition. Fortunately several friends, amongst whom Mr. W. Furze has taken a prominent part, have combined to prevent the loss of a really useful Society, and starting with a small balance in hand, it is hoped that, with well deserved local support and finer weather on the next show day, the Society will again be placed in a satisfactory position.

— EUPHORBIA JACQUINIÆFLORA.—Few plants flowering at this time of the year last so long in perfection as this *Euphorbia*. One of the finest displays that I have witnessed was in a small span-roofed stove in the garden belonging to Captain Robinson, Acrefield Road, Woolton. The plants varied in height from 2 feet to 3 feet 6 inches, or perhaps more. They were grown from cuttings inserted early in June, the current year's growths rooted in a brisk bottom heat, and finally placed in 4-inch and 6-inch pots. Each plant carries one stem, many of the shoots being wreathed thickly with the intensely bright flowers quite 18 inches or more in length. As the plants were arranged on both sides of the centre path forming an arch the full length of the house the effect produced can easily be imagined, and very creditable to the gardener in charge, Mr. C. Osborne.—E. M.

— A LARGE TREE.—Ten workmen are now engaged in taking out a section of a gigantic Redwood tree in the Mammoth Forest, California. The section removed will be divided into three cuts, each 9 feet in length. The tree is situated 6325 feet above the level of the sea. It measures 99 feet in circumference, and 33 feet in diameter. The saw used in the work is 22 feet long, and requires eight men to handle it. The divided sections of this big tree will be conveyed to Chicago on three flat cars for the exhibition at the World's Fair in 1893. The total weight of the three cuts will be 20 tons.—J. H.

— HARDY FRUIT EXHIBITIONS.—I hope the excellent suggestion of Mr. G. Bunyard on page 44 will induce secretaries and committeemen to adopt the plan of limiting a dish of Apples or Pears to five fruits. They can be staged in much less time, look better, as witness the Guildhall Show, and many an exhibitor knows that with six fruits to arrange on a dish he has one too many. With respect to Mr. Bunyard's further remarks on excluding orchard house fruit, I cordially agree they not only deceive the public, but also heavily handicap *bona fide* exhibitors of hardy fruit, who will be grateful for the practical letter.—S. T. WRIGHT.

— NATIONAL ROSE SOCIETY.—A meeting of the General Committee of the Society was held at the rooms of the Horticultural Club on the 14th inst. Dr. Hogg, a Vice-President of the Society, was in the chair. The Executive Committee for the year was chosen, that for last year being re-elected, with the exception of the Rev. Alan Cheales, who retires, and who is succeeded by R. E. Knight, Esq., of Bobbey Court, Sittingbourne. The Committee thus elected then considered the schedules of prizes for the metropolitan Show at the Crystal Palace and the provincial Show at Hereford, which was arranged very much on the lines of those of 1890. Questions with regard to judges' cards and the examination of the stands for duplicates were then discussed, and decisions were given on them. The question also of the gold medals was under consideration, and it is hoped that on all these matters the decisions of the Committee will approve themselves to the general body of subscribers. A vote of thanks to the Chairman concluded a very hearty and successful meeting.

— SPARROWS VERSUS THE CATERPILLAR PLAGUE IN CHESHIRE.—Under this heading on page 46, I observe an opinion expressed that caterpillars were more abundant than usual in Cheshire in 1890. Caterpillars of some kind or other are always a plague in gardens, but I did not observe that in this part of Cheshire they were more abundant in 1890 than usual; they were certainly less of a plague than in the preceding year 1889. But I write to complain of another plague less under control in gardens even than caterpillars, and becoming intolerable in this neighbourhood, I mean the sparrows. These have so entirely cleared the Currants and Gooseberries of buds that the crop of 1891 must be a failure. I have no doubt about the authors of the mischief, and they had not even the excuse of hunger. The buds were all pulled off in November and left under the trees. When the hungry bullfinches came they found nothing left, and it might be supposed that the sparrows had forestalled them out of spite. The time is past when gardeners can be convinced that the sparrow has any compensating use or redeeming virtue, and they ought to join with farmers in trying to exterminate such an odious pest. Sparrow clubs are an excellent institution, which I would do all in my power to encourage, and I should like to see the practice restored of paying out of the rates for sparrows' heads. I may add that the sparrow is one of the few birds that are quite indifferent to snow and frost, as their impudent boldness always enables them to get food. Indeed it is useless here to attempt to feed the blackbirds and robins, which have been dying of starvation all over the country, as the harpy sparrow gives warning to his friends as soon as the food appears, and snatches it all away before less impudent birds have a chance of coming near it.—C. WOLLEY DOD.

A JOURNEY TO BURMA.

[A paper by Mr. A. WINKLER WILLS, read at a meeting of the Birmingham Gardeners' Association.]

It had long been one of my day dreams to see something of the tropics with their cloudless skies; their teeming inhabitants, so different in appearance and manners from ourselves, and above all their lovely vegetation. Yet for years it was a dream which seemed utterly unlikely to be turned into sober reality. But the Fates ordained that some four years ago my only daughter should become the wife of a man whose lot was cast in the far East, and after two or three years of separation I became possessed of a strong yearning to see this child of mine once more in the flesh,

and thus it was that about this time last year my wife and I left the gloom of the English autumn, and the smoke of Birmingham behind us, and made our way quietly across France and Italy to Naples, where we embarked on the P. and O. steamer "Chusan" for Colombo, our first halting place on our long journey to Burma or Farther India.

I have accepted your invite to address you to-night the more readily because it gives me the opportunity of helping in some degree to dispel the astounding ignorance which prevails in this country about the latest addition to our vast possessions in the East, its people, and its probable future. When I first spoke of my intention to make this journey one friend said, "Going to Burma? Why, surely it's very dangerous?" And another, "Are not you running great risks from Dacoits?" And yet another, "Isn't the country very unsettled? and the people, are not they very savage?" And so on.

Well, you shall have my impressions of Burma and its savages

from the landing place, for our big ship draws 30 feet of water; but our luggage is quickly transferred to a boat by bronze-skinned Tamuls amid vast clamour and bustle, and in half an hour we set foot on the fairy land of Ceylon, one of the loveliest islands in the world. Here all is new and full of interest. Natives of India, whose slight lithe forms suggest animated bronze statues, and Cinghalese in white robes, and with their long jet-black hair coiled on the top of their heads and fastened with large tortoiseshell combs form the bulk of the ever-shifting human panorama; in the corridor of your hotel are scores of dealers in jewels—some genuine, more false—who would make your life a burden if you had not already learned the talismanic words "bus, jour" ("enough, get away). Indian jugglers and snake charmers exhibit their hanky-panky in the verandah, perform the celebrated basket trick, and make a Mango plant 3 feet high grow out of a seed and a little heap of dust, and produce their cobras and pythons to the terror of unaccustomed travellers. If you want to make a purchase or pay

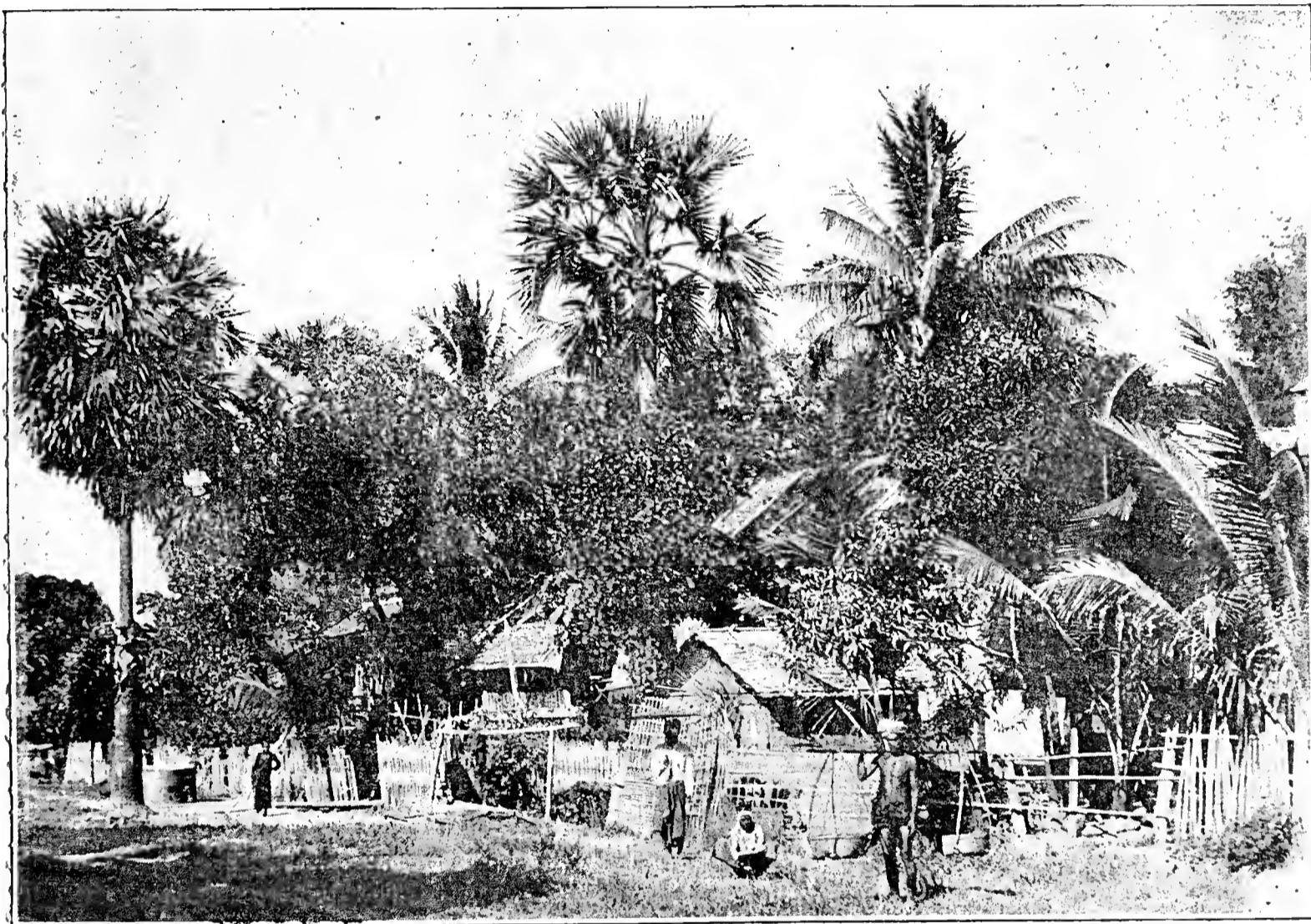

FIG. 12.—A BURMESE VILLAGE.

in a few minutes; but I must detain you a moment on the way. I am not going to waste your time by a description of a sea voyage on board a luxurious ocean-going steamer of 5000 tons. The miseries of a storm at sea, when all ports are closed and the thermometer stands at 90° in your cabin, are not an inviting theme. The delights of a smooth voyage, when you glide all day over glassy seas and beneath cloudless skies, of nights in which the stars or the moon shine out of a sky of ebony, as they do here only once in a year, but with this difference, that there you can lie back in your comfortable deck chair and revel in the coolness of the still air, while here you must shiver in an ulster. These and many other things are commonplace, with which everyone has become familiar in these days of travel.

Imagine therefore that we have escaped from the heat of the Red Sea, passed the grim rocks of Perim, and landed our mails at Aden, where, it is commonly said, only a sheet of paper divides you from the nether region, and that is scorched, and made a safe run across the Arabian Sea and Indian Ocean to Ceylon. As we approach the harbour of Colombo we see the long coast line fringed with tall Cocoa-nut Palms, our first glimpse of a vegetation so strange and so different from any we have seen before. We lie out half a mile

a call you hail a jinriksha, a miniature cab, drawn not by a nag but by a Tamul lad, who whisks you off at seven or eight miles an hour under a blazing sun, whose direct rays you could not encounter for one minute without getting a sunstroke; his head unprotected save by Nature's covering, and the working of every muscle visible under his shining, bronzy, and well-oiled skin. All is full of life and colour; all entirely different from anything we ever see under our dull and sunless skies.

But towards five o'clock the fierce heat abates, and the thermometer goes down perhaps to 80°, for it is winter time now, and at this hour every new comer takes a carriage and drives to the far-famed Cinnamon Gardens, a park-like public ground, where he saunters in the grateful shade of Cocoa and Fan Palms, Bananas, and tropical trees of novel aspect, and revels in the sweet breath of the Cinnamon bushes from which the place takes its name. Great bushes of Hibiscus, with flowers of a dozen varieties and colours, are dotted about everywhere; Allamandas, too, and Bougainvilleas of a deep rich purple, which make you pity ever after the pallid tint of those glass-grown and decrepit sufferers which are doomed year after year to do duty among the regulation "six stove and greenhouse plants," with which we are familiar. I think

I could put my hand on some of these washed-out specimens of vegetation which have travelled the midlands in search of floricultural honours for many years; but no one would find his enthusiasm aroused by them who has seen the Bougainvillea ramp and climb 40 or 50 feet high among the trees of an eastern garden, and droop down again in festoons and cascades of rich purple to the ground.

But I must hasten on, much as I could say of the beauties of this spot, for we have an invitation to spend a fortnight with friends at their Tea estate 5000 feet above sea level, up among the hills 100 miles away, and we gladly fly from the oppressive heat of Colombo, and take the train at seven next morning for the upland station of Talawakele. For the first hour the line runs nearly level, passing at first through groves of Cocoa and Areca Palms, with little settlements of native houses dotted here and there in cleared spots, each with its cluster of Plantains close by, while ever and again great open spaces of Paddy of intense vivid green extend on either side of the line, in various stages of growth, the young crops rising from perfectly level ground, which is kept flooded by an elaborate system of irrigation. Then the road plunges into dense forest and jungle, where creepers climb like gigantic snakes round the trunks and hang in superb curves from branch to branch of immense forest trees, while the dense undergrowth is relieved by many coloured flowers, of to us unknown kinds, and frequent pools by the side of the line are bright with large pink and white Water Lilies. We are now in the tract, which, beautiful as it is, is too truly known by the terrible name of the Valley of the Shadow of Death, for here, during the construction of the line, 50,000 natives and every European superintendent employed on the work died of malarial fever.

Then it begins to rise in a long steep incline till it reaches, one after another, vantage points commanding extensive views over jungle and forest, with foregrounds of superb trees, and every yard between them filled in with strange shrubs and flowering plants struggling one with another for space to grow in; still the road climbs and winds in vast curves up the mountain sides. At some points the way is scooped out of the face of the rock, while from the window of your carriage on the opposite side you look sheer down 800 or 1000 feet into the valley beneath. The glory of the ride, perhaps, culminates at the far-famed Kaduganaga Pass, but it is difficult to give the palm to any particular spot, when for fifty miles there is a continuous series of such views of everlasting grandeur over hill and valley with distant sight of Adam's Peak and the other great mountains of Ceylon, till the brain is almost bewildered with the beauty and wonder of the scene. As you reach an elevation of 3000 or 4000 feet Tree Ferns begin to show themselves, and the bright flowers of Lantanas form a conspicuous element in the vegetation of the middle region becomes scarcer.

At last, after some hours, a great and sudden change comes over the scene, for we have arrived at the zone suitable for the cultivation of Tea and Coffee and Cinchona, and here man has done his utmost to efface the consummate natural beauty of this fair land, for forest and brushwood have been alike ruthlessly swept from the face of the ground for miles in every direction, a suicidal policy for which the unfortunate planter is now paying a heavy and twofold penalty in the dearth of shelter and of firewood—dearth which he is now struggling to undo by planting Eucalyptus and Acacia trees of quick growth. At Talawakele station we left the train, and coolies took charge of our boxes, which they carried on their heads across country, reaching the house of our friends almost as soon as we did. For ourselves, a drive of sixteen miles in a ramshackle trap drawn by two emaciated horses landed us at the foot of the hill, behind which the bungalow of our hosts was situated, and half an hour's ride on two of their sure-footed ponies landed us at their door, 5000 feet above sea.

A well arranged programme of excursions through the island was defeated by unseasonable weather, the tail end of a cyclone in the Bay of Bengal, which we should have encountered had we gone straight on to Calcutta, so we spent much of our time in rambles near at hand. Fortunately the estate is the last in the district, and is skirted on the larger part of its circumference by still primeval jungle. Gigantic Bamboo Grasses, 40 feet high, are the most conspicuous element in the vegetation, and it is quite impossible to exaggerate the perfect gracefulness of their curves, or the delicacy of their feathery foliage. Equisetums 2 or 3 feet high, and resembling in their symmetry the most perfectly grown Deodara, abound, as well as many smaller species of this genus, and Selaginellas. So also do Ferns of a great number of species, and our hostess showed us a fine collection of 100 sorts all gathered within a small radius from the house. Tree Ferns, some 15 feet in height, but yet babies beside the giants of the Himalayas, are scattered through the brush and along the sides of streams, and the lovely *Gleichenia dichotoma* forms dense masses in the ravines, through which one might carve a tunnel, and yet have a thick

shelter overhead. But in this lovely climate, where the range of the thermometer all the year round is seldom more than from 56° to 75° day or night, you see side by side plants which we cultivate in the stove, the greenhouse, and the open air. In our host's garden are Poinsettias 9 or 10 feet high, big bushes of Gardenia, and scarlet and rose coloured Hibiscus luxuriating alongside of Fuchsias, Dahlias, and Roses; Euphorbia jacquiniæfolia beside Vinca major, Clerodendron Balfourianum in juxtaposition with blue Lobelia, and Phajus bicolor springing from a bank of English Violets.

One excursion we took to Horton Plains, where there is the highest inhabited rest house in Ceylon, was of special botanical interest. Our ladies were carried in Sedan chairs, my host and I rode, most of the way through jungle through which the vertical sun scarcely penetrates, with here and there a lane torn through the brush by roving elephants. Balsams abound here, from tiny species a few inches high to large bushes. An amazing profusion of Melastomaceous plants and many varieties of Tradescantia fringe the path, and a delicate white Thunbergia trails over the banks among innumerable Ferns and Selaginellas. A remarkable Arum is a striking feature, bearing flowers not unlike those of our *A. maculatum*, but with palmate leaves like those of a Horse Chestnut. Here we had our first sight of Orchids growing on the tree trunks, but a small Dendrobe and a *Cœlogyne* were the only ones in bloom. Here and there the track emerges for a time on to a grassy knoll or Patua, and here a charming terrestrial Orchid, like an enlarged *Pleione*, and of delicate purple, expanded its abundant flowers among white Smilax and blue and purple Gentians, and many others unknown to us. On the extensive plateau at the top of the mountain grew a superb *Hypericum* of exquisitely symmetrical growth, and from this point the eye ranges over rolling masses of hills, whose ravines are full of Tree Ferns and away beyond them to 60 miles of pathless jungle, uninhabited save by snakes and wild beasts, bounded only by the distant ocean.

Time fails me to tell you of half the lovely scenes which we beheld in Ceylon, but before whisking you away to distant Burma I must just tell you of what I consider two of the events of my life, botanically speaking. Never can I forget my first sight of *Amherstia nobilis*, that marvellous leguminous tree native of Burma and Siam, in the governor's ground at Kandy. Imagine a Laburnum enlarged to the size of a goodly forest tree, and its tresses of flower magnified into huge bunches of crimson and amber 4 feet long, and each flower 5 or 6 inches across, and you will not wonder that when we suddenly came in sight of *Amherstia nobilis* we involuntarily burst into exclamations of wonder and delight. Nor can I ever forget our visit to the far-famed gardens of Peradeniya, with its grove of gigantic Indianrubber trees, its superb specimens of *Ravenala madagascariensis*, so-called Travellers' Palms, which is no Palm at all but a Plantain; its unequalled collection of Palms, and, above all, its matchless groups of gigantic Bamboos, the bases of the stems of which are as large round as a moderate timber tree of these latitudes, and its great collection of tropical plants generally. I should add, by-the-by, that in a plantation close by these gardens we saw Vanilla and Cacao in growth by the acre. We were told that the former grew as easily as grass, and that if a plant was cut off at the ground it flourished almost as well apart from its roots as with them. Yet in our stoves how difficult it is even to maintain this Orchid in a semi-moribund state, so delicate are the conditions to which plants are adapted in Nature.

But I must hurry you on lest we fail even to arrive at Burma to-night. Our voyage from Colombo to Calcutta was uneventful, nor were the four days from Calcutta to Rangoon remarkable except for the contrast between the splendidly kept P. & O. steamers and the s.s. "Bundara" of the B. I. line, by which we went on. We had 600 coolies, native Indian labourers, on deck, and as two-thirds of them were generally smoking their hubble-bubbles night and day, a kind of rough hookah, in which is consumed a mixture of tobacco, Indian hemp, opium, and dried cow manure, a sickening odour pervaded every part of the ship, and made food a disgust and sleep almost an impossibility.

Hundreds of miles before the ship enters the mouths of the Irawaddy, the sapphire of the open ocean gives place to a brown tint, which proclaims that far out to sea the waters of that mighty river, which has flowed 800 miles through the length of Burma, mingle with those of the still mightier ocean. At last we entered the great mouth of the river, which forms the water way to the City of Rangoon, one of the many which for 100 miles of coast form the outflow of the Irawaddy; and steaming between low banks fringed with Palms and dotted with villages came at length in sight of the golden spire of the Great Pagoda, which, towering far above the loftiest trees, is a conspicuous land mark for leagues around, and then ran up to the landing stage, where at last we

joined hands with those dear ones, to see whose faces once again we had traversed so many thousands of miles by land and sea.

[With this interesting description of tropical scenery we have pleasure in representing a Burmese village, from a photograph taken by the talented traveller.]

(To be continued.)

PHYLLOCACTUS.

(Continued from page 546.)

P. CRENATUS.—A magnificent species, undoubtedly one of the best in the genus, and one that has proved extremely valuable in the hands of hybridisers, as with the crimson-flowered species it has yielded a number of intermediate tints, such as soft rose, blush, and pale crimson. The stems are flat as in the others, but they are only slightly crenated; the flowers are fragrant, of great size, 6 to 8 inches in diameter, with numerous lance-shaped petals, pure white and spreading. It is a native of Honduras, whence it was sent with several other plants by Sir Chas. Lemon, Bart., to Mr. G. Ure Skinner, in 1839, and it first flowered four years after its receipt. Seven years later—namely, in 1850, Mr. Gordon succeeded in raising at the Royal Horticultural Society's Gardens a series of remarkably beautiful hybrids between this species and *Cereus speciosissimus*, which attracted much admiration at the time, and are still found in a few collections. The pollen was taken from the *Cereus*, making the *Phyllocactus* the seed-bearing parent, and the result was that the seedlings resembled the latter in form of the stems and flowers, but the colours more nearly resembled the *Cereus* slightly softened and varied. All these hybrids proved extremely floriferous and useful garden plants. This cross was repeated in 1870 by Col. Charleton of Braddon, Isle of Man, but a greater variation in colours resulted, the tints ranging from the pure white of the *Phyllocactus* to brilliant scarlet. Mr. C. M. Hovey, Boston, United States, also produced a race of hybrids between *Phyllocactus crenatus* and what he terms *Epiphyllum splendidus*, but which is presumably some scarlet form of *Phyllocactus*. These were raised about the same time as Col. Charleton's, the flowers of all being remarkably large, from 8 to 12 inches in diameter, and very freely produced. The best of them are the following—Alice Wilson, orange scarlet; Mauve Queen, purplish pink; Orange Gem, shining orange; Pink Queen, mauve pink; Sunset, rich crimson, and Refulgence, dark scarlet. A fine variety of *P. crenatus* is grown at Kew under the name of Vogelii, which has very large flowers of a rich rosy tint, and probably originated from some similar cross to those already named. *P. Gordoniana*, which has bright rose-coloured handsome flowers, appears to have had a similar origin.

P. HOOKERI, *Salm.*—In the "Botanical Magazine," plate 2692, a figure of a fine white-flowered *Phyllocactus* was given under the name of *Cactus Phyllanthus*, an extremely old inhabitant of English gardens. In the opinion of several other writers it is quite distinct from and superior to that species, the name given above being consequently bestowed upon it. The branches and stem are flat and deeply crenated, 2 to 3 feet high, producing the flowers on the margin. These have a long narrow tube, and tapering white petals 2 to 3 inches long and about a quarter of an inch broad. It possesses a most agreeable fragrance, and usually flowers in the summer months from July to September.

P. LATIFRONS (*Cereus oxypetalus*, Decandolle).—A very strong-growing species, quite the giant of its family, producing stout flattened stems 4 to 5 inches broad, deeply crenated, and 8 or 10 feet high. A fine specimen, with several stems fully 8 feet in height, is grown in the Kew collection, and when in flower it has a remarkable appearance. The flowers seem to share the large dimensions of the plant, for they are 7 to 8 inches long and about 6 inches in diameter, the petals of a delicate clear creamy white, the sepals and tube of a reddish hue. It is a native of Mexico and some districts to the south of that country, and has been in cultivation for a considerable time, though the date of its introduction is uncertain.

P. PHYLLANTHUS, *Salm.*—As the oldest cultivated *Phyllanthus* this possesses a certain degree of historical interest, but it is not particularly beautiful, and is far surpassed by *P. crenatus*, *P. Ackermanni*, and the handsome hybrids that have been mentioned. Its branches are flattened and crenated, bearing long tubular flowers in the style of *P. Hookeri*, but not so broad at the mouth; creamy or greenish white, opening at night, and possessing a peculiar odour. According to the "Hortus Kewensis" the plant was cultivated by Phillip Miller in 1710, and a very good figure was given in Dillenius's "Hortus Elthamensis" in 1732, with a long description of the plant under the name of *Cereus Scolopendrii folio brachita*. It is the Spleenwort-leaved Indian Fig of Miller, and is said to have been originally obtained from Brazil.

P. PHYLLANTHOIDES, *Salm* (*Cactus speciosus*, Bonpland).—An extremely beautiful species, and, like *P. Ackermanni*, one of the most floriferous of the family, continuing in bloom during the greater part of the summer. With such an important character it is surprising that hybridisers have not employed the species more frequently in crossing with others, but it has no doubt contributed a few to the series of garden forms, and some of those with rose-coloured flowers can be traced to it. In the typical form the stem is flat, the margin crenated, and the centre reddish. The flowers are about 2 to 3 inches long and 3 to 4 inches across at the mouth, the petals being ovate or lance-shaped, and coloured rose and white in irregular streaks, very delicate and handsome. As *Cactus speciosus* it was mentioned by Bonpland, who,

with Humboldt in 1801, found it growing on trunks of trees at Turbaco, south of Carthagena. Plants or seeds were introduced to Europe by those travellers, and the first flowers were produced at Malmaison in May, 1811, plants also flowering about the same time in the Montpellier Botanic Garden.—L. C.

(To be continued.)

ASTER WHITE QUEEN.

THE accompanying illustration (fig. 14) kindly supplied by Messrs. E. Webb & Sons, Wordsley, Stourbridge, represents an excellent type of dwarf Aster, admirably adapted for culture in beds or pots. Webb's White Queen forms a compact bushy little plant about 8 inches high, bearing large, well formed, pure white blooms, borne quite clear of the

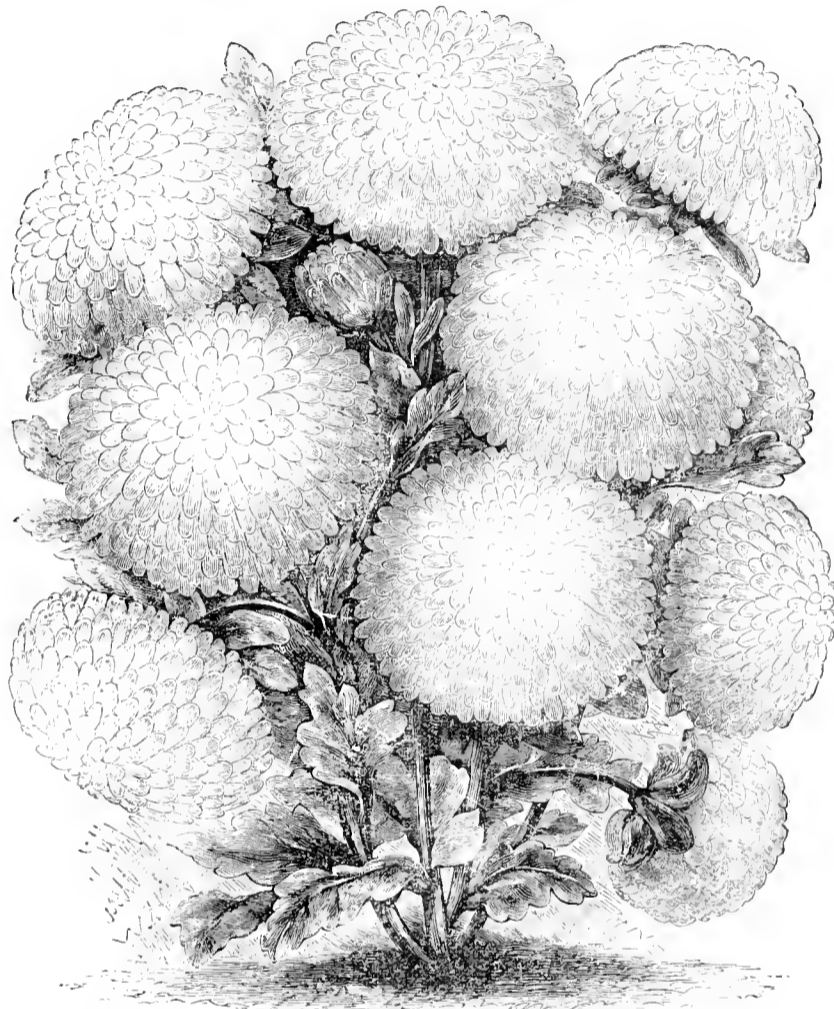

FIG. 14.—ASTER WHITE QUEEN.

foliage, so that they are seen to great advantage. This is an important character, for sometimes in dwarf Asters the blooms are so buried in the foliage that much of their beauty is lost. A capital companion for this is Scarlet King, which is exactly similar in habit, but possessing very bright red blooms, a sufficiently near approach to scarlet to justify the name as applied to florists' flowers.

A VISIT TO WOODSEAT.

THIS North Staffordshire seat of J. F. Campbell, Esq., has for many years been famous for its Grapes especially, besides Pines, Peaches, &c. It was at Woodseat that Mr. Rabone (now at Alton Towers) grew his noted Grapes, and coming to more recent times the cultural skill of Mr. Hollingworth has been well established; the greater portion of the Grapes so successfully exhibited by him have been cut from old Vines. At the time of my visit, the end of December, the earliest Vines had started regularly and strong, giving promise of a fine crop of fruit. The next division may be termed midseason, and is filled with old Vines in splendid order, wood being moderately strong, short jointed, with fine bold buds. In the latest compartment some Grapes were still hanging, consisting of the usual late varieties, all being very fine, Lady Downe's exceptionally good, the bunches being about 3 to 4 lbs. each, a weight seldom reached with that variety. I noticed that the Vines are pruned very close, seldom leaving more than one eye to a spur, and the spurs are sufficiently wide apart to allow plenty of light to each lateral, which probably accounts for the large bunches produced. The borders are inside and out, the vineries being built on arches. Peaches were in fine order, wood well ripened and studded with fruit buds, from which fine fruit may as usual be expected. Pines have recently been done away with, and the space they occupied is filled by extremely fine Eucharises; the foliage is large, and the spikes of flowers propor-

tionately numerous and fine. They are never more than a fortnight or so without plenty of flowers from these plants the whole year through. I question if the dreaded "mite" would have the nerve to attack such splendid plants. No drying off as practised by some, but the plants are kept going ahead, which may partly account for results. At the back of these houses Orchids occupy one division, which are in good condition; the remainder is filled with Palms and Crotons for decorative purposes. Ericas and small Azaleas fill another house, and promise a wealth of bloom. Other houses were devoted to table plants and Calanthes. In a cooler house some Orchids were flowering, many spikes being particularly fine. Pits and frames were full of Ferns, bedding plants, and Violets.

The conservatory is a large iron structure, built on the ridge and furrow system, and contains some of the best and finest Camellias I ever saw; most of them range from 12 to 14 feet high, and proportionately wide, with foliage and flowers to the soil. The Camellias alone are well worth going a long distance to see. Each plant is a model of health and vigour. They are planted in beds, and the mistake of crowding has been avoided. Other plants and climbers produce a very beautiful effect. As a good coating of snow lay on the ground it was not possible to note crops in the kitchen garden, but the fruit trees on the walls and by the sides of the walks looked very promising for good crops. Bramley's Seedling Apple is highly spoken of as suiting the heavy soil. More might be written about Woodseat and its trees and shrubs, but the above will prove that the gardener is a good fruit and plant grower, and the more credit is due as the soil is bad, requiring a good deal of judgment in managing.—S. T. W.

LILY OF THE VALLEY.

FEW flowers are held in higher estimation than the Lily of the Valley, and although in some parts of the country it is found growing wild by the acre, this does not make its cultivation any the less appreciated by lovers of flowers; but what I am most surprised at is the vast amount of money sent to other countries for the purchase of crowns or clumps, when in certain parts of Great Britain they can be produced of infinitely better quality than the majority of imported roots. I do not infer that the common wild forms can ever be brought to the same perfection as some of the larger varieties that have recently been brought into cultivation. The variety we grow is one that my predecessor here "singled out" years ago, and is known as "Harris' variety." It produces large spikes and from sixteen to twenty-four bells on a spike when well grown, but does not force quite so quickly as the smaller forms, although we generally manage to have nearly 1000 spikes ready for the annual decorations of the ballroom during the first week in January.

Our beds altogether comprise about half an acre, a quarter of which is annually used for forcing purposes, giving a continued supply of flowers from the first week in January until they bloom out of doors. The method of culture is as simple as possible, for as soon as a good portion of one of the beds has been lifted for forcing we give it a good dressing about 6 inches thick of old Chrysanthemum and potting soil, thoroughly decayed leaf mould, and well decayed light manure in equal parts, also a good sprinkling of soot or wood ashes.

The non-flowering crowns are singled out and tied in bundles on wet days, and when an opportunity occurs (we choose a fine day if possible) commence planting much in the same way as nurserymen transplant seedling trees. Let the drills be a foot asunder, and plant the crowns an inch or so apart, throwing in a little of the leaf mould to the trench before putting in the crowns, which ought to be well elevated and made quite firm. We find a border facing east the best aspect for them, and we give neither mulching nor any other top-dressing during the whole period of their growth, as by experience we find they do better without it; but, of course, they are all lifted for forcing at the end of three or four years. During the two first years after planting all weeds are kept down by hoeing, but afterwards we want to leave the young runners to get the stock for subsequent planting, therefore after that time the beds must be kept clean by hand-weeding, or using on a hot day a small Onion hoe to cut up the small weeds.

Forcing is carried out under much the same conditions as have been recommended from time to time in these pages, only we do it more in a wholesale way. A bed of fermenting material is made up in the pit inside a Melon house. The pit is 45 feet long and 3 feet wide, and is heated by two 4-inch hot-water pipes; over these we place the material (leaves and litter), which has previously been well mixed together, turned, and sweetened; then the Lilies are dug up, the non-flowering crowns pulled out, and the clumps placed on the fermenting material when the temperature is from 80° to 90°, and a little moss, or failing this leaf mould, is placed on the crowns, and the whole pit is covered with lights, and kept dark until growth has fairly commenced. During this stage they are

kept frequently syringed with water the same temperature as the bottom heat. When growth begins gradually admit the light and air until the spikes are well advanced, then the lights can be entirely removed. When the bells begin to open we make the roots up into the vases and boxes for house decorating, or if for cutting pack them closely into rough cutting boxes, so that they can be easily moved into cooler quarters for a few days before being cut. Later on successive supplies are brought on by simply placing the clumps on the floors of any of the forcing houses, where they start freely, and after forcing they are planted out in the woods.—W. J. IRELAND, *Singleton, Swansea.*



CHRYSANTHEMUMS FOR DECORATION.

THE remarks by "J. P." concerning bush plants are very opportune, as the rage for large blooms for exhibiting has doubtless caused many useful varieties to be either discarded or not to have the cultivation accorded to them that their merits deserve. To those who have not the chance or privilege of exhibiting, bush plants can be more readily grown for conservatory and cutting purposes, and make a good addition to those plants grown in 8-inch pots to carry three, four, or six large blooms, as the case may be. For large bush plants I have usually in January placed three cuttings in a 60-sized pot, stood them in a warm greenhouse or vinery just started, and when rooted I have taken them to a cold greenhouse, potting them without dividing into 48's as soon as ready, and the end of March shifting again into 7-inch pots, placing them in a cold frame with plenty of air at all times. Plants that have done duty in 48-pots are very useful for growing again. Some of them at the present time may now have four or five strong shoots. Shake them out and replace into the same pots, and shift as required. A cool greenhouse is the best place for them till March.

When the weather is favourable about the end of May they are finally shifted into 10 or 12-inch pots, and some a little larger, according to the strength of the plants. An open position is accorded them throughout the summer, and liquid manure is given about three times a week from August onwards. At their final potting a few sticks about 18 inches long are used, and the shoots drawn out and tied to them to admit more air and keep them strong. From the commencement pinching the extreme points of the shoots when 3 or 4 inches in length is resorted to, the large-flowering varieties up to the middle of June, and Pompons till the middle of July. No attempt is made to tie down or train the shoots, as in the case of plants grown for exhibiting; but in August seven or eight good sticks of sufficient length and strength are placed in the pots, and the growths tied and looped up about every three weeks. This is essential, as if not attended to a windy day will do much mischief; and even if winds do not prevail their own weight will cause them to hang down, and not have so slightly an appearance in the autumn. In the size of pot named, plants have ranged from 3 to 5 feet high, 3 to 4 feet through, carrying from fifty to 100 heads of bloom. I have also seen, when short of large pots, large bushes grown in Seakale pots for cutting purposes, these pots not usually being in use from May to December.

Varieties are so numerous and good that anyone with a limited space for housing them have a difficulty sometimes respecting which to select for the purpose named. I have found that those having a decided colour are the most appreciated in a cut state. Good whites, such as Lady Selborne for October; Avalanche, Elaine, and Madame Lacroix for November; Fair Maid of Guernsey for December; and Ethel for January. Good yellows, such as Peter the Great, Mrs. Dixon, and Thunberg; and good reds, such as Cullingfordi and Julie Lagravère. This last-named, although an old one, is still one of the best of its colour, and its foliage is good. In fine autumns like the past one, it has been excellent outdoors. Some plants of this grown purposely in this kitchen garden for cutting have furnished a large quantity of flowers. At the present time the only three kinds we are cutting from are Ethel, Thunberg, and Meg Merrilies; these three sorts were kept in a cool house through October, November, and December. Meg Merrilies is the latest of the three. Other good varieties of various colours for making bushes are Ralph Brocklebank, Hiver Fleuri, Madame C. Audiguier, Edouard Audiguier, Margot, Mons. Ardene, Bouquet Fait, James Salter, La Triomphante, Madame Bertier Rendatler, Edwin Molyneux, Mrs. G. Rundle, and Princess Teck. Those who have a liking for Pompons will find Sœur Melanie, White Trevena, Cedo Nulli, and Madame Marthe good whites; Golden Circle, Aigle d'Or (early), and St. Michael good yellows; Bob, Calliope, and Brilliant good reds. The Anemone Pompons are pretty for cut flower work, Antonius, Madame Montels, and Madame Sentir being excellent types. The variety Marie Stuart is a free grower, and makes a fine bush, and should find a place in the most limited of collections.—A. HARDING.

SHEFFIELD UNITED CHRYSANTHEMUM SOCIETY.

THE annual dinner of this now prosperous Society was held on Monday evening, January 12th, at the Maunche Hotel, Sheffield, when about eighty members sat down. In the absence of the President, Mark Firth, Esq., who is travelling abroad, the chair was taken by C. E. Jeffcock, Esq., Vice-President, who was supported by the principal officers of the Society, and also delegates from societies in various other West Riding towns.

This was the first annual dinner held since the amalgamation of what previously were two rival Chrysanthemum Societies in the town, and the most enjoyable portion of the evening's entertainment was the presentation to Mr. H. Broomhead, Hon. Treasurer, and who from the first starting of the Sheffield and West Riding Society has been a most indefatigable worker in its behalf, a liberal subscriber to its funds, and has been very largely instrumental in bringing about the union of the two Societies. This consisted of a valuable testimonial, subscribed by the members, and consisting of a handsome marble timepiece, a pair of bronze Stanley ornaments, representing Stanley and Emin Pasha on horseback, and an illuminated address, which ran as follows:—"The marble timepiece and pair of Stanley ornaments were presented to Mr. Henry Broomhead, Treasurer of the Society, by the members, as a slight recognition of his untiring energies, extending over a number of years, in the advancement of Chrysanthemum culture, and the liberal support freely rendered on all occasions, and more especially in connection with the amalgamation of the two principal Chrysanthemum Societies of Sheffield." This was signed by the President, Vice-Presidents, and Secretaries.

The Chairman in making the presentation referred at length to the valuable assistance and support to the Society so long rendered by Mr. Broomhead, and especially to his work in bringing about the amalgamation, the good results of which could be seen by a reference to the balance sheet. Mr. Broomhead, after thanking the Chairman and the members for their kindly expressions, said it was a great surprise to him to be made the recipient of so handsome a gift. He had not counted upon receiving anything of the kind, as whatever he had done for the advance of the Society's interests had been to him a work of pleasure.

In responding to the toast, "The Officers of the Society," the Secretary, Mr. Housley, said that the Society now numbered 350 members, and that the season just closed had been the most successful one the Society had experienced. The Show held in November last was very far superior to any held in previous seasons, and notwithstanding that the amounts paid in prizes had this season been considerably larger than in any previous season, a reference to the balance sheet showed an addition of over £50 to the Society's funds as the results of the year's workings. The amalgamation had been a great success.

The Committee has decided to hold a Show in the Corn Exchange, Sheffield, in 1891, on Friday and Saturday, November 13th and 14th. —W. K. W.



FRUIT FORCING.

PEACHES AND NECTARINES.—*Earliest Forced Trees.*—Fertilising the flowers must be continued as succeeding ones expand and the pollen becomes ripe, distributing it over the stigmas, which is more effectual when done with a camel's hair brush or feather than shaking the trellis. Syringing may be resorted to both morning and afternoon when the fruit is well set, but in dull weather damping will be sufficient, and in cold weather syringe sufficiently early to allow the foliage to become dry some time before nightfall. This is important, for keeping the trees constantly dripping with water encourages soft woody growths, and is fatal to that elaboration essential to the swelling of the fruit and the solidification of the wood. Water used for syringing must be of the same temperature as the house. Ascertain that there is no deficiency of moisture in borders inside, watering thoroughly if necessary, as dribblers are next to useless. Disbudding must soon have attention. It must be done carefully at this early season, removing a few growths daily from a tree preferably to many at distant intervals. The latter practice gives a check to the roots, and promotes wood growth at the expense of the fruit, which for lack of assimilated matter often falls at this juncture in consequence of sap congestion. Maintain the night temperature at 55°, 60° on mild nights, 60° to 65° by day artificially, 5° less on those figures when the weather is severe and dull. Ventilate early, admitting a little air at 65°, not allowing an advance over 70° without full ventilation, closing at 65°, always excepting a small space left at the top constantly. This prevents a vitiated atmosphere, securing a healthy condition in the leaves, enabling them to do more and better work in the daytime.

Second Early Forced Trees.—Those started at the beginning of the month are expanding their flowers, and before they open it is well to make a close scrutiny of the trees, and if any aphides are found fumigate to exterminate the pests. Great care is necessary in fumigating, as the organs of fructification are easily and irreparably damaged.

Moderate fumigation on two or three consecutive evenings will be sufficient, keeping them in check until the fruit is set. Avoid solutions which sometimes damage the petals and enfeeble the stamens and pistils. Where there is an excess of blossom buds draw the hand the contrary way of the growth along the under side or back of the trellis, so as to remove all those there situated, and if that is not enough thin them well with the forefinger, leaving the best situated, which, by the removal of the ill-placed and too crowded, will be increased in vigour, and a more even setting and better swelling of the fruit be thereby secured. Syringing must cease when the buds show colour, but damp the house in the morning and early afternoon, for though damp stagnant cold air is not favourable to Peach blossoms, or the trees in any stage of their growth, a dry atmosphere is pernicious by provoking constant and excessive evaporation. See that the inside border is thoroughly moistened through to the drainage, but avoid needless waterings.

Succession and Late Houses.—Finish pruning the trees at once, dressing them with an insecticide, after washing them with softsoapy water, 4 ozs. to a gallon, taking care not to dislocate the buds, not using the dressing at "winter" strength if the buds are advanced in swelling, but syringe with a weaker solution. Secure the trees to the trellis, allowing ample space for the swelling of the branches, and leave room between them for laying in young wood for future bearing. Fork the borders lightly, not disturbing the roots, removing any loose soil and supplying fresh loam, with a dressing of steamed bone meal and wood ashes in equal parts at the rate of half a pound per square yard when the trees are weak through carrying heavy successive crops of fruit. Half the quantity will suffice for vigorous trees. Apply it to the surface, trusting to washings from the watering pot or hose for its admixture with the soil. If the trees are liable to gum use superphosphate of lime and muriate of potash. The sulphur energises the protoplasm, and the acid of the muriate dissolves silica, which strengthens the epidermal structure of the trees, rendering them less susceptible of gum disease. Three ounces of the superphosphate and 2 ozs. of potash muriate are a full dressing per square yard. If the trees are inclined to long-jointed growth increase the superphosphate by 1 oz., reducing the potash proportionately. If the borders are at all dry they should be given a thorough watering. Those with moveable roof lights will not require watering, the soil being in a thoroughly moist state from rain, and the shoots are kept in a condition by the air moisture unfavourable to evaporation, so that the trees not only have thorough rest but conditions favouring the buds, which not infrequently fall in the dry changeable atmosphere of houses with fixed roofs. Bud dropping is, however, due to other causes than deficiency of moisture at the roots during the rest period. Over-maturity of buds, as in trees early and consecutively forced; imperfect bud formation, through a deficiency of moisture at the roots or in the air, or lack of support and assimilating power through attacks of parasites, and too crowded a condition of the foliage are fatal.

CHERRY HOUSE—Ventilate early, for no fruit tree dislikes confinement more than the Cherry. Maintain a night temperature of 40°, no more by artificial means, 45° by day in dull cold weather, 50° in mild or sunny, ventilating at 50°, and allowing a rise of 10° to 15° from sun heat with full ventilation, closing at 50°. Syringe the house and trees in the morning and afternoon when the weather is bright, damping occasionally in dull. Trees in pots must have the necessary care in watering.

PINES.—*Fruiting Plants and Starters.*—Afford a mean temperature of 70°, varying it 5° according to external aspects, admitting air at 80° with sunshine, but do not lower the temperature, allowing the heat to rise to 85°, closing at 80°, with a prospect of a slight advance from sun heat. Syringe all available surfaces twice every day, but do not syringe the surface of the bed between the plants. Avoid dense steam produced by syringing highly heated hot-water pipes. Syringe the plants occasionally early in the afternoon when the axils of the leaves become dry.

Plants for Successional Fruiting.—At the commencement of February another supply of Queens should be started to supplement the fruit from those which are already introduced for that purpose. Beds having hot-water pipes beneath them can soon be prepared, but it is not the case where fermenting materials alone are employed for bottom heat, hence the subject is mentioned now so that the matter may be seen to at once, and 85° to 90° of bottom heat secured by the time it is required. When plants which have been kept somewhat drier are to be started see that the balls are made thoroughly moist, so that with the extra warmth root action may commence at once.

Successional Plants.—Maintain a night temperature of 60° to 65°, and 5° less in severe weather, 5° to 10° advance in the day according to external conditions. Keep the plants rather dry at the roots, but not excessively so, and when water is considered necessary give it thoroughly at a temperature of about 80°. Suckers should have a temperature of 55° to 60° at night, and 60° to 65° by day from fire heat, with 10° more from sun heat.

MELONS.—As the seedlings grow add a little warm soil, keeping them near the glass, and look out for slugs. A ring of soot or lime placed round the plants will generally preserve them, but means must be taken to entrap the slugs; they are particularly fond of brewers' grains and moist bran. Soil should be placed under cover, so as to become dried preparatory to forming into ridges or hillocks in the Melon house. Good loam, rather strong than light, is suitable for Melons, and if it has been laid up in ridges so as to reduce the turf it will be in a fit state for the purpose. If deficient in grit add a fifth of road

scrapings, and if not calcareous a similar proportion of old mortar rubbish. If there is need of manure nothing answers so well as horse droppings. The admixture would in that case be four parts loam, one part each of horse droppings, road scrapings, and lime rubbish. For frame culture seed should be sown early in next month. The bed for raising the seedlings should be made forthwith, unless one be made for Cucumbers, which will answer for raising Melons.

RAISING CUCUMBER PLANTS IN FRAMES.—Early February is a good time to start seeds for raising plants to fruit by Easter. The greatest mistake is commencing before the fermenting materials are present in quantity and due preparation to make up and continue the heat in the beds by linings, so as to keep the plants in steady progressive growth. The material for making up the bed for raising the seedlings being in a fit state for turning over and mixing with leaves, so as to induce a sweet regular heat, a site for a bed being chosen with a full southern aspect, and having shelter to the north, as that of a hedge or wall. If the ground be rather higher than the surrounding level all the better. In forming the bed beat the sweetened dung and leaves well down with the fork as the work proceeds, making the bed about 5 feet high at back and 4 feet 6 inches in front, which will allow for settling, as it will do about one-third. A few peasticks placed across and along the bed at intervals not only prevent overheating, but admit the heat from linings being conveyed to the interior of the bed. For early work frames with double sides are preferable, half-inch boards 9 inches less in depth at the back and 6 inches less in front than the box, being secured to the inside, nailing strips of wood an inch wide and thick vertically to the box, then the boards which form an inch cavity all around the inside of the box, which is essential to get top heat from the linings. In about a week from making up the bed the heat will be up. Level the bed, replace the box, apply sufficient manure to raise the inside within 2 or 3 inches of the top of the inner frame or cavity, placing sawdust, dry leaf soil, or spent tan for plunging the pots in. To raise the plants half fill 3-inch pots with rich light loam, placing one seed in the centre of each pot, covering with fine moist soil, so that no water is required for the germination of the seed. Space is thus left in the pots for top-dressing, which is preferable to potting the plants. Cover the pots with a square of glass, which hastens germination, but remove it as soon as the plants appear. The plants from a sowing made early in February will be ready to plant out early in March.

In Houses.—Secure a night temperature of 65°, 5° more in mild weather, whilst it may be 5° less on cold nights, 70° to 75° by day artificially, and 80° to 85° with sun heat. When the external air is mild a little ventilation may be given at 80°, closing before the temperature is reduced below that degree, so as to raise it to 90° or 95°, but if the external air is cold, although the sun shines, it is better to allow the temperature to advance a little beyond the above limits than to admit cold air, which injures the foliage, also causing the fruit to become stunted and to curl at the end. Plants in bearing will require to be examined about twice a week, removing all weakly and exhausted growths, reserving as much of the young bearing wood as is necessary to fill the allotted space, stopping the shoots at one or two joints beyond the fruit. Young plants coming into bearing should not be allowed to bear too soon, and by no means be overcropped. They are greatly assisted by removing the male flowers, also surplus female blossoms as they appear. Let the root and atmospheric moisture be ruled by external influences and condition of the soil, avoiding overwatering, and using liquid manure where vigour is needed. Except on very fine days syringing should not be practised over the foliage, a light sprinkling on fine afternoons being beneficial, damping the floor, &c., moderately at about 8 A.M. and 2 P.M. Encourage the roots to spread on the surface of the bed by adding a little fresh lumpy loam from time to time, with which may be incorporated a little well decomposed cowdung or fresh sweetened horse droppings. Watch for aphides, and fumigate carefully and moderately on two consecutive evenings in preference to once severely. Rub quicklime well into parts affected with canker, and if mildew appear dust with flowers of sulphur.

STRAWBERRIES IN POTS.—Admit air freely when the plants commence flowering, remove the weaker and later blossoms, and when the pollen is ripe brush the flowers over lightly with a feather. After the fruit is set thin them to about half a dozen, more or less, according to the variety. Whilst the fruit is setting 50° to 55° will be sufficient heat artificially, advancing to 60° to 65° with sun heat, but after the setting is effected remove the plants to a house with a temperature of 60° to 65° artificially, and 70° to 75° by day, supplying liquid manure until ripening commences, then apply clear water sparingly. See that successional plants do not require water, and are not brought on too rapidly in the early stages. If there be any trace of aphides fumigate moderately but efficiently, so as to have the plants perfectly clean before they come into flower.

KITCHEN GARDEN.

THE WEATHER.—We have had the most severe December and January experienced for many years. Our open air vegetable crops are holding out better than we anticipated, but they have become so thoroughly frozen that additional severe weather does not make any impression on them. The thaw will try them, as many are sure to become very pulpy soon afterwards. To avert this as much as possible do not be in a hurry to remove any protectors that may be used in the time of the frost, and give additional protection should frost recur, as it is then the harm will be done. Leeks are extremely valuable. The winter Broccoli, such as Snow's, Osborn's, and some others that were

about to form heads, have suffered far more than the later sorts. The former will not be of much use, but the latter may prove as good as ever in April and May.

FORCING.—Where means are at command this must be carried on vigorously. The demand everywhere for forced produce in the spring will be large. Every surplus Seakale, Rhubarb, and Asparagus root should be forced, and as there are still three months before open-air vegetables will be available the roots must be introduced to the forcing house in such quantities as will insure a good succession. Continue to sow abundance of Kidney Beans as previously advised, and force on plants in leaf as fast as is consistent with retaining a fruitful habit.

PARSLEY.—There is a general deficiency of Parsley this winter. Much of it was completely destroyed by the grub last summer. The frost has been much against all exposed plants, and it is only our crop under frames that is still luxuriant. The Parsley seed sown in the open in the spring does not come rapidly forward. The leaves from the first sowing in February or March are rarely ready for gathering until May or June. This will not suit where the supply is deficient at present, and all who can should make up a hotbed. Place a frame on, and place from 9 inches to 1 foot of rich loamy soil on top; sow the Parsley seed broadcast on this, cover with 2 inches of soil, and treat as if the frame contained some early vegetable that was being hurried on for use.

HOTBEDS.—These will now be largely in demand. Secure as much good material as possible to make them. There is nothing better than Beech, Oak and other tree leaves mixed with long littery manure from the stable. Mix these together in about equal parts a fortnight before the bed is required, turning it three or four times weekly. None of the materials should be old or half decayed. Only fresh leaves and manure generate and retain the heat; many cartloads must be mixed together, as it is usually easy to find a site for a hotbed, and there cannot be too many of them.

CROPS FOR HOTBEDS.—The chief of these are Potatoes, Carrots and Radishes. Some of all of these may be planted or sown now. It is too early for the main forcing crops, but a frame full of each may safely be placed in, only a dwarf early Potato should be planted. The hotbed must be ample in depth and well placed together. There should be about 1 foot of moderately rich soil placed on the surface, and the tubers planted in this at a distance of 9 inches apart. Radishes may be grown in 4 inches of soil, but it must be very firm and poor, as in loose, rich soil they run to leaf. Carrots also require a substantial hotbed, as they will be growing for three months, and a deficiency of heat in a few weeks' time would check them and probably cause a failure. We have ceased growing the French Horn as being too short, but grow the English Short Horn as the better of the two. The soil for the Carrots must consist of fine loam, half-decayed horse droppings, and a liberal dash of river or sea sand. The latter is preferable, as it contains much salt and is a preventive of grub. Tread the soil firmly down on the manure, otherwise they will show the same tendency as the Radishes. The general treatment of crops being forced on hotbeds is to provide a little ventilation at the top of the lights on all fine days to allow the steam to escape. Keep the frames constantly closed in bad weather, give ample protection during cold nights, and water very sparingly until growth is luxuriant and the weather genial.

PLANT HOUSES.

Fuchsias.—Plants started some time ago are only just commencing growth. Shake the old soil away from their roots, and place them into smaller pots in a compost of loam, leaf mould, sand, and one-seventh of manure. These must be watered carefully; in fact if damped with the syringe once or twice daily little water will be needed at the roots until they are growing freely. Prune some more plants, and introduce them into a vinery or Peach house just started. Young plants that have been kept growing in small pots may be transferred into 4-inch pots, allowing them a temperature of 50°.

Heliotropes.—Young plants in 2½ or 3-inch pots may be placed into others 2 inches larger, and allowed a temperature of 55° to 60°. In sharp weather do not place them too close to the glass unless the temperature advised can be maintained with certainty.

Zonal Pelargoniums.—Pelargoniums rooted in autumn and now in small pots may be transferred into 4 and 5-inch pots, and placed into gentle heat; they will soon commence growth, and will not be long before they produce bold trusses of flower. Old plants of Vesuvius and Wonderful that flowered early in the winter and have since been kept in good condition, will flower freely again if placed into heat where the atmosphere can be kept moderately dry. Small plants of Ivy-leaved varieties may also be potted.

Primulas.—Those raised from seed sown late and now in small pots may be placed into 60's. They will flower profusely about the end of April, and prove invaluable for the conservatory.

Cinerarias.—Young plants in small pots not showing flower stems may be shifted into larger. Late plants of these are always useful when bulbs and other spring flowering plants are past their best. Give those in various stages that have their pots well filled with roots weak stimulants; soot water in a clear state is very beneficial, and acts upon them quickly.

Hydrangeas.—Where some were rooted with flower buds, and have enjoyed a good season of rest, they may be placed into 4 or 5-inch pots. They will be at home in a vinery or Peach house until they start into

growth, when they must have a light position on a bed of ashes or other moisture-holding material.

Solanums.—If the berries are shrivelling place a few plants in gentle heat to make growths early, which, when large enough, should be taken off and rooted in brisk heat. If rooted together in sandy soil pot them singly directly they are rooted, and pinch to induce them to branch. Cut back plants that are not needed for yielding cuttings. If placed in a vinery they will soon start into growth, when their balls may be reduced and the plants potted in smaller pots in a compost of loam, sand, and one-seventh of manure.

Bouvardias.—Plants that have rested for some time and have been infested with insects may be cut over, and all the old soil shaken from their roots. Take off a few of the strongest roots and cut them into short lengths and place them in small pots, two or three pieces into each. Just cover the roots with soil, and plunge the pots in a box and place them on the hot-water pipes in a vinery or other warm house. The old plants may be placed into smaller pots and started gently into growth. Keep other plants that have done flowering rather dry at their roots, but do not unduly force them to rest.

Kalosanthes.—Plants in small pots that were cut back after flowering, and have broken freely into growth, may be placed into larger pots. Keep them cool and water them carefully. If the latter cannot be attended to potting had better be deferred another month.

THE BEE-KEEPER.

THE HISTORY OF COMB FOUNDATION.

ALTHOUGH I have never said much upon this useful adjunct to the apiary, I think I am entitled to some attention as being the first in Great Britain or America to manufacture it, and not only the first, did so many years previous to most of the living bee-keepers. I have been prompted to take up this subject by the request of a prominent bee-keeper drawing my attention to the following, which appeared in the "B. B. J." for January 1st, 1891. "At the German Department of the Exhibition of 1851 Mr. Neighbour purchased the improved metal plates for making wax foundation, and it was with these that the foundation we used when we first commenced bee-keeping was made—a very different article to what is now used."

It will be observed that there is only one date given which is inaccurate. It was in 1862 that Mr. Alfred Neighbour purchased the plates, and not 1851, although prior to that date the plates were invented and sheets used in Germany. In the summer of 1862 Mr. A. Neighbour sent me, among other things, some of the wax sheets, as they were then termed, asking my opinion on them. A short time after I received the sheets I slipped a piece horizontally beneath the combs of a hive at work, and almost immediately the bees drew out the cells vertically. This was sufficient proof that comb foundation was an acquisition, and I lost no time in making sheets and plates for my own use, the latter within a week, and the former the same night on which the sheets came. At that time, through the articles on bees and poultry in this *Journal* enthusiasm ran high, and were the means of many associations being formed amongst both fanciers and bee-keepers, because often the two went together, if not that of horticulture as well.

I made a visit shortly after that to Stewarton, and formed an acquaintance with all the bee-keepers of that place, taking with me a sample of wax sheet, but no one except Mr. A. Ferguson, a noted bee-keeper, could guess what it was, and he was anxious to learn more about it. On telling him I had made the piece he held in his hand, it being an easy matter to do so, an audience with me at my home was asked for and granted, so that he might learn the process. Previous to this all manipulations with wax were done in my heated workshop. The lesson was given in the kitchen; the night being frosty soon hardened the sheets, and for the first time failed to impress them, which provoked a hearty laugh from pupil at the now crestfallen tutor. I soon learned the cause, and the second attempt was a success, being the best lesson I had on making comb foundation.

For a time no other sheets were manufactured but by myself.

Mr. Ferguson, being corresponding with Mr. Woodbury at that time, learned from him that he had attempted to make sheets by painting wax upon brown paper, then steeping the sheets in water, and peeling the paper from the wax while pulpy. On learning this I wrote to ask Mr. Neighbour if he knew better. His reply was that they had tried the making, but failed to produce a marketable sheet, on account of being unable to secure good wax, but would be obliged for further information. I sent him full instructions, and in return was sent the original German plates, which Mr. Cowan says were "the first sheets he used were made from." Between 1862 and 1874 comb foundation and the plates for making it were in the hands of many Scotch bee-keepers, all of them indebted to me. But in England I am not aware of a single bee-keeper, except Messrs. Neighbour, who made sheets, and I am inclined to think that firm preferred purchasing rather than making.

At the first exhibition in the Crystal Palace, 1874, Messrs. Neighbour exhibited a pair of stereotyped plates, which were claimed by someone with the view of depriving Mr. Neighbour of the power of making sheets, and so monopolise the business, but "he did not reckon with his host." Neighbour's people had others; besides, the person found out to his cost that more than plates were wanting, so it proved a failure. Seeing the great advantage of comb foundation for the first time, Mr. Abbott was anxious to be in possession of the great invention, and after failing to get them or the information how to make sheets he appealed to me. I laid his case before Mr. Neighbour, and he at once supplied him with a pair of plates, and some of your readers know in what spirit the kindness was returned. But the plates without the knowledge of making sheets, &c, were of no use. A second appeal was made to me, and I gave Mr. Abbott the wrinkle. But I never saw an English made sheet equal to Scotch made ones, and at one of this subject was of general comment. While the Scotch sheets were perfect to a cell and hung straight in the frames, the English made were twisted and perforated throughout, and this is where the great difference came in, and not as Mr. Cowan has it, because of any alteration or improvement over the first method of producing.

From the first I made sheets with the full impression of the cell, and before America made the improvement Mr. Ferguson and myself had it in contemplation; and while I admit that the side wall is a great improvement, it is in most cases nothing more than the impression of the base with by far too thick a midrib for use in the apiary. I send herewith two samples of comb foundation, No. 1 my own make, the other procured from an advertiser. The side walls of No. 1 you will observe are high, with a thin midrib, while the other has a very thick midrib with scarcely a side wall visible, is of inferior wax, and a much inferior foundation to that made from the original plates. I may as well mention that I do not sell foundation made from native wax, as I can if I cared get 3s. per pound for all my genuine wax, but I require it for my own use. Neither do I manufacture foreign wax, only in a few instances. I make sheets for friends, so that the sending of the specimens is not as an advertisement, but to show bee-keepers what they should aim at, and what they can believe. I have never witnessed a sample of comb foundation with side walls so deep as the sample forwarded, and of all the times I ever competed only once lost the prize, but was not beaten.

Bee-keepers should endeavour to make their own foundation. High side walls secure perfectly straight and symmetrical combs, and a sure preventive of sagging or huckling, and dispenses entirely with wire, a clumsy and unnatural contrivance at the best.

The same remarks apply to thin foundation as to thick sheets. With a high side wall and thin midrib beautiful, straight, and symmetrical combs are secured, and dispenses entirely with the even more unnatural and clumsy method of using separators, which flat-bottomed sheets demand. The bees make an effort to

transform the flat bottom of the cell into a natural one, and being hampered for room between it and the separators cluster together more than usual, press the foundation out of the plumb, hence the twisted and irregular combs of sections and supers. But as I dislike inferior wax and improperly made sheets, so do I full sized sheets in receptacles intended for comb honey. In order to get the most satisfaction I would urge all bee-keepers to preserve their own wax, and get appliances to manufacture their own foundation.

Although some manufacturers assert they possess secrets I do not believe it, and if any reader of this paper wishes to be in the best position as an apiarist, I will give him information that the world knows not of. As I have extended this paper more than I intended, I must defer some further hints and replies to other inaccuracies as pointed out by several correspondents in the "B. B. J." relative to carbolic acid.—A LANARKSHIRE BEE-KEEPER.

[The sample of No. 1 comb foundation referred to is in every respect superior, the other being worthless in comparison.—ED.]

TRADE CATALOGUES RECEIVED.

John Green, Norfolk Nurseries, Dereham.—*Annual Guide.*

Samuel Yates, 75, Shudehill, Manchester.—*Catalogue of Garden and Farm Seeds.*

J. R. Tranter, 3, Hart Street, Henley-on-Thames.—*Catalogue of Vegetable and Flower Seeds.*

Ryder & Son, Sale, Manchester.—*Garden Manual for 1891.*

Daniels Bros., Norwich.—*Illustrated Guide for Amateur Gardeners.*

J. R. Pearson & Sons, Chilwell, Nottingham.—*Catalogue of Garden and Flower Seeds.*

Thomas S. Ware, Hale Farm Nurseries, Tottenham.—*Catalogues of Vegetable and Flower Seeds, Gladioli, Begonias, Dahlias, and Chrysanthemums.*

Thames Bank Iron Company, Upper Ground Street, London, E.C.—*Illustrated Trade List.*

Hogg & Wood, Coldstream, N.B.—*List of Vegetable and Flower Seeds.*

W. B. Rowe & Co., 65, Broad Street, Worcester.—*Catalogue of Vegetable and Flower Seeds.*

W. F. Gunn & Co., 3, Stockton Road, Sunderland.—*Seed Catalogue.*

Henry Eckford, Wem, Salop.—*Spring Catalogue of Vegetable and Flower Seeds.*

Austin & McAslan, 89, Mitchell Street, Glasgow.—*Catalogue of Vegetable and Flower Seeds.*

Wm. Clibran & Son, 10 and 12, Market Street, Manchester.—*Catalogue of Vegetable and Flower Seeds.*



All correspondence should be directed either to "THE EDITOR" or to "THE PUBLISHER." Letters addressed to Dr. Hogg or members of the staff often remain unopened unavoidably. We request that no one will write privately to any of our correspondents, as doing so subjects them to unjustifiable trouble and expense.

Correspondents should not mix up on the same sheet questions relating to Gardening and those on Bee subjects, and should never send more than two or three questions at once. All articles intended for insertion should be written on one side of the paper only. We cannot reply to questions through the post, and we do not undertake to return rejected communications.

Books (C. S.)—By far the best work on Conifers is prepared and published by Messrs. J. Veitch & Sons, Royal Exotic Nurseries, Chelsea; but it does not describe methods of propagation. In respect to the other work you require, we do not know that there is anything of the kind published; and it is doubtful if the information you need can be acquired from books alone by any man, however intelligent he may be.

Painting Hot-water Pipes (Inquirer).—A mixture of lampblack and linseed oil is usually employed for this purpose, first scouring the rust off the pipes, then rubbing the mixture in with a piece of sacking or a brush. Heat gently and dry steadily, then no harm will be done to the occupants of the house.

Annuals for Cutting (Cut Flowers).—In addition to Asters, Stocks, Zinnias, Godetia, Mignonette, Marigolds, Phlox, and Chrysanthemums, the following are useful, affording a quantity of flowers. Cornflower (*Centaurea cyanus*), New Miniature Sunflower, Sweet Sultan, yellow, white, and purple varieties; *Dianthus chinensis* (Indian Pink), Branching Larkspur, *Eschscholtzia crocea*, Candytufts, crimson, purple, and white; *Nigella*, *Bartonia aurea*, Shirley Poppies (must be cut young); *Malope grandiflora*, *Convolvulus minor tricolor*, Scabious (dwarf double); *Lupinus nanus*, *Centaurea cyanus*, double, and Sweet Peas in great variety. Mr. Wright's "Profitable Fruit Growing," can be had from the office of the *Journal of Horticulture*, post free, 1s. 3d.

Orchid Culture (Constant Subscriber).—You have no doubt made a mistake by placing all the plants in the stove, and that alone would account for the unhealthy condition of some of them, though you do not say which are the worst. The *Cattleya*, *Cymbidiums*, *Cypripediums*, and *Lycaste* should remain in the cooler part of the stove, and will require very great care in the supply of water at this time of year. The others would be better in a house where the temperature is as nearly equable as possible, not falling below 50°. If they do not appear satisfactory when finer weather comes, turn them out, examine the roots, and repot in fresh material if the old compost is much decayed, or the roots are not taking to it freely. You will find much general information upon the subject of potting and the treatment of your plants in Castle's "Orchids," post free from this office 1s. 2½d.

Pomme Grise Apple (Lincoln).—The "small uniform sized and evenly shaped russet looking Apples" which have attracted your attention in London fruit shops are of the above variety imported from the other side of the Atlantic. The variety is correctly described as follows by Dr. Hogg in his *Fruit Manual*:—Fruit, small, 2 inches wide, and 1½ inch high; roundish and inclining to ovate. Skin, rough, with thick scaly russet, green in the shade, and deep orange on the side next the sun. Eye, small and open, set in a narrow and shallow basin. Stalk, about half an inch long, inserted in a shallow and small cavity. Flesh, yellowish, crisp, very juicy and sugary, with a brisk and highly aromatic flavour. A dessert Apple of first rate quality; in use from October to February. The tree is rather a weak grower, but an abundant bearer.

Mixing Sulphate of Iron with House Sewage (H. B.).—House sewage on account of the urea contained in urine emits a disagreeable odour, due to the conversion of the urea into ammonium carbonate, a very volatile compound. Mixing iron sulphate with sewage converts the ammonium carbonate into a double sulphate of ammonium and iron, which is non-volatile. To entirely "fix" the ammonia requires more iron sulphate than can with safety be applied to fruit trees frequently watered with the sewage. It may, however, be usefully employed in "fixing" the ammonia, whereby some of the offensive odour of the sewage would be taken away, whilst its value as a fertiliser on the score of ammonia alone would be greatly increased. Iron sulphate at the rate of 1 lb. to 20 gallons of water may be used for mixing with sewage at the rate of one-fifth, or 1 lb. iron sulphate to 100 gallons of sewage, and is safe for application to garden crops as generally employed; but for such uses as those to which you put the sewage it would be necessary to have the iron sulphate very much more diluted. For fruit trees in pots, on account of the frequent waterings, it would be necessary to have the iron sulphate considerably weaker than that named. By using 1 lb. iron sulphate in flushing the drains each time, or that quantity to the 400 gallons of sewage, the latter would be perfectly safe for all purposes, and very much increased in value as a fertiliser, also less offensive.

Fungus on Orange Trees (Inquirer).—No doubt the fungus to which you allude is *Capnodium Citri*, which infests Oranges, Lemons, and allied plants. The following account of the genus *Capnodium* was given by the late Rev. M. J. Berkeley in the "Treasury of Botany"—"A curious genus of fungi established by Dr. Montagne to receive a portion of the black smutty parasites which infest the leaves and twigs of shrubs in damp warm climates. It belongs to the division Ascomycetes, and is characterised by the abundant creeping black threads which run over the several parts of the plants which it attacks. Shoots from these threads either invest the fruit or are combined to form it. The fruit consists of irregular often elongated and branched cysts, which in the same species contain naked spores, and sporidia enclosed in asci. Two species belong to the British flora: *C. Footii*, found on Laurel leaves; and *C. elongatum*, in the extreme south-west, on Pear trees. Others are the plague of Coffee, Lemons, Olives, and other important plants. In a young state these plants are not distinguishable from *Antennaria*. The stomates of the plants they attack are completely smothered, and direct light almost excluded, so that the functions of the leaves are greatly impeded. No remedy is known when the parasite is once developed. If any is applied it must be directed to the destruction of the different species of coccus on whose excretions these fungi seem mostly to be developed. Lemons frequently arrive in this country in an unsaleable condition, incrustated more or less completely

with a jet black felt, in consequence of the growth either of an Antennaria or the spawn of Capnodium Citri, which seems to increase greatly after the fruit is packed up for the market." It may be prevented by the application of a fungicide, which we suspect you know how to prepare and apply.

Chimonanthus fragrans in Pots (S.D.).—We have flowered the Chimonanthus in a pot, but it requires a very large one, good loam, with a little peat, plenty of water in summer, and a warm sunny place in the autumn, and the water to be reduced then to harden the wood. It requires much the same culture as a spurred Currant tree would do, only that the young stubby shoots are what must be looked after and prepared for winter. If a plant has several stems now, and they are bristling with short shoots, these may all be cut in to a bud in the end of March. Ere long they will push. If the shoots come strong pinch them back, so as to obtain two instead of one. If the shoots produced are of the size of from a crowquill to a goosequill they will be quite strong enough, and if these side shoots grow longer than from 8 to 10 inches nip out the points. If the shoots are too thick to obtain light enough thin them out. Give all the heat possible out of doors in autumn, and as much dryness as the plants will stand, to ripen the shoots. If the plants must stand out in winter protect the roots with litter. As the soil becomes damp and the weather is mild the buds will expand. When done flowering prune as before.

Constructing an Ice-stack (J. Prince).—The following is the plan for which you ask as adopted by the late Mr. Beaton. "It must be made sugar-loaf fashion. When the site is on level ground, the carts must be emptied so near to the cone that the ice when broken can be conveniently thrown on with shovels, and then two or even three places round the cone may be used for breaking the ice; but the easiest way is, when the ground or site is on the face of a bank, or at the bottom of a gravel or chalk pit, as in that way the carts may be emptied on the top of the bank, the ice broken there, and then thrown down the bank, so as to empty itself on the cone at once. At Shrubland a natural hollow was chosen for the site of the iceberg, and the bank on one side made steep; and at 6 feet from the bottom of the bank was the outside of the cone when it was finished. Some such space is necessary between the bank and the ice, to get rid of rain or snow-water running down the bank before it gets to the ice. At the bottom of the bank, and half way up, posts were let into the ground in pairs, 4 feet apart, and braced together with a strong piece of timber set across, as builders do their scaffolding; then the garden planks for wheeling on were made into a long trough, inclining from the top of the bank, and resting on those cross pieces; the bottom of the trough being carried out to near the centre of the cone, and far above it; the ice was broken on a platform of boards at the top of the bank, and thrown into the inclined trough, and it slid down just over the cone. A set of men were put on the cone to distribute the broken ice as it fell from the spout, and one of them was the master builder: he saw the cone brought up regularly; and when the ice reached the height of the bottom of the spout, the planks were rearranged so as to allow room for throwing off the ice as fast as it came down; and finally, when the cone was finished into a sharp point, the whole was left till the first frost after mild or thawing weather. And the reason is this: As soon as it turns to rain or thaw, the outside of the iceberg begins to melt a little, and sometimes it remains so for three weeks, but on the first hard frosty night the whole is frozen over again, and the outside of the cone is then as if it were one solid face of rugged ice; then is the time to thatch it with good long straw, and about the same thickness as you would a Wheat or Barley stack, and no more, provided you have cheaper materials to give it a good thick covering afterwards. At Shrubland they used large quantities of leaves, and nothing else, over the straw; throwing it on at intervals, so that the leaves did not heat by putting too many on at once. The depth of covering over the straw was sometimes twice as much as in other seasons, according to the quantity of leaves on hand, but 2 feet in thickness does not preserve the ice better than 1 foot. The ice was never uncovered by high winds blowing off the leaves, and never was anything put on or against them to keep them down. Perfect exemption from wet or damp is necessary for the bottom of an ice-heap; and a few pieces of rough wood, put on such a place, and covered with brushwood about 1 foot, and that again covered with 6 inches of straw, is the way. The brushwood and straw are soon compressed into a few inches in thickness by the weight of the ice; and as the ice melts, the water passes through, without hindrance, into cross open drains previously made at bottom."

Names of Fruits.—The names and addresses of senders of fruit to be named must in all cases be enclosed with the specimens, whether letters referring to the fruit are sent by post or not. The names are not necessarily required for publication, initials sufficing for that. Only six specimens can be named at once, and any beyond that number cannot be preserved. (J. L. Hobbes).—The Apple is Court of Wick. (J. P.).—1, Dumelow's Seedling; 2, Bedfordshire Foundling; 3, Alfriston; 4, Scarlet Nonpareil; 5, Wyken Pippin; 6, Norfolk Beefing. (J. Jackson).—1, Swan's Egg; 2, Nec Plus Meuris; 3, Beurré Rance. 4, Easter Beurré. (F. T.).—The Grape is the Black Alicante, and has no comparison in quality with Mrs. Pince.

Names of Plants.—We only undertake to name species of plants, not varieties that have originated from seed and termed florists' flowers. Flowering specimens are necessary of flowering plants, and Fern fronds

should bear spores. Specimens should arrive in a fresh state in firm boxes: Slightly damp moss, soft green grass or leaves form the best packing, dry wool the worst. Not more than six specimens can be named at once, and the numbers should be visible without untying the ligatures, it being often difficult to separate them when the paper is damp. (S. B.).—1, Cypridium hirsutissimum; 2, Cypridium insigne-Maulei; 3, Cypridium venustum; 4, Lælia albida; 5, Lælia anceps. (J. M. T.).—1, Nephrodium molle; 2, Asplenium cicutarium; 3, Lomaria discolor; 4, Oclontoglossum Rossi majus. (Guernsey).—Æschynanthus fulgens.

COVENT GARDEN MARKET.—JANUARY 21ST.

The market is unaltered.

VEGETABLES.

	s. d.	s. d.		s. d.	s. d.
Artichokes, dozen	0 0	to 0 0	Mushrooms, punnet	1 6	to 2 0
Beans, Kidney, per lb. ..	0 9	1 0	Mustard & Cress, punnet	0 2	0 0
Beet, Red, dozen	1 0	0 0	Onions, bushel	3 0	4 0
Brussels Sprouts, ½ sieve	2 6	3 0	Parsley, doz. bunches ..	2 0	3 0
Cabbage, dozen	1 6	0 0	Parsnips, dozen	1 0	0 0
Carrots, bunch	0 4	0 0	Potatoes, per cwt.	3 0	4 0
Cauliflowers, dozen	2 0	4 0	Rhubarb, bundle	0 2	0 0
Celery, bundle	1 0	1 8	Salsafy, bundle	1 0	1 6
Coleworts, doz. bunches ..	2 0	4 0	Scorzoneria, bundle	1 6	0 0
Cucumbers, doz.	2 0	3 6	Seakale, per bkt.	2 0	2 6
Endive, dozen	1 0	0 0	Shallots, per lb.	0 3	0 0
Herbs, bunch	0 2	0 0	Spinach, bushel	5 0	6 0
Leeks, bunch	0 2	0 0	Tomatoes, per lb.	0 4	0 8
Lettuce, dozen	0 9	1 3	Turnips, bunch	0 0	0 4

FRUIT.

	s. d.	s. d.		s. d.	s. d.
Apples, ½ sieve	1 6	to 6 0	Lemons, case	15 0	to 24 0
" Nova Scotia and			Melons, each	0 0	0 0
Canada, per barrel	15 0	26 0	Oranges, per 100	4 0	9 0
Grapes, per lb.	0 9	3 0	St. Michael Pines, each..	2 0	6 0
Kentish Cobs	55 0	60 0	Strawberries, per lb. ..	0 0	0 0

AVERAGE WHOLESALE PRICES.

CUT FLOWERS.

	s. d.	s. d.		s. d.	s. d.
Arum Lilies, 12 blooms ..	4 0	to 12 0	Mimosa (Fench.) per bch	0 0	to 2 0
Bouvardias, bunch	0 6	1 6	Narciss (Paper-white),		
Carnations, 12 blooms ..	1 0	2 6	French, doz. bunches ..	12 0	18 0
Chrysanthemum, 14 blms.	1 0	3 0	Do. Do. English,		
" 12 bunches	3 0	9 0	per bunch	1 0	1 6
Epiphyllum, doz. blooms	0 4	0 6	Pelargoniums, 12 trusses	1 0	1 6
Eucharis, dozen	3 0	6 0	" scarlet, 12 bunches	6 0	9 0
Gardenias, each	2 0	3 0	Poinsettia, dozen blooms	3 0	9 0
Hyacinths (Roman), doz.			Primula (double) 12 sprays	0 6	1 0
sprays	0 6	1 6	Roses (indoor), dozen ..	0 6	1 6
Lapageria, 12 blooms ..	2 0	4 0	" Red, 12 bls. (Fench.)	1 0	2 0
Lilac (French) per bunch	6 0	9 0	" Tea, white, dozen ..	1 0	3 0
" longiflorum, 12 blms.	4 0	6 0	" Yellow, dozen	2 6	15 0
Lily of the Valley, dozen			Tuberose, 12 blooms ..	0 4	0 9
sprays	1 3	1 6	Tulips, per dozen	1 0	2 0
Maidenhair Fern, dozen			Violets (Parme), per bch.	6 6	9 6
bunches	4 0	9 0	" (dark), per bch. ..	2 0	3 6
Marguerites, 12 bunches	2 0	6 0	" (English), doz. bch	1 0	2 0
Mignonette, 12 bunches..	3 0	6 0	Wallflower, doz. bunches	3 0	6 0

PLANTS IN POTS.

	s. d.	s. d.		s. d.	s. d.
Aralia Sieboldi, dozen ..	6 0	to 12 0	Hydrangea, doz. pots ..	9 0	to 18 0
Arbor Vitæ (golden) doz.	6 0	8 0	Lilium lancifolium, doz.	0 0	0 0
Chrysanthemum, per doz.	6 0	24 0	" longiflorum, doz.	0 0	0 0
Climbing Plants, various,			Lily of the Valley, per pot	4 0	6 0
dozen pots	4 0	9 0	Lobelia, per doz.	0 0	0 0
Dracæna terminalis, doz.	24 0	42 0	Marguerite Daisy, dozen	6 0	12 0
" viridis, dozen	12 0	24 0	Mignonette, per dozen ..	4 0	6 0
Epiphyllum, per dozen ..	12 0	30 0	Musk, per dozen	0 0	0 0
Erica, various, dozen ..	12 0	18 0	Myrtles, dozen	6 0	12 0
Euonymus, var., dozen ..	6 0	18 0	Nasturtium, dozen pots	0 0	0 0
Evergreens, in var., doz.	6 0	24 0	Palms, in var., each ..	2 6	21 0
Ferns, in variety, dozen..	4 0	18 0	Pelargoniums, per doz. ..	0 0	0 0
Ficus elastica, each ..	1 6	7 0	Poinsettia, per doz. ..	9 0	15 0
Foliage plants, var., each	2 0	10 0	Rhodanthe, per dozen ..	0 0	0 0
Fuchsia, per doz.	0 0	0 0	Stocks, per doz.	0 0	0 0
Geraniums Scarlet, p. doz.	2 0	6 0	Tropæolums, various, per		
Hyacinths (Roman), doz.			dozen	0 0	
pots	8 0	10 0	Tulips, dozen pots	8 0	12 0



INFORMATION FOR EMIGRANTS.

OUR advice has occasionally been sought by would-be emigrants as to the best country to go to in search of that prosperity which they had failed to find here, and we have invariably striven to

impress upon them the fact that a settler's life in any new country is beset with hardships, that they must go out prepared to work harder than they had ever done here, and to rough it all round. If they were prepared to do this, and were young, vigorous, and healthy, with plenty of energy and "go" about them, they might earn a decent wage part of the year upon the land, but beyond that their future must necessarily be beset with much grave uncertainty.

It was not without a feeling akin to pity that we discussed the matter with our last applicant—a well educated gentlemanly young fellow, who, with his young wife, thought of going out to Canada next spring. He had some means, thought of acquiring a farm out there, and in view of this he came to us last autumn to "pick up some knowledge of farming!" In answer to our remonstrance at the too evident folly of such a proceeding he replied that he had well considered the matter, and his inquiries had shown him that farming out west was a much more simple matter than it was in this country. Like so many others he evidently thought the colonies a sort of Eldorado, where prosperity was assured and success a certainty, where the virgin soil was so rich in pristine fertility that little if any of the care and pains of soil tillage in this country were called for there. Well, his was a case apart from that of an ordinary emigrant, and we must not forget that it is for the benefit of such we are writing.

To all such we say, Be careful in the selection of a new country, and first send for handbooks to the Emigrants' Information Office, 31, Broadway, Westminster, London, S.W. You will then learn that there is no demand for men in Canada in winter. By the end of March or early in April there may be work for farm hands, carpenters, bricklayers, and masons; and female servants are always in demand. In Australasia men well trained in husbandry, especially in sheep shearing, but also all kinds of farm work, the cultivation of fruit trees, nursery work, gardeners, dairymen, handy men, female servants, miners, navvies are in request, and there is a demand for farmers there. Under certain conditions such persons get free or reduced passages to Queensland and Western Australia. In South Africa farmers, farm labourers, and female servants are in demand in Cape Colony and Natal, to which places free or reduced passages may also be had under certain conditions.

It appears, therefore, advisable to give preference to either one or other of the colonies named, and to avoid doubtful countries, especially some of the States of America, where it has for some time been notorious that farmers were suffering from the agricultural depression, and the report is true enough. How true we were not aware till we received direct information from an old settler in one of the States. He was brought up on the land as the working son of a working farmer. He emigrated soon after he was twenty-one years of age, and is now getting on to sixty, and has been struggling for bare subsistence all the time. He has now a farm of 230 acres in Wisconsin at a rent of 12s. to 16s. an acre, with (when he wrote several months ago) Oats at 8½d. per bushel (now higher), pork at 14s. per 100 lbs. (now lower), and all other farm produce so cheap that as he says, "It is all we can do to make our rent, and nothing for ourselves." What say you to this, Mr. British Farmer, with your rent down to 15s. an acre, and your Oats, if a good sample, worth 3s. a bushel? Well might our informant say that England is a Land of Goshen in comparison.

A brother of this struggling settler has just come home with an independency, acquired in a manner which shows how great the necessity of the States farmers really is. He went out twenty-one years ago as a hard-working blacksmith, saved a little money which he commenced lending to the needy farmers at an average interest of 8 per cent., and so gradually "made his pile." He says that nine out of ten farmers mortgage their crops and live stock (which is called chattel mortgage), settle up when they sell, and then borrow again, thus being virtually

always on the brink of bankruptcy, for a bad season would probably ruin many of them. The method of borrowing is in this wise:—No debt is legal unless entered in the books of a public notary, which are open to the inspection of lenders, so that it is easy to see how borrowers "stand." The farmer makes known the sum he wants, the lender sees his crop and stock, then both go to a notary; the transaction is officially entered, the borrower paying half a dollar or a dollar, and the thing is done. No attempt is made to keep the matter secret. So long as a borrower has a reputation for "paying up" he stands just as well in public estimation as the lender.

In favourable districts in California enterprising, industrious, competent men, not without money, have found fruit culture profitable. Mr. Leonard Coates for instance, and Mr. Burnett, we are glad to observe, appears to see a promising future before him. But such men are far above the average in ability and resources to the general class of emigrants, who appear to think fortunes are to be made on farms in the land of the west.

WORK ON THE HOME FARM.

In addition to work mentioned in our last note some extra care has been required with crop and stock. With so little snow and such sharp frost it became absolutely necessary to use extra protection for roots in heaps, and a thick covering of rough litter was placed over every heap. Some heaps in outlying fields were covered with gorse, of which plenty was to be had close at hand, and in another instance a quantity of fine brushwood faggots made for the lime kilns were used for the same purpose. We always like to turn all such rough and ready means to account—anything to avoid using good straw. We have had to use some of that, though, for the roots had to be saved from frost at any cost, and those farmers who are crying out about damaged roots simply proclaim their incompetence or poverty of means.

As hedging and ditching is done field gates are all carefully examined and any necessary repairs done, spurs being put to decaying gate posts, rough timber sills placed just under the surface where necessary to give stability to the posts, and prevent the gate dropping and dragging. Any faulty fastenings are repaired, and, if necessary, a coat or two of tar or paint given to gate and posts. Attention to this at this season of the year tends to keep the gates in sound working order. We never permit any gate near a public footpath to remain unlocked, but have an easy stile or wicket through which stock cannot pass close by for public convenience, all risk of gates being left open being thus avoided.

In order to retain good men upon the farm it is a good plan to allow them to thrash corn on the barn floors by hand in such weather, when they are not wanted upon the land. They are made clearly to understand that the corn must be threshed, screened, and measured into sacks at the same rate of cost as we can get it done by the steam thresher. They can then earn a very fair wage by working hard, to the mutual advantage of master and man. When a farmer is so considerate he is easily able to secure the services of steady able men, and it is much better so than to have to take on inferior men at the busy season of the year.

METEOROLOGICAL OBSERVATIONS.

CAMDEN SQUARE, LONDON.

Lat. 51° 32' 40" N.; Long. 0° 8' 0" W.; Altitude, 111 feet.

DATE.	9 A.M.					IN THE DAY.				Rain
	Barometer at 32° and Sea Level.	Hygrometer.		Direction of Wind.	Temp. of soil at 1 foot.	Shade Temperature.		Radiation Temperature.		
		Dry.	Wet.			Max.	Min.	In sun.	On grass	
1891. January.										
Sunday	30.719	21.0	20.8	N.	32.9	25.4	16.9	28.9	12.5	—
Monday	30.674	25.2	24.8	N.W.	32.9	41.9	19.7	48.2	14.2	—
Tuesday	30.448	39.4	39.4	N.E.	32.9	41.2	25.1	43.2	24.3	—
Wednesday ..	31.586	36.9	34.0	N.W.	32.9	40.1	34.7	65.1	29.4	—
Thursday	30.503	30.9	29.8	N.	32.9	37.9	29.3	55.3	26.2	0.082
Friday	30.102	31.3	30.4	N.	32.9	34.1	30.4	58.3	28.6	0.010
Saturday	30.318	26.1	25.5	N.	32.9	29.7	23.2	47.8	19.4	0.010
	30.507	30.1	29.2		32.9	35.8	25.6	49.5	22.1	0.102

REMARKS.

11th.—Low temperature and smoke fog all day.
 12th.—Fine, with occasional sunshine. Thawing.
 13th.—Overcast and mild day; foggy early.
 14th.—Fine and bright throughout.
 15th.—Clear, with frequent sprinkles of snow or sleet in morning; sunshine at midday; cloudy afternoon. About an inch of snow in evening, and thawing from midnight to 6 A.M. on 16th.
 16th.—Frequently bright, but occasional flakes of snow and a sharp sleet shower at 10.30 A.M.
 17th.—Fine and bright till 10 A.M., then overcast with snow showers; fine afternoon with some sunshine.
 In spite of the relative warmth of the 12th to the 14th we have another (the sixth consecutive) week with a mean temperature below that of freezing point.—
 G. J. SIMONS.

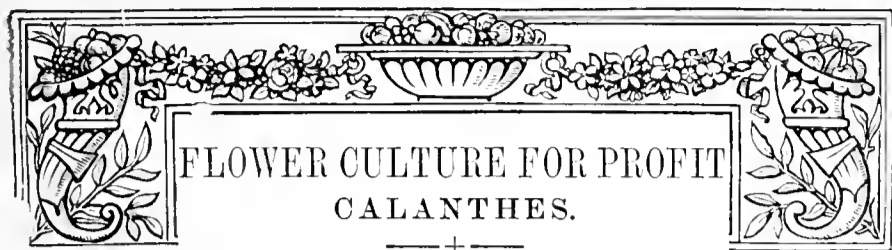

FLOWER CULTURE FOR PROFIT
CALANTHES.

THESE are not often cultivated for sale in a cut state, yet they pay well. This winter, owing to the great scarcity of other flowers, *Calanthes* have been more appreciated than usual, a better price for the spikes being the outcome. Florists frequently inquire for flowers with long stems, and if in addition they keep well after they are cut their value is considerably enhanced. The fact of *Calanthes* combining these good qualities, also being members of the great Orchid family, adds to their charm, and altogether I am strongly of opinion there will be a great demand for them as their merits become better known to the buyers and retailers of cut flowers. They are particularly to be recommended for culture in those private gardens where flowers for buttonhole bouquets and ladies' sprays are in great request. The white, or nearly white flowers, are admirable for the former purpose, and very elegant sprays can be made of the *C. Veitchi* forms. Hundreds of single flowers can be detached from a fairly large number of spikes without affecting the market value of the latter in the least. In fact, the spikes ought not to be cut before the flowers at the point are nearly or quite expanded, and by that time many of the lower flowers on long and moderately long spikes would, if not used, have faded badly. Nor is there any gain in growing extra fine spikes, but, on the contrary, it pays better to allow each pseudo-bulb to form two or three medium-sized spikes rather than one from 3 feet to 4 feet in length.

If we except one or two varieties of recent introduction, the most valuable of the winter flowering *Calanthes* will be found in *C. vestita lutea*, the spikes and single blooms of this variety being well adapted for making into hand and other bouquets, sprays, wreaths, and crosses, and the best of them fetch from 9s. to 12s. per dozen, the smaller sizes realising 6s. per dozen. *C. vestita oculata* is not so valuable, though well worthy of extended cultivation. The spikes of this and either of the three forms of *C. Veitchi* fetch from 6s. to 9s. per dozen spikes, and seeing that at least six spikes can be obtained from three moderately strong bulbs in a 6-inch or rather larger pot, the profitableness of *Calanthes* is very evident.

Increasing the stock of pseudo-bulbs is not such a slow progress as might be imagined by the inexperienced, a good supply of *C. Veitchi* being raised comparatively quickly; but the short thick pseudo-bulbs of the *vestita* type are certainly more difficult to increase. There are several points so to speak on the long *Veitchi* pseudo-bulbs, and if cut into lengths each would form a growth, which would under favourable conditions develop into a good sized pseudo-bulb. We prefer the slower method of snapping the pseudo-bulbs in two, the upper part forming a moderately strong growth, while two or more stout growths would be obtained from the lower half, or nearly as good as though the pseudo-bulb had been left intact.

Trebling the number of pseudo-bulbs each year is not bad progress, but when our stock was insufficient the old pseudo-bulbs were not thrown away as being of no further value, but were set rather thickly in pans filled with light peaty compost and kept in heat. The greater part of old ones thus treated form a young growth from their base, and being potted off when the roots are about 2 inches long serviceable bulbs eventually result. We never cut or break up the pseudo-bulbs of *vestita*, but strong ones will

form two or more shoots the season after flowering, and frequently another if taken good care of in the following spring.

It may sound somewhat strange, but it is true nevertheless, that the cultivation of *Calanthes*, say to flower next winter, ought to commence from the flowering period this winter. A few days in a well heated living house will do them no harm, but on no account ought the plants to be placed for any length of time, either when in or out of flower, in a cool conservatory or greenhouse, or the consequences to the bulb may be nearly or quite fatal. Not only is a moderately warm house, or say one which seldom falls below 55° during the night or often exceeds 65° in the daytime, the safest place for the bulbs, but the flower spikes also open and last much the longest under this treatment. After the foliage is dead and removed little or no water ought to be given, and the plants must also be kept in heat and quite dry during the resting period. If preferred they can be shaken clear of the old compost, have their old roots lightly shortened, and then be rather closely but not deeply packed together in pans or boxes of light peaty soil, there to remain till shoots and roots are formed. This plan answers well if the final potting-off is not delayed till the roots are become interlaced, in which case they cannot be separated without injury to them. Ours are usually left in their flowering pots till they have made shoots about 2 inches long with a cluster of short roots attached, when they are carefully separated from the old soil and at once repotted.

Opinions vary as to the best compost for *Calanthes*, and to this difference of opinion many failures are to be traced. A free use of loam is recommended by some authorities—the majority probably—and with all due respect to said authorities I yet maintain that loam ought not to be so generally and freely employed in the compost. Light loam full of fibre doubtless will grow them well; but not one gardener in a hundred can procure this, and a loam void of fibre, or any containing a slight per-centage of clay, is nearly fatal to *Calanthes*. What never fails with us is a mixture consisting of two parts brown fibrous peat in lumps to one each of sifted horse-droppings, chopped sphagnum moss, charcoal, and broken crocks, the two last somewhat coarse. Even with such a porous compost as this it is advisable to nearly half fill the pots with drainage. What is wanted is a potful of roots as quickly as possible, after which they may safely be fed with liquid manure. It is almost needless to add the pots should be clean, those fresh from the potteries being avoided, as robbing the compost of the little moisture necessary.

A 4-inch pot is large enough for a single pseudo-bulb of the *vestita* type, and a 5-inch pot would do for a good-sized one of the *C. Veitchi* varieties, these sizes being useful for house decoration. When required to afford cut blooms only the best plan is to place three or four in a 6-inch pot, and about five in a 7-inch or 8-inch pot. By growing *C. Veitchi* singly in 6-inch or rather larger sizes it is possible to have pseudo-bulbs from 9 inches to 12 inches in length, and with proportionately long spikes; but we want neither the one nor the other. In potting, nearly fill the pots with compost, this being previously well warmed by means of hot bricks placed in the centre of the heap. Make this firm, and carefully fix the pseudo-bulbs, or so as not to injure the young roots, the base being just below the surface. The old roots being only shortened serve to steady the plants.

Many succeed all right, or follow the right lines up to this point only to err in their choice of site for the pots. Ordinary plant stages will not suit them, nor do they often succeed well when interspersed among other Orchids. They can best be grown on shelves of well heated houses, and near to the glass. Ours never fail on the back shelves of three-quarter span-roofed plant stove and forcing houses, three long rows being grown, but they do not thrive nearly so well on side shelves in the same houses. They also do well on shelves in Pine stoves, and on these shelves generally they ought to be kept till the spikes are well advanced in flower

and the foliage dead, when they will do well, and prove most effective interspersed among Ferns and a variety of other plants. When first potted only just enough moisture should be afforded to prevent the soil becoming very dry, but according as the roots spread more water must be given, till eventually a good soaking is required daily. Liquid manure of some kind may then alternate with clear water, but it ought not to be strong enough to injure the roots. Water must be gradually withheld according as the foliage ripens off and active growth ceases, this being a rather critical time, though the young spikes pushing up from shelf-grown bulbs rarely damp off. During the hottest part of the summer the Calanthes require to be carefully shaded from bright sunshine, and overhead syringings are beneficial. Their flowering season usually extends from the middle of November to the end of January, and this season we shall have them still later. Earliness, however, is greatly affected by the time of starting the plants and the heat they are kept in, and a good succession can be had by varying this treatment.

Calanthes travel and keep well. The boxes may be lined with cotton wool, over this placing a sheet of tissue paper, on which the spikes may be packed very closely in a single layer, being then covered with more paper and enough cotton wool to keep all tight and firm when the lid is shut down. Wooden boxes are always to be preferred as being the warmest and safest, and during frosty weather the Parcels Post is the safest means of transit. Boxes are too much exposed to cold when sent by rail.—M. H.

THE WINTER.

PRESENT AND FUTURE DIFFICULTIES.

No one reading your excellent article under the above heading in the Journal of last week could fail to appreciate the timely remarks and suggestions so prominently brought forward, and the thoroughly accurate account of what is likely to happen will apply to many persons in charge of gardens this season. That vegetables during the early part of the summer will be scarce there cannot be a doubt, as whole breadths of Broccoli are either killed or so enfeebled as to be nearly useless. Varieties of Lettuces, which in ordinary winters have stood without protection, are likewise gone. Cabbages look sickly, and so does Spinach, while Parsley, which has had neither frames nor handlights to cover it, will be many long days before it affords a decent picking. The remarks on those who have sufficient accommodation wherewith to force Asparagus, Seakale, Kidney Beans, and Mushrooms are well for those to whom it may apply, but it is the note of warning to others less favourably situated that makes the article so valuable, while the portion relating to the insufficient frame ground is quite opportune. You apply for suggestions as to how these difficulties may be overcome, and I have pleasure in suggesting a few items which may serve a good end and simplify matters a little.

Where frames do not exist in which hotbeds can be made up much may be done in greenhouses with pans and boxes, so as to be prepared for the time when all danger of frost is over by having on hand a supply of plants sufficient for the space at command, and which will be of inestimable value to tide over a critical portion of the year. In many establishments a sowing of Red and White Cabbages will already have been made, also Cauliflowers, Lettuce, and Parsley; but those not having done so should lose no time, but make a sowing at once. Some old potting soil will be excellent on which to sow. Have clean pans ready drained, over these place a coating of leaf mould, and fill nearly level to the rim with the soil, and sow the seeds thinly, covering slightly with fine soil, and water carefully until the seeds germinate. Place them in the greenhouse, and when the plants are showing their first leaves prick off into boxes of good soil, giving the plants 3 or 4 inches space. Instead of covering the bottoms of the boxes with leaf mould we use some well-decayed manure, which the plants delight in. In the greenhouse they may be kept until the worst of the weather is over, providing as much air is admitted on all favourable occasions as possible. As the weather becomes warmer a wooden framework may be made of any rough boards and erected in a sheltered part of the garden in which to place the boxes. In the case of cold cutting winds mats or any suitable covering can be laid over the framework, removing on every favourable opportunity so as to admit the light. In this way they may be kept until the time for planting outside arrives, and if planted with care on a south border will be found much earlier than if sown outside.

With regard to Lettuces, we sow Tom Thumb and All the Year Round. The former is kept growing in the greenhouse, cut out of the boxes, reserving the latter for planting outside. It is also well to grow two or three boxes of Parsley in the greenhouse. Although nothing can equal that grown outside, still useful sprigs may be had for cooking and garnishing purposes. Early Erfurt is a variety of Cauliflower we use, and Cocoman is an early compact Cabbage, but other varieties equally as good are easy to select.

Early Peas we sow in boxes the last week in February, the varieties used being American Wonder and William Hurst. A greenhouse or Peach house will start them admirably. When about an inch high they may be placed with the other boxes in the frame until the time for planting. In planting we select a piece of ground which has been heavily manured, and mark out rows 18 inches apart for American Wonder, and 2 feet for William Hurst. The line being tightened, a shallow trench is taken out with a spade or small fork, the Peas are then taken out of the boxes and carefully placed in the trenches, afterwards filling up with fine soil and pressing it round the roots. A good watering follows, and if a few twigs of Fir, or anything of the sort is placed along the rows, it will be found advantageous in warding off any cold winds. This system has been pursued by us for many years, and by adopting it we have been able to secure supplies much sooner than we should otherwise have done, and in giving these few notes I do so with the hope that they may be of benefit to some of your readers who may feel the scarcity of supply.—R. P. R.

THE CULTIVATION OF THE PEACH AND NECTARINE UNDER GLASS AND ON THE OPEN WALL.

[A Paper read by Mr. W. TUNNINGTON, Calderstone, Aigburth, before the members of the Liverpool Horticultural Association, January 16th, 1891.]

(Continued from page 66.)

ROOT-PRUNING.

THIS is resorted to for the purpose of restoring equality between root and branches. It stands to reason that when the head of a tree is restricted to certain space annually, and its roots allowed to ramble at will in a rich border, that they will get out of proportion to the head. This is followed by the production of gross wood, which does not ripen, and is sure to end in unfruitfulness. The remedy for this is root-pruning or checking the roots to prevent grossness, thus inducing a moderate and more fertile growth, such as in an ordinary season will ripen well, and ultimately, all things being favourable, will yield a crop of fruit. This root-pruning should be done earlier than it usually is. Generally it is deferred until the tree has lost its foliage. I prefer to do it when the leaves show signs of finishing growth, say about the end of September. The advantages of doing it at this time are that it brings the tree to rest earlier, which matures both wood and buds, and that the temperature of the soil is higher than at a later period. This with the leaves still upon the trees will induce fresh root action, and enable the tree to recover a little from the severe check it sustained from the operation, and be more likely to yield good results the following season.

The operation is very simple. The first thing to be considered is the size of the tree. In the case of young trees that are growing more vigorous than is desirable a trench may be made 2 feet from the stem, and all the strongest roots shortened a little. If the weather is fine at the time the trench can with advantage be left open for a day or two. This will check growth and effect early wood ripening. If sufficient strong roots are not found near the surface to account for grossness the suspicion then arises that there are tap roots. In that case the tree must be worked under and all roots that are striking downwards cut and brought up. In the case of old trees we remove every second or third year within a yard of the stem of the tree one-third of the soil in circumference down to the drainage. This is replaced by new. If root suckers are present they are removed and the roots relaid firmly in the new soil close to the surface. By this treatment the trees are not much checked, and the roots working in the new soil considerably adds to their vigour.

MULCHING.

In shallow borders this is a necessity during the summer months. It keeps the surface of the border cool, and encourages the roots to the surface. This is where we want them if we are to expect the tree to be fruitful, and at the same time produce fruit of the best quality. For old trees that are carrying a crop we use good cow dung. In the case of young trees or trees that show signs of too luxuriant growth old spent manure, such as old hotbed dung, is more suitable. This prevents the border being parched during hot weather, and at the same time does not afford too much rich food at the times of heavy rain. During

the winter months the mulching is removed, as I think the action of frost on the border is of great benefit; it mellows the soil and causes a complete rest in the trees, which does not take place when the border is covered with manure. I may state we never use farmyard manure in the soil at the time of planting.

INSECTS.

Red spider and green and black aphides are very troublesome. The former can be kept down by the free use of the syringe on fine days. If the other makes its appearance as soon as it is detected syringe the trees with a solution of softsoap and tobacco juice, at the rate of 2 ozs. of softsoap and 1 pint of tobacco juice to 4 gallons of tepid water. If the trees are attacked by mildew a small quantity of sulphur may be added to this solution. I have been troubled of late years by a weevil, which eats off the flowers and embryo fruit, and which if not checked by some radical cure will soon spoil all the hopes of a crop. In a cold ungenial season, when the trees can make little headway in growth, this pest will curl itself up in the young foliage, secure from the reach of all insecticide. In this case hand-picking should at once be resorted to, and all curled leaves crushed or removed. My mode of procedure has been to syringe the trees in autumn, before the insect gets into its winter quarter, with a solution of petroleum and soapsuds from the laundry, if they are to be had; if not, softsoap must be brought into requisition. To every gallon of the soapsuds we add one and a half wineglasses full of petroleum. This is kept well mixed by one man, while another forcibly syringes every particle of the wall and the trees, making sure that not the slightest crevice is missed.

In the winter all the branches and shoots are loosened from the wall, and every shred is gathered up and burned. I find this a favourite hiding place for the larvæ of insects. If, previous to loosening the main branches, a mark is made upon the wall to show the position they occupied, it will greatly facilitate the operation of nailing in the spring. The branches are then bunched up, pulled away from the wall, and securely tied to stakes driven into the border for that purpose.

I forgot to mention that, previous to being syringed, a piece of canvas or old cloth is bound tightly round the stem of the tree, and spread upon the border a few feet round to prevent it getting saturated with the petroleum. The branches are kept away from the wall until the buds are showing colour in the spring. I find this retards the flowering for a fortnight or three weeks. In consequence they are not so liable to be injured by late frosts.

Before the trees are nailed in the spring, they are again syringed with one wineglassful of petroleum to a gallon of water. After they are nailed we further retard by the aid of the blinds, previously named, by letting them down for an hour or two in the day during bright sunshine, until the trees get partly in flower. After this, the blinds are only used in case of frost or cold winds.

In concluding my remarks on the Peach outside, I will name a few varieties that have proved most satisfactory with us. Alexander is the first to ripen, and is of good size, and a good Peach in all respects. Dymond also is amongst the best of early Peaches. These are closely followed by Hale's Early. I think this is better than the above. It is larger, and is first-rate in all respects. Royal George and Grosse Mignonne are useful sorts. We have for some years had fruit of Walburton Admirable at the end of September and beginning of October. Although this is rather too late for good flavour, it is wonderful how it is improved if the fruit is put into a Pine stove for a few days before it is sent to table.

In Nectarines Lord Napier is a long way the best with us. It is a large fruit and of good flavour. We have not missed a crop of this outside for years. It ripens ten days earlier than Hunt's Tawny. The latter is followed by Pine Apple. There are later Nectarines, but I do not advise planting them outside so far north.

(To be continued.)

VARIEGATED FOLIAGE PLANTS.

AS long as I remember our Journal it has been characterised by the freedom of discussion allowed to its writers. As competition is the life of trade, so may we conclude that discussion is the proper means by which to cultivate successfully an *esprit du corps* in the writers who contribute so well to its pages. I have not seen Mr. Atkins' signature before, but I thought his communication on foliage plants very much to the point, though there were one or two items which the result of my experience would have altered somewhat. I therefore think that "Rusticus" is a little too severe, especially as he is himself somewhat incorrect in some of the statements he makes. Thus he condemns Coleuses and Caladiums much too hastily. Coleus Tête d'Or when well grown is one of the best and most effective decorative plants we have.

Moreover, it stands house work well, and is so easily increased that we can dispose of many badly damaged veterans with less compunction than is felt for the loss of a good specimen of a plant more difficult to increase. Caladiums, again, are very good for grouping or placing in single vases. If properly prepared they will stand a two-months campaign in summer or autumn.

The variegated Pine Apple is also a very good decorative plant, but I should imagine neither of your correspondents has seen it in good form. Our method is to grow the plants on to a large size, which they can be in 10 to 12-inch pots. When large enough they are "beheaded," and the tops are rooted in 5-inch pots, and kept in the full glare of the sun throughout the summer. There is no "spikiness" about such plants, and the colouring is worth the trouble. Pandanus Veitchi is one of the best standing plants, but it requires a peculiar treatment from the cutting stage to get it into best form.

As to the method of propagating tops of *Ficus elastica* variegata from cuttings, why do so when roots can be more quickly produced on the plants by dividing the stem at the desired point and mossing? To grow this plant well it ought to be allowed the temperature of a hot stove. The warmer treatment it receives the better it colours. I have a large stock of this now, the tallest with single stem, clothed from the pot with foliage, being quite 7 feet in height. When in good condition it takes high place among decorative plants. However, it should be understood that it will not do under the same treatment as the type will, nor is it so well adapted to stand rough treatment.

Both writers have omitted such grand *Dracænas* as *Lindeni* variegata *superba* and *Mrs. Freake*.—B.



LEAVES IN ORCHID HOUSES.

VISITORS to the Orchid Nursery at St. Albans cannot fail to be favourably impressed by the healthy and vigorous condition of the plants. This to a great extent no doubt is due to the genial surroundings, in which leaves play an important part. It was a conversation I had with Mr. Sander which led to my adopting leaves for the houses in these gardens, and I think with very beneficial results, and especially so as regards *Cattleyas*. Iron and stone play too important a part in the modern construction of Orchid houses, and although this must be had to a certain extent, yet if there are not other counteracting agencies the Orchids will not thrive as they ought. Mr. Horner of *Auricula* fame, who can grow Orchids as well as most people, and better than many, attributes no mean part of his success to the floor of the houses being of earth, and so imparting more natural surroundings. Early fruit forcers are fully alive to the beneficial influence in which leaves, or even leaves and stable manure, have upon the various fruit trees and plants. With Orchids it is not less important, as these denizens of the tropical forests receive the major part of their sustenance from the surrounding atmosphere, which must be charged with the vapours arising from the decaying vegetation.

Leaves have not an untidy appearance, especially where pits for receiving them are sunk in the house level with the floor. I cover the whole of the floors with leaves, a trellis being used for walking upon. I am aware that some people have a great aversion to leaves on account of the belief that they harbour slugs, but as open lath stages are now generally raised above the under or close-fitting one, the supports of which can be fixed in receptacles for holding water, there need be no fear of injury from these pests. When the leaves are first introduced the heating soon causes the slugs to change their quarters, consequently we keep a sharp look out and kill all we can see before they have much chance of escaping. During the late severe weather rather sharp firing has had to be resorted to so as to keep a safe temperature, but the genial state of the atmosphere, on account of the leaves contained in the houses, has been quite marked. Orchids, say *Cattleyas* for instance, which are kept fairly dry through the winter months would become drier in a given time in a winter like the present, on account of the extra artificial heat, than they otherwise would do in a milder winter with less firing. Leaves counteract this drying influence to a remarkable degree—a great point I think in their favour.—A. YOUNG, *Abberley Hall Gardens, Stourport*.

HARDY CYPRIPEDIUMS.

AMONG the rarest plants in the hardy plant garden to be found in fine established tufts are the hardy *Cypripediums*, though why it should be so is a problem hard to solve. Some, it is true, require especial care in growing them, but these difficulties would

speedily diminish provided better plants were obtainable to begin with, for it is hardly to be expected that a feeble rhizome denuded of all roots save a few scattered fragments and a crown can survive when the flowering time has passed, for what energy the bud contains is quite exhausted. Happily, those that reach us in the best sized pieces and in the best condition, so far as good roots and strong healthy crowns are concerned, are among the best of all the hardy species. Anyone given good sized pieces of *C. spectabile*, *C. Calceolus*, and *C. parviflorum* should have little difficulty in permanently establishing them if a suitable spot can be found for them.

Some of your readers, however, may like to know what constitutes a suitable spot for these plants, and this I will briefly describe. In the larger gardens shade and coolness will be readily found, and these, coupled with abundant moisture, either naturally or artificially supplied, are the most important of their requirements. There are different modes of providing for these plants, and to accommodate them as they deserve it will be much the simplest plan to devote a moist shady corner or nook to their cultivation.

The next thing will be to excavate an irregular hole, in future to be called the artificial bog, about 2 feet deep, and of a diameter to suit individual requirements. One of 6 feet or 8 feet across, however, will not only hold sufficient of these charming plants to make a really good display, but it may also contain an interesting selection of other showy as well as choice plants, which in reality need some such provision, but they are too frequently planted in positions quite the reverse. The hole having been dug to the required depth, some rough clinkers, brickbats, stones, or similar material, should be placed in the bottom to a depth of 6 inches to carry off water and keep the soil sweet, for while these plants delight in abundance of moisture they dislike stagnation. Cover this drainage with some thick turves, grass side downwards. This will prevent the soil above trickling down into and choking the drainage, and if properly done will last for years. It only remains to fill with soil consisting of peat and peat siftings and half-decayed leaf soil in equal proportion, working in a little manure thoroughly decomposed, some sharp sand, old mortar rubbish if obtainable, likewise some sphagnum moss.

A foot thick of this compost will bring the surface of the bed to within 6 inches of the ordinary level—a desirable level, particularly if the margin be shaped as a saucer, for then all the rain water possible will be secured for the welfare of the plants. Apart from this, however, there should be a supply of water under control, either by means of a pipe permanently laid into the bog or by means of a hose pipe, which may readily supply any amount, sufficient in fact to keep the bed in a state of semi-saturation from the time growth commences till the plants are again at rest. Under such conditions as these not only will these *Cypripediums* thrive, but *Trilliums*, *Dodecatheons*, *Dentarias*, *Saxifraga peltata*, *Swertia perennis*, *Parnassias*, *Lobelias* of the *fulgens* and *syphilitica* sections, many *Orchises*, *Wood Anemones*, with *Primulas rosea*, *cashmeriana*, and *japonica*, though these prefer a loamy soil rather than a peaty one; still, it would be increasing the general interest of such a spot by study the individual requirements of moisture and shade loving plants by adding soil accordingly when planting them. In similar ways many corners of villa gardens, as well as others of great import, may be beautified for a considerable period of the year, and instead of being avoided as heretofore prove as attractive as any spot in the garden.—J. H. E.

THE VANILLA.

I HAVE been interested in reading in the *Journal* the excellent paper by Mr. A. W. Wills upon his travels in India. It is not only interesting but instructive to gardeners, therefore it is of the more importance that the paper should be correct as to matter of fact, especially if it bears upon the culture of any plant likely to be grown by practical gardeners. Mr. Wills states at page 70, in reference to the *Vanilla*, "Yet in our stoves how difficult it is even to maintain this *Orchid* in a semi-moribund state." This is surely an error, for if all our *Orchids* were so easily grown as the *Vanilla*, the *Orchid* grower's work would be easy enough. I do not advise any one to grow it unless they have a large house, but given this, with plenty of heat and moisture, it will grow with the greatest vigour. It would give the plant a considerable check either in England or Burma to cut it over close to the ground, but if this is done the roots which are always forming on the long twining stems soon lay hold of any fresh material they are set in. It roots away freely in fibrous loam and peat with some decayed manure, but the aerial roots absorb considerable moisture from the atmosphere. It is necessary to syringe the plant freely in hot weather in summer once daily at least to keep it free from thrips. These troublesome pests seem to have a special fondness for this plant, and if they

are not subdued they will speedily bring it down to the semi-moribund state described by Mr. Wills, but this would be the fault of the cultivator.—J. DOUGLAS.

POTATOES FOR IRELAND.

I CONSIDER that your correspondent, Mr. Iggulden (page 61), has called attention to a most important matter—namely, the failure of the Irish Potato crop, and likewise suggests some remedies whereby some of the suffering caused by such failure might be mitigated. When so many schemes are in the air for the social and economical welfare of Ireland it is a great pity that some such common-sense remedies are not tried. I cannot help thinking that if the matter was fairly placed before the present Chief Secretary for Ireland, who has, I believe, the general welfare of Ireland greatly at heart, and was within the range of practical politics, it would stand a fair chance of being tried. If properly carried out it must do a great deal of good; of course, it would have to be on the voluntary principle, as you could not intrude on a man's Potato patch any more than into his house.

I quite agree with Mr. Iggulden that there are always too many good men experienced as head gardeners out of employ, and who possess the necessary qualifications for instructors in the art of properly cropping and cultivating such small holdings peculiar to the distressed districts of Ireland. To me it has often seemed a puzzle why the Irish people, small cottars and others, put all their eggs as it were into one basket, and grow nothing but Potatoes, when Carrots, Parsnips, Onions, Beetroot, Jerusalem Artichokes, Beans and Peas, all contain nearly as much nutritious matter as the Potato, and some of them more. I should think that a variety of Potato having such tall haulm as the *Champion* was unsuited to the humid climate of Ireland, but to find the best varieties trial or model gardens should be established near the schools. The scholars should be taught gardening, and a notice given that the garden was open at proper times for the inspection of all who wanted to learn better methods of cultivation. The best of everything should be tried, and at the end of the season the produce of the school gardens could be sold at a nominal price to the cottagers. At the same time as the boys are taught to grow the vegetables, the girls should be taught to cook them, and one instructor in the course of a week might attend several schools. Exhibitions should be held for the produce of school gardens and cottage gardens, and no doubt cultivation would improve, a greater variety of crops would be grown, tending to the general welfare of the people.

I know from an annual personal inspection of our village gardens and allotments, since we have had a cottagers' show, the produce of the gardens has increased greatly in value and variety, and I believe it is knowledge that is mostly required, for on one occasion I had a man employed under me in a garden in the North of England who emigrated from Ireland to Yorkshire—a man grown—and picked up his knowledge there; and he was one of the handiest and smartest men at outdoor garden work I ever met, and I have several very good men serving under me now. I hope the power of gardening knowledge will be tried on the Irish peasantry where needed, and then the partial failure of the Potato crop will not cause so much distress.—R. MAHER, *Yattendon Court, Newbury.*

SEASONABLE HINTS ON FLORISTS' FLOWERS.

AURICULAS.—The question has been often mooted, What harm does a severe winter do to these plants? It is of no use arguing from their origin that they cannot be much inconvenienced by it, for although the plant is doubtless an Alpine, yet it has been so altered and refined that its constitution is not what it was, a fact which can be tried very easily by planting some of the refined edged flowers on the rockery, together with *Primula Auricula* and *Primula marginata*, when it will be seen after a season or two that while the latter are flourishing the former have become "few by degrees and beautifully less," and therefore that degree of hardiness they do not possess. At the same time, my experience is that they do better in a cold winter than in a mild one. Where, as at present, we have a long unbroken spell of cold there are no spasmodic attempts at growth induced by sunny warm days, and then the plants chilled by an attack of frost. There is much less chance, too, of too early blooms, which eventually suffer from cold. One thing does happen when the truss is formed, and perhaps just beginning to peep above the foliage, that the pips become distorted and crumpled, and of course their flatness and symmetry is destroyed. This may be obviated by covering the frames with matting, and this year snow has formed a very good blanket. Hence, on the whole, I do not anticipate a good blooming time for the *Auricula*.

As soon as the weather is favourable it will be necessary to remove all decayed or decaying leaves, and to stir the surface of the soil very gently with a blunt stick, and to examine the collar for woolly aphis, removing it if any be found. I wish that I could share Mr. Douglas's hope that the severe weather will be too much for them, but I really cannot. They seem to be impervious to most things, and we have had severe winters since their appearance or their reappearance, and yet it has not disposed of them, so that I am very doubtful as to this increased lower temperature doing it.

CARNATIONS AND PICOTEEES.—Here, too, all is in a state of stagnation, and nothing can as yet be done. On examining my small collec-

tion I find them looking exceedingly well, the grass green and vigorous, and no signs of decay or mildew; but the soil in the pots is frozen hard, precluding the possibility of doing anything with them at present. Now will be a good time, if it be not already done, of getting the compost ready for them, placing it under a shed where it can be exposed to the action of frost without rain falling on it, and when the frost goes it can be hand-picked and all worms and grubs, especially the wire-worm, carefully looked for and destroyed. I do not know how the border Carnations will fare after this severe winter. I fear that many a reputation will be damaged, and that there will be many vacancies. I already see some ominous signs of approaching dissolution.

GLADIOLUS.—Here again we are in a very quiet state. Where the corms are wintered the cold weather has been in their favour provided they were kept from frost, as it will prevent the tendency in some of the earlier blooming kinds of pushing out roots (or shoots as in some cases), and thus keeping them in a thoroughly dormant condition. I fear that those who have lately essayed their growth will experience somewhat of the same disappointing results as we who have gone before—that losses will occur do what we will. By-the-by, it is pleasant to find that the Royal Horticultural Society is offering prizes this year for them on August 25th, as an opportunity will then be given of testing the correctness of some statements that have been made of late as to inferiority of the French spikes as compared with those of English-raised flowers, an inferiority I confess I cannot see.

PANSIES.—I do not grow these in the open border or I should be in a great fluster about them. I think the frost loosens the hold of the plants on the ground and makes them altogether have an uncomfortable and distressed look, and I should think the losses amongst them will be numerous. My own small collection is in pots and in a frame, but even they look limp and flaccid. They will, however, I hope revive. They are, of course, kept perfectly dry, as indeed are all florists' flowers at present.

RANUNCULUS.—These, at least the Persian varieties, are now snug in their drawers or boxes (as the case may be), and nothing can be done for them at present; the tubers may be looked over to see that they are free from damp. I grow also the Turban varieties, but these do not come under my notion of florists' flowers. I had a piece of good luck with them this year, showing the advantage of being on the look out for weather. A favourable day for planting occurred in November. I thought, Shall we plant or leave it until to-morrow? We seized time by the forelock, and got in both them and my one bed of Tulips. The bed where the Persians are to be planted is well turned up, and I hope the ground will be in a good condition by the time their planting is possible. I am surprised that this beautiful flower is not more grown; indeed, it has fallen into a state of neglect. I remember the time when Carey Tyso of Wallingford and George Lightbody of Falkirk were running a race as to the production of the best flowers, when new varieties were priced in their lists at a guinea apiece, and what is more, when amateurs paid that for them. I fear these strains have now well nigh vanished; no one has taken them up, while more showy and less symmetrical flowers, which go by the name of French Ranunculus, have intruded themselves into our gardens. It is one of those instances in which show and glare have taken the place of elegant form and delicacy of colouring.

ROSES.—Much searching of heart is going on now on the condition of Rose trees after this long spell of severe frost, and various and conflicting are the accounts, especially with regard to Teas. I fear that they who depend on standards will have a sad tale to tell, but the condition of dwarfs is still hopeful. In some places I hear of their being utterly ruined, while Mr. Burnside brought up to the meeting the other day some wood of Maréchal Niel and Francisca Kruger which were quite uninjured. It is, of course, too early as yet to judge, but I do not think the damage will be so great as some people imagine. One is surprised at the very opposite views held on the most common subjects. I have been much astonished to see it stated that the damage to the Roses by frost was to be attributed to the unripened nature of the wood caused by the wet summer, while many of us believe that they will not suffer so much because the wood was so thoroughly ripened in the splendid September and October which we enjoyed after our wet July and August.

TULIPS.—These are safe in the ground, and we hope are making good roots preparatory to their blooming, but nothing can be done with them.—D., *Beal*.

WINTER FLOWERING BEGONIAS.

WHEN *Begonia socotrana* was introduced to this country nine or ten years ago it was thought by some that while constituting a beautiful addition to our cultivated Begonias it would not be likely to help the hybridiser materially. Upon what this opinion was founded does not appear, but the fact remains that the converse has been abundantly proved, and there is every reason to expect still greater results. It will probably be remembered that when an illustration of *B. socotrana* was published in this Journal (p. 95, February 2nd, 1882) it was stated Messrs. J. Veitch & Sons of Chelsea had secured the stock, and further that the plants seemed to combine the characters of several popular types of Begonias. At Chelsea experiments were commenced with the plants as soon as they flowered, and one of the first crosses that produced any results was from *B. socotrana* as the seed parent and the variety *Viscountess Doneraile* as the pollen parent. The seed thus obtained was sown in December, 1883; one plant only was raised, and when this

flowered it formed a distinct and beautiful acquisition, receiving the name of its raiser, "John Heal." It was shown at the meeting of the Royal Horticultural Society, October 13th, 1885, and was awarded a first-class certificate. The plant was very graceful in habit, with rich, rose-coloured, freely produced flowers, and we hazarded the prediction at the time that it would "probably prove the commencement of a new race of winter flowering Begonias."

Further experiments were tried, and in 1885 seed was obtained from a cross between an orange-scarlet Tuberous Begonia and John Heal, the former being the seed parent. The seed was sown in December of that year, and the plant obtained was shown and certificated on November 8th, 1887, under the name of Adonis. The flowers have broad petals of



FIG. 15.—BEGONIA WINTER GEM.

a rosy scarlet hue, very distinct in colour, and the plant in general habit resembles *B. socotrana*.

The third success is Winter Gem (fig. 15), for which the Floral Committee of the Royal Horticultural Society granted an award of merit at the meeting in January of the present year. This was raised from a cross between *B. socotrana* and a tuberous crimson-scarlet seedling. The seed was sown in February, 1886, and only one plant was obtained from the pod, exactly as in the case of John Heal and Adonis. It is of dwarf habit, with rounded leaves, and soft, rosy, well formed flowers, rather suggestive of the modern Zonal Pelargonium. It is free, lasts well, and is especially valuable for the fact that it flowers regularly in December, lasting to the end of January. The other two generally flower in October and November, so that Winter Gem forms a natural succession. It is a singular circumstance that the flowers seem to be all staminate, and this has been a difficulty in perpetuating the type. Fortunately they are increased by cuttings or bulbils, and every advance made will be watched with much interest. A pure white variety would be decidedly welcome; it is not too much even to expect a double variety, and if a group with marked variations can be once formed the plants will take a place amongst the most useful for winter.—C.



IN MEMORIAM.—JEAN SISLEY OF LYONS.

AT the ripe age of eighty-seven there has just passed away one who, though residing in France, was well known in England, and who indeed was more than half an Englishman, the acute horticulturist whose name heads this brief notice. I have used the expression more than half an Englishman advisedly, for in a correspondence I had with him some years ago he informed me that his family had once resided in the neighbourhood of Sutton Valence in this county (Kent), and that he himself was once in business in England; the name still survives in the extreme west of the county.

Living as he did amongst the many raisers of Roses, he was able to go about amongst them, observe their operations, judge of their results, and he often communicated these to your contemporaries. I never had the pleasure of seeing him, but from all I have heard he was an energetic vigorous man, holding strong views, and having no fear of letting them be known. The correspondence arose from his having written about what he called the dishonesty of Englishmen buying the stock of a Rose raised in France, and then sending it out in England with an English name, and writing themselves the raisers. Another point on which he felt and wrote strongly was the manner in which some names of Roses were anglicised when they came over here. What right, he wrote, had any English Rose grower to change Duc de Wellington into Duke of Wellington? He was also much interested in Carnations and Pelargoniums, and his love for flowers led him on to cultivate many classes of plants.—D., Deal.

STRAY NOTES.

THERE really seems to be some excuse for "talking about the weather" this winter. I suppose we ought to be proud of breaking the record of a hundred years or so in the way of frost if we have done it, but not being a regular scientific observer I should be content for those who remember 1813-14, or whatever it is, to continue to crow if they wish it, if we could only get a regular thaw. Mark Twain tells us of a river pilot who "couldn't ever seem to tell the truth in any kind of weather." I feel now that if he were confined to stories of extreme and long-continued cold, he would have "to strain himself" to get beyond the limits of my credulity. It is the continuance, rather than the severity, which has been extraordinary. The frames containing my Violets have only been opened twice, for about six hours at a time, for more than eight weeks, and they do not appear much the worse for their seclusion, and the lowest reading of my thermometer on a sheltered wall was 5° Fahr. on the morning of January 10th. This was 7° lower than that of any other night this winter; on every other dangerous night clouds or fog have come over before the morning and saved us from zero. Exactly the same low point (5°) was reached the winter before last here—viz., on the morning of February 13th, 1889, when all my established Maréchal Niels, though well protected with bracken, and covered, moreover, with 10 inches of snow, were absolutely killed. But we had had warm weather in the early part of February, and the plants had not been so well ripened in the autumn before as they have been now.

Dean Hole tells us, I think, in his "Book of Roses," that the enthusiastic workingmen florists of the Nottingham district will take the coverings from their own beds on a cold night to cover up the "bit of glass," and keep their favourites from the frost. I am very fond of my Tea Roses, and have done what I could for their beds, but they would have a poor time of it if I was killed by the cold, and lately it has "got in," so that it has been as much as I could do to keep the frost out of my own bed. I have found the earthing up of the beds (the Teas, not my own) to be after all not altogether satisfactory. If you do it with a hoe from the beds themselves you are apt to tear or expose the shallow and most valuable roots, and extraneous soil is a trouble to get there in a hurry and to take away nicely. I have tried this year and last dead leaves. They blow about but very little (for whatever the N.R.S. catalogue may say, Tea Roses have thorns), are light and easily put on, and fairly easily removed, and seem to be more like what Nature herself suggests in the way of a winter covering. Whether any serious damage has been done hitherto I am not able to say, it is difficult to assess the amount of injury done by frost till some warmer weather has supervened. Mine may be all killed or very little hurt, but anyhow I am looking forward to paying a visit or two in the spring to certain good folks not far from me, who have been telling us during last summer and autumn that we are quite mistaken in supposing that Tea Roses are not as hardy as H.P.'s, and that there is really no necessity for coddling or covering them up.

But what a hindrance there has been to all sorts of garden work. I had all the most important part of my Rose planting done, and some three or four dozens of Apple tree were planted with desperate energy, but yet I hope with care, as if the enemy was hammering at the gates, as indeed he was. But alas for summer plans of restoration, renovation, and alteration of Rose beds—most of these must, I fear, now be put off to a less arctic winter. I was going to try, for the first time, the thorough

dressing with well-decayed farmyard manure of one of my Rose beds. It does not sound much of an experiment, but none of my Roses, or at least none of my H.P.'s and but few of my Teas, have ever had any dug into the soil. I think it often does more harm than good unless thoroughly decayed, when most of the virtue is gone, but I may be wrong. My Roses have nothing but liquid manure, with sometimes some artificial. On my soil, which is at all events light on the top and is easily washed about with much water, the time when the liquid manure goes in best is when just the crust is frozen; the dash of the water cannot then close the pores, and it disappears as quickly as if poured on a grating.

Readers of Dean Hole's book will remember an incident connected with a fire-shovel, used under what turned out to be unfortunate circumstances, to convey certain manure to his Roses. Early last spring, in a light frost, as I passed by the field gate of my rosery, I observed something which one of my cows had left there, apparently as an offering, and which, being just frozen, seemed particularly tempting to the spade I carried in my hand. Accordingly it was lifted and deposited just as it was upon the nearest Rose bed. A week or two afterwards I saw that it had been burrowed into by one of the large dung-beetles. I left it alone to see what would happen, and, to make a long story short, very nearly the whole of what was put there was actually buried underground before the time for the first hoeing of the bed had arrived. This is evidently a patent way of getting manure into one's Rose beds without disturbing the roots; but I am afraid the supply of workers is not equal to carrying it out on a large scale.

It has been well pointed out lately that for a good Rose season the weather at the actual time of flowering, or at least from mid-June to mid-July, is by far the most important, but no one seems to have noted in reviews of the past season any great change as having taken place with little apparent alteration in the weather in last July. That climatic and atmospheric changes at that time have very great and sometimes mysterious influence on the blooms is commonly recognised. We constantly hear during the season that such and such a Rose is "not coming good now," and that another is "coming much better." All Rose growers know that these changes do occur, but I am doubtful if the causes are thoroughly understood. We all know that some uncertain Roses, such as Pierre Notting especially, will sometimes suddenly begin to "come good" for no especial reason that we can define; and sometimes there is a wholesale change for the worse or the better with very little alteration in the weather that we can perceive.

Now, the wholesale change for the better that occurred here during the last three or four days of July was plainly due to the weather, which was hot, dull, and dry—perfect Rose weather; but earlier, somewhere about July 12th, there was a notable change for the worse in my rosery, though apparently not elsewhere, which did not seem to correspond to any particular alteration in the weather. Up to July 12th, in pouring rain, my H.P.'s had been very good. To take a special instance, I had the medal for best H.P. on two successive days, July 9th and 10th, with Le Havre. I had a good many even stronger buds of this variety coming on, but they turned out comparatively worthless, and I had not another good bloom of the sort throughout the season. The same change, in a less degree perhaps, passed over all my Roses about that date. After it they were certainly a point worse throughout than they had been. Even on strong shoots they were flabby, *passé*, shapeless even at first coming out compared with the earlier blooms. At the period of this change there was rather less rain than there had been, and the temperature fell and rose rather rapidly, but the weather had been very changeable before, and it was difficult indeed to account for the marked deterioration which took place.—W. R. RAILLEM.

BISMARCK APPLE.

IN your issue October 31st, 1889, I gave a few particulars concerning this grand new Apple, eliciting in consequence two letters from New Zealand with further interesting particulars, which I will give extracts from. Mr. W. J. Palmer of Auckland says:—"I look upon myself as the first to introduce it to New Zealand and also to England. In 1876 I saw in the catalogue of Mr. J. C. Coles, Richmond Nurseries, Melbourne, a description of a new seedling Apple of great promise, which I procured from him. I cut the plants hard in and grafted the scions in October, and in the March following took first prize for best cooking Apples at the Horticultural Show in Auckland. From these plants not six months old, being pleased with their appearance, I sent twenty-four plants to Messrs. J. Laing & Sons, Forest Hill, together with a woodcut. I have grown it here to 28 ozs. in weight. This is the origin of the Forest Hill stock; but two years after, Mr. McIndoe (brother of the well-known gardener at Hutton Hall) sent home by post to Hutton Hall grafts, which through this source originated Messrs. J. Veitch & Sons' plants." Mr. Palmer then goes on to state that it was raised at a place called Riddels Creek, in Victoria (Australia). The other letter is from Mr. John C. Blackmore of Onchunga, New Zealand, which confirms the previous fact of origin at Riddels Creek by Messrs. John Smith & Sons, who sent Mr. Blackmore trees as a present, and the latter claims to have been the first to grow it in Auckland. Both state the fact that it is a cross (?) between Stone's Pippin and Alexander. I think Alexander may be one of its parents, but Stone's Pippin may be Loddington (taken out by some Kentish emigrant, several of whom have lived near the

original tree), or another Stone's Pippin, a very old sort, to which the Scotch Gogar is the nearest relation that I can recall. My own opinion is that Wellington was one of the parents.

The precocity of bearing noted in Auckland has been fully borne out here, as we had dozens of fruit upon the maiden trees on Paradise stocks. Some of this fruit was up to 12 ozs. in weight, and figured in our collection at the Crystal Palace.

The foliage of this Apple does not indicate Alexander or Stone's the parents. It rather inclines to the wavy outline and hoary nature that obtains in Small's Admirable or the Hawthornden race. Another, and not a good Apple season, has fully confirmed my (1889) opinion that it is a most valuable addition to the fertile set of Apples of handsome appearance.—GEO. BUNYARD, *Maidstone*.

RESULTS OF THE FROST.

THE sudden rise in the temperature last week, accompanied as it was by a heavy rain washing the snow away, has revealed a poor state of things among the green crops in the kitchen garden and fields. Whatever damage may have been done to shrubs and Roses will be better known as the season advances, but the prolonged severe weather has played havoc with the crops of Broccoli, mine here being all dead excepting Sprouting Broccoli; even that is much damaged, and even the most forward planting of Brussels Sprouts is past use, but the later planted with their small heads are not hurt, showing that successive plantings of this important vegetable is advisable.

A large bed of Cabbages planted for spring use have mostly decayed at the hearts. The hardiest green vegetable so far proves to be the Curled Kale as well as Buda Kale. Fields of green vegetables in this locality are destroyed and give off a most disagreeable odour, showing too plainly the work of damage by frost. The lowest reading of our thermometer has been at 8°, or 24° of frost, on three different nights, but it has frequently been down to 14°, or 18° of frost. I have no recollection of so long a frost, and so persistently severe all through, though I have knowledge of one more severe in 1860-61, when the glass went below zero. That was when living at Bury St. Edmunds in Suffolk, but that frost was of shorter duration.—THOMAS RECORD, *Crayford, Kent*.

AMORPHOPHALLUS CAMPANULATUS.

NUMEROUS applications have been received for information concerning the true *Amorphophallus campanulatus*, which is totally distinct from the remarkable *Amorphophallus Titanum* that flowered in the Royal Gardens, Kew, in 1889, and was illustrated in the *Journal of Horticulture*, July 4th of that year (page 7, vol. xix, new series). Under the name of *Arum campanulatum* the plant, of which the name forms the title of this notice, has been known for many years, and was fully described by Dr. William Jackson Hooker in the "*Botanical Magazine*," in 1828 (T. 2812), a large double page coloured plate accompanying it. The greater part of this description is here quoted for the information of inquirers.

"Root a large, rounded, compressed tuber, marked with concentric lines and numerous scars; and producing a few small fibres. From the centre of this, generally, a single large leaf is produced 1½ to 2 feet high. Its peduncle is cylindrical, greenish brown, with pale spots, and hispid, or rather echinated, expanding above into three principal divisions or pinnae; each is again bifid, and the segments are pinnatifid, being cut almost to the midrib into ovato-lanceolate laciniae or leaflets, with many parallel veins. The flower appears at a different season from the leaf, and is very large and showy. From the top of the tuber arises a short, green, spotted stem, or peduncle, having numerous succulent radicles thrown out from its very base, and two unequal lanceolate membranaceous sheaths or bracteas. This short stem bears a very large subcampanulate purplish spathe, of a somewhat coriaceous texture, much waved at the margin, greyish, spotted with white on the outside, within whitish towards the middle, and reddish purple at the very base. Spadix 10 inches to 1 foot high; its lower half (that part covered with pistils) cylindrical, above, where the stamens are placed, much dilated, and at the top expanding into a large, waved, deep purple granulated head.

"The first I knew of this extraordinary plant was through the medium of my friend Dr. Strang, who obligingly brought me from M. Spanoghe from Java a noble specimen of it in spirits. About the same time a living plant was sent from Madagascar by Mr. Telfair to Robert Barclay, Esq., at Bury Hill, in whose superb collection, and under the skilful management of his gardener, it soon produced its flowers; and from a drawing kindly sent to me by that gentleman, aided by my specimens preserved in spirits, the accompanying figures were taken.

"Although the plant has been long represented and described by Rumphius, Rheede, and Commelin, yet no systematic botanist seems to have noticed it until Dr. Roxburgh introduced it into the '*Hortus Benghalensis*' under the name which I have here retained. We are there told that its Sanskrit name is Kunda, and its Hindoostani Munchakunda; that it is not uncommon on the Continent of India, as well as in the Archipelago; and that in the Northern Circars it is cultivated and valued as the Potato is with us, and as the Yams in the West Indies. The roots often weigh from 4 to 8 or more lbs. each. Commelin received it from Ceylon, and cultivated it at Amsterdam, but never saw it produce its flower. Rumphius seemed to consider the

flower of this to belong to his real *Tacca*, v. 5, t. 173, f. 1. Both he and Rheede speak of the root being employed medicinally by the natives."

Visitors to the late Miss North's gallery of plant pictures at Kew may have noticed, amongst the illustrations of Javan flora, a picture showing a leaf and inflorescence of *Amorphophallus campanulatus*, which Mr. Hemsley tells us was taken "previous to the bursting of the spathe containing the spadix, which takes place suddenly about sunset. There is an accumulation of heat, and it exhales an offensive odour that is quite overpowering, and so much resembles that of carrion, that flies cover the club of the spadix with their eggs."

The culture of most of these tropical Aroids is very similar. They require a high stove temperature, a moist atmosphere, and abundant supplies of water during growth, then a period of rest when the leaves die down to the tuber, and the soil can be kept nearly dry. The large divided leaves are the most attractive portion of the plants, and *A. Rivieri* is particularly valued for its foliage. The floral portion is remarkable, but the odour of nearly all the species is so objectionable that they are not welcome occupants of houses.

A full historical and botanical description of *Amorphophallus Titanum* appears in the "*Botanical Magazine*" for the present month, three plates being devoted to illustrating its peculiar characters.



EVENTS OF THE WEEK.—To-day (Thursday) at 4.30 P.M. the Royal Society will meet, and at 7 P.M. the National Chrysanthemum Society's annual meeting will be held at Anderton's Hotel, Fleet Street. The Society of Arts will meet on Wednesday, February 4th at 8 P.M.

— THE WEATHER IN THE METROPOLITAN DISTRICT has been open, bright, and comparatively mild during the past week. Slight frosts have occurred on several mornings, and some rain has fallen. The effects of the long continued frost are not fully apparent at present, but many shrubs have suffered seriously.

— GARDENERS' ROYAL BENEVOLENT INSTITUTION.—Mr. E. R. Cutler writes to us:—"You will see from the enclosed letter that your account of our proceedings last Thursday week has been productive of very great good to us. Will you kindly make mention of it in your next issue?" The following is the letter referred to, from Sir W. H. Salt to Mr. Harry J. Veitch:—"I have much pleasure in forwarding you a donation of £50 to the Gardeners' Royal Benevolent Institution. I trouble you with this, as I see by the *Journal of Horticulture* you have just been re-elected Treasurer." We are gratified by this intelligence. Sir William Salt's kind action is a great compliment to Mr. Veitch.

— FUNGI IN RELATION TO PLANT DISEASES.—We are informed that Professor C. B. Plowright, M.R.C.S., will deliver three lectures on the above subject at the Royal College of Surgeons, Lincoln's Inn Fields, London, on Monday, Wednesday and Friday, February 16th, 18th, and 20th. The lectures will be at 5 P.M. on each day.

— CAN you or any of your readers recommend me a PARSLEY SUITABLE FOR A SANDY SOIL? As a rule I never succeed with Parsley, the plants begin to rust off before the summer is half over. I have often thought that a list of flower and vegetable seeds suitable to a sandy soil would be very acceptable to an amateur like—E. T. H.

— AT a recent meeting of the BRIXTON, CLAPHAM AND STREAT-HAM CHRYSANTHEMUM SOCIETY Mr. William Roupell was elected Hon. Secretary, and he will no doubt do his best as the successor of the late Mr. Hall and of Mr. Salter to maintain the credit of this noted suburban Society.

— THE BIRMINGHAM GARDENERS' ASSOCIATION held its annual meeting in their room at the Birmingham Midland Institute on January 19th for passing the accounts and balance sheet, and the election of officers and Committee for the present year. Mr. W. B. Latham was unanimously re-elected Chairman, and the officers of the previous year were also re-elected. The income of the Association for 1890 was £53 13s. 10d., including subscribing members; and the expenditure £36 14s., so that a substantial balance remains in hand. There were 318 subscribing members for the past year. In addition to the money balance in hand, the Society's library, bookcases, &c., are of the value of at least £120.

— GARDENING APPOINTMENT.—Mr. S. Ocock, late gardener at Stud House, Home Park, Hampton Court, has taken charge of the gardens of R. B. Evered, Esq., Oatlands, Horley, Surrey.

— THE UNITED HORTICULTURAL BENEFIT AND PROVIDENT SOCIETY.—The annual meeting of this Society will take place on Monday, February 9th, at 8 P.M., at the Caledonian Hotel, when Mr. James H. Veitch has kindly promised to preside.

— A LARGE TREE.—I read a paragraph in the *Journal of Horticulture* last week about "a large tree." I wish "J. H." would kindly tell me how a tree which is 33 feet in diameter can be sawed through with a saw 22 feet long, and oblige—J. A.

— THE WEATHER IN THE NORTH.—In Scotland on January 20th and 21st 2 inches of snow fell, about 4 inches in all, which mostly disappeared on the 23rd, the temperature rising to 45°. The lowest reading of the season was 14° on the morning of the 18th, coinciding with the extreme cold in the south.—W. T.

— RAINFALL NEAR KILKENNY.—Mr. D. A. Milward sends a tabulated record of the rainfall at Laviston, Kilkenny, during 1890. We observe the total for the year was 28.18 inches, which fell on 201 days. February and October were the driest months, with 1.51 and 1.87 inch respectively. November was the wettest month with 4.30 inches, but upwards of 3 inches were recorded in January and March; under 3 inches falling during each of the remaining months. We prefer being supplied with deductions of this nature from records to full tabulated lists for publication.

— WEATHER NOTES.—Mr. A. Bentley, The Gardens, Eshwood Hall, Durham, January 26th, writes:—"I observe you have several reports of the recent severe weather, but none from this district. I therefore send the following observations on Sunday, January 18th. At 8 A.M. the temperature was at zero or 32° frost, noon 18° frost, 9 P.M. 32° frost. This is the most severe frost we have had here this winter, but we have several times had 20° and 22° frost. As we had a few inches of snow during the last severe frost, vegetation does not seem to have suffered much, at least not so much as some of your correspondents describe who have had less frost." Mr. T. H. Slade, The Gardens, Mongewell, sends the following note:—"We have registered 23°, 24°, and 25° of frost here. Cabbage and Broccoli are spoilt, and I am of opinion if we are to have the last named in winter they must not be planted in the usual manner, but in single rows, in order to have them thoroughly hardened to withstand severe weather. I adopted that plan in my previous charge, and purpose planting them in that way again."

— THE ROYAL METEOROLOGICAL SOCIETY.—The annual meeting of this Society was held recently at 25, Great George Street, Westminster, Mr. W. H. Dines, B.A., Vice-President, in the chair. Dr. Tripe read the Report of the Council, which stated that the progress of the Society during the past year had been of a satisfactory character. Among the investigations carried on by the Society are the following:—The organisation of a large number of meteorological stations, the observations from which are examined and reduced by the staff, and printed in the "Meteorological Record"; the regular inspection of these stations by the Assistant Secretary; the collection and discussion of phenological observations; and an inquiry into the thunderstorms of 1888 and 1889. An exhibition of instruments is held annually in March. During the year a complete catalogue of the Library, extending to 222 pages, has been compiled and published. The Library has so much overgrown the present limited accommodation, that the Council have been obliged to consider the question of obtaining more commodious rooms, and have consequently inaugurated a "New Premises Fund," which is being well supported by the Fellows. After the adoption of the Report the officers and Council for the ensuing year were elected. At the Ordinary Meeting the following papers were read.—1, "Note on a Peculiar Development of Cirrus Cloud Observed in Southern Switzerland," by Mr. R. H. Scott, M.A., F.R.S. 2, "Some Remarks on Dew," by Col. W. F. Badgley, F.R.Met.Soc. These are notes on observations which were made to discover whether all dew is deposited from the air, or if some also comes from the earth and plants, and also what quantity is formed during the year. The conclusions which the author deduces from his observations are:—(1) That the earth always exhales water vapour by night, and probably a greater quantity by day; (2) That the quantity of water vapour given off by the earth is always considerable, and that any variation in the quantity is mainly due to the season of the year; (3) That the greater part of

the dew comes from the earth vapour; and (4) That plants exhale water vapour, and do not exude moisture. The total quantity of dew collected on the author's grass plates in the year was 1.6147 inch.

— THE NATIONAL HORTICULTURAL SOCIETY OF FRANCE will hold their seventh Horticultural Congress in Paris during the present year. It will be held as in preceding years, at the same time as the annual Exhibition, in May, but the exact date has not yet been fixed.

— THE WALKLEY (SHEFFIELD) FLORAL AND HORTICULTURAL SOCIETY opened its session for 1891 on Friday, January 23rd. The meetings are held fortnightly at the Howard Hotel. An interesting programme of papers by various gardeners and amateurs has been arranged, and the interest of the members in the Society is to be further sustained by the re-establishment of a circulating library of horticultural works.

— AT the annual meeting of the BRIGHTON CHRYSANTHEMUM SOCIETY last Thursday it was decided to hold the Show for the present year on November 3rd and 4th. The proposition referred to in the circular issued to the effect that the desirability of opening the Show on the afternoon of Monday, November 2nd, should be fully considered, was discussed at some length, but the exhibitors appeared to think that it would impose too severe a strain upon them.

— AT the annual meeting of the RICHMOND (SURREY) HORTICULTURAL SOCIETY, it was announced that the total receipts amounted to £586 12s. 8d., the expenditure being £1 7s. 10d. short of this. Prizes amounted to £266 17s., exhibition expenses to £211 9s. 6d., and general expenses to £106 18s. 4d. Special thanks were accorded to the Honorary Auditor, Arthur Cooper, Esq., and to the Hon. Sec., J. H. Ford, Esq., for their valuable services. As already announced, the summer Show for 1891 will take place on June 24th in the Old Deer Park.

— FROZEN MUSHROOM BEDS.—Referring to a reply under the above heading on page 56, I had a similar bed to that of your correspondent, and perhaps my treatment may be of service to him, provided he has the convenience for adopting it. A bed was made late in the autumn in an old shed, but considering the severity of the weather I gave up all hopes of gathering from it. I then thought of the following plan, which will well repay me for my trouble. I chose the unheated bed of a small plant house, the heat maintained in the temperature being from 55° to 60°, and the plants remaining in their position. I simply took the soil off the top, and the part of the bed to the depth of the spawn, put it on the bed in the plant house, covered it with the soil, supplied water to settle this, and now the Mushrooms are coming as thick as hail.—W. G. C.

— ANTHRACITE COAL.—Doubtless many gardeners and amateurs will have had their resources heavily taxed to maintain the required temperatures in forcing and other glass structures during the severe weather through which we are passing. To all such I recommend anthracite coal, which while increasing the heat lessens the labour and obviates the necessity for night stoking. We have registered 4° and 6° below zero among other very low readings, but the "diamond" brand anthracite, advertised in this paper by T. T. Pascoe of Swansea, has carried us safely through with ease where ordinary coal or coke could not have maintained the required temperatures without unceasing attention day and night. I am inclined to think that at the end of the season it will not be more expensive, even here in Yorkshire, than ordinary coal or coke, and to those nearer the pits must be a very great saving.—A DOUGLAS.

— HARDY KALES.—Messrs. Sutton & Sons write:—As the almost arctic winter we have experienced for six or seven weeks has wrought such havoc amongst the green crops of the garden, making it almost impossible to obtain a supply of greens for the table, we think you may be interested in seeing specimens of our Exquisite Green and Exquisite Purple Arctic Kales. The specimens sent you to-day were planted at the usual time in an exposed part of our trial grounds without any protection whatever, and although other sorts growing alongside have been practically destroyed by the frost, these, as you will see, have not suffered in the least. Large beds of both these varieties may be seen in our trial grounds at the present time by travellers on the Great Western Railway. The plants generally grow from 8 to 12 inches high, and are as valuable for winter bedding as for table use. [Only one plant arrived, the purple variety mentioned. It is dwarf and sturdy, with much-curled leaves, not one of which has been in the least injured by frost.]

— THE B. S. WILLIAMS MEMORIAL FUND.—The final meeting of the Committee of the above Fund was held at 41, Wellington Street on Wednesday, January 28th at 3 P.M., Dr. M. T. Masters in the chair. The Treasurer, Mr. H. J. Veitch, announced that the total amount subscribed was £527 7s. 6d., that the printing and postage expenses amounted to £50 6s. 11d., leaving a balance at the bankers of £477 0s. 7d. After some discussion it was resolved that £250 be offered to the Committee of the Gardeners' Orphan Fund for the purpose of placing two children on that fund, to be nominated by Mr. Harry Williams. It was also resolved that the balance—namely, £227, be devoted as prizes and medals for plants, the capital and interest to be utilised until exhausted. Dr. M. T. Masters, Mr. Harry Williams, and Mr. J. A. Laing were appointed Trustees, and the determination of the distribution of this part of the Fund will be left to them.

— It is with regret we have to record the death of Mr. CHAS. KEETLEY, which occurred on Sunday, January 18th, after a short but painful illness, at Osmaston Hall, near Derby, in his seventy-seventh year. Mr. Keetley was appointed head gardener to the late Sir Robert Wilmot, Bart., upwards of forty years ago, and continued as such until the estate was sold to the Midland Railway Company a year or two ago, in whose service he continued until his death. Mr. Keetley was a well known and skilful gardener, kind and courteous to all with whom he had dealings, and ever ready to give advice to others, which won him a number of friends.

— TWO GOOD EARLY POTATOES.—Having tried many early varieties of kidney Potatoes side by side during the past two seasons, I have come to the conclusion that for early work there is none to surpass Sutton's Ringleader and Sharpe's Victor. The former, unlike other early Potatoes, has the foliage, though much shorter, of a late variety, and when I first tried it two years ago I began to think we had a wrong sort, a belief shared by many of my friends who saw the crop growing; but, however, it proved perfectly correct to description, and with the exception of Sharpe's Victor, came in fully ten days earlier than five others, and with such a splendid crop of handsome tubers that one was led to think was rather the produce of a late variety. It was free from disease both last year and this, and of excellent quality. Sharpe's Victor is useful for pots and forcing. It has the shortest foliage of any Potato with which I am acquainted which makes it a decided acquisition where space is limited, and for cottage gardens. Although with us not nearly such a heavy cropper as Ringleader, still the crop turned up in excellent condition, with not a trace of disease, and a better flavoured Potato no one could desire. We planted both varieties last year on March 25th, and both were ready to lift on May 28th.—R. P. R.

— THE correspondents of London daily papers send the two appended notes on GARDENING AND FLOWERS IN PARIS:—"The air is mild and the sun clear, although much ice remains in and around Paris. The happier conditions of atmosphere have given an impetus to the traffic in flowers which has been in abeyance for nearly a month, except among those who deal in the rarest and costliest specimens of winter cultivation. This Paris industry in recent years has assumed very large dimensions. The supplies come chiefly from Provence and the South, but a considerable quantity is reared by petty gardeners in the *banlieue*, whose income the frost has cruelly nipped. The superintendent of the Central Market for flowers tells me that on an average about 2000 baskets of cut plants arrive there every day, a little more than half of them coming from the provinces. After they have been thoroughly sorted according to their value, over 6000 porters are employed in distributing them in the city and in the suburbs. Eleven small markets are regularly constituted in various districts on certain days of the week, the taste and skill displayed by the women who preside at the stalls making these places, for the time being, models of elegance and artistic arrangement. Forced Lilies, Roses, Camellias, Azaleas, and Orchids are reared by a considerable number of gardeners round the capital, but only five devote themselves specially to the costly Gardenia, and only one to the Orange flower indispensable at marriages."

— "THE FLOWER MARKETS OF PARIS are usually one of its most lovely features. For six weeks they have been flowerless. The damage done to flowers in the environs of Paris cannot be repaired this year. M. Simon, Secretary of the Horticulturists' Union, states that a Rose gardener at Ivry has lost £4000 worth of standard Roses, another at Malakoff £1200, and one at Brie-Comte-Robert £2000. He believes the losses of the other great Rose growers will be proportionate, and may be roughly set down for the neighbourhood of Paris at £40,000.

The flower gardeners at Chevreuse have lost garden plants valued at £16,000. The losses of those at Croissy and Montlignon in flowers that were being reared under frames in pots are estimated at £36,000. Two thousand gardeners' assistants have been for six weeks out of work. It is impossible to compute the injury done to forests and plantations. Trees during the black frost were given the whole length of the bole. In splitting, they gave out loud reports."

— MR. J. FAIRHURST, gardener to P. Blenig, Esq., Beechley, Allerton, near Liverpool, sends a flower of what he considers "A PECULIAR EUCHARIS." It is a large, handsome, well-developed flower, composed of ten equal divisions in two regular series. We have frequently seen similar examples, usually from well-grown plants, but we have not heard of the character being perpetuated.

— THE ESSEX FIELD CLUB.—The eleventh annual general meeting of this Club will take place at the Essex and Chelmsford Museum, New Bridge Street, Chelmsford, on Saturday evening, January 31st, 1891, at half-past six o'clock. The report of the Council for the year 1890, and the Treasurer's statement of accounts, will be read and submitted to the meeting. The election of new members of the Council and officers for 1891 will also take place. No presidential address will be delivered, in order to afford time for the consideration of the important subjects to be brought before the members. The scheme for the amalgamation (in the event of certain contingencies) of the Essex Field Club and the Essex and Chelmsford Museum, and for the establishment of a Local (Essex) Museum, Laboratory, and Library of Natural History, Geology, and Pre-historic Archaeology, will be explained and submitted to the meeting. The object of the scheme is to secure the establishment by the Club in Essex of a purely local and educational museum, library, and laboratory, so as to form a centre of scientific activity and education in the county in connection with the work and publications of the Essex Field Club. The various stipulations are so framed as to ensure the plans embracing the whole county, and not any particular section of it, and that there may be in operation the best methods of working and controlling the Institution under the circumstances obtaining from time to time. The scheme for technical instruction in Essex, submitted by the Council of the Club to the County Council of Essex, will also be detailed and explained to the members.

— WOOLTON GARDENERS' MUTUAL IMPROVEMENT SOCIETY.—The second annual meeting of the above Society was held in the Mechanics' Institute, Woolton, last Thursday evening. The chair was occupied by R. J. Harvey Gibson, Esq., M.A., F.L.S., F.R.S.E., Professor of Botany, Liverpool University. Mr. J. Rothwell, Hon. Sec., read the report as follows:—"The Committee in submitting the report and statement of accounts have to record a successful year's working. The membership although somewhat less than last year is still satisfactory, being fourteen honorary and sixty-nine ordinary, with an average attendance of fifty. The members desire to tender their warmest thanks to the donors of special prizes—viz., to Rev. G. H. Spooner for essay on "Propagation and Cultivation of Hardy Border Flowers" and "Hardy Fruit Culture;" to R. G. Harvey Gibson, Esq., for special prize for collection of "Microscopic Sections of Fungi;" and to Messrs. R. P. Ker and Sons for special prizes for papers on "Selection and Cultivation of Hollies" and culture of "Greenhouse Rhododendrons." The Library has been well used during the year, and the following works have been added:—"Nicholson's Dictionary of Gardening," "Williams' Orchid Manual," "Hogg's Fruit Manual," and "Wright's Fruit Growing." Mr. R. G. Waterman, Hon. Treasurer, stated that the receipts for the year were £7 1s., and exactly that amount had been expended in books and working expenses. The following were the prize winners for essays:—"Hardy Fruit," Mr. Arthur Kime; "Hardy Border Flowers," Mr. Alfred Griffiths; "Hollies," Mr. Harry Corlett; and "Greenhouse Rhododendrons," Mr. R. G. Waterman. Considerable discussion took place as to the advantage such a Society was to the gardeners of the neighbourhood, which was taken part in by the Chairman, Messrs. R. Todd, W. Ker, R. G. Waterman, and others. Messrs. R. P. Ker and Sons again offer a special prize of one guinea for essay on "Spring Flowering Plants," and R. J. Harvey Gibson, Esq., offers a prize of valuable books for paper on "Hybridisation." The Treasurer and Secretary were re-elected, Mr. J. Griffiths was appointed Librarian for the year, and the following constitute the Committee:—Messrs. R. Todd, T. Carling, Breeze, R. Lawrence, J. Griffiths, E. Brockebank, H. Corlett, W. Hough, Davies, C. Mainwaring, A. Kime, Andrews, T. Leadbeater, W. W. Gamble, and T. Sumner. A hearty vote of thanks was accorded to the Executive of the Mechanics' Institute for

the free use of the room, to R. J. Harvey Gibson, Esq., for presiding, and to the Secretary and Treasurer for their valuable services during the past year.

— A NEW HORTICULTURAL SOCIETY FOR BRIGHTON AND SUSSEX.—A largely attended meeting of Sussex gardeners was held at the Odd Fellows' Hall, Brighton, on Thursday afternoon, 22nd inst., to take into consideration the desirability of establishing a new horticultural Society at Brighton. Mr. W. Balchin, jun., presided, and was supported by Mr. Cheal and Mr. Glen, Worth Park. Over thirty persons were present, and Mr. Longhurst read a like number of letters from others, who for various reasons were not able to be present, all promising their most hearty support to the proposed new Society. It was the unanimous opinion of those present that a Society should be started on the same lines as the Chrysanthemum Society, and a resolution to that effect was passed. Six gentlemen, with Mr. Balchin as Chairman, were appointed a Committee to arrange and advertise a public meeting, to be held in the Town Hall at an early date, and take the necessary preliminary steps to the establishment of the same. The gentlemen present at the meeting, together with those who promised their support by letter, may be taken as fairly representative of the county, and if the proceedings of the public meeting prove as enthusiastic as that of Thursday last no doubt the sixty gardeners who have given their support will be augmented by sixty more. May all interested in horticulture attend the meeting.—I.

— THE FRUITERERS' COMPANY.—The annual banquet of the members of this Company was given on Monday night last at the Mercers' Hall. H. R. Williams, Esq., Past Master of the Company, presided, in the absence of Sir James Whitehead, the Master for the current year. There were about eighty guests, amongst others being the Lord Mayor, Sheriffs, representatives of the other City Companies, Major Craigie (Board of Agriculture), Rev. W. Wilks, Secretary of the Royal Horticultural Society, also Messrs. W. Paul, G. Paul, and A. F. Barron. Messrs. G. Bunyard, J. Cheal, T. F. Rivers, and J. Wright were amongst the liverymen in attendance. After the usual loyal toasts, the Chairman said he was occupying the place which ought to have been taken by Sir James Whitehead, who was, he very much regretted to say, detained at home through illness. There had also been received letters of encouragement, and expressing regret for absence, from Mr. Chaplin, the Duke of Rutland and Westminster, Earl Spencer, Lord Dartmouth, Lord Coventry, and others. The Chairman also read a letter from Sir James Whitehead, in which he urged that further attention should be paid to the encouragement of fruit culture in English homesteads. The Chairman, in proposing "The Board of Agriculture," eulogised the power for good which the Board was capable of exercising. He favoured the formation of technical schools for teaching the growth of fruit in this country, and it was one of the objects which the Board desired to promote. In planting trees, he urged that attention should be paid to the adaptation of fruit trees to soils, and insisted that England should grow much larger quantities of Apples than were produced here. In 1889 they imported from abroad 3,612,316 bushels of Apples, worth £974,405; and of other raw fruit they imported 5,791,202 bushels, worth £1,147,439. They were anxious to push this matter of fruit-growing before the attention of the people; and he maintained, in proof of the awakening interest that was already felt, that they had sold nearly 6000 copies of their pamphlet, one of which, specially bound, he presented to the Lord Mayor. Major Craigie responded, and mentioned that in 1890 they imported a smaller quantity of Apples than they did in 1889, showing that more attention was being paid to the cultivation of that pleasant fruit. The Lord Mayor expressed his high approval of the work done by the Fruiterers' Company; and, as the head of the Corporation, he pledged himself to do his utmost to further the work which had been so well begun by the Company, and the Mansion House was at their disposal for a meeting, which, subject to Sir James Whitehead's recovery, will be held early in March.

A JOURNEY TO BURMA.

[A paper by Mr. A. WINKLER WILLS, read at a meeting of the Birmingham Gardeners Association.]

(Continued from page 71.)

RANGOON is a city of some 250,000 inhabitants, Burmese, natives of India, Chinese, English, a city of broad streets and great markets, where tall warehouses and offices stand side by side with bamboo shanties, and all are set in a background of tropical vegetation. The quarters of the European soldiers and the handsome bungalows of the English officials and residents stand on high ground behind the town, and are simply buried in Palms and forest

trees, which attain a great size in the constant heat of the tropics. The thermometer stood at 80° to 85° while we were there, and it was almost the depth of winter, while in the summer it runs up to 100° and even 110°.

The great Schway Dagon or Golden Pagoda is one of the real wonders of the world. It is to the Buddhist what St. Peter's at Rome is to the Roman Catholic, or what the Shrine of Mecca is to the Mahomedan, the central point of that religion which for twenty-three centuries has been the faith of so many millions of our fellow men. To it the pious Buddhist ever aspires once in his life to perform a pilgrimage, and at no time can one visit it without seeing in its precincts types of many tribes and nationalities, Shans and Paloungs from distant parts of Burma and Siam, Cinghalese from Ceylon, Chinese from the Flowery Land, and many others.

It stands on a lofty artificial platform surrounded by luxuriant tropical vegetation, and its great central spire rises from an amazing platform of masonry, swelling out at the base and tapering away in elegant curves to a height greater than that of the dome of St. Paul's, the whole covered with pure gold and surmounted by a tee, a sort of umbrella-shaped appendage, from which hang innumerable bells, which give forth a melodious tinkling as the wind sways them to and fro. It is also adorned with jewels, and the largest ruby in the world is amongst them. The whole tee, which was the gift of King Theebaw in his palmy days, is said to be worth £50,000.

The approach to the Pagoda is up a flight of steps some hundreds of yards long, worn by the feet of countless pilgrims, and covered for its entire length by a teak roof. After passing through a great archway at the bottom, grotesquely carved into forms of huge dragons and quaint figures of men and beasts, you first encounter a row of mendicants who line the sides of the passages, cripples of all sorts, lepers, and other loathsome objects, who extend their skinny arms and hold out their alms bowls for contributions; but even they are cheerful specimens of humanity in spite of disease and poverty, and instead of cursing you if you pass them unheeded they relapse instantly into conversation, not unmixed with laughter, after the characteristic fashion of the Burmese generally.

On either side of the central flight of steps are rows of stalls for the sale of trifles of all sorts, cooked rice and cakes, candles for votive offerings, native Burmese books, &c., &c. Arrived at the top you find yourself in full view of the Pagoda, rising from a vast rectangular base, which is surrounded by hundreds of quaint gigantic figures of mythical beasts and dragons, and of elephants kneeling and standing, all liberally ornamented in gold and vermilion. From the centre of each side of this base projects a large square temple, open at front, and approached between great timber pillars also painted in gold and scarlet, surmounted by exquisitely carved wooden archways and roofs, which rise tier upon tier against the cloudless blue sky.

The interior is full of bronze, wooden, and stone figures of Buddha of all sizes, and at the back is a recess containing some specially sacred image, before which devotees are constantly burning scores of candles, or depositing flowers and quaint paper ornaments. Some carry in cleft sticks little books of gold leaf, which they affix to one or other part of the building as votive offerings, and in every part of the place an odd appearance is imparted by these little square patches of gold standing out in relief against the vermilion, which is freely used throughout. We noticed one column being freshly painted by a man who first daubed the colour on with a stick, and then spread it evenly with his bare hand. It seemed an effective if scarcely a clean way of painting. A paved square extends round the base of the central mass of masonry, forming a great terrace some 40 yards broad, and this again is surrounded by an immense number of courts and pagodas, closely set together, and forming an exterior space some 350 yards long each way. Nearly all are of characteristic Burmese architecture, and their entrances are adorned by wood carvings of extreme delicacy, deeply undercut, and combining conventional scroll work based on plant forms, with life-like representations of men, birds, and beasts.

Nearly all of these buildings contain images of Buddha, hundreds in all, and of all sizes, from 3 to 15 or 20 feet high, of wood, stone, bronze, or alabaster, most of them richly ornamented in gilding and vermilion. In one is a recumbent figure about 40 feet long, with lesser figures of monks and devotees standing or kneeling about the foreground. The walls of this chamber are adorned with frescoes representing some of Buddha's miracles, admirably executed, and especially noticeable for the spirited rendering of characteristic forms of tropical life—animal and vegetable.

In another open court a young Hypoongyee was teaching a class of Burmese novices, who were evidently admiring a series of pictures on the walls, also representing miracles of Buddha, in which men were afflicted with loathsome diseases, or with their

bodies hewn in pieces, were depicted with a very unpleasant realism. The greatest vivacity is imparted to the scene by numbers of people of various tribes and in manifold gay costumes dotted about the enclosure, passing in and out of the temples, and of devotees pacing round the pagoda with outstretched hands and fingers joined at the tips, repeating prayers or passages from the sacred books of Buddhism. Here is a group of Hypoogyies in yellow silken robes and with shaven heads; here a *religieuse* in white dress, very ugly, her ugliness accentuated by her shaven crown; here again a fortune teller, sitting on his mat with his

so'lemn mystery which was overpowering, and which stimulated the imagination in the highest degree. At the second we saw it in the full blaze of tropical day, when every detail of its strange architecture was revealed to us, and the great golden spire stood out in dazzling brightness against a cloudless sky of deepest blue.

We left Rangoon on Monday, December 9th, at 6.30 A.M., by rail for Toungoo, the goal of our long travel. The first two or three hours take us through rich tracts of Paddy, intermingled with unreclaimed jungle, in which huge clumps of feathery Bamboos 50 or 60 feet high (the most marvellously graceful of all created

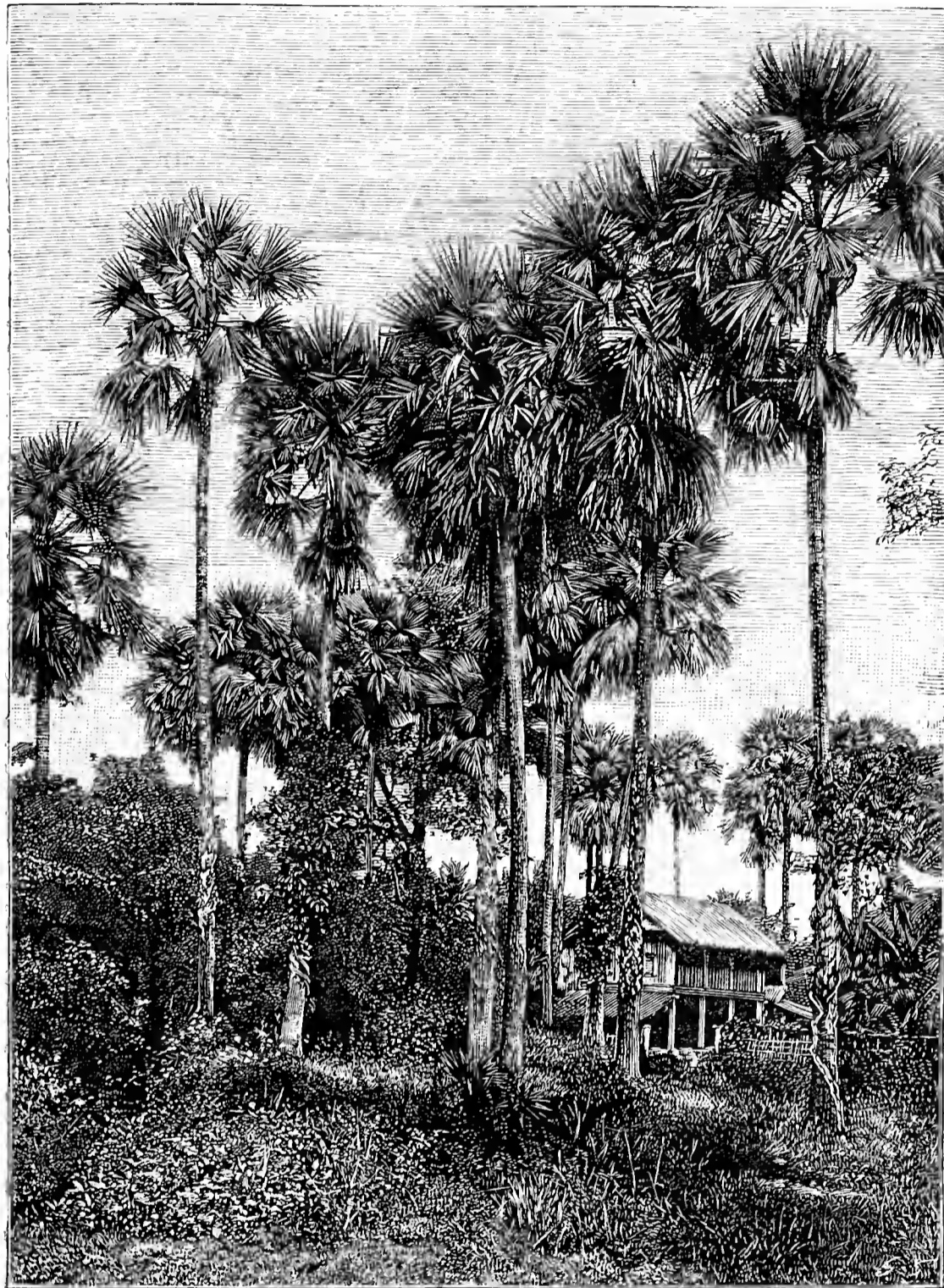

FIG. 16.—BURMESE PALMS, *CORYPHA UMBRACULIFERA*.

properties around him—a desk with a slate on it on which he draws his cabalistic signs, a life sized drawing of an outstretched hand on which are traced the various lines familiar to those who believe in palmistry, a few rude figures of dragons and familiar spirits, and so forth—surrounded by a crowd of people squatting on their heels, and absorbed in the interest of his predictions; here, once more, a devotee sitting on his mat and droning out his devotions in a nasal sing-song tone. The whole scene is so wholly unlike anything we had ever seen in Europe, and of such extreme interest, that I regard our two visits to the Schway Dagon Pagoda as among the most memorable events of our life. At the first we beheld it under the full moon, and its carved roofs and doorways, its innumerable quaint images, its countless calm-faced Buddhas, and its surroundings of glorious vegetation were invested with a

plants, and one of the most useful to mankind) and the scarcely less beautiful Calami or Rattan Canes are conspicuous. Paddy is, of course, the growing crop of which rice is the final fruit, and rice is the mainstay and chief food of the almost countless millions of the east. When he rises in the morning the native of India, Ceylon, or Burma eats his rice, he and his family sitting round the common bowl, guiltless of plate, or knife and fork. He toils as a labourer, or tills the field, or irrigates its crops, or pursues whatever be his vocation in life with unceasing industry till the sun is sinking towards the west, and then only does he again break his fast, and again his food is rice, perhaps flavoured with a little curry.

On the innumerable uses of the Bamboo whole essays have been written. I need only remind you that it is the principal house-building material in the east; that it forms the supports and

the roof tree, the side wall, and the gutter of the dwelling; that its supple stems yield the mast and the yard arm, the thwarts and the tiller, the ribs, and even the frame of the native craft; that its joints form buckets and bowls, boxes and cases; that its slender rods and its young growths are bound together into ladders and its larger ones into scaffolding, and its fibres twisted into ropes. Indeed, it would form a long catalogue if one were to enumerate all its adaptations to the necessities of domestic and daily life.

As you proceed, at every station crowds of Burmese in gay dresses, natives of India, Chinese, Shans, and Karens show how effectually the traffic of this wonderful country is being developed. Birds are numerous. Swallows, mynahs, blue jays, green parrots flit or sweep to and fro, and great flocks of pelicans feed in the swamps, or wheel in magnificent circles with huge outstretched wings. Bullocks and buffaloes are seen frequently in the fields, the former as beasts of draught, the latter drawing primitive ploughs through the irrigated swamps which are soon to be green with growing crops. At one station we saw a number of the finely ornamented racing bullock carts in which the Burmese rejoice, and crowds of their owners and of bystanders waiting for the sport, and ready to stake their rupees on the events, for the Burmese dearly love public games, and bet heavily on the result. After some hours the scenery changes; jungle becomes predominant, and forest trees and leaves fringe the line. Native houses still appear here and there singly and in clusters, and the stations are still thronged by many-tinted crowds. As one comes north the trees become larger, and the rail runs through dense forest, and among the branches are seen thousands of Orchids. Huge Grasses 12 to 15 feet high grow by the acre in damp places, and their big flower spikes shine in the blazing sun like burnished silver. The undergrowth is rich and varied, though at this season flowers are scarce, for it is getting on for Christmas, and in the shade the temperature is only at 85°. At last, after twelve hours' journey, we emerge from the forest, and run into the fine station of Toungoo, and our long pilgrimage is achieved.

(To be continued.)

GROWING MUSHROOMS—A CRITIQUE AND REPLY.

1. IN Mr. Wright's book on "Mushrooms for the Million" it is stated that manure can be obtained at 3s. 6d. the load. I do not find it so. A load contains 2 tons, the standard weight for a one-horse cart. The price obtained for manure is 2s. 6d. a ton, 5s. a load. Add to this 4s. 6d. for delivery, and it is found that 9s. 6d. is nearer the mark than 3s. 6d. A very appreciable discrepancy, eh?

2. It cannot be supposed that 2 tons of manure could be loaded and unloaded, and a reasonable distance covered by the horse, in less than three hours, and the charge for horse and cart and man is 1s. 6d. per hour.

3. Mr. Wright no doubt speaks from personal experience when he says that one load makes only 1½ yard of ridge, but it does seem astonishing that over 26 cwts. can be squeezed into a space 2½ feet at the base, and 2½ feet high, and tapering away to 6 inches broad at the top.

4. Another statement which seems misleading is that in which it is asserted that each yard represents 15s. worth of produce, for assuming that 15 lbs. of edible Mushrooms are grown to the yard, where may 1s. per lb. be obtained wholesale for the greater part of the year?

5. It was particularly noticed here last year that Mushrooms were to be had for a long time for 4d. lb. retail, and probably 6d. to 8d. is the average price all the year round retail.

6. I noticed in last week's *Journal of Horticulture* that Mushrooms were fetching 1s. 6d. a punnet in Covent Garden. I presume the punnet contains 1 lb.?

7. I should gladly appreciate any information you may be able and willing to afford me on the matter. Have you any Liverpool correspondent who grows Mushrooms on a large scale?—ENQUIRER.

[Mr. Wright is evidently the proper person to answer the above letter, and he does so as follows:—If "Enquirer" had read a little more carefully he would have deprived himself of the opportunity for displaying his critical acumen, and the readers of the *Journal of Horticulture* would in consequence have been deprived of the little pleasant reading which his letter affords.

Perhaps your correspondent does not possess the sixth and best edition of the work in question. If he does not he should obtain it, while if he has it he has either not read it or forgotten what it contains in reference to some of the subjects on which he writes; however, he does not read with sufficient care what appears in previous editions, or he would not make the mistake of basing his strongest arguments on false premises, because if these happen to be knocked down his case vanishes. The points are all the same well worth stating, as possibly some of them, and some which appear in the work, may not be clear to all other readers; I am therefore really obliged to "Enquirer" for calling attention to his difficulties in comprehension. Now to the points.

1. *Price of Manure.*—The price named on page 14 of the work referred to is what has been actually paid for thousands of loads in London by Mr. Barter. The statement on the page quoted is his, and it is true. I have nowhere suggested that the price is universal. It would be very foolish to do so, because numbers of persons who can and do grow Mushrooms more or less extensively have plenty of manure with-

out buying at all. In such cases the three-and-sixpenny rate would be, we will say, 300 per cent. too high. On the other hand, a friend of mine has to pay 7s. 6d. a load for manure, and he has been astonished and delighted by the profits he has derived in growing Mushrooms. But there is another aspect of the case. If my critic will turn to page 110 of the work he will find reference to the differing prices of manure; and he will also find a very simple fact stated to the effect that the more manure costs for Mushroom beds the more it eventually realises for gardens when the beds have ceased bearing. There may be exceptions, but that is the rule undoubtedly, and in some cases the manure has been sold for more than it cost to buy, so that the only outlay in growing the Mushrooms was for spawn and labour. A man who gives a high price for manure and sells it for a higher, getting a valuable crop of Mushrooms into the bargain, must, according to point 1, be greatly handicapped, Mr. "Enquirer," eh? Query: Should you not like to be the unfortunate man?

2. *Weight of Manure.*—"A load of manure for Mushroom beds weighs 2 tons," so it is stated in the first paragraph, and continued; therefore the question of weight being a distinct element in the general case, it is convenient to regard it as point 2. I have never advocated the purchase of manure by weight for Mushroom beds, and never shall, at least without seeing it, and giving advice thereon personally. Why? Because, as stated on the page previously cited, "manure that is sold by weight is as a rule too far advanced in decomposition for use in Mushroom beds." Manure of the "standard weight of 2 tons for a one-horse cart," as stated above, is unsuitable for growing Mushrooms, and for that purpose alone I would not have it at any price and pay carriage, nor should I like to be the horse. They must work animals hard at Liverpool, and are not likely to grow Mushrooms profitably with such heavy material.

3. *Making Mushroom Beds.*—I am credited with speaking from "personal experience" when stating that "over 26 cwts. of manure can be squeezed into a space 2½ feet at the base, 2½ feet high, and tapering to 6 inches at the top." My amusing critic is too generous. The statement was not founded on my "personal experience," but is a mental evolution; not mine, please, but "Enquirer's" absolutely, and I would not like to deprive him of a vestige of the credit for the discovery. It is my turn to be generous now. If the gentleman who writes so entertainingly can point to one line out of the 5000 in "Mushrooms for the Million" that contains either those words or their meaning I will undertake a journey to Liverpool, show the author of the statement what kind of manure to choose, "squeeze" a sample together in the right way, and generally do my best to teach him to grow bountiful crops of Mushrooms. I feel sure he would treat me well and that we should get on well together. What do you say to that, Mr. "Enquirer," eh?

4. *Prices of Mushrooms.*—In reference to this subject I am pleased to observe that the remarks on page 15 of this work only "seem" to be misleading. The prices (wholesale) there named were actually obtained, every penny of them. There is no mistake about that, and two years afterwards an equal profit on culture, with lower prices, was obtained by a gardener on his first attempt at growing Mushrooms outdoors through following instructions, but he did not misread, and proved to demonstration (page 119 "M. M.") that I did not mislead. And, further, as showing how careful I was not to do so "Enquirer" is asked to turn to page 122 of the book, and he will see that in consequence of the increased supply it is stated the average London wholesale prices had fallen about 15 per cent. in six years, or 2½ per cent. yearly. If they continue declining at the same rate for twenty more years, which is extremely improbable, a handsome profit will then be derived from full crops marketed at the right time; this, however, comes in the next paragraph.

5. *Time of Profitable Production.*—The fact of "Mushrooms being obtainable at 4d. a pound retail in markets" at a certain long or short period of the year does not invalidate a single statement in the book. Tons are sold at less than that when there is a crowd of them in pastures. I have seen a cartload of field Mushrooms offered for 2s. 6d., and 2s. 6d. a pound given for cultivated Mushrooms the same year. It is wholly a question of supply. But it is exactly when Mushrooms do not and cannot grow in pastures that their cultivation for profit is advocated, and at no other time, and attempts at producing them remuneratively during the hot summer months are also discouraged. The season of profitable production on outside ridges commences in November and ends in July, though a few are grown in October. The table on page 16 ("M. M.") shows this, none for August and September, and that the best time is December to May, both months inclusive. More than that, however, appears bearing on this subject, for on page 105 the different times which beginners should or should not commence preparations are stated with precision—namely, "The end of July is the best time, the beginning of December a good time, October a difficult time, and March a bad time for commencing," for reasons there given. The crops that follow on the instructions being carried out are not produced when field Mushrooms glut the markets, but when good prices are obtainable for good samples. Still if the "average all the year round" (and thus obviously including field Mushrooms) is as stated by "Enquirer," "6d. to 8d. a pound," this is really confirmatory with the work in which the prices are given for good samples grown and sold during the period advised in it. If we take "Enquirer's" lowest price (4d. retail), and take off 25 per cent. for salesmen's commission and marketing, and also take the lowest Covent Garden price at the time he wrote, we have an average of 10½d., and this is in almost exact accord with what appears in the book on page 122. Thus we seem to agree after all, but without my good-humoured critic appearing to know it,

6. *Punnets*.—In weighing Mushrooms a pound weight is placed on one side of the scale, an empty punnet in the dish on the other, then Mushrooms with their stalks on as pulled are added till a balance is arrived at. This is quite fair, for the punnet only weighs a trifle, and is worth more than that trifle to purchasers in the conveyance and delivery of the Mushrooms without their being again "handled," and the punnets are not returned. They are simply sold in with the produce, and so cheaply that purchasers find no fault. Any soil adhering to the roots is shaken off before weighing, but the stems are not cut, or the juiciness and flavour would not be long retained; in that respect, and it is of prime importance to consumers, the plan suits them, and it suits producers for another reason which is not very obscure.

7. *General Information*.—I have endeavoured to give a little information under the different headings, and am willing to give more on any points that may be definitely stated. On page 99 of the book reference is made to a grower of Mushrooms near Liverpool, but whether he grows them still I am not able to say, and should not think it likely there are many persons who grow Mushrooms on a large scale, with manure so wet and heavy that two tons can be delivered in a one-horse cart.

After striving, with very much pleasure to meet the requirements of "Enquirer," I shall perhaps anticipate others in stating that copies of the sixth edition of the criticised work can still be had from the office of this Journal, post free for 1s. 2d., and all readers have full liberty to find as much fault as they like with what it contains. I have no reason to modify my statement that Mushrooms, well grown, are more profitable than any other vegetable crop grown in this country, and all the failures that occur are either the result of unsuitable manure, mismanagement, accident, or weak spawn.]



CHRYSANTHEMUM FANNY BOUCHARLAT.

THIS I find one of the best varieties for late work. This week I have cut some fine fresh blooms for wreath making, and the plants are of good dwarf habit, retaining their foliage better than many of the late varieties. Boule de Neige is also a good variety, but Fanny Boucharlat is fully three weeks later grown under the same conditions, and if thinned freely we can secure blooms of large size. What coloured varieties are good for January blooming?—W. J. I.

MEASURING CHRYSANTHEMUMS.

MR. THOMAS GARD, Bulland, Antony, Devonport, sends for our inspection an appliance he has made for measuring the diameter and depth of Chrysanthemum blooms. It consists of a circular plate with two slits in it, one for the stem of the flower for determining its diameter, the other for the measure for showing its depth, and as both the plate and standard are marked like a measuring rule, the dimensions of blooms are ascertained with exactitude. The appliance is fanciful, no doubt, yet well made and effectual for the purpose in question.

CHRYSANTHEMUMS FOR CHRISTMAS.

IF Mr. Haslam has not already Chrysanthemum Boule de Neige I would advise him to procure it without delay, as according to my experience it is the most useful white Chrysanthemum for Christmas decoration. It cannot exactly be described as a reflexed of the larger size, or indeed as a Pompon, but it is intermediate between the two. It has a dwarf habit, keeping its foliage well, and also being a profuse flowerer. I cultivate it in 6-inch pots, in which size it succeeds admirably. The habit is naturally rather bushy, but we keep it pinched up to the first or second week in July. Ethel we also grow for the same purpose, but in larger pots, and not so closely pinched. Virginal, an Anemone Pompon, is also a very late variety, only just now commencing to open its bloom. It is not a free flowerer, which is against it. This season we restricted the root space to 6-inch pots with better results.—A. YOUNG, *Abberley Gardens, Stourport*.

LATE CHRYSANTHEMUMS.

I LATELY saw in the Smithfield Market, Manchester, blooms of a variety which is a reflexed sport from Princess Teck, being pure white, having none of the blush tint of its parent. For this reason the variety in question will be extremely valuable when it becomes more generally known; at present the stock remains in the hands of one man, who purposes growing 15,000 plants during the coming season. Being reflexed the flowers are more valuable for wreaths than incurved blooms. This variety blooms early in December, and can be had until the middle of February by working the plants in succession. Three cuttings are placed in a 3-inch pot, from this they are transferred to one 5 inches in diameter, and finally into a 7-inch one, in which they flower, each pot carrying from fifteen to eighteen blooms. The side buds are removed to concentrate the energy of the plant into the selected buds. By this method of culture good plants in pots can be had as well as cut flowers, as this variety does not grow tall.

Chrysanthemum Coppellia, belongs to the Japanese reflexed section, is capital for producing late flowers, the blooms are compact, thoroughly

reflexed, the colour blush or white, tinted with rose. Jasper Pozain.—This Japanese kind is excellent for producing late flowers. The colour of the blooms from terminals is a faint blush. At this time of the year I think this colour particularly pleasing, certainly it is to the ladies.—E. M.

BUSH CHRYSANTHEMUMS AT TRENTHAM.

ALTHOUGH Chrysanthemums are largely cultivated at Trentham for the production of blooms for exhibition, this is not the only manner in which they are there grown. Mr. Blair finds that cultivated in "bush" form they are extremely useful, not only for supplying abundance of cut blooms for the vases in the house during the Chrysanthemum season, but for late decoration of the conservatory bush plants are extremely useful. In the second week in January many plants were still in fine condition, and all the leading varieties are tried as they come out. I thought a note would prove useful to some who patronise this method of culture and who desire to know how the newer varieties behave under this mode of culture. I jotted down a few of the best then in bloom as well as others which had previously been tested.

The style of the plants differs somewhat from those grown by others. Instead of repeatedly pinching the points of the young shoots they are topped twice, the first time at 3 inches high, and again when the shoots are about 8 inches long. After this the shoots are allowed to grow freely. Some of the plants run up 6 feet high, according to the variety of course. As a rule they carry three dozen blooms. The small side buds are removed, which concentrates the strength of the plants in the central flower on each shoot. The plants are well supplied with moisture, especially during the summer.

The following varieties were good for the latest supply of blooms. Admiral Sir T. Symonds, single yellow; some of the flowers of this variety were barely developed, the colour bright yellow being especially showy. America, another single variety, blush white, being valuable for late use. Sunflower, Swanley White, C. Orchard, Roseum Superbum, and Mons. Elliott. Other sorts in favour are Madame Rose Owen, Maiden's Blush, Don Quixotte, Soliel Levant, Puritan, Amy Furze, Mdle. Blanche Pigny, George Daniels, Mdle. Louise Leroy, J. Thorpe, junr., and Triomphe de Auzin, the two latter belonging to the Anemone section. Sœur Dorothee Souille, Japanese Anemone, being an especial favourite for this style of growth.—E. M.

CHRYSANTHEMUM CULTURE IN AMERICA.

THE United States horticulturists have taken up the Chrysanthemum with great spirit, and judging from what we see in the illustrations in the *American Florist*, and what we read, that our American friends are scarcely behind us in growing plants. In the *American Florist* of November 27th, in the report of the Chrysanthemum Show at Washington, U.S.A., one plant of W. H. Lincoln is described as having "some 300 bright canary yellow blooms, varying in diameter from 3 to 5 inches, the plant covering an area of not less than 13 feet in circumference." Another correspondent in a very readable article on new Chrysanthemums seen at Mr. Louis Siebrecht's nursery, writes—"Among yellows Mr. S. regards W. H. Lincoln as the very finest in the market. The flowers are very large, full double, high in the middle, of a pure deep yellow, bolt upright, and on stiff stems." The same writer remarks that Mr. Siebrecht had very handsome blooms of Mrs. Alpheus Hardy from plants struck in June. Referring to this variety for a moment, I saw three or four fine blooms in the collection at the Edgbaston Botanical Gardens, and I notice that Mr. J. Aplin gives favourable experience of this variety in the *Journal* of December 25th. I think this variety has not been seen at its best yet, and I know of growers who had condemned it intending now to give it another trial. I fear it undertrich terribly hard propagation before being sent out. Other "ostrich plumed" varieties are before us. Louis Boehmer is well spoken of in the American gardening papers, and reference is made to its promising to become a standard sort on account of its robust habit of growth. This variety is evidently becoming popular in America. Another new variety of ostrich plume is announced as being grown at Montreal, but does not seem to be named yet. It is described as of a deep yellow colour, and of about the same size as Mrs. Alpheus Hardy, but more globular in form and decidedly more hairy. New varieties raised in America are now very numerous, and many of these find their way to us, and many acquisitions will be found amongst them. Many of your readers will remember Mr. John Thorpe, who many years ago was a partner in the firm of Messrs. Bell & Thorpe at Stratford-on-Avon, and on the dissolution of the firm Mr. Thorpe went to New York, and soon became well known in the States as a practical horticulturist. He now takes a very active interest in all horticultural matters, and his name crops up here, there, and everywhere in connection with horticulture. He is one of the Chrysanthemum growers, and so great is the interest taken in the Chrysanthemum now in the United States, that in three numbers of the *American Florist* reports of fifty Chrysanthemum shows and displays in as many different cities and places are given, and many of these places are many hundreds of miles apart. Mr. James Laing of the Forest Hill Nurseries was in America in the height of the Chrysanthemum season, and his experience, if he would kindly give it, would be of great interest to all Chrysanthemum growers and horticulturists generally.—D. S. H.

THE HULL CHRYSANTHEMUM SOCIETY.

THE annual meeting of the Hull and East Riding Chrysanthemum Society was held at the Station Hotel, Hull, on Monday evening, 26th inst., Mr. Geo. Bohn, Vice-Chairman, in the chair. The report showed that the Exhibition of the Society held in November last

was visited by over 11,000 persons, the number of exhibits 308, being an increase of twenty-four on the number shown in 1859, although that year, when the N.C. Society's provincial Show was held in conjunction with the Hull Show, showed an increase of sixty-four on any previous year. The number of cut blooms shown was 3320, being an increase of 1023 on the previous year, whilst there is a balance of £38 2s. 3d. in favour of the Society on the year's working, and a balance in the bank of £276 12s. 7d.

The Chairman of the Society, R. F. Jameson, Esq., had resigned his position in consequence of finding himself in a minority on the Committee on a question of withholding the prize money from one of the exhibitors who had deceived the Judges by unfair practices, which were not discovered until an hour or two previous to the closing of the Show, at which time all the prizewinners in the same class had already received their prize money, and as it was admitted that some of them had also contravened the terms of the schedule the Committee decided not to interfere with the decision of the Judges. As Mr. Jameson took the opposite view he resigned, and although the Committee unanimously asked him to reconsider his decision he declined.

The Chairman, in moving the adoption of the report, made a most conciliatory speech, and upon the subsequent election of officers Mr. Jameson was unanimously re-elected. It is hoped that he will accept the position of Chairman for the present year. All the other officers of the Society were unanimously re-elected, with the exception of one of the Treasurers, who through ill health did not seek re-election. The old Committee were also re-elected without change.—EDW. HARLAND AND JAMES DIXON, *Hon. Secs.*

AS OF A DREAM.

(Continued from page 48.)

WE live now under the shadow of our own Vine and Fig trees, for they occupy a good portion of the wall surface of our cottage, as No. 34 of my exhibit at the Drill Hall, already noted, contained two dozen of Brown Turkey Figs. These ripen, and we gather some dozens of fruit annually. The tree is trained fan-shape. I have never protected it during winter. I hope it will pass safely through the present trying ordeal; if it do I shall feel more than ever in favour of its being planted against cottage walls, as the Fig seldom becomes affected by blight, and its foliage looks handsome anywhere. A market can always be found for the tempting luscious fruit.

No. 35 contained a plate of Royal Muscadine Grapes, as negligently grown on my cottage wall for the purpose of making wine. I put a stress on the word negligently, for that is exactly how it applied to them. I have the small greenhouse here erected at the end of my cottage which I used at Woodstock for producing seedling Potatoes. In those days of the murrain it was impossible to raise these in the open ground. I lead a branch or two of the Vine in at the top glass at the back, and train them down over the wall surface. Capital Grapes can be had in this way much earlier, and with little trouble. Those outside are allowed to take a comparatively free rambling, and if they do not become quite ripe, or tempting enough to eat, so much the better for the wine. I still grow my old favourite, the Black Esperione.

Coe's Golden Drop and the Jefferson Plums formed No. 36. The first has a place on the north-western end of my house, and the other as a bush tree in the garden. Splendid Plums they are to command the world, but the trees require great attention on account of their various enemies. Next came a plate of the old White Bullace, No. 37, which for wine, jam, pie, children, and birds can be commended. This and the common Berkshire Plums, previously spoken of, appears to have been the chief of the stone fruits on this old place. No. 38, a fruitful branch of Tomatoes, I took up merely to show how they would not ripen this year in the open. We are very nearly vegetarians here, and Tomatoes will become indispensable. I ripen them easily without fire heat near the front glass in the above-mentioned greenhouse. No. 39, two sections of honey. Now I go again into history. I wonder if the "Cottage Lamp" is still to be found in your archives or pigeon-holes? If not, turn to those splendid illustrations on pages 602, &c., 1862, and you will see how "like a young boy" I there depicted my own primitive inventions. I make the bees work in these modern wooden supers, as supers, on the tops of my old straw hives. As to mead, honey beer, honey vinegar, &c., &c., how often has "Our Doctor" sat in judgment upon them? and I fear those articles you can find in your pages have given him decided trouble to shape.

I told in these pages, too, lang syne, how the beautiful allegory of Scripture won me over to plant Vines and Figs against the old rectory at Woodstock. I left the place fourteen years ago. About two months since I made my first re-visit to the ancient borough, and of course called at the rectory. To my surprise I found the old Vines growing against the house, and trained after the fashion that I left them, but the whole surface of the garden, where the chiefs of our present race of Potatoes had their origin, is laid down to grass for the purposes of lawn tennis or croquet. The old garden walls, however, still maintain Knight's Monarch and Hacon's Incomparable Pears that I planted. The present rector has worked great improvements in the churches. The late Duke of Marlborough went with Mr. Majendie, which of course proved a great help towards the accomplishment of these things. I found the whole town, too, is planted with flourishing young trees, lining the streets on both sides, and the young Vines planted in my time are covering the front walls of many of the houses. Nevertheless, Woodstock seemed to me almost as a "city of the dead," not a vehicle of any

kind, and scarcely a human being about; my footsteps, as I hastened to catch the three o'clock train (a loop line of but yesterday) seemed to resound from across the High Street.

Home made wines seem naturally to follow the above observations. I cannot abuse the uses or the making of them without laying myself open to censure as "a faddist." Besides, is it not written in Nos. 235 and 236 (old series), and in Nos. 225, 236, &c., &c., *Journal of Horticulture*, the reason why, and how when opportunities offer and domestic economy chimes in, these beverages are wholesome, strengthening, and convenient by consequence of saving the brewer's bill? Many of my best friends are "total abstainers." Well and good. Soon after I came here I tapped one of the finest springs of water to be found in the country. It is perpetually at their service when they elect to come and see me. As my stand was meant to point out, all superfluous small fruits remaining for me after their "preserving time," or what is wanted for eating, or for pies and puddings, I work into wine. I took up three bottles, and one other containing vinegar, to explain away the extremes for utilisation. The wines were Rhubarb made in 1852, Gooseberry made in 1866, and a bottle of the present year from mixed fruits, of which I have 70 gallons in cask. I have also made a small barrel of Royal Muscadine and Esperione Grape wine, plus a barrel of cider from the Pay-the-rent. Hereby hangs a tale. In the second year of my residence here I sold my Apples to a merchant in Reading. I called upon him again in the third autumn time to try and bargain again for 5s. per bushel, the Apples to be carefully hand-picked from the trees, sampled, properly packed, and delivered free to his premises. He said, in a pompous, independent, haw haw manner, and pointing to some half-dozen casks, with their ends out advertising the fruit, "I have just received 1000 barrels of those Apples from America, and I'll give you the same that I gave for them, 2s. 6d. per bushel." I stepped across the pavement, disturbed the top layer of fruit to get a peep at the wretched bruised looking specimens below, for I had heard a good deal about the Americans assorting their Apples as an exemplar for us English. Well, I said, paying pomposity back with its own coin, if I were to offer you rubbish like those from my orchard at 2s. 6d. per bushel I should consider that I was insulting you. I was decidedly nonplussed as, upon further inquiry, I found our merchant's prices ruled all Reading.—ROBERT FENN.

(To be continued.)

RENOVATING ORCHARDS.

IT is, I think, noteworthy that in a fruit plantation of several acres under my charge here, with two or three exceptions our crop of Apples last season was the produce of young trees—that is, trees that have taken the places of those worn out or unsuited to the soil and from four to twelve years planted. The sorts most productive were Waltham Abbey Pearmain, King Pippin, Keswick Codlin, Lord Suffield, and Grenadier; while from old trees the only sorts were Winter Queening, Northern Greening, and Wellington; the other trees only produced an Apple here and there. The crop altogether did not exceed a hundred sieves, which after providing for home use allowed seventy sieves for market. Although this may be considered a small crop, yet my employer thinks it a fair one for the year; but I asked him what would have been his portion of crop if he had not taken care of his trees for years previously? When he came here fifty years ago it was then a fruit plantation, mostly Cherries. These he found like Hop-growing, too risky, so much fruit was spoilt in adverse seasons before getting them to market. He therefore gradually removed these and planted Apples and Pears of the best sorts; the custom has always been annually to have the trees marked for removal that prove worthless, also those worth grafting. Pruning is regularly done (one man has done it for over thirty years), manuring every other year, and the ground regularly dug and hoed frequently in summer. This is considered the proper way to manage an orchard, but it is regretted that so many orchards are going to decay through neglect and no fruit, while the gentleman I have mentioned employs labour, enjoys his ramble through the plantation, and says he has never been without a crop of fruit according to the seasons.

I ought to mention we have had a good crop of bush fruit, about forty sieves of Red Currants, twenty-five of Black Currants, and just over fifty-five sieves of Gooseberries. The above is sufficient proof if any were needed and after what has been lately advanced on fruit growing that it is much better to look after a plantation than neglect it.—T. RECORD.

FLORIST FLOWER SOCIETIES IN BIRMINGHAM.

THE Midland districts around Birmingham contain many cultivators of Pansies and Picotees and Carnations, but for a long time have had no opportunity of having exhibitions of these flowers in their own districts. Taking the Pansy first, a Midland Counties Pansy Society has just been formed for the purpose of encouraging the cultivation of this popular flower, and the raising of first-class seedlings. For this year, exhibitions are confined to eight surrounding counties; but new varieties and seedlings for certificates are invited from all parts of the kingdom, and an Exhibition will be held in Birmingham early in June. There are a large number of cultivators of the Pansy in the Midlands, and such a Society is much needed.

Birmingham is well known as a strong centre for Carnation and Picotee growers, and Mr. Robert Sydenham has worked hard to form a Midland Carnation and Picotee Society, which shall in no way clash with the great Exhibitions at Oxford and Manchester, but will enable

the Midland growers to meet on their own ground, and give the Black Country people an opportunity of seeing a great gathering of the finest flowers and new varieties. An Exhibition of the Carnation and Picotee on a large scale is arranged for July next, to follow immediately after the Oxford Show.

The Pink, which has long been a greatly neglected flower, is slowly and surely coming to the front again, and a gathering of Pink growers and an Exhibition of Pinks is arranged for at the Great Wolverhampton Summer Show in July next, and will do much to give an impetus to the further cultivation of this fine old florists' flower and border plant. I do not know if the Committee are arranging a class for bunches of the border decorative sorts; but I hope it may be done, as we have many beautiful kinds which are outside the florists' circle of varieties, and are yet so richly deserving encouragement, and of having an opportunity of being seen by the public.—W. D.

THE CHERRY PLUM AS A FENCING PLANT.

SOME weeks ago we referred in our Farm article to the usefulness of the Myrobella or Cherry Plum (*Prunus domestica myrobalana*) for fencing purposes, and as several inquiries have been received for further information we are enabled, by the courtesy of Messrs. Daniels Bros., Norwich, to give illustrations of the plant (figs. 17 and 18). The following particulars are also furnished in their catalogue:—

"This was introduced for fencing purposes by the late Mr. Ewing of the Eaton Nurseries, and has undoubtedly proved itself to be the very best fencing plant ever grown. For rapidity of growth it is unrivalled, and under fair conditions will make a capital fence in three or four years from planting. It also grows vigorously in the poorest soils, and is first-class for planting in exposed situations or by the sea coast. It is quite hardy, and will stand the severest frosts without injury. The Myrobella does not often fruit in this country save in the south or west of England and in sheltered positions in the eastern or midland counties, and then only when allowed to grow into trees or large bushes. It, however, forms a capital stock for Plums, and if strong single stems are allowed to grow from the fence at intervals of about 12 feet, they may be budded or grafted with choice varieties of this popular fruit, and in a few years will form a most profitable and ornamental hedgerow.

"The best time for planting is in November or early spring, or it may be done in open weather at any time during the winter months, but in fairly moist weather successful plantings may be made as late as the middle or end of April. In planting plant firmly, placing the sets from 6 to 9 inches apart, according to size. After planting, about the time that growth commences, they should be cut down to 8 or 10 inches in height. It will bear almost any extent of clipping, and should be cut at least twice a year—about the end of July and in winter or spring whilst in a dormant state, and should be fairly trimmed



FIG. 17.—BLOSSOM AND FRUIT.

the first year or two after planting to ensure a good bottom for a strong and thick fence; but it may be clipped in to form a fence no thicker than an ordinary garden wall, which will be found quite impenetrable. As the plants advance in age the branches become armed with long,

sharp spines, which make the fence impenetrable to cattle, &c. Myrobella will, therefore, be found splendid for making new or improving old fences, and much superior to Whitethorn or any other fencing plant."

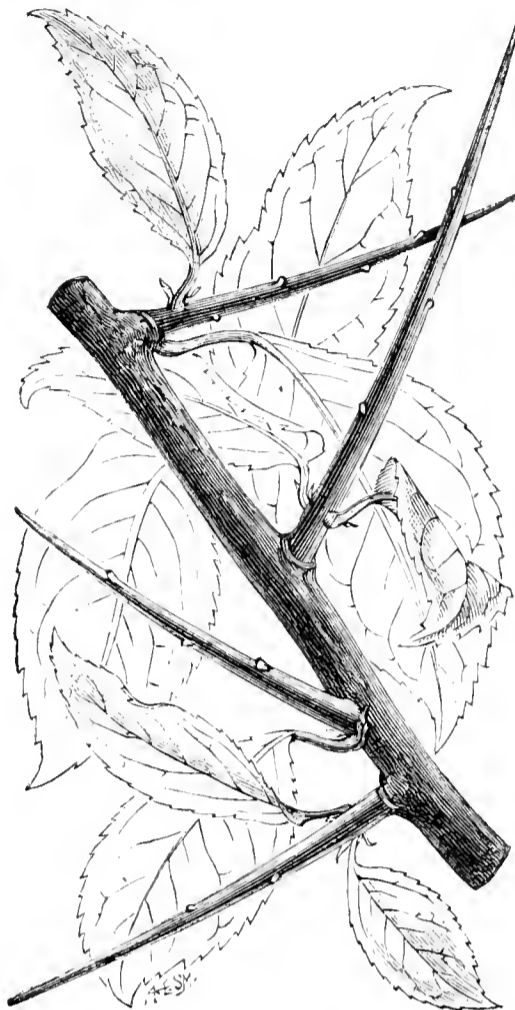

FIG. 18.—OLDER BRANCH WITH THORNS.

REVIEW OF BOOK.

Webster's International Dictionary of the English Language, revised and enlarged under the direction of NOAH PORTER, D.D., LL.D., of Yale University. George Bell & Sons, 4, York Street, Covent Garden. 1890.

It has been said that dictionaries are not compiled until a language has commenced to decline, or at least until it has reached its fullest development. Certainly until the invention of printing little appears to have been done in the direction of such compilations, and though a few lexicons date back to before the Christian era, they are relatively in small proportion to the wealth of the languages of antiquity. The dictionary form of conveying knowledge of a language has, however, had an enormous development in modern times, that if the numbers of such works were really an indication of decline, as stated above, the English language would be in a serious condition. As a matter of fact, however, it appears to increase at a very rapid rate, and dictionaries that a few years ago were amply sufficient for purposes of reference are now quite inadequate. New words are being constantly introduced, scientific expressions and technicalities appear frequently in newspapers and general literature, and new editions of dictionaries are called for nearly every year to keep pace with the advance. A complete dictionary of the English language of the present time is an encyclopædia in a condensed form, and indispensable alike to readers and writers.

Webster's Dictionary has for many years had a considerable reputation on both sides of the Atlantic, and fresh editions have been issued from time to time containing additional features of interest. In the one under notice, however, we have to record an advance of great importance, which renders it one of the most valuable works of reference of the present time. It forms a large quarto volume of 2118 pages, and after a close examination, more especially directed to testing the botanical and horticultural definitions, we can testify to the remarkable accuracy which distinguishes it, and the evident care exercised in its supervision.

The enumeration of the chief sections of the work will give an idea of its scope and utility. First there is a memoir of Noah Webster, by Dr. Chauncey H. Goodrich; then we have a list of authors quoted, which occupies ten pages closely printed, three columns to a page. The "History of the English Language" is fully treated upon, a list is furnished of "Indo-Germanic Roots," followed by chapters on pronunciation and orthography. These constitute the introductory matter.

Coming to the Dictionary itself we find that 1681 pages of three columns each are devoted to word explanation, giving accentuation, pronunciation, definition, with quotation examples in the case of critical words, and illustrations of those that do not readily admit of brief verbal explanation. In the appendices we have also much important information. "An explanatory and pronouncing dictionary of the

names of noted fictitious persons and places," occupies thirty pages, and is a novel feature in a dictionary. An exhaustive pronouncing gazetteer follows, and a biographical dictionary including 10,000 names. Vocabularies of Scripture, Greek, Latin and English names are added. There is a capital list of quotation words, phrases, proverbs, and colloquial expressions, with lists of abbreviations, arbitrary signs, &c. Besides the illustrations scattered through the text the work concludes with classified lists of pictorial illustrations, occupying eighty pages, and though the engravings are small they are very clear and well adapted for their purpose.

The work is printed in excellent type, on good paper, and is in all respects admirably executed both in the editorial and publishing departments.

THE FROST RECORD, 1890-1891.

WE are indebted for the following official and authoritative record of the frost during the present winter to G. M. Whipple, Esq., B.Sc., the courteous and experienced Superintendent of the Kew Observatory. Much useful work is performed at this establishment, concerning which we hope to publish some particulars at an early date; in the meantime it will be interesting to have a reliable register of so prolonged a frost. The Kew Observatory, it may be added, is not connected with the Royal Gardens, but is under the management of a Committee appointed by the Royal Society, and is one of the first-class stations of the Meteorological Office.

TABLE SHOWING THE DAILY MINIMA AT KEW OBSERVATORY DURING THE LATE FROST, NOVEMBER, 1890—JANUARY, 1891. Extracted from the records by permission of the Meteorological Council.

Date. 1890-1.	Min. Temperature.		Date. 1890-1.	Min. Temperature.	
	In air.*	On ground.†		In air.*	On ground.†
	deg.	deg.		deg.	deg.
November 25	31	20	December 25	21	15
" 26	26	25	" 26	25	13
" 27	23	20	" 27	30	20
" 28	21	19	" 28	26	12
" 29	22	16	" 29	26	28
" 30	21	15	" 30	21	24
December 1	25	18	" 31	21	19
" 2	30	19	January 1	28	28
" 3	34	31	" 2	24	20
" 4	36	34	" 3	27	23
" 5	35	34	" 4	32	25
" 6	36	36	" 5	27	23
" 7	34	27	" 6	24	20
" 8	31	28	" 7	24	20
" 9	29	20	" 8	23	9
" 10	29	23	" 9	21	17
" 11	24	25	" 10	15	9
" 12	23	19	" 11	13	9
" 13	16	14	" 12	19	15
" 14	17	9	" 13	34	27
" 15	21	11	" 14	33	26
" 16	24	18	" 15	30	26
" 17	24	26	" 16	25	29
" 18	25	19	" 17	23	16
" 19	25	26	" 18	20	11
" 20	15	11	" 19	20	11
" 21	27	26	" 20	28	22
" 22	11	11	" 21	30	23
" 23	18‡	7‡	" 22	29	21
" 24	24	28			



FRUIT FORCING.

VINES.—*Early Forced Vines in Pots.*—Thin the bunches somewhat freely, so as to induce larger berries, not, however, going to the extreme of making the bunches loose, though that is better than small-berried bunches. Maintain the temperature at 65° at night, falling to 60° on cold mornings; but raise the heat in good time to 65° or 70° by day and 70° to 75° when mild, admitting air at 75°, increasing the temperature with sun heat to 80° or 85°, closing the house at 80°, with a prospect of an advance to 85° or 90°, at the same time damping the house. Damping is also necessary in the early part of the day. Afford copious supplies of tepid liquid manure. Observe great care in ventilating.

Earliest Forced Houses.—Remove all loose and duplicate bunches,

* Minimum for twenty-four hours ending at midnight (thermometer 12 feet above ground). † Minimum for twenty-four hours ending at 10 A.M. ‡ Occurred at S.P.M.

NOTE.—On December 14th the mean temperature for the whole day was 20°. On December 22nd the mean temperature for the whole day was 17°

thinning the berries as soon as they become well formed, but do not defer this longer when the properly fertilised berries are distinguishable by their taking the lead in swelling. Where no fermenting materials are used in the house fill the evaporation troughs with guano water (1 lb. to twenty gallons of water), and the borders and other available surfaces may be sprinkled at the time of closing—early in the afternoon. Where results are of more consequence than appearance a portion of the fermenting materials may be removed, and the whole surface inside covered lightly with thoroughly sweetened manure from the stables, which should be turned several times before it is introduced, or the ammonia vapour will be too strong for the tender foliage, which may, however, be obviated by admitting a little air at the top lights to allow any excess of vapour to pass off, as it will in a day or two. The inside border before being covered with the sweetened stable litter must have a good supply of tepid water, not exceeding 90°, or liquid manure. This, with the leaves in an active state, will incite root action, and the berries will swell freely. Avoid cold currents of air, also steam arising from highly heated hot-water pipes, both causing rust. The heat of fermenting material on outside borders must not be allowed to decline. Where no fermenting materials are used take care to prevent the roots in outside borders becoming chilled by cold rains or snow, having wooden shutters or tarpaulin so disposed as to throw off the rain or melted snow. Attention will be required in tying the shoots and in stopping the laterals. It is assumed that the shoots have been stopped two or more joints beyond the fruit. Where the space is restricted they may have been pinched to one or two joints, and in any case the axillary growths may be stopped at the first leaf, and to one afterwards as fresh growth is made. If this is likely to interfere with the principal leaves the axillary growths may be rubbed off except from the two lowest joints, those above the fruit being stopped to one leaf. It is of the utmost importance that the principal foliage be fully exposed to light and air, overcrowding and overcropping being in the highest degree prejudicial; at the same time very close stopping is not to be recommended where there is room for extension, as an increase of foliage promotes corresponding root action, therefore preserve all the foliage consistent with its full exposure to light.

Houses in which Vines are in bloom should have a steady night temperature of 65°, 70° to 75° by day by artificial means, and 5° to 10° more from sun heat. Muscats must be kept 5° higher all round. Black Muscat and other varieties liable to set indifferently may be assisted by tapping daily, or more certainly by brushing the bunches lightly with a camel's hair brush, then apply ripe pollen from free-setting varieties, drawing a brush filled with pollen lightly over the bunches. A constant circulation of warm rather dry air is conducive to a good set, and it is advisable not to stop the growth closely during the setting period, but avoid allowing growth to be made which must afterwards be reduced in quantity. That gives a check highly prejudicial to the health of the Vines, and does not favour the swelling of their crops.

Vines Started at the New Year.—Continue syringing the rods twice a day, but do not keep them constantly dripping, and so induce aerial roots on the rods, for these have a weakening tendency. Continue syringing until the bunches are formed, when it must be discontinued, but maintain the atmospheric moisture by damping the paths and borders three times a day. Increase the temperature to 55° at night, and 60° to 65° by day, with an advance from sun heat to 75°, with ventilation in accordance with the state of the external air. Avoid damping the hot-water pipes when they are highly heated; the steam is highly inimical to tender foliage, and the moisture very different from that given off by cooler surfaces. Keep up a supply of ammonia by turning over fermenting material, frequently adding a few fresh horse droppings, or if these are objected to the house may be sprinkled with liquid from stables diluted with six times its bulk of water. A 3-gallon water-potful of diluted liquid is sufficient to sprinkle a square rod (30½ square yards) of flooring or border surface, and is best applied in the afternoon or evening following the usual damping with water. The evaporation troughs may be filled with the same, but it is important not to make a mistake in applying the liquid too strong.

Do not be in a hurry to disbud, letting the growths advance until the bunches appear in the points of the shoots, then the weakest and otherwise least desirable can be removed; but it should be done gradually so as not to cause appreciable check.

Houses to Afford Ripe Grapes in July.—Early February is the latest time for starting Vines to finish fruit satisfactory soon after mid-summer. Nothing is well done in a hurry. Vines are no exception. They require time and suitable condition for the performance of good work. Outside borders need not be covered with fermenting material, but a covering of leaves and a little litter over them to prevent their blowing about will afford all the protection required at this season of the year; all that is necessary is to prevent chill. Close the house at once, merely use artificial heat to exclude frost at night, and maintain a temperature of 50° in the daytime. This to some extent will cause the sap to rise, and a light damping occasionally assists in softening the epidermal layers, the tissues below being more readily acted on by moisture and warmth. A bed of fermenting materials inside the house conduces to a good break by securing a uniform moisture, but they need not be introduced until the Vines are started. Then supply the inside border with tepid water, or preferably with liquid manure at a temperature of 90°, repeating as necessary so as to thoroughly moisten the whole border through to the drainage. Syringe the Vines three times a day, using water not less in temperature than the house. Maintain the temperature at 50° at night, 55° by day artificially, and 65° from sun heat.

THE FLOWER GARDEN.

Propagating.—When the stock of Heliotropes, Ageratums, Verbenas, Resines, and Coleuses is comparatively small there is all the more necessity for commencing early with their propagation by cuttings. Soft young shoots, such as will soon be formed by the old plants, when these are subjected to a moderately brisk heat and rather moist atmosphere, strike the most readily and are always to be preferred. If a close frame over a heated tank or hot-water pipes is available a good depth of either sawdust or cocoa-nut fibre should be placed in this. Kept well moistened this plunging material will conduct the heat properly, but if allowed to become dry it will fail to do so. Dibble in the cuttings rather thinly in either pans or well drained pots filled with moderately rich sandy compost. Keep them close, wipe the glass of frame dry every morning, and water whenever the soil approaches dryness. Cuttings thus treated strike quickly, and having good soil to root in soon grow strongly, first the tops and then side shoots being in their turn available for making into cuttings.

Other Methods of Propagating.—All the kinds of plants named will strike surely and quickly if the cuttings are inserted somewhat thickly in water-tight pans filled with sand and water, and then set either on the hot-water pipes or in some other very hot position. They must be very closely attended to, as should the sand once be allowed to become dry this would prove fatal to the cuttings. When the roots are about 2 inches long the plants ought to be potted or boxed off, using rather light well warmed compost for the purpose, the plants being kept growing in brisk heat. Hotbeds of leaves and manure, or either alone, are of good service for propagating purposes, frames or bottomless boxes with glass coverings being set on these and filled with cuttings in pans or pots. If there is much steam in the beds it will be necessary to leave a chink of air on the frames for a time, and later on when they may safely be kept closer to dry the glasses every morning. Cuttings generally to be carefully shaded from bright sunshine and never allowed to become dry.

Abutilons.—Variegated, notably A. Thompsoni and improved forms of the same, are very effective bedding plants, and a fairly large stock, or enough to dot over a good sized bed, among a groundwork of dwarf flowering or fine-foliaged plants, could be propagated from one strong plant. Place this in heat and take off the top, rooting this if possible. Then, according as the side shoots attain a length of about 4 inches, take these off with a heel of old wood attached, and root them in a brisk bottom heat. Pot them singly, and shift the most forward into 5-inch or rather larger pots.

Cannas from Seed.—In order to have strong plants by bedding out time seed must be sown early. When received they will be found exceedingly hard, and unless softened prior to sowing germination will either not take place or be very slow. Soak the seeds for twenty-four hours, or till they have swollen considerably, in a jar of water either plunged in a strong bottom heat or set on the hot-water pipes. If in the latter position see that the water does not all evaporate and leave the seeds dry, or they will be spoilt. Fill the jar with more hot water when left the last thing at night. When the seeds have softened somewhat transfer them to pans or pots of warm peaty soil, and plunge in a strong bottom heat till they have germinated. Before the seedlings are far advanced pot off singly, using rich soil and 4-inch or rather larger pots, and keep them growing in heat. The beautiful Crozy's hybrids being very superior flowering forms of Cannas are raised in the same way, and would flower by the middle of July.

Acacia lophantha.—This also is of good service in the flower garden, either for dotting or mixed beds of flowering or fine-foliaged plants. Plants obtained from seed last season and kept in pots would be suitable for the larger beds this season, but are quite useless for propagating purposes, and more seed must perforce be sown. The seeds are large and very hard, and must be treated exactly as recommended in the case of Cannas. It is possible to have neat plants in 5-inch pots by the first week in June, but not if the seedlings are checked in any way. Pot them early, and keep them steadily growing in a warm greenhouse.

Grevillea robusta.—Another somewhat slow growing green-foliaged plant, and which is frequently used in the flower garden. It is propagated from seeds, these being large, flat, and fairly soft. Sow at once in a pan of light or peaty soil, plunge in a hotbed or place in some other warm position, give a watering, and cover with a square of glass. The seedlings to be first potted placed singly into 2½-inch pots, and then shifted into 5-inch pots. Kept steadily growing they ought, by bedding out time, to be 9 inches high.

Tuberous Begonias.—The seed of these ought to be sown early or not later than January, for the twofold reason that it germinates more surely if sown before the sun gains much power, and also because early germination gives a longer period for the plants to attain a serviceable size by bedding out time. The single varieties are more effective in beds than the doubles, while the erect flowering forms of the former are much the most showy; but the drooping varieties are very suitable for vases and hanging baskets. More than ordinary pains ought to be taken in sowing this very minute seed, or the chances are a failure to germinate will occur. Either good sized pots heavily drained or pans may be used, these being firmly filled with fine peaty soil, the surface being quite level. Water through a fine-rose pot, and in the course of a few hours sow the seed evenly on the surface. Do not cover it in any way, not even with silver sand, this doing more harm than good; but plunge the pans or pots in a hotbed where there are no worms, nothing being better than sawdust on a bed of leaves and manure. Cover the pans or pots closely with a square of glass and shade heavily. There being plenty of moisture in the plunging material there ought to be no

necessity for moistening the soil in the pans or pots till after the tiny plants are to be seen. At the same time it must be closely watched, and if approaching dryness be moistened upwards by partial plunging in a tank or pail of warm water, overhead watering being fatal as it disturbs the germinating seeds; much less shade to be given after germination has taken place, and the seedlings ought to be pricked off in good light compost as soon as they can be moved with the point of a label.

Dwarf Lobelias.—Excellent strains of bedding varieties can now be purchased, this doing away with the necessity for taking so much trouble in propagating either by division or cuttings. If the seed is sown and otherwise treated much as advised in the case of Tuberous Begonias, thousands of plants will soon be fit for pricking off into boxes and pans. Avoid sowing too thickly, crowded seedlings being liable to damp off wholesale.

PLANT HOUSES.

Adiantum cuneatum.—Young plants that were potted some time ago and are rooting freely should be placed in a temperature of 60°; they will soon yield useful fronds for cutting. Introduce those that have been resting for some time into a temperature of 5° higher, syringe amongst the pots, and keep the soil rather moist at the roots. If they have been troubled with slugs dust the crowns liberally with soot, which will soon bring these pests out of their hiding places. If the plants have filled their pots with roots and it is not desirable to increase their size cut the plants in two, and pot the divisions without disturbing the balls further, except for the removal of the old drainage from the base. Use as a compost fibry loam two parts, the other two being composed of leaf mould, sand, and old lime rubbish. Supply water carefully until the plants are rooting and growing freely. Place them in the temperature advised above. Plants from which all the best fronds have been removed must be trimmed and placed for a time in a temperature of 50° to rest. Young-growing well-rooted plants in thumb pots should be placed into 3-inch pots. Seedlings in boxes may be potted singly into thumbs. To prevent these drying unduly plunge the pots in cocoa-nut fibre refuse, ashes, or other material in boxes or on the stage.

Isolepis gracilis.—Some of these that have been in use during the autumn and winter will begin to be shabby. Select the worst, and divide them into two, three, or four pieces according to their size, and pot them into 60's. Place them in a vinery or Peach house, where the temperature ranges about 50° to 55°. They will grow freely, and soon be ready for decorative purposes. Isolepis that have their pots full of roots will improve if artificial manure is applied occasionally.

Pteris serrulata.—If these are in small pots they may be placed into others 2 inches larger; if in sizes as large as are required carefully reduce the roots, and repot into the same size. These plants, as well as seedlings, grow freely in vineries and Peach houses that are just started. It is wise to raise annually a good number of seedlings to take the places of any that are damaged. When a good stock of young Ferns is raised there is no necessity to reduce those which have filled their pots with roots and been injured by room and other forms of decoration.

Microlepia hirta cristata.—Microlepias in 5 and 6-inch pots which have been damaged in rooms may be divided and placed into small pots. They will soon begin to grow in heat, and if repotted will make useful plants in 5 and 6-inch pots by next autumn. Where plants of a larger size are needed place some of the plants in 7 or 8-inch pots. Pots from 4 to 8 inches in diameter are more useful than those of larger size. This Fern does well in three parts loam to one of leaf mould and sand.

Polystichum proliferum.—A very useful Fern, especially in small pots. It grows freely in old soil from Cucumber and Melon beds if leaf mould is incorporated. The plants soon commence producing new fronds if placed in a temperature of 50°. Established plants that had their fronds pegged down in August or September will have abundance of young ones attached to them that are well rooted. Transplant these singly in boxes, and place them in a vinery; they will soon grow sufficiently to be ready for small pots.

Davallia Mooreana.—This Fern succeeds well in baskets, and the specimens are beautiful when 4 or 5 feet in diameter. Plants are useful, however, in 5 and 6-inch pots for room decoration and furnishing purposes generally. From large plants in pots or baskets a good stock of young plants may quickly be raised by thinning the rhizomes and placing two or three pieces into each pot.

Cyperus distans.—Seedlings raised as directed some time ago may produce a small flower spike from the centre. They frequently do this in small pots when growing through the winter; remove the spike and place the plants into larger pots. Seed may be sown at once on the surface of the soil in pans, well water them, and cover with a square of glass. Place the pans in heat. Plants that are doing duty now may, when past their best, be cut over; they will soon grow again from the base and flower. These are not only useful in pots, but their heads are invaluable for cutting, and can be used effectively in large and moderate sized vases with flowers.



APIARIAN NOTES.

BEES FLYING AND COVERINGS.

OUR neighbours' bees flew well on January 11th, 12th, and 13th, but our own flew partly only on the 13th. The cause of some

flying before others is entirely due to the crown covering, the former being in a great measure covered with impermeable or waterproof material. The merest tyro cannot fail to observe that when hives are covered closely on the top with waterproof material it renders them damp within, causing the bees to be restless and likely to air themselves in too low a temperature, and when the ground is cold and wet. The conditions that tend to keep bees quiet are those that the bee-keeper should study to provide. Had January 13th, the day on which our neighbour's bees flew, been windy instead of being calm as it was many would have been lost. In all my experience I never witnessed bees in better order, and never had fewer deaths. Some hives have not as yet shown a single dead bee, while in the worst they do not exceed seventy.

BREEDING.

This may not have started quite so early or rather so late in December as is often the case, but I have no doubt but all are at it now, and as all are allowed to keep the pollen gathered in the autumn, which was plentiful, the best and proper place for it, the bees will not be compelled to fly out in untoward weather, and I will take care none goes back for want of food, and no bee-keeper should neglect this important matter if he is anxious for surplus honey. Bees should never have less in store during the spring and early summer months than 10 lbs. I shall not attempt feeding the bees until the mean temperature is about 45°, but whenever they have had a thorough airing and the temperature is right I shall begin it. All stocks that were built up from nuclei late in the year having no pollen and fed entirely on sugar are in the best of health, sufficient to convince the greatest sceptic that bees do not require pollen during winter or except for breeding purposes.

FUTURE PROSPECTS.

Should the remaining part of winter and the spring prove favourable to bees they will be in splendid condition for gathering surplus honey early in the summer, and we all wish for a fine one. Hellebore or Christmas Roses are in bloom, but Snowdrops, Aconites, and Crocuses will be a month later this year. Wall-flowers, with the absence of snow, are entirely destroyed, but for the same cause Arabis is unharmed, and will soon be in flower. The later these bloom the more the bees will obtain from them.

ARTIFICIAL SUPPLIES.

Bees always thrive best when no artificial work is performed or artificial supplies given, but there are places where neither water nor flowers are within a reasonable distance. In such cases provide both water and peameal in a sunny, sheltered nook near the apiary. For water I have used a large stone-ware jar; the mouth is closed with a rim of wood, with a leather valve in the centre. This arrangement allows the jar to be easily filled, and inverted over a grooved board, which stands in a shallow tray filled with sawdust, and the peameal in a large pipe lying flat, having one end closed to prevent drought, while the other is open and faces the south, or in a zinc drum that revolves with the wind. Those are fortunate who do not require either of these devices, while those who do not need to feed bees now, with a protracted season before them, will be rewarded with the highest yield of honey. In some cases artificial work is good, but where it is not required is better.

CLEANING FLOORS.

Where ventilating floors are not in use floor boards should be cleaned and thoroughly dried before returning, but it is better to have in readiness a clean dry one to take the place of the one removed, and all the better a hive as well. If ventilating floors are employed and the hives otherwise well protected, nothing will be necessary to be performed; but remember no manipulation should be performed until after the bees have well aired themselves, and upon a fine day.—A LANARKSHIRE BEE-KEEPER.

TRADE CATALOGUES RECEIVED.

- J. E. Barnes, 9, Exchange Street, Norwich.—*Catalogue of Vegetable and Flower Seeds.*
 William Bull, 536, King's Road, Chelsea.—*Catalogue of Select Flower and Vegetable Seeds.*
 Kelway & Son, Langport, Somerset.—*Manual of Horticulture and Agriculture.*
 John Smith, Stratford-on-Avon.—*Illustrated List of Labels.*
 John R. Box, Croydon.—*List of Tuberous Begonias.*
 H. Cannell & Sons, Swanley, Kent.—*Illustrated Floral Guide and General Catalogue.*
 George Cooling & Sons, 11, Northgate Street, Bath.—*Spring Catalogue, 1891.*
 B. S. Williams & Son, Victoria and Paradise Nurseries, Upper Holloway.—*Catalogue of Flower and Vegetable Seeds.*
 Frederick Adolphe Haage, jun., Erfurt.—*Catalogue of Plants and Seeds.*



•• All correspondence should be directed either to "THE EDITOR" or to "THE PUBLISHER." Letters addressed to Dr. Hogg or members of the staff often remain unopened unavoidably. We request that no one will write privately to any of our correspondents, as doing so subjects them to unjustifiable trouble and expense.

Correspondents should not mix up on the same sheet questions relating to Gardening and those on Bee subjects, and should never send more than two or three questions at once. All articles intended for insertion should be written on one side of the paper only. We cannot reply to questions through the post, and we do not undertake to return rejected communications.

Fumigating (T. G.).—Your letter affords good evidence of the value of the material. It is in fact a distinct and admirable advertisement, and can only be inserted as such by arrangement with the publisher on a trade basis.

Amorphophallus campanulatus (W. E. G., J. T. S., II., and J. M.).—The information required is given on page 85. *A. campanulatus* and *A. Titanum* are distinct species, the latter being that which flowered at Kew in 1889.

Conifer Hedge (G. II.).—We know of no more suitable Conifer for forming an attractive hedge or screen than *Thuia gigantea*, which is often sold as *T. Lobbi*. It grows quickly, forms a close yet elegant screen, and retains its brightness during severe weather. We prefer it to the other species you name.

Fruit Culture Under Glass (T. W. S.).—We know of no better work on this subject than Mr. David Thomson's, published by Messrs. Blackwood & Sons, Edinburgh and London. It contains a few illustrations of structures and trees, but not instructions for building. Mr. Rivers, Sawbridgeworth, gives plain instructions for erecting cheap structures. You should have both these works.

Grafting Roses Under Glass (S. S.).—What we mean by being "in the same state of growth" is that the sap should have commenced flowing in the stock as well as in the wood that forms the scions which are taken from the previous season's wood. Dormant stocks are not advised, even when dormant wood is used for scions. On the contrary, the stock should be slightly in advance of the scion. It is a general custom to place the stocks in a house for a time, until root action begins, and the sap rises before they are grafted with dormant scions or what are so termed.

Leaves Unhealthy (W. II.).—Either the soil in the pots has become soured and unwholesome, possibly through bad drainage, or the plants have been subjected to a low temperature. We have seen several instances this season where Palms and other plants have suffered in a similar way, chiefly due to sudden lowering of the temperature on severe nights. Near large towns the fogs have done much damage to foliage plants, Palms, Dracenas, and Crotons having all suffered, but that is not likely to be the cause in your case. Repot the plants at the earliest opportunity in fresh soil with good drainage, and encourage growth with a good temperature. They may grow out of the injury, but the worse leaves will have to be removed.

Removing Raspberries (N. S. R.).—No doubt a much better summer growth will follow from cutting down all the stems of the Raspberry stools you intend taking up and replanting, but you would have no fruit for a season. Moreover, old stools do not by any means always transplant well, as they vary in condition. If you wish for fruit next season it might be worth your while to choose and plant the most suitable well-rooted canes for forming a young plantation, cutting these down as shown in the way you mention, while those attached to the stools might be cut back to about half their length for bearing some

fruit during the ensuing season. The new plantation will be the most likely to give the greatest permanent satisfaction.

Planting Fruit Trees (F. James).—No doubt several persons are in a similar position with yourself. You ordered a number of trees in the autumn, but did not receive the whole of them, and of those you did receive only planted about half before the frost came, the others being well heeled in, and now ask if you had better complete your planting this spring or wait till the autumn. We should certainly complete the planting this season, letting the trees remain heeled in till the ground is in very good condition, and order the remainder to be sent and lay them in also till the most favourable opportunity arrives for planting. With judgment in that respect, and the work well done, you may expect the spring-planted trees to grow quite as well as those that were planted just before the frost, and it is not unlikely they will succeed better. The subject will have further attention.

Gardenias Cankered at the Collar (K.).—The specimen sent is very badly affected by canker, and plants in a similar condition are past recovery. It is usually caused by an excess of water or moisture at the "collar," which destroys the epidermal tissue, causing an escape of extravasated sap, that, on exposure to atmospheric influences, oxidises, and a destruction of the bark ensues. It arises also from an excess of nitrogenous and a deficiency of mineral constituents in the soil for the proper solidification of the tissue. The only plan likely to do any good is to use a little dissolved bone occasionally, sprinkling it on the surface of the soil to be washed in, and when watering is necessary, use a table-spoonful of soot, brought to the consistency of paste with water, to every three gallons of water used. In potting, the collar should be kept rather high, so as to prevent water lodging around it.

Barked Fruit Trees (J. S. J. H.).—In addition to making smooth the torn edges of the bark and plastering we do not know what more can be done except carefully planting two seedling Crab or Apple stocks close to each tree, inarching these to the trees by slicing from the ground upwards to a length of 6 inches of the stem above the grafted parts. In this way young fruit trees have been restored which would otherwise have been destroyed in consequence of the stems being deeply eaten all round by rabbits. The sliced portions of the stems must be absolutely clean for their union to be effected. When secured they must be clayed in the usual manner adopted in grafting, and no fissures allowed in the pigment to admit the air. Thin coverings which quickly become dry are of little use. You will find the information you require respecting the *Amorphophallus* on page 85, the other plant we do not know; have you not mistaken the name? Is it *Buphane ciliaris*?

Transplanting Marechal Niel Rose, Auriculas, Lilies (F. B.).—The Rose will grow either in a box inside the house or in a border outside, and the stem brought through in the same way as in planting Vines. We have seen excellent results by both methods, though some persons are apt to give too much water to Roses in boxes at one time and not enough at others, and hence fail. The planting out is the easier method, but the stem outside should be protected with haybands. You may remove the Rose at any time when the ground is in a favourable condition, just as the top buds are swelling being a good time for transplanting, then cutting the stems back severely. Auriculas may be taken up and potted as soon as signs of fresh growth are apparent. A frame will be suitable for them, affording protection from frost when growth is active. You may withdraw the Lily of the Valley from the ashes and place them in the greenhouse. If they can be plunged in leaves there all the better, covering the crowns with them also 2 or 3 inches deep till the growths push freely from them.

Decayed Seaweed (Devonshire Subscriber).—The constituents vary according to the different plants or Seaweeds. *Fucus digitatus* contains 20.66 per cent. of potash, 7.65 soda, 6.86 magnesia, 10.94 lime, 2.36 phosphoric acid, 12.33 sulphuric acid, 1.44 silica, 0.57 peroxide of iron, and 26.18 chloride of sodium. *Fucus serratus* contains 3.98 per cent. potash, 18.67 soda, 10.29 magnesia, 14.41 lime, 3.89 phosphoric acid, 18.59 sulphuric acid, 0.38 silica, 0.30 peroxide of iron, 16.56 chloride of sodium. In the green state Seaweeds supply chiefly nitrogen and potash to a soil, decomposing rapidly, and are excellent manure, but a quantity is needed—viz., 20 to 30 tons per acre. They should be used as a potash-nitrogenous manure. Reduced to mould their value is similar in furthering plant growth to leaf soil, differing only in the enlarged amounts of potash and soda, and may be used in the same way. Dried and burnt the constituents would be as given above, but the value of the soil would be gone, the mineral only remaining, and chiefly valuable for its potash, soda, and phosphoric acid. In the mould state the organic matter would contribute considerably to plant growth, mainly from the humus, though the carbonic and nitrogenous elements would act beneficially. It may be used for the plants you name to the extent of one-third of loam, or if the loam be turfy a fourth would be sufficient, as its action would be directed to increase foliage, and in plenty of light to improve the colour of foliage and flowers.

Cabbages Clubbing (W. G. C.).—Usually most prevalent and disastrous in plants grown in ground long or frequently cropped with Brassicas, a change of soil is most effectual in securing immunity from clubbing. A Pea or Bean crop alternating with those of Brassicas is very desirable. Lime, soot, and trenching are good, but having tried those as well as petroleum, which is not a useful application to soils, we advise a dressing of fresh gas lime. A quarter hundredweight is a proper dressing for a square rod of ground that is soon to be cropped. It should be distributed evenly on the surface, and left there without

more mixing with the soil than a light scratching over with a fork to insure its better distribution. It must be left a few weeks, say six, during which its poisonous elements will have sufficiently acted on the clubbing pests to render them innocuous, and the atmosphere have converted the sulphite and sulphide into sulphate of lime, whereby it is transformed from a poisonous into a useful plant food, and may be mixed with the soil advantageously. In autumn it may be applied in double quantity, leaving it on the surface, or very lightly scratched in, over the winter, mixing with the soil before putting in the crops. Sulphate of lime or gypsum, into which gas lime, as before stated, is converted, is useful as a manure for Brassicas, absorbing and "fixing" ammonia, liberating potash from some of its insoluble compounds. Fresh gas lime must not be applied to ground occupied by the roots of fruit trees. Iron sulphate is a good manure for Brassicas, where the soil does not contain its oxides in excessive quantity, and it destroys parasites that prey on vegetation. Three-quarters of a pound is a proper quantity to apply to a square rod, and is best mixed with sand to insure its even distribution. It may be applied at the time of putting in the crops or prior thereto during moist weather. No pointing in is necessary.

Names of Plants.—We only undertake to name species of plants, not varieties that have originated from seed and termed florists' flowers. Flowering specimens are necessary of flowering plants, and Fern fronds should bear spores. Specimens should arrive in a fresh state in firm boxes. Slightly damp moss, soft green grass or leaves form the best packing, dry wool the worst. Not more than six specimens can be named at once, and the numbers should be visible without untying the ligatures, it being often difficult to separate them when the paper is damp. (*J. B. T.*)—1, *Cattleya Trianae*, a good variety. 2, *Masdevallia amabilis*. 3, *Oontoglossum Cervantesi decorum*. 4, *Oncidium cheiroporum*. 5, *Cypripedium callosum*. (*B. R. O.*)—1, *Selaginella Martensi*. 2, *Selaginella serpens*. 3, *Selaginella Kraussiana*, often named *S. denticulata* in gardens.

COVENT GARDEN MARKET.—JANUARY 28TH.

The market is unaltered.

VEGETABLES.

	s.	d.	s.	d.		s.	d.	s.	d.
Artichokes, dozen	0	0	0	0	Mushrooms, punnet	1	6	2	0
Beans, Kidney, per lb. ..	0	9	1	0	Mustard & Cress, punnet	0	2	0	0
Beet, Red, dozen	1	0	0	0	Onions, bushel	3	0	4	0
Brussels Sprouts, ½ sieve	2	6	3	0	Parsley, dozen bunches	2	0	3	0
Cabbage, dozen	1	6	0	0	Parsnips, dozen	1	0	0	0
Carrots, bunch	0	4	0	0	Potatoes, per cwt.	3	0	4	0
Cauliflowers, dozen	2	0	4	0	Rhubarb, bundle	0	2	0	0
Celery, bundle	1	0	1	3	Salsafy, bundle	1	0	1	6
Coleworts, doz. bunches	2	0	4	0	Scorzoneria, bundle	1	6	0	0
Cucumbers, doz.	2	0	3	6	Seakale, per bkt.	2	0	2	6
Endive, dozen	1	0	0	0	Shallots, per lb.	0	3	0	0
Herbs, bunch	0	2	0	0	Spinach, bushel	5	0	6	0
Leeks, bunch	0	2	0	0	Tomatoes, per lb.	0	4	0	8
Lettuce, dozen	0	9	1	3	Turnips, bunch	0	0	0	4

FRUIT.

	s.	d.	s.	d.		s.	d.	s.	d.		
Apples, ½ sieve	1	6	to	6	0	Lemons, case	15	0	to	24	0
" Nova Scotia and						Melons, each	0	0	0	0	
" Canada, per barrel	15	0	26	0	Oranges, per 100	4	0	9	0		
Grapes, per lb.	0	9	3	0	St. Michael Pines, each..	2	0	6	0		
Kentish Cobs	55	0	6	0	Strawberries, per lb. ..	0	0	0	0		

AVERAGE WHOLESALE PRICES.

CUT FLOWERS.

	s.	d.	s.	d.		s.	d.	s.	d.		
Arum Lilies, 12 blooms ..	6	0	to	11	0	Mimosa (Fench.) per bch	1	9	to	2	0
Bouvardias, bunch	1	0	1	6	Narciss (Paper-white),						
Carnations, 12 blooms ..	1	0	2	6	French, doz. bunches ..	12	0	18	0		
Chrysanthemum, 12 blms.	1	0	3	0	Do. Do. English,						
" 12 bunches	4	0	9	0	per bunch	1	0	1	6		
Epiphyllum, doz. blooms	0	4	0	6	Pelargoniums, 12 trusses	1	0	1	6		
Eucharis, dozen	3	0	6	0	" scarlet, 12 bunches	9	0	18	0		
Gardenias, each	3	0	5	0	Poinsettia, dozen blooms	3	0	9	0		
Hyacinths (Roman), doz.					Primula (double) 12 sprays	0	6	1	0		
sprays	0	6	1	6	Roses (indoor), dozen ..	0	6	1	6		
Lapageria, 12 blooms ..	2	0	4	0	" Red, 12 bls. (Fench.)	2	0	4	0		
Lilac (French) per bunch	6	0	9	0	" Tea, white, dozen ..	1	0	3	0		
Lilium longiflorum, 12					" Yellow, dozen	2	6	15	0		
blooms	4	0	6	0	Tuberose, 12 blooms ..	2	6	4	0		
Lily of the Valley, dozen					Tulips, per dozen	1	0	2	0		
sprays	1	3	1	6	Violets (Parme), per bch.	6	6	9	0		
Maidenhair Fern, dozen					" (dark), per bch. ..	2	0	3	6		
bunches	4	0	9	0	" (English), doz. bunch	1	0	2	0		
Marguerites, 12 bunches	2	0	6	0	Wallflower, doz. bunches	3	0	6	0		
Mignonette, 12 bunches..	3	0	6	0							

PLANTS IN POTS.

	s.	d.	s.	d.		s.	d.	s.	d.		
Aralia Sieboldi, dozen ..	6	0	to	12	0	Lilium lancifolium, doz.	0	0	to	0	0
Arbor Vitæ (golden) doz.	6	0	8	0	" longiflorum, doz.	0	0	0	0		
Chrysanthemum, per doz.	6	0	24	0	Lily of the Valley, per pot	2	0	3	0		
Climbing Plants, various,					Lobelia, per doz.	0	0	0	0		
dozen pots	0	0	0	0	Marguerite Daisy, dozen	6	0	12	0		
Dracæna terminalis, doz.	24	0	42	0	Mignonette, per dozen ..	4	0	6	0		
" viridis, dozen	12	0	24	0	Musk, per dozen	0	0	0	0		
Epiphyllum, per dozen ..	0	0	0	0	Myrtles, dozen	6	0	12	0		
Erica, various, dozen ..	12	0	18	0	Nasturtiums, dozen pots	0	0	0	0		
Euonymus, var., dozen ..	6	0	18	0	Palms, in var., each ..	2	6	21	0		
Evergreens, in var., do en	6	0	24	0	Pelargoniums, per doz. ..	0	0	0	0		
Ferns, in variety, dozen..	4	0	18	0	Poinsettia, per doz. ..	9	0	15	0		
Ficus elastica, each ..	1	6	7	0	Rhodanthe, per dozen ..	0	0	0	0		
Foliage plants, var., each	2	0	1	0	Stocks, per doz.	0	0	0	0		
Fuchsia, per doz.	0	0	0	0	Tropæolums, various, per						
Geraniums Scarlet, p. doz.	0	0	0	0	dozen	0	0	0	0		
Hyacinths, doz. pots ..	8	0	10	0	Tulips, dozen pots	8	0	12	0		
Hydrangea, doz. pots ..	9	0	18	0							



STEPHEN'S BOOK OF THE FARM.

DIVISION V.

IN this part of this comprehensive work the revision by Mr. James Macdonald of the purely farming part of it is as entirely satisfactory and exhaustive as it is in the other parts. Routine farmwork for summer has an appropriate ending in the sections on "Haymaking" and "Bare Fallow," both which have been entirely rewritten, and with the sections of autumnal work routine work for the year ends.

On the whole general utility has been kept admirably in view in the revision, but occasionally we are reminded that the work has been done over the border by the attention which has so evidently been given to crops which find most favour with North British farmers, as, for example, in the Swede culture in the last volume, and in Potato culture in this. The undue brevity of the chapter on "Subsidiary Farm Crops" is hardly in keeping with the work, and tends to show that fruit farming is not likely to obtain much extension in Scotland.

The chapter on "Bee-keeping as a Farm Industry," by Mr. William Raitt, contains many practical hints, and an anecdote under the heading of "Bees *v.* Shorthorns" is worthy of repetition. "Some years ago the writer was at tea in the company of several farmers, who chaffed him not a little on having a 'bee in his bonnet.' Their talk was of Shorthorns. 'I'll tell you what it is,' said I, 'I have a single bee at home that has this year put more money into my purse than the best Shorthorn cow you have had done into yours.' I, of course, referred to the queen bee of one of my hives, the mother of all its inhabitants. It so happened that I had this season taken from that stock no less than 130 lbs. of first-class honey in such splendid condition that I sold it to a dealer after winning a handsome prize besides, for £10 16s. That was a clencher! It is but fair to say that the result was exceptional, though I have several times greatly exceeded it in quantity since. For instance, I had in one season from a single hive 204 lbs. of bottled honey of first-class quality, and an almost equal amount from a hive the year before, and all without killing the bees or interfering with their necessary winter stores. These figures indicate the possibilities that lie in bee-keeping, though taking one season with another, I should estimate the average produce of a well managed apiary at from 30s. to 40s. per hive."

In the following chapters much useful information is given upon the selection, hire, and stocking of a farm. There is also much useful and interesting matter under the heading of the "Physical Geography of Farms." The rotation of crops is well discussed, and the reasons for rotation are set forth as being (1), That while all plants tend to exhaust the soil they do so in different degrees; (2), That all plants do not abstract the same kind of ingredients or in equal proportions; (3), That the habits of growth differ greatly in plants, some searching for their food down into the subsoil and others feeding in the surface layers; some occupying the ground for a short time and others for a long; (4), That crop residues differ materially; and (5), That the various kinds of plants differently affect the growth of weeds and the presence of insects. Very wisely it is also stated that climate and local circumstances must to a large extent influence the system of cropping.

We regret not to see some mention made of the fact that by judicious tillage and manure application farmers are now practically independent of strict adherence to crop rotation, for that has been proved repeatedly both in Scotland and England, and it is clearly in the tenant's interest that he should be able to produce

crops most in demand, and which are therefore calculated to afford him most profit. A clear comprehension of this fact by both landlord and tenant is most important, as that is calculated to have a healthy influence upon the removal of vexatious restrictions in the covenants of farm agreements. To bind a tenant's hands to his hurt cannot be good for the landlord, and we have always striven to show how possible it is to avoid old restrictions as to the growth of two white straw crops, or for the matter of that two or more crops of any kind consecutively.

The last chapter is on land drainage, and is both well written and well illustrated. Not easy is it to say anything new upon this well-worn subject, and it is far more important to note all leading points of the work, and the reasons for doing it. This has been well done, different systems are also discussed, and authorities quoted for and against them, so that a clear idea can be obtained by beginners for their guidance in the work.

WORK ON THE HOME FARM.

The prolonged frost has put the resources of farmers to a severe test, for with pasture covered with snow and root left out upon the land all frozen hard as stones, there has been a run upon stored food, which has only been well met by timely and judicious preparation. Sweet lessons of adversity will the wet "haysel" of last season and this hard winter prove if they induce more general attention to ensilage. Full of nutrition are silage stacks made last season—made, be it remembered, at so little cost; haymaking, on the contrary, was never more expensive, and the result never more unsatisfactory, most of the hay being inferior, and much of it is most probably mouldy. We earnestly beg every home farmer to include special crops for silage in the cropping scheme for this year. It is most nutritious food, is easily made without any of the uncertainty that is inseparable from haymaking, it is liked by horses, cows, store cattle, and sheep, is one of the most economical useful crops we have, and is quite indispensable in modern farming.

We have recently met with two cases of sheep worrying, and would urge every shepherd and flock-master to be watchful, and do all that is possible to guard against the incursions of stray dogs. Now that the lambing is gradually becoming general the shepherds should live among the flock. We take care to provide a comfortable hut for the shepherd, and allow him everything he can possibly require for his comfort and convenience. However much these valuable men are accustomed to exposure they are human beings, and if they are good servants one cannot well do too much for them. With an adequate provision for shelter, and plenty of good wholesome food for the ewes, there is no reason why the crop of lambs should not be as good as usual, provided the ewes have been kept in fair condition since last weaning time. If we would have rich milk we must have rich blood and a well nourished body.

In flocks affected by foot-rot the feet of all ewes suffering from it are dressed in the first week after the lambing, and regularly subsequently so long as they require it. It is only by steady persistence that this troublesome disease can be kept under, and the feet of pregnant ewes near lambing cannot be dressed for it previous to lambing, but no time should be lost afterwards, both for the sake of the ewes and to prevent—so far as one can—its spreading among the lambs. Neither sheep nor lambs thrive as they ought to do while suffering from foot-rot.

METEOROLOGICAL OBSERVATIONS.

CAMDEN SQUARE, LONDON.

Lat. 51° 32' 40" N.; Long. 0° 8' 0" W.; Altitude, 111 feet.

DATE.	9 A.M.					IN THE DAY.				Rain
	Barometer at 32s and Sea Level.	Hygrometer.		Direction of Wind.	Temp. of soil at 1 foot.	Shade Temperature.		Radiation Temperature.		
		Dry.	Wet.			Max.	Min.	In suu.	On grass	
1891.	Inches.	deg.	deg.	deg.	deg.	deg.	deg.	deg.	deg.	In.
January.										
Sunday 18	30.456	22.3	21.2	N.	33.0	30.3	19.2	55.3	17.0	—
Monday 19	30.325	21.2	20.1	N.	32.9	37.1	20.8	49.2	16.2	0.010
Tuesday 20	30.022	36.9	35.9	W.	32.7	44.1	19.7	49.0	14.7	0.184
Wednesday .. 21	29.490	31.9	31.9	W.	32.7	39.9	30.1	64.4	27.1	—
Thursday 22	29.497	36.2	34.9	W.	32.8	43.0	29.7	70.8	24.8	0.010
Friday 23	29.713	42.7	42.1	S.	32.9	48.6	31.0	53.8	25.1	0.853
Saturday 24	29.590	47.7	47.0	S.W.	32.9	49.1	42.8	53.0	39.4	0.266
	29.870	34.1	33.3		32.8	41.7	27.6	56.5	23.5	0.823

REMARKS.

18th.—Brilliant throughout.
19th.—Dull; early sunshine from about 11 A.M. to sunset; a little snow in evening.
20th.—Generally mild and dull, but sunshine at midday; rain from 8 P.M. to midnight.
21st.—Cloudless throughout.
22nd.—Cloudy early; unbroken sunshine from 10 A.M.
23rd.—Mild, dull, and drizzly; rain at night.
24th.—Wet till 6 A.M.; dull and drizzly morning; wet from 1 P.M. to 5 P.M.; bright night.

The exceptionally long frost ended with the 19th, leaving the minima of that day to be recorded against the 20th, and slight frost occurred on every subsequent night until that of Friday, 23rd. Although on 24th the temperature rose to nearly 50°, the intense cold of the earlier days of the week made the mean for the week considerably below the average. The difference between the average temperature at 9 A.M. for the past nine weeks and the mean for the twenty years 1859-78 shows the following remarkable deficiencies:—Week ending November 29th, 6.2° below the average; December 6th, 5.1°; 13th, 9.7°; 2th, 13.2°; 27th, 11.2°; January 8th, 10.8°; 10th, 11.8°; 17th, 8.9°; 24th, 5.3°; or an average deficiency of more than 9° in nine successive weeks, a deficiency which we must go very far back to equal.—G. J. SYMONS.



GARDEN GLORY.

THE idea of gardening presents at least two prominent and distinctive aspects—the æsthetic and the economic. These two divisions may, of course, run into many sub-divisions; but if gardening is—as Bacon said it is, and as those who are true gardeners have found it to be—“the purest of human pleasures,” then it must present itself thus.

The garden may serve to typify that higher cultivation of that sacred enclosure, the hedge of which is the heart of man—nay, it seemeth rather that, viewed in its higher aspect, it speaketh first this parable of culture, written on the palimpsest of Nature. We will bear this in our mind. The proper balancing, then, of these phases or conditions will be found needful in giving life its blessedness. The interblending of the artistic and the useful will help in no small measure to give the varying, the ever-varied, touches of individuality, which in the concrete we call character. Gradgrind has no perception of the beautiful; he lacks the art faculty, he has no conception of the real worlds of joy and beauty which lie beyond the shadows of the money bags and pork boxes. Maudle, on the other hand, is perhaps as ignorant of the elements which go to build up true manhood as it is brought into contact with the practical problems of an everyday life, beyond the atmosphere of the drawing-room, outside the range of velvet couches and the plush of flunkeydom. But we are not now concerned with Gradgrind or Maudle; we simply ignore them. They shall not come with us through the gate. They have no interest in this kingdom of Flora, whither we are now to wend our way.

But it is well, at any rate, to note that the tincture of trade is being poured into the essence of everything. The coronet now may be imprinted upon the millinery box, and the motto of an ancient earldom might find place on the bill-heads used for due notification of the sales of the produce, on market principles, of the castle gardens. Does this betoken the touch of Midas, which would unchecked bring everything to the dead level of dulled gold? Do not let us too readily get into the shade of pessimism, but there does seem to be some danger that the utilitarian spirit may permeate everything, and “a joy for ever” will only eventually be gauged and valued by its price in the market.

In the midst of these misgivings it seems well to sing the praises of the old love. Let us keep her graces well in the mind's eye. Let us see her prettily dressed, in dainty attitude, not always as a drudge plus cash book and ledger. Let us, in short, leave the atmosphere of the Exchange and of the work-room, and get away into the fresh air and the open. Let us anticipate the spring.

But why attempt to write upon garden glory just on the first step of the new year? The earth is bare and cold. The ground is hard, and the frost has continued night after night. The wind is keen as it tumbles in from the east, or boisterous as it blows hard from the north. The garden tools have got coated with rust, and much blue-faced humanity comes and goes, seemingly driven as closely as the birds, to come and show themselves for fragments that may be spared to keep the flickering flame of life burning. Why write upon garden glory now?

Yes. You see in imagination the dead Daisies, the drooping Mayflowers, the blackened Lily, the Rose naked but for its thorns, the creepers up the wall a tangled mass of shrivelled fibres, and you dream on gloomily through the winter day. Shall I write

“Ichabod” over the gate? Surely the glory has departed. Stay; almost whilst you are yet speaking a slanting sunbeam steals through the chink of an opened door in the western sky, and looking back to the bare brown bit of border, you see a Christmas Rose and the peep of a slender stalked Snowdrop, and in these tiny messengers you seem to be able to read the parable of Nature again, and you start off lighter hearted on a new road, of new thought and new hope, as you pass under review the pageant of the seasons.

Soon the silver Snowdrops will modestly hang out their bells and lead the way, and as though this were not wealth enough the Winter Aconite will put its dots and lines of gold upon the brown coverlet of earth, with dainty decorative effect. Start once made, how quickly the array of beauty is marshalled into order and brought into view in succession. These tiny things, taking first timid peep, just pushed above the earth level, how prettily they seem to kiss the sun and wave open hands to the sky. “These tiny things,” I have just said, for you will have observed how the early spring flowers hasten to get petals open. They come with spasmodic start and eagerness, all flower many of them as though they cannot wait for the leaves. This is not garden precocity only. The Coltsfoot in the field, shooting up its golden-starred crown, cannot wait for foliage. The Crocus cups stand in a gay line, leaves must come later.

Then these are followed in quick march by Daffodils, seeming to say for Nature, “Nay, but we will not allow such hard and fast rules to govern the order of the springtide. Leaves last? Not always. Watch us. See, we will stud the field thickly with green blades, broad and full, yet quickly shall follow the flower.” And what a flower! What a splendid page has opened to us! What a book of fairy tales! What a picture of gay glory! The Field of the Cloth of Gold! Other sturdy leaved plants follow with a rush. Pæonies, big with bud of hot crimson and cool pale pink, with creamy white, and all the shades the most fastidious could wish. The great family of the Iris tribes, with leaves like swords in an armoury, and flower heads as pretty as Orchids; and now the hot sun has brought so many fair faces from behind the veil that one cannot attempt portraiture in so small a gallery—the Editor has other demands for his wall space.

But we are led to the Roses—the June Roses. Oh ye Queens, one echoes the sentiment which lingers in the mind once stirred with the eloquence of one who can write about gardens! Oh ye Queens!

“What garden grace can be compared to thine?
So sweet, so silent, and with face so fine;
So fair a presence. Lips that open with morn
Proclaim thee Queen. Thy beauty hides the thorn.”

We may perhaps not agree—all of us—to go quite the length of the old Rose lover who thus saw such charms in his favourite as to eclipse the perchance simpler beauties of other Court attendants to whom we pay equal respect with “the queen of flowers.” But there is no time for jealousy, and no desire for it in this domain. I love the Daisy because it is a Daisy; the Rose because it isn't. What philosopher was it who said “Art is Art because it is not Nature?” We will not cavil if you please; the walk is wide enough for two. There is room for both, and all, and everybody.

Then we are led on to the rich full autumn-tide. The spring balm and the warm sunshine have been pouring growth and life into the big stemmed plants—Hollyhocks and Dahlias, the Gladiolus and the Sunflower, and the long list of plants which come in to fill the idea of wealth which seems to be associated with the harvest time. But not alone in the glory of petal and perianth do we find the resources of autumn. The very leaves carry the suggestion of iridescence, the secret of suppressed fire which will burst out in dashes and streaks and in flame tongues of scarlet and purple and gold. That which came a shy tender green when the May was on the hedges is now like a torch in the October sun, and the Thorn tree, which was a bush of snow-blossom in summer, has

become a blaze of living flame when the days are counting up towards three hundred. So might we go on finding here and there this power to charm, these evidences of garden glory; but my mission was simply to waken interest, not to exhaust enthusiasm.

To give practical point to these few hasty thoughts and hurried words let us try to put glory into the garden. Let us plant with a purpose. In choosing, say creepers, for a wall, have them so arranged that there shall always be something in fresh flower to see at its best. Perhaps the yellow Jessamine will be a suitable first foot for the New Year—the Wistaria, the Woodbine, with Pyrus and Ceanothus, to say nothing of the Sweet Peas and Canary Creepers, and the host of other things which come and flower and go before the Virginian Creeper dazzles you with its splendour and marks the time for the lighting of the lamps for the approaching night of the year. Have in the shrubbery the Laurestine, the Almond, Daphne, Prunus, Mespilus, all in grand array. Look for a blank and put something in that shall give contrast, continuity, and completion to the space now bare. Have no garden gaps in this sense.

There is something further, and much, that should be said upon the Glory of Fruitfulness—berried plants and fruit-laden trees—the laughter and song in the vales and the clapping of hands on the hills, but this we leave for the present.

The winter is past. The birds are finding something in their throats as I write. The thrush is just rehearsing in the early morning when you can see the outline of towers and steeples in the distant town as they stand out in relief against the streak of light which heralds the coming dawn of the spring day. Shall we make our life the fuller, the better, the happier—yes, the holier, by trying this year to see, scattered over the fair face of Nature, within or without the hedge, some of the beauty and wealth of this one aspect of garden glory?—JOHN EDMUNDS.

LESSONS IN MARKET GARDENS.

THE season is again fast approaching when many gardeners will be what is generally called "taking a turn round" to see what is to be seen and learned in gardens and nurseries away from their own immediate districts. Such a custom is very properly recognised as part of a gardener's never-finished education, and one that is frequently carried out by those whose anxiety it is to keep abreast of the times. There is, however, room for doubting, or rather saying, that gardeners are much more alive to the lessons of a tour than are their employers, with whose interest the custom is more closely related; hence I know, and am sorry to say, that in a great many instances gardeners must either stay at home and be content with hearing or reading of what is to be seen and learned or pay their own expenses, in one sense to their loss, but to the profit of others. It is but just, however, to say that if the matter were brought before employers in a proper light many of them would recognise it to be to their own interest to allow a certain sum annually towards this object. No matter how able a gardener may be in his profession, an inspection of the doings and an hour or two's chat with other professionals, in even very moderate gardens, never fail to give a stimulus to both the visitor and the visited. Our tendency is to fancy our own crows the blackest and best feathered, and to fall into a stereotyped method of "doing things," and we require being brushed up by contact with the works and ideas of our contemporaries.

I have heard it related of the famous Mr. McNab of Edinburgh Botanic Gardens that he once returned to Edinburgh from an inspection of the splendidly cultivated Heaths under the late Mr. Turnbull at Bothwell Castle, commenced some important operation on the Botanic Heaths, and very vigorously pledging himself as not going to be beat by the "west country people." I mention this incident, as I conceive it to be illustrative of what should, more or less, be the effect produced by an inspection of superior culture wherever met with. If one thing is more certain than another in horticulture it is that whenever a gardener, no matter what his age, ceases to be a student in his profession he may be labelled as on the "down grade." There is no standing still in culture any more than in anything else. It must either be in a progressive or retrogressive condition.

If I might presume as an old gardening hand to offer a word of advice to intending tourists this season, I would say, If you have not of recent years taken a look at some of the market gardening establishments, especially those in the vicinity of London, by all means devote a season's tour to an inspection of them. This is the more earnestly to be recommended in view of the very important change that has taken place in the products now in most request in private establishments. The time has gone by when those severe tests of skill, huge and splendidly grown specimens of hardwooded plants, were the chief pride and attraction of British greenhouses.

They have been succeeded by plants more tenacious of life and more suitable for house decoration, or for the production of flowers for cutting all the year round, and it is in the great market manufactories that such plants are grown to the greatest perfection and at the least possible cost. It may be said that such plants can be produced with less skill and attention than was required to produce the leviathan Primulas, Ericas, and other hardwooded plants of forty years since. In one sense this may be true, but in another it may be disputed. Many a private gardener has but a very defective idea of the beautiful ornamental foliaged and flowering plants produced by market growers in the course of only a few months. Such plants every gardener has now, more or fewer, to grow for domestic purposes, and an inspection of the establishments round London cannot fail to be an eye-opener to any gardener who has not some knowledge of them. It may be said truly that no private growers can command the conditions at the command of these market gardeners. Still, that is no reason why a man with a receptive mind and his "wits about him," should not learn a profitable lesson or two that he can apply with considerable improvement at home. Speaking from personal experience the heads of these great establishments are very civil and communicative to private growers, from whose competition they have nothing to fear. A great many of us have but a poor idea of the enormous number of plants in the grandest of health produced in pots not much larger than breakfast cups in one of such gardens, and I feel certain a visit to them would astonish many a gardener, both as regards number and quality.

The same remarks are equally applicable to the production of fruits. Take, for instance, the few following facts. I last season visited the establishment of a son of an old friend, and found that he had that week in April sent 750 dozen Cucumbers to market, and he assured me that he was but a small grower; and a friend told me of a garden that I had not time to visit where the Cucumbers were sent to market three times weekly in two-horse waggons. I found my young friend adding to his enormous town of glass houses, seven houses each 400 feet long and 30 feet wide, all for Grapes. These men do not speak of adding a house or two, but of covering another acre. At a plant establishment I visited I found 40,000 pots of Mignonette turned out in the season, and such Mignonette! Heaths, Pelargoniums, Fuchsias, and Chrysanthemums, &c, on the same scale, and in the same grand order. I asked my young friend if it were not possible to overstock the market with Cucumbers and Grapes. The answer was, London can never be overstocked with Cucumbers as long as they can be sold at a fair price.

No doubt the time has now arrived that not much can be made at growing such things except when turned out by the million and at the least possible cost of production, and there is but little chance for the small grower. It is considered by those who are best able to judge that the time is very near when the best Grapes that can be produced will not realise more than 2s. per lb. Some growers have already sent in large quantities of Grapes that have never been thinned, and they go at 4d. and 6d. per lb., certainly placing Grapes within the reach of all.

My impression is that much of the Grape growing in some market places is not on a sound footing. The oldest of many Vines are but very young. They are torn out and replaced when they should be in their prime. Many of them are confined to inside borders, and Vines under such conditions never last long nor bear such fine fruit as when the half at least of the root run is outside. I am not now going to try to account for the fact. Some of the market men are finding this out and placing their span-roofed vineries far enough apart to give a considerable extent of outside border, and I think they will not need to renew their Vines so often. Probably the finest samples now going into Covent Garden are from Vines planted nearly a quarter of a century since, and now with boles like a man's leg and bearing their finest crops. I feel, Mr. Editor, I must apologise for such a disjointed and I fear unprofitable discourse, but you are partly to blame.—D. THOMSON, *Drumlanrig Gardens*.

A WORD ON STOKING.

In the cultivation of fruit and flowers under glass there is no work necessitating a more constant or watchful labour than stoking. Ventilation perhaps is as important, and watering comes next; but generally speaking the latter, except in very hot weather, only requires attention once a-day; but stoking, especially during the early months of the year when much forcing is going on, demands almost hourly attention.

To the uninitiated the work of stoking a fire well seems a very simple matter, and may, as they think, be entrusted to the commonest unskilled labourer to perform; but the fact is that to be able to carry out this work intelligently, economically, and

effectively demands the highest skill and closest attention. No one can estimate the loss in fuel which takes place in our gardens annually as the result of ignorant and wasteful firing, besides the irritation and unpleasantness it frequently causes between the gardener and his assistants. Stoking does not strike us as being a work of so fascinating a nature that anyone can become fond of it, yet such is the case, as I can call to mind many instances of young men who took as much pride and interest in their fires as they would in potting the rarest and most expensive plant. When this is the case it is always a pleasure to inspect the stokehole, which we find damped to keep down dust, the ashes neatly placed on one side and frequently removed (no lumps of coal or coke in them), and the fire irons placed where they can always be found. Contrast this with a slovenly kept stokehole—the floor strewn with ashes, everything dry and hot with dust and sulphur enough to choke anyone, and the fire irons thrown about in disorder. The condition in which a young gardener keeps his fireplace not infrequently indicates his character in respect to other duties he may have to perform.

The principle of good stoking may be very briefly stated. It consists not in the apparent quantity of fire there may be in the furnace, but in the cleanliness of the fire, if I may so express myself, a fire that is free from exhaustive and dead matter, and is composed only of combustible materials. The same quantity of fire in a clean furnace will give at least double the amount of heat that it will give in a furnace which is choked with ashes and clinkers. I had a very clear proof of this only a few weeks ago. A large new boiler had been at work for upwards of a month, and gave every satisfaction for a time, but gradually for a week or so failed to circulate the water so well. The stoker was positive the firing was faultless, and invited me to look at the fire, which I did, and certainly there seemed an excellent one. However, I was not satisfied, and the fire was taken out, with the result that on the bars at the far end was a thick layer of expended material effectually sealing up the space between the furnace bars, which in good stoking it is so important to have clear for the admission of air to the fire, and also reducing the boiler surface on which the action of the fire could play. The removal of this material made all the difference between successful and unsuccessful stoking, between a sluggish circulation of hot water and a perfect one. The difference in the heat-giving power of a dirty and a clean fire is also very evident in our hearth fires. Rake the dirt out of the grate, and the fire, even if it appears a smaller one, gives out a much greater heat.

Stoking in relation to temperature, fuel, boilers, and other matters in sympathy with the subject might be very usefully considered, but I have trespassed too long already, and will only add that I hope these few observations may help and encourage some young gardeners to excel in this work at the commencement of their gardening career.—OWEN THOMAS, *Chatsworth Gardens*.



VANILLA.

THIS is grown to perfection in one of the Pine stoves at Osberton, Worksop. I remember a few years ago seeing a plant growing luxuriantly the whole length of the house producing very fine pods of a good size and in great abundance. Mr. Woods, the gardener, was kind enough to give me a couple of dozen pods about the length and thickness of a good sized French Bean. There are only a few species known to me—namely, *aromatica*, *planifolia*, *lutescens*, and *Phalænopsis*. The two former have insignificant flowers but are grown principally to obtain fruit, which is easily done by artificial fertilisation. *V. lutescens*, a native of La

Guayra, is rare, petals and sepals greenish yellow, lip bright yellow, flowers large, two or more together, from axils of leaves somewhat of the appearance of *Cattleya citrina*. *V. Phalænopsis* (Madagascar) has large flowers, white orange lip, produced in large bunches from axils of the leaves.—URBANUS.

ORCHIDS AT STREATHAM.

LÆLIA ELEGANS and its varieties have long been special objects of attention at the residence of R. H. Measures, Esq., Streatham, and it is doubtful if his collection is surpassed in this country, as

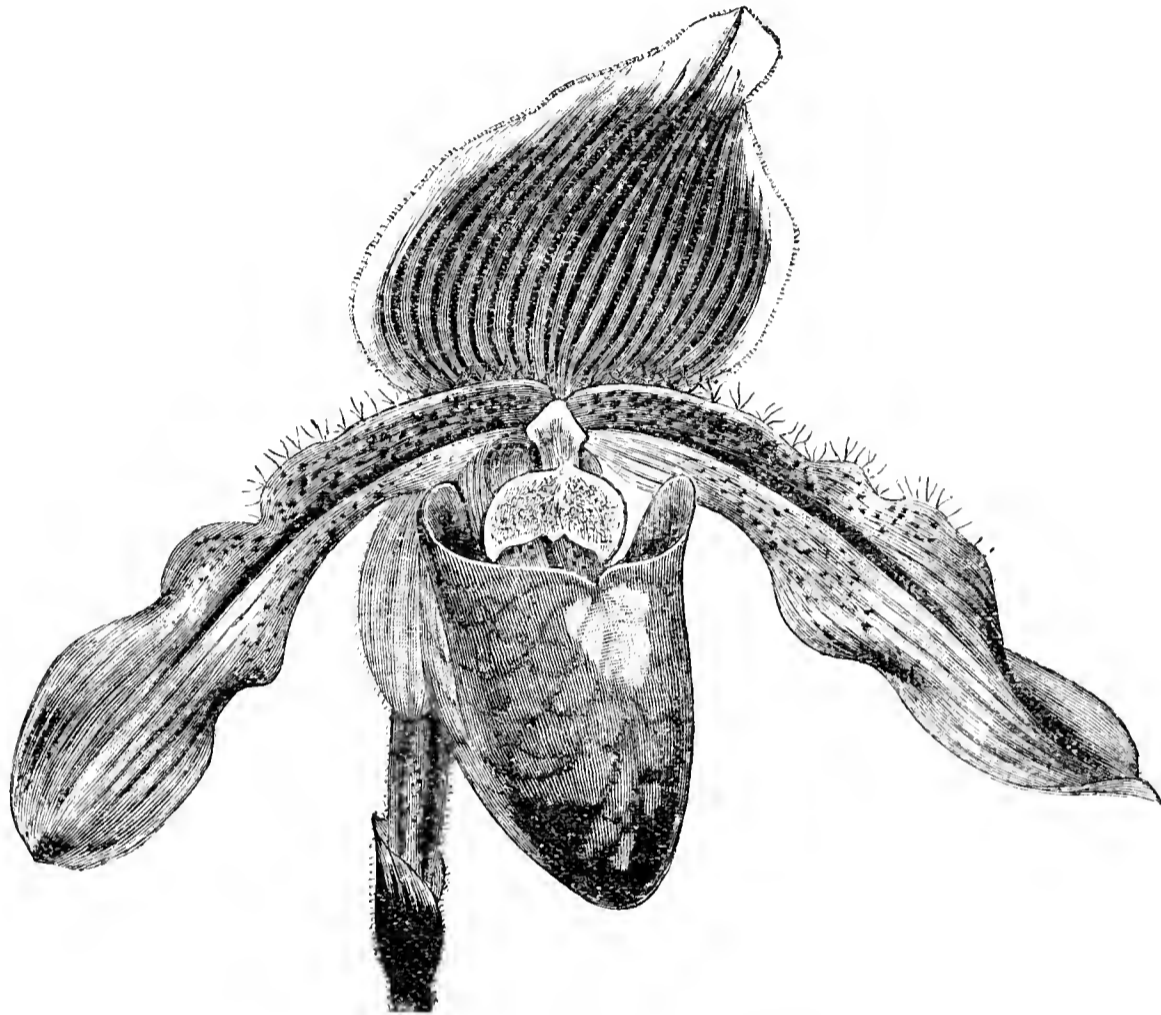

FIG. 19.—CYPRIPEDIUM CASTLEANUM.

it comprises all the finest varieties obtainable. Cypripediums also constitute another important feature, including nearly all the species and hybrids in cultivation, together with the best varieties of the respective types. This year the fogs have proved very troublesome, and many fine flowers were lost before they had reached their best condition. Fortunately the plants themselves have not suffered, in fact the loss of the flowers may prove an actual advantage in the case of small plants or those not very strong. Several additions have been made to the Cypripediums lately, and one that Mr. Measures values greatly for its distinct bluish-purple colour is *C. Castleanum* (fig. 19), the history of which has been previously given. An excellent coloured drawing has been prepared from this, and shows the peculiar blue suffusion admirably.

ORCHIDS AT "MY GARDEN."

AFTER such a prolonged period of severe weather it would not be surprising if Orchid houses were rather dull and the plants flowerless. In one or two instances lately we have, however, noted collections where the display of flowers has been bright and cheering in no ordinary degree. Much depends upon the situation, and a garden outside the smoke and fog radius of London is favoured as compared with those exposed to the ill effects of the poisonous compound known as London fog. At no time of year can a profitless visit be paid to the residence of A. H. Smee, Esq., The Grange, Carshalton, rendered historical by the late Alfred Smee's entertaining book "My Garden." Something can always be found of interest, and on a journey a week ago numerous Orchids were found in flower scattered through the various houses that would have made an imposing group if arranged together. The *Cattleyas* have not yet commenced to expand their flowers with the exception of *C. Dayana*, but they are promising well; "sheaths" are numerous, and the plants healthy. Of Cypripediums the following were noted:—*C. Bullenianum*, *C. callosum*, *C. superciliare*, *C. Leeatum*, and *C. javanicum*, all flowering well.

Amongst the curiosities which are always to be found at The Grange, a diminutive Orchid named *Pleurothallis Colibri* was found after a careful search, for the plant itself is small; the leaves an inch long, and quarter of an inch broad, but the flowers are amongst the smallest I have seen; they are scarcely three-eighths of an inch in diameter, with purple dots, and strange little white pendulous filaments from the points of the sepals. Another small Orchid but larger than the preceding is *Epidendrum polybulbon*, which has neat little flowers, the sepals and petals linear, brownish in the centre, tipped and edged with yellow, the lip relatively large, white with a yellowish centre. The charming white crystalline *Angræcum hyaloides* in a basket 3 inches square, had six short racemes of flowers clustering round the stem, a striking contrast with the giant *A. sesquipedale* bearing two fine flowers near it. Amongst other Orchids in flower were the coral-red *Ornithidium coccineum*, the yellow *Maxillaria variabilis*, several *Coelogynes*, *Lælias*, *Calanthes*, and *Dendrobiums*, the graceful *Vanda Amesiana*. These give no indication of having passed through a severe ordeal, but are flourishing as satisfactorily as could be desired.

QUALITY VERSUS SIZE IN FRUITS.

WITH some varieties of fruits, and especially as regards Pears and Grapes, size appears to take precedence of quality, or why do we see such large coarse varieties of Pears with a poor insipid flavour placed before varieties of superior quality, although only of medium size when placed upon the exhibition table? By medium size I refer to such varieties as *General Todtleben*, *Doyenné Boussoch*, *Beurré Bachelier*, *Brockworth Park*, *Beurré Clairgeau*, and *Duchesse d'Angoulême*. To those people with little experience, and especially as regards ladies and gentlemen who visit fruit exhibitions to glean information, these large fruits are attractive, consequently the names are taken as desirable varieties to grow, but when trees are planted, and ultimately produce fruit, disappointment is the result. Good fruits of *Winter Nelis*, *Josephine de Malines*, or even *Beurré d'Aremberg*, although not of large size as compared with the others above named, are superior to them in quality. Where, however, quality is combined with size most decidedly give these the preference, as *Doyenné du Comice*, when well grown, will produce fruit of the largest size. The way to discourage these large worthless varieties is to expunge them from exhibitions. With well tried varieties of great merit each variety, whatever its ordinary size, should be encouraged to grow to its utmost limit as far as high culture is concerned.

I think the reminder of Mr. Geo. Bunyard to the framers of schedules of fruit exhibitions very opportune, as when orchard house-grown Apples or Pears are allowed to enter into competition with *bona-fide* outdoor grown fruits it is very misleading to the public. Apples growing against walls should be placed in the same category, as, if the general public has yet to be educated to British grown fruit from the open air, let it be done with *bona-fide* examples.

A well-grown Peach or Nectarine is always of high quality if the variety is worth cultivating at all, and whatever its variety they should be thinned and fed sufficiently to fully develop each fruit. Well-grown Peaches or Nectarines are sure to give satisfaction, both for home consumption or even for sending to market, as they always fetch a high price whatever the season. The reason generally given for the want of flavour in market Peaches is that they are gathered before they are ripe. I do not think this is correct, as Peaches and Nectarines are always of better flavour when gathered a day or two before being fit for table, and placed in a cool fruit room. I have sent Peaches to Covent Garden from a distance of 150 miles, with a previous twelve miles jolting over a country road, and they have reached their destination without blemish, and the flavour not impaired in the least. For fruit from an outside wall the salesman's returns have been 15s. to 18s. per dozen, and have cleared £5 from a single tree growing against a wall in the open air.

For high quality in Grapes what can be better than well-grown examples of either the *Black Hamburg*, *Madresfield Court*, *Muscat of Alexandria*, *Lady Downe's*, or even *Buckland Sweetwater* or *Duke of Buccleuch*? as whatever the size quality is always present. I have often seen it stated that the *Black Hamburg* is one of the easiest of Grapes to cultivate, and so it may be, but to secure size of bunch and berry, combined with high finish, requires superior cultivation, more so indeed than either *Gros Colman*, *Gros Maroc*, *Alwick Seedling*, or *Alicante*.

A large *Queen Pine Apple*, or indeed any other variety, besides showing high culture, also represents good quality; and so we could go on and mention other fruits, excepting perhaps *Strawberries*. Everyone's taste is certainly not the same, size in several instances being their only qualification for being cultivated at all,

and how *Helena Gloede* can be described as of an excellent flavour is beyond my comprehension.—A. YOUNG.

TUBEROSES.

IT is evident from the largely increased sale of this useful bulb during the last few years that both market and private growers have become fully conscious of its value as a decorative plant in the cut state. With very little skill a supply of its fragrant flowers may be maintained all the year through.

We start our Tuberoses in large 60-sized pots in a compost of loam, leaf soil, and sand in equal parts, river or roadside sand being good enough for the purpose. The pots are placed in a corner of the plant stove, where they remain until growth has commenced and the pots filled, or nearly filled, with roots. No time is lost in placing them into their flowering quarters. With first size bulbs 32's should be used. The potting compost should be rich; three parts loam, two of dry cow or deer dung, one leaf soil, and one of coarse sand. A few handfuls of bone dust, if free from ivory filings, can be added with advantage.

When in good condition Tuberoses will fill their pots with roots some time before growth is completed, then feeding with liquid or chemical manure may be resorted to with advantage. Throughout their growing period it is well to keep them in a warm moist house, where they are well syringed two or three times a day. This has the effect of checking red spider, to which, should the atmosphere be at all dry, they are much subject. Dusting with flowers of sulphur should be resorted to if this pest becomes troublesome.

Deep potting is an error too frequently committed with these plants. A glance at the bulbs will show how deep they have been embedded in their native soil, which is often, if not always, less than half their length. This should, therefore, be observed as a guide when potting, deep potting being often attended with injurious, and in some cases fatal, consequence to the bulbs.

Taking the varieties as they come to hand, we start with the *African*, which arrives in the market early in October, and continues to arrive in quantity until the American varieties arrive on the scene in December. The *American Pearl*, owing to its dwarf compact habit, has become a general favourite, and commands a slightly higher price in the market. Grown in heat they flower within about three months from the time of starting, the October and November plantings being a few days longer. To keep up a supply twelve or thirteen plantings should be made, the strongest *Pearl* or other American kinds being selected for the August and September plantings.

As an outdoor flowering plant the *Tuberose* is more frequently than not a failure. To ensure a good supply of bloom out of doors the bulbs should be started in gentle heat in May in boxes of leaf soil, or, better still, singly in pots, and planted out as early in June as the weather will permit.

With this simple treatment they rarely fail, and I hope when the time comes to again grow a quantity in the same manner.—W. R. WILLIAMS, *Great Marlou.*

HOW THE PARISIAN MARKET GARDENERS FORCE LETTUCES.

THE kind of Lettuce most grown for forcing by the French market gardeners is the black-seeded crisped small early, which has the peculiarity of being able to grow with little air. The seed is usually sown from the 5th to the 15th of October in a sheltered spot, under bell-glasses placed on a raised bed sloping to the south, from east to west. The bed is made up in raising the back 6 inches above the surface of the ground, with the soil taken from the front, thus giving it a slope of about 1 foot towards the south, with a width of 4 feet, which is sufficient to hold three rows of bell-glasses set in cross lines. The seed usually germinates at that time in about five days, and a week or ten days later the seedlings may be pricked out on a similar sloping bed, putting this time only two dozen plants under each bell-glass.

With good treatment the Lettuces ought to have formed a rosette from 1½ to 2 inches in diameter by the month of December, and be strong enough to be transferred to their final position on a hotbed, the heating material of which is from 20 to 25 inches deep. When the latter bed is of the proper sweetened condition, the compost and frame are placed over it, taking care that the compost be only about 4 inches from the glass; the young plants are taken up with a small ball and pricked out into the bed, which will hold from fifty to sixty-five plants to each frame light. The last row of Lettuces ought to be set at about 6 inches from the wood, to prevent a spindly growth through the shade of the frame.

Thus planted, the beds ought to be examined every week to

guard against insects and to remove any decayed leaves. As soon as the first frost appears it is necessary to draw some dry heating material around the beds to prevent the loss of heat and exclude frost, and the frames ought to be covered with straw mats. If the cold increases the trenches between the beds should be filled with stable manure to the height of the frames and the mats doubled. If snow comes it is shaken well off the mats and trenches to prevent the cooling of the beds when it melts.

Some careful market gardeners remove, after two or three weeks' planting, a few of the outer leaves with which the Lettuces have been planted, and which have grown too large, and do not contribute to form the head. Others intercrop with early Carrots, which they sow at the same time as they plant the former, thus securing a successional crop, but this is not the general rule, and many prefer to sow the early Carrots with Radishes in a special hotbed.

Treated as described the black-seeded crisped small early Lettuce, sown from the 5th to 15th October, and planted in the beginning of December, is fit for sale towards the end of January or beginning of February. It may, however, happen that too severe winters do not allow the hotbeds to be made up or to set out the plants. In such cases it is necessary to protect the plants on the sloping beds against the severe weather until they can be planted on the hotbeds. We first begin to draw a lining of short, dry, heating material against the back of the beds, and to cover the bell-glasses during night with straw mats. If frost increases it is safe to scatter first about half an inch of very short dry stable litter between the empty spaces of the bell-glasses, and in case the cold becomes too severe for the plants to be thus protected, the layer of litter should be increased to the height of the bell-glasses, and single, double, and triple mats placed over all if necessary. When the sun shines during a bright frosty day the mats are removed, also the litter on the top of the bell-glasses, to enable the plants to take advantage of the sun's warmth, and towards three o'clock in the afternoon they are covered again. The black seeded crisped small early Lettuces thus treated and planted in the hotbeds after the middle of December are fit for the market in the course of February and March.

When weather becomes milder, and no more sharp frosts are to be feared, the gardeners make up special Lettuce beds, 1 foot of stable manure deep, over which they place 4 inches of compost. Such a bed will hold three rows of bell-glasses, under which they plant four crisped small Lettuces, and one Cos Lettuce in the centre; they continue to cover and uncover the bell-glasses with straw mats, according to the temperature, until the plants are fit for sale.

The Tennisball Lettuce is not quite so early as the small crisped, but it is more productive, heads better, and as it cannot be grown without fresh air, its forcing differs somewhat from the preceding variety. It is usually sown from the 20th to 25th October on a sloping bed like the other, and although hardier may be treated in the same way. We have, however, stated above that it is not so early as the crisped small variety, and on that account it may be left on the sloping border until the latter has been sold, when we shall set it out to take its place on the hotbed. To do that it is not necessary to touch the heating material of the bed; we only loosen the compost with a fork, and when it is level plant towards the end of January or the beginning of February, at the rate of thirty plants to a frame light. They are protected from cold in the usual manner, but it is necessary that fresh air be admitted, tilting the sashes up at the back with pieces of wood whenever the weather is rather mild.—EUG. SCHAEFFEL, *Paris*.

(To be continued.)

POTATOES FOR IRELAND.

I HAVE been greatly interested in reading Mr. Iggulden's article on this subject, see page 61. Having been in Ireland for some years perhaps you will allow me to offer a few comments thereon, at the same time I have no desire to pose as an authority on the subject, beyond briefly relating my own experience. With Mr. Iggulden's preliminary remarks I heartily agree, but as to his selection of varieties which he recommends, at least as to some of them, I must express my dissent. "Magnum Bonum," says the writer of the article quoted, "is still a great favourite with us, and we had a capital crop on our low ground. The quality is good, and this Potato I would also strongly recommend for planting in Ireland." I hope no one will plant largely of this Potato in Ireland; if so I trust it will be someone with plenty of money who can afford to buy Potatoes for table use, and not the peasant who is dependant upon his Potato crop for his subsistence for the year. Having grown Magnum Bonum in Leinster, Ulster, and Munster, I am compelled to pronounce it one of the worst quality Potatoes.

In 1887 the quality was excellent; the summer of that year being hot and dry, it evidently suited the variety, but that is the only year it has been fit for table use, and the pigs have to get them. Last year we had an Irish acre of them, but we cannot use them. This year I intend having but one row of them, merely to keep the variety in stock. If not for its bad cooking qualities it would be a capital Potato for Ireland, as it is one of the heaviest croppers extant.

Dunbar Regent is an enormous cropper, and is, moreover, an excellent cooking Potato. Of these we had considerably over an acre. This and Emperor, of which we had another acre, will be the two varieties we shall rely on this year. Unlike Mr. Iggulden, we find Emperor a first-rate cooking Potato. White Elephant is the very worst Potato we have ever grown, and we were obliged to give it up. All the Ashleaf varieties do well here, also Laxton's Victorious and Beauty of Hebron. Village Blacksmith is splendid everywhere that I have grown it. The soil here is of a sandy nature, the district a mountain one. As the climate of England and Ireland differ so much, it would have considerably enhanced the value of Mr. Iggulden's article had he stated if he had ever grown the varieties in Ireland which he recommends for culture here.—R. WELLER, *Glenstal Castle Gardens, Limerick*.

SEDUMS.

SOME time ago, in writing of hardy plants in flower, I said that the Sedums or Stonecrops would require to be treated of by themselves. The task is by no means an easy one, as they have not received the attention from writers that they deserve, and in writing of them now I must disavow any special qualifications for the work beyond a liking for the plants and some study of their beauties and peculiarities. The Sedums have been much neglected in ordinary gardens for many years. It is true that some species, such as *S. glaucum* and *S. acre aureum*, have been in use by the carpet bedders, their uniform habit of growth eminently fitting them for these purposes, but the ordinary gardener would appraise their value at a very low figure indeed. It is true that the fast increasing number of Alpine growers leads to a greater taste for the curious and uncommon in plants, and that this class of amateurs is beginning to appreciate their beauty; but too often those of us who have the boldness to confess admiration for the Stonecrops find our remarks received with a pitying smile, which only requires to be accompanied by a significant tap on the forehead to express the opinion of the hearer that there is a screw loose somewhere with anyone who admits an admiration for such plants.

It is gratifying to note that the professional gardener realises that there is a great future before hardy and alpine plants, and that he is studying the subject with the zeal of one who feels that, if he is to keep his place in the ranks of his profession, he must keep himself abreast of the times. To him, then, as well as to the amateur I commend the Sedums as plants which will well repay him for the little care required in their cultivation, and will reveal afresh the wonderful way in which Dame Nature adapts her productions to the purposes they are intended to fulfil.

We find in studying the Stonecrops that, like many other plants, they had to contend with the difficulties of classification, and that in old gardening works there is sometimes a difficulty in unravelling the Sempervivums or Houseleeks from the Sedums, as both were grouped under the latter name. This is derived from the Latin *sedere*, to sit, in consequence of the plants being apparently seated or placed upon the stones or rocks to which they are attached. There is a considerable diversity of habit in the genus, but, like all the others of the same family, the Crassulaceæ, are of a succulent nature, having fleshy stems and leaves, and by means of these are enabled, like the Cacti of warmer climates, to withstand the withering influences of the sun and heat to which they are so much exposed in their native habitats.

A considerable number of the Stonecrops are native plants, and one of the best known of these (*S. acre*, the Bitter Stonecrop), grows very plentifully along the coast of the Solway, near where I write. It forms large masses 2 or 3 feet across, and appears to luxuriate in the sand, stones, and broken shells which abound where it grows. These masses of green are very pretty at all times in their bright contrast to the grey of their soil—if it can be called soil; but in summer when the carpet of green becomes a carpet of gold the eye is enchanted with the picture, and one would fain linger over this triumph of Nature's decorative art.

Among the Stonecrops *S. reflexum* was well known in old gardens, and is still occasionally met with. This has long stems thickly covered with fleshy leaves of a deep green, assuming a purplish tint in winter. In old days this was known as Trip Madam, Tripe Madam, and Prick Madam, all of which are said, on what authority I know not, to be corruptions of Triacque Madam.

S. reflexum has flat heads of yellow flowers with a tinge of green, and should always be planted below the level of the eye, a position suitable for most of the genus. A finer species of similar character, but with larger tufts of lighter green leaves, which do not become purple in winter, is *S. grandiflorum*. This has larger and brighter heads of flowers. For some time I considered this only an exceptionally fine form of *S. reflexum*, but it is grown in the Edinburgh Botanic Gardens under the name of *grandiflorum*, and has as much claim to the rank of a species as many other plants.

A few plants of these two kinds planted as part of a mixed edging to my garden walk created quite a sensation in June and July, 1889, the dry season suiting them exceptionally well. A very neat little species, which is commonly grown as *S. glaucum*, is largely used for carpet bedding. For this purpose it is not intended to flower, and consequently its beauty is not fully realised. The tufts of glaucous milky green, only rising about a quarter to half an inch above the soil, are very pretty, but I think the beauty of the plant is only properly seen when the little pinkish-grey flowers are so fully expanded as to conceal the leaves entirely from view. I have seen this greatly admired, even by people whom you could hardly expect to admire a flower of such modest beauty. There seems some confusion as to the true name of this species, and possibly several species are in the trade under the same name. According to the "Cottage Gardeners' Dictionary" *S. glaucum* is yellow, and has for a synonym the title of *S. Andersoni*, and I am inclined to think the true name of what is generally grown as *glaucum* is *corsicum*. Another pretty well-known species is *S. Lydium*, a very dwarf plant with lively green leaves, which in dry weather or when starved become of a bright coral red. This is a native of America, and was introduced in 1849. It is said to have pinkish-white flowers, but although I have grown it for five years it has never bloomed with me. *S. brevifolium*, a native of the south of Spain, is in my opinion one of the prettiest of the dwarf tufted species; at all events, so far as the colour of the foliage is concerned. The leaves are of a creamy colour, which afterwards become beautifully coloured with red in autumn. This species should be grown in peat. The flowers are white in July and August. There are several other dwarf tufted species which are very interesting, but there are so many others to note that I must reluctantly pass them over. I will continue the subject in a future issue.—S. ARNOTT.



CHRYSANTHEMUM MRS. F. THOMPSON.

I ENCLOSE a bloom of *Chrysanthemum Mrs. F. Thompson* from a cut-down for your inspection. I have been cutting *Chrysanthemums* up to the present time, and still have a few left. On New Year's day I cut seven large blooms of *Mr. H. Cannell*, also *Thunberg*, *Belle Paule*, *Mlle. Lacroix*, and *Princess Teck*, all larger and better than the one I have sent. I think societies should encourage *Chrysanthemum* shows for later dates. As you are aware nothing is more useful at Christmas and the beginning of the year. With exhibitors like myself who have limited room to prepare for the shows, as soon as the show is over the *Chrysanthemums* are over also, whereas if societies were to encourage later dates exhibitors would grow and manage their plants accordingly. Then how useful they would find them for decoration. I know several gardeners who had not one bloom the first week in December.—J. E. P.

[The bloom sent was a fine one, and a supply of such examples would be found useful at this time of year. It might be advisable to try a December Show, but the Exhibitions of the National Society in January have not been very satisfactory.]

CHRYSANTHEMUM GOLDEN GEM.

FOR blooming in January and February there are very few, if any, *Chrysanthemums* that can equal *Owen's Golden Gem*, and I know of no other variety that so readily adapts itself to late blooming. Its colour is of a deep bronzy yellow, and possesses a fine substance. When allowed to grow naturally, with the exception of pinching the shoots two or three times during the growing season, it produces terminal clusters of three or four blooms, that can be used for ladies' wear without any artificial arrangement, all that is required being to add two or three small Fern fronds, and the bouquet is complete. Ladies possessing cultured taste admire an informal spray such as this much more than one treated in a more unnatural manner. For vase filling too the same pleasing and natural features are presented as in the purpose previously mentioned, and are easily and quickly arranged in vases of any kind. *Chrysanthemums* are much valued at this season for any purpose, and those not having grown the variety under notice should not allow the cutting season to pass without adding it to their collection, however

select it may be. It has the additional merit of being a dwarf sturdy grower, which alone is of great worth, when they are employed for conservatory decoration in pots.—W. S.

LATE CHRYSANTHEMUMS.

MR. ROBERT OWEN, Maidenhead, sends us a bloom of *Chrysanthemum Mrs. Hugh Graham*, which he says is from a plant 3 feet high, and bearing three other blooms not so far advanced. It is a Japanese with broad incurving florets, white, with a sulphur tinge in the centre, possibly due to age. *Golden Gem* is a Japanese reflexed, with medium size blooms golden bronze, the centre reddish. It is bright, effective, and free, undoubtedly useful, and we recently saw a large stock in a market establishment, where it is valued as a naturally late variety.

THE NATIONAL CHRYSANTHEMUM SOCIETY.

AT the recent annual meeting of the above Society the financial statement was presented, from which the following particulars are gleaned. It appears that the total receipts during the year, including a balance of £19 0s. 9d. from 1889 and the amount of the reserve fund £95 13s. 8d., are £1067 4s. 5d. To this has to be added £41 14s., due from the Royal Aquarium Company for the January Show, with medals and tickets in hand valued at £9 8s. 6d. The expenses include £521 14s. 6d. in prizes at the three shows; medals £105 19s. 1d.; printing £71 16s. 9d.; stamps, telegrams, &c., £45 11s. 6d.; clerical assistance, collecting subscriptions, and canvassing for advertisements are entered in two items (one marked 1889), the total being £70 7s. 2s.; and the annual dinner cost £21 15s. 4d. There is a balance at the Union Bank of London of £28 7s. 8d.; and cash in hand of £18 19s.—Total £1067 4s. 5d. An item also appears at the foot of the account to this effect, "Due for printing catalogues, £70 16s. 8d."

HULL AND EAST RIDING CHRYSANTHEMUM SOCIETY.

WITH reference to the report of the meeting of this Society in the *Journal* of the 26th ult. we should have stated that only one exhibitor used unfair means to deceive the Judges; the others who had contravened the terms of the schedule had done so by removing some plants, in the groups, out of their pots, and had thus, in the opinion of the Committee, unintentionally transgressed.—EDWD. HARLAND, JAMES DIXON, *Hon. Secs.*

THE WINTER.

THE remarks in your leading article of January 22nd, on "Present and Future Difficulties," would be read no doubt by men holding responsible positions with far more than ordinary interest, since it expresses so truthfully the difficulties imposed on gardeners who have to meet a large demand particularly from the kitchen garden. A survey of this portion of the gardener's charge since the disappearance of the snow is disappointing to a considerable degree, for there is a fatality among the Broccoli, Cabbage, Lettuce, and other plantations, such as few of us are accustomed to; and many restricted in garden appliances will be put to their wit's ends to know how best to cope with the pending or actual famine in vegetables. In some instances the rulers of the kitchen are not always the most considerate or reasonable, and will press their wants even more severely in times of scarcity; but happily all are not alike. Root crops, such as Parsnips, Carrots, Artichokes, Salsafy, and Turnips, although indispensable, soon tire the palate when they have to be drawn upon frequently for the daily supplies without alternate change from Kales or other green vegetable; the appeals for these, not only from the cook, but from the mistress impatiently enforced, make the gardener's position anything but pleasant.

Swedish Turnips, where they are available, can be turned to good account where convenience exist for forcing them slightly, either in a light or dark place; but in the latter case it is well to give some notice at the table as to what constitutes the "dish," or the first supply may be "passed" on account of its colour. I remember an instance where the cook was summoned by her mistress to give an account as to the reason of the "Seakale" sent in being of such bad colour, when she explained that it was Swedish Turnip-tops and not Seakale; but this happened after dinner, when her privileged dish had been rejected. Such an intimation, of course, will only be necessary in the case of those not having previously provided them.

Broccoli that should have formed the early winter supply are killed, every plant, and there are very few survivors in the midseason ranks; but some dwarf plants of *Late Queen* do not appear so badly injured. Cottagers' and Scotch Kales seem the most hardy; some sturdily grown dwarf Asparagus Kale suffering badly. The stems of old Cabbage plants are as soft as though scalded, so is Parsley that has no frame protection, and also are the plants left in the seed bed for filling vacancies in the Cabbage quarter in spring, so that it will be necessary to raise plants of both Cabbage and Parsley to carry on the supply in early summer.

Fortunate are the owners of small gardens who laid up a store of Runner Beans in the autumn, for though a good deal of trouble is given in preparing them for table, their presence must necessarily cause satisfaction at a time of vegetable dearth in winter and early spring. In our case they have proved of excellent service in providing a change and diminishing the strain upon the outdoor stock. The process is simple in the extreme, and the expense infinitesimal; but the advantages in such winters as that of 1890-91 are almost immeasurable. Gatherings of entirely surplus produce in summer would be the means of providing many winter dishes, and the quality cannot be found fault with when properly cooked.—W. S.

ASCOTT GARDENS.

WITHIN two miles from the Leighton Buzzard Station on the North-Western main line from Euston is situated the Buckinghamshire residence of Leopold de Rothschild, Esq., bearing the name of Ascott. Standing upon elevated ground north of the Vale of Aylesbury, it commands a most pleasing prospect of English rural scenery, an extremely fertile district, bounded in the distance by the picturesque Chiltern Hills. This for nearly 300 years has been the site of a garden and residence, and though the present mansion comprises but a relatively small portion of the original structure, the additions and extensions have been conducted with so much skill and taste that much of the old character has been preserved. It is now a comfortable looking, picturesque, and spacious residence, exactly in accord with its surroundings, and the beau ideal of a country squire's hall.

In the garden, with which we are more concerned, important work

a place. One portion in particular must be delightful in the extreme during the summer months—namely, the Rose and hardy plant garden. This occupies a sheltered position, a long walk passing down the centre, with spacious beds on each side, filled with Carnations and all the best free flowering effective and fragrant hardy plants in grand masses, both beautiful and useful. At frequent intervals the path is spanned by arches covered with Roses, Clematis, Honeysuckle, Hops, and numerous other climbers, which are all made to twist and scramble and droop in delightful freedom and luxuriance. A large bed in a central position was last season devoted to Hollyhocks with admirable results. This garden must, in fact, afford a succession of welcome flowers from early spring until late autumn.

South of the house there is a fine expanse of lawn bounded by a low terrace wall. Golden variegated trees and shrubs are employed with excellent effects, one bank of *Olearia Haasti* and Golden Cypresses being especially noteworthy. Then magnificent hedges of Golden Yews

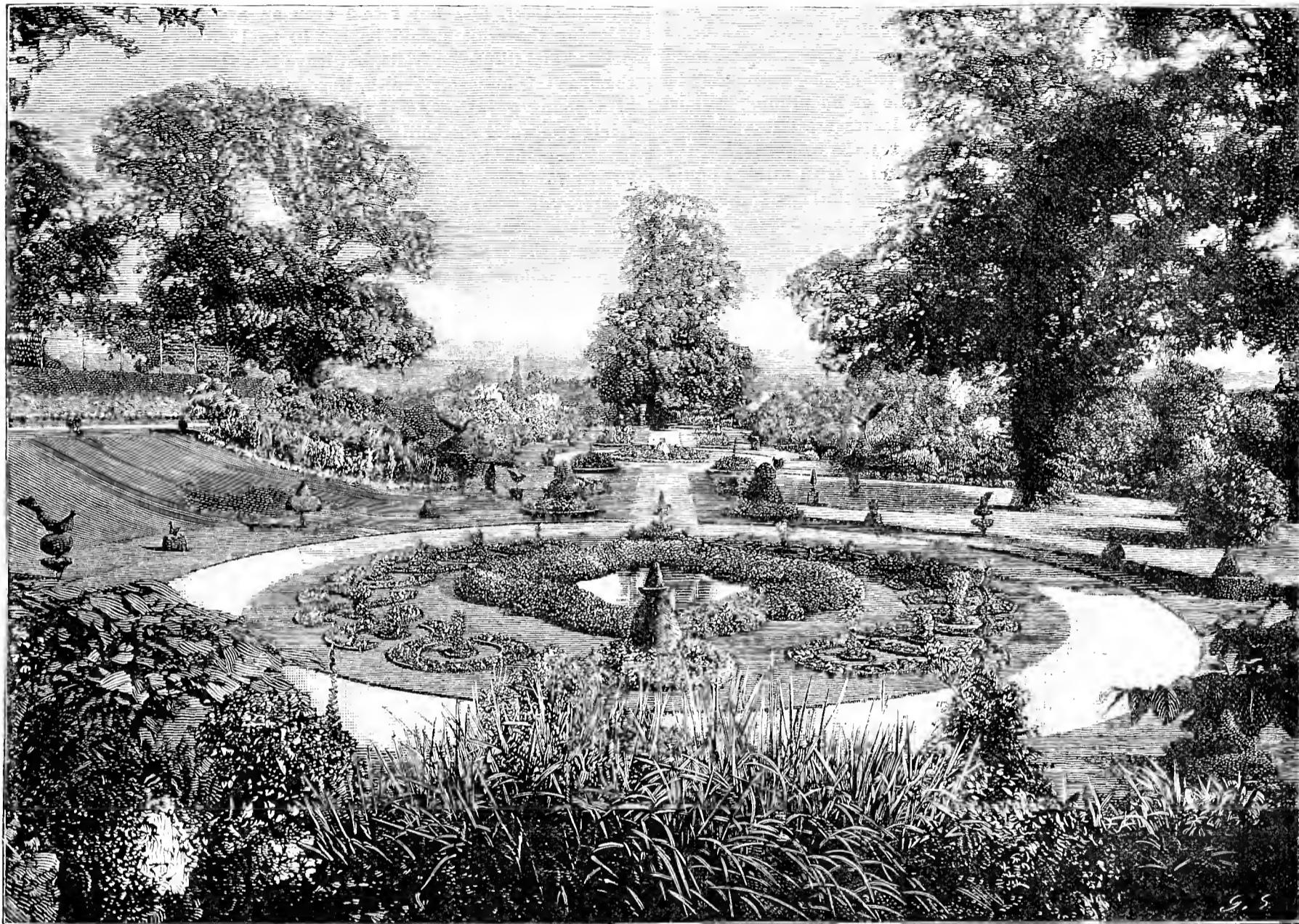

FIG. 20.—A VIEW IN ASCOTT GARDENS.

has been carried out with the same good taste and careful study of natural effects. The old trees have been preserved with almost loving care; but fine shrubberies have been formed, banks raised and suitably planted, dells and rockeries rendered more attractive by a judicious accentuation of their characters, and liberal additions to their occupants. A garden has thus been formed which increases in interest every year, and Mr. Rothschild gives the keenest attention to every detail where improvement seems desirable. It is the accumulative results of this watchful interest that constitute the charms of a beautiful garden, the development of which must be the work of years. When we contemplate a fine picture we see only the finished labours of the skilful artist, and except it be viewed with a professional eye the gradual steps by which this has been accomplished are not considered. So it is in a garden designed for natural effect. The greatest success is achieved when the process by which it has been attained is not perceptible to the stranger.

Our visit was made to Ascott at a time of year which is least fitted for showing the special features of a garden to the best advantage—namely, in November. Even then, however, it required but moderate imaginative power to realise the spring and summer attractions of such

and Golden Hollies extend for over 100 yards, and a walk near the Rose and Ivy covered walls brings us to the point where the photograph was taken depicted in the engraving (fig. 20). Upon slightly raised ground above a picturesque rockery bank the flower garden is overlooked, and then away beyond a distinct prospect is obtained of the Aylesbury Vale. Fine old trees form the framework to the picture, the velvety grass slopes, the beds of flowering plants, and the peculiar clipped Yew and Box trees constitute a varied and charming scene. Some of the strange examples of topiary work are great antiquities dating back at least a century and a half and worthily preserved for their interest. It may be remarked a handsome fountain has been placed in the centre since the photograph was taken.

With regard to the glass houses little need be said, for Carnations are the great speciality at Ascott, and these were referred to fully in this Journal last year (page 439, November 20th). Readers may, however, be reminded that 1500 plants of Miss Joliffe alone are grown, which yield something like 50,000 flowers. Many other choice varieties are also included, and the handsome *Souvenir de la Malmaison* receives special attention. In other houses Zonal Pelargoniums are well grown, together with miscellaneous plants for decorative purposes, Nerines

being great favourites, and all proving by their condition how well Mr. J. Jennings, the experienced gardener in charge, understands their requirements. A Peach case, planted with Roses in front and Peaches on the back wall, is also a useful house, two favourite Roses being Gloire de Dijon and Cheshunt Hybrid, which yield their flowers in profusion. Much more could be noted, as for instance the well-constructed bothy, an admirable example of what such structures should be; but these outlines of a well designed and ably managed garden will suffice to convey an idea of its style and scope.—L. C.

THE CULTIVATION OF THE PEACH AND NECTARINE UNDER GLASS AND ON THE OPEN WALL.

[A Paper read by Mr. W. TENNINGTON, Calderstone, Aigburth, before the members of the Liverpool Horticultural Association, January 10th, 1891.]

(Continued from page 81.)

GLASS.

MY remarks on the Peach under glass must be brief, therefore I propose only to touch upon a few items of culture. We will begin with the tree after the crop is gathered. As soon as possible all wood that has carried fruit, and all lanky and naked shoots, unless they be leading ones, should be cut out, so that little or no pruning will be required in the winter. After this all the leaves are put under the trellis, so that the wood which remains will have the full benefit of the light. We then give the border a thorough soaking with diluted liquid from the farmyard. The trees are syringed regularly morning and evening. It is often the case that the trees are left to take care of themselves after the fruit is gathered. All the air possible is admitted, but we never remove the sashes from the roof. In the autumn we give the trees and the whole of the house a dash over with petroleum, the same strength as I have previously named. No further winter dressing will be required. The trees will then be tied to the trellis, taking care to leave room in the tie for swelling. The border is then looked to. All the old soil for 2 or 3 inches is removed down to the roots. The borders are then top-dressed with new soil and a sprinkling of bonemeal and a little wood ashes. Every two or three years a dressing of fresh lime is added. Over this we place a mulching of cow manure, and conceal it with a little soil. This is all the mulching we give during the year. Previous to closing the house for starting we give the border a good watering with tepid water.

When fire heat is applied it must be done with considerable caution, as, however good the condition of root and branch, down come the buds if too much is applied. The same thing will happen if the trees have been neglected with water during the autumn and winter months; 45° to 50° is safe to start with at night, and 55° during the day, with a moist atmosphere. Ventilate freely at the latter temperature, but avoid cutting winds. This may be increased 5° as the trees come into bloom. Another thing to avoid; never bring manures that contain ammonia into the house while the trees are in flower.

A slightly drier atmosphere should be maintained during this period. If too high a temperature is kept at this time the wood buds are liable to take the lead of the young fruit, and in that case may often refuse to swell. When the fruit is swelling freely the borders, also the trees on fine days, should be syringed morning and afternoon. This syringing may be done with more force as the foliage gains strength.

THINNING THE BUDS.

This we do when the trees are overlaid with bloom, especially if they are rather weak. I think it is a great strain upon the trees as finishing a crop of fruit is later on in the season, as the roots are not in action at this early stage of growth.

I may here state that for all Peaches under glass we resort to artificial fertilising. I do not for a moment say that good crops cannot be obtained without this; but however much pressed with other work we find time to go over the flowers every day, which occupies two men for an hour or so the first thing after dinner. One operates on the Peaches and the other on the Nectarines. The brushes are changed every few minutes. By so doing the pollen is carried from one to the other. This may to some appear faddy, but it has always answered our purpose, as we have never yet failed to produce a crop.

DISBUDDING.

We commence this as soon as the wood buds show signs of growth. I consider this strengthens the flower, and further disbudding will require to be done with some judgment, as it is not well to remove too much growth at once. This can be done in three times, allowing a reasonable interval between them. The top of the tree and any strong branches

should be done first, leaving the bottom or weaker branches to gain strength.

THINNING THE FRUIT.

The first thinning should be given when the fruits attain the size of a pea. On this occasion removing all those on the under side of the branch, and reducing all triplets and twins to one, leaving the remainder about 3 or 4 inches apart. A second thinning will be required in about a month, leaving those that are best placed and show signs of swelling freely this time about 6 to 8 inches apart. A third thinning, which in the case of a courageous man will be the final one, should be given when the fruit has reached what is known as "the stoning stage." Some people leave a large number at this period to allow for dropping as they say. By adopting this means of securing a crop they are courting failure. If they leave more than the tree is capable of carrying over this trying time it will adopt its natural way of relieving itself of too great a burden, perhaps cost more than the cultivator bargained for, and not retain even an average crop. At this final thinning the fruit should be left 10 to 12 inches apart. Remove all pointed and ill-placed fruits, but leave those that have a tinge of rose on them, as this indicates health, if possible such as are placed at the base of a young growth. As the season goes on and the fruit is swelling freely (we water the borders freely with diluted liquid), a night temperature of 55° to 60° is quite high enough, with a day temperature of 70° to 75° for an hour or two in the evening with a moist atmosphere. Overcrowding the shoots when laying them in is a common occurrence. This is a great mistake, as it enfeebles the tree, and at the same time prevents the wood from ripening, and thus blights the prospects of a crop the following year.

THE STONING OF THE FRUIT.

For about six weeks there will be no perceptible growth in the fruit, although the work has been steadily going on. In my opinion it is not well to have the border too wet at this time, as the fruit is liable to take up too much moisture, turn brown at the kernel, and fall. A low night and day temperature should be adopted during this period, as there is nothing gained by hard forcing. The tree should be kept clean by a free use of the syringe. The cultivator will readily perceive when this sleep or rest ends, for growth in the fruit starts with a bound, so to speak. Now is the time to give the border a good watering with tepid liquid, or whatever fertiliser he may prefer. All fruit are raised up on old labels or split bamboo to the full sun, and leaves are placed on the under side of the trellis. If a leaf shades the fruit pitch half of it away and leave the other half. Increase both night and day temperatures, the former to 70°, and the latter to 80°, which may run as high as 85° for a few hours in the evening. This is the only time the Peach will stand sharp forcing.

In the last swelling of the fruits it is the custom of some cultivators to treat them to a steaming moist atmosphere of 90° to 100° in the evening. I do not approve of extremes. If a dull day or two follow this treatment, a low night temperature, and then the sun breaks out early in the morning before the moisture is off the fruit, they are liable to get damaged at the point. The skin is dull in colour, and does not look so well as fruit ripened under more natural and steady conditions. As the fruit approaches ripeness it should have free ventilation, as this will improve both colour and flavour. When it is ripe it should be examined each day. It should never be left to fall with over-ripeness. I think fruit is in the best possible condition for table when it takes gentle pressure to remove it from the tree. On the other hand, if it has to travel by rail or sent to market it should be gathered earlier, or damage in transit and loss will occur.

PACKING THE FRUIT.

When this has to be sent a distance, boxes or trays for the purpose should be made, about 5 inches in depth, and made to hold one or two dozen each. In packing lay a thin layer of paper shavings at the bottom. On this lay cotton wadding; wrap the fruit in thin tissue paper; then cut sheets of wadding about the depth of the fruit in 2 feet lengths. Wrap this round the fruit its full length, using a gentle pressure in placing them in the box. Put another sheet of wadding on the top, and if this is not firm soft hay or paper shavings should be used to make it so. If it is desired to keep the fruit for a time, it can be done by placing them on a soft surface in a cool cellar. They will keep in good condition for ten days or a fortnight.

If I were planting a house of Peaches for early work where half a dozen trees could be accommodated I should select the following:—Early Beatrice, Alexander, Hale's Early, Royal George, Bellegarde, and

Violette Hâtive. Nectarines:—Lord Napier, Pine Apple, and Violette Hâtive.

For a late house of Peaches my selection would be Barrington, Grosse Mignonne, Nectarine Peach, Noblesse, and Princess of Wales. Nectarines:—Downton, Balgowan, Hunt's Tawny, Pitmaston Orange, and Victoria.

In conclusion I will name three Peaches I would not plant at all. The first two are Early Rivers and Early Silver; these split the stones. The third is Lord Palmerston; a splendid Peach to look at, but however well grown it is always stringy and of bad flavour.



STRAY NOTES.

As I went to the Birmingham Show, on the evening of July 16th, my route lay over a line of rail, very familiar formerly, which I had not traversed for some years. As I passed a certain well-known station, my thoughts were strangely drawn to my earliest mentor in garden work. I knew he had returned to the scene of his life labours to lie, but was, of course, unaware that his spirit was passing away on that very day. Let me say a word, in memoriam, in the Journal, where all good gardeners are honoured.

William Burton, a native of Flitwick in Bedfordshire, at about the age of twenty-one, became gardener to the Rev. C. Ward, rector of the neighbouring village of Maulden, and remained there for forty-six years, a most faithful and trusted servant, till the death of his master in 1879. He was a grand specimen of the old-fashioned type of gardener in himself; and he had every opportunity for constant growth in knowledge and practice in the exceptionally fine grounds and garden where his lot had placed him, and in the happy chance which gave him an employer who was always ready to take to any improvement in fruit or flower, and in all those years spared no pains or expense to bring the place to perfection.

He had generally but one man under him, but he worked like a horse himself, and his subordinate, whom he would always cheer and never scold, could only follow suit. I should think it must have been thirty years before he had any glass, save one short row of unheated pits, yet the things he managed to raise and save through the winter were wonderful. He never lost his temper; discontent and ill humour were utterly unknown to his genuine "Apple face." The rectory boys were exacting at times, and mischievous at others, but even they, I think, would have been dismayed if they had ever seen him really angry. He was strangely different to the modern type of gardener, for with his corduroys and hobnails and broad Bedfordshire dialect it would now seem as strange that he should be so thoroughly up in his profession, as it would have been to the dear old man himself could he have known that anyone would ever write about him in a newspaper. Hundreds of Roses he budded, grew, and pruned with wonderful judgment, even before H.P.'s were known—a sickly little boy sitting by on the wheelbarrow handles and looking on admiringly; and to the last the choicest novelties were added to the collection. Gladioli, Carnations, and almost every florists' flower were taken up more or less as specialties at some time or other. Orchards of Apples and Pears were planted, cared for, and brought to perfection. To every branch of the work of a garden of high reputation he brought industry, care, and love.

For a man of his class he had less prejudice than usual against novelty. I can only remember a slight display against the first mowing machine. It was once discarded, I think, and the old scythe lovingly taken to again; but he was such a master in the use of that scythe to produce a gloriously smooth turf that one can hardly wonder at his being loth to lose his hard learned skill, even though the labour would be so much shortened.

A grand old rectory garden, and a grand old rectory gardener, who had little education (he turned the French names into genuine Bedfordshire with amazing pluck and memory), and perhaps never saw a flower show, yet in matters of practice and experience I, for one, would be glad indeed if I could learn from him still.

Requiescat in pace, and would there were more like him.

Mr. Cocker, of Aberdeen, was good enough to send me a specimen of the cards which he suggests for use in Rose judging. I understand him to recommend that these should be filled up and signed by the judges, and placed upon each exhibit. But does he think that every stand is always judged by points? The N.R.S. rules only order it "when necessary." And it would often be plainly impossible, as for instance at the Tibshelf Show of 1888, where fourteen stands of forty-eight were shown. The work to be got through in the time is arduous; and in many cases an additional burden could not be borne in the time limit. Nevertheless, I like the idea. I do think pointing sometimes becomes inaccurate from an unconscious raising or lowering of the standard, and this I think would be benefited, in the large classes, by

one of the judges carrying the standard bloom for immediate comparison in case of doubt or dispute. And it would undoubtedly be an education for visitors to see the number of points given to each Rose, which might be of considerable advantage. If the system were practicable, which I much doubt, I should like to see it in force.

On one occasion last summer I had a new experience as a judge. To take the place of an absentee I was asked to make a third in judging fruit and vegetables. My own doubts as to personal fitness were overruled. And, after all, even a judge must make a maiden essay. Our first task was the judging some Strawberries "for flavour;" and, when this was immediately followed by the sampling of some fine Melons, I began to think that this was the office for which Nature had designed me. But one of my *confrères*, of practical and professional aspect, did not join us in these revels; not that he objected to the practice of tasting, but he "didn't like them things." He listened with acquiescence to the satisfactory smacking of our lips, and sympathised with wry faces, or other expressions of disapproval. We progressed smoothly, and he rose much in my respect as a man to whom all such vanities presented no temptations.

At last we got to the vegetables, and, on coming to the Turnips, he showed increased interest, and, to my surprise, insisted that these also should be tasted. It was now our turn to protest that we "didn't like them things;" but our friend, who despised Strawberries and Melons, evidently did. He cut a neat slice out of a specimen of each of the best looking dishes, and tried them with the utmost relish; and now we watched his face with interest and concern. "Ah! that's very sweet,"—we prepared for a verdict—"but this is delicious!" First prize accordingly. One other vegetable was tasted, I forget which. I do not think it was the Onions, but I do remember that Onions gave us some trouble; the globular and flat types are so dissimilar that one must "go for" one or the other; and if you prefer one type for first prize, it seems as if you ought to do the same for the second.

I am inclined to fancy, from the experience of that day, that I am a better judge of fruit than of vegetables.—W. R. RAILLEM.

SMALL PINETUMS.

THAT the indiscriminate planting of Conifers anywhere and everywhere in the ornamental grounds of private gardens has caused much disappointment, is as certain as is the fact of the possibility of avoiding such annoyance by the exercise of due consideration before the planting, or rather before the trees are purchased. Who is to blame in this matter? Can we justly say the nurseryman is wrong who gives such prominence to Conifers in his show borders? Certainly not. He takes good care to present the trees which he has to sell under the most tempting guise, and it is for the would-be purchaser to consider whether the soil of his garden is, or can be, brought by the means at his disposal into an equally deep fertile condition to that of the nursery; for he may rest assured that the nursery soil is trenched deeply and kept abundantly fertile. Sluggish growth and unhealthy condition are ruinous to the nurseryman. He must have his trees "full of growth"—that is, sturdy, robust, and glowing with such health and beauty as appeals irresistibly to the buyers. It is for them to consider if they can afford the trees equally favourable conditions of soil and climate. If there is no doubt about it, after this vital matter is put to the test of that sound judgment resultant from mature experience, then buy and plant by all means, but do take care and plant well in every sense of this most comprehensive term.

The stately specimens at Dropmore show plainly how possible it is to have an attractive pinetum in a poor thin soil, but before attempting it may be well to count the cost, for without carefully prepared stations, and subsequent periodical additions of soil, one dare not venture upon anything like a free selection of Conifers. Thujas and Piceas may be ventured upon in such soil, but without the care indicated no one ought to plant *Abies*, Cedars, or Pinuses, except perhaps *austriaca* and *sylvestris*. We might of course put in a plea for the thorough cultivation of a few Conifers in poor soil, for assuredly they are entirely worthy of it, and a dozen or two really fine healthy specimens are not so very costly a luxury after all.

There are a dozen remarkable for distinct and striking characteristics, and which are worthy of a place in every garden. *Picea Nordmanniana*, *Cedrus Libani*, *C. atlantica glauca*, *Thuja gigantea*, *Thujopsis borealis*, *Abies Douglasi*, *A. Albertiana*, *A. Parryana glauca*, *Araucaria imbricata*, *Picea nobilis*, *P. pinapo*, *Pinus insignis*; and for a second dozen I would take *Cupressus Lawsoniana*, *C. erecta viridis*, *Thuja Lobbi*, *Thujopsis dolabrata*, *Libocedrus decurrens*, *Picea grandis*, *P. lasiocarpa*, *Abies alba*, *A. excelsa*, *Wellingtonia gigantea*, *Pinus Benthamiana*, and *Taxodium semper-virens*. We hardly expect this selection to meet with general approval, but the first dozen are certainly "hard to beat," and exception can only be taken to *Pinus insignis* because it is spiny,

tender, and cannot be planted far north. When it does answer it reigns supreme, and if it were possible to produce specimens as fine as those which exist on the banks of the Tamar in gardens generally, it would deservedly have first place in my list.

Lovely as is the glaucous variety of *Cedrus atlantica* it will have no mean rival in *Abies Parryana glauca*, which is so striking in the small examples I have seen of it, that with a free habit of growth one may safely predict a very prominent place for it. Only to produce a really impressive effect it, like the silver Cedar, should be planted singly amidst suitable surroundings; it requires dark green foliage near it to bring out its full beauty.

Wellingtonias have been much over-planted, and should be confined to very deep rich soil. The Deciduous Cypress (*Taxodium distichum*) is so lovely in summer that one would always like to include at least one of it in a selection. But it is not my intention to treat of Conifers generally here, and I must refrain from the temptation to mention many others, because I want to add a few words about the planting. To plant well not only must the soil have careful attention, but the trees must be arranged without formality, and with a suitable blending of deciduous trees or others calculated to impart pleasing contrast and variety to the scene, and so render it far more attractive than an ordinary pinetum is. If there is space for only a few Conifers on turf, then a lovely fringe of colour may be added by planting any borders near. In my notice of Orton Hall mention was made of the charming effect of a Holly laden with scarlet berries near some *Thuja gigantea*. I would also have Mountain Ash and *Cotoneaster frigida*, each so beautiful in its own season; and of other trees, White Birch, Scarlet Oak, Purple Beech, Liquidamber, and such of the Maples as *Acer heterophylla dissecta*, *A. lutescens*, *A. colchicum rubrum*, *A. macrophyllum*, *A. Schwedleri*, *A. variegatum*, the Norway Maple, Judas Tree, *Gymnocladus canadensis*, *Acacia Bessoniana*, *A. Decaisneana*, *A. monophylla*, *Ailantus glandulosus*, *Prunus Pissardi*, and the *Salisburia*, all which are remarkable for beauty of growth, form, or colour of foliage.

There can be no law of taste binding us to a literal interpretation of the term Pinetum in planting Conifers. Better far to ignore it altogether than to sacrifice the graceful grouping and mingling of trees so admirably calculated to impart and receive beauty by force of contrast. It is true that Conifers give warmth, fulness, and elegance to a garden in winter; so also deciduous growth imparts its own peculiar charm at other seasons of the year.—EDWARD LUCKHURST.

EXHIBITION HOLLYHOCKS.

ALL growers and lovers of this grand plant, the Hollyhock, must feel a deep debt of gratitude to Mr. G. Steel for the great trouble he has voluntarily taken upon himself in trying, and I hope with success, to clear up a subject which is of vital importance to all persons interested in the exhibition of Hollyhock blooms—viz., a determination to have none but the true variety the purchaser asks for. I have repeatedly seen purchasers served with plants under the name required, but when the plants unfolded their flowers the greatest disappointment ensued, as they turned out to be worthless varieties. I suggest that vendors as well as buyers try and put a stop to this not very commendable practice, as it would do away with much uncertainty and vexation. I have often heard it said, and I have also read, that the Hollyhock has deteriorated of late years. I have had letters from all parts of England, Scotland, and Wales asking me the same questions. My answers to all have been the same—viz., "No; not at all," as many of the older varieties are still to the fore. I would like to ask the veteran growers which were their best varieties, and see if some of us do not possess the true sorts.

I have been familiar with the Hollyhock for at least twenty-five years, and I can truly say if memory serves me rightly that I have grown and shown better Hollyhock blooms for the last eight or ten years than I remember having seen twenty years ago. If any of your readers saw the display of cut blooms at the Newcastle-upon-Tyne autumn Show in 1887, better known as the Jubilee Exhibition, when twelve stands of twenty-four were staged for competition, they must, I think, admit there has not been much deterioration. I consider only the first and second-prize collections were good, my own and Mr. A. Rogerson's respectively. After those two stands the quality of the blooms gradually dwindled down to specimens about as large as Globe Asters. Take again the Newcastle autumn Show of 1889; there were not quite so many competitors, but the blooms were decidedly better than in 1887. I believe Mr. Jas. Douglas judged the cut flowers in both years. What has he to say respecting them? It has been a greater difficulty to procure really good sorts than it has been to cope with the disease.

It may appear somewhat egotistical on my part to relate in these

columns my own success as a Hollyhock exhibitor, but why I do so is that it may be an incentive to others. I have exhibited during the last ten years all over the country, including the Crystal Palace, Newcastle, and Alnwick, and many other places about ninety-four stands of blooms, and my record is ninety-one first prizes, two seconds, and one third. It will thus be seen I ought at least to know something of good exhibition sorts.

I will now give a few remarks about Mr. Steel's list. I may state, as he does, that some far down the list will before long take a higher position; for instance, W. E. Gladstone and Mr. Fenwick will, I presume, nearly head the list when distributed. Mr. Steel has Grace Darling at the top, which position it has great claim to, but my opinion is that Queen of the Yellows in perfection is the finest variety in cultivation. Peri is the only white I know worth growing.

In conclusion, I will name what I consider the best twelve sorts—viz., Grace Darling, Queen of Yellows, Robert Ryle, William Ewart Gladstone, John Finlay, Maggie Bain, Mrs. Maynard, Favourite, Ruby Queen, Agnes Ryle, Peri, and Le Grande. To add to this another twelve I would say have F. G. Dougall, Lord Decies, Leviathan, Hercules, Venus, Mrs. Codling, Pride of Layton, Walden Queen, Conquest, Majestic, Thomas Fenwick, and Champion. These, if true to name and well grown, would almost be unsurpassable on the exhibition table. I urge upon exhibitors not to strive so much for a large collection, but to form only a well chosen selection. The same applies to all other kinds of florists' flowers besides Hollyhocks. It is better to grow several plants of one variety than so many of a worthless or inferior type. Those who would like to grow Hollyhocks must not be deterred by the fungus, for by careful management this can be kept at bay. Cut the plants down as soon as they have finished flowering in the autumn, the earlier the better, cover them with light soil about 2 inches deep; they will soon be seen to push through the soil fresh and clear of disease. I may in a future note have something to say about my mode of cultivation.—GEORGE FINLAY, *East Layton Hall Gardens, Darlington*.

[Details of culture from such a successful exhibitor will be acceptable to many readers.]

CLEANING GRAPES OF MEALY BUG.

NOTHING is so interesting to me as each week comes for the issue of the Journal than to read the various articles for what information I can obtain, and I confess there is abundance for all. The note under the above heading (page 13) rather surprised me, however. According to "J. H. W." we have to imagine two men, one holding a bunch of Grapes over a pail, and the other with a syringe or hydrant and a pail of water forcing out insects. "J. H. W." remarks, "Garden literature abounds in detailed instruction for ridding our Vines and vineries of mealy bug, but it is questionable if ever it was more prevalent than it is to-day." Nothing is more simple than to thoroughly clean Vines that are infested with mealy bug or any other insects.

I should prune the Vines as soon as possible after the leaves are off, have a flat box standing close by so as to lay the shoots in that they may be carefully taken away and burnt, then have one rod at a time taken down from the trellis and every bug that can be seen killed at once. After going over all the Vines in this manner I should thoroughly clean all woodwork and glass, using a stiff scrubbing-brush for this purpose, having a pail of hot water wherein half a pint of petroleum and half a pound of softsoap has been added and well mixed. At the same time have the walls lime-washed with hot shell-lime. It is necessary that this be slaked in small quantities, so that it may be used whilst fresh and hot. See that every hole and crevice be stopped up. The Vines themselves should then be well syringed with tepid water, so that all loose bark may be more readily removed without injury to the Vine. It is necessary that a man of some experience should perform this operation, for it is mostly round the eyes the pests secrete themselves, and therefore the canes must be cleared of all loose bark without damaging the dormant eyes. As this work proceeds see that holes which were caused by the shrinking of the pith after last season's pruning are stopped, for there is no better place for these troublesome pests to deposit their eggs in. I use the following composition for this purpose—three parts beeswax, three parts resin, and two parts tallow, heat them until a liquid is formed, see that they are incorporated by being well stirred, and when cooled down it is fit for use.

Dress the Vines with a composition made as follows:—To three gallons of boiling soft water add 2 lbs. of softsoap, after this is dissolved let the water cool down, then mix 5 lbs. of flowers of sulphur, a little soot, half a pint of petroleum, and one pint of Bishop's Fungicide; this latter ingredient will thicken the whole into the consistency of paint. Have every part of the canes well painted with this, and after they have become dry replace them in their former position. Remove about 2 inches of the surface of the border and supply fresh composite. Paint the hot-water pipes with linseed oil and vegetable black. After this routine has been completed all in the house would be sweet and clean, but should the pests again appear on the Vines carefully look over them during the summer and apply petroleum with a small brush.

Some ten years since I completely eradicated this troublesome pest from two vineries that were infested in the worst possible form by the above method.—ALFRED BISHOP, *Westley Hall Gardens, Bury St. Edmunds.*

DR. MASTERS AND THE GARDENER'S CHRONICLE.

IN the present issue of the *Journal of Horticulture*, which we trust will not disappoint its readers, we wish to give ourselves the

of gardening is practised by the community. Each has pursued a thoroughly independent course, and neither has hesitated to assert itself when circumstances have arisen to call forth opposing views on subjects of public interest. As it has been in the past so it will be in the future, and Wellington Street and Fleet Street will not always be in unison, nor is it desirable they should be, for in debatable matters it is only by the expression of differences of opinion that the truth can be elicited.



FIG. 21. — DR. MAXWELL T. MASTERS.

pleasure of recognising an event in the career of a respected contemporary, and to present our compliments to its accomplished editor, Dr. Maxwell T. Masters. The *Gardener's Chronicle* has recently attained a period in its existence known as the Jubilee—a term of fifty years of weekly issues. It is the senior by only seven years of the *Journal of Horticulture*, and to speak paradoxically, we may venture to say that both these old Journals are as young as ever, and disseminate each in its own way matter of interest to botanists and horticulturists throughout the world where the science of botany is studied and the art

But public duty is one thing, personal respect between those who engage in it another, and Dr. Masters is, in truth, highly respected by those who are responsible for the production of this Journal, and his good work appreciated. It was no light task to succeed a man like Dr. Lindley, but Dr. Masters proved himself equal to the position, and to maintain the high scientific tone of the paper which he conducts so well. He is active in his endeavour to assist any good work that comes within his province, whether it be of an educational or charitable tendency, and he is also a strong and effective supporter of the Royal Horticultural

tural Society. A keen well trained intellect, a good heart and winning manner, are the characteristics of Dr. Masters, and we think they are reflected in the portrait that we have the pleasure to present.

MAXWELL TYLDEN MASTERS, M.D., F.R.S., was born at Canterbury in 1833 and was educated at King's College, London. In early life, indeed when he was a mere youth, he devoted himself to the study of natural history, various branches of which attracted him in his early career, but eventually after qualifying himself for the medical profession, which he practised for some years, he devoted all his energies to the pursuit of structural and physiological botany. So well had he distinguished himself in this science that he was chosen lecturer on botany at St. George's Hospital, an office he held with great acceptance from 1855 to 1868. On the death of Dr. Lindley he became principal editor of the *Gardener's Chronicle* in 1865. On the occasion of the International Horticultural Exhibition at Ghent in 1888, Dr. Masters was Vice-President of the Jury, and had the distinction of Chevalier of the Order of Leopold conferred upon him, and in the same year he was elected a corresponding member of the Institute of France in the room of the late Professor Asa Gray of Harvard University.

Dr. Masters has been a voluminous writer and a hard worker. His more important works are a treatise on "Vegetable Teratology," "Botany for Beginners," and a revised edition of Henfrey's "Elementary Course of Botany." He has assisted in the production of Oliver's "Flora of Tropical Africa," Hooker's "Flora of British India," and other works of an important character.

THE BEST FLOWERS FOR CUTTING.

WITH the continually increasing demand for cut flowers there is, at the same time, a rapid increase in the number of plants suitable for the purpose. Gardeners at no period have had such a varied collection open to their selection as they have at present, and the extent to which they can draw on all kinds, hardy and tender, annual and perennial, is practically unlimited. No private establishment could find space to do justice to a large number; but whilst that is the case it is possible, and withal very convenient, to so restrict, to so select the plants cultivated, that along with an abundant supply it may, at the same time, include the choicest in the several sections. The notes which follow it is hoped may be useful in directing attention to a number of really good plants, and the cultural advice meet the wants of the least experienced.

Hardy plants occupy a position of great importance as producers of useful flowers for cutting, and in the term hardy plants it is not to be implied that the words indicate what are known as "herbaceous" merely, but are meant to include good hardy annuals and biennials as well. It is impossible to conceive the amount of garden space which is wasted every year. If annuals are grown they are chiefly useless sorts. If hardy perennials, much the same remark applies. Now, it is a fact which anyone who has gone into the matter practically and experimentally must admit, that the best decorative annuals and perennials are also those best adapted for furnishing a continued supply of flowers. In many seasons with the aid of a few good flowering and fruit-bearing shrubs the entire year might be circled with flowers grown in the open. The present season, of course, is a practical reminder that the greenhouse is a most useful adjunct to the garden, but happily seasons like this are somewhat out of the normal course, and the fact remains that much more can be had from the portion of gardens devoted to flowers than is generally the case.

Many annuals are not really hardy, and are unsuitable for autumn sowing; they can only be raised in the spring of the year in which they are to flower. The benefits accruing from autumn raised seedling are a much earlier bloom and generally stronger plants, while with attention the continuance in flower extends as late in autumn as the spring sown series. Common examples are Sweet Peas, Cornflower, Oxeye Daisies, and Candytuft. The time to sow in spring depends very much on locality. The beginning of March for the warmer districts, ranging till the end of the month for late districts. Thin seeding is a matter of first importance. One plant of a strong growing species will produce a greater quantity of flowers than if several were grown close together, while the quality will be superior. This is a certainty, only it must be noted that the plant which is to be allowed to grow must from the beginning have plenty of space. A multitude of seedlings confined to a limited space in a short time extracts all sustenance from the soil, and those left have this drawback to overcome with a weakened constitution engendered through overcrowding. Another important point is that of removing all seed capsules at regular intervals.

In addition to the flowers already named, the following are all

suitable for furnishing good flowers. *Calliopsis bicolor* is much better than some mixed strains of *Gaillardia*, capital for mixing with other flowers. *Chrysanthemums* yield a selection of good flowers. The Corn Marigold for some years has been much grown. I find a few plants very useful, but use it only occasionally. The best of the others are the Double White and Yellow, Dunnett's White and Yellow, and *C. tricolor*, and the variety *Burridgei*. There is a continental form of these with double flowers, very pretty and useful. Each plant of these should have plenty of space.

Godetias are useful, and the variety is now great. *Duchess of Albany*, *Lady Satin Rose*, and *Bijou*, the last a distinct small flowered form, are a good trio. A packet of mixed varieties will give satisfaction. Allow a space of at least 12 inches each way betwixt each plant. *Larkspurs* are worth being represented by the branching form. One plant forms a good sized bush, and yields a large quantity of flower. I grow the blue form only. *Love Lies Bleeding* is to be grown in the same way as the last. It is of value for furnishing very large vases. *Sweet Sultan*, white and purple, is indispensable. They are suitable either for mixed arrangements or for employing alone. These are among the best of flowers for cutting.

Tropæolums give us a valuable selection of flowers. The dwarf forms should alone be grown. The yellow and bronze shades are unique in their tones. One seed should be sown where a plant is wanted, and if the soil is in good heart it will cover about 2 feet square. A poor soil is best for these, as they flower so much more profusely. They are most suitable for small glasses or bowls, and look prettiest in a setting of their own leaves. *T. peregrinum*, or the Canary Creeper, is one of the very best plants from the cut flower point of view. The plants should not be closer than 1 foot to 18 inches. We employ it either for small glasses or in long shoots for very large vases, allowing the stems to hang loosely or to twist round the vessel. *Pot Marigold* furnishes a desirable change. The selection we grow is a Continental one, flowers of large size, and of a deep orange shade of colour.

Hardy biennials may, in many instances, be treated as half-hardy annuals, and raised under glass the same year as they are flowered. Many of these, moreover, become perennials in mild winter. However, as a rule, young plants will be found of the greatest value, as they yield a greater profusion of better flowers. The end of June or beginning of July is a good time to sow, and the seedlings should be transplanted from the seed bed in early autumn to the place they are intended to occupy. *Antirrhinum*s are worth including. We occasionally fill vases with flowers from a good strain. The dwarf forms should not be grown for the purpose of supplying cut flowers. To *Canterbury Bells* much the same remark applies.

Foxgloves are excellent. The finest of all is the white form. Cut with long stems this makes one of the most effective cut flowers. A shaded position in a room should be chosen, as unfortunately these do not stand very well when cut. *Heartsease*.—The fancy *Pansies* grown from seed and treated as above yield a profusion of pretty flowers, which are most acceptable for furnishing flat dishes during the summer and autumn months. They are best set up among their own foliage. *Oenothera Lamarckiana* should find a place because of its perfume as much as on account of its large open yellow flowers.

Sweet Williams, when the strain is good, are valuable. Double mixed, *Carter's Auricula-eyed*, *Scarlet*, and *White* are all especially fine. We use them for large glasses mixed with other flowers. *Wallflowers* demand the same remarks about the quality of the strain as the last. The blood-red and a clear yellow are the two best forms. We find them indispensable.—B.

BISMARCK APPLE.

APPLE growers are indebted to Mr. Geo. Bunyard for the trouble he has taken to trace the origin and history of the Bismarck Apple. As my name is mentioned in connection with its introduction to this country, perhaps a few words from me will interest some of the readers of the Journal.

I did not receive grafts from Auckland, as stated by Mr. W. J. Palmer. During the summer of 1881 I received from my brother in Auckland a small box containing six young trees of Bismarck. They were genuine dwarfs, stock and scion did not measure more than 6 inches. They were packed in wood ashes, and although ten weeks in the box they were fairly fresh. Four out of the six grew, but made little progress that season; however, in the following year they gained strength and set blossom buds. In 1883 several fruits set, and a dish was exhibited at the Chiswick Congress. Three of my trees then passed into the hands of Messrs. Veitch & Sons, and from them were produced the splendid fruits to which was awarded a first-class certificate at the Crystal Palace Show in the autumn of 1884.

Mr. Palmer claims having first introduced Bismarck into England, and having sent to Messrs. J. Laing & Sons twenty-four plants of

it two years before I had my stock. If this be so, it is remarkable that a firm so noted for their energy, and having such a stock of trees, should be two years behind me in publicly exhibiting their produce. Mr. Bunyard and I agree in thinking that Alexander may be one of its parents, but the other must be a solid, heavy, long-keeping variety. With me Bismarck is one of the largest, heaviest, long-keeping Apples I have.—J. MCINDOE, *Hutton Hall Gardens, Guisborough.*



EVENTS OF THE WEEK.—To-day (Thursday) the Royal Society will meet at 4.30 P.M., and the Linnean Society at 8 P.M. On Friday the Quckett Club meet at 8 P.M., and on Saturday the Royal Botanic Society meet at 4 P.M. Next Tuesday, February 10th, will be a rather busy day for horticulturists at the Westminster Drill Hall. The Royal Horticultural Society's Fruit, Floral, and Orchid Committees will meet at 12 noon, and at 3 P.M. the annual general meeting will take place in the Lindley Library, 117, Victoria Street. The same evening the annual dinner of the Horticultural Club will be held at the Hotel Windsor at 6 P.M., and the Wimbledon Horticultural Society's annual dinner takes place at the Dog and Fox, Wimbledon Hill, at 7 P.M.

— THE ROYAL HORTICULTURAL SOCIETY.—We have received the balloting lists of the Royal Horticultural Society, which it is proposed are to govern the proceedings at the annual meeting to be held on the 10th inst., but we confess to be somewhat puzzled as to the way in which the election is to be conducted as therein set forth. In accordance with the Charter one-fifth of the Council are to be removed annually. This year those recommended by the Council for removal are Sir C. W. Strickland, Bart., Col. R. H. Beddome, and T. Francis Rivers; and the three Fellows recommended by the Council to fill their place are Sir John Llewelyn, Bart., George Bunyard, and D. Morris. Let us assume that these three gentlemen will be elected to fill the vacancies; but is not Mr. Morris already a member of Council, and will remain a member, notwithstanding his rumoured resignation, till after his resignation has been accepted by the annual meeting? If, as has been suggested, Mr. Morris only resigns the treasurership, no matter: his resignation must still be accepted by the annual meeting. How can Mr. Morris be recommended to fill a vacancy on a Council of which he is already a member, and from which it does not appear he is to retire? Then if Mr. Morris remains a member, how is Mr. Crowley, who is recommended for the office of Treasurer, to be dealt with? for if he is elected as Treasurer that will make four new members of Council instead of three, for the Treasurer must be elected "from among the members of the Council" by the Fellows then present at the annual meeting; so says the charter. Mr. Crowley is not nominated in the balloting list for election on the Council, nor is there now time for his nomination, and if the Society is to have the benefit of Mr. Crowley's undoubted ability for the office of Treasurer it appears to us that one member of the Council must after the election resign, and the Council can then appoint Mr. Crowley to fill the vacancy till the annual meeting in 1892, when his appointment may be confirmed by the Fellows.

— THE WEATHER IN THE METROPOLITAN DISTRICT has been generally open and comparatively mild during the past week. Moderate frost has occurred on two or three mornings. Rain fell rather heavily on one or two days, but bright sunny weather has prevailed. The soil in gardens is becoming more workable, but is still very soft in many places.

— THE HORTICULTURAL CLUB.—The annual house dinner of this Club will be held at the Hotel Windsor, Victoria Street, Westminster, S.W., on Tuesday, February 10th, when the chair will be taken by Mr. John Lee, Chairman of the Club. Dinner will be on the table at six o'clock; tickets 5s. 6d. each, not including wine, &c. Mr. Geo. Bunyard and Mr. Harry Turner have kindly arranged for a selection of vocal and instrumental music to be given during the evening.

— THE schedule of the YORK FLORAL GALA is to hand, and announces the dates of the Show as June 17th, 18th, and 19th next. The

classes number 106 for plants, flowers, fruit, and vegetables, the prizes ranging from £20 to 5s., liberal provision being, as usual, made for specimen stove and greenhouse plants. The Secretary is Mr. C. W. Simmons, 13, New Street, York.

— ON Monday evening last MR. GEORGE PHIPPEN entertained his staff to a supper in the large room of the British Workman, Abbey Square, Reading. Over seventy sat down to the repast. An important feature of the evening was that of the employes receiving a participation in the profits of the business of the past year.

— A NEW PRIMULA.—Messrs. B. S. Williams & Son, Victoria and Paradise Nursery, Upper Holloway, send us an example of what they term "a sport from our *Primula sinensis alba magnifica*." Unfortunately it was packed in cotton wool and arrived in a withered condition that did not permit its true characters being seen. It appears, however, to be a good double variety, the flowers white with a blush tint.

— A PARISIAN SEED LIST.—The list of seeds available for distribution from the Natural History Museum of Paris (*Jardin des Plantes*) has come to hand from M. Maxime Cornu, and includes a very large number of names. The catalogue comprises seventeen large pages, four columns to a page, and with a total of over 1000 names; these are arranged on the natural system, commencing with the Ferns and terminating with the "Gymnospermæ."

— SPARROWS AND FRUIT BUDS.—As usual the sparrows in one day made sad havoc with the buds of the Gooseberries. On January 13th, with a mild rain, they came in great numbers, and in some cases scarcely a bud is left. Sparrows never interfere with buds here unless the weather is moist. The only hope we have of securing fruit is to prune, so that plenty of new wood is thrown up. If we were to prune on the spur system we would never get fruit.—W. T.

— WE learn that a valuable addition has recently been made to the Kew Herbarium by the purchase of an extensive collection of dried plants from West Sze-chuen and the Tibetan frontier, at elevations of 9000 to 13,500 feet, lately brought home by Mr. A. E. Pratt, who travelled and collected ornithological and other specimens of natural history at the expense of Mr. J. H. Leech. It is said that the botanical specimens are excellent, and promise many novelties of Himalayan affinities.

— FIRE AT A SEEDSMAN'S.—Messrs. Hurst & Son, 152, Houndsditch, write:—"As we have received several letters from sympathising friends respecting the fire which recently occurred on our premises, we beg to state that fortunately it was but a slight one. It is true it was alarming at the time, and would probably have proved serious had it not been promptly discovered and extinguished. The damage was confined to a very small space. It occurred in the basement of one of our shops, and quite apart from the warehouses, and has in no way interfered with the conduct of our business."

— SHREWSBURY GREAT FLORAL FETE.—The annual meeting of the members was held at the Music Hall, Shrewsbury, last week, when a large number were present. The account showed that 1890, in spite of the unfavourable weather, was the most successful Fête ever held. The receipts amounted to nearly £3000, and the profits of the Fête itself to £878. After deducting the cost of the spring and autumn Shows, which are free to all subscribers and families, the net profit on the year is £709. As will be seen by an advertisement, the Society have greatly augmented their prize list; the total amount offered in cash prizes, and open to all, is no less than £640. The Right Hon. Lord Harlech was elected President for 1891.

— A PROLIFEROUS ORANGE.—Mr. G. Steel sent us with the curious Potato figured on page 114, a prolific Orange, with the following note relating thereto:—"At a festive gathering on New Year's Eve my little boy got an Orange which he did not quite approve; on looking at it I found part of the skin decayed, and on commencing to take it out what seemed to be a young Orange appeared. Is such a freak of Nature usual or possible? I have sent the Orange for your inspection, and would be pleased to have your opinion." [The small Orange within the large one and near its apex was about an inch in diameter. We have seen similar examples, and two specimens were examined by the Scientific Committee of the Royal Horticultural Society last month, the opinion of the savants being published in our report of the meeting on page 64, the issue of January 22nd.]

— THE CATERPILLAR PLAGUE IN CHESHIRE.—Mr. J. Arkle, a member of the Chester Natural Science and Literature Society, informs us he is the author of the remarks on this subject that were quoted from the "Entomologist" by a correspondent and published in our issue of the 15th ult. (page 46). Mr. Arkle adheres to his statement that caterpillars were not more abundant than usual in that county in 1890, and sends supporting testimony to the effect that the "plague" referred to was very much of a myth, and that frost, not caterpillars, destroyed the fruit blossom. Mr. Arkle is, however, wholly in error respecting the identity of our correspondent, and who lives very far distant from Cheshire, in which county all entomologists do not reside.

— WE are informed that Mr. A. Outram has just had erected in Brompton Cemetery a fine monument to the memory of the late WILLIAM COURT, who represented Messrs. Veitch & Sons in America for many years, the same being subscribed for by his American friends through Mr. A. D. Cowan of Chambers, Il., N.Y. The monument is about 9 feet high, red granite set upon a substantial York stone landing, bearing the following inscription:—"In memoriam. The American and English flags entwined. William Court, born September 1st, 1843; died September 7th, 1888. Subscribed by his American friends." The same is a fine piece of workmanship by Messrs. J. Barker and Son, West Brompton, S.W.

— WHITE POINSETTIAS.—Mr. W. Kipps, The Gardens, Walton Lea, Warrington, in referring to the value of Poinsettias for decorative purposes from the end of autumn till the present time, states that he grows many of the white variety for associating with the red, and arranged with Palms, Ferns, Asparagus plumosus, and other plants the result is highly satisfactory. The bracts of the white variety are, he says, quite free from the green tinge which is often seen, and he considers white Poinsettias well worth growing. His plants vary from 1 foot to 6 feet in height, the dwarfier being raised from cuttings in summer.

— LIVERPOOL HORTICULTURAL ASSOCIATION.—At the twelfth annual general meeting of this Association Mr. Thomas White, who presided, appropriately referred to the loss the Association had sustained through the deaths of the late Sir T. Edwards-Moss, Bart., and Mr. Enoch Harvey. The Secretary's report indicated a financial gain of nearly £90 during 1890, a sum not hitherto gained since the year 1884. The exhibitions held during the year have been in point of merit very successful. The return of the summer Show to Sefton Park, and the splendid weather on both days, had the effect of increasing its popularity. The receipts for the autumn Show for the first time equalled the expenditure. The numbers of visitors at the Show were 2789, summer Show 7045, autumn Show 6983. The subscriptions have increased £42 on the previous year. Thanks were accorded to nurserymen and florists who had rendered effectual aid, and officials were elected for the present year.

— THE LIGHT RAINFALL AND FRUIT TREES.—Mr. W. Piffé-Brown, of Gloucester, has furnished some very interesting statistics on the rainfall in Gloucestershire from 1865 to 1890. It appears that the latter year was the lowest for more than twenty-five years, with 18.86 inches. The greatest fall in the period was in 1882 with 40.40 inches. By Mr. Brown's record the deficiency for 1890 is 9.20 inches, and during the past five years there has been a decline in the rainfall. February has proved the driest month by far, with an average during the past five years of only 0.89 of an inch. May was the wettest, with an average of 2.82, July with 2.81, and November with 2.61. The question is how much this deficiency of moisture will affect our fruit crops, more particularly orchard trees on sward. Before the recent severe frosts set in I planted a good many trees on ground where the soil is kept continually moved on the surface, which is well known to prevent evaporation, yet on digging down about 18 inches or 2 feet the men could scarcely get their spades in the soil, it being so dry and hard. In many parts last year the fruit dropped prematurely, showing no trace of injury from insects. May not the lack of moisture in the soil account for it? I think that was the cause, as naturally the fruit would drop if such was the case. I am very apt to take a too cheerful view of matters, but I think there is good reason to be somewhat anxious about the prospects for the present year, more especially as stated for trees in grass, as the soil is much drier as a rule, consequently they will feel the effects of drought more than those where the land is cultivated. We always keep the hoes at work among our dwarf trees, and have mulched with a quantity of long manure, so that if we have a dry season we shall not suffer so much as where no steps are taken to prevent the escape of moisture.—S. T. WRIGHT.

— GARDENERS' ORPHAN FUND.—At the Committee meeting of this Fund, held on Friday evening, the following contributions were announced as having been received during the month of January:—Mr. Todd, from the Edinburgh Chrysanthemum Show, £15; the Scottish Horticultural Society, per Mr. M'Kenzie, £5; Ealing District Gardeners' Association concert, £15; proceeds of a skating fête at Hanger Hill House, Ealing (E. M. Nelson, Esq.), £7 13s. 1d.; from a similar fête at The Elms, Acton, sent by Mr. James, gardener to R. A. Scott, Esq., £5; Liverpool Horticultural Association (per Mr. R. P. Ker), £2 2s.; Bristol Chrysanthemum Society (Mr. Vallance), £2 2s.; Mr. M. Dunn, Dalkeith, £1 1s.; Mr. H. Herbst, £1 1s.; Mr. Macfarlan, £10; Mr. A. J. Brown (Chertsey concert), £1 16s.; Sevenoaks Gardeners' Association (Mr. C-Denning), £1 10s.; Tunbridge Gardeners' Association (Mr. Fennell), 14s. 6d.; Leeds Paxton Society (Mr. Frankland), £1 1s.; contents of money boxes (Mr. J. Hughes, Birmingham), £6 10s. 9d.; Mr. D. T. Fish, Hardwicke, 19s.; Mr. Turton, Reading, 8s. 2d.; Mr. Gibson, Morden Hall, 9s. 6d.; Mr. Lemmon, Brighton, £1 5s. 8d.; Mr. Ware, Wimbledon, 12s. 4d.; from Chiswick, 7s.—total, £77 17s., a good result from good helpers in a good cause. A letter was read from Mr. H. J. Veitch on behalf of the Williams' Memorial Committee, offering the sum of £250 for the support of two children to be nominated by Mr. H. Williams, and was unanimously accepted with thanks. Dr. Hawksley, Managing Director of the School of Handicraft, Chertsey, kindly offered, through Mr. A. J. Brown, the gardener, to consider the cases of any children with the view to their admission to the school on the recommendation of the Committee, and a vote of thanks was accorded for the kind suggestion. The School is an excellent one, the inmates being given a good education, and grounded in the rudiments of gardening and carpentry. More will probably be heard of it. Already there are eight applicants for the benefits of the Orphan Fund, some of the cases being very distressing, and the Committee bespeak the kind aid of all who can help in making provision for as many as possible by the next election.

— HOME-MADE WINES.—I am one who enjoys the articles by old and esteemed writers, such as "D., Deal," and Robert Fenn. I have had a little of his sad experience concerning things I thought good, but which high authorities did not appreciate. My wife, with my help, has made various home-made wines, and we are considered experts; but perhaps if samples were placed before judges they might be "passed." Life is most worth living, however, when we can please ourselves. Believing that Mr. and Mrs. Fenn must have more experience in the art of wine, mead, and vinegar making from honey than we have, would it be asking too much for him to repeat his methods of making these liquors? I am sure many beside myself would be grateful for the information, as it is like the "gathering up of the crumbs," nothing being lost, but a great gain secured, and more especially as home-made are in many instances superior to foreign wines, and tend to alienate people from using stronger and more pernicious liquors.—W. T., Lanarkshire.

— CARNATION FLOWERS IN AMERICA.—Mr. John Thorpe has been writing about Carnations in an American paper, and prophesied that within ten years the flowers will be 4 inches in diameter, and will realise a dollar each. Taking up the subject in the *American Florist*, he remarks:—"Somebody says they have Carnation flowers already 3 inches in diameter. That is good, very good; but Carnations are not modelled out of clay directly, or my 4-inch flower would be figured next week. To obtain a flower simply 4 inches in diameter is not a difficult task; in fact, all the Malmaison varieties are fully 4 inches in diameter when well grown, but they are not what my 4-inch Carnation ideal is. Here is my model:—First, the flower is not to be less than 4 inches in diameter; the petals must be thick and regularly disposed; the colour, any colour; it must have a decidedly sweet perfume. Second, the calyx to be not less than half the diameter of the flower; it must be sufficiently large so as not to burst during the period of the petals emerging from it. The stem must be in proportion to the size of the flower, and long enough to be cut not less than 18 inches long; the lower end of the stem not thinner than an ordinary lead pencil. The stem to be clothed with leaves as are the best varieties to-day, excepting that the lower leaves are to be 8 inches long, one-half inch wide, covered with a glaucous surface which only Carnations have. The leaves to be curved in that lovely way already possessed by the 'divine flower.' Such flowers will sell for one dollar each."

— OWING in part to the fine weather during September and October last those who grow AUTUMN-BEARING RASPBERRIES had abundant and valuable crops. But though these may have been more

bountiful than usual for the reason stated, well managed plantations rarely fail to yield an acceptable supply of fruit, and it is a little surprising that autumn-bearing Raspberries are not more generally

Veitch & Sons, and the collection attracted considerable attention. The Catawissa, for that is the name of the variety, is a true, and evidently a productive, autumn-bearing variety, fruit large, dark red,



FIG. 22.—AUTUMN RASPBERRY CATAWISSA.

cultivated. There is no lack of good varieties, and the old October Red is very serviceable. The one figured (fig. 22), however, is less widely known. It represents one of many fruiting sprays that were exhibited at the Crystal Palace October fruit Show by Messrs. James

and of fine flavour. It requires the same treatment as other autumn bearers—viz., all canes in early spring to be cut down to the ground, the young shoots then thrown up to be well thinned for bearing, to allow the fruit to receive the full benefit of light and air. The origin

of the variety is uncertain, but the name suggests it is an American Raspberry. Be that as it may, the sprays referred to proved its adaptability to British gardens, for they were heavily laden with dark red fruit.

— THE MIDLAND COUNTIES CARNATION AND PICOTEE SOCIETY.—We are informed that the schedule of prizes, close upon £60, is now in the printer's hands, and all classes of these popular flowers, including border varieties, have very liberal encouragement. The first exhibition will be in the Birmingham Botanical Gardens, and is fixed for August 8th.

— BIRMINGHAM GARDENERS' ASSOCIATION.—At the first meeting of the winter session, February 2nd, Professor Hillhouse, Professor of Botany at Mason's College, gave a lecture on "Smatterings," quoting the old proverb that "a little learning is a dangerous thing," alluded to the fact that in many cases a little learning is not dangerous when properly applied, and that in many cases old proverbs are not what they seem, and quoted Lord Brougham's saying it is best to know something about everything, and everything about some things. An unoccupied mind is like an unoccupied garden, it is soon filled with weeds. It was a most able lecture, words of wisdom and sound advice were given in rapid succession, frequently accompanied by quiet satire and humour. Messrs. Pope & Son sent a specimen plant in full flower, and growing in water, of "the Sacred Lily of China and Japan," and it looked very much like an acquaintance of a long number of years, the old Grand Primo Polyanthus Narcissus. Mr. Pope stated, however, that it is earlier than the ordinary varieties of Polyanthus Narciss. Mr. Cooper brought with him from Highbury branches of evergreens to show the severe weather at Highbury. All the Euonymus of the Evergreen section were destroyed to the ground, or nearly so. Golden Hollies, especially the Golden Queen, have suffered there, and in many other places at Birmingham. In one nursery some fine plants are greatly injured. Cotoneaster microphylla on a south wall at Highbury, and fully exposed, is almost denuded of foliage, and Aucuba japonica, Pernettya pilosa are very much browned, so also are Mahonia aquifolia, Laurustinus, &c. The maximum frost at Highbury was 24°, but a few degrees more at the lower part of the grounds about the pool; but Highbury is on elevated ground.

— AT the present time BOUVARDIAS are flowering well in a small span-roofed house in the gardens at Dove Park, Woolton. The varieties in question are the old Vreelandi, single white, and Alfred Neuner, a double white. Although the last named is perhaps the more valuable for buttonhole bouquets and sprays, the single variety is the favourite with Mr. Carling, who grows these plants uncommonly well, and considers the single flowers have a lighter appearance and better adapted for vases. The plants are grown in 6-inch and 7-inch pots in a compost mainly of loam. The profusion of flowers produced is a proof that the general treatment is correct.—E. M.

— ACCOUNTS of the LOCUST PLAGUE IN AUSTRALIA are still most dismal, excepting at Adelaide, where the locusts, as was reported just before the mails left, had been good enough to drown themselves in myriads. The seashore at Adelaide was lined with the drowned locusts. At Minyip, however, the arrival of an immense column from the north was seriously alarming the inhabitants. The atmosphere presented the appearance of a snowstorm; the roads and fences were covered to a depth of 3 inches or 4 inches with a solid mass of locusts. The gardens were quickly denuded of vegetation, and all herbage was fast disappearing before the pest. The caterpillar plague is also causing the Australian colonists serious anxiety. Failures among agriculturists are attributed to these pests, and no wonder when as much as £600 is said to be the loss of one farmer alone through the destruction of his Barley crop by the caterpillar.

A CURIOUS POTATO.

In September, 1888, I dug six fine Potatoes for exhibition. After doing duty at our local show they were kept for seed, but not being used no further notice was taken of them until September, 1889, when they appeared so fresh and sound I again exhibited them as a novelty, when they received much attention, and were thought even better than young Potatoes. When cleaning up the other day these same Potatoes came under my notice, and although now dried up they have not failed to produce another novelty. You will see the young ones nestling in the bosom of the parent. Unfortunately some have got broken off. Could you produce a drawing of this novelty, I think it

would be interesting to readers of your valuable Journal.—GEO. STEEL *Heatherslaw*.

[It is, as most gardeners know, quite a common occurrence for old Potatoes to produce young tubers without the former producing any growth above ground, and many "new" Potatoes have been so raised not for home use alone, but for market. But these are produced by one-year-old tubers, or tubers that have been about a year out of the ground,



FIG. 23.—A PROLIFEROUS POTATO.

and adhere to them, the growths of the eyes or buds through being arrested assuming the form of tubers. Mr. Steel's tubers were different. They had been out of the ground more than two years when discovered, and the "new" Potatoes were not formed by and from the external eyes or buds, but formed in a cluster in the centre of the Potato, increased in size there, and forced their way through the dried cuticle. We assume they are the produce of latent buds on the growing axis that proceeds through the tubers from base to apex, and terminates in the buds by which the growth is continued the succeeding year; but these buds having become effete the latent buds become active for perpetuating the kind. A portion of the old Potato was removed for showing the position of the young tubers. We have not seen a precisely similar case; and though it may not be novel to the whole of our readers, it will be new to the majority.]



FRUIT FORCING.

PEACHES AND NECTARINES.—*Earliest Forced House*.—Unfavourable weather since the commencement has seriously affected forcing operations. The maintenance of a low night temperature and a steady heat by day has kept the trees advancing slowly, and where extra attention has been given to fertilisation there is every reason to anticipate a good crop of fruit. In the case of late varieties being still in flower they may have the camel's-hair brush or other means of distributing the pollen passed over them, keeping the house moderately dry with a circulation of air until the flowers commence fading, when a slight syringing with tepid soft water will soon bring off the remains of

the flowers, setting the mind at rest as to the first stage, which always, especially after a period of dull and cold weather, causes anxiety to the grower. Inside borders are a great advantage in early forcing; the trees always succeed better than those having their roots in cold outside borders, and they set better in a lower temperature, making up for lost time as the days increase in length and brightness. Undue haste in early forcing often causes the loss of a crop. Proceed with disbudding cautiously, also shorten shoots that were left at full length at pruning time. Remove the foreright shoots first, commencing at the most upright part of the trees, and work down to the horizontal branches at the base. Keep a sharp look out for aphides, and fumigate upon their first appearance. Be careful, however, not to give too much, as the foliage and tender fruit are susceptible of injury. See that all surfaces near hot-water pipes are kept constantly moist, and that the roots of the trees are well supplied with tepid liquid manure in a weak state. Avoid, however, over-excitement in the early stages of swelling, which is often fatal to stoning. Admit a little air on all favourable occasions, but be careful to avoid cold currents, and close sufficiently early to raise the temperature 10° to 15° from sun heat, avoiding a close atmosphere by a little ventilation.

Succession Houses.—When the trees are approaching the flowering state syringing must be discontinued, but secure a genial condition of the atmosphere by damping the house occasionally. In other cases syringe well until the flowers commence opening, and in case of a great show of flowers remove those on the under side of the trellis. Do not omit to fumigate on a calm afternoon to destroy any aphides that may exist, and so keep the trees free from those pests until the flowering is over. If the inside border be dry, afford a thorough supply of water, or liquid manure in the case of weakness in the trees.

Later Houses.—Severe weather has one good effect, in that whilst doing no harm to ripe wood it assures complete rest in the trees, and keeps the blossoms back. Dryness at the roots must be avoided, affording thorough supplies, but where the roof lights have been removed the borders will have been well moistened by the recent rains. Ventilation will be necessary to the fullest extent, so as to keep the blossom back, and the lights should remain off until the blossoms are emerging from their scaly covering, and not then safe from frost.

CUCUMBERS.—Avoid overcrowding, keep the foliage thin, remove bad leaves and exhausted growths, stopping one or two leaves beyond the fruit; crop lightly, and secure clean growth as essential to free successional bearing; keep the night temperature at 65° to 70° , and 75° by day, with 80° to 90° with sun heat, closing early in the afternoon, with plenty of atmospheric moisture on bright sunny afternoons; this, with judicious applications of liquid manure in a tepid state, will insure good root action and free growth in the plants and fruit.

Young plants may be transferred to the hillocks or ridges in the structure prepared for their reception by thorough cleansing of the woodwork, and soil having been in a few days to warm the soil should be pressed firmly about each plant, placing a stick to each plant and securing to the lower or such wire as suits for training the plants when grown over the trellis. Shade for a few days from bright sun at planting, but not more than is absolutely necessary to prevent flagging.

STRAWBERRIES IN POTS.—The weather has been such that the plants have not been kept more than gently moving. Ventilation must be very carefully given to plants swelling their fruits, as sudden and drying currents of cold air cause the tender fruit to indurate, and it rarely swells kindly afterwards. When the air is cold and sharp some hexagon netting placed over the ventilators admits of ventilation when it otherwise could not be given. Plants in flower should have air under or above them, so that it is warmed before it comes in contact with the tender fructifying organs. Have the atmosphere rather dry for a couple of hours each day, so as to insure conditions favourable for fertilising by a little extra heat if necessary, with freer ventilation. Fertilisation is quickly effected with a feather duster, examining the flowers each day until there is a good crop set, after which remove all superfluous flowers, also surplus and deformed fruits. Water plants in flower on the mornings of fine days, lifting the leaves and flowers with one hand so as to avoid wetting them, and keeping the water from the crown, as that sometimes suffers through the frequent application of water and a close atmosphere. Afford liquid manure to plants swelling off their crops, and maintain a genial condition of the atmosphere with a temperature of 60° to 65° , with 10° to 15° rise from sun heat.

KITCHEN GARDEN.

VEGETABLE CROPS.—The spring of 1891 is likely to be one of the most deficient in vegetables ever experienced. The whole of the green crops are destroyed in many gardens, and the sooner they are cleared away the better, and the ground prepared for other crops. Possibly some owners of gardens may think their cultivators have been careless in not protecting and saving the green crops, but this was of no avail, and lack of attention is not the cause of the scarcity of green vegetables.

RAISING VEGETABLES UNDER GLASS.—Although seeds cannot for some time be sown in the open ground with advantage, as many plants as possible should be raised under glass, as in bad springs it is a great advantage to have plenty of them in a forward state under protection for planting out as the weather becomes favourable. The best receptacles for the seed are shallow wooden boxes. A quantity of rather rich loamy soil should be broken up. Do not add any sand to it. Place a layer of fresh leaves in the bottom of each box, and then fill with the soil. Make it very firm, as this prevents the plants running into too much leaf. Level the surface, sow the seed thinly on this, and cover with a

little of the soil sifted fine. A sprinkling of sand placed over all will help to prevent damping. We are about to sow the following crops in this way:—Celery for early use, Brussels Sprouts for a few early rows, Cauliflower for first crop, and a pinch of Early Paris Market Lettuce. As a beginning one box of each of these will be sown. When the plants are large enough to be handled they will be transferred to other boxes, and after gaining a good size they will be gradually hardened previous to being planted out. A few scores or hundreds of such plants will be found most useful before any of the open air sowings can be ready. Successional lots will be sown in three weeks hence.

RAISING EARLY PEAS.—The early Peas sown in autumn have failed, indeed the plants have not appeared, and should they do so after this they will be so weakly as not to be worth keeping. The first crop must be sown under glass, and it may be put in at once. We have tried raising them on turves and other ways, but find it best to sow them in 3-inch pots. A few pieces of drainage are put in the bottom of each pot. They are then filled half-way up with rich soil, about a dozen seeds are put in, and more soil is placed over them. They are then placed in a heat of 60° , and they soon germinate. The young plants must be kept near the glass and well in the light. Air should also be admitted on all favourable occasions. The back shelf of an early vinery is a very suitable place for them, and they may be kept in heat until about 6 inches high, when they should be placed in a cold frame previous. Young Pea plants do remarkably well in this way, and can be turned from the pots and planted with the balls of soil entire at a distance of 8 or 10 inches from each group. They receive less check in being raised this way than any we have tried. The new early Pea William Hurst is the best of its class we have yet tried.

PLANT HOUSES.

Cleaning the Houses.—All houses in which plants are grown must be thoroughly cleaned before the growing season commences. Clean the plants first, and if possible remove them to the adjoining house until the woodwork and glass have been washed with softsoap and warm water. All walls and brickwork not painted should be limewashed once or twice according to the condition of the walls. If very green it will be necessary to scrub them well first, and then wash them with a weak solution of chloride of lime and water. This will destroy vegetation, and if well limewashed afterwards they will remain clean for a long time. The green soon comes through if the walls are damp and very green when the lime is applied, but if the walls can be well dried after an application of chloride of lime and then thoroughly limewashed it will be found to adhere perfectly and last well. The curbs and floors if formed of stone should be cleaned with chloride of lime. The pipes and staging, if the latter is iron, should be painted with lampblack and boiled oil. The material used on the stage for holding moisture must be well washed if gravel, or removed and replaced by fresh. If ashes are used the best plan is to take it out and bring in fresh. If the stages are well cleaned, and the moisture-holding material renewed quantities of slugs are frequently removed. Slugs are frequently a source of annoyance through negligence in these matters, and can often be stamped out by a thorough cleaning. There can be no comparison between the growth of plants in houses that are clean and sweet, and those that are the reverse. After the houses are cleaned any potting needing attention should be attended to from time to time.

Storing Soils.—If the long spell of severe weather has prevented wheeling in a good supply of soils that will be needed shortly for potting, no time should be lost in getting them under cover. If wet store these soils where they will dry sufficiently to be fit for use when wanted. Many plants often fail to do well through wheeling in soil that is too wet, and using it in that condition. All soils used for potting must be in an intermediate state of moisture, and this condition can be readily detected by its silky feel when passing it through the hands. If it adheres to the fingers it is too wet; on the other hand, plants should not be potted with soil that is too dry, and thus necessitate a liberal supply of water. Soil in quantity will be needed for seeds, and may be prepared. It does not take long to sow seeds and insert cuttings if the soil is ready for use.

Pots and Crocks.—Pots should be washed and stored in their sizes, so that when potting commences there is no waiting. It is a good plan to wash the pots as they are emptied, they are done in less than half the time than is needed when placed on one side, and allowed to become dry. Frequently dirty pots are placed on one side to be washed at a more convenient season, which never arrives, and finally entails double the labour and often considerable inconvenience. If the supply of pots in hand is not equal to what may be required it is a good time to prepare them. Crocks may be washed and broken by passing them through sieves with various sized meshes.

Stakes and Labels.—A good supply of the latter can be made or bought, for they are needed in quantity in most gardens. Where labour is limited it is a mistake to attempt making them, for good labels can now be bought very cheaply. Sort and tie stakes into bundles of various sizes, as they generally become very much mixed in the course of a year. If the majority of those used are made of deal it will often be necessary to remove the end that has been in the soil. For lasting no stakes equal those made of bamboos; thick canes can be sawn into lengths and split readily; to be fit for use they only need the rough edges removing afterwards. For the sake of appearance paint all newly made stakes. It is surprising what a quantity can be done at night and morning before it is light enough to attend to watering and other work.

THE BEE-KEEPER.

APIARIAN NOTES.

SPRING DWINDLING.

MILD spring weather following that of a severe winter is the best medicine for putting bees in good health and spirits—that is, in cases where bees and queen are normally healthy. It not unfrequently happens that to appearance they are so, yet a daily dwindling of the bees takes place as the spring advances instead of getting more numerous. In most cases the fault will be found in the queen, for so long as bees' wings are entire they remain healthy, and are able to discharge their duties inside and outside the hive; but whenever a queen is in an abnormal state the bees become spiritless and disappear.

Queens are liable to become unable to perform their maternal duties through dropsy, old age, or a chill, especially when they have been located in a damp hive. In some cases the ovary collapses at an early period of the queen's life. In some of the above cases she may be able to deposit a few eggs, but in others none can be laid. An experienced bee-keeper, as a rule, forms a good opinion of the state of the hive by the movements and appearance of the bees, but the novice can only determine the facts by ocular demonstration—even then he may not be experienced enough to decide when a queen is at fault. Sometimes queens in a diseased state appear large and handsome, but as a rule eggs are either absent in the cells or are few in number and irregularly laid, and the bees at all times spiritless and in contrast to those having a healthy queen. Whenever the apiarist discovers an unhealthy queen it should be removed, and the bees joined to those of another hive.

I do not expect that the coming spring will pass away without having its usual average or greater number of swarms leaving their hive bodily through one or other of the above causes. Many queens are alive above a year old, whilst they and younger ones may not have had an immunity from disease in some form through the long continued cold. We are justified in bringing the above before bee-keepers through the correspondence that has brought to light so many cases of abdominal extension or dysentery.

I entirely disagree with those who maintain that spring dwindling is due to the death of the aged bees, because, as already stated, bees never fail until their wings give way. Sometimes queens suddenly cease to be prolific, and although not barren fail to produce as many eggs as will allow a hive to be strong and profitable. It is for the bee-keeper to exercise his judgment and become acquainted with the fertility and behaviour of queen and bees, so as to enable him to turn everything to the best account. Other causes of spring dwindling are untimely manipulations, the cooling of the hive by them or by having it in a damp and otherwise cold state, which destroys the vigour of the bees, rendering them unable to battle with the chilling winds of spring. Irregular and untimely feeding, too, also causes bees to fly out and be lost.

CARBOLIC ACID.

I observe in a bee journal that the late Rev. George Raynor is credited with being the first to use carbolic acid in the apiary. Carbolic acid was known as a quietener of bees as early as 1840, and perhaps long before. The first I observed writing on the subject was "R. S." between twenty and thirty years ago in the *Cottage Gardener*, and in 1870 he gave a graphic description how to manipulate frame hives with it. In 1869 "Apicola" gave the method of using carbolic acid by saturating a sponge with it, and placing it in the smoker. I was the first to describe the method of clearing supers of bees by its use, and it was not till after then that the late Rev. George Raynor said he had used it for fifteen or sixteen years, not forty. The above are the facts, and I think most persons prefer them to misleading statements.

FOUL BROOD.

In order to suppress this plague amongst bees do not allow it to develop itself, but whenever observed destroy the contents of the hive, and put the bees through the "purgatorial" process, by putting first into one hive and then into a second, plain boxes or straw hives to be used, then thoroughly disinfected, allowing the bees about three days' occupation in each hive, after which return to a clean permanent hive furnished with comb foundation, using sulphur fumes in a close chamber to disinfect the infected hive, then wash thoroughly with sulphate of iron and lime, equal proportions, or with carbolic acid. By stamping out foul brood in the first stage whole apiaries may be saved, resulting in the owners securing large yields of honey, instead of much trouble, loss, and disappointment. To search for foul brood is about the only justifiable manipulation the bee-keeper may perform.—A LANARKSHIRE BEE-KEEPER.

SEDUM SPECTABILE AND BEES.

I AM glad to observe that "A Lanarkshire Bee-keeper" has noticed my remarks on the above. I fancy he has discovered the real cause of the stupifying of the bees on the plant. The effect seems to be most marked where there are large beds of the plant, and in all likelihood, as your esteemed correspondent says, it is the odour which causes the stupefaction of the bees. I hope, as "A. L. B. K." suggests, to study the subject when opportunity offers, and to observe the habits of the bees in my garden, which is apparently a "happy hunting ground" for these interesting insects.—S. ARNOTT.

TRADE CATALOGUES RECEIVED.

Vilmorin-Andrieux & Cie, 4, Quai de la Mégisserie, Paris.—*General Catalogue of Seeds, Bulbs, &c.*

Charles Frazer, Palace Plain Works, Norwich.—*Illustrated Catalogue of Conservatories, Vineries, and other Glass Houses.*

B. S. Williams & Son, Victoria and Paradise Nursery, Upper Holloway.—*Catalogue of Flower, Vegetable, and Agricultural Seeds.*

Benjamin Soddy, 243, Walworth Road, S.E.—*Spring Catalogue.*

Wm. Cutbush & Son, Highgate and Barnet.—*Catalogue of Flower and Vegetable Seeds.*



•• All correspondence should be directed either to "THE EDITOR" or to "THE PUBLISHER." Letters addressed to Dr. Hogg or members of the staff often remain unopened unavoidably. We request that no one will write privately to any of our correspondents, as doing so subjects them to unjustifiable trouble and expense.

Correspondents should not mix up on the same sheet questions relating to Gardening and those on Bee subjects, and should never send more than two or three questions at once. All articles intended for insertion should be written on one side of the paper only. We cannot reply to questions through the post, and we do not undertake to return rejected communications.

To Inquirers.—We have received several letters too late for being satisfactorily answered this week.

Fumigating (J. V.).—Your letter, like another received on the same subject, is a distinct advertisement. See our reply to a correspondent on page 96 last week.

Maidenhair Fern (J. F. F.).—Now the fronds are brown cut them away so as to make room for fresh, keep the plants rather dry for a short time, but not "dust dry," and when they push fresh fronds you may repot them, reducing the balls a little, or dividing them if necessary, using good fibrous loam with a fourth of well decayed manure intermixed. When in free growth, not before, apply liquid manure, taking care to use it weak. If the loam be rich omit the manure.

Grafting Pear Tree (F. J.).—You may put a graft on each branch, cut back if there is room for training the growth, otherwise only graft those branches that are best located for affording growths from the grafts to cover the space equally at proper distance apart—namely, 12 inches. It is best to cut off the whole head and put on scions so as to form a fresh tree as soon as practicable. The Apple trees that meet may have the last year's growths joined in the manner proposed. They will unite freely if care is taken to exclude air by covering the junction with grafting wax or clay.

Sulphate of Iron for Mixing with Sewage (F).—As you will notice the iron sulphate is for mixing with sewage for immediate application, and where it is given at frequent intervals. The quantity named is quite sufficient for the purposes indicated, as in powerful supplies it is highly prejudicial. As a disinfectant it may be used at the rate of 1 lb. to a gallon of water for saturating sawdust or similar material to take away bad smells. As a surface dressing the iron sulphate should be applied carefully and evenly distributed in moist weather only, at the rate of a quarter of an ounce per square yard.

The Winter Moth (J. N).—All experiments up to this date have failed to destroy the eggs of the winter moth, except by killing trees as well, hence it is useless to apply any insecticides for that purpose now. Paris green, applied at the end of March or early in April and continuously as required, will keep the trees clean if the mixture is used as has been directed in the *Journal of Horticulture*. The strawsoniser is answering well in some parts of Australia in destroying locusts; where this cannot be used a new engine by Boulton & Paul, with one of Stott's sprayers, will prove extremely useful. In this apparatus it is impossible for the Paris green to settle, but is kept in constant suspension by an ingenious internal contrivance. The slacked lime and soot you suggest are utterly useless for application to destroy the eggs. The winter moth is very much to the fore now in some parts, and it is an open question when the insects cease depositing eggs. The mixture you mention as having been recommended on page 127, of our issue of May 22nd, 1890, answered well applied in spring for destroying the young caterpillars before they do any material damage—not the eggs.

Mixing Steamed Bone-flour with Stable Drainings (F. S.)—The phosphate of lime in steamed bones is more soluble than in raw bones. Genuine steamed bones should contain 60 per cent. of phosphate of lime, and nitrogen equal to 2 per cent. of ammonia. Steamed bone-meal or flour decomposes within twelve months of its application to the soil. The steamed bone-meal, therefore, is not slow in action; but it is made quicker by dissolving, in which form it is a poorer manure than genuine dissolved bones. By saturating bone-meal with stable drainings fermentation renders the insoluble constituents soluble, thereby becoming available plant foods, hence are more valuable for quick returns. You may use the steamed bone-flour as you propose—viz., saturating it with stable drainings, but instead of adding soil to make a thick paste use dry wood ashes in about the same proportion as the steamed bone-flour. Dried, as it soon would be under cover, it would be available for use as guano. If you resolve on using soil let it be clay dried and reduced to powder; but you will not get the same amount of ammonia in steamed bone-flour by that process as by fermenting raw bones mixed with clay, and watering the mixture with stable drainings. Bones fermented in that way contain 49 per cent. of phosphates, and the organic matter contains 4.2 per cent. of ammonia. Your second letter would have been willingly answered this week if it had been sent sooner.

Camellia Buds Falling (W. J. B.).—The misfortune is usually the result of defective root action, which may be induced by a variety of circumstances, the most common cases occurring in plants that are placed outdoors after the buds are set. The pots from exposure to sun or drying atmospheric influences become heated or much dried, and the roots near the sides perish. Sometimes the soil becomes dry, and the plants suffer more outdoors on account of the greater evaporation from them than under glass. This causes a check, resulting in the buds being cast at a later period. A frequent cause of the buds falling is a saturated condition of the soil effected by rain during cold wet periods. Also placing outdoors causes the buds to be more or less indurated, so much so that their sap vessels become contracted, and the sap is diverted from the bloom to the wood buds, growth extending and buds falling in consequence. The sudden change, too, that the plants experience when placed under glass in the autumn, especially in a dry house, often causes the buds to fall, and to prevent this many gardeners syringe the plants, and keep the atmosphere somewhat moist for a time after housing. Noxious fumes are very injurious to plants, but they usually first affect the tender foliage, and it is likely if they had damaged your Camellias they would have cast their leaves as well as the buds. Camellias are amongst the best of plants for enduring "fumes and smoke," therefore we do not think they have caused the buds of your plants to fall as suggested.

Names of Fruits.—The names and addresses of senders of fruit to be named must in all cases be enclosed with the specimens, whether letters referring to the fruit are sent by post or not. The names are not necessarily required for publication, initials sufficing for that. Only six specimens can be named at once, and any beyond that number cannot be preserved. (J. E.).—Mère de Ménage. (G. T.).—1, Beurré d'Aremberg; 2, Bâster Beurré; 3, Winter Nelis. (J. F. O.).—1, Old Nonpareil; 2, Bess Pool; 3, Alfriston; 4, Dumelow's Seedling; 5, Northern Greening; 6, Court of Wick. (A. S. E.).—The Grape is not Alnwick Seedling, but Alicante.

Names of Plants.—We only undertake to name species of plants, not varieties that have originated from seed and termed florists' flowers. Flowering specimens are necessary of flowering plants, and Fern fronds should bear spores. Specimens should arrive in a fresh state in firm boxes. Slightly damp moss, soft green grass or leaves form the best packing, dry wool the worst. Not more than six specimens can be named at once, and the numbers should be visible without untying the ligatures, it being often difficult to separate them when the paper is damp. (J. J.).—Yes, they are all Bromeliaceous plants related to the Pine

Apple. 1 is Tillandsia Lindeni; 2, Tillandsia usneoides; 3, Tillandsia zebrina; and 4, Pitcairnia fulgens. (W. B.).—The Winter Aconite. Eranthis hyemalis. (S. M. R.).—1, Pilea muscosa; 2, Tradescantia zebrina; 3, Selaginella apus.

COVENT GARDEN MARKET.—FEBRUARY 4TH.

MARKET very quiet, with short supplies, particularly of vegetables. Grapes in good supply.

VEGETABLES.

	s.	d.	s.	d.		s.	d.	s.	d.
Artichokes, dozen	0	0	0	0	Mushrooms, punnet	1	6	2	0
Beans, Kidney, per lb.	0	9	1	0	Mustard & Cress, punnet	0	2	0	0
Beet, Red, dozen	1	0	0	0	Onions, bushel	3	0	4	0
Brussels Sprouts, ½ sieve	2	6	3	0	Parsley, dozen bunches	2	0	3	0
Cabbage, dozen	1	6	0	0	Parsnips, dozen	1	0	0	0
Carrots, bunch	0	4	0	0	Potatoes, per cwt.	3	0	4	0
Cauliflowers, dozen	2	0	4	0	Rhubarb, bundle	0	2	0	3
Celery, bundle	1	0	1	3	Salsafy, bundle	1	0	1	6
Coleworts, doz. bunches	2	0	4	0	Scorzenera, bundle	1	6	0	0
Cucumbers, doz.	4	0	8	0	Seakale, per bkt.	2	0	2	6
Endive, dozen	1	0	0	0	Shallots, per lb.	0	3	0	0
Herbs, bunch	0	2	0	0	Spinach, bushel	5	0	6	0
Leeks, bunch	0	2	0	0	Tomatoes, per lb.	0	4	0	8
Lettuce, dozen	2	0	2	6	Turnips, bunch	0	0	0	4

FRUIT.

	s.	d.	s.	d.		s.	d.	s.	d.
Apples, ½ sieve	1	6	to	6	Lemons, case	15	0	to	20
" Nova Scotia and					Melons, each	0	0	0	0
" Canada, per barrel	15	0	26	0	Oranges, per 100	4	0	9	0
Grapes, per lb.	0	9	3	0	St. Michael Pines, each	2	0	6	0
Kentish Cobs	45	0	50	0	Strawberries, per lb.	0	0	0	3

AVERAGE WHOLESALE PRICES.

CUT FLOWERS.

	s.	d.	s.	d.		s.	d.	s.	d.
Arm Lilies, 12 blooms	2	0	to	4	Marguerites, 12 bunches	2	0	6	0
Azalea doz. sprays	0	9	1	0	Mignonette, 12 bunches	3	0	6	0
Bonvardias, bunch	1	0	1	6	Mimosa (French), per bunch	1	9	to	2
Camellia, white, per doz.	2	0	4	0	Narciss (Paper-white), French, doz. bunches	9	0	5	0
" red	1	0	1	6	Do. Do. English, per bunch	1	0	1	6
Carnations, 12 blooms	1	0	2	6	Pelargoniums, 12 trusses	1	0	1	6
Christmas Roses, dozen blooms	0	9	2	0	" scarlet, 12 bunches	9	0	13	0
Chrysanthemum, 12 behs.	3	0	6	0	Poinsettia, dozen blooms	3	0	6	0
Daffodils, doz. blooms	1	0	2	0	Primula (double) 12 sprays	0	6	1	0
Epiphyllum, doz. blooms	0	4	0	6	Roses (indoor), dozen	0	6	1	0
Eucharis, dozen	3	0	6	0	" Red, 12 ble. (Fench.)	2	0	4	0
Gardenias, each	3	0	5	0	" Tea, white, dozen	1	0	3	0
Hyacinths (Roman), doz. sprays	0	6	1	6	" Yellow, dozen	2	6	15	0
Lapageria, 12 blooms	2	0	4	0	Tuberose, 12 blooms	2	6	4	0
Lilac (French) per bunch	4	0	6	0	Tulips, per dozen	1	0	2	0
Lilium longiflorum, 12 blooms	6	0	9	0	Violets (Parme), per beh.	4	0	6	0
Lily of the Valley, dozen sprays	0	9	1	6	" (dark), per beh.	2	0	3	0
Maidenhair Fern, dozen bunches	4	0	9	0	" (English), doz. bunch	1	0	2	0
					Wallflower, doz. bunches	3	0	6	0

PLANTS IN POTS.

	s.	d.	s.	d.		s.	d.	s.	d.
Aralia Sieboldi, dozen	6	0	to	12	Lilium lancifolium, doz.	0	0	to	0
Arbor Vitæ (golden) doz.	6	0	8	0	" longiflorum, doz.	0	0	0	0
Azalea, per plant	2	0	3	6	Lily of the Valley, per pot	1	0	2	0
Cineraria, per doz.	9	0	13	0	Lobelia, per doz.	0	0	0	3
Climbing Plants, various, dozen pots	0	0	0	0	Marguerite Daisy, dozen	6	0	12	0
Dracæna terminalis, doz.	24	0	42	0	Mignonette, per dozen	4	0	6	0
" viridis, dozen	12	0	24	0	Musk, per dozen	0	0	0	0
Epiphyllum, per dozen	0	0	0	0	Myrtles, dozen	6	0	12	0
Erica, various, dozen	12	0	18	0	Nasturtiums, dozen pots	0	0	0	0
Euonymus, var., dozen	6	0	18	0	Palms, in var., each	2	6	21	0
Evergreens, in var., dozen	6	0	24	0	Pelargoniums, per doz.	0	0	0	0
Ferns, in variety, dozen	4	0	18	0	Poinsettia, per doz.	9	0	15	0
Ficus elastica, each	1	6	7	0	Rhodanthe, per dozen	0	0	0	0
Foliage plants, var., each	2	0	10	0	Stocks, per doz.	0	0	0	0
Genista, per doz.	9	0	18	0	Tropæolums, various, per dozen	0	0	0	0
Geraniums Scarlet, p. doz.	0	0	0	0	Tulips, dozen pots	6	0	9	0
Hyacinths, doz. pots	8	0	10	0					



LIQUID MANURE.

THE general principles which should influence the use of manures are broadly the maintenance of fertility in the soil in such a manner that each crop shall be fully nourished from seed germination to full development. We strive especially to restore to the soil mineral constituents withdrawn from it by recent crops, and also to store it with the nitrogenous food that is so essential an element in free robust growth. But it is rather a moot point when to apply nitrogen because of its liability to be lost in the waters of drainage if used long before there is active root growth in the soil. It is for this reason that nitrate of soda is so frequently recommended for a surface dressing, and such advice is sound if due heed

is also given to the use of this deservedly popular manure in wet weather. It is precisely this necessity for wet weather to dissolve and wash in the manure that renders surface dressing so speculative.

In a general way farmers cling to the muck heap because it contains all the elements of plant food, or rather all the elements of fertility required by the soil, and also because it may be used with such perfect safety that a man cannot well go wrong with it, and provided he uses enough, results are generally satisfactory; but its action is often provokingly slow, and the cost of its manufacture is often heavy. It is for farmers near London and other large towns that it proves most profitable, as they can obtain it at such a cheap rate and in practically unlimited quantities. But it is also precisely for land so favourably situated that liquid manure in the guise of sewage should have preference, yet what is done with it generally? Take for example the sewage of most towns. In any scheme for its disposal the acquisition of a considerable tract of land by the corporation or local board forms a most serious item, as also does the construction of a main sewer through or past miles of farm lands by the owners or tenants, of which its value as a fertiliser is absolutely ignored. Having regard to the outlay involved in the purchase of land for the disposal of the sewage, and that it is so frequently discharged into any accessible stream or river, can we doubt that town authorities would willingly agree to arrangements for its divergence to farm land at any suitable point?

Surely there can be no insuperable difficulty in the way of a cheap arrangement whereby each farm on the line of a main sewer might obtain its supply at will, so that the sewage might be turned upon any field as it was required, and the flow of sewage either stopped altogether or turned into another channel for other portions of the farm, when a field had received enough. Take, for example, pasture and meadow land in this month of February. Much experience has shown that this is the best month of all the twelve comprised in the year's span of time for applying manure to it. Supply the soil containing the crowd of hungry roots with a rich store of manure, plant food, fertility (any name you like to call it by) during the present month, and you render a full crop of nutritious herbage a certainty. Would any sane man, having the option of an unlimited supply of sewage for the purpose, ever squander his means upon the purchase of chemical manures, or the purchase of store cattle to consume his crops for the manufacture of muck heaps? Surely not, and yet what is the case? No general effort is made to obtain or apply sewage in the manner we suggest, yet in the few instances where it has been done results show how surely crops of marvellous abundance may be had.

Well says Victor Hugo in "Les Misérables:" "There is no guano comparable in fertility to the detritus of a capital. A great city is the most powerful of stercoraries. To employ the city to enrich the plain would be a sure success. If our gold is filth, on the other hand our filth is gold. We fit out convoys of ships at great expense to gather up at the South Pole the droppings of petrels and penguins, and the incalculable element of wealth which we have under our own hand we send to sea. All the human and animal manure which the world loses, restored to the land instead of being thrown into the water, would suffice to nourish the world." Hear him yet further, for assuredly his language is plain and forcible enough.

"These heaps of garbage at the corners of stone blocks, these horrid scavengers' carts, these fetid streams of subterranean slime which the pavement hides from you—do you know what all this is? It is the flowering meadow, it is the green grass; it is cattle, it is the satisfied low of huge oxen at evening; it is perfumed hay, it is golden corn, it is bread on your table, it is warm blood in your veins; it is health, it is joy, it is life. Thus wills that mysterious creation which is transformation on earth and transfiguration in heaven.

"Put that into the great crucible; your abundance shall spring from it. The nutrition of the plains makes the nourishment of man. You have the power to throw away this wealth, and to think me ridiculous into the bargain. That will cap the climax of your ignorance."

Hard hitting this, but the views of the great French author on this important subject are as sound as his satire is just. The waste of sewage in this country and others is a shame; it is a disgraceful example of reckless extravagance, which nothing can justify. Every possible sanitary requirement can be met, due attention can be given to the requirements of the most fastidious imagination, without further persistence in the suicidal practice of river contamination, with such a fertiliser.

Why is it that cattle are so often grazed at a loss, that the margin of profit on dairy farming is so narrow, that the profits derived from farm produce are so low? Is it not all owing to the cost of food, to a low average of crop yield? Well, in the sewage that we waste lies the palliation for very much of this, and in our next paper we intend giving proof of it.

WORK ON THE HOME FARM.

The land is very soft upon the surface now the thaw has come, and we counsel patience and caution about ploughing and corn sowing arrears. We shall first put the ploughs upon some old leys of mixed seeds left over for a winter bite for store sheep, and upon which folding went on all through the frost. All the folded part is now fairly rich in fertility, and it will be ploughed and sown with Black Tartarian Oats. We intend trying to obtain an exceptionally heavy crop of corn on this land, and shall not only use the heaviest sample of seed possible, but shall also drill a moderate quantity, about 2 cwt., of chemical manure with the seed. We do this because the leys are old, and the soil was so low in fertility before the sheep folding that we question if the folding has done enough. Our use of chemicals is the best answer to our query, as it makes all sure. If the scheme of sewage use given in our farm article this week could have been applied to the leys, we should have been independent of sheep folds and chemicals, and quite certain of a full crop of Oats. Most of the Barley will be sown upon land ploughed in autumn and left in ridges all winter, as we like to cultivate this fickle though profitable crop under the most favourable conditions, one of which is timely sowing, which cannot be done with any degree of certainty in soil left unploughed till the time of sowing draws nigh.

Manures for grass land intended for hay or silage should now be procured separately from a reliable source and mixed at the home farm. The quantity required per acre is quarter hundredweight muriate of potash, 1 cwt. nitrate of soda, 1½ cwt. superphosphate, quarter hundredweight steamed bone flour. This should be used before the end of the month, as then all risk of a want of rain to dissolve and wash it into the soil will be avoided. Where a considerable quantity is used so that advantage can be taken of ton rates, the cost should not amount to more than £1 per acre for the manure on rail. Very strongly do we advise an annual dressing of such manure to all grass land for which sheep folding or sewage cannot be had, for the advantage of sustained fertility cannot be overrated, and an ample profit upon the outlay involved is certain. If used upon pasture withdraw all stock from it till it is growing freely, and growth comes quickly and strong so soon after the manure is used that an early bite for the dairy cows is a certainty.

METEOROLOGICAL OBSERVATIONS.

CAMDEN SQUARE, LONDON.

Lat. 51° 32' 40" N.; Long. 0° 8' 0" W.; Altitude, 111 feet.

DATE.	9 A.M.					IN THE DAY.				Rain	
	1891.	Barometer at 32° and Sea Level.	Hygrometer.		Direction of Wind.	Temp. of soil at 1 foot.	Shade Temperature.		Radiation Temperature.		
			Dry.	Wet.			Max.	Min.	In sun.		On grass
January.		Inches.	deg.	deg.		deg.	deg.	deg.	deg.	In.	
Sunday	25	30.043	36.9	85.4	N.W.	32.9	45.7	84.6	64.3	29.1	
Monday	26	30.097	42.2	39.9	S.	33.1	48.1	36.3	72.4	31.7	
Tuesday	27	29.858	41.1	41.6	S.W.	33.8	47.7	40.3	57.8	34.3	
Wednesday	28	30.029	46.2	44.9	S.	35.8	50.1	43.6	56.1	40.6	
Thursday	29	29.919	46.6	46.3	S.	33.0	45.7	45.7	49.6	43.6	
Friday	30	30.031	41.9	41.1	S.W.	39.3	50.9	34.4	76.0	32.6	
Saturday	31	30.019	45.1	45.0	S.	39.2	53.0	42.2	73.2	35.2	
		30.011	43.4	42.0		33.0	49.2	40.2	65.5	35.3	

REMARKS.

25th.—Bright sunshine all day; clear night.
 26th.—Overcast early; fine and bright from 11.30 A.M., slight drizzle at night.
 27th.—Dull and damp throughout.
 28th.—Dull and mild morning; some sunshine in afternoon; rain in evening and night.
 29th.—Mild drizzly morning; wet afternoon and night.
 30th.—Dull early; bright sunshine from 10 A.M.
 31st.—Heavy rain early; generally bright after 10 A.M., but spots of rain about 3 P.M., and rain at night.
 A mild week, with a good deal of rain in the second half, but much bright sunshine. Temperature above the average, after being below it since the week ending November 22nd.—G. J. SYMONS.



SPRING PLANTING.

JUST when the planting of fruit and other trees was being carried out in earnest in November the frost came and sealed the ground completely. No doubt a good deal of planting was done in the little time in which it could be carried out, but the season was unusually short. The ground was so dry in many districts in the autumn that before the rain came trees could not be taken up with the abundance of good roots which both nurserymen and their clients like to see; therefore the former waited, even if the latter became impatient, till the trees could be despatched in a creditable state, and planted under favourable conditions. That was undoubtedly the right course to adopt under the circumstances, though the result of it was probably the shortest autumn planting season ever known, for it amounted to a mere snatching of about three weeks between the drought and the frost.

The extent and severity of the winter is fresh in the memories of most persons, but the character of the autumn drought is not so well appreciated. During the whole of the month of September and three weeks in October less than $1\frac{1}{4}$ inch of rain fell, as measured by Mr. Symons and recorded in his meteorological observations in the weekly issues of the *Journal of Horticulture*. This is very remarkable if not unprecedented, and may be taken as fairly representative of the autumn drought in the south of England. It had also the greater effect on the soil as following a dry August, the rainfall of which was only a little over $1\frac{1}{4}$ inch. Towards the end of October half an inch of rain fell, and a little more than three-quarters of an inch during the first week in November; it was therefore not until November was well advanced that trees could be either taken up or planted satisfactorily, and before the end of the month the earth was hard as adamant, remaining in an unworkable condition for about nine weeks. Granting that the soil and weather were more favourable for autumn planting in the north than the south an enormous amount of work remains to be done, and not a few persons are hesitating whether to carry out their intentions of planting fruit trees this season or wait till next November. After either working or closely observing the work of others in fruit tree planting and management over a period of forty years I am distinctly of opinion that it will not be wise to wait.

Whether fruit trees or bushes are planted to a limited extent for home use or on an extensive scale for commercial purposes the desire is the same—namely, to see them in good bearing condition as soon as possible. How time is to be gained by losing a season's growth, even if that is not luxuriant, I entirely fail to see. A spring planted tree that makes only moderate growth in summer is at least well established by the autumn, and must take a distinct lead the following year over one that is planted nine or ten months later, and which has to recover from the check consequent on its removal. But it by no means follows that spring planted trees make only moderate growth the first season. If carefully packed and properly managed they may be as good in the autumn following as if they had been planted in winter, and the chances are they will be better. I have said "winter," because more than half the so called autumn planting is done in the winter. When a tree is taken up the moment its leaves can be shaken off and planted immediately while the ground is still warm, and also moist, it will, in good hands, grow almost as well the following summer as if it

had not been removed; but this cannot be said of trees, no matter how good they may be, that are obtained from nurseries in the ordinary course of trade. If obtained early, packed well and planted well under favourable soil conditions, they will grow well. But from various causes they have to be waited for. The weather may retard the lifting, or, as often happens, the orders may be sent in late, and at least some persons who are almost the last to give orders expect to be the first to be served. There are, perhaps, no more obliging persons in the world than British nurserymen, but there is a limit to their power, and they cannot execute late orders for fruit trees early in the planting season, and when the trees arrive at their destination the earth is no longer warm, and though it may be autumn in the almanacks it is winter to the trees.

Many thousands of fruit trees were planted last November, and the work continued to the last moment that the ground could be moved. It was soon frozen right below their roots, remaining so for weeks; and it is very certain that these trees could derive no advantage from the "autumn" planting. There could not be even a commencement of the healing process of the pruned roots during that time; and where the work was interrupted, half of the trees more or less being left over, these trees, if the roots were well "laid in," will grow at least as well planted after the frost as those that were planted immediately before it, if the most favourable opportunity is waited for, with the ground in the best of order. The recent winter has been exceptional, the movement of the sap in trees transplanted or not has been held in abeyance, and because of this fruit trees are in much better condition for lifting and planting now than is usual at this season of the year; and they will grow as well planted in March as in February, and possibly better, that depending on the soil and the weather. A most important practical point, however, to remember in connection with the subject is this—having the trees as soon as they can be procured, laying them in carefully, so that when favourable weather comes it can be promptly turned to account in planting. Any particular date from the present time till the end of March is of infinitely less importance than the friability of the soil for ensuring the best results.

There is an old saw to the effect that if you plant trees in the autumn you have only to "order" them to grow, but if you plant them in spring you must "ask" them to grow. It is not without significance, and the lesson it conveys is sound when strictly followed. The term autumn means when the ground is still warm and moist—not any time before Christmas when it is cold and wet. The above oracular utterance has probably led to a great deal of rough and hurried planting in November regardless of the weather, and trees have failed to give satisfaction in consequence, while it has deterred many persons from having the work done in spring, no matter how favourable the weather, yet I have no hesitation in expressing my conviction that trees in the right condition and properly planted during the ensuing spring will grow better than those that were roughly stuck in towards the end of November.

A few years ago a friend of mine obtained a number of very good trees from a very good nurseryman. They reached their destination at the end of November. The weather was just what it should not be for planting, frost, snow, and rain alternating, yet I caught him rushing them into the puddle as if working for a wager. He was working against time, as he said they "must be in before December." I advised him to stop the work at once, and let the others remain in the bundles in the barn, taking care the packing round the roots was kept damp, and this covered with dry straw to prevent freezing till the ground was dry and open. It so happened that severe frost set in at once and continued for six weeks. During that time I had at least six letters of concern from him, and to each he received a postcard reply to "put on more straw." It seems a farmer's notion of using straw was different from mine, for at last he replied, "I can't, unless I put

it outside, for the burn's full." He had taken it in by the cart-load. At last the frost departed, and he was told to dig a trench, lay the roots of the trees in it, work some free soil well amongst them, cover them 6 inches deep, and let them remain there till the ground was dry enough for harrowing and rolling before planting, even if they remained for a month. They remained laid in more than a month, for they were not planted till March, and then mulched. Every tree grew well, but some of those forced in in November died, and the others had a struggle for existence. The spring planted trees took a distinct lead and kept it, and have given complete satisfaction.

Success in spring planting depends chiefly on four things—(1) constant root moisture, (2) friable soil, (3) mulching, (4) rather close pruning. Most nurserymen who have reputations to lose take special care to surround the roots thickly with wet packing in spring, and it is very necessary they should, and also to do all they can to prevent the roots drying before packing. If the roots of young fruit trees are kept distinctly moist every moment they are out of the ground they grow well when carefully planted, even when the buds are bursting through the scaly covering, and better than when the roots are placed in something like a quagmire in mid-winter. The moving sap incites fresh root action at once, just as in the case of leafless Fuchsias which gardeners shake out and repot after starting. They do not do this when the plants are dormant in midwinter, but let them "break" first, because they then grow better. Obviously fruit trees cannot be safely packed in that state, and should, as above stated, be had sooner ready for planting when they can be planted well. During fine weather in March the pulverised soil on the surface of the ground is much warmer than that below, and some of the former placed in contact with the roots is helpful. Warmth is the motive power of growth, and every degree tells in spring. Mulching is good for trees whenever they are planted, and particularly in spring for preventing the soil shrinking and fissures forming in it. The weather, however, will suggest whether it should be done at once or in a few weeks. We want earth warmth, but no fissures. Avoid these, and April or May, according to circumstances, is a good time for mulching for the retention of moisture. Shortening the branches I deem essential for three reasons:—(1) Because the roots have been shortened and cannot support growths from a hundred or more buds the whole length of the long shoots, but they soon become powerful enough to sustain good growths from three or four at the base of each. (2) Because the greater the area of bark exposure the greater the evaporation when the roots are inadequate to maintain the supply for that purpose, with a surplus for promoting growth. (3) Because I have found the plan answer, and practice proves those theories sound. If I say I prefer shortening the branches of recently planted trees after the sap commences moving I shall perhaps bring a few hornets about my ears; but I do, so they can pepper away.—J. WRIGHT.

SCARCITY OF VEGETABLES—FORCING CAULIFLOWERS.

FOR several years past we have sighed in vain for a "good old-fashioned winter," but now we have had our wishes gratified in this respect it will be many years before we want a similar experience. As far as trees, shrubs, and hardy flowers and bulbs are concerned it is yet too early to determine what our losses are, but there is no doubt at all about what has happened in the vegetable garden. With us Broccoli is completely destroyed, while Borecole, Savoys, Cabbage, and Brussels Sprouts are all badly crippled, and in many instances are rotting fast. Anything in the shape of Lettuce, Endive, Parsley, and Cauliflower plants not heavily protected are also destroyed, and we shall have to make a fresh start with several other things. This being a general complaint, hints, in addition to those already given on page 59, upon how best to meet the difficulty may be acceptable to some readers.

In some instances the latest Broccoli has escaped, and in all such cases there will be little or no need to take any extra steps to forward Cauliflowers, but as a rule the latter will be wanted earlier

and in greater quantities than usual. Luckily we have excellent forcing varieties of the Extra Early Erfurt, such as Veitch's Extra Early Forcing, Carter's Defiance, Sutton's First Crop, and Dean's Snowball. Having tried them all, I should be sorry to give priority to either of them. We have a pan of seedlings at this date (January 28th) on a warm greenhouse shelf, and which will soon be ready to prick off, but if seed is sown at once thinly in a pan or box, placed in heat, and the seedlings before they become drawn be transferred to a warm greenhouse shelf, they would quickly become sufficiently strong enough to pot off, and from these good hearts could be cut late in May. We prefer to place the seedlings singly in 3-inch, or rather larger pots, to pricking them out into boxes or pans, as they transplant badly from the latter. At the same time they must not be kept long in small pots, as, should they become badly root-bound, "buttoning" or premature hearting would most probably result. Swinging shelves in greenhouses where a little heat is kept in the hot-water pipes are the best places for preparing the plants, and if given fairly rich soil, and are kept properly supplied with water, they soon become strong enough either for shifting into 10-inch pots or planting in pits or frames of some kind. Pot plants set in a light position, and given the benefit of a little heat, and after they are well established abundance of liquid manure, will form excellent hearts. To succeed these more may be grown in a slightly heated pit, and failing this in deep frames or rough pits.

As a rule vegetables grown in pits and frames have far too little rich soil to root into, partial failures being the result. This difficulty can, however, be easily obviated by forming a very mild hotbed composed, say, of a mixture of old with nearly fresh stable manure and leaves. This being made rather firm will generate a gentle heat and yet not become too dry for the Cauliflowers to root into. Sufficient heating material should be placed in a pit to bring the 6 inches or rather more good loamy soil up to within 9 inches of the glass. These beds ought to be got ready while the plants are being prepared, so as to the soil well warmed through in readiness for the planting. If prepared well in advance of the plants a crop of either Radishes or Lettuces might also be taken from them. The new short topped Turnip-rooted forcing varieties of Radish are the quickest to bulb and form but little top. French Breakfast is also very quick and of excellent quality, while the old favourite, Wood's Frame, is still one of the most profitable forcing Radishes. Sow the seed broadcast and thinly on moist soil, covering lightly, and plant the Cauliflowers among the Radishes 15 inches apart each way. Most of the Radishes will be drawn long before the Cauliflowers require all the space.

If the preference is given to the Early Paris Market Cabbage Lettuce, Sutton's Dwarf Brown Forcing being the next best, and the plants given a slight start in advance of the Cauliflowers, which they will really have if the seeds are sown at the same time, these would heart in before the latter unduly shaded them. Prick the Lettuces out when quite small 4 inches apart in rows 15 inches asunder, and more also might be put out between the intended sites of the Cauliflowers. Every other Lettuce to be cut when they commence to press against each other as required, and these mixed with blanched Chicory will make a good salad, while the remainder will form close and remarkably tender hearts.

The Cauliflowers when placed out at the distances apart already given should be firmly fixed in the soil and never suffer by want of water afterwards, liquid manure being given directly the hearts commence forming. Hard forcing must not be resorted to, but if ventilated freely on warm days, and given much less air in colder weather, the light being closed early and covered with mats whenever the nights are cold, progress will be satisfactory enough. A good succession can be had with the aid of frames glazed or only covered with mats, beds being formed for these much as advised for the earliest batches. Supposing the stock of autumn-raised plants is lost or too few in extent, more seed of the forcing variety, and either Dwarf Erfurt, Mammoth, Early London, Mont Blanc, or Magnum Bonum should be sown by the middle of February, and the plants thus obtained be prepared for planting either under handlights at the foot of sunny walls, or on warm borders where light protection in the shape of benders and mats can be afforded for a time. Exhibitors who have lost their stock of Veitch's Autumn Giant, and upon which they rightly depend for extra fine hearts in August, ought to sow a pinch of seed in gentle heat at once, a trial being given to Carter's Extra Early selection of the Autumn Giant. We grew this for the first time last season, and were able to cut good hearts from spring raised plants early in August, and about nine days in advance of the old form. Dickson's Eclipse is also earlier than Autumn Giant, but in other respects not quite equal to it. Strong plants turned out of 4-inch pots in April or early in May, and planted on rich well-prepared open ground lightly sheltered and otherwise well attended to, will well repay for the trouble taken with them.—W. IGGULDEN.



JOTTINGS.

SINCE I wrote the paragraph referring to the Orchid Show at the Hague next May Sir J. Quarles Van Ufford has sent me a copy of his catalogue of Orchids, together with a supplement, bringing it up to 1889. This extremely useful work comprises a list of the Orchids cultivated in European collections, and as there are ninety-eight pages in the first issue and twenty in the supplement, there are probably not less than 4000 species, varieties, and hybrids enumerated. The native country is given with each; the most useful for general cultivation are marked by an asterisk, the figures 1, 2, and 3 respectively indicating warm, intermediate, and cool house as the best adapted for the particular sorts so marked. The catalogue is in two sections, and in the first the printed matter is confined to one-half lengthways of the page, thus leaving space for manuscript additions. The second part is also very useful, as all the principal synonyms are there arranged alphabetically opposite the names now accepted. The catalogue is published by the Dutch Orchid Club, and must be regarded as a useful contribution to Orchid literature for purposes of reference.

Last week Mr. A. Young wrote in favour of leaves for Orchid houses, an important matter, and one to which I called attention some years ago, as I have seen many examples of the assistance that addition has rendered to Orchid cultivators. The benefit is unquestioned, the only defect being the number of insects and other pests large quantities of leaves are apt to introduce into houses. Isolating the stage supports by bowls or saucers of water, as used to be done at Downside and elsewhere, counteracts the evil to a great extent, but watchful care is needed at all times. It may, however, interest Mr. Young and other readers, especially those near the coast, to know that seaweed is now being largely employed, with leaves and alone, for the same purpose—namely, to supply a genial heat and constant wholesome moisture in the air. At first I was rather doubtful as to the results of so bold an experiment, but in this case, as in the use of sea sand for propagating purposes, it is evident the danger is only imaginary. For some months now seaweed has been employed beneath the stages in a large Orchid growing establishment, not only without any evil results but with manifest advantage, as shown by the fine healthy colour of the foliage, the vigorous spikes of flowers, and their rich colours.

Everyone knows that Orchids depend greatly upon atmospheric support, and those who wish to render them manurial assistance in the best and safest way may do so through that medium. It is not therefore surprising that the exhalations from seaweed should produce an effect, the only thing is some would suppose the result would be injurious; yet how frequently we find plants grown under glass with complete success close to the sea, where every breeze must come laden with saline moisture; and I have seen Orchid houses so much exposed on the west coast of England that the salt could be tasted if a moistened finger was passed over a *Cattleya* leaf. Thus it does not seem that there is anything to fear from the use of seaweed, at the same time all should experiment cautiously. The advantages of using this material are—first, it can be obtained in many places much more readily and cheaply than leaves; second, it is not a storehouse of injurious insects, but possesses properties opposed to their increase; third, combined with leaves it maintains a steady and lasting heat. The chief defects are that it is not very conveniently transferred from place to place, and as decomposition advances it is liable to become offensive.

Writing about the absorbent powers of Orchid foliage recalls some of the disastrous effects of the fogs this winter which have occurred in smoky cities like London. I have never heard of these injuries being so general and severe as in the present season, and for a long distance round the metropolis in some directions the results are similar. *Dendrobiums* and *Cypripediums* have suffered both in flowers and leaves; the few *Cattleyas* expanded have had a trying time, and some pessimistic prophets do not hesitate to say that as the varieties of the *C. Trianae* section are so late the flowers are probably injured in the sheaths and will never expand, or if they do will come deformed. This, no doubt, is an exaggerated view; but it is not unlikely that some damage has been done in

the way suggested. Every cultivator will regard Dr. Oliver as a public benefactor if, in the course of his investigations respecting fog effects upon plants, he can discover some means of preventing, or at least of alleviating, the troubles they have to bear in this respect.

The amount of carbonaceous and other particles deposited upon glass houses is a good indication of what the London atmosphere contains, and in many places it is only possible to procure a due admission of light to the plants by frequently washing the glass roofs. At one establishment last week two tanks, constructed to collect the rain from a house completed a few years since, were cleared out, and no less than *ten barrowloads* of sooty matter were removed, all of which must have been conveyed into the tanks from the glass. One scientific gentleman has been engaged in computing the amount of soot deposited from London air, and arrived at the following conclusions. He collected the smoke deposited on a patch of snow in Canonbury one square link about 8 inches in extent, and obtained from it 2 grains of soot. As London covers 110 square miles, this would give us for the whole area 1000 tons. As the quantity measured fell in ten days, a month's allowance would need 1000 horses to cart it off, and these stretched in line would extend four miles. Hence London's black fogs.

"Can you give me a description of *Oncidium superbiens*?" writes a correspondent, and to help him to form an idea of the

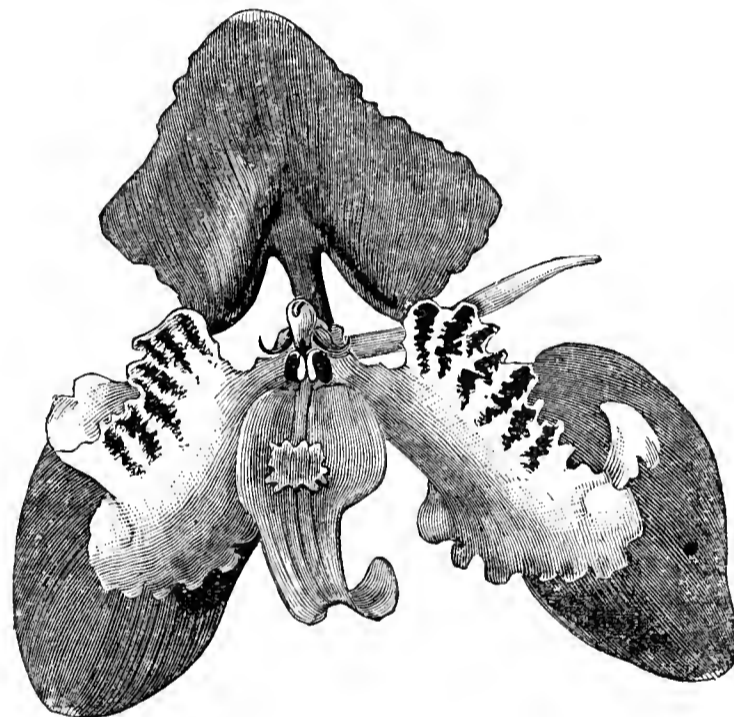

FIG. 24.—ONCIDIUM SUPERBIENS.

flower the annexed cut (fig. 24) is inserted. This *Oncidium* is a native of elevated districts in South America, having been found by Purdie at Ocana between 8000 and 9000 feet above sea level, and by Funck and Schlim near Pamplona. It produces a long raceme like many of its relatives, such as *O. macranthum*, *O. lamelligerum*, and *O. undulatum*, with broad, curiously shaped rich brown sepals, contracted at the lower part into a distinct stalk-like portion. The petals are yellow, with bars of rich brown running across or broken up, and not so much confined to the side as shown in the illustration. The lip also is brown, with a yellow base. The plant can be treated successfully in the same way as *Oncidium macranthum*, thriving in pots placed in the *Odontoglossum* house.

Opinions are sometimes expressed that Orchids are declining in popularity, but there is abundant evidence to show that though there may be fewer large collections ten times as many amateurs are now interested in Orchids as was the case a few years since. Prices are also well maintained in most instances. For example, at a recent sale a large imported plant of *Vanda cœrulea* was offered. It was in a basket nearly a yard square, and had about thirty stems, upon which were the remains of 200 old flower stalks. The plant was sold for forty guineas, which was rumoured to be the full amount of the reserve, and it was generally believed that the destination of the specimen was not a hundred miles from Tring.

Orchids were well represented at the Royal Horticultural Society's meeting on Tuesday, and one of the three novelties for which awards were made by the Committee was that here described.

O. triumphans is familiar to Orchid admirers as one of the finest members of a large genus, but it is similarly a matter of common knowledge that the varieties differ greatly in their beauty, especially in the colouring, and a richly coloured form ranks very high amongst the most effective Orchids grown. That shown by Mr. William Whiteley at the meeting in question is probably the best ever shown before the Orchid Committee, although at least half a dozen varieties had been certificated by the Floral Committee before the first-named body was constituted. Whiteley's variety has finely developed flowers, the sepals broad, the petals and lip much broader, the ground colour being an exceedingly rich clear yellow tint, with distinctly marked bars of bright reddish brown. The plant was a strong one, and had one tall stout raceme. It had been grown by Mr. Godfrey, manager at Mr. Whiteley's Hillingdon establishment.—LEWIS CASTLE.

ORCHIDS AT CLEVELEY.

IN my account of Cleveley some time ago I specially mentioned the grand pans of *Cœlogyne cristata* with its varieties, and *Lælia anceps*, and now that they are in flower it is well to add a little more about them. Of these two most useful winter flowering Orchids there is a magnificent display. Arranged as they are with a background of choice specimen stove Ferns, and set in a bank of Maidenhair Ferns, they present a sight at this time of year not easily forgotten. Of *Lælia anceps* there are 158 spikes and 320 flowers. In this number is included the magnificent mass of *Lælia grandiflora*, bearing forty-eight spikes and 144 flowers. This is probably the finest plant of this variety in the country. The flowers this season are much larger than hitherto. *Cœlogyne*s are represented by some half a dozen pans, and include *cristata*, *Lemoniana*, and the Chatsworth varieties, which are covered with flowers, averaging 100 spikes to each pan, which represent 2000 to 3000 blooms. The effect is charming, and Mr. Timmis, the owner of Cleveley, must feel justly proud of such a show; as also must his gardener, Mr. Cromwell. Another pleasing feature at this season is the *Odontoglossum* house, where are to be seen a splendid display of *Sophronitis*, hanging alternately with well flowered examples of *Odontoglossum Rossi majus*, and all thriving remarkably.

ONCIDIUM CAVENDISHIANUM.

In addition to many pretty Orchids in bloom at Highfield, Woolton, the residence of W. H. Tate, Esq., there is a very fine plant of the above, carrying sixteen spikes, each bearing sixty flowers. It is not often met with under such favourable conditions, but Orchids are really well grown at Highfield. Mr. Tate has a very choice collection, and Mr. George Haigh, the gardener, knows the cultivation they require. I shall have pleasure in noting the collection a little later on in the season.—R. P. R.

CALANTHE CULTURE FOR PROFIT.

I WAS much pleased with your article upon the above subject recently; but although agreeing with the able writer upon the main points, there is one little yet very important matter respecting which I feel inclined to differ from him—viz., the best compost for *Calanthes*.

I am one of those who strongly advocate the use of loam for *Calanthes*, as I have seen both it and the compost recommended by "M. H." tried, and the result was much in favour of the former. The finest *Calanthes* I ever saw were grown in a mixture of three parts fibrous loam to one part dry cow manure, with a good sprinkling of finely broken oyster shells and charcoal through it. The gardener in this instance was possibly a fortunate "one in a hundred," as he was generally able to procure good fibrous loam. In preparing it for *Calanthes* it was broken up by the hand into pieces the size of a large walnut, and passed over a riddle to free it from any loose soil before it was mixed for potting.

At the place I mention we used to grow the greater part of the stock in 7-inch pots—five pseudo-bulbs in a pot. The pots were filled with clean crocks to within 2½ inches of the top, and the pseudo-bulbs planted in the soil above the level of the pot, in the same style that most Orchids are potted. They were then taken into a Cucumber house and placed on the side walls of the beds, where they remained until removed to their flowering quarters. By the time they were needing shading the Cucumber leaves were sufficiently numerous to supply all requirements in that direction, and when syringing the Cucumber plants it was always our practice to give the *Calanthes* a slight syringing too. During the time they were in a vigorous growing state frequent supplies of diluted cow urine were given them, but as soon as growth ceased these supplies were stopped, and water gradually withheld until the flowers commenced expanding, after which no more was given them.

I can fully endorse what "M. H." says regarding the necessity of keeping the pseudo-bulbs in heat during their resting period, as

I remember at one time having a good object lesson on that point. I was serving at a place where *Calanthes* were well grown, and the master thought much of his plants. One year, to give them a thorough rest, he had them all removed after flowering into a house which never had a much higher night temperature during the winter than 40°, and often below that. When the time for potting came round, what was the dismay of everyone to find that the greater portion of the pseudo-bulbs were decayed and quite worthless, and this all through mistaken kindness!

I do not think there is a more useful winter-flowering plant than the *Calanthe*, and it is remarkably strange how few take the full advantage of its utility. I know places where it forms the main supply of cut bloom during the dark months of the year, and yet in my present situation, where cut flowers during the winter are much prized, there is not one *Calanthe*.—FLOS.

THE CULTIVATION OF THE PANSY.

MANY years ago, certainly from 1840 to about 1870, the "Show" Pansy was a popular flower with English florists as well as with our Scotch friends; but whilst with us this flower dropped considerably into the background and was rarely seen, Scottish florists continued year after year to introduce new and good varieties. Some of our English growers still cultivate this flower in the midland and northern districts, and the new Midland Pansy Society will do something towards creating a further interest in them. Divided as they are into three classes, selfs, white grounds, and yellow grounds, with rigid rules as to quality in regard to markings and blotch, they do not admit of that great diversity of colouring which belongs to the fancy Pansy, hence the latter has achieved a great popularity in Scotland, and especially in the northern and midland districts of England. Some idea may be gained of its popularity in the fact that annually an average of 100 new varieties are sent out for the first time by various raisers, ranging in price from 2s. 6d. to 5s. each. I have several Pansy growers' catalogues before me, and in one I find 328 varieties enumerated, in another 418, and in another 531 varieties; and if all the varieties in the catalogues published could be tabulated there would not be less than a thousand.

This popular flower is also receiving great attention in America as well as in Germany and other parts of the Continent, and various "strains" of seed are advertised for decorative purposes, but those who wish to grow flowers to exhibit for prizes must grow the fine named sorts of the florists. We are indebted to the Scotch florists for the superb varieties seen at the exhibitions in the midland and northern districts especially, and in amateur gardens where named varieties are grown.

To describe the cultivation fully of named varieties, to have them in their true character and beauty, would require more space than I am able to give now. A few hints must suffice. Planting at the proper time is an essential point. The Scotch florists often send out plants in the spring not too well rooted, and without any soil about the roots, and it is a mistake. When sent to a distance in the month of March, or earlier, and they can be planted in good soil in a cold frame, or temporarily planted rather close together in a sheltered spot, and protected in bad weather, they have time to make some roots before planting them in their open quarters in April. Where plants can be looked after during severe weather, buy them in October or November, and they then make strong plants for blooming early in the spring. It is a very great mistake to buy Pansy plants in May or June as some do, even waiting to see them in bloom first, for unless cool moist weather follows for a few days after the planting they make little or no headway, and many die, then Pansies are condemned as being difficult to grow.

Any good soil suits them for ordinary garden decoration, digging it as deeply as possible, and mixing in decomposed manure and fresh loam, and if the existing soil is heavy some burnt earth or coarse sand. Plant out in April, or early in May at the latest, in March if possible; and in dry weather water copiously. Pansy plants should not be allowed to become too dry, neither waterlogged in very wet weather. I have always found the young roots clinging to burnt earth and garden refuse when it has been used. An important point is to keep the plants free from green and brown aphids, the latter especially, as the Pansy is very subject to it in dry weather, particularly when keen east winds prevail. It is safest to give the plants a good dressing before planting, and I know no safer insecticide than "Swift and Sure," which can be obtained from any seedsman with instructions for use. This, used according to instructions, does not injure the very young flower buds, and is efficacious in destroying the aphides; but it is wiser to apply a dressing occasionally, or the brown aphides soon do mischief beyond our reach. To those who grow for exhibiting

purposes, I recommend a perusal of one or more of the excellent little treatises published by Scotch florists, as each gives brief practical instructions which may be safely followed.

Those who do not wish to go to the expense of buying named varieties can obtain a good display of Pansies by buying a packet of seed from some reliable source, and sowing it in March or early in April, the earlier the better, using good sandy soil, sowing in pans or boxes, not in heat, and as soon as the plants have two pairs of leaves transplanting them into other boxes or a frame until they can be planted in April or early in May, April if possible, keeping much soil about the roots in removal, and watering freely in dry weather. These plants make rapid growth, soon come into bloom, and continue flowering until late in the autumn.

For the convenience of amateurs who may wish to add to their collections, or commence one, I give the names of sixty of the best of the newer Pansies in commerce, but with the fact that we have about a thousand varieties in cultivation, and over a hundred new sorts introduced each year, many of the newer kinds must be passed over, but amateurs may safely rely upon getting a good selection from the undermentioned and at cheap prices—namely, A. S. Glass, Alexander Smith, Bella Coutts, Bonnie Annie Laurie, Blooming Heather, Daughter of the Morning, George Anderson, Henry Hamilton, James Campbell, James Douglas, John Taylor, Julia Goodfellow, Lizzie Duncan, Lord Bute, Lord Hamilton, Maggie A. Scott, Maggie R. S. Cocker, Miss French, Miss Henderson, Mrs. Atkinson, Mrs. John Ellis, Mrs. Freeland, Mrs. Lindsay, Marvel, Mrs. Lister, Mrs. Mack, Mrs. John M'Connell, Mrs. Philp, Neil Leitch, Neil Gillies, Robert Jamieson, Robert Stobbie, Thomas McCrorie and William Evitts. Good varieties a little older are Andrew Gray, Allan Ashcroft, Archie Buchanan, Charlotte Muir, Donald Morrison, Mrs. John Downie, John Lamont, Neil M'Kay, Mrs. Dobbie, Evelyn Bruce, J. J. Ashton, Mrs. Browell, Mrs. Maxwell, Campbell Bannerman, Charles Stansell, John Pope, May Tate, Mrs. G. P. Frame, Pilrig, Princess Beatrice, Kate McArthur, Tom Bell, Thomas Battersby, Miss Jeannie Reid, William Dean, and Wm. Cuthbertson.

Amongst the twenty-six last named varieties are many exceedingly fine flowers of great beauty and value to exhibitors. Objection may be taken by some raisers to the list I have given as not including some well worthy of notice. Granted, but with the enormous number of new varieties sent out every year who can select all the best, much less grow them? We are having far too many every year, some not sufficiently distinct and many inferior to existing varieties. One florist sent out thirty-three new varieties last year at 2s. 6d. each, not one of which had received a certificate at any Pansy exhibition.—W. DEAN, *Sparkhill, Birmingham.*

VARIEGATED FOLIAGE PLANTS.

ADMITTING that our Journal is open for free discussion, and that much good may be the result thereof, I am going to defend myself against the remarks of "B.," page 81, who thinks I am severe upon Mr. Atkins. In the first place it was far from my intention to be severe, but I desired to be truthful, and to enlighten readers. "B." says I am incorrect in my statements, and he alludes to my condemning Caladiums and Coleuses. The article I referred to was published in the columns of this Journal of January 15th, pages 39 and 40, and it states "At this season of the year (viz., January)," and goes on to recommend these two plants for decorative work. I again repeat that I have never seen Caladiums fit for decoration in winter, or only occasionally the variety argyrites, and Coleuses I have never found to stand longer than an hour or two. I admit in their proper season they are useful, but not for winter decoration. I am willing to go any distance to see these plants fit for that purpose now, and shall be very glad to purchase large quantities.

Then as to *Ananassa sativa variegata* he imagines that neither of your correspondents has seen this in good form, and he goes on to explain his method of growth and propagation. He states, "We grow our large plants in 10 and 12-inch pots, and when large enough the plants are beheaded, and the tops are rooted in 5-inch pots and kept in the full glare of the sun all the summer." In this I am somewhat mystified. How can you behead *Ananassas* and serve them as he directs? I am only speaking for myself. For his edification I will tell him what I have done with the *Ananassas*. Many years ago, when a boy in Messrs. Rollison's nursery at Tooting, these plants were scarce and valuable; we then had two varieties of *sativa variegata*, and another variegated one called *Porteana*, now seldom seen. The difference in the two forms was that one had much narrower and more highly coloured leaves. I do not remember where they originated, but *Porteana* came from the Philippine Islands. This has a leaf of a deep olive green colour, with a broad band of pale yellow extending down the centre. Our mode of propagating was principally by suckers and crowns. We used to fruit both varieties (fruit 1½ lb. to 2 lbs. only). *A. sativa variegata* produces crowns very freely from the fruit, and these made symmetrical plants. We grew them in pots suspended from the roof of the house, and they used to colour superbly. For ordinary decoration they are useful, but not as table plants, for they are very spiny, and no one would care to

use them for table decoration when the danger of getting scratched is so apparent. I should as soon think of using *Yucca aloifolia variegata*, with its spear like leaves and spines, as the *Ananassas*; both are dangerous.

"B." states then *Pandanus Veitchi* is one of the best standing plants. Yes, everybody who grows it knows its value. The Screw Pines are numerous, but this is the best variegated form, a great improvement on the old *Pandanus javanicus variegatus*. The former was introduced by the late John Gould Veitch from the South Sea Islands, and is one of the most useful decorative plants grown. Perhaps "B." will be surprised to hear I grew this before it was in commerce, so I think I may claim a slight knowledge of what I am writing about.

His remarks respecting *Ficus elastica variegata* would not do for those who have to make their living by growing plants. His mode of propagation would occupy too much room, and is far too long an operation. Then, to finish, he remarks both have omitted the *Dracenas* named by him; why even after this we could easily swell the number by naming many others if desirable.—RUSTICUS.



TWO GOOD LATE WHITE CHRYSANTHEMUMS.

PROBABLY few growers are as yet aware of the great value of *L. Canning* for flowering during January, either for decorative or market purposes. A year ago this variety was in great demand, there being a general belief amongst growers that it would prove first-class for exhibition, but in this it was disappointing, as owing to its lateness it was scarcely seen upon the exhibition tables. In consequence of this there appears this season to be no demand whatever for it. Its true value, however, is seen in its character as a late variety for producing grand white flowers during January, and in this I believe at present it has scarcely an equal. The plant is of dwarf and vigorous growth, producing smooth, hard, and shining foliage which is not susceptible to mildew (I have never seen a trace thereon), and swells its buds freely during the dull dark days of December and January. During the past week I have been cutting fine flowers from it, which would be taken by most growers as representing a superior type of *Elaine*, having exactly the form and character of that justly popular variety, but with slightly broader florets, and if possible a clearer and purer white. This is the type of flower which sells most freely and realises the highest prices, as it is most effective when cut for any purpose—in wreaths or bouquets, as flowers to wear, or for table decoration. It is my intention to grow as many as possible of it during the coming season for cutting from in January, 1892.

The other variety deserving a word of praise is *Sarnia*, which has been in cultivation a number of years, but is not met with in many collections; being of little use as an exhibition variety, owing to its lateness, many have ceased growing it. Like the above it is at its best during December and January, and for producing valuable flowers for cutting during those months it is certainly very useful. Its flowers have exactly the form and character of *Ethel*, but without the objectionable dark centre which imperfectly grown flowers of that variety invariably show. A local grower of cut Chrysanthemums for market showed to me some flowers of it during the last week in December, asking me if I could give him its name. He said he had grown it for some years for cutting from at Christmas not knowing its name, but finding that it produced better flowers and sold more freely than *Ethel*. My own experience of it this season fully coincides with what he then told me, and I shall cultivate it in future for Christmas flowers in preference to *Ethel*.—W. K. W.

LATE CHRYSANTHEMUMS.

IN endeavouring to provide blooms for Christmas a number of plants were raised from cuttings inserted in a cold frame in December. In April the late varieties were cut down, and the plants were afterwards allowed to grow without either topping or taking the crown buds, but the terminals were thinned to one bud on each stem. *Boule de Nieve* was over in November; *Putney George* was later, and kept well till January. *Grandiflorum* was the best, being well in bloom at Christmas, and kept till the 15th January. *Princess Blanche* does not grow over 3 feet high, and requires no cutting down. It is the dwarfest variety we have seen, and flowers in December when grown in pots, and this year was out well till the 15th of January. If planted out and potted before the frost comes it does not flower until the new year, and is very useful for low houses. Mrs. C. Carey is now being employed in vases, and is our latest, but it comes almost single. We shall try the varieties named by "E. M." for late work; but can he, or any grower, tell us of a white *Grandiflorum*? It would be a boon for late work, fine in form and holding its blooms well up to view, while some drop their flowers in vases. M. E. A. Carrière was over with us in November; but *Meto* on a cut-back gave us two grand blooms at Christmas; very pretty, but in our opinion no good as a "fillbasket" flower.—H. G., *Winchester.*

CHRYSANTHEMUMS AT CHRISTMAS.

I SHOULD like to add to the names already mentioned two others—namely, Mdle. Lacroix and Florence Percy, which are really excellent for Christmas decoration. The cuttings were inserted November 21st; after being struck they were placed in 4-inch pots and the former pinched when 6 inches high. Florence Percy was not pinched at all but allowed to grow at will. Subsequent to the final potting the plants of Mdle. Lacroix were pinched July 3rd, still allowing Florence Percy to break naturally. The plants were kept neatly staked but no shoots removed, and were placed at housing time in a cool Peach house and there kept until showing colour, afterwards removing to the conservatory, where we have had them for the past two seasons in perfection at Christmas time. Mdle. Lacroix is much the shorter grower. Florence Percy is charming; its whorled florets are greatly admired, and it is excellent grown on the above system.—R. J. R.

ECCLES, PATRICROFT, PENDLETON, AND DISTRICT CHRYSANTHEMUM SOCIETY.

THE annual general meeting of this Society was held on Friday last, the 30th January, at the Christ Church Schools, Patricroft; John T. Lewis, Esq., occupied the chair.

The annual report was presented by the Hon. Secretary, Mr. H. Huber, and approved by the meeting. It was considered a very satisfactory and encouraging one, and showed a continuous advancement of the Society in number and quality of the exhibits, attendance and financial position. The Hon. Treasurer, Mr. T. Hooper, read a statement of the accounts, showing a balance of £60 10s. 9d. to the credit of the Society.

Captain Andrew proposed that the district of the Society should also include the townships of Urmston, Flixton, Davyhulme, Irlam, Cadishead, Pendlebury, Swinton, Clifton, Worsley, Walkden, and Boothstown, which was seconded by Mr. A. B. Wimpony, and carried unanimously. The following officers and members were elected on the Committee of management for the present year:—Chairman, Mr. L. H. Larmuth; Vice-Chairmen, Mr. Wm. Elkin and James Derbyshire; Hon. Treasurer, Mr. John Hooper; Hon. Secretary, Mr. H. Huber; Committee, Mr. Jos. Bausor, Mr. John Bayley, Mr. James Bradley, Mr. John Briddon, Mr. Thos. Buckley, Mr. John Clarke, Mr. John Hesketh, Mr. Richard Johnson, Mr. John Parr, Mr. James Ramsdale, Mr. John Roberts, Mr. James Smethurst, Mr. John Turner, Mr. W. B. U. John, Mr. W. Pownall, Mr. J. Blears, Mr. W. Smethurst, Mr. Thos. Morton, Mr. Geo. Lee, Mr. J. Waterhouse. The date for holding this year's Chrysanthemum Exhibition was fixed for the 13th and 14th November. The meeting terminated with a vote of thanks to the Chairman.

ROYAL HORTICULTURAL SOCIETY.

FEBRUARY 10TH.

THE meeting at the Westminster Drill Hall on Tuesday last was exceedingly well attended by exhibitors, and the hall has not presented so varied and pleasing a display for a considerable time. A large table the whole length of the building, in the centre, was filled with exhibits, another was devoted to Apples and other fruits, while two other smaller tables were occupied with miscellaneous exhibits. Orchids, Primulas, and Cyclamens were the leading features amongst the flowering plants, and afforded a charming effect. The visitors present expressed much pleasure at the interesting character of the exhibition, and the contrast with the last meeting was a most agreeable one.

FRUIT COMMITTEE.—Present: P. Crowley, Esq. (in the chair), Dr. Hogg, with Messrs. J. Lee, R. D. Blackmore, G. Bunyard, James Veitch, W. Denning, J. T. Saltmarsh, W. Warren, J. Cheal, G. Norman, G. W. Cummins, A. Dean, G. Wythes, J. Hudson, H. Balderson, J. Willard, C. Penny, W. Bates, and J. Wright.

The display of fruit was extensive and excellent on this occasion, collections of Apples chiefly, but also excellent Pears and Oranges, extending the whole length of the hall. Rev. E. S. Lowndes, Little Comberton Rectory, Pershore, sent thirteen varieties of Apples, with an interesting letter descriptive of the soil in which they were grown—disintegrated oolite washed from the hills on blue lias, drained, and irregular beds of gravel. The fruits were of good size and well coloured, and the collection merited, as it received, an unanimous vote of thanks. Mr. Miller, Ruxley Lodge, Esher, sent some dishes of very fine Apples admirably kept in American flour barrels—a simple, useful, and good method of storage, and a vote of thanks was unanimously recorded. Mr. Crowley placed on the table samples of Peach wood showing injury by frost where they had touched the wires. Mr. Hudson stated that he had found the advantage of removing the branches of trees from wires before winter, and securing them in position in spring. Mr. J. Willard also advocated the same method, and he had found the advantage of it as applied to Raspberry canes.

Mr. W. C. Wemyss, Westbury Court, Westbury-on-Severn, exhibited a wooden tray for drying Plums as used in ovens near Bordeaux, and described in the "Kew Bulletin" for December last. It was triangular in shape, an inch or two deep, and the bottom closely latticed. It may be said, however, in reference to drying Plums that the varieties usually grown in British gardens cannot be profitably converted into prunes by any method of drying, as they are too soft and tender for that purpose.

Messrs. T. Rivers & Son sent a very extensive collection of fruit, including seventy-five dishes of Apples, seventeen of Pears, and thirteen of Oranges and Lemons. Extremely fine among the Apples were Peck's

Pleasant, Buckingham, Belle de Pontoise, Gloria Mundi, Lord Derby, and Reinette de Canada. All the Pears were very good, and the Oranges admirable examples of home growth. A large silver medal was recommended. Messrs. J. Cheal & Son also staged an excellent assortment of Apples and Pears, most of the fruits fine and remarkably well coloured. Blenheim Orange, Winter Queening, Lord Derby, Dumelow's Seedling, Prince Albert, Kentish Fillbasket, King of the Pippins, and Egremont Russet, were prominent in this collection (large silver medal). Messrs. Lane & Son sent forty dishes of Apples, most of them being very good indeed, and Lane's Prince Albert unusually fine and highly coloured. A silver medal was recommended for the collection.

Mr. G. Bunyard imparted to the Committee the sad intelligence of the death, on the previous day, of Mr. C. Haycock, who by the remarkable Apples and Pears he grew when at Barham Court, and exhibited successfully at the leading shows, gave a great impetus to improved fruit culture in this country. Mr. Haycock had served usefully on the Committee, and on the proposition of Mr. Bunyard it was unanimously decided that a letter of sympathy be sent to his widow on her great bereavement.

FLORAL COMMITTEE.—Present: W. Marshall, Esq., in the chair; B. Wynne, H. Herbst, R. Dean, T. W. Girdlestone, W. Furze, W. C. Leach, G. Phippen, H. B. May, F. Ross, C. E. Pearson, D. Jeffries, J. T. Bennett Poë, T. Baines, D. Noble, H. Cannell, G. Paul, C. T. Druery, G. Gordon, E. Mawley, W. H. Williams, J. Walker, and Rev. H. H. D'Ombra.

Primula sinensis varieties, from Messrs. H. Cannell & Sons, Swanley, constituted a large handsome group, representing all the best types of these beautiful and useful plants. Those shown were in admirable condition, vigorous, and flowering freely, and filled nearly one side of the central table. Medal was awarded.

Cyclamens from Messrs. Hugh Low & Co., Clapton, formed an interesting group; the plants extremely well grown, the flowers large, and the colours ranging from pure white to deep crimson (silver Bank-sian medal). Mr. C. Holden, Park Road, Ealing, sent some small Primulas, and Mr. J. Walker, Thame, showed three boxes of Carnation blooms (vote of thanks).

Mr. T. S. Ware, Tottenham, sent a few choice hardy plants, comprising Galanthus Elwes', G. caucasicus, G. latifolius var. Fosteri, Iris reticulata Bakeriana (blue and purple), and a small yellow Iris Danfordia (I. Bornmülleri).

The Right Hon. Lord Foley, Ruxley Lodge, Esher (gardener, Mr. J. Miller) showed three boxes of Eucharis and Cœlogyne blooms, with sprays of Asparagus plumosus (vote of thanks). Cut blooms of Rhododendron hybrids from Messrs. J. Veitch & Sons, Chelsea, were greatly admired, the flowers greatly varied in size and colour (vote of thanks). Clivias from Messrs. J. Laing & Sons, Forest Hill, formed an attractive group, as they were bearing large heads of globular deep red fruits, and vigorous well-developed foliage (vote of thanks).

Messrs. James Carter & Co., High Holborn, showed two baskets of Primula Holborn Blue and the Improved Holborn Blue for comparison; the latter being much deeper in colour with finer flowers (vote of thanks).

ORCHID COMMITTEE.—Present: Harry J. Veitch, Esq., in the chair, and Messrs. James O'Brien, Hugh Low, H. M. Pollett, H. Ballantine, C. Pilcher, E. Hill, H. Williams, F. Moore, Lewis Castle, J. Douglas, F. Sander, and Dr. M. T. Masters.

Messrs. B. S. Williams, Upper Holloway, exhibited a large and handsome group of Orchids and Ferns, which attracted much attention from the visitors. Cypripediums were well represented. A fine plant of Phaius grandifolius having twelve long racemes, Odontoglossums, Lælias, Lycastes, Angraecums, Dendrobiums, and many other plants were represented (silver-gilt Flora medal).

Messrs. Sander & Co., St. Albans, had a group of choice and valuable Orchids, for which a silver-gilt Flora medal was awarded. Some of the most noticeable plants were the following:—Odontoglossum Edwardi, with two large panicles of deep purple flowers; Lælia harpophylla, with seven or eight racemes of rich orange flowers each; Lælia anceps, Percivaliana, with large handsome flowers; the pure white Lycaste Skinneri alba; Odontoglossum biconense album, with a white lip; Angraecum sesquipedale, with two large ivory-like flowers; an exceedingly deep rosy coloured Odontoglossum vexillarium, a fine Cattleya Trianae, and several Dendrobiums, Odontoglossums, and Masdevallias (silver-gilt Flora medal).

Norman C. Cookson, Esq., Newcastle-on-Tyne, sent a fine hybrid Cypripedium named Wiedlicianum, the flowers deep red both in the lip and petals. Malcom C. Cook, Esq., Kingston Hill (gardener, Mr. W. Cullimore), exhibited a strong plant of Cattleya amethystoglossa bearing a fine head of flowers (cultural commendation). F. C. Jacomb, Esq., Cheam Park, Cheam (gardener, Mr. W. May), contributed a beautiful group of Odontoglossums and Dendrobiums. The plants were in wonderful health, the racemes and flowers remarkable, and the varieties of great merit (silver Flora medal). W. Cobb, Esq., Silverdale, Sydenham, showed several Cypripediums, Phalænopses, and the elegant little Saccolabium bellinum, for which a bronze medal was awarded. Messrs. Paul & Son, Cheshunt, contributed a group of Cœlogyne cristata in several varieties, the plants in capital condition, and the flowers large.

CERTIFICATED PLANTS.

Odontoglossum triumphans, Whiteley's Variety (William Whiteley, Hillingdon).—A grand variety with very large flowers, the petals and lip very broad, the colour rich yellow, with heavy blotches and bars of reddish brown. Very handsome.

Cattleya Trianae plumosa (J. Statter, Esq., Stand Hall, Manchester).—A distinct variety, with a deep central tinge of crimson in the petals, the lip rich magenta.

Iris Dunfordiae (T. S. Ware).—A charming little yellow Iris, the flower stems 3 inches high, the flowers $1\frac{1}{2}$ inch to $1\frac{3}{4}$ inch across, bright yellow oval falls dotted with green (first-class certificate).

Hamamelis Zuccariniana (J. Veitch & Sons).—This was shown from the open ground, bearing pale yellow flowers, much lighter than *H. arborea*, another Japanese species sent with it. A curious and interesting shrub (first-class certificate).

Cypripedium Creon (J. Veitch & Sons).—A beautiful hybrid from *C. oenanthem superbum* and *C. Harrisianum superbum*, the dorsal sepal rich polished purple margined with white, the lip and petals tinted with purple (first-class certificate).

Masdevallia Trochilus (Pitcher & Manda).—A peculiar species, which some thought should be termed *M. ephippium*. It has large hollowed reddish brown flowers, with long yellow sepaline points. A botanical certificate was awarded.

Primula Kentish Purple (Cannell & Sons).—A single variety with large handsome flowers of excellent shape and substance; the colour a rich crimson purple.

Primula Kentish Fire (H. Cannell & Sons).—A single variety with intensely bright fiery red flowers; very large and handsome.

Chorozema Lowi (H. Low & Co., Clapton).—An exceedingly free flowering variety of a useful greenhouse plant, the "standard" bright orange with a yellow centre, the "wings and keel" bright purple. The plants are bushy in habit, dwarf, and well adapted for decoration.

ANNUAL MEETING.

THE annual general meeting of the Royal Horticultural Society was held in the Lindley Library at 3 P.M. on Tuesday, after the ordinary business of the Committees had been concluded in the Drill Hall. Sir Trevor Lawrence, Bart., M.P., President of the Society, took the chair, and there was a good attendance of Fellows, amongst whom we noticed Baron Schröder, the Rev. W. Wilks, Dr. R. Hogg, Dr. M. T. Masters, and Messrs. W. T. Thiselton Dyer, Sidney Courtauld, H. J. Veitch, J. Douglas, G. F. Wilson, G. Paul, H. J. Pearson, Philip Crowley, A. F. Barron, H. Williams, F. Sauder, G. Bunyard, J. Cheal, C. Noble, H. M. Pollett, H. Turner, W. Marshall, G. Wythes, W. Bates, G. Nicholson, and G. Prince.

The business commenced in the usual way by the Rev. W. Wilks reading the minutes of the last general meeting, which were duly confirmed. He then stated that by a curious coincidence the number of candidates for election as Fellows was exactly the same as last year—namely, fifty-one, and the names having been read the candidates were declared to be elected. Upon the proposition of the Chairman, Messrs. W. Marshall and J. Cheal were next appointed scrutineers of the ballot for the election of Council and officers.

The report and balance-sheet having been printed and circulated amongst the Fellows, the Chairman proceeded, in moving their adoption, to review the work of the year. He considered the position of the Society was most satisfactory, and the best indication of this was afforded by the increase in the number of Fellows, which also showed an increase of popularity. Concerning the ordinary work of the Society it was not necessary for him to say very much, all present were as familiar with that as himself. The fortnightly meetings, however, had never been more interesting, and he referred to the Show held that day in the Drill Hall as an example of what was done in that way. Even during the severe weather exhibitors had contributed freely. Special thanks were due to the gentlemen who had added to the interest of the meetings by lectures on a variety of subjects, which had been admirably treated. A considerable number of certificates had been awarded, for fifty-six of which the Orchid Committee were responsible, which seemed to indicate that the members had been rather liberal. The Floral Committee were more moderate in their awards, and the Council wished it to be understood that nothing but first-rate novelties should receive awards. The Show in the Temple Gardens was a great success. It was opened by the Prince of Wales, and the Council had the pleasure subsequently of receiving a letter from the Secretary to the Prince expressing his entire satisfaction with the Show and all arrangements. Further, it was evident he had taken much interest in the Exhibition, as he had inspected the whole of it. Much useful work had been done at Chiswick; the gardens were in better order, and the Council would be glad if an increase in the number of Fellows would admit of more expenditure on Chiswick, but they were most anxious to avoid running into debt. The character of the Society's Journal had been well maintained, and it was rendered even more interesting. It was something they could give to country Fellows in return for their subscriptions, and the acknowledgments of the Society were due to the Rev. W. Wilks, and to Mr. D. Morris for their services in this work. Referring to the Horticultural Hall scheme, the Chairman said Baron Schröder would explain more in detail why the project was in abeyance. It was by no means given up, and they expected to succeed ultimately.

To the exhibitors many thanks were due, both amateurs and the trade, for their contributions of choice and beautiful flowers, and it was with the object of encouraging amateur cultivators that money prizes were being offered in the schedule of the present year. The old Chiswick days were remembered by some Fellows, and though he could not expect a return of these, they felt the step they had taken was in the right direction, and might lead to a greater advance another year. He referred to the losses the Society had sustained by the death during 1890 of several respected Fellows of the Society, including

Mr. Haughton, Mr. Shirley Hibberd, and Miss North, and mentioned that a Hibberd Memorial Fund had been instituted. A matter of some importance undertaken during the year was a series of experiments to test the constitution of London fogs and their effects on plants. The Royal Society had granted £100 towards investigating the matter, and it might produce results of importance to horticulturists. The culture of some plants had in several cases been given up near London because they were so severely affected, and though it was improbable the effects could be entirely removed, something might be done in that direction. The programme for the year 1891 would, he hoped, be considered a promising one; numerous interesting papers had been announced, and he expected the meetings to be fully as attractive as in the past year. With regard to the financial statement it was satisfactory to state that a clear surplus of £147 had been secured, and he hoped this would be the commencement of a long course of success. He concluded by expressing the thanks of the Council to the Committees, the Treasurer, and the Secretary, remarking with regard to the last named that he was sure they had found the right man for the right place.

Mr. H. J. Veitch asked if attention had been called to a paragraph in the *Journal of Horticulture* referring to an irregularity in the proposed election of Council and officers. He also handed up a copy of the paper to the Council.

The Chairman stated there had been a misapprehension with regard to the by-laws, which the Secretary would explain.

Mr. Wilks then read the paragraph referred to, which appeared in this *Journal*, on page 111, last week. He then claimed that the action of the Council had been governed by by-laws 63 and 69, as follows:—

"68. If any member of the Council dies, or becomes incapacitated from any cause whatever in the interval between any two annual meetings, the other members of the Council may fill up the vacancy so created by the appointment of some other discreet Fellow; and any Fellow so appointed shall for all purposes be deemed to occupy the position of the person to whose seat in the Council he has been appointed.

"69. For the purpose of the last bye-law, a member of the Council may be deemed incapacitated who is absent from England for more than three calendar months, or declares that he is incapable from illness, urgent duties or otherwise, from efficiently performing his duties as member of the Council."

He further pointed to bye-law 76, which reads thus:—

"76. The President, the Treasurer, and the Secretary shall vacate their offices on the second Tuesday in the month of February in every year, but shall be re-eligible, as hereinafter mentioned. In the event of any vacancy occurring in any of these offices by the death, resignation, or incapacity of any of the officers, such vacancy may be filled up by the Council."

Mr. Morris had been absent from England for over three months, and this constituted his incapacity for which he had resigned his position on the Council. He supposed that the misunderstanding had arisen by reference to the by-laws 66 and 67:—

"66. Any member of the Council may resign his seat in the Council, but such resignation shall not be deemed complete until it has been accepted by a resolution passed at the next ensuing annual meeting, and the acceptance of any such resignation shall not be entertained by such general meeting unless the member proposing to resign has signed a paper in the form marked E in the appendix, and has left it with the Secretary on or before the 1st of January preceding such annual meeting.

"67. The vacancy created by the resignation of a member of the Council shall be filled by the election, by ballot of the Fellows present at the meeting that has accepted the resignation, of some other discreet Fellow."

These provided for the resignation of members of Council and officers without the operations of causes enumerated in the other by-laws, and might be taken advantage of when there was a division of opinion in the Council, and some members wished to have the opportunity of bringing the matter before the Fellows.

Dr. R. Hogg wished to know which member of the Council had resigned from incapacity, and who had taken his place.

Mr. Wilks then said that Mr. Morris had resigned, and Mr. Crowley had been appointed to fill the vacancy thus caused. It was further said that Mr. Morris was expected to return next month, and he had been nominated for re-election because his services had proved so valuable to the Council.

In reply to an invitation from the Chairman, Dr. Masters explained in regard to the Hibberd Memorial Fund that it was intended to apply a portion to providing a portrait of the late Mr. Hibberd, but the principal object was to afford the child some material assistance, and he hoped subscriptions would be liberally contributed.

Baron Schröder rose to give a few remarks respecting the proposed Horticultural Hall, and was received with loud cheers. He said the reason why the scheme had been in abeyance was that a financial crisis had disturbed the city, and it was thought better to keep in the background for the present. The Royal Horticultural Society must ultimately have a home of its own, a hall worthy of the horticulture of Great Britain. In no country is there more skill and taste in horticulture, in no country is there so much pounds, shillings, and pence, yet the moderate sum of £40,000 could not be brought together for so important a purpose. The total amount promised is £22,000, but out of the large number of Fellows only 235 had contributed. This he considered was dreadful. Over 2000 members have not subscribed, yet if they would give £10 each the work would be complete. If £35,000

were subscribed he would be willing to guarantee the remaining £5000, but the Fellows must put their shoulders to the wheel and do their utmost to assist.

In reference to this matter Mr. Bunyard subsequently asked if it would not be advisable to call in the money already promised, as the interest would soon accumulate to the benefit of the fund.

Baron Schröder stated in reply that when he asked for £40,000 he said he would not call in the subscriptions until the whole amount was promised, and he could not go from his word. Still if any subscribers wished to send in the money he should be delighted to receive it, though he could not think of applying to those who had promised.

Mr. C. Noble called attention to the amount expended upon the Society's Journal, and wished to know if it was advisable to devote so large an amount to the purpose when the gardening papers would be willing to publish the information much more quickly.

Mr. Wilks explained that the sum of £449 included the postage of the Journal, and with regard to the general question he observed that the Journal was much appreciated by Fellows at a distance. If they threw up the Journal they would lose 800 or 900 Fellows the next day. They had secured nearly all the Fellows they could expect near London, and their increase would come chiefly from a distance, and to these their Journal specially appealed.

Mr. Marshall then announced that the members of Council and officers as recommended in the list issued. He stated that only fourteen voting papers were correctly filled, twenty-seven were incorrect, and several were blank. Members of Council resigning:—Sir C. W. Strickland, Bart., Col. R. H. Beddome, T. Francis Rivers. Fellows recommended to fill the above-mentioned vacancies:—Sir John Llewelyn, Bart., George Bunyard, D. Morris. Officers:—President: Sir Trevor Lawrence, Bart. Treasurer: Philip Crowley, F.L.S. Secretary: Rev. W. Wilks, M.A. Auditors: W. Richards, Harry Turner, Henry Williams, A. H. Pearson.

Mr. W. T. Thiselton Dyer commented upon the favourable progress of the Society, and concluded by moving a cordial vote of thanks to the Chairman, officers, and executive. This was seconded by Dr. Masters, carried unanimously, and a few words from the Chairman terminated the proceedings.



EVENTS OF THE WEEK.—Horticultural events are not numerous for the following week. Some provincial Societies have meetings and dinners to hold, but there is nothing of special importance. We are informed that the Sittingbourne Society will meet on February 17th, the Linnean Society meets on 19th at 8 P.M., and on February 21st the Royal Botanic Society have a general meeting at Regent's Park.

— **THE WEATHER** around London has been rather dull during the past week, but comparatively mild, except on one or two days, when easterly or north-easterly winds prevailed. The buds of Currants and Gooseberries are starting, and a few hardy flowers are expanding.

— **VEGETABLES AND THE FROST.**—From various sources we find that the scarcity of green vegetables in consequence of the frost is something more than a disappointment in some families, and that there are gardeners who are not just now on the best of terms with cooks. No one can be justly held accountable for the scarcity in question, and as affording conclusive evidence of this it will suffice to record the fact that absolutely all the green vegetables in the Royal Horticultural Society's Gardens at Chiswick have been destroyed by the severe and protracted frost in the south of England. No winter crops have escaped, and all the spring Cabbages and Lettuces have melted away.

— **DEATH OF MR. C. HAYCOCK.**—As will be seen on reference to our report of the Fruit Committee of the Royal Horticultural Society on page 124, the able gardener and accomplished fruit grower, Mr. C. Haycock, died on Monday last. Some time after leaving Barham Court, Kent, he took charge of the gardens of Robert Smith, Esq., Goldings, Herts. We are informed that he had been suffering for some time from Bright's disease, to which he succumbed on the date named. He was fifty-one years of age, and in every respect a most estimable man.

— **GARDENING APPOINTMENT.**—Mr. J. M. Tucker, for the last two years foreman to Mr. Clinging, Marden Park Gardens, Caterham Valley, has been appointed head gardener to J. G. Lovell, Esq., The Elms, Bedford.

— **EARLY TOMATOES.**—"J. M." writes:—"Tomato plants raised from cuttings last autumn, if potted deeply and the soil made firm, will, if grown sturdily on a shelf near the glass in a temperature about 65°, afford ripe fruits about the end of April. Seed sown at once thinly, and the plants well managed, will afford early crops, but will not bear so heavily as will plants raised in a few weeks' time. Varieties which bear very large fruit are not the best for the earliest supply."

— **THE TOTAL RAINFALL AT CUCKFIELD, SUSSEX,** for the past month was 2.95 inches, being 0.82 above the average. The heaviest fall was 0.86 inch on the 29th. Rain fell on twelve days. Highest temperature, 49° on 31st; lowest, 9° on the 10th; mean maximum in shade, 38°; mean minimum, 28°; partial shade readings, 5° below the average.—R. J.

— **THE WEATHER.**—In S. Perthshire the weather for the past fortnight has been an alternation of fine and dull days. The 1st, the 6th, and the 8th inst. were very fine, the last especially so, almost enough to delude one into the idea that spring had come. But March, when we not unfrequently have our heaviest snows, is still ahead. Occasional slight frosts have occurred. This morning (9th) 6° are registered, the lowest for nearly three weeks.—B. D.

— **THE WEATHER** here during the past month has been of an unusually severe character. For the first twenty-three days the frost was very sharp, and during that period both rain and snow frequently falling together. On the 26th a general thaw set in, which thoroughly broke up the frost. Rain and snow fell upon ten days. Maximum in any twenty-four hours, 0.43 on the 30th; minimum in any twenty-four hours, 0.02 on the fourth; total for the month, 2.02.—E. WALLIS, *The Gardens, Hamels Park, Buntingford, Herts.*

— **FROST AT STIRLING.**—Mr. G. McDougall writes:—"I forward for your inspection the day and night temperatures from 25th November to 25th January, which show that upon forty-four nights frost was registered. We have had several winters within the last twelve years with longer continued frost, notably 1880-81, which continued from the last days of November to the first week in March without intermission, except two or three days in the middle of December. The thermometer stands in the open 3½ feet above ground, and about 16 feet above sea level." We observe the lowest readings are, omitting decimals, 14° December 21st, and 11° January 10th and 23rd, or in other words 18° and 22° of frost respectively.

— **THE WEATHER FOR JANUARY.**—Summary of meteorological observations at Hodsock Priory, Worksop, Notts, 56 feet above mean sea level.—Mean temperature of the month, 34.3°. Maximum on the 27th, 50.6°; minimum on the 18th, 6.7°. Maximum in the sun on the 31st, 90.8°; minimum on the grass on the 19th, 2.4°. Mean temperature of air at 9 A.M., 33.3°. Mean temperature of soil 1 foot deep, 33.4°. Nights below 32°, in shade twenty-three, on grass twenty-eight. Total duration of sunshine in month forty-six hours, or 90 per cent. of possible duration. We had eleven sunless days. Total rainfall, 1.30 inch. Rain fell on fourteen days. Average velocity of wind 10.2 miles per hour. Velocity exceeded 400 miles on four days, and fell short of 100 miles on five days. Approximate averages for January:—Mean temperature, 37.5°; sunshine, thirty-five hours; rainfall, 1.82 inch. The first three weeks were cold and frosty, and the last ten days mild. There were two very cold nights, and on a third the minimum was below 20°. The absolute minimum was lower in 1879 and 1881, as in March, 1883.—JOSEPH MALLENDER.

— **EFFECTS OF THE LATE FROSTS.**—We can now more fully ascertain the damage caused by the recent severe frosts amongst our vegetables. Brussels Sprouts, Veitch's Exhibition and Paragon, have stood well. Out of seven varieties of Broccoli not a single plant is left; the same applies to the Purple Sprouting Broccoli. Of the Kales Chelsea Exquisite Curled is uninjured, whilst the Dwarf Green Curled, growing by the side of the former, has suffered considerably. Of spring Cabbages we have lost 90 per cent. Ellam's Dwarf Early is the great favourite here on account of its earliness and delicate flavour. We have sown again, and intend potting the plants so to make up what time we can. Celery was well earthed when the ground was moderately dry, and well beaten with the spade, and upon the first appearance of frost the tops were covered with plenty of clean straw, and the frost did not reach the stems. Many shrubs have suffered considerably, owing, in a great measure, to the position they occupy being low, and often much water abounding near their roots.—JOHN DOUGHTY, *Angley Park Gardens, Cranbrook.*

— THE WEATHER LAST MONTH.—January was cold with snow on the ground up to the 20th, when we had a heavy rain in the night, and the weather was warmer afterwards to the end of the month; we had more sunshine than usual. The wind was in a westerly direction twenty-two days. The total rainfall was 1.42 inch, which fell on twenty-one days, the greatest daily fall being 0.41 on the 31st. Barometer highest 30.61 at 9 A.M. on 11th and 13th; lowest 29.38 at 9 A.M. on 22nd. Maximum shade temperature was 52° on 23th; minimum 1° on the 18th; minimum on grass 4° on 19th. A thermometer on the outside of the screen stood at 0° at 11.50 P.M. on 17th, and from 2.30 to 6.30 A.M. on the 18th. Mean temperature of the month was 32.88°. The garden spring ran 9 gallons per minute on the 31st. All the Broccoli and Brompton Stocks are killed, and many Cabbages, Variegated Kale, Lettuces, &c.; probably others will show severe injuries when growth commences.—W. H. DIVERS, *Ketton Hall Gardens, Stamford.*

— ROYAL METEOROLOGICAL SOCIETY.—At the ordinary meeting of this Society, to be held at 25, Great George Street, Westminster, on Wednesday, the 18th instant, at 7 P.M., the following papers will be read:—"The Great Frost of 1890-1891," by Charles Harding, F.R.Met.Soc.; "On the Varieties of the Rainfall at Cherrapoonjee in the Khasi Hills, Assam," by H. F. Blanford, F.R.S.; "The Problem of Probable Error as Applied to Meteorology," by T. W. Backhouse. The twelfth annual Exhibition of Meteorological Instruments will be at No. 25, Great George Street, from March 3rd to 19th.

— LIVERPOOL HORTICULTURAL ASSOCIATION.—A lecture, entitled "The Gardener's Insect Friend," was given last Saturday before the members of the above Association by Mr. Harbordt, Covent Garden Seed Stores, Liverpool. The lecturer dealt chiefly with the honey bee, showing the important part which this and other insects have played and are still playing in the development and improvement of many important plants and trees. The lecturer notably referred to the indebtedness of the orchardist to the honey bee. The lecture was illustrated by means of the magic lantern, which materially assisted in the explanations given. Messrs. Cox, White, and Roberts took part in the discussion which followed. A vote of thanks to the Chairman, Mr. White, brought the meeting to a close.

— THE CARDIFF AND DISTRICT CHRYSANTHEMUM SOCIETY.—The annual meeting of this Society was held at the Black Lion Hotel, Cardiff, on Friday evening, February 6th, a large number of members being present, Mr. T. Malpas in the chair. Mr. F. G. Treseder, Hon. Treasurer, presented the financial statement for the year, which showed a favourable balance of £40 12s. 7d. The following were elected officers for the ensuing year:—President, Col. Hill, C.B., M.P.; Mr. C. R. Waldron and Mr. F. Searl were re-elected Hon. and Assistant Secretaries, as were also the old Committee, with Mr. T. Clark, Chairman; Mr. F. Armitage, Vice-Chairman. It was decided to hold the next Show on November 11th and 12th, 1891. A vote of thanks to the retiring officers, and to the Chairman and Vice-Chairman, terminated the proceedings.

— AT the February meeting of the SHEFFIELD FLORAL AND HORTICULTURAL SOCIETY Mr. James Simmonds read a very practical paper on the "Primula," which induced a most useful and interesting discussion on the best varieties of double Primulas. In the course of the remarks made it was stated that the old alba plena is still the best double Primula, as it is so free flowering. The Marchioness of Exeter is also a grand variety; the flowers large, extremely double, and plants often flower so well that the plants were liable to exhaust themselves. Another good variety is alba plena fimbriata, having each petal fimbriated, but in other respects, including constitution, the variety is the same as alba plena. White Lady is similar to Marchioness of Exeter; Delicata resembles alba plena fimbriata, but has much larger blooms, which are produced quite as freely and are as useful for cutting, and the stems do not snap like the Marchioness of Exeter and some others.

— THE PROPAGATION OF DOUBLE PRIMULAS was also discussed, Mr. Collier advising that after flowering, when the plants have become somewhat exhausted and are becoming tall, the lower leaves can be trimmed away, and some sphagnum moss mixed with sand placed round the stems. Into this material in April and May the stems will root as quickly as possible, when they can be taken off and potted. Young cuttings like these make the best of plants. Some use

turfy soil for rooting the stems, but he considered moss and sand to be the best.

— BUTTERCUPS IN LAWNS.—I should be obliged to any reader of the *Journal of Horticulture* who would give me any information as to destroying the common Buttercup (*Ranunculus bulbosus*) on lawns, for there are numerous patches of it on our lawns. I have applied the weed killers, it has no effect upon it but improves the growth.—W. E., *Newchurch.*

— LISBURN CHRYSANTHEMUM SOCIETY.—The Committee of the above Society met last week in the British Workman Hotel, Lisburn, for the purpose of winding up the affairs of last season, and inaugurating the campaign for the present year. Mr. McGrath presided, and there was a good attendance of members. Mr. S. Nelson read the report of the Society, which was most encouraging; and Mr. Samuel Cairns produced the balance-sheet. After settling all liabilities there was a small balance in hand; and by the unanimous desire of all present it was resolved to push forward the prospects of this year's exhibition, as the Society hopes to materially increase its popularity.—A. SCOTT, *Rathmore.*

— BLANCHED LAUREL SHOOTS.—A Dorsetshire correspondent writes—"Having been greatly struck by the beauty of some perfectly white Laurel shoots, I now send a small piece as a specimen. These shoots are produced from a healthy green Laurel, and for four years, during which time I have had the opportunity of watching them, I do not believe there has been a single instance of even a symptom of green in them. They grow about 3 or 4 feet high, and are beautiful in decoration, for which purpose they have been cut rather severely. My object in sending this specimen is to find out if anyone else has seen a similar departure from the usual nature of the Laurel, and if not, whether these shoots under proper treatment might not be used for propagation, and so a new and valuable addition be made to our garden shrubs." [We have seen similar examples before, but we do not know whether they have been propagated by cuttings or in any other way. Perhaps some of our readers can tell us something about the matter.]

— WOOLTON GARDENERS' MUTUAL IMPROVEMENT SOCIETY.—A meeting was held in the Mechanics' Institute last Thursday evening, Mr. R. W. Ker in the chair, when the prize for an essay on the "Culture of Greenhouse Rhododendrons" was awarded to Mr. R. G. Waterman, who read the paper (see page 131). It was followed by a good discussion, in which Messrs. R. Tod, — Rae, J. Calland, J. Stoney, A. Kime, T. Winkworth, — Griffiths, and the Chairman took part. The second paper was also a prize essay on "The Selection and Cultivation of Hollies" suitable for the Liverpool District. This was read by the successful writer, Mr. H. Corlett, and the discussion was carried on by those already named, and Mr. R. Lawrence. The prizes are gifts made to the Society by Messrs. R. P. Ker & Sons, and have caused considerable interest amongst the members. A vote of thanks was accorded to the essayists for their papers, and a similar compliment to the Chairman concluded a very enjoyable and instructive meeting, at which about forty persons were present.

— EAST GRINSTEAD HORTICULTURAL SOCIETY.—Mr. G. Wyatt Truscott, the President, was entertained by the members of this Society at a banquet last week. There was a large attendance. In concluding an excellent speech, Mr. Truscott desired to repeat his injunction to gardeners to join the Society, because he was sure it would very largely benefit them if they would use its advantages aright. It had been his misfortune lately to notice one or two gardens where gardeners had injured their chance of promotion in their art by slovenliness. He urged them to pay stricter attention to detail, because in whatever walk of life they were placed they must always remember it was not the work which measured the dignity of the man, but the man who determined the dignity of the work. If they would only remember that they would have cause to be thankful in after life. He thanked the inhabitants of the neighbourhood for the generous support accorded to the Society's past Shows, and asked practical gardeners to aid by joining in discussions and reading papers, for without that practical aid the Society could not possibly succeed.

— LORD DORCHESTER, presiding at the meeting of the METROPOLITAN PUBLIC GARDENS ASSOCIATION recently, in the absence of the Earl of Meath, announced that of the £3000 required for the laying-out of the Victoria Park Cemetery, over £2800 had been subscribed

including £500 promised by His Grace the late Duke of Bedford. In the assurance of this promise the Chairman had authorised the dispatch to the London County Council of the formal offer of the Association to undertake the work, as agreed upon at the last meeting. It was resolved to continue negotiations respecting the proposed conversion of Bartholomew Square, E.C., De Beauvoir Square, N., and Sidney and Bedford Squares, E., into public gardens; to assist the Poplar District Board of Works in the laying out of a new recreation ground in Bow Road, and to communicate with the Chelsea Vestry respecting the seats removed from Sloane Square. The Ecclesiastical Commissioners, it was reported, had given three months' further extension of the time in which they would be prepared to sell about nine acres of land between Crown Road and Fulham Palace Road for a recreation ground at a low rate, and that the Fulham Vestry were ready to give half the money if the London County Council subscribed the balance.

— ROYAL BOTANIC SOCIETY OF LONDON.—At a meeting of this Society last Saturday, Mr. T. H. Burroughes in the chair, it was announced that included in the donations received since the last meeting were seeds of the Para Rubber tree, presented by Mr. Plowes, a Fellow of the Society. The Secretary (Mr. Sowerby) said that at the present moment anything relating to the growth or cultivation of indiarubber and gutta percha was of the utmost importance to civilisation. In the Society's museum is a specimen of the first sample of gutta percha imported to Europe—viz., in 1842, and shortly after that date it was used to insulate the first submarine telegraph cables, and up to the present moment no substitute has been found to take its place. From some interesting papers lately published in the *Electrical Review*, he gleaned that from the "wholesale cutting down of adult trees" and the "reckless clearing and burning of the forests" the trees furnishing the most valuable kinds of gutta percha had become exceedingly scarce, and in most localities utterly extirpated. This is also rapidly becoming the case with the trees which supply the many varieties of indiarubber, and only illustrates the fact, continually being mentioned by him, that, sooner or later, all natural vegetable products used by man must be artificially cultivated, as the natural supply never kept pace with the artificial demand. Some few attempts had been made to cultivate indiarubber, but as yet not very successfully; and the behaviour of the several kinds of trees furnishing elastic gums in the Society's collection—natives of Central America, Tropical India, and Africa—all proved that it was no easy task civilisation had to contend with, but which, if it wished to continue to enjoy the benefits of telegraphic communication, it must sooner or later solve. Dr. Prior made some interesting remarks upon the Egyptian Papyrus plants now growing in the gardens.

— HINTS ABOUT FREESIAS.—For some time past varied opinions have been expressed respecting the culture of the Freesia in nearly every gardening periodical, which I have read with interest, as I think many fail to grow this beautiful, sweet scented plant to anything like perfection. Yet the culture is simple; at least, I have always found it so, and always been able to flower them well. I think where fragrant flowers are required for the house decoration, either in a cut state or in pots, the Freesias should be one of the first to be had for autumn and winter work, as they stand being placed in the rooms very well, which proves fatal to so many other plants. I generally pot the bulbs in August, placing eight in a 5-inch pot, in a compost of two parts loam and one of leaf soil, with a liberal quantity of sand. They are then placed in a cold frame and lightly covered to a depth of 2 inches with cocoa-nut fibre, in which position they remain until their growth is seen. I then remove the fibre from the top of the pots, but for a few days I cover the frame with a mat, so as to gradually accustom them to the light. When the pots are well filled with roots they are brought into the intermediate house and placed on a shelf near the glass, where they remain until the plants flower. If a few are required for any special purpose they are placed in heat, always being careful to bring them back again into a cooler house to open their flowers, as, like all other flowers, they last much longer when treated in the way mentioned. When the flowers are visible the plants are supplied with weak liquid cow manure at every alternate watering. After they have flowered they are replaced on the shelf in the full sun, and liberally supplied with liquid manure, so as to plump the bulbs for another season. I think the reason why many fail to flower bulbs of any description after the fruit year is, they forget that they require "feeding" after flowering, to replace the nourishment which has been drawn from the bulbs. I have had equally as good flowers of Freesias the third year as I did the first from bulbs treated in the way mentioned.—O. W. GUY.

A JOURNEY TO BURMA.

[A paper by Mr. A. WINKLER WILLS, read at a meeting of the Birmingham Gardeners' Association.]

(Continued from page 90.)

WE drove to our daughter's bungalow, and were at once installed in luxurious quarters. Like most Burmese houses it has all its rooms on one floor, which is approached by a double flight of stairs, and supported on massive teak posts. The space underneath serves as coachhouse and conservatory too, for here we have fifty sorts of Crotons in richest foliage, *Eucharis amazonica*, *Allamandas*, Orchids, &c. Here *Vanda cærulea* is in glorious bloom in the open air, and so is *V. teres*. Dendrobiums of many species are flourishing, though not in flower, such as *D. Dalhousieanum*, *D. Parishii*, *D. fimbriatum*, *D. primulinum*, and many others. *Ciitoria Ternatea* and the vivid scarlet *Ipomæa Quinoclit* climb to the roofs of the houses, mingled with a much-prized English Honeysuckle. It may interest you to know how one's day is spent in the far east. You rise with the sun about 6 A.M. He has no fog or smoke to dissipate, and strikes hard with his burning rays, as he mounts above the long range of mountains 5000 feet high, which bound the horizon to the east some fifteen miles away, so that by 7.30 A.M. the thermometer in winter stands at 80° to 82°, in summer at 100° to 110°. At 6.30 you have *chota hajari* (little breakfast) consisting of coffee, toast and butter, and plenty of fruit, Custard Apples, Papaws from the gardens, Oranges, such as we never tasted elsewhere, from the hills, and in the summer Mangos, Mangosteens, and Pines.

From 7 to 9.30 we always drove among the lovely roads in and about Toungoo, and I photographed tropical vegetation and scenes of Burmese life, pagodas and monasteries. The 20,000 inhabitants cover a large space, probably some two miles square; the houses are scattered here and there among Bananas, Cocoa and Palmyra Palms and tropical trees by the sides of broad and well kept roads, and from early morn to dewy eve these roads are full of happy people moving to and fro, chatting and laughing, for laughter is as common among these children of the sunny east as long and anxious faces are in our streets. Everyone is well off, for everyone has enough, and the desire to hoard is both forbidden by the Buddhist religion and almost unknown among the people.

Everyone is decently dressed, and the squalor, rags and filth of our poorest classes have no counterpart in this happy land. I have seen crowds assembled at festivals and holiday times, and the mingling shades of amber, pale red, blue and every imaginable soft and delicate colour are only to be compared to a living parterre of daintily tinted flowers. The greatest reproach which can be levelled at a Burman is that he has sunk so low that he cannot don a silken passoo or skirt at such times. The good humour and kindness of these people is unlimited, and they strike one as being at all times Nature's perfect gentlefolk. We had unusual opportunities of judging of these qualities, for my son-in-law, Mr. Sage, has lived long among them, and speaks their language perfectly, so that we were always able to communicate with them through his mediation.

On our return from our drive, when the heat of the sun had become oppressive, we settled down to our various occupations—Mr. Sage to his official duties, my daughter and wife to their reading, and I to developing my photographs. At eleven everyone takes a hot bath, and at twelve comes tiffin, a substantial meal of meat and abundant vegetables, for from 6 A.M. to 6 P.M. the gardeners are incessantly carrying water from the river Sittang close by to the garden, and thus Cabbages, Cauliflowers, Spinach, and Carrots are grown with much success; Potatoes are imported. After tiffin all resume their several occupations, and at 5 P.M. we always drove out again, generally round the lakes, which are the favourite and most beautiful retreat in the cool of the evening, when the thermometer has gone down to 75°.

Then as we returned it was delightful to see the streets crowded by happy people. At one corner, the junction of four broad roads, there was generally a little crowd of youths, stripped save for their waistcloths, enjoying the national game of ball-play; and as darkness came on—and it comes on swiftly after sundown in these latitudes—stalls were brought out and set up in the roadsides, at which were exposed for sale pieces of Sugar Cane, native cigars, sweetmeats, and the like, and little fires appeared here and there, at which thin mealcakes, like gigantic pancakes, were cooked for sale to the passers-by. All was life and happiness, and Cocoa Palms and Bananas formed everywhere a charming background to the scene, while now and again the marvellous odour of the male bloom of the Sathapoo, Screw Pine, or Pandanus filled the air with its penetrating richness, so that we never returned to our home without regret and reluctance.

At 8 P.M. came dinner, a good square British meal, and after that music, a game of cards, chat, and so forth. At eleven we went to bed under the necessary mosquito curtains, with windows wide

open, and slept the sleep of healthy fatigue till the sudden daylight aroused us in the morning.

Toungoo is a garrison town with a wing of British and another of Indian troops officered by Englishmen, and has splendid airy and roomy wooden barracks, well sheltered by magnificent Mango and Peepul trees, so that the European colony is of respectable dimensions, and affords good and pleasant society.

Very characteristic of the country is what I must call, for want of a better term, its ecclesiastical architecture. Pagodas are as

the houses of the brethren are not only the homes of those who devote their entire lives to pious meditation and religious exercises, but the schools of the country. I could say much of this system but my time is too short, and I must content myself with a reference to the peculiar architecture of these remarkable and very numerous buildings. They are generally buried in trees and approached by flights of steps, flanked by remarkably quaint representations of dragons, serpents, and sometimes of evil spirits or nats, in whose omnipresence the Burmese have unbounded belief. The main

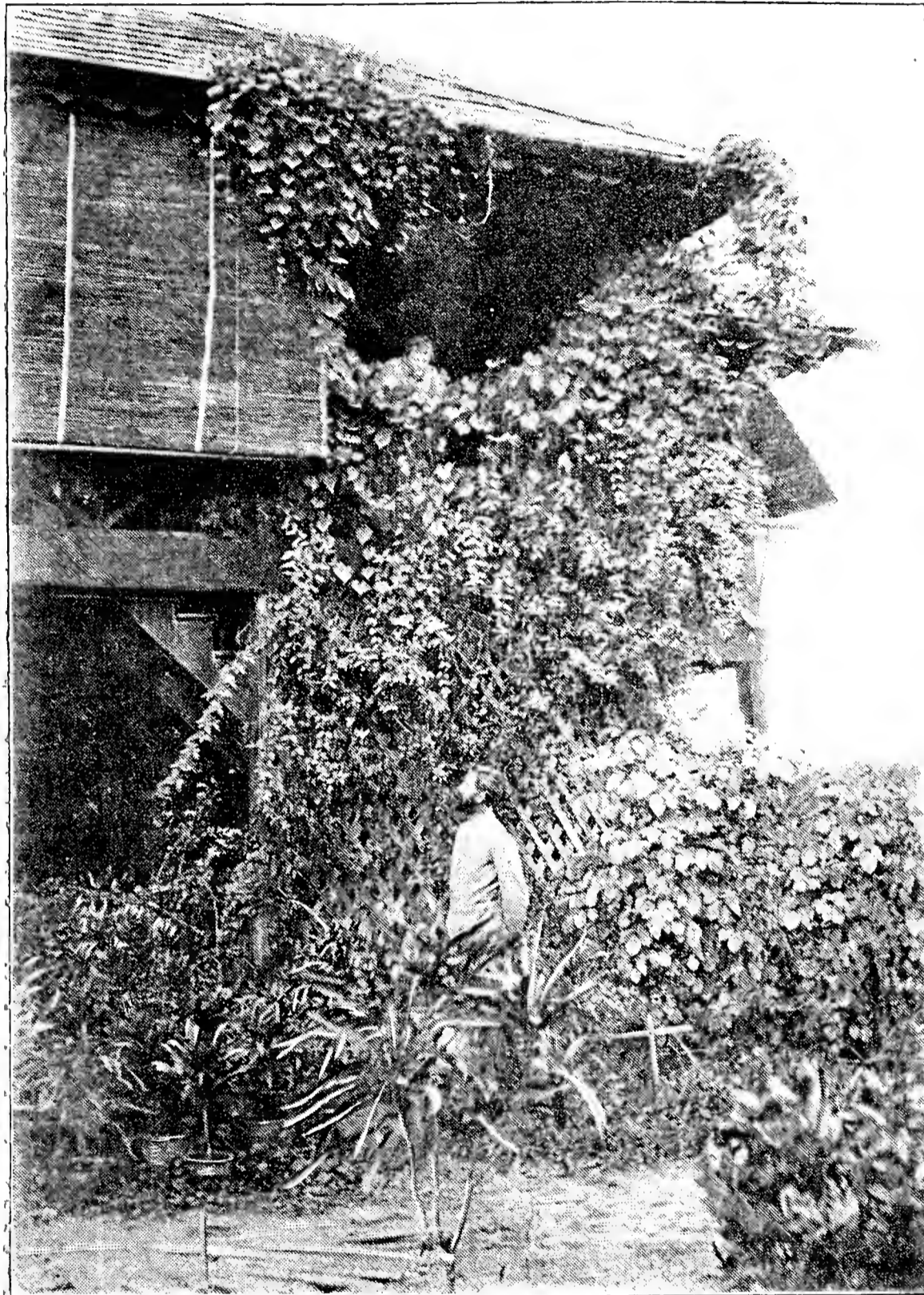

FIG. 25.—A BURMESE BUNGALOW.

numerous as churches in our country, and are all of the same general form, though in miniature, as the great Schway Dagon of Rangoon, which I have described at some length.

Equally interesting are the hypoongyee kycungs, or houses of the Burmese brethren. The aim of the Buddhist religion is to make every man a hypoongyee or priest (again I use the word for want of a better), and to promote a life of religious meditation, by which he shall attain to a degree of self-abstraction and piety which shall enable him, in the next migration of his soul, to rise to a higher grade of being; for if he fail in this he is doomed to retrograde, and to become a lower animal again. Hence, every male Burman becomes, if only for a short time, a hypoongyee, and

building is always supported on teak upright posts, so that there is an open space beneath it. From the first floor it rises, tier upon tier, the whole built in teak wood, and often from floor to loftiest pinnacle adorned with carvings of very exquisite workmanship. Within is always a large temple with its images of Buddha and the paraphernalia of the Buddhist service, and alongside of this the dormitory of the hypoongyees and their often extensive library of sacred literature, written upon prepared slips of Palm leaf. The brethren are always courteous and dignified, and in every instance they threw open all parts of their establishment to our inspection, guiding us themselves and dismissing us with the polite Burmese salute, "Now you can go. Come again." Once some-

thing was added which I asked Mr. Sage to interpret, and he replied, "The Hypoongyee has paid you a great compliment; he says, 'You are not like some English people, who come into our places as if they were their own. Come again!'" Indeed, as we were in simple courtesy bound to do, we always asked the permission of these good people before we entered their buildings, and paid the same tokens of respect to their religion as we should do in entering a church at home, and as we should expect a foreigner to do if he entered our own Christian place of worship.

Dancing, theatrical entertainments, and sports are dear to the hearts of the Burmese. We were fortunate enough to witness a pue or play, or rather a portion of it, for the entire performance lasts from 8 P.M. till 5 next morning. It was given by the inhabitants of one quarter of the town of Toungoo, and was considered a performance of high quality, and was held on a level space of turf surrounded by trees. In the middle of this a canopy of bamboo mats covered an area of some 70 feet square. Two little piers of bricks about 2 feet high supported two pots of flaming kerosene oil, which were replenished with a wooden ladle from time to time by the performers. These were footlights and illumination of the house. A space of 12 feet square was kept clear round these piers, and formed the stage, and around this rose rank behind rank of men, women, and children to the number of several thousands. A place of honour was courteously reserved for us in the front row. The wardrobe of the performers consisted of a large wooden chest, from which they extracted ever and anon fresh costumes, and behind the stage, almost invisible in the gloom, was the orchestra of drums, fifes, clogken, and horns.

The actors consisted of two clowns, several princes and princesses, Woons or Ministers of State, and two dancing girls in beautiful silken robes and profusely adorned with gold and jewels. The piece consisted of one of those long drawn out legends which abound in Burmese literature, in which are described the search of a young prince for a suitable mate, his travels through distant lands, the encounters of himself and his retinue with wild beasts, evil spirits, false priests, &c., with an occasional interlude in the shape of a dance or ballet. The dancing consisted of a series of innumerable angular contortions of the body, evidently extremely difficult, but not consonant with our western notions of elegance, but it elicited rapturous applause. We watched the performance for two hours, and then the densely packed crowd made way for us most courteously, and we finally extricated ourselves by winding in and out through lines of bullock carts which fringed the outside of the throng five or six deep, and among numerous sleepers wrapped in their long robes, who were stretched on the ground recruiting themselves by a nap previous to returning for another spell of the performance.

(To be continued.)

ROYAL HORTICULTURAL SOCIETY.

REPORT OF THE COUNCIL FOR THE YEAR 1890-91.

THE year 1890 has been one of steady work and progress for our Society. Five conferences have been held at Chiswick—viz., on Daffodils, on Carnations, on Ferns, on Dahlias, and on Grapes, and the attendance of Fellows and others at them, as also at the fortnightly lectures at the Drill Hall, has been decidedly more encouraging than in previous years. Fellows would greatly assist the Council by making these meetings and lectures better known among the general public. For this purpose Fellows may obtain at the office packets of tickets of admission for distribution amongst their friends at the following rates—twelve 1s. tickets, 10s.; or six for 5s.

Sixteen fruit and floral meetings have been held at the Drill Hall, besides those held at Chiswick, and lectures have been delivered at fourteen of them. The number of awards has been as follows:—On the recommendation of the Floral Committee, forty first class certificates against fifty-four in 1889, 117 awards of merit against eighty-four, two commendations against three last year. On the recommendation of the Orchid Committee, fifty-six first class certificates against twenty-seven last year, forty-five awards of merit against seven, nine botanical certificates against twelve. On the recommendation of the Fruit and Vegetable Committee, six first class certificates against seven, and seven awards of merit against three last year. The Society's great Show held (by the renewed kindness of the Treasurer and Benchers) in the Inner Temple Gardens, and opened by His Royal Highness the Prince of Wales, was a greater success than ever, alike in the number of visitors, the quantity and quality of the exhibits, the propitiousness of the elements, and the consequent pecuniary result. The best thanks of the Society are due to all who so kindly brought their plants for exhibition or otherwise contributed to the success of this Show.

The Society's general work of scientific experiment and investigation, and of the practical trial of various plants, has been going on steadily at Chiswick, under the superintendence of Mr. Barron. Trial has been made of 104 varieties of Lettuce, twenty-five of Endive, thirty-three of Celery, thirty-six of Leeks, and thirty of Broad Beans. Thirty-

four new varieties of Potatoes, twenty-three new Peas, thirty new Tomatos have been tested. In the floral department 415 varieties of Carnations and Picotees, 354 Dahlias, fifty-eight Ivy-leaved Pelargoniums, seventy Violas and bedding Pansies, 112 different strains of China Asters, and thirty-two of Stocks have been tried. A very large collection of perennial Asters (Michaelmas Daisies) and Sunflowers have been received in view of the projected conference upon them in October, which will prove of the greatest possible interest, and will, it is hoped, serve to clear away the great existing confusion in their nomenclature in different parts of the country. The experiment of opening the gardens on Sundays, which was commenced in 1888 for the sole purpose of giving such Fellows as are fully occupied during the week an opportunity of visiting them for scientific or practical purposes, has again, as it did the year before, proved unsuccessful in that particular direction; it has therefore been decided to abandon it, as it not only throws additional work on the officials on their one rest day in the week, but also entails considerable expense on the Society which can ill be spared from the general work of the gardens.

The Society's "Journal" has been continued so as to enable Fellows at a distance to enter more fully into and reap the benefits of the study and work of those more actively engaged at the centre. Three parts, forming vol. xii., 707 pages, with forty-two plates of new plants, &c., have been published during the twelve months, and letters are constantly received from the most distant and diverse sources testifying to the Fellows' appreciation of this renewed branch of the Society's work.

The Council wish to repeat verbatim one paragraph of their last year's report, which runs as follows:—All these conferences and meetings, and especially the work and maintenance of the Chiswick Gardens and the publication of the "Journal," have involved the Society in a very large outlay, and the Council take this opportunity of endeavouring to impress upon Fellows the absolute necessity there is for them all individually (as many as have the Society's welfare at heart) to endeavour to secure new Fellows to the Society if its work is not only to be continued at its present standard, but still more so if the ever-opening and extending opportunities of usefulness are to be embraced and accepted. The adoption of £1 1s. as one rate of subscription was, no doubt, a popular movement, but the Council desire to remind the Fellows that such a low rate of Fellowship can only be self-supporting if it draws into the Society a very large number (far larger than at present exists) of additional Fellows. The Council, therefore, venture to express the hope that every Fellow of the Society will endeavour to obtain at least one new Fellow during this present year. A statement of the privileges of Fellows and of the aims and objects of the Society, together with a form of nomination to Fellowship, is for this purpose enclosed with this report.

The following table will show the Society's progress in regard to numerical strength during the past year:—

DEATHS IN 1890.			FELLOWS ELECTED IN 1890.		
	£	s. d.		£	s. d.
Life Fellows	6	0 0 0	4 guineas	4	4 0
4 guineas	0	0 0 0	2 "	2	10 0
2 "	8	16 16 0	1 "	3	9 0
1 "	5	5 5 0	Associates	1	0 10 0
			Affiliated Societies ..	8	10 10 0
	19	£22 1 0			
RESIGNATIONS.					
	£	s. d.		£	s. d.
4 guineas	3	12 12 0	New Fellows, &c.	44	£530 3 6
2 "	19	39 18 0	Deduct loss		94 10 0
1 "	19	19 19 0			
	41	£72 0 0	Net increase in income		£463 13 6
Total loss	60	£91 10 0	New Fellows, &c.		424
			Deduct resignations and deaths		60
			Increase in number of Fellows		334

The most notable feature in the past year's work has been the excellent commencement made for raising a fund for obtaining for the Society more suitable and worthy premises, and for building a horticultural hall to meet the requirements with regard to light and space and position, not only of our own Society, but also of the numerous kindred associations of this great metropolis. A scheme for the purpose was put forth in the spring, by which it was proposed to borrow, without interest, from those willing to so lend it, a sum of £40,000, part of which was to be expended on the buildings and part placed in the hands of trustees to safeguard the annual ground rent, the principal being, it is hoped, gradually repaid to the lenders by annual drawings out of the assets accruing from the rent paid to the Trustees by the Society, and by other kindred associations using the buildings, and by occasional lettings. The Trustees are Sir Trevor Lawrence, Bart., Bart., M.P.; Baron Henry Schröder (to whom we are indebted for the scheme), and Everard A. Hambro, Esq. The response made to the scheme was at first very promising, and half the amount required was promised during the ensuing summer, but owing to circumstances connected with the condition of financial matters generally it was thought advisable in the autumn to allow the appeal to rest for at least six months, but it is hoped to resume active operations again as soon as the present spring is advanced.

In conjunction with the Lindley Library Trustees, the Society's library has received considerable attention. All serial publications have been kept up to date, a large number of untidy but valuable volumes have been bound, and the following books amongst others added to the library, viz.:—"Annales des Science Naturelles," six vols.; "Nuovo Giornale Botanico Italiano," twelve vols.; "Revue Horticole," "Köhler Medizinal Pflanzen," "Nyman Conspectus floræ Europææ," "Pflanzen-Familien," "Baillon Dict. Bot.," "Archives Nouvelles du Muséum."

d'Histoire Naturelle," "Icones Plantarum," "Amaryllideæ," &c. The best thanks of the Society are due to all those who either at home or abroad have so kindly and liberally presented books to the library or plants or seeds to the Gardens. Special thanks are due to those who have so kindly contributed Perennial Asters and Sunflowers in view of a much needed Conference on them in October. A list of the donors has been prepared, and will appear in the next number of the "Journal."

The Council also wish to express, in their own name and in that of all Fellows of the Society, their great indebtedness to all who have so kindly contributed, either by the exhibition of plants, fruits, flowers, or vegetables, or by the reading of papers, to the success of the Conferences and fortnightly meetings.

The hearty thanks of the Society are due to the Chiswick Board and to all the members of the Standing Committees—viz, the Scientific, the Fruit and Vegetable, the Floral, the Orchid, and the Narcissus Committees, for the most kind and patient attention which they have severally given to their departments; also to the exhibitors who have contributed to so great an extent to produce the magnificent results of the Daffodil, Carnation, Fern, Dahlia, and Grape Conferences.

The Council have the sad duty of recording the death of nineteen Fellows during the year, and amongst them they deeply regret to find the names of Messrs. Wildsmith, MacIntosh, Haughton, Williams, Holmes, Deal, and Shirley Hibberd, Miss North and Miss Owen. The loss the Society has sustained in this manner has been unusually great, not in numbers, perhaps, but in the relative importance of the gaps left in our ranks. Messrs. Wildsmith, Deal, and Hibberd, and especially the last named, having been most energetic and loyal supporters of the Society and themselves active workers in all its undertakings.

During the past three years the Council have amongst other matters been considering methods of interesting amateurs more in the Society and its work, and of rendering to them a greater personal return for their subscriptions. To this end they have already established the fortnightly lectures, and the great Temple Show; have promoted various Conferences on interesting horticultural subjects; and have revived the publication of the "Journal." They have now further decided to revive the Society's ancient custom of offering prizes to amateurs, a long schedule of which has been already circulated in the "Arrangements for 1891." The Council cannot afford, with the very limited funds at their disposal, to embark on any very comprehensive scheme this year, but if this new departure should meet with general approval they hope that the Fellows themselves will, by subscriptions to the "Prize Fund for 1892," enable them next year to set forth a much fuller schedule.

Another revival during the past year has been the scheme of affiliation with local societies, and the Council would feel greatly obliged if Fellows who take an interest in the affairs of any local horticultural societies would use their influence to secure co-operation in this way.

It has been decided to hold a Conference at Chiswick on Conifers during October, which it is hoped will prove unusually interesting, not only as drawing attention to the best of these trees and shrubs from a garden or landscape point of view, but also demonstrating the best varieties to plant for English-grown timber as well as the different uses and suitabilities of the various foreign-grown timbers. The unusually hard winter through which we have just passed will prove a most practical commentary on the hardiness of the different varieties. The co-operation of landowners and others who may have planted these trees or shrubs in past years, or who take a present interest in them, is specially invited.

ANNUAL REVENUE ACCOUNT FOR THE YEAR ENDING 31ST DECEMBER, 1890.

DR.	Cash Paid.	Debts Payable.	Totals.
£ s. d.	£ s. d.	£ s. d.	£ s. d.
TO ESTABLISHMENT EXPENSES—			
Salaries and Wages	305 8 10		305 8 10
Rent of Offices	93 3 0	33 15 9	123 18 9
Printing and Stationery	174 16 2	70 0 2	184 16 4
Publications—Journals, &c... ..	315 4 1	134 9 5	449 13 6
Postage	64 4 4		64 4 4
Coal, Gas, and Water	4 2 1	0 15 9	4 17 10
Miscellaneous	133 2 8	1 1 3	124 3 11
Library	7 10 0		7 10 0
			1274 13 6
„ SHOWS, MEETINGS, and CONFERENCES—			
Rent of Drill Hall and Cleaning	65 5 0	32 17 0	98 2 0
Special Shows—Temple	438 14 7		438 14 7
Others	68 16 9	5 10 0	74 6 9
Advertising	23 11 0	3 17 9	23 8 9
Prizes and Medals	77 10 11		77 10 11
Floral Meetings and Conferences, Printing, &c... ..	38 7 5		38 7 5
Do. Labour	90 2 4		90 2 4
Superintendent of Flower Shows.. ..	50 0 0		50 0 0
			893 12 9
„ CHISWICK GARDENS—			
Rent, Rates, Taxes, and Insurance	293 7 9	60 2 6	353 10 3
Superintendent's Salary	225 0 0		225 0 0
Labour	676 8 10		676 8 10
Manure, Implements, &c.	59 7 9	4 7 0	63 14 9
Coal and Coke	129 0 2	50 11 11	179 12 1
Repairs	100 5 2	11 14 0	111 19 2
Water and Gas	13 6 4	0 16 1	14 2 5
Miscellaneous	74 14 11		74 14 11
			1699 2 5
„ HORTICULTURAL HALL—	66 16 10		66 16 10
„ SUBSCRIPTIONS for 1889 unpaid written off			21 0 0
Paid Creditors, 31st Dec., 1889	772 4 11		
Balance at Bank, 31st Dec., 1890	156 3 8		
Petty Cash in hand	3 3 4		
„ BALANCE TO GENERAL REVENUE ACCOUNT			147 1 11
	£4518 18 10	£346 18 7	£4102 7 5

CR.	Cash Received.	Debts Receivable.	Totals.
£ s. d.	£ s. d.	£ s. d.	£ s. d.
BY BALANCE AT BANK, 1st January	400 6 3		400 6 3
In hand	3 17 3		3 17 3
			404 3 6
„ ANNUAL SUBSCRIPTIONS, 1890	2387 13 1	21 0 0	2408 13 1
Do. do. 1891	87 3 0		87 3 0
„ SHOWS—TEMPLE—			
Tickets	£474 7 0		474 7 0
Advertisements	34 19 0		34 19 0
Donations	33 17 0		33 17 0
	540 16 0	7 7 0	548 3 0
„ MEETINGS AND CONFERENCES	48 18 0		48 18 0
„ ADVERTISEMENTS	82 2 3	52 6 0	134 8 3
„ MISCELLANEOUS			
Sale of Journal and Reports, &c.	45 11 1		45 11 1
„ DIVIDENDS—			
Davis Bequest and Parry Legacy	56 18 4		56 18 4
„ INTEREST ON DEPOSIT	11 4 11		11 4 11
„ PRIZES AND MEDALS	34 12 6		34 12 6
			3288 9 2
„ CHISWICK GARDENS—			
Produce Sold	525 16 3	98 5 5	624 1 8
Admission and Members' Tickets	3 2 0		3 2 0
Miscellaneous	8 3 0		8 3 0
Chiswick Horticultural Society	£36 0 0		36 0 0
Less Expenses	6 4 3		6 4 3
	29 15 9		29 15 9
„ STORING PLANTS	68 15 10		68 15 10
			743 18 3
„ DONATIONS ACCOUNT—			
Amount Transferred against Horticultural Hall Expenses	70 0 0		70 0 0
Received from Debtors 31st December, 1889	104 3 4		104 3 4
	£4518 18 10	£178 18 5	£4102 7 5

We have examined the above Accounts with the Books and Vouchers, and find the same correct.

(Signed) HARRY TURNER, HENRY WILLIAMS, A. H. PEARSON, Auditors.

13th January, 1891.

BALANCE SHEET, 31ST DECEMBER, 1890.

DR.	£ s. d.	£ s. d.	£ s. d.
TO SUNDRY CREDITORS			345 18 7
„ Subscriptions received in advance for 1891			87 3 0
„ DONATIONS—			
Balance of Account, 31st December, 1889	400 0 0		400 0 0
Less Transferred to Revenue Account	70 0 0		70 0 0
	330 0 0		330 0 0
Donations received During the Year	15 0 0		15 0 0
			345 0 0
„ GENERAL REVENUE ACCOUNT—			
Balance at Credit of that Account, 1st January, 1890		1649 13 2	1649 13 2
Add, Balance for the Year 1890, as per Annual Revenue Account		147 1 11	147 1 11
		1796 15 1	1796 15 1
			£2575 16 8
BY DEBTORS—			
Annual Subscriptions Outstanding		21 0 0	21 0 0
Garden Produce		93 5 5	93 5 5
Temple Show—Donation		7 7 0	7 7 0
Advertisement Schedules		52 6 0	52 6 0
		173 18 5	173 18 5
„ INVESTMENTS—2½ per cent. Consols, £2122 83.9d. cost			1892 11 3
(£2,022 88.9d. of this sum is held by the Society, subject to the provisions of the Will of the late J. Davis, Esq.)			
„ CASH AT LONDON AND COUNTY BANK—			
Current Account			153 3 8
„ PETTY CASH IN HAND			3 3 4
„ CASH AT LONDON AND COUNTY BANK on Deposit—Donation Account			345 0 0
			£2575 16 8

We have examined the above Accounts with the Books and Vouchers, and find the same correct.

(Signed) HARRY TURNER, HENRY WILLIAMS, A. H. PEARSON, Auditors.

13th January, 1891.

CULTURE OF GREENHOUSE RHODODENDRONS.

[Prize Essay read by Mr. R. G. WATERMAN, Woolton, before the Members of the Woolton Gardeners' Mutual Improvement Society, February 5th, 1891.]

RHODODENDRONS may be classed as amongst the most magnificent of all our greenhouse flowering plants. Take, for example, the noble proportions of R. Falconeri, which approaches 50 feet in height, with its enormous leaves from 15 to 18 inches in length, borne at the ends of the branches, or R. Nuttalli, one of the most gorgeous, producing umbels of nearly pure white fragrant flowers 4½ to 5 inches in length, with a like diameter, so distinct from the Balsaminæflorum varieties or double form, and the rich dark glowing red of the Duchess of Connaught. Their diversity of growth and their habit of flowering as regards form and colour, is also an additional mark in their favour. Whilst the beauty of Jasminiflorum recommends it to the skilful bouquetist, yet as an exhibition plant it fully maintains its own. R. Gibsoni, Countess of Haddington, R. Veitchianum, and others will prove weighty specimens amongst greenhouse plants, while the hybrids lend colour and distinctness to all collections. To properly consider the value of plants the season of flowering is of vital importance, and while we cannot claim special advantages for the plants under review, most of them open their lovely flowers in spring when flowers are valuable, while the Java section bloom at different periods of the year, and may be justly termed hybrid perpetuals.

The species of Rhododendron number upwards of a hundred, are

evergreen, and natives of Europe, Asia, the Malayan Archipelago, North America, and abundantly on the Himalayan Mountains. The flowers are produced from buds like Azaleas, scaly and conical, usually in terminal corymbs; corolla variable, often funnel or bell-shaped, as is Countess of Haddington, or salver shaped, as *R. fragrantissimum*, while the javanicum section are formed of a long tube opening into five lobes, or after the shape of *Stephanotis*. Among the earliest introductions was *R. maximum*, from North America, which was brought to this country in 1756, and so designated before the larger varieties were known. This forms an impenetrable thicket on many parts of the Alleghany Mountains. *R. formosum*, from the Eastern Himalayas, 1815. *R. javanicum*, from Java, 1847. *Jasminiflorum*, from Malacca, 1849, and in the year 1850 numbers of magnificent species were brought into commerce, including *R. Aucklandi*, *R. Falconeri*, *R. glaucum*, *R. grande*, *R. Maddeni*, and *R. Edgeworthi*, all from Sikkim, *R. Veitchianum* from Moulmein, and additions have been made from time to time since that date.

CULTURE.

We will now proceed to the cultural details, which have a greater practical interest to those who desire to possess specimens of health and beauty. It will hardly be necessary to describe the position or form of the house required. For specimens or bushes a span-roofed structure will be the most suitable where the plants may have abundance of light on all sides. A well-lighted conservatory or greenhouse where the plants are not kept too far from the glass, will prove satisfactory. I have already mentioned that some of the *Rhododendrons* grow to a large size, and these should be planted out in a thoroughly prepared border, with ample drainage, and the root-space somewhat restricted.

PROPAGATION.

It is desirable that some knowledge of the various methods of increasing the stock should be mastered by the cultivator. The most approved systems are by cuttings, seeds, and layers, and by grafting, the last-named being the means generally adopted by nurserymen and large growers. Budding and inarching may in some cases be pursued. Seeds, which are very small, may be sown in well-drained pans in sandy peat, with an extra sprinkling of sand on the surface to prevent the soil from becoming green or washed out. A slight covering with moss, or some similar material, will keep the compost in good heart and induce early germination. Sow seed about March, and when the seedlings are large enough they may be pricked out into pans or small pots in a similar compost. Prepare cuttings made from half-ripened wood and place them under bell-glasses or close frames until callused, after which a slight bottom heat will soon induce young rootlets. Layering is not usually adopted, whilst the grafting is more generally practised in early autumn, the plants being kept in close frames until the union is complete. Free growing varieties, either from cuttings or seeds, are employed as stocks.

(To be continued.)



ROSE SHOWS IN 1891.

THIS is a list of all the Rose Shows whose dates are as yet definitely fixed. The next list will appear early in March. In the meantime I shall be glad to receive any Rose show fixtures, not mentioned below, as soon as they have been arranged.

- June 23rd (Tuesday).—Westminster (N.R.S.).
- „ 24th (Wednesday).—Richmond (Surrey).
- „ 25th (Thursday).—Winchester.
- „ 30th (Tuesday).—Canterbury.
- July 1st (Wednesday).—Croydon.
- „ 2nd (Thursday).—Bath, Farningham, Norwich, and Woodbridge.
- „ 4th (Saturday).—Crystal Palace (N.R.S.).
- „ 7th (Tuesday).—Gloucester.
- „ 8th (Wednesday).—Sutton.
- „ 14th (Tuesday).—*Wolverhampton.
- „ 16th (Thursday).—Hereford (N.R.S.) and Helensburgh.
- „ 18th (Saturday).—Manchester.
- „ 21st (Tuesday).—Tibshelf.
- „ 23rd (Thursday).—Worksop.
- Aug. 1st (Saturday).—Ripley (Derby).

*This is a three-days Show, beginning July 14th.

—EDWARD MAWLEY, *Rosebank, Berkhamsted, Herts.*

WORKSOP ROSE AND HORTICULTURAL SOCIETY.

THE annual and general meeting of the Society was held last week, Mr. Henry Vessey Machin, J.P., the Vice-President of the Society, in the chair. Mr. Whall then read the balance sheet, which was as follows, showing the income £145 17s., and the balance to the good £30 15s. 3d. Mr. Walter Allen moved the report be adopted, and it was seconded and carried. The Chairman said it was the next duty of the meeting to elect officers, and he did not think they could do better than re-elect as President the Duke of Portland. This was seconded and carried. Mr. Whall said he could not do better than repeat the words of the Chairman, and say the meeting could not do better than re-elect Mr. Machin as Vice-President. This also was seconded and carried at once. The Chairman said it would be necessary for the meeting to fix at once the date of the next Show. There was nothing like being the first in the field, and it was urgent that they should get on the list of the National Rose Society's Shows. He had it in his head that Worksop was going to be one of the best for Rose shows in England. It was decided that the next Show of the Society be held on July 23rd. Commenting on the meeting the *Retford Times* states the chief honour in connection with the formation of the Rose and Horticultural Society rests with Mr. Machin, though he had more to do with the Rose section than with the horticultural. An ardent grower of the Queen of English flowers—an ardour which has been growing for years—he conceived the idea that Worksop and the district ought to possess a Rose Society, and also hold an annual Exhibition of the flower. His idea was only a Rose Show, but at the first public meeting at which it was decided to show Roses at Worksop he gave way at once to the majority, who wished to see the all-round produce of a well-kept and diversified garden alongside with Roses. The combined Show was really only a Show of Roses, and a magnificent one. The Exhibition was, in fact, too early for anything but Roses; but this year the Exhibition will be a fortnight later than it was last year, and if the season is right the Show will be doubly good.

UNITED HORTICULTURAL BENEFIT AND PROVIDENT SOCIETY.

THE annual meeting of this excellent Society was held at 8 P.M. on Monday last, February 9th, in the Caledonian Hotel, Robert Street, Adelphi Terrace, Strand, when there was a large attendance of members. James H. Veitch, Esq., occupied the chair, and proved himself in every respect an admirable Chairman, speaking thoughtfully yet fluently, and conducting the business throughout in a manner highly satisfactory to all present.

The proceedings were commenced by the Secretary, Mr. W. Collins, reading the minutes of the last annual general meeting. This was followed by the report of the Committee, by the accounts for the year of the Benefit, Benevolent, and Management Funds, also read by the Secretary, and by the Treasurer's account, read by Mr. J. Hudson. The report is appended, also the chief items of the four accounts named.

REPORT FOR 1890.

The Committee again have very great pleasure in presenting the annual report and balance-sheet to the members, the Society being in a very flourishing condition, both numerically and financially. It is clear that the advantages of this Society are being more widely known and appreciated, seventy-four new members having joined during the past year, the greatest number obtained in any previous year. The Society now numbers 369 benefit members, including six elected to-night.

The sick list is a rather long one, owing in great measure to the prevalence of the influenza epidemic in the early part of the year; thirty-two members received sick pay, the total amount paid being £64 7s. 2d. This amount is covered by deductions of 4s. 6d. and 3s. 0½d. from the two classes of members' deposits. One death has occurred during the year, that of the late Mr. William Back of Tottenham. The amount standing to his credit in the books of the Society—viz., £25 10s. 3½d., was paid to the widow; in addition to which a Singer sewing machine was purchased for her (the result of an appeal for assistance from Mrs. Back) at a cost of £5 3s. 6d. The amount was paid from the Benevolent Fund.

The balance in favour of the Benefit Fund is £4222 4s. 9d. Members' subscriptions during the past year amounted to over £500.

The Benevolent Fund shows an increase of £154 8s. 1½d., 10 guineas of this amount being paid by the Thames Bank Iron Company as a life membership, the total amount of the Fund being £1561 2s. 11d. The Management Fund is also very satisfactory. The receipts, including those of the annual dinner, amount to £132 2s. 6¼d., and the expenditure to £103 13s. 6d., leaving a balance in favour of the Fund of £28 9s. 0¾d. The Treasurer's account is highly gratifying, the total funds invested being £6000. The annual dinner was again a success, being the means of adding eleven more names to the list of honorary members, and Messrs. Rothschild & Sons very generously gave a donation of £25 towards the Management Fund.

The best thanks of the members are due to Messrs. B. S. Williams and Son and J. Laing & Sons, who very kindly sent plants for decoration of the Hall; to Messrs. H. Cannell & Sons for their beautiful Begonia flowers, also to Mr. J. R. Chard, Stoke Newington, whose new Arcadian style of table decoration was the admiration of all.

The best thanks of the members are also due to the Treasurer, Trustees and Auditors for their continued valuable services to the Society.

The Benefit Fund shows that the receipts, including the balance for last year of £3478 18s. 11½d., were £4328 12s. 1½d. The expenditure under the same head, including sick pay to thirty-two members, was £106, leaving a balance of £4222 4s. 9d.

The Benevolent Fund gives a total under the head Receipts of £1566 6s. 5d., including balance in hand from last year of £1416 14s. 10½d. The expenditure was only £5 3s. 6d. for a sewing machine given to the widow of the late William Back, the balance being £1561 2s. 11d.

The Management Fund receipts were £132 2s. 6¾d., the balance from last year being £21 13s. 1½d. The expenditure was £103 13s. 6d., leaving a balance of £28 9s. 0¾d.

The Treasurer's account shows a balance for last year of £134 15s. 11½d., subscriptions of benefit members £621 9s. 9d., arrears of 1889 £9 15s. 9d., and of honorary members £59 17s., with other items amounting to £1036 8s. 6½d. The expenditure included purchase of £700 stock, 2¾ per cent. Consols for £680 16s. 3d., payments to sick members £64 7s. 2d., to Management Fund £34 19s. 6½d., annual dinner expenses £48 13s. 11½d., and other items, leaving a balance of £75 19s. 7d.

Mr. James H. Veitch then rose to propose the adoption of the report and balance-sheet, and made a capital speech concerning the work and

after a member had ceased paying his subscription for a certain period the interest on his deposit was no longer placed to his account, but transferred to the Benevolent Fund. Mr. Hudson had proposed the application of this interest to the Management Fund. It was adopted and has considerably increased the working power of the Society. In regard to the number of members the results were similarly satisfactory, for in 1880 there were only eighty-three on the books, now they were rapidly approaching 400, and seventy-four had been elected during the past year. The honorary members had similarly increased from seven in 1880 to sixty at the present time, with four life members; and the Messrs. Rothschild had not only contributed liberally to the funds but had consented to become patrons of the Society. The Chairman next pointed out the great and important differences between the United Horticultural and ordinary benefit societies. First, the member never loses his deposit, even though he ceases paying; and secondly, the interest on his deposit will in time reduce the amount of his subscriptions to a very small sum, or, indeed, extinguish it entirely. It had been suggested that under certain restrictions it might be desirable to institute a higher scale of contributions—namely, 4s. per month, but before that were adopted several details would require consideration, though it might be desirable in some respects. He concluded by



FIG. 26.—FICUS STIPULATA, FRUITING AND BARREN BRANCHES.

advance of the Society. No one, he said, could doubt from the reports they had just heard read that the Society was in an extremely satisfactory condition, and that it offered great advantages to the members. But he added that as Mr. J. Wright, who held the post of Chairman last year, gave so exhaustive a summary of the details connected with the work and scope of the Society, it was not necessary to dwell upon this at any length. There were a few points upon which he would like to make remarks, and these referred more particularly to the progress effected within the past eleven years. With regard to the Benefit Fund, it would be noticed that the balance had increased from about £1000 to over £4000. It offered advantages over ordinary benefit societies, inasmuch as the money not disbursed in sickness accumulated with interest, each member's account being kept separate. One had died during the year, his amount of £25 being paid to his widow. The Benevolent Fund was largely made up of donations secured at the annual dinner, and was of great utility to members, as after they reached the age of seventy years a sum could be voted to them from this fund; also, after a member had been in receipt of sick pay for twelve months a further sum could be voted for assistance. In the case of any member dying, too, in necessitous circumstances, the widow could be helped from this fund, and they had an example of this in the past year, when a sewing machine was presented to the widow of one of their late members. A great advance had also been made in this fund, as in 1880 the balance was just over £700; this year it was over £1500. The Management Fund was the weakest part of the Society's accounts, but that has been much improved by a suggestion of the Treasurer's. It was the rule that

recommending that all gardeners should give the advantages of the Society close consideration, as it was excellent and sound in all its respects, and moved that the report and balance-sheet be adopted, printed, and circulated. This was duly seconded, and carried unanimously.

The next business was the election of four members of the Committee, with one to take the place of Mr. Chard, who has resigned, and only five being nominated the following were duly elected: Messrs. G. W. Cummins, Lewis Castle, W. Foreman, C. W. Knowles and H. Peerless. Mr. W. Collins was unanimously re-elected Secretary, and Mr. J. Hudson Treasurer. Votes of thanks were accorded to the Committee, the Auditors, the Horticultural Press, and the Chairman, the latter's response bringing the proceedings to a conclusion.

FICUS STIPULATA FRUITING.

WE have received from Algiers a specimen of what is usually known as *Ficus repens*, but which is really *F. stipulata*, bearing well-developed fruits and leaves quite different from the ordinary barren type. It comes from Rocher, the original home of the Japanese Chrysanthemum, Gloire de Rocher, figured in this Journal last November, and has been forwarded to us by Mr. Charles Gibson of Morden Park Gardens. The appended illustration (fig. 26) fairly represents its chief characters, but was prepared by Mr. Burbidge from a plant that fruited in Ireland about ten years ago. In the specimen submitted to us the fruits and leaves were rather larger than those depicted, and the plant is said to

grow with the greatest luxuriance out of doors. In England plants have often grown through the crevices of houses and extended on the walls, enduring ordinary winters without injury. At the Royal Botanic Society's Gardens, Regent's Park, an instance of this kind may be seen, and even the past severe winter does not seem to have killed the plant.

FLORAL DECORATIONS IN BIRMINGHAM.

THE Mayor of Birmingham gave a fancy dress ball on the 5th inst. in the Council House, and the floral decorations were entrusted to Messrs. Wills & Seagar of Onslow Crescent, London, and a lavishness in execution with refinement of taste was apparent throughout. From the entrance hall of the Council House, up the grand staircase and in the corridors were superb Palms and flowering plants, and the large reception and other rooms were most tastefully decorated. Some idea may be formed of the magnitude of the decorations from the fact that eighteen railway trucks were required for the transit of the plants from London, in addition to a quantity obtained from the Solihull Nurseries, Messrs. Hewitt & Co. and their manager, Mr. Spinks, lending valuable help. Many large specimen Kentias and other handsome Palms were abundant, many of them from 8 to 12 feet high, and Messrs. Wills & Seagar had obtained from Cannes a large supply of cut Bamboo in full foliage, many stems of which were from 15 to 20 feet in height. These proved of the greatest value for decorative work, their light foliage and graceful form aiding so much to artistic decoration. Cut branches and leaves of other Palms, including the Sago Palm, and large fronds of Tree and other Ferns were also obtained from Cannes, and were most effectively used. A long corridor leading from the Council House to the Art Gallery was artistically dealt with, and this was called the "Haarlem Garden," as some thousands of Tulips and Hyacinths were used there.

Throughout the building were provided a large number of zinc trays painted green, measured for and made to fill in windows, niches, and other places where a group was wanted, and when it was advisable to prevent injury from water. It was a wise arrangement, and enabled the decorators to work in a quantity of cut Orchids, Lily of the Valley, and other flowers, as well as Orchid plants, rising from sloping beds of Ferns and Lycopods. One of the ante-rooms was fitted as a hanging garden, and from the centre of the ceiling to the sides were tasteful festoons, with large half-globes of double scarlet Pelargonium blooms suspended from the wreaths. Handsome groups of plants were also placed in suitable positions. In one room was a large hanging bell, composed of 200 dozen bunches of double scarlet Pelargonium flowers, with a base of Richardias, and in various devices, at least a thousand dozen bunches of double scarlet Pelargonium flowers were used.



FRUIT FORCING.

VINES.—*Eyes and Cut-backs.*—Eyes may now be inserted, using pots, pans, or square pieces of turf. Select firm well ripened wood, filling the pot or pan with rich friable loam, inserting the buds with a pinch of silver sand half an inch beneath the surface, plunging the pots in a bottom heat of 80°. Cut-backs should be placed in a house where they will have a temperature of 60° to 65° at night, and 70° to 75° by day. When they have started into growth shake them out and return them to the same size pot, using good friable loam, providing a moist and rather close atmosphere until they are re-established, when they should have a position near the glass, so as to insure sturdy, short-jointed, thoroughly solidified growth.

Early House.—The Vines in flower must have a temperature of 60° to 65° at night, and 70° to 75° by day artificially; but Muscats need 5° more both day and night. Keep the atmosphere somewhat drier by free ventilation, leaving a little air on at night; yet a genial condition of the atmosphere must be insured by keeping the floors sprinkled three times a day during bright weather. Any shy-setting Grapes may have the pollen distributed by a camel's-hair brush. Stop the laterals at the first leaf, and keep those stopped to one joint throughout the season, but those beyond the bunch may be allowed to make two or more joints, provided there is space for the full exposure of the foliage to light and air. Avoid overcrowding the foliage, it is better to reduce the laterals than do that, yet the fruit retained must be proportionate to the amount of foliage. Heavily cropped Vines make correspondingly little growth, and the Grapes frequently do not colour, because there is not sufficient chlorophyll stored for conversion at the time of ripening into the essential purple or amber colour. Reduce the crop when necessary, so as to have more growth in the laterals, and so keep the roots active, thereby maintaining a good supply of nutriment.

Vines Started at the New Year.—These Vines are in leaf and showing fruit, but do not be in a great hurry in disbudding, and let it be done gradually, removing the weak and least promising growths in the first instance, then give further attention when it is seen which

shoots are likely to afford the best bunches. One bunch on a spur is as much as is likely to finish satisfactorily, but if there be space, the spurs being widely distant along the rod, two shoots may be left, it being clearly understood that only one is to be allowed to carry fruit, the duplicate only remaining until choice can be made of the best, and in case of two shoots being left one ought to be near the main rod, to keep the spur as short as possible. Weakly Vines, however, may be allowed more space, so as to secure stouter wood, larger and plumper eyes, and better bunches in future. Give the needful attention to outside borders in protecting them sufficiently to prevent chill by heavy rain or snow.

Vines to Afford Grapes in July and August.—The Vines must now be started. They break most evenly and strongly when assured a moist genial atmosphere, therefore damp the rods three times a day, and sprinkle other surfaces. Avoid, however, keeping the rods constantly dripping with water, for the tendency in that case is to cause the emission of aerial roots, which are unsightly, if, indeed, they are not prejudicial in appropriating the stored up food which otherwise would be expended on the formation of roots in the border or go towards invigorating the growth. A temperature of 50° at night, 55° by day, and 65° from sun heat is suitable until the buds begin to move. Bring the inside border into a thoroughly moist condition by repeated watering with tepid water, and if the Vines are weak afford a supply of liquid manure, not before moistening the border, but after it is watered sufficiently for healthy growth. The soil having a strong affinity for the manurial elements will grasp and retain them for taking in by the roots as required. Afford outside borders sufficient protection to prevent chill, a little stable litter or other partially decayed material being all that is required. Eschew thick coverings of manure, particularly when likely to settle into a close soapy mass, giving preference to lumpy, which will admit of the free access of air.

Late Houses.—Assuming that the Vines were cleared of the Grapes early in January, and that the inside borders have been top-dressed with fresh loam and steamed bone-meal, which though less nitrogenous, is sooner indeed available within the current year as plant food, a good supply of tepid water should be given, and a start made without much farther delay, as it is essential to the Grapes keeping well that they be ripened thoroughly by the middle of September. Keep the strong rods in a horizontal position, and insure an even break by syringing three times a day. Let the temperature be kept at 50° to 55° at night and on dull days, until the buds move, then allow 5° to 10° more by day, and an advance of 5° or more from sun heat, but lose no opportunity of ventilating freely.

Ripe Grapes.—Avoid fire heat as much as possible in the Grape room, admitting air to prevent an accumulation of moisture, replenishing the latter with clear soft water as required. An equable temperature of 45° is most suitable.

New Borders.—The compost for new or renovating old Vine borders should now be prepared, and the best for the purpose is the top 3 or 4 inches of a pasture, rich and friable, and in nature neither very light nor very heavy. It, however, is better rather strong than light. As that is not always obtainable light soil may have an addition of clay marl, heavy loam, and old mortar rubbish, about a sixth in each case. Loam is best obtained where it thinly overlies limestone and is of medium texture. To good friable loam add a tenth of old mortar rubbish broken small, removing every particle of wood, such as laths, &c. To all add some charcoal in lumps, from a hazel nut to a hen's egg, about half as much as the mortar rubbish, and a similar proportion of calcined oyster shells. Crushed bones may be added, but they are slow in action. Bones are not so much used as formerly in their enduring state, but are reserved for dressings to the surface, applying only in time to benefit the current crop. Chalk is also a good application to light soil, but quicklime to the extent of a tenth is preferable for heavy soils. If the soil be poor a fifth part of short fresh stable manure or horse droppings may be added, otherwise manure in most cases is best applied as a mulch.

In preparing the border, which may be proceeded with as the weather permits, bear in mind that no fruit tree requires more copious supplies of water when in growth than the Vine, and at the same time is more impatient of stagnant water; hence drainage should receive first attention, and instead of excavating, concreting, and cementing, keep the border well elevated as far as circumstances admit. Employ 3-inch drains with proper fall and outlet. Provide a foot of drainage, the roughest at the bottom and the smallest at the top, which last preferably to a depth of 3 inches may be old mortar rubbish. If the border is intended for early or late Vines, allow a rather sharp slope to the south or front for the purpose of throwing off the rain by means of tarpaulin and shutters. The proper time for planting Vines is from April to June inclusive, and those that are to be planted at that season should now be cut back to the length required, and be placed in a cool Peach house or pit to start into growth, and when the new shoots are 1 to 2 inches long shake out the plants, and plant them in the permanent borders. A width of 6 feet will be sufficient in the first instance. Where the Vine roots are to have the run of both outside and inside borders, confine them to the inside, not making the outside border until the Vines are thoroughly established.

FIGS.—*Earliest Trees in Pots.*—The trees started in November for affording ripe Figs early in May will be throwing out fresh roots plentifully, the bottom heat being kept steady at about 70° to 75°. Bring up the fermenting materials to the rim of the pots, and instead of allowing the roots to come over the top of the pots to ramble unchecked into the fermenting materials, place pieces of rich turf of good size round the

rims to keep the roots close and to induce sturdier growth. Provide plenty of moisture in the atmosphere by syringing twice a day, and damping as may be required in bright weather. Admit a little air at 70°, increasing it with the temperature; close at 75°, and if the temperature rises to 80° or 85° from sun heat it will be an advantage. See that there is no lack of water at the roots. The drainage being good there is little danger of giving Figs too much water, many crops being lost by keeping the trees too dry. The temperature in dull weather must range from 60° to 65°, 55° to 60° at night, when the external air is cold, but 5° higher when the weather is mild. Disbudding will need to be attended to as growth advances, and gross shoots must be stopped, but the finest Figs are borne upon extensions. Shoots, however, should be pinched where necessary to prevent a straggling habit at the fifth or sixth leaf; but avoid crowding the trees with foliage, keeping them sufficiently open to admit light and air to every part.

Early Forced Planted-out Trees.—The trees planted in inside borders and started early in the year will, if the borders have had repeated waterings at a temperature slightly in advance of that of the house, be starting into growth, and may have the night temperature raised to 55°, 60° or 65° by day from fire heat, with an advance from sun heat and free ventilation to 70°, or even 75°. Syringe twice a day as before advised, but in dull weather damping along with an occasional syringing will be all that is necessary. See that the borders are properly moistened. If the trees are weak a thorough soaking with liquid manure, not too strong, at a temperature of 85° to 90°, will assist the growth and root action, which must be encouraged by surface dressing with rather lumpy manure, but not thick, a couple of inches thickness being ample.

PINES.—Fruiting plants and starters, which will now be throwing up fruit, should have a mean temperature of 70°, varying it 5° according to the weather, admitting air at 80° with sunshine, but not lowering the temperature, allowing it to rise to 85°, closing between that and 80°, and if it rise somewhat after closing it will be an advantage. The plants recently started into fruit will, if in good condition at the roots, produce strong suckers; when the suckers are large enough all, except one to each plant, must have the growth checked by taking out the centre. To supplement the autumn-potted plants select others which have been wintered in 7 or 8-inch pots, choosing the most vigorous. Those remaining may be reserved until the general spring potting, when they can be shaken out and treated similarly to suckers.

Good fibrous loam with the turf well reduced, placed under cover to become dried, is a suitable compost. Drain the pots well, dust soot or dry wood ashes over the drainage to exclude worms, and ram the soil firmly about the plants, keeping them well down in the pots to admit of copious supplies of water being given when necessary; 10-inch pots are suitable for Queens, and 11 or 12-inch pots for those of more robust growth. A temperature of 60° to 65° will be sufficient for these plants, also those potted last autumn, and about 85° bottom heat.

Plants about to be started in beds must not have the heat at the base of the pots over 90° to 95°, or their roots will be injured. If sufficient fruit be started to meet the requirements late successional plants that have not been subjected to a high temperature may be advanced slowly, they with autumn suckers requiring careful watering, especially when the heat at the roots is supplied by fermenting materials, those having it supplied by hot water requiring more frequent attention.

PLANT HOUSES.

Zonal Pelargoniums.—Cuttings will root freely in a temperature of 60° if inserted singly in small pots of sandy soil. Select sturdy shoots from plants that have been kept cool. Weak cuttings drawn up in heat are almost certain to damp. Cut back plants from which cuttings have been taken and keep them rather dry until they break again into growth. They will start freely in a temperature of 55°. Repot sturdy plants that have been wintered in 3-inch pots into others 2 inches larger. Press the soil firm into the pots, and use for a compost good loam, one-seventh of decayed manure and sand. Water the plants carefully at first, and place them in a temperature of 55°.

Ivy-leaf Pelargoniums.—Propagate these as advised for Zonal Pelargoniums. Plants wintered in 4-inch and 5-inch pots may be placed into 8-inch pots. If large, plants can be accommodated during the summer months in any light airy structure. If they can be trained up the rafters of a greenhouse from the middle of May they will yield quantities of flowers for cutting. The semi-double varieties are invaluable for this purpose. Do not shade them, even during the brightest weather, or they will fail to flower profusely.

French and Fancy Pelargoniums.—Repot all that need more root room in the compost already advised, and place them where they can have abundance of air. Pinch the points out of all plants not needed for flowering early. The early cuttings must be well rooted in the pots in which they are to flower. Apply a little artificial manure to the surface of the soil, and allow the shoots to extend until they flower. Water these occasionally with clear soot water. Plants that were rooted late may be transferred to 5-inch pots if they are well rooted in the small size they first occupied. From old plants retained for yielding cuttings shoots may be removed and inserted at once. They will root freely in a temperature of 60°.

Oak-leaved Pelargoniums.—These are very useful for associating with flowers in a cut state. Cuttings root freely at this season of the year in heat, and quickly make good plants with bold foliage if repotted. Old plants that have been cut back will soon start into growth if placed into gentle heat until they are started, and then repotted. It is a good plan to prepare a few plants for planting out for the summer supply.

Gladioli Colvillei The Bride.—Where these are grown in quantity it is a good plan to sort them at this season of the year, and place a portion in a cool airy structure. Those that are gently forced are very useful, but those brought forward under cool greenhouse treatment make handsome plants, and produce quantities of flowers of large size and substance. This is well worth growing in quantity, both in pots and in the borders outside.

Anemones.—Anemones have been kept cool during the winter, and they are now growing rapidly, showing their flowers in quantity. Give them a light cool airy position or the foliage will be drawn up weakly. Soot water in a clear state will be found very beneficial.

Hydrangea hortense.—Plants cut back in autumn for yielding good cuttings early are now being started into growth.

Lilacs.—Small plants that have flowered in 6 and 7, or even larger pots, are pruned close back and placed in a cool house. If the plants are established in their pots, and are well cared for after they are pruned, they will make strong growth and flower again another year. Rhododendrons of the *præcox* type and *Azalea mollis* that have flowered should be kept in cool frames or late Peach houses until they can be thoroughly prepared for placing outside.

Bulbs.—Examine the latest bulbs that were potted, and remove them from the ashes in which they have been plunged to cold frames. Admit light to them gradually until they are green, and then ventilate abundantly.

Richardias.—Young plants raised and kept in boxes throughout the winter may be potted singly in 5-inch pots and placed in a vinery or Peach house. These will prove useful for planting out in May, and will thus be ready for lifting early, and produce spathes freely during the months of November and December.

THE BEE-KEEPER.

APIARIAN NOTES.

THE PAST WINTER.

IF we could have chosen the weather we could not have had it better for wintering bees. The almost entire absence of snow with dry frosty days and frequent mild weather in this locality is a wide contrast to what it was in some places not more than fifty miles distant. This favoured the bees in every respect, so much that I have never seen nor heard of bees passing a winter with less loss of life.

January 18th was the most wintry day we experienced the whole season. The thermometer on that morning stood at 14°—certainly not low, but the wind was of a most piercing nature, which must have been trying to bees in damp hives, or where they were exposed to a draught. This is more or less the case when they have an empty chamber beneath the combs, aggravated when there is an inner and outer doorway, which arrangement causes a greater draught than is necessary with all its evil influences. To test the accuracy of these remarks make a few divisions of glass similar to hives in use, with arrangements having a small lamp in lieu of bees, then force in smoke on a moderate windy day, and the issuing of the smoke will give the strength of the current.

FLOWERS AND PEAMEAL.

These are at the present at least five weeks later than they were in 1890, but there will be a quicker succession of them this year if the weather is seasonable, and will enable us in a great measure to dispense with peameal, which we have not supplied as yet, although on the 1st of February, after more than two months' confinement, I observed a number of bees fly direct from the hive to the peameal receptacle. As the utensil was perfectly free from odour memory alone was the cause of the search.

FEEDING.

The mild November was conducive to extra consumption of stores, which the severe hurricane of January 31st proved by the moving of some of the hives, but none was capsized. In order to prevent any mishap by want of food, and to save considerable labour uncovering them to ascertain their condition, I inserted a shallow trough in the entrance of every hive, where they may be fed with ease and speed according to their requirements. This is the most natural and in every respect the better way to administer food; but the thin spale of wood as a float must not be neglected

and bees take syrup in this way more quickly than by any other method.

DEAD BEES.

After the cold of January 18th I was prepared to find more dead bees than I had previous to that date, but I have been agreeably disappointed. Judging by their appearance all are in fine condition, and perhaps stronger than they were in December, as I have seen signs of young bees and but few dead. When inserting the feeder to one hive that had not its combs to the floor after the fashion of having an eke below, a fifty years behind practice, I was surprised to see what appeared a deep layer of dead bees, but on raking them out found less than a hundred, the bees having pushed them close to the front for easy removal when mild weather came.

In one district I visited lately there are many dead colonies having plenty of honey, which would not have occurred had the bees been located in narrower hives. The entire absence of damp on the ventilating floor, as well as filtering the cold air before it reaches the bees, is another of the reasons why our bees survive when others die. It is reaping the reward of putting into practice little matters that without attentive observation would never have been revealed.

PRESERVING BEES.

The advantage of preserving bees during winter gives their owners the opportunity of having early swarms, and very often a yield of honey from spring flowers, and a large surplus from summer ones, as well as having the full complement of young queens raised under the best circumstances and condition for the present and future year, giving the largest amount of profit possible which may accrue from bee-keeping.

MY APIARY.

One-half of my stocks are located in two divisions, while the others are in three, or what I term full-sized hives. The latter I shall work so far as I can control them to be non-swarmers, adding super after super, after I have made sure that sealed honeycombs do not obstruct the side passages. Should a swarm issue from any or all of them, they will be hived in the ordinary way, and the old stocks' royal cells will all be removed after the eighth day, and a young fertile queen added wherever practicable, and the surplus sealed honeycombs removed; then after a few days as the young bees begin to crowd the hive, supers will be placed on them. These, or such hives as these, are in the best condition for late Heather work. The first swarms will after a time have their old queen and surplus honey removed, and a young fertile queen introduced, these also being in the best trim for the moors. But should none of them swarm there will be only the old stock to deal with, which shall have their queens removed only, but no surplus honey except that in the supers. With the former I shall encourage early swarming, which may be in May, putting the swarms into two divisions, supering after a week or two depending on the weather.

The old stocks will be broken up and divided into as many nuclei as I may deem advisable to meet the wants of the apiary, with a percentage in excess, so that no hive of full strength may decline for want of a fertile queen. In all probability if the weather during summer is favourable there will be a large increase of swarms, involving the necessity of adding many together as far as practicable, will endeavour to keep all of equal strength and strong, for little can be gained by sending weaklings to the Heather.

PUNIC BEES.

These hardy and good workers are again in the ascendancy over other varieties, and if spared, and not disappointed in getting some pure queens, I mean to devote my spare time to watching their movements and studying their habits as well as that of raising a few pure queens, a thing becoming rare nowadays, but I hope that this ebony race in Scotch hands will be preserved in a pure state.—
A LANARKSHIRE BEE-KEEPER.



TO CORRESPONDENTS

All correspondence should be directed either to "THE EDITOR" or to "THE PUBLISHER." Letters addressed to Dr. Hogg or members of the staff often remain unopened unavoidably. We request that no one will write privately to any of our correspondents, as doing so subjects them to unjustifiable trouble and expense.

Correspondents should not mix up on the same sheet questions relating to Gardening and those on Bee subjects, and should never send more than two or three questions at once. All articles intended for insertion should be written on one side of the paper only. We cannot reply to questions through the post, and we do not undertake to return rejected communications.

Commission Agents (H. R. Q.).—We will make inquiries on the subject, but cannot promise to procure the information desired.

Named Hollyhocks (F. C.).—The best named varieties of Hollyhocks can only be obtained in the form of plants raised from cuttings, though good varieties are obtainable from mixed packets of seed saved from superior flowers.

Shortening Fruit Spurs (Inquirer).—Long spurs may be cut back as you suggest to buds nearer the main stem, discretion being exercised by the pruner, and it may not be the best plan to cut back the whole of the spurs the same season, but only some of them, thinning them out, so to say, and it may be done at the present time.

Woodlice (T. R. O.).—If you persevere in the methods you are adopting you will considerably reduce the numbers of the pests, and you may also try some rough, dry old dirty boards placed face to face, but not so closely as to prevent woodlice finding their way between them. Some persons have found this one of the best methods for effecting the purpose desired.

Pinus insignis—Mistakes (Somerset).—The word "spiny" which you cannot understand in the article on page 107 was inserted by mistake. Mr. Luckhurst described this Conifer as "spring tender," but his words were misread by the compositors. They also converted "Pimeleas" in the copy into "Primulas" in print in Mr. Thomson's article near the top of page 100 last week. It is seldom two accidents of that nature happen in one issue of the Journal.

Climber for Cold Greenhouse (A. G. F.).—With a Maréchal Niel Rose on the roof a flowering climber would have a poor chance on the back wall; but with plenty of light Clematis indivisa lobata would answer, being quick in growth and free-flowering; it flowers in spring. Mandevilla suaveolens is fine for cutting, and very sweet; it flowers in late summer, and is a rapid grower when it becomes established. Lonicera sempervirens minor is the finest of all Honeysuckles, and it does well in a cool greenhouse, flowering in spring and summer.

Mushrooms (F. Gleason).—One Mushroom becoming united to another, hoisted on the top of it, so to say, and there supported, is not an unusual occurrence. It is the result, as you suggest, of the strong forcing the weak out of dense clusters and the tissues joining, and may be regarded, if you wish, as an example of the Darwinian law of the "survival of the fittest." We are glad you have such a "splendid crop of fat Mushrooms," for which you are good enough to say you are "indebted to our Journal." Permit us to return the compliment by congratulating you on your own sound judgment and good work.

Utilising Early Peach House Roof Lights (F. S.).—The lights are likely to be of most service for placing over late Peach trees grown against a wall in assisting their fruit to finish well, and aid in ripening the wood. A span-roof house would not answer, and a west aspect is not very favourable to Peaches in many localities, but in yours, unless very exposed, it would no doubt answer well. It will be necessary to provide efficient protection for the blossom, young fruit, and tender foliage in spring. Suitable varieties are Princess of Wales, Barrington, Warburton Admirable, Sea Eagle, the Nectarine Peach, and Gladstone. Dwarf fan-trained trees are best for walls.

Propagating Bedding Plants (A Youngster)—You will be more likely to succeed with the "Geraniums" by leaving their propagation until March or even April than by inserting cuttings now in a hotbed. A hotbed would enable you to rear a quantity of plants, but we should not employ it for the bedding Pelargoniums, but reserve it for such as Ageratums, Verbenas, Lobelias, and others that need a close moist heat for their successful striking. The Pelargoniums will root very well in the vinery, taking care not to overwater nor shade too much. Though useful, spring struck Pelargoniums are not nearly so good for bedding purposes as are plants raised in the autumn, but we have used both very successfully in cases where there were older plants to raise the centre of beds, those from spring struck cuttings being planted round them for forming a low margin.

Name of Beetle (G. H. C).—It is one of our native species, a rather large female specimen of the Weevil, called *Otiorynchus tenebricosus*. During the winter months these cease to eat, and hide away at some slight depth in the earth, or occasionally under bark; they are not unfrequently conveyed from one place to another in pots or boxes containing mould. Early in the spring they issue forth to attack the buds or young twigs of fruit trees, showing much partiality for the Apricot and Peach. Later in the season the stout fleshy grubs or larvæ may be found feeding on the smaller roots of various fruit trees, also other shrubs. As yet they have not been discovered in the act of doing any harm to Orchids.

Applying Superphosphate of Lime (C. R.).—Superphosphate of lime principally benefits plants by its phosphoric acid, which is combined with one equivalent of calcium (lime). The superphosphate being soluble in water is, therefore, a readily available plant food. Being principally a phosphatic manure, although containing a small percentage of nitrogen, superphosphate may be applied advantageously to ground that contains naturally an abundance of lime, for though some limestones contain a good per-centage of phosphoric acid, most are deficient in phosphates, which are particularly valuable as dressings for light soils, or where immediate benefit is desired, for it does not come under the permanent improvement class of manures.

Peach Tree Casting Buds (En Avant).—The present condition of the soil is no indication of its previous state, and we think the tree has not been well supplied with water at some stage in the formation of the flower buds. The buds fall, however, from a variety of causes, but over-development, imperfect formation, and dryness at the roots are the chief. The border having an incline leads us to assign the cause to dryness, especially as the soil is in better condition near the stem of the tree, and the taking out of an old tree where the soil was sour is no evidence of the tree casting its buds through lack of moisture as above indicated. None of the manures you name has any prejudicial effect on the buds, but by favouring soil enrichment would contribute to their formation and retention.

Applying Blood to Vine Borders (W. B.).—Dried blood forms a valuable fertiliser, supplying potash, phosphoric acid, and nitrogen to the soil. It should not be applied whilst the Vines are dormant, as it decomposes rapidly, the organic nitrogen being soon converted into ammonia and soluble compounds, and is an excellent dressing for sandy soils. If the blood be fresh it can easily be coagulated by adding enough sulphate of lime (gypsum) to it, which causes a more rapid decomposition, and encourages the conversion of the insoluble nitrogenous matter into nitrates. Apply it at the rate of a good handful per square yard or a peck per rod when the Vines are starting into growth. If the gypsum is not handy dry wood ashes answer for drying the blood, and are a useful manure for Vines.

Cropping Pot Vines (Jas. S.).—Judging by the shoots sent we should consider the Vines capable of perfecting eight bunches each, taking care to remove the superfluous bunches in good time, or as soon as the best can be ascertained; also supporting the roots by surface dressings and copious supplies of weak liquid manure. If the Vines were encouraged to form feeders at the surface, by placing turves around the rims of the pots, and that filled with decomposed manure, there would be greater certainty of the crop swelling well, especially if the roots came over the rim of the pots and had the run of the fermenting bed. It is not unusual for Vines to show fruit freely at eleven months old, and yours are very free, the bunches being promising, and we heartily congratulate you on your successful practice.

Neglected Nut Trees (H. T. H.).—Not only will fresh growths push from the cut-back stems, but from the ground, and produce growths stronger than ever, and fruitless in character, unless the root action is seriously checked by digging a deep trench round each tree 2 or 3 feet from the stem, cutting right down through the roots, at the same time undermining and severing all that strike downwards. If this is done and the soil replaced and beaten down firmly, and a selection of moderate growths of equal strength is made, and these are at least a foot, and preferably 18 inches apart, all others being suppressed now, and as they appear in spring and summer, there is the possibility of shorter firmer growths being produced and ripened that may bear in due time. If you do not reduce the roots considerably the branches will soon shade the fruit trees again without affording any nuts as compensation.

Pruning Long Sappy Shoots of Fruit Trees (Suburban Amateur).—Cut away the "breast-wood" to a sound bud nearest the base. These useless growths only impoverish the other parts of the tree, and by depriving the spurs and growths that would form of light and air, prevent the solidification of the wood and the formation of blossom buds. These robbers should be pinched in summer to three or four leaves of their base, not counting the small basal leaves, and by the concentration of the sap on the lower buds aided by the increased power of elaboration in the leaves, it is probable they would form spurs or fruit buds; but when growth is excessive, and there is no room for the trees to extend, root-pruning is the only effectual remedy. That we should advise in your case, taking care to do it effectually yet judiciously. By inducing a reciprocal action between the roots and branches the trees will fruit abundantly. The above was in type when your second letter arrived, in which you say that the trees have been taken up. We hope the broken ends of the roots were cut smooth before replanting.

Feeding Camellias in Tubs (T. T.).—Camellias are much invigorated by surface dressings of cow or sheep manure. The former mixed with one and the latter with two parts of turfy loam are less objectionable in appearance than if used alone, and an inch thickness encourages the roots to the surface, liberal waterings washing the manurial elements into the soil. Both make excellent liquid manures, using a peck of the first to twenty gallons, and the same quantity of the other to thirty gallons of water. If these are used boiling water should be first poured upon them, as they are apt to be full of insect or destructive larvæ. Soot is a powerful stimulant. Form it into a paste with water, and use a tablespoonful with every three gallons of water employed in watering. The advertised artificials are good fertilisers, employing them according to the instructions. When the trees are swelling their buds is a good time to apply liquid manure, as it not only assists the buds in swelling but enriches the soil, encouraging root formation and a good growth. Now is a suitable time to use it, continuing until the buds are set.

Names of Plants.—We only undertake to name species of plants, not varieties that have originated from seed and termed florists' flowers. Flowering specimens are necessary of flowering plants, and Fern fronds should bear spores. Specimens should arrive in a fresh state in firm boxes. Slightly damp moss, soft green grass or leaves form the best packing, dry wool the worst. Not more than six specimens can be named at once, and the numbers should be visible without untying the ligatures, it being often difficult to separate them when the paper is damp. (J. B. S.)—1, *Dicksonia antarctica*; 2, *Dicksonia squarrosa*; 3, *Cyathea medullaris*; 4, *Todea superba*; 5, *Hymenophyllum ciliatum*. (A. C.)—1, A species of *Carex*; 2, *Adiantum formosum*; 3, *Asplenium flaccidum*; 4, *Gnaphalium lanatum*; 5, *Pilea muscosa*; 6, *Choysia ternata*. (M. H. S.)—*Crotalaria pulcherrima*.

COVENT GARDEN MARKET.—FEBRUARY 11TH.

BUSINESS quiet, with supplies somewhat shorter.

VEGETABLES.

	s.	d.	s.	d.		s.	d.	s.	d.
Artichokes, dozen ..	0	0	to	0	Mushrooms, punnet ..	1	6	to	2
Beans, Kidney, per lb. ..	1	6	1	9	Mustard & Cress, punnet	0	2	0	0
Beet, Red, dozen ..	1	0	0	0	Onions, bushel ..	3	0	4	0
Brussels Sprouts, ½ sieve	2	6	3	0	Parsley, dozen bunches	2	0	3	0
Cabbage, dozen ..	1	6	0	0	Parsnips, dozen ..	1	0	0	0
Carrots, bunch ..	0	4	0	0	Potatoes, per cwt. ..	3	0	4	0
Cauliflowers, dozen ..	3	0	6	0	Rhubarb, bundle ..	0	2	0	3
Celery, bundle ..	1	0	1	3	Salsafy, bundle ..	1	0	1	0
Coleworts, doz. bunches	2	0	4	0	Scorzoner, bundle ..	1	6	0	0
Cucumbers, doz. ..	4	0	8	0	Seakale, per bkt. ..	2	0	2	6
Endive, dozen ..	1	0	0	0	Shallots, per lb. ..	0	3	0	0
Herbs, bunch ..	0	2	0	0	Spinach, bushel ..	5	0	6	0
Leeks, bunch ..	0	2	0	0	Tomatoes, per lb. ..	0	4	0	8
Lettuce, dozen ..	2	0	2	0	Turnips, bunch ..	0	0	0	4

FRUIT.

	s.	d.	s.	d.		s.	d.	s.	d.
Apples, ½ sieve ..	1	6	to	6	Lemons, case ..	15	0	to	20
" Nova Scotia and					Melons, each ..	0	0	0	0
" Canada, per barrel	15	0	26	0	Oranges, per 100 ..	4	0	9	0
Grapes, per lb. ..	1	6	3	6	St. Michael Pines, each..	2	0	6	0
Kentish Cobs ..	45	0	50	0	Strawberries, per lb. ..	0	0	0	0

AVERAGE WHOLESALE PRICES.

CUT FLOWERS.

	s.	d.	s.	d.		s.	d.	s.	d.
Arum Lilies, 12 blooms ..	2	0	to	4	Marguerites, 12 bunches	4	0	to	6
Azalea doz. sprays ..	0	9	1	0	Mignonette, 12 bunches..	3	0	6	0
Bouvardias, bunch ..	1	0	1	6	Mimosa (French), per				
Camellia, white, per doz.	2	0	4	0	bunch ..	1	6	2	0
" red ..	1	0	1	6	Narciss (Paper-white),				
Carnations, 12 blooms ..	1	0	2	6	French, doz. bunches ..	6	0	12	0
Christmas Roses, dozen					Do. Do. English,				
blooms ..	0	6	1	6	per bunch ..	1	0	1	6
Chrysanthemum, 12 bchs.	3	0	6	0	Pelargoniums, 12 trusses	1	0	1	6
Daffodils, doz. blooms ..	1	0	2	0	" scarlet, 12 bunches	8	0	12	0
Epiphyllum, doz. blooms	0	4	0	6	Poinsettia, dozen blooms	3	0	6	0
Eucharis, dozen ..	3	0	6	0	Primula (double) 12 sprays	0	6	1	0
Gardenias, each ..	3	0	5	0	Roses (indoor), dozen ..	0	6	1	6
Hyacinths (Roman), doz.					" Red, 12 bls. (French)	2	0	4	0
sprays ..	0	6	1	6	" Tea, white, dozen..	1	0	3	0
Lapageria, 12 blooms ..	2	0	4	0	" Yellow, dozen ..	3	0	12	0
Lilac (French) per bunch	4	0	6	0	Tuberose, 12 blooms ..	1	6	2	6
Lilium longiflorum, 12					Tulips, per dozen ..	1	0	2	0
blooms ..	6	0	9	0	Violets (Parme), per bch.	4	0	6	0
Lily of the Valley, dozen					" (dark), per bch. ..	2	0	3	0
sprays ..	0	9	1	6	" (English), doz. bunch	1	0	2	0
Maidenhair Fern, dozen					Wallflower, doz. bunches	3	0	6	0
bunches ..	4	0	9	0					

PLANTS IN POTS.

	s.	d.	s.	d.		s.	d.	s.	d.
Aralia Sieboldi, dozen ..	6	0	to	12	Lilium lancifolium, doz.	0	0	to	0
Arbor Vitæ (golden) doz.	6	0	8	0	" longiflorum, doz.	0	0	0	0
Azalea, per plant ..	2	0	3	6	Lily of the Valley, per pot	1	0	2	0
Cineraria, doz. ..	9	0	12	0	Lobelia, per doz. ..	0	0	0	0
Climbing Plants, various,					Marguerite Daisy, dozen	6	0	12	0
dozen pots ..	0	0	0	0	Mignonette, per dozen ..	4	0	6	0
Dracena terminalis, doz.	4	0	42	0	Musk, per dozen ..	0	0	0	0
" viridis, dozen ..	12	0	24	0	Myrtles, dozen ..	6	0	12	0
Epiphyllum, per dozen..	0	0	0	0	Nasturtiums, dozen pots	0	0	0	0
Erica, various, dozen ..	12	0	18	0	Palms, in var., each ..	2	6	21	0
Eunonymus, var., dozen ..	6	0	18	0	Pelargoniums, per doz. ..	0	0	0	0
Evergreens, in var., dozen	6	0	24	0	Poinsettia, per doz. ..	9	0	15	0
Ferns, in variety, dozen ..	4	0	18	0	Rhodanthe, per dozen ..	0	0	0	0
Fiens elastica, each ..	1	6	7	0	Stocks, per doz. ..	0	0	0	0
Foliage plants, var., each	2	0	10	0	Tropæolums, various, per				
Genista, per doz. ..	9	0	18	0	dozen ..	0	0	0	0
Geraniums Scarlet, p. doz.	0	0	0	0	Tulips, dozen pots ..	6	0	9	0
Hyacinths, doz. pots ..	6	0	9	0					

TRADE CATALOGUES RECEIVED.

R. C. Notcutt, Broughton Road, Ipswich.—*Catalogue of Choice Chrysanthemums.*
 J. Carter & Co., 237 and 238, High Holborn.—*List of New and Beautiful Chrysanthemums.*
 B. R. Davis, Yeovil.—*Catalogue of Tuberos Begonias.*
 Harlem P. Kelsey, Linville, Mitchell Co., North Carolina.—*Catalogue of Trees, Shrubs, and other Plants.*



SEWAGE.

SEWAGE or liquid manure of any sort ought to play an important part in the culture of all forage crops, of root crops, and in fruit farming. We have been told positively that bullocks do not fatten so well upon sewage hay as they do upon ordinary hay, but surely it will be granted that we have ample compensation for lowness of quality in enlarged quantity. Bullocks are not fattened exclusively on hay, though hay may form the bulk of food used, and it is an easy matter to guard against any want of quality in the hay by some addition to other parts of the dietary.

Some twenty-four years ago it was proved that a ton of grass could be grown for each 100 tons of London sewage used, and this, too, irrespective of quality of pasture. A yield considerably upwards of 30 tons of Rye Grass per acre obtained by several consecutive mowings from a very poor shallow soil upon gravel about that time ought to have led to better things than it did. Objection was taken to anything like a general use of sewage by the scientific leaders of that day, because its deficiency in potash and phosphoric acid might cause mischief by the persistent use of sewage upon the same plot of land. Yet how easily might such an objection be overcome by a sufficient top-dressing of chemical manures before the sewage was used, and it should not be forgotten that very much soil contains sufficient potash.

Subsequent practice has shown this to have been very much a false alarm, just as the unavoidably excessive dilution of sewage with water proved to be an advantage rather than an obstacle to its profitable use. It is really a moot point as to what is excessive dilution, for it must never be forgotten that the water promotes decomposition, so that when the sewage enters the soil its manurial constituents are absorbed and retained, leaving an odourless transparent effluent. We prefer the term of absorption to that of filtration, because plant food is taken up by the roots in a gaseous or liquid form; yet the terms are conjointly applicable to the process, for sewage that is applied to the soil in a very crude state has the particles of manure arrested and kept in the soil by a process of mechanical filtration.

The popular idea largely shared by scientific men that sewage could only be used to advantage for light and very porous soils was also a mistake, and the objection to its use for heavy land on the score that such land became cracked in a drought, and the sewage was lost by running away in the cracks or fissures, was simply ridiculous, and yet the statement was made in evidence before a Committee of the House of Commons. Holding as we do that all soil can profitably be brought into a suitable mechanical condition by judicious cultivation, we must insist upon the general utility of sewage when used with judgment. We should store the soil with fertility now before growth begins if we would have a full crop and sustained vigour. Let the home farmer having the advantage of a manure tank and a bon-accord pump keep the manure distributor briskly at work throughout the present month on all firm pasture or leys, and he will reap a rich reward in an early and abundant crop of herbage available for stall feeding, grazing, or hay.

From 50 to 60 tons per acre of Mangolds have been grown on

land manured with sewage, which is applied long before the seed is sown, and frequently after seed germination. Care has to be taken not to pour the sewage over the leaves, and the difficulty in using it on a large scale for root culture is the want of a cheap and efficient method of distribution; the difficulty does not exist where a system of irrigation is in force. Marvellous crops of cattle Cabbage, too, may be had by a regular use of sewage weekly, and we may remind managers of small home farms that with a large manure tank at their disposal it is in their power to produce crops of such phenomenal abundance as will astonish the tenant farmers, and afford them a valuable lesson if they care to take advantage of it.

In fruit farming sewage should be regarded as a prime factor to success. For young fruit trees it answers best when the fruit is swelling; for old trees having a tendency to barrenness now is the time to saturate the soil with it, and in doing this care must be taken to reach all the roots, and so to store the soil with fertility, that all new roots grown in the coming season shall find ample stores of food in the soil. Very simple is it not? And yet how many farm orchards are there in which the trees are in a lamentable state of exhaustion, while the sewage is suffered to run to waste as a worthless thing. For Strawberries and bush fruits it cannot be esteemed too highly. It makes certain, vigorous growth, full crops, fine fruit, if only it is used freely enough.

WORK ON THE HOME FARM.

The long frost has prevented the sowing of much Wheat on heavy land, and has given the laggards a lesson which they will do well to remember. Not a single good reason have they for putting off Wheat sowing till the end of November. Our own Wheat plant from the September sowings is a little brown in parts of the fields where the snow was not thick enough to protect it from the frost, but on the whole we can report a full strong plant, over which the Cambridge's press wheel roller or a Howard fluted roller will be passed as soon as the surface is sufficiently firm and dry. On very rough land a Crosskill roller may have preference, but it will be rather too heavy for the tender condition of land for some time to come.

The scarcity of Clover seed will make prices rule high, and will, we hope, induce a much more extensive sowing of mixed seeds, which can be kept down for three or four years by farmers generally at any rate. In Essex and Suffolk, where the climate is generally so favourable to the development of Clover seed, it will probably still have preference; but this a matter altogether apart from the general question. With land so exceptionally clean, the wisdom of laying down a considerable breadth to temporary pasture is obvious enough.

Reports of serious outbreaks of pleuro-pneumonia and swine fever continue, and special attention should now be given to the condition of piggeries and the division of the pigs. Guard well against crowding. Pigs will lie close together, and often become so overheated that they rush into the open air, get a sudden chill, and disease follows. Clean stys, very little litter, and ample space, are the simple but efficient preventives. The temptation to allow muck and filth to accumulate in piggeries at this season of the year is very great, and the only safe way to overcome it is to insist on a regular clearance at stated times, so that there can be no excuse for negligence.

A mixed dietary is altogether preferable for bacon hogs. Maize must not be the chief thing or they become too fat. Middlings, bran, and buttermilk, with a moderate quantity of Maize, and some Mangolds and cattle Cabbage, tend to promote health and the development of a carcase with lean and fat in well balanced proportions.

METEOROLOGICAL OBSERVATIONS.

CAMDEN SQUARE, LONDON.
 Lat. 51° 32' 40" N.; Long. 0° 8' 0" W.; Altitude, 111 feet.

DATE.	9 A.M.					IN THE DAY.				Rain	
	Barometer at 32° and Sea Level.	Hygrometer.		Direction of Wind.	Temp. of soil at 1 foot.	Shade Temperature.		Radiation Temperature.			
		Dry.	Wet.			Max.	Min.	In sun.	On grass		
1891. February.	Inches.	deg.	deg.		deg.	deg.	deg.	deg.	deg.	In.	
Sunday	1	30.064	43.8	42.3	N.W.	40.0	47.0	41.2	75.2	35.4	—
Monday	2	30.639	33.8	32.2	N.	38.9	47.7	29.9	54.6	23.8	—
Tuesday	3	30.625	41.9	43.1	W.	38.9	48.4	32.9	53.4	24.9	—
Wednesday ..	4	30.658	47.2	45.2	N.	39.9	48.0	43.9	72.6	39.1	—
Thursday	5	30.704	40.4	39.9	N.W.	39.7	45.5	34.9	67.9	27.4	—
Friday	6	30.633	41.2	39.9	N.W.	39.0	43.9	35.1	51.8	28.1	—
Saturday	7	30.553	43.4	42.8	Calm.	39.8	44.7	41.1	46.0	39.9	0.010
		30.559	43.1	40.8		39.5	47.0	37.0	61.5	32.0	0.010

REMARKS.

1st.—Cloudy till noon, almost cloudless after.
 2nd.—Slight fog early; fine day, but no strong sunshine.
 3rd.—Fine, with a gleam of sunshine at midday.
 4th.—Cloudy morning, bright afternoon and evening.
 5th.—Overcast early; fine day, with frequent sunshine.
 6th.—Overcast, with a little drizzle at midday.
 7th.—Fog and darkness, with drizzle and light rain; darker than an average cloudy night from 9.45 A.M. to 11.50 A.M. At 10.45 A.M. a white board 3 feet by 1 foot 6 inches was invisible at 10 feet distance. The misty rain which fell was so dirty that every drop was distinctly marked on white paper exposed to its fall. Temperature near, but rather above, the average.—G. J. SYMONS.

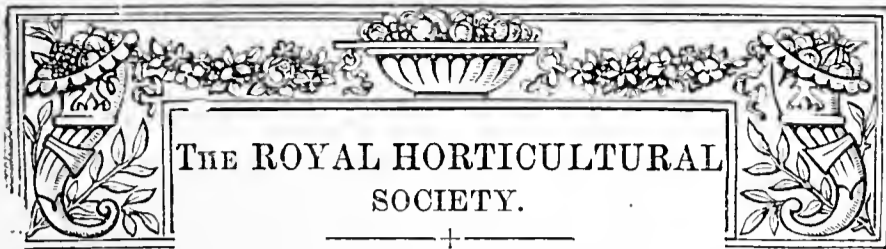

BEFORE referring to an incident in which the *Journal of Horticulture* figured somewhat prominently at the annual meeting last week we wish to express our satisfaction at the distinctly improved condition of the Society as represented in the Report and Revenue account that were presented for adoption, as well as in the President's address. Earnestly desirous of seeing the Society well supported, well managed, and prosperous, we rejoice in the success that has been achieved by the Council and officials, and at the same time cordially wish that even a greater measure of success will be the reward of their endeavours during the ensuing year.

The improvement appears to be general. In finance a deficit at the beginning of the year has been changed into a surplus at its close. That is a distinct gain. There has been a substantial increase in the number of Fellows, but at the popular guinea rate it is desirable that the increase be considerably greater, and we shall be glad if, as the Council suggests, each Fellow can obtain at least one more for adding to the roll as the season advances. The improvement of the Society's "Journal" is very decided, and we take some little credit to ourselves in having pointed out the way, and the Editors have by their work proved the justification of our references. That is so far satisfactory, but we should like to see future issues produced at less cost without being less acceptable to the Fellows, and think this might be done. We pass on, however, to note the improvements referred to, and which are apparent, at Chiswick. The structures are gradually being put into better order, and the garden no longer presents an aspect of semi-neglect. The trials of flowers and vegetables conducted there and the conferences held are of wide public interest, and give a stability to the Society that it could not otherwise enjoy. We are pleased to observe that the Council will be glad to give still further support to Chiswick when the increase of Fellows permits this to be done, and we trust the necessary means will be forthcoming. The Committee meetings in London have been better attended than in previous years, and on many occasions the Hall has been most attractively and interestingly furnished. We are not alone by a very long way in having no love for the place, but it seems as if the public mind in time becomes accustomed to incongruities, and perhaps in a measure reconciled to them.

The Society is providing special encouragement for amateur exhibitors at the shows and meetings announced to be held during the current year, and we are reminded that it may assist the Society if special attention be called to the fact. In addition to money prizes at nearly every meeting silver-gilt, silver, and bronze Flora medals are offered on March 24th, April 14th, May 12th, June 9th, July 7th, August 11th, August 25th, September 8th, October 6th, and November 10th; silver Banksian and silver Knightian medals being provided for October 6th and December 8th. Silver challenge cups for amateurs are included in the schedule June 9th, June 23rd (Pæonies), and September 8th (British Ferns). The Veitch Memorial medal with £5 is also offered on October 6th for a collection of fresh cones and branches with foliage. Besides these the following firms are contributing attractions to the meetings named by medal prizes.

Messrs. Barr & Son, King Street, Covent Garden, offer a silver-gilt medal for the best new English raised seedling Daffodil, to be

competed for at any meeting up to May 12th. They also offer silver and bronze medals for collections of Daffodils on March 10th, March 24th, April 14th, April 21st, and May 12th, all the classes being confined to amateurs, and Polyanthus Narcissi are excluded. Mr. James Kelway (Messrs. Kelway & Sons, Langport, Somerset) is again presenting the silver Gladiolus medal, and Mr. William Kelway is offering four "Kelway medals" in order to extend the cultivation of improved forms of the most beautiful flowers that can be grown in the gardens of the United Kingdom. One of these medals (a silver-gilt) is to be awarded for herbaceous Pæonies, the other three (silver) for Pyrethrums, Delphiniums, and Gaillardias.

The dates upon which these medals will be offered are May 28th and 29th (the Temple Show) for Pyrethrums, June 23rd for Pæonies and Delphiniums, and July 7th (Chiswick) for Gaillardias. We have pleasure in giving prominence to these prizes, as we think the experiment well worthy of being tested, for non-competitive exhibiting is more or less tame, and Britishers have such a natural love for real contests that they would even rush to a drill hall to see a good fight.

We are now going to enter into our little contest with the Council over the validity of some recent elections. We intend to defend our position in the most friendly way, but firmly. This is no question of opposition to individuals, and a gentleman at the meeting who was bold enough to ask a question in that way suggestive was met with a burst of laughter. We can quite understand the Council desiring to retain the services of Mr. D. Morris on the Board. The Society never had a better Treasurer, and can never hope to have, than in Mr. Morris, and a gentleman who possesses the requisite qualifications for that position must of necessity be a competent administrator. We can also well understand Mr. Morris desiring to be relieved from the duties that he discharged so well, while at the same time being willing to serve on the Council. Nothing would have been more easy than the attainment of both objects within the charter. He had simply to resign the treasurership in the prescribed form, and also in prescribed form have had his resignation accepted at the annual meeting, and he would have been free, and he would have remained on the Council, if he was not one of the three recommended to retire. As neither of these vital conditions was fulfilled he does, in fact, remain on the Council, and what is more he is the Treasurer still. His re-election on the Board at the meeting last week was superfluous, and Mr. Crowley's election as Treasurer invalid.

Notwithstanding the criticism and explanations made by the Secretary at the meeting upon the remarks we published on page 111 of our issue of February the 5th, we feel compelled to reiterate what we then stated as being absolutely correct. We said that Mr. Morris, who was nominated for election on the Council (on the form provided for that purpose), was already a member of that body, and would remain so till after his resignation was accepted by the annual meeting. This is set forth in by-law 66, where it is stated, "Any member of the Council may resign his seat in the Council, but his resignation shall not be deemed complete until it has been accepted by a resolution passed at the next ensuing annual meeting," &c. That is explicit. A member "may" resign, but his resignation "shall not" be accepted otherwise than in the manner prescribed. Was the law complied with? Certainly not, for no resolution either accepting or rejecting Mr. Morris's resignation was passed at the meeting, and consequently he remains a member of Council and Treasurer of the Society, not by virtue of the informal election that took place at the annual meeting, but by virtue of his resignation not having been accepted. So important is the act of acceptance or non-acceptance of the resignation of a member of Council that by-law 74 provides that it shall be taken at the meeting (after the appointment of scrutineers) "before all other business."

The failure in presenting the necessary "resolution" for completing a resignation has in this case involved non-compliance with the very important by-law 65, which states, "At every annual meeting of the Society three members of the Council shall be removed by ballot of the Fellows present, and the vacancies so created shall be filled up by the election of three other discreet Fellows of the Society." Mr. Morris, as we have shown, was actually a member of Council, and therefore his election again does not and cannot count, and it follows that only two new members were elected—namely, Sir John Llewelyn, Bart., and Mr. G. Bunyard. Mr. Crowley could not be elected on the Council because his name had not been inserted in the form provided for that purpose under by-law 83, which states, "The Council shall prepare two balloting lists, including the names of any Fellow or Fellows proposed for removal or election." The first of these lists (F in the Appendix) refers to the Council, the second (G) to officers. For election on the Council it was necessary for Mr. Crowley's name to be in the first list, printed and circulated among the Fellows in January. This was not done. His name was not in the "Council" list, where it ought to have been; but Mr. Morris's was, and it was not necessary it should be, therefore Mr. Crowley's was put in the "officers'" list, and recommended as Treasurer, but that could not entitle him to election as such, because the charter clearly states that the Treasurer "shall" be elected "from among the members of the Council." Mr. Crowley's name ought to have been in both lists under the circumstances; he would then have first been elected on the Council, and next as Treasurer. He has never been elected on the Council in prescribed legal form, and was consequently not legally elected as Treasurer. Through some misapprehension two admirable business men have been made to checkmate each other, with the result that one of them remains in the position from which he sought to retire, and the other is debarred from an office that he was desired to fill.

In referring to our note (page 111), the Chairman of the meeting stated there had been some misapprehension of the by-laws which the Secretary would explain. No doubt there had been some "misapprehension," but not by us. With all the by-laws quoted by the Secretary we are quite familiar, and we know that their interpretation must not be in conflict with the charter. We were not likely to question the power of the Council to fill up vacancies that may occur on the Board between two annual meetings. This can of course be done, but for how long? "Until the annual meeting next following." That is what the charter says, and the principle applies to all the by-laws affecting vacancies quoted by the Secretary, and published in our report of the meeting on page 125. The reservation is of fundamental import, for it deprives the Council of the power of abrogating the rights of the members of the Society at their annual meeting. The precise words we have quoted are not in the by-laws, but they are in the charter; and at the head of the by-laws there is a note printed in italics which says, "Where any conflict, contradiction, or repugnance appears or seems to arise, the words or meaning of the charter must prevail."

The Secretary is reported as having said that "Mr. Morris had resigned, and Mr. Crowley had been appointed to fill the vacancy thus caused, but as Mr. Morris was expected to return next month, he had been nominated for re-election because his services had proved so valuable to the Council." The Council was empowered to appoint Mr. Crowley last autumn, but only until the annual meeting, and Mr. Morris' resignation was not complete, and could only be made so by the act of the general meeting. If it had been accepted by the meeting (to which it was not even submitted), he would not have been eligible for re-election at that meeting, because the charter and by-laws clearly state that three "other" discreet Fellows shall be elected than those which retire. The officers are re-eligible, but not retiring members of Council. There was no occasion to nominate Mr. Morris, but Mr. Crowley's name ought to have appeared in the form instead, and then the services of both these gentlemen would have been secured on the Council. We

suggested a way out of the difficulty before the meeting, and Mr. Crowley can act as Treasurer yet if Mr. Morris again in prescribed form resigns that position, thus creating a vacancy to which Mr. Crowley can be appointed until the next meeting in 1892, and he can then in due form be placed on the Council by that meeting. At present it has to be considered whether he can make a valid payment or give a legal receipt on behalf of the Society, for Mr. Morris remains in law the only Treasurer.

But there is another and very important matter connected with this election that has been overlooked by the Council, and that is the validity of the voting papers. By-law 81 says, "Vacancies in the Council created by the resignation or removal or incapacity by an annual meeting of any member of the Council shall be deemed to be *extraordinary* vacancies; all other vacancies in the Council shall be deemed to be *ordinary* vacancies."

Assuming Mr. Morris's resignation had been valid through its acceptance by the annual meeting it would have been an extraordinary vacancy, and consequently there would have been one more added to the three that retired according to by-law 65, making the number of vacancies four. But on the retiring list there were only three, and these were distinguished by the prefix of R, which means "that the removal of the member against whose name that letter is placed is recommended." Not a word of the extraordinary vacancy caused by the supposed resignation of Mr. Morris, whose name ought to have had the prefix of V, to indicate "that a vacancy has been created in the office of the member against whose name that letter is placed by death or incapacity from illness or otherwise."

It is with no unkind feeling that we write these lines, but from an earnest desire that the Society should be conducted "discreetly," and in accordance with the charter that we are solicitous about the modes of procedure. The Society is, fortunately for itself, working under a charter, and it behoves those who are entrusted with its administration to bear this in mind, for any departure from the prescribed forms may land the Society into unforeseen difficulties.

THE FANCY PANSY.

It is now forty years since the late John Salter first brought this lovely race of Pansies before the public, and in a few years English and French growers began to send out attractive varieties. Not, however, to remain popular; for when exhibited at the horticultural societies they did not gain favour, and would, no doubt, soon have been lost in oblivion had not one with a keen eye for novelties and improvement in the Pansy taken more than a passing interest in the flower, and notwithstanding the jeers of his brother florists, pioneered the subject of this paper through many a hot discussion, and even ventured to predict its recognition as a florists' flower on the exhibition table. It was in 1858 that Mr. Wm. Dean, the recognised father of the Fancy Pansy, gave so much impetus to the flower, and soon improved forms of his seedlings were figured in the *Florist* and *Floral Magazine*. Thus the foundation was laid, and it must be a great source of pleasure to Mr. Dean, who is still happily amongst us, to see the perfection his favourite has attained. It is in Scotland, however, that the Pansy is seen in its best dress; the cool climate being well suited for its cultivation. We are also indebted to our friends in Scotland for the finest varieties in commerce.

The improvement during the last three years is, perhaps, the greatest advance the Fancy Pansy has ever made. It is true when such old favourites as May Tate, Evelyn Bruce, Catherine Agnes, William Cuthbertson, Mrs. Jamieson, &c., were introduced they were recognised as decided acquisitions; but there was a sameness in their marking, although improved in form, and they have not retained the dense solid blotch with which they were introduced, a feature which we should like to see perpetuated in the Fancy Pansy. We have now, however, a distinct break in colour with every other good property, and the raisers of such grand sorts as Lord Hamilton, William Ross, Mrs. Atkinson, Tom Travis, J. J. Ashton, Miss Hudson, M. A. Scott, Lizzie Duncan, Alexander Smith, Mrs. Mark, Helen Christie, Mrs. John McConzell, &c., have great reason to be proud of their work. It is only a pity these improved forms are not brought more prominently before the public.

The Pansy is perhaps the most popular flower in cultivation; indeed, there are few gardens without a collection. For all

lovers of this charming flower, and especially those who are so frequently asking me for a list of the finest varieties, I have made a selection, which includes both exhibition and decorative varieties. The latter class, although fit for the exhibition table, are perhaps not so fine in quality as the former, and may be distinguished by their robust constitution and floriferousness. Those who grow the Pansy for exhibition ought to have their composts prepared during the winter months. The preparation of composts is now an acknowledged necessity by all cultivators for exhibition, and ought to form one of the chief occupations of a season when little else in the way of gardening can be done. Decayed leaves is perhaps the best rooting medium we can procure, and full of manurial properties; a large proportion of leaf mould ought therefore to form part of the compost. In preparing a good bed for Pansies the soil ought to be taken out to a depth of 18 inches, then fork in some good manure, afterwards making up the bed about 6 inches above the surface with the compost, which will hitherto have been thoroughly mixed and pulverised with the frost. As soon as the weather is somewhat mild, and the ground dry enough, planting ought to be pushed on without delay during March and April. This is one of the secrets of success. After planting we tread the bed as firm as possible, as with an Onion bed, after which a good mulching of the compost is again applied and levelled neatly over. The great point is to have the roots actively working in deep fertile soil before the hot weather of early summer sets in. The Pansy is a moisture loving plant, and no amount of sun will do it any harm, provided its roots are cool and moist, and

it is wonderful the slight hold dry weather takes on vegetation established in deep-worked fertile soil.

It is true the Pansy can be grown well in ordinary garden soil in borders or any other convenient part of the garden without any special treatment, but to produce exhibition blooms it will be found a little extra care in cultivation is necessary, especially now when competition is so keen. In shallow-worked ground the stratum of fertile soil must be so thoroughly freed from moisture in hot weather as to cripple the plants by lack of food, and probably those roots which did pass beyond the reach of drought were in a medium entirely deficient in the elements of plant food, of which moisture is only one, though most important.

It may be remarked by some that Pansies do not require a deep-rooting medium, but although the roots may not travel enough to obtain direct supplies from the deeper soil, yet there is a continual passing of moisture laden with plant food in solution to take the place of the drier medium in which the roots are active. If there be no means of staying the upward progress of this moisture its final destination will be the atmosphere, and much of its value is destroyed by this means; we must therefore have the ground mulched two or three times during the season with short decayed manure or other compost, which will act as a complete foil between the dry atmosphere above and the comparatively moist soil beneath.

In the subjoined list the varieties marked thus* are selected as decorative sorts. Owing to their stronger constitution they are better adapted for borders, or such places as may be devoted to

LIST OF THE LEADING FANCY PANSIES.

Name.	Raiser's or Introducer's Name.	Date of Introduction.	Colour.
Lord Hamilton	Grossart	1890	Mulberry blotches, belting mauve, suffused with rose, a novel combination.
Mrs. Atkinson	Atkinson	1890	Maroon blotches, yellow ground, broadly margined with deep puce.
Wm. Ross	Campbell	1890	Dark crimson blotches, belting white, suffused with rosy-crimson, margined like a
Mrs. John McConnell	McConnell	1888	Violet blotches, purple ground, distinctly edged with pure white. [rainbow.
M. A. Scott	Campbell	1888	Purple blotches, bronze ground, margined rose, suffused with yellow.
*J. J. Ashton... ..	McConnell	—	Dark crimson self, beautiful outline, perfect form.
Miss Hudson	Tinsley... ..	1890	Violet blotches, white self, a beautiful smooth flower.
*Market Favourite	Steel	1890	Brown blotches, yellow self of grand outline.
*Pom Travis	Kay	1890	Dense violet blotches, purple ground, margined with pure white.
*Kayi	Kay	1890	Purple blotches, yellow ground, margined rosy-purple.
*Wm. Evits	Kay	1890	Velvety black blotches, ground bronzy yellow belted with deep crimson.
*Geo. Anderson	Bailey	1889	Maroon blotches, violet ground, edged yellow.
Mrs. Lister	Lister	1890	Purple blotches, edged crimson.
Alex. Smith	Campbell	1890	Purple blotches, yellow ground, belted with crimson.
Mrs. Mark	Campbell	1890	Dense black blotches, ground light yellow, edged with rosy-crimson.
*Donald Morrison	Campbell	1888	Purple blotches, yellow ground, belted with rosy-crimson.
*Lizzie Duncan	Campbell	1889	Black blotches, purple ground, edged white.
Miss French	Campbell	1888	Dark violet blotches, yellow ground, belted with crimson.
Neil Leitch	Lister	1888	Maroon blotches, yellow ground, edged with rose.
Maggie Shaw... ..	Campbell	1889	Violet blotches, white ground, suffused with rose.
*Helen Christie	Campbell	1890	Purple blotches, white ground, suffused with rose.
*Sir Jas. King	Stewart... ..	1888	Violet blotches, purple ground, margined with white.
*Neil M'Kay	Fox	1887	Chocolate blotches, yellow ground, margined with chestnut brown.
John Taylor	Kay	1890	Blue blotches, white self, of fine form.
Mrs. Hugh Weir	Weir	1890	Chocolate blotches, yellow ground, margined with rose.
Pilrig	Dickson & Co.	1885	Mulberry blotches, yellow ground, margined with crimson.
*Princess Beatrice	Laird & Son... ..	1886	Violet blotches, white self, of finest form.
Alfred Hunt	Paul	1888	Brown blotches, plum ground, edged yellow.
*Mrs. John Downie	Sutherland	1884	Chocolate blotches, lemon self, very large smooth flower.
*Beauty	McComb	1885	Crimson blotches, white self, shaded rose, exceedingly pretty.
Mrs. John Ellis	Campbell	1888	Dark indigo blotches, white self, of fine form.
Mrs. Browell	Bailey	1886	Dense purple blotches, crimson self, fine outline.
John Mattieson	Steel	1890	Brown blotches, yellow ground, edged rosy-crimson.
*Lord Rosebery	Pattison	1885	Dark indigo blotches, purple ground, edged white.
Elaine	Dobbie & Co.	1889	Violet blotches, purple ground, edged white.
*John Pope	Laird & Son... ..	1888	Brown blotches, yellow ground, belted with rosy purple.
Katie Hope	Dobbie & Co... ..	1888	Violet blotches, ground rosy-purple, edged white.
*Dusty	Kay	1890	Dark blue blotches, yellow ground, belted crimson.
*Jas. Alexander	Cuthbertson	1887	Black blotches, yellow ground, belted rosy-purple.
*Dodo	Downie... ..	1888	Violet blotches, yellow ground, margined with purple.
*My Lady	Pochin	1884	Purple blotches, violet ground, edged white.
*Harry Moore	Stewart... ..	1890	Dense dark blotches, crimson self.
Dottie Irvine... ..	Irvine	1888	Chocolate blotches, yellow ground, belted with rosy-purple.
*Geo. Cromb	Lister	1887	Claret blotches, pink ground, belted with raby-crimson.
Lady of the Lake... ..	Paul	1889	Violet blotches, creamy white self, exceedingly pretty.
Kate M'Arthur	Campbell	1888	Black blotches, yellow ground, margined crimson.
Edith E. Brown	Lister	1888	Purple blotches, ground indigo blue, edged white.
*Richard Dean	Downie... ..	1888	Dense dark blotches, claret self.
Tom McFarlane	Grossart	1890	Brown blotches, white self, of fine form.
*Miss Marchbank... ..	Downie... ..	1888	Chocolate blotches, rosy-purple ground, belted with white.

their culture—Tom Travis, Market Favourite, Donald Morrison, Princess Beatrice, J. J. Ashton, Maggie A. Scott, and a few others are fine exhibition varieties, with a robust habit, and may with advantage be grown as decorative plants, owing to their bright and distinct colours. Lord Hamilton, the winner of so many first class certificates, is a magnificent variety when "caught;" care must, however, be taken to give it the benefit of a "sun-shade" if the flowers are to be seen to advantage. Wm. Ross is another of the same character, perhaps finer in quality but at times inclined to be rather narrow in the under petal. Tom Travis is a fine bold flower, the colours distinct and well contrasted. Market Favourite is perhaps the best yellow self in cultivation, a fine bold flower. Miss Hudson is a lovely white, and for a dark self J. J. Ashton is our ideal of perfection. Mrs. Atkinson is a gem, after the style of the old and popular favourite May Tate. Maggie A. Scott is a bold dashing flower of fine form. Kayii is named after Mr. Kay of Gargunock, the raiser of so many fine varieties, and will no doubt make its mark on the exhibition table. Wm. Evits is an improvement on Neil M'Kay, one of the most popular flowers in cultivation. George Anderson is another fine variety raised by Mr. Bailey, who is now a specialist in Pansies. In Mrs. John McConnell we have all the characteristics of a model Fancy Pansy. The above may be looked upon as the best, though others in the list may be equally fine when well grown, but those named were most conspicuous in my collection last year. Some very fine varieties were exhibited last season for the first time, and as most of them are now offered to the public we may have something to say on their behaviour later on. It must not be thought that my list contains all the best varieties in cultivation, but as representing the best that have come under my notice, and although in 1890 we had perhaps the largest introduction of really fine sorts ever sent out in one year, there are several of them that will not be grown again here. It is highly amusing to look over some trade list where we find over 360 varieties (at least names) of Fancy Pansies enumerated. It is needless to mention that over 200 of these have had their day. — GEO. STEEL, *Heatherslaw*.

PEACHES AND NECTARINES.

PEACHES and Nectarines, both early and late, now take high rank, if not the premier position, amongst the choicest dessert of the day. It is but a few years since a Queen Pine was considered the all-important dish in a dessert for the *élite* of society, but now the times or fashion has changed to the extent that a Pine is rarely inquired for. How may this state of things be accounted for? Are the huge and often flavourless imported monsters to be blamed? or is the high quality of Peaches better understood and appreciated now that they are better and more extensively cultivated? However this may be, I am told by experienced travellers, whose opinions are worth recording, that the Peach is found to be the most nourishing and sustaining of all fruit, especially before they become "dead ripe." Curiously enough this is the time that wasps and other insects seem to relish them most, just before they begin to soften. It may not be out of place also to mention here how well swine are said to feed on the fallen and surplus Peaches from the extensive orchards in the United States.

Both Peaches and Nectarines were formerly much more grown outside than they now are, but they were mostly a precarious crop, and unless in the most favoured positions failures were more plentiful than successes, and the superiority of the fruit grown inside over that outside is so marked that it is not surprising to find so few attempts outside cultivation, yet there are instances where Peaches and Nectarines are successfully grown on outside walls. The most northern example I know of may be seen at Osberton, where Mr. Woods has a grand wall covered with some fine trees a dozen or fifteen years old, some of these trees covering 200 square feet of wall space.

The soil at Osberton is open and gritty, with a gravelly subsoil, and that Mr. Woods considers too light to grow Vines in. The Peach trees make moderate sized short-jointed wood that is thoroughly matured before winter, whereas in wet localities, where the soil is wet and retentive, the Peach usually make vigorous sappy growths that do not solidify, as the solar heat does not readily penetrate such soils to a sufficient depth in time to solidify the top growths and enable the tree to cast its leaves naturally, but they are retained until a sharp frost separates them from the wood and injures the fruit buds; the following spring leaf blister may safely be expected. This Peach blister is the most disastrous malady attending outside cultivation, and baffles the most determined growers; it mostly follows a cold wet season. My old friend the late Mr. Tillyard and myself, only a short time before his death, had a long argument at Brockleby upon the primary cause of the

Peach blister. I thought when such an old and able cultivator as he was known to be hesitated between two opinions it was a difficult subject to decide; but I may here state that in 1871 I had occasion to change the places of some Peach trees by putting some from a late house on to outside walls, and those from outside walls into the late house. Curiously enough those trees brought in from the outside became almost as badly blistered as those left on the open walls, and those taken outside was the only trees on the walls free from blister and to bear a fair crop of useful fruit; but Mr. Tillyard pointed out a very fine old Peach planted at the side of his dwelling, and well sheltered and protected. This tree until recent years could always be relied on to produce a good crop, but had taken to blistering; Mr. Tillyard thought the roots had gone too deep. Not one of the many young trees he had tried would keep healthy many years, and what had been a fine wall of trees is now a complete wreck as far as Peaches are concerned.

This garden years ago was famed for its fine Peach wall, but of late years the trees became badly blistered. Every tree was lifted and good new borders made, the results still unsatisfactory, but now we have the wall covered with glass we can get 5000 superior fruit with less trouble than it was to get 500 fruits often of a very moderate description, and I am satisfied that it is more trouble to keep trees healthy and secure a crop of Peaches outside than they are worth, unless in the most favoured and suitable localities, and in open porous soils.

Now as we have a good assortment of varieties a description of their behaviour and quality may be serviceable to intending planters, therefore it shall be forwarded by another post.—J. H. GOODACRE.

A FRUIT AND FLOWER FACTORY.

COMMERCIAL gardening has attained a wonderful development within the past twenty-five years, and now constitutes a business entirely distinct from the ordinary seed and nursery trade of this country, and equally as distinct from the horticulture of private establishments for which Britain has so long been famed. Supplying the rapidly increasing population of our large cities with fruit, flowers, and vegetables has proved a profitable employment for thousands of keen energetic men who possess an intimate knowledge of the practical details in what may be termed economic horticulture; for the inexperienced, the slow, or the careless there is no room. Hard work, with head and hands in a systematic manner, and directed by sound judgment, produce results that in some cases can only be described as marvellous. Dozens of market growing establishments round London alone could be named that afford extraordinary instances of rapid advance under good management to their present condition. Acres of land covered with glass houses, where Grapes, Tomatoes, and other fruits are produced by scores of tons, plants and flowers by hundreds of thousands for the great markets. In all these, however, the business method adopted is practically the same—namely, the produce is either consigned to salesmen in different districts, or the market man acts as his own salesman; the trade, therefore, being essentially wholesale. In a few cases, however, chiefly with regard to small businesses, the retailer has found it convenient to be also the producer, and by the aid of a nursery or market garden has kept his shop supplied direct, thus saving two profits. In the example about to be described this principle has been adopted, but upon a much larger scale than before, and to a man possessing large capital it obviously affords, under certain conditions, an opportunity for materially increasing his returns.

Hillingdon is a quiet little Middlesex town about a mile and a half from Uxbridge, and though hitherto of small moment in the horticultural world, it is destined to become celebrated as the site of a "Fruit and Flower Factory" of unusual dimensions and surprising character. Mr. William Whiteley, "the Universal Provider," of Westbourne Grove, has gained a world-wide reputation for the rapid development of a colossal business, and though the history of his progress cannot be recorded in these pages, it is worthy of remark that energy, system, and enterprise have evidently constituted his guiding motto. In a calendar issued by the firm it is stated that the business was commenced on March 11th, 1863, and the fact that such a place as that here described is required to supply the demands of only *one* department is a sufficient indication of what has been accomplished in less than thirty years.

About nine acres of land were taken at Hillingdon a short time since, and last year proceedings were commenced to convert this into a nursery for supplying the central retail business with fruit, flowers, and plants. An experienced practical man as superintendent was the first requisite, and such a one Mr. Whiteley found in Mr. Godfrey, who at once entered into the spirit of the

enterprise, and has thoroughly grasped its scope and importance. The land was surrounded by a substantial wall 14 feet high, with another about the centre, dividing the space into two nearly equal divisions. In one of these work was commenced by an elaborate system of drainage, rendered especially necessary by the heavy character of the soil, but it is facilitated by a moderate slope to the south-east. A good portion of the soil has also been rendered more useful by a "burning," and the ballast thus produced has proved of great service for mixing with heavier material for borders, and also in the houses for stages, upon which plants are arranged. A plan for covering the greater part of the land in the division with glass houses was next carefully considered, and ultimately the work of erecting the houses was allotted to Messrs. Messenger & Co. of Loughborough, who have performed their task in an eminently satisfactory manner. There are in all some seventy-one structures, varying in size from 160 to 672 feet, with numerous frames, and the whole are of a light yet substantial and elegant character, such as we have never seen surpassed in any nobleman's garden. The houses are chiefly span-roofed, but some are three-quarter spans and others are lean-to's, and throughout one of the distinguishing features is the avoidance of central pillars and supports, the rafters and roofs being strengthened by neat cross-ties of iron, giving them quite an ornamental appearance while economising space. The principal houses are in three great blocks running south-east to north-west, a nearly equal number of houses being parallel in each block, with rods between the ends of the adjoining blocks. Spacious tanks run crossways through the centre of each group of houses, and provision is thus made for an abundant supply of rain water, as the collecting surface is a large one. Beyond this, however, a tank of considerable dimensions is being constructed to collect the water from the roofs of sheds and offices. A well has also been sunk, and with an engine, water tower, and tank at a good elevation, not only is a supply ensured, but considerable force can also be obtained when needed.

The heating arrangements have been made with much judgment and care. Trentham boilers are used in pairs for the different blocks, so that they can be worked separately or together, as desired or necessary. During the recent severe weather they have proved quite satisfactory, and no difficulty has been experienced maintaining the requisite temperature over so large an area. Plenty of piping has been employed, and in most cases the pipes instead of being in blocks are distributed over the house to ensure a greater equalisation of the temperature. Ventilation is provided for by a lever arrangement which opens the roof ventilators for a good length, and side ventilation is effected by sliding shutters or similar contrivances.

With regard to the houses individually and their occupants it will be impossible to give a detailed description within the limits of an article in the *Journal of Horticulture*, but it may be remarked that the whole of the houses are not yet filled, and as their erection was not commenced until last summer the work must have been conducted with magical speed to have accomplished so much in a few months. The houses in the large blocks already mentioned are principally devoted to Roses, Orchids, Cucumbers, Melons, Beans, Tomatoes, Strawberries, Peaches, forcing bulbs, with other flowering plants, and for propagating stock. In the Rose houses, of which there are several 270 feet long each, the varieties—*Maréchal Niel*, *William Allen Richardson*, and *Niphetos*, all on the seedling Briar—are planted in borders about 3 feet wide on each side of the path, and are making capital growth. Much attention is being devoted to Strawberries, and a three-quarter span house with a stage at the back, and of similar length to those just described, contains a large stock of *Noble*, of which 10,000 are being forced; *La Grosse Sucrée*, *Auguste Nicaise*, *President*, *Sir Joseph Paxton*, *James Veitch*, *Sir Charles Napier*, and *British Queen* being the chief of the other varieties grown. A lofty structure near this, 24 feet wide and 270 long, is to be filled with large Palms and other specimen foliage plants; for such it is well adapted, but at present only a few have been obtained.

A series of houses of moderate width, with roofs at a sharp angle, have been planted with Peaches and Nectarines in all the most approved varieties, and another larger lean-to against a wall at the upper part of the ground is similarly occupied, from which a large supply should be obtained when the trees are in full bearing. The vinery is next reached, and that is an astonishing structure, a lean-to facing east by south. It is 672 feet long, really in two sections, but practically constituting one house in seven divisions. The back wall is 14 feet high, and with 19 feet length of rafter it can be imagined that the Vines will have plenty of space to extend. These are planted 4 feet apart, an inside border communicating by arches in the front wall with a border outside, which has been duly concreted, drained, and prepared in the orthodox manner. In most instances a division is devoted to one variety, as *Lady*

Downe's, *Black Hamburg* (two), *Muscat of Alexandria* (two), *Gros Colman*, but *Buckland Sweetwater* is associated with the *Black Hamburgs* in one house, and in the last of the range we find *Alicante*, *Alnwick Seedling*, and *Gros Maroc*. The houses are arranged for succession to cover a long period of the year, while for the earliest supplies a house in the lower block has been appropriated to Vines in pots. The last named house was an extremely attractive one at the time of my visit, a week ago, as the Vines (*Black Hamburg*), after some trouble, had "broken" very regularly and strongly, showing abundance of vigorous bunches, and being trained to the roof they formed an arched bower of fresh greenery of a most pleasing character. The results from this house are also likely to be highly satisfactory, for the present appearance is most promising. There, also, three divisions are arranged for succession.

Now we come to the Orchids, which hold an important position at Hillingdon, and have proved so satisfactory that still more space will probably be assigned to them. Several houses are occupied with strong well selected plants of the most freely flowering and useful forms, as the flowers are in much demand at the Westbourne Grove headquarters. *Coclogyne cristata* is an especial favourite, the flowers of great size and substance, one

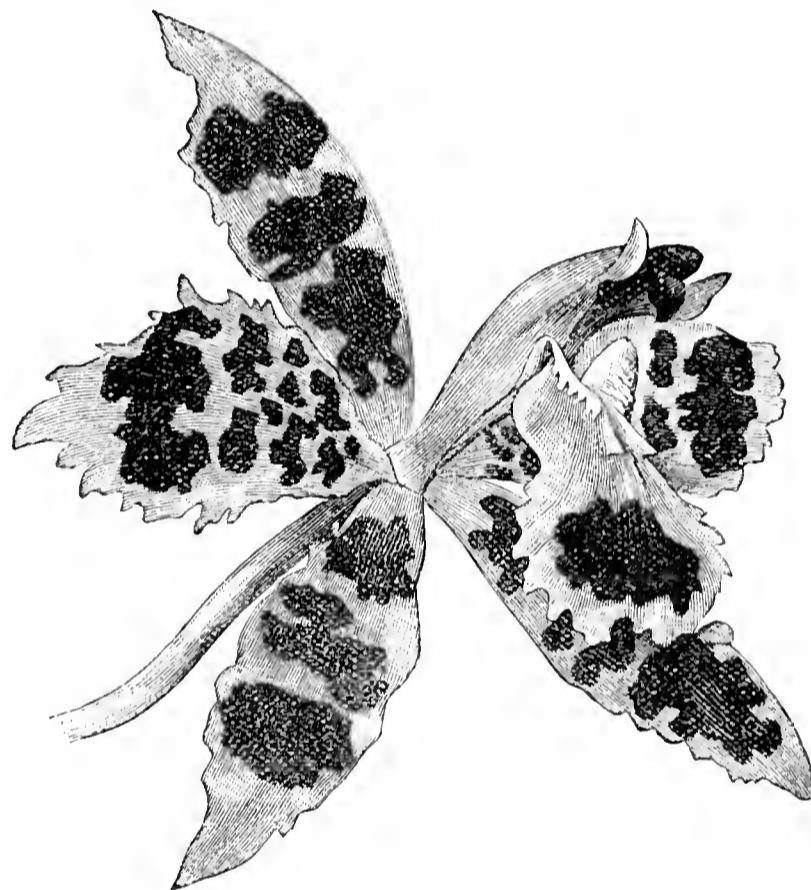

FIG. 27.—ODONTOGLOSSUM TRIUMPHANS, WHITELEY'S VAR.

specimen having had 170 flowers open; *Cattleya Trianae* is represented by vigorous specimens either in flower or showing abundance of sheaths, and some fine varieties have already been noted; *Laelias autumnalis* and *anceps*, *Lycastes*, the rich orange *Laelia harpophylla*, *Cypripedium villosum* and *insigne*, with *Dendrobium nobile*, *crassinode*, and *Wardianum*, are all grown in quantity. *Oncidium* in capital plants and good varieties furnished a beautiful display at the time of my visit, and the attraction of this handsome Orchid cannot be overvalued for all kinds of floral work. Another special favourite is *Odontoglossum triumphans*, of which there are some admirably grown plants with large flowers, and amongst them was found the variety which was shown at the last meeting of the Royal Horticultural Society, and duly honoured by the Orchid Committee as one of the best in colour, form, and size that has ever been exhibited. In fig. 27 is depicted a sketch of one flower from the strong raceme borne by the plant in question. *Calanthe Regneri*, *Odontoglossum triumphans*, *O. Alexandrae*, *O. Sanderianum*, and *O. Pescatorei* are also well grown, and it is evident that not only do the houses suit Orchids exactly, but Mr. Godfrey knows just the treatment they require, and plants that produce blooms saleable at 6d. to 1s. each are worthy of all attention.

In the forcing houses *Eucharises*, *Lilies of the Valley*, *Azaleas*, *Gardenias*, *Freesias*, *Deutzias*, *Tuberoses*, *Stephanotes*, and countless other plants are grown in large numbers. Provision is being made for a large supply of Tomatoes, *Hackwood Park* and *Trophy* being the selected varieties; *Conférence* is also to be tried. *Kidney Beans* are advancing well, considering the season; also *Cucumbers*,

of which a supply has been had during the winter months. All these, and much more, must, however be passed over with a few words, but mention must be made of the Mushroom house, 180 feet long, as that is a special feature. It is well constructed, with the object of preserving an equable temperature, and four beds extend the whole length, with a path in the centre. The lower beds are partially devoted to Seakale and Rhubarb, while Lilac is placed in the central space, but the greater portion of the beds is occupied with Mushrooms, of which there is an excellent crop, and some of the beds have been in bearing for a long time.

Against the walls are sheds, stables, workshops, bothies, offices, store houses, and every convenience for a "factory" on such an extensive scale. The whole business is conducted in a most systematic manner, and this is one of the essential features of success. The daily work of every man is entered in a book, for revision by the chief, and lists of all produce for headquarters are sent with it, besides being entered on a counterfoil, which is priced upon the reception of the returns. Something of a similar kind is followed throughout the business, and Mr. Whiteley appears to be one of the few masters of great commercial concerns, who know every day their precise financial condition. I need only add to these notes that my visit was rendered very agreeable by the courtesy of the able manager.—LEWIS CASTLE.

TREES.

THE BIG AVENUE AT ASHBY FOLVILLE.

It is not of a fine old avenue that I have to tell now, but of the planting of a new one, in view more especially of recording in the Journal the date of the planting, so that when the trees gain size and the avenue becomes so fine a feature as to excite attention and inquiry, reliable particulars of the age of the trees may be forthcoming for the satisfaction and guidance of posterity for the next three or four centuries. For the sight of a fine avenue of trees gives rise to the question, "How old are they?" and the answer is almost invariably vague and unsatisfactory because no reliable record of the planting is forthcoming. Mention may be made of one remarkable exception at Althorp Park, the seat of Lord Spencer in Northamptonshire, where date stones were first used at the planting in the sixteenth century, and continuously down to the present time. The fact is all the more important from the numerous magnificent specimens of old timber there. It has been my good fortune to see very much of our best timber, but I know none which affords more valuable lessons to the planter than that at Althorp.

It will be understood why the Ashby Folville avenue is considered of sufficient importance to have special mention when I explain that beginning near the Manor House it ends at a distance of a mile and a half from it, running due south over a boldly undulating surface, first passing over a gentle eminence down into a valley, and thence upwards to the highest part of the estate, so that eventually it will become a conspicuous feature in some of the most attractive scenery of Leicestershire.

To mark the lines with precision a theodolite was necessary, and by using staffs of white deal for marking the stations the work was not difficult. The avenue is 80 feet wide, and the trees are 50 feet apart. They are the true English Elm, about four years old from the bud, for every tree is worked so that uniformity of growth is a certainty, and they are full of health and vigour in roots, stem, and branches, the average height being about 12 feet. The soil is a fairly deep loam, the subsoil clay, of such retentive nature as to render thorough drainage necessary. The stations were excavated 2 feet deep, and the bottom of each station broken up another fair spit, so that soil and subsoil were broken up to a depth of upwards of 30 inches. The whole of the stations were opened before any planting was done, and so much rain and snow fell during this part of the work that many of the holes became full of water, others had less water, and some had none at all, for in some places the loam was so deep that the natural drainage sufficed to carry off the water. Every station which held water had a row of 2½-inch pipes placed across the bottom of it, and the drain was either continued to and connected with the nearest ditch or land drain, or continued sufficiently far down the slope to ensure the thorough drainage of the station. The soil was then replaced, the turf sods being chopped up and mixed with it, enough fine soil being put aside for working in among the roots of the trees, one man holding the tree in its exact position, another spreading out the roots at full length and working the fine soil well among and around them with his hands, two other men throwing in the soil, which was pressed firmly about the roots and stem by careful treading.

The planters were followed at once by others, who fastened each tree securely to a stout bamboo staff, the string going over a

thick pad of hay placed around the stem for each tie. Next came others with bushes and withes to make a sufficiently stout guard around each stem to keep off the cattle, which appear to be out on the Leicestershire pastures all the year round. The trees were thus rendered safe in every way for the moment, till the triangular guards, 7 feet 6 inches in height, of stout unsawn larch poles were made. The lower ends of the poles were first charred in a fire, so that below the surface of the soil, and 2 or 3 inches above it, each pole has an exterior of charcoal, and decay is thus prevented. The poles are 2 feet from the bottom of the stem, and 1 foot from it at the top, upon which there is a cap or bar of larch, with six other horizontal bars to each panel. We have thus a thoroughly strong guard, injury to the roots from driving in the poles is avoided, and there is much less risk of the ground ever being loosened in the soil by the rubbing of cattle than when the poles are upright or have the tops sloping outwards instead of inwards, and the appearance is neat and entirely satisfactory. The estate carpenter wished to introduce a little fancy work with diagonal bars, but this was prevented by a well-merited compliment on the neat and satisfactory appearance of the horizontal bars, as the expense in the aggregate must be considerable for so many guards, an avenue of Beech trees and many mixed clumps and belts having to be done as well as the big avenue.

The object of having such care bestowed upon the stations was to ensure the trees becoming established quickly and to induce vigorous growth from the first. Once get them well established in the stations and fine trees are an absolute certainty in such soil. My aim was not only to plant the trees well, but so to leave them that their safety and progress were assured as far as possible. Occasionally a station was made sufficiently near to old trees for roots from them to be cut through. In every such instance an open trench was made between the station and the old trees, sufficiently deep to cut through all roots established in the soil, and as a necessary precaution against the young trees being starved by the old ones. On Monday, November 17th, 1890, the first two trees at the north end of the big avenue were planted by Mr. R. Smith-Carington, his son, Mr. H. H. Smith-Carington, and his grandson, bonnie little Folville Smith-Carington, whose share of the work consisted in holding a branch. The last trees were planted at the south end of the avenue on December 8th. The work had been much hindered by a heavy fall of snow, but every tree was so well planted that there ought not to be a single failure.

The Beech avenue was planted in the course of the next few days for a carriage drive. It is 70 feet wide, and the trees are the same distance apart. It must be owned that general effect had more influence upon the width of this avenue than any consideration of the full development of the trees. But this is a matter which must be held in reserve for another paper.—EDWARD LUCKHURST.

FOUR-INCH CARNATIONS.

It is really a rash proceeding to express any doubt as to what we may expect next in the way of size or other distinctive feature in any popular florists' flowers, so that Mr. John Thorpe's prophecy (page 112) may come to be realised in all its fulness, even to the dollar apiece. The ideal flower, however, is not quite a novelty. In saying this, reference is not made to the sprawling monstrosities which have become so common of late years, some of which have been termed "Malmaisons," but wanting in every characteristic of these queenly flowers save the kinship of carnationhood. Here let me say that the true "Malmaisons" under good treatment develop one-fourth of their flowers quite 5 inches across, the remainder being slightly smaller. I cut at least 300 blooms last season over 5 inches across, and many of them 5½ inches. There is simply no Carnation which can in any way approach well grown Malmaisons, and very few other flowers.

Last year I grew Madame Arthur Warocqué to that size named. This winter one rat or more has selected the plants of this variety as good eating out of a frameful of 1300 plants, and what may be the result this season I cannot say.

Éillet de Paris is even larger than the above, and promises to be a fine kind, but after three seasons' trial I should say it is shy of increase. Comtesse de Paris also produces 4-inch blooms. Few sorts are more attractive than is this. It is of the strong growing habit so characteristic of the Carnations raised in France, forces quite readily, and, indeed, is best, at least in our latitude, when cultivated under glass. There are many more of the same type, and this year I have on trial a collection selected to produce large flowers with good non-splitting calyces; but no doubt the calyx which large flowers require is that of the short, firm, clasping nature we find in the true "Malmaison." It "bursts," no doubt, but not in the half-hearted, one-sided manner of the sorts which

are reputed calyx splitters. If a "Malmaison" is examined it will be seen that the calyx is split at each natural division, and consequently acts as a support to the entire circle of petals. In Madame A. Warocqué the same arrangement is found. In the ordinary split-calyx sorts, however, only one division is split open, and the petals sprawl in the manner so annoying in the ordinary large-flowered types.

It is uncommon to find long-calyxed flowers produced of a large size without a split occurring. Comtesse de Paris, already referred to, sometimes transgresses. Germania, which expands to quite 3 inches, does not; therefore, I think, if large flowers are to continue to be in demand as at present, the successful raiser of new sorts will be he who takes the calyx of the "Malmaison" as a type, and works on these lines.—B.

HOW THE PARISIAN MARKET GARDENERS FORCE LETTUCES.

(Continued from page 103.)

SHOULD the Tennisball Lettuce not be headed when there is no more risk of any frost, it would be good to remove the frames entirely and leave the plants to develop in the open air. These Lettuces, when planted in January, are ready for sale towards the end of March. The Tennisball Lettuce may also be planted on the same beds under bell-glasses set in three cross lines instead of the frames, and in that case we plant three Lettuces under each bell-glass, protecting them against cold as advised for the plants on the sloping beds, and giving air whenever weather permits. Thus treated the Tennisball, planted in February, heads in the beginning of April.

Lastly, that variety may also be planted in the open ground under bell-glasses. For that culture we stir and pulverise the soil well, and after having raked it in the usual manner, we spread over it a little more than 1 inch of compost, which is levelled with a garden rake and then pressed or patted down well. This done, we place over it three rows of bell-glasses, under each of which are pricked out three Lettuces, admitting air when necessary after they are well rooted. Planted out in February these Lettuces are fit for use towards the 15th April.

The Cos Lettuce most grown for forcing around Paris is the Green Cos, which is treated in about the same way on sloping beds under bell-glasses as the Crisped Small Early; but that variety (Green Cos) being fond of air, the bell-glasses are tilted at the back with pieces of wood in the middle of the day during November whenever weather permits, and the lights (bell-glasses) are closed again in the evening. During severe frosts the plants are handled in the same way as the crisped small black seed Lettuce, and when there is no more danger the litter is removed, first from the top of the bell-glasses, then gradually all around, and air is admitted whenever weather allows. In January or February the finest of these Cos Lettuces are selected to be planted on hotbeds under bell-glasses, one Cos Lettuce being placed in the centre of four black-seeded crisped small varieties to each glass. These Cos Lettuces are the first which come to the market in the beginning of March.

The remaining plants on the sloping borders must be protected against cold if necessary, and all fine days be taken advantage of to provide a little ventilation by tilting the bell-glass first $1\frac{1}{2}$, then 2, 3, 4, 6 inches, according to the temperature; and when all risk of severe weather seems to be over the bell-glasses are removed entirely to induce a sturdy growth before the plants can be transferred to their final position either on a hotbed or in the open ground. At the end of January or during the first fortnight of February, if the ground is not frozen, all our market gardeners plant the green Cos Lettuce on beds sloping southwards. Where beds are formed in the usual manner, some seed of French Horn Carrot, Parsnip, or Leek, is thinly sown at the same time. The bed is then harrowed to cover these seeds, the rake passed over about an inch of compost extended over it, and the drills or lines traced with the feet, then planting the finest of the Cos Lettuces with a good ball and all their roots at a distance of about one foot.

When the beds are large and well situated the gardeners use two or three of the fourteen or fifteen drills composing the bed for half-hardy Cauliflowers set out at the same time as the Lettuces. Although the green Cos Lettuce is self-folding, it is better to bind it at about three-quarters its height with raffia bast or a wet haulm. Should a long spell of dry winds be experienced during March or April the plantation on the sloping borders must be watered. The Lettuces thus planted in the beginning of February are usually saleable towards the middle of May, and the Cauliflowers planted along with them are fit for sale towards the first week of June.

For Lettuce forcing the temperature ought not, as far as

practicable, to exceed 15° Cent. (about 59° Fahr.). There are some other useful forcing Lettuces, as the Georges, red-edged Victoria, white and grey Cos Lettuces, with which those interested in the matter may make a trial.—EUG. SCHÆTTEL, *Paris*.



JOTTINGS.

A FRIENDLY reader says that he "likes" the Orchid jottings I have from time to time contributed, and "would be pleased to see more of them;" some generous critics persuade me that this is a general opinion, and so I will try to provide a few notes under this heading more frequently. At the same time let me remind all those who are interested in Orchids that items of news and personal experience are most welcome to other readers, and it is by mutual help in this way that the best service can be rendered to the conductors of the Journal, who are ever striving to render their pages instructive in all departments of gardening.

For example, in one of my notes last week I called attention to the injury caused by city fogs to Orchids, both in flower and growth. Now, the damage is by no means uniform, and it would be important to ascertain the experience of several cultivators on the point. If a list could be prepared of the Orchids least affected or uninjured by fogs it would be a material help to Orchid growers in towns, and would be the means of avoiding much after disappointment. The President of the Royal Horticultural Society recently referred to the fact that friends of his had been compelled to discontinue the culture of certain Orchids owing to the evil results of the pestilential fogs. In any wholesale condemnation like this there is sure to be some injustice, for there are Orchids which unquestionably stand the trying atmospheric conditions without any perceptible injury. Let our amateur and professional friends come forward, then, and tell us their experience, and I will add to this the result of my observations extending over a period of twenty years.

No better indication of the popularity of Orchids could be afforded than by the fact that they are becoming "market plants." Not many years ago it was comparatively rare that Orchid flowers were seen in Covent Garden, now probably on no day throughout the year would the florists' shops in the central row be found without some representatives of that varied family. At times, too, there is quite an abundance of these flowers, and they also take their place in the ordinary wholesale market with the Stephanotes, Eucharis, Gardenias, and other choice flowers, which cultivators who have to study their returns very closely have found it worth their while to grow. What, for instance, can surpass the graceful *Cœlogyne cristata* for sprays, wreaths, and wedding bouquets? Then for richness of colouring *Cattleya Trianae* and its successors of the *C. labiata* type are unsurpassed. Such *Dendrobiums* as *nobile*, *Wardianum*, and *crassinode* are invaluable as buttonhole flowers, because they stand exposure so well. For striking characters of form and peculiar tints the *Cypripediums* are unrivalled, while the delicacy of *Odontoglossums crispum* and *Pescatorei*, and the fine yellow tints of many *Oncidium*s afford a wide range to select from.

Time will not admit of further notes this week, for I am about to start on a little continental tour, concerning which I hope to tell Journal readers something in an early issue. But I cannot conclude these remarks without a word respecting the death of my old friend Mr. John Dominy; it is the talk of the Orchid world this week, and many besides myself will sincerely regret to see the news announced on another page. Mr. Dominy had worked well in the Orchid cause for half a century, and his success redounded to the credit of the great firm which has treated him so generously in his old age. We have good and clever orchidists still with us, but let us not omit to do honour to one who had been a leader in his day and generation.—L. C.

ANGRÆCUM FRAGRANS.

So few Orchids possess any economic value that those which have any special characters in that way are of more than common interest. In the "Botanical Magazine" for the current month an

illustration is given of *Angræcum fragrans* together with the following description:—

“The interest attached to this little Orchid is due to the persistent Vanilla-like odour of the leaves when dry, which has led to its use as a tea in Bourbon, the Mauritius, and even to some extent in France. According to a notice in the ‘Gardener’s Chronicle’ (1850, p. 599) of an article on this plant by a M. Gobley, communicated to the ‘Chemical Gazette,’ it is considered a digestive, and even recommended in diseases of the respiratory organs. The popular name is variously spelled Fahame, Faham, Fahan, Fahon, Fahum, and Faam, of the origin of which I have no information. It is a native of both Bourbon and the Mauritius, from which last-named island plants were received in 1887 at Kew, from Mr. Horne, F.L.S., Director of the Botanical Gardens, Pamplemousses, which flowered in January of last year, and were very sweet scented.

“With regard to the genus *Æranthus* to which *A. fragrans* is referred by Reichenbach and in the ‘Flora of Mauritius’ it is to be observed that it was founded by Lindley as *Æranthes* (altered to *Æranthus* in ‘Vegetable Kingd.’), for the *Dendrobium Arachnites* of Thouars (‘Orch. Afr.’ t. 88), and another species, *A. grandiflora* (‘Bot. Reg.’ t. 817; ‘Bot. Mag.’ t. 6034, misspelt *Æranthus*), to which he incautiously added as a third a true *Angræcum*, the *A. sesquipedale*, *Thouars*. Of these the two first differ notably from *Angræcum* in habit and form of flower, in the elongate foot of the column, and the singular spur, and as Bentham remarks (‘Gen. Plant.’ iii. 576), they are more allied to *Ærides* than to *Angræcum*. Reichenbach, on the other hand, has without comment (‘Walp. Ann.’ vol. vi., 899) introduced a crowd of genuine *Angræca*, including *fragrans*, together with species of other very different genera, into *Æranthus*, *Reichb. f.*, but omitting both Lindley’s species, though at the same time citing *Æranthus*, *Lindl.*, as a synonym of his *Æranthus*.

“Description:—Stem 6 to 10 inches long or more, about as thick as a goose-quill, scandent. Leaves few, towards the top of the stem, 3 to 4 inches long by half to three-quarters of an inch broad, spreading and recurved, lorate, deeply two-lobed at the tip, lobes rounded, deeply channelled down the centre, margins recurved. Flowers solitary, axillary or supra-axillary; peduncle ascending or erect, with the ovary 2 to 2½ inches long, rather stout, sheaths and sheathing bract appressed. Flowers 2 inches in diameter across the sepals, pure white, fragrant; sepals and petals linear, spreading and recurved, obtuse. Lip about as long as the sepals, hastately lanceolate, acute, grooved down the centre; spur slender, rather longer than the sepals, green. Column very short, sides subauricled; anther hemispheric, ridged on the crown; pollinia attached one on each side of the acute apex of an oblong entire strap.”

In the Kew museum specimens may be seen of the prepared leaves as sold in France.

ECONOMIC FRUIT GROWING.

THERE may be some truth in the statement that any method of fruit-growing is economical if conducted on systematic and well-founded principles, but that at the present moment is not so commonly adopted as might be expected. I know full well there are hundreds of establishments where the gardener cannot carry out fruit-planting speculations; but there are, at the same time, many gardens that could be made more productive by tree-planting, and that, too, without incurring a large expenditure. What I am referring to is the utilising of the spaces occupied by garden paths, and it might be asked, How often can such spaces be found contributing to the extension of the fruit supply, or towards the outlay required in maintaining them in presentable condition?

It is quite true that the orthodox garden arches are expensive, so, also, might trees be suitable for filling them quickly; but costly trees or ironwork I do not advocate. Maiden trees, everyone knows, can be secured cheaply enough, and there is common evidence that these cheap trees are much more largely planted at the present time than in former years. These are what might be planted so as to turn the garden paths to profitable account, inserting them at distances apart consistent with prevailing circumstances. They may be planted at 6 feet or 6 yards asunder, or any intermediate distance suited to the will of the operator or the purchaser, previously fixing some iron rods of a length sufficient to be bent over and inserted in the ground or each side of the walk, and of such strength as to make the work remunerative. Sufficient head room must be allowed for free passage beneath.

If these being in position, the next provision must be something to prevent their displacement by wind, which, however, may not be necessary for the first two or three years. In the one instance only I saw moderately strong wire strained overhead, so as to

connect altogether the whole length of the arches, the ends of the wire being fixed to a wall. Failing this the end rod might be supported by a couple of tolerably long spurs, or with wire attached to short plugs driven in the ground behind them.

The trees being planted in pairs are trained to meet each other at the top, but instead of their growth being suspended at this stage they are allowed to extend each in an opposite direction along the central overhead wire until the space is furnished. Ordinary fixed arches, valuable though they are, interfere greatly with the access to the vegetable or other fruit quarters, so also do espalier and low cordon-trained trees when a continuous wire fence is adopted for training them; but such an objection cannot be raised against the system here alluded to, because they may be disposed at distances allowing of an easy passage between.

I have previously remarked that only one instance of this simple and inexpensive style of tree growth have been noted, and it had its origin in this case by the failure of the low cordons that were planted as an edging to the fruit quarters, which was a walled space set apart exclusively for fruit growing. The gardener at that time, being of an unusually inventive and original turn of mind, conceived the idea that by changing their position from the usual low level to a simple arrangement spanning the path the growth would be better situated for gaining more perfect maturity, and this course not only added to the extent of the crop, but greatly to the appearance of the enclosure, thus combining pleasure with profit in a marked degree. Apples and Pears are the only fruits thus treated, but Plums, or even Gooseberries, might be so planted for imparting variety and change to the scene if this were needed. If carried out only to a moderate extent the plan is well worth consideration, particularly to the owners of small gardens, where much ground cannot be given up to fruit culture; but there may possibly be some large establishments where the supply is scarcely equal to the demand in the matter of dessert.—W. S.



EVENTS OF THE WEEK.—To-day (Thursday), February 19th, the Royal Society will meet at 4.30 P.M., and the Linnean Society at 8 P.M. The Quekett Club assemble at 8 P.M. on Friday, February 20th, and the Royal Botanic Society on Saturday, February 21st, at 4 P.M. On Wednesday, February 25th, the Society of Arts will meet at 8 P.M.

— THE WEATHER.—Since our last issue no rain has fallen in the metropolitan district, and the soil, through having been so thoroughly frozen, turns up in admirable condition for working and planting. Slight morning frosts have occurred, and on Tuesday a somewhat dense fog prevailed, rendering artificial light a necessity in London over a considerable part of the day. The fog continued on Wednesday.

— BISMARCK APPLE.—In reference to the correspondence about this Apple it is quite true Mr. Palmer sent us trees of it in 1879, with a rough sketch of the fruit, and spoke of it very highly; but coming from such a warm climate as Auckland we were doubtful if it would be suitable for this country, consequently did not give it that attention it deserved. We fruited it in the open quarters, but unfortunately could not save the fruit. It was not till we saw the fruit exhibited by Messrs. Veitch at the Crystal Palace that we discovered its merits, and when we told their fruit foreman that we had a good stock of it and many in a fruiting state he would scarcely believe us. At the same time we found out that they were not prepared to send it out that autumn; but in consequence of their having brought it into notice and receiving the certificate for it, we arranged to waive our right of sending it out until they had their stock ready for disposal the following season.—JOHN LAING & SONS.

— FROST EFFECTS.—I have not yet seen it in print what a peculiar sheen remains to the fruit and all other deciduous trees since the departure of the silver rime that made them look so beautiful for so long. They appear as if an ashen-grey wash had been carefully painted over them, even to the tips of their tiniest sprays. If it will but act as a wash and extirpate the tribes of vermin that trees have been afflicted with the last three years how thankful we all should be. I grow a fair sprinkling of choice Conifers and other evergreens which have been presented to me as keepsakes by old friends. Excepting Golden

Hollies, Bays, *Choisya ternata*, and *Veronica Traversi*, the late frosty ordeal seems at present to have let them off fairly well.—R. FENN.

— A NOTE ON PARSLEY.—I am one who has been fortunate with Parsley this winter, and perhaps my note may be useful to some of my brethren who have suffered a Parsley famine this last season and present winter. I have a range of lights which I use for early Potatoes in the spring and saladings in the late autumn and winter; but as my kitchen chief "goes in" for a large amount of Parsley, which must be had, I sow in drills about 8 or 9 inches apart each summer, immediately the Potatoes are off, a few of the lights with Parsley. This will be, on an average, about midsummer. The lights are left off until the very cold weather sets in. The Parsley has grown well by that time; some of the drills have been cut, and the Parsley dried, the rest is left, the result being that I have Parsley galore all through the winter.—N. H. POWNALL, *Lenton Hall Gardens*.

— CANKER AND FROST.—Mr. J. Hiam writes:—"I have been very anxious to learn what effect the late severe weather would have on my fruit trees, which I claim to have cured some years ago on the theory that insect life was the cause of the injury, and none of the many other remedies suggested being used. I have just made a careful examination of several varieties of Apple trees said to be especially liable to canker, and am pleased to find most of them apparently uninjured. I enclose samples of the most tender wood from the trees, so tender that if it were not for the discoloration of the leaves one might imagine it nearer midsummer than February. Dumelow's Seedling, Lord Suffield, and Hawthornden show no signs of injury. Ribston Pippin, hitherto quite free from canker on this tree, shows signs of injury from the frost, which may, or may not, develop into canker. I shall look after the results most carefully."

— BULLFINCHES.—Mr. Hiam continues:—"I hear these birds are playing sad havoc with the fruit buds in many quarters. I am troubled less than usual, as may well be imagined when no less than fifty-three have been caught in trap cages in my garden this season, and three others shot which would not be persuaded to share the good things provided for their accommodation in the traps. When we consider that these birds will pinch off the bloom buds at the rate of over twenty in a minute, some idea of the fruit saved somewhere in the district may be imagined."

— FRENCH JOURNALS state that the great GRAPE COUNTRY OF CHAMPAGNE, which as yet has been free from the phylloxera, is now threatened by the dreaded pest. In the commune of Trélop in the Department of Aisne, and close to the borders of the Department of the Marne, several colonies of the phylloxera have recently been discovered, and although, of course, the most energetic measures of isolation and extermination were at once begun, there is great alarm lest the Marne district—the great champagne-producing lands—may be infected, as a brisk trade has been carried on by them in the importation of Vines from the now infected village of Trélop.

— VEGETATION IN SOUTHERN CALIFORNIA.—In his recently published article on Southern California, Mr. Charles Dudley Warner says that the new City of Riverside occupies an area some five miles by three, and that "one avenue through which we drove is 125 feet wide and twelve miles long, planted in three rows with Palms, Magnolias, the *Grevillea robusta*, the Pepper and the Eucalyptus, and lined all the way by splendid Orange groves, in the midst of which are houses and grounds with semi-tropical attractions. Nothing could be lovelier than such a scene of fruits and flowers, with the background of purple hills and snowy peaks." Yet in 1872 there was only a "poor sheep ranch" where this city of some 6000 inhabitants now stands.

— JAPANESE CHRYSANTHEMUM BEAUTY OF CASTLEHILL.—Mr. Robert Owen of Maidenhead sends us a handsome bloom of the above-named variety, which is said to be the result of a cross between *Gloriosum* and Mrs. Falconer Jameson. It is somewhat of the Criterion type, with larger, narrower florets of a bright reddish bronze in the centre, fading to yellow in the outer florets. Mr. Owen says:—"As you are aware, the best blooms cannot be produced at this season of the year. I have still a plant in bud, and will not be open before March. The first bloom of this variety expanded about middle of October last, and I have had blooms of it every month since. It was certificated by N.C.S., and again shown by me in good form in January. It is a little uncertain as to its time of flowering, consequently several plants should be grown to secure blooms for exhibition at any given time."

— GARDENING APPOINTMENT.—Mr. J. MacDonald, late gardener to J. Hamlyn Borriew, Esq., Angeston, Dursley, has taken charge of the gardens of Captain Marling, Clanna, Sydney, Gloucestershire.

— A LARGE TREE.—A correspondent in "Notes and Gleanings" (page 86) naturally asks how the 22-foot saw is to cut through the large tree 33 feet in diameter. It occurs to me that the teeth portion of the saw may be 22 feet long, but I do not see why a steel bar could not be used to lengthen it out at each end. A few years ago I witnessed three experienced timber-cutters saw through a large Oak tree at the bottom. It took them two days, but it was quite a small saw in proportion to the size of trunk. Two of the men were at one side of the tree and one at the other; but there were no wooden handles, only strong cord at each end that was drawn through each cut. The saw itself did not appear to be longer than the diameter of this tree, if so long. As the sawing proceeded strong wedges were driven in the aperture to make it a little wider, and to make the saw work easier, that I see no reason why a 22-foot saw should not go through a trunk 33 feet in diameter, especially if they had a 10 or 12-foot length of wire rope at each end. The tree above referred to was a splendid butt of Oak grown within 200 yards of my house, and took eight powerful horses accustomed to such work to draw it up on the carriage.—A. H.

— READING GARDENERS' IMPROVEMENT ASSOCIATION.—The fortnightly meeting of this Association was held on Monday evening, when a large number of members assembled to hear a paper on "Orchids," read by Mr. J. Douglas, of Great Gearics. The subject was one of more than ordinary interest to the members, Orchids being grown to a considerable extent in the neighbourhood of Reading. Several of the members exhibited specimens of *Dendrobium nobile* and *Wardianum*, *Lycaste Skinneri*, *Odontoglossum Pescatorei*, *Cymbidium Lowianum*, *Goodyera discolor*, and various *Cypripediums*. Mr. W. Baskett exhibited a magnificent specimen of *Cœlogyne cristata*, fully 3 feet in diameter, and carrying nearly 300 flowers; Mr. Pound, gardener to G. May, Esq., showed a fine plant of *Phalænopsis Schulleriana*, having forty flowers on one spike; and Mr. G. Stanton, of Park Place, sent a very fine spike of *Dendrobium speciosum*, altogether a very imposing group, which added considerably to the interest of the evening.

— VEGETABLES AND THE FROST.—Vegetables in general having suffered so much from the recent severe weather it is interesting to find Broccoli fresh and green, giving promise of a good return of useful heads; growing side by side with Drumhead Savoys, Brussels Sprouts, Red Cabbage, and Chou de Burghley, that are rendered absolutely useless. Even Curled Kale is slightly damaged. Parsley on a border facing south has also suffered much, while that planted under Filbert trees, near to a north wall, has wintered well. The hardiest Broccoli with us is Veitch's Model, then Edinboro' Market and Lauder's Goshen about equal, Backhouse's Winter coming next, while Snow's Winter brings up the rear with about one-half gone bad. Some of those left are already quite fit for use. Heeling over has undoubtedly been the means of preserving the Broccoli; they were thus brought quite close to the ground and well protected by the snow, while the cheek they thus received in early autumn rendered the growth more sturdy and better able to withstand the rigours of an almost arctic winter.—A. D.

— IMPROVING THE GARDEN TROWEL.—Our American friends are always trying to make improvements, and the garden trowel has not escaped their notice. "Sometimes," says the "Agriculturist," "a slight change in the form of an implement or tool will make it more convenient and better adapted to the work for which it was intended. This is very prominently proven by simply grinding or filing away the end of a common garden trowel. All who have had experience in that line know how extremely difficult it is to cut off with the common garden trowel a weed that has a strong tap root. By using a trowel modified as explained the work is readily accomplished. Grind down until it is three-quarters of an inch from point to point, leaving the edge concave instead of rounded as in the ordinary form. It is plain that in pressing into the soil, any root coming in contact with the trowel between the two points is readily severed. This does not in the least detract from the common use of the implement, but greatly adds to its usefulness. Should the concave surface be kept sharp it will now be more effective in every way."

— HORTICULTURAL CLUB.—The annual house dinner of the Club took place on Tuesday last at their rooms, Hotel Windsor, Victoria Street, Westminster. The chair was taken by the President, Mr. John Lee, and amongst those present were the Rev. W. Wilks, Secretary

of the Royal Horticultural Society; Mr. Philip Crowley, Treasurer of the R.H.S.; Mr. H. E. Williams, Past Master of the Fruiterers' Company; Mr. J. Butcher, Solicitor to the Nursery and Seed Trades' Protection Society; the Rev. F. H. Gall, Messrs. T. W. Girdlestone, Harry J. Veitch, J. Herbert Veitch, C. T. Drucry, Henry J. Pearson, H. Wallis, C. E. Pearson, Geo. Prince, H. Herbst, H. Turner, George Bunyard, W. J. Jefferies, A. F. Barron, Joseph Cheal, &c. There was a selection of vocal and instrumental music, kindly given by some amateurs, which had been arranged by Messrs. Bunyard and Turner, and a most pleasant and successful meeting was enjoyed by all present, the only matter of regret being that the venerable and venerated Chairman announced his intention owing to increasing years to retire from his office, which he has found latterly to be somewhat of a burden. The announcement was received with universal regret. He has been Chairman since the formation of the Club, and has always shown great interest in its welfare. The toast of the Royal Horticultural Society was proposed by Mr. Harry J. Veitch, and responded to by the Rev. W. Wilks, who spoke encouragingly of its prospects, and was glad to bear witness to the fact mentioned by the Secretary, that the first step in the improvement of its position was made at one of the dinners of the Club, when the outside Committee was nominated, and he hoped that both the Society and the Club might go on and prosper.

CULTURE OF GREENHOUSE RHODODENDRONS.

[Prize Essay read by Mr. R. G. WATERMAN, Woolton, before the Members of the Woolton Gardeners' Mutual Improvement Society, February 5th, 1891.]

(Continued from page 132).

COMPOST AND POTTING.—These details require the attention of intelligent and practical workers. When it is stated a plant may be kept in the same pot for seven, ten, or even more years it is sufficient to prove that the work must be carried out in the best possible manner. Although they vary considerably in growth and appearance their requirements as to soil are similar. Good selected peat, with all sour portions removed, may be broken up into pieces the size of walnuts, and for very large plants double that size; to this add fully one-fourth of sharp silver sand and a little broken charcoal, to be carefully and thoroughly mixed. Pots should be selected of good shape and well burned, which will be less liable to become green, which is obnoxious to the eye and detrimental to the health of the plant. The pots and crocks alike should be scrupulously clean, and in arranging the drainage select well fitting pieces to cover the holes, placing the hollow side downwards; follow carefully with piece after piece until sufficient is arranged, which should be from 1 to 3 inches in depth, according to the size of the pot. A layer of sphagnum or rough moss over the drainage will prevent the soil being washed down or blocking a free water course. A portion of the roughest of the material can be put in next to the depth required, making it firm, and everything is in readiness for the plant, which must undergo close inspection.

The ball or root should be like the compost, just a happy medium between wet and dry. If the ball or potting soil be soddened or wet the whole will become an impervious mass, in which the young rootlets cannot thrive, as an open porous mixture is one important item towards success. If too dry it will be impossible to thoroughly moisten it after potting, which means death to all the fine fibres that may come in contact with it. If there be any doubt that the plant may be dry at the bottom or centre of the ball place it in a tub of water, just covering the rim of the pot, and let it remain an hour or so, and then after a day or two it will be in safe condition for repotting. Like all other hardwooded plants these require firm potting, using a blunt-pointed stick for a rammer at intervals until the pot is sufficiently full which should be within three-quarters of an inch in small pots to 1½ inch in those of very large size.

No rule can be laid down as to how often a plant should be repotted. Whilst in a young state a small shift may prove beneficial every year or two, but in large specimens seven or ten years will be sufficient. Old plants may remain in the same pots while they continue to make fair growth and are in good health. After potting the plants may stand a day or so before watering, and if a sprinkling of sand be scattered on the top it will wash down the sides if there is the slightest crevice. When planted out in beds or borders the above instructions should be followed. The most approved times or seasons for repotting are spring, early autumn, or immediately after the young growth is made, those especially advised being after the growth is completed for the Java section, and early autumn for the Himalayan and their allies.

THE TEMPERATURE.—That of a greenhouse is required for the

general collection, not less than 55° while making their growth, which can be reduced to 50° afterwards, and in the winter to 40°. These are extreme minimum temperatures. The Javanicum type will require 5° higher than those named. After the growth is completed ventilate freely to ripen the young growth. In the case of young plants a span-roofed frame at this juncture will prove an admirable position. Syringing will prove very beneficial during the season of growth, refreshing the plants and producing a humid atmosphere which they much enjoy.

INSECTS.—Rhododendrons are fairly free from these pests. At times mealy bug will prove troublesome by getting under the scales of the flower buds. If such is the case, great care must be exercised while the foliage is young and tender, but when it is ripened and hard stronger measures can be resorted to in the form of insecticides. Fir tree or lemon oil, Gishurst compound or petrolcum mixed at regulation strength and dropped on the buds will have the desired effect, a washing of clean water to follow the operation. Scale occasionally gets a foothold, but a careful sponging with one of the above-named mixtures will make itself felt. Some of the woolly foliaged varieties, such as Edgeworthi, are more difficult to manage, but determination will win the day.

FEEDING AND WATERING.—An occasional supply of soot water, or a sprinkling of Standen's manure will prove of service if the pot is full of roots and the growth puny and weak. The general management as regards watering is very similar to most hardwooded plants, a plentiful supply during the season of growth, but limiting the amount somewhat after that period, or a second growth may start, which will probably mean the loss of a crop of flowers, and a tendency to weak immature wood. Special care should be taken when the plants are placed on ash or earth spaces to prevent worms entering the holes at the bottom of the pots, which will soon mean defective drainage, sour soil, and unsatisfactory plants. A slate, or some other hard flat surface should be placed for the pots to stand on, or for large specimens three small pots placed in triangular form will prove a secure base.

TRAINING.—All Rhododendrons require some attention in this matter. The strong growers must be watched, or leggy plants will soon be the result. Nuttalli, and those of like growth, must be pruned back occasionally while young, or the growing buds rubbed off; otherwise the plants will represent a series of broomsticks with a tuft of leaves at the point. Veitchianum and Countess of Haddington should be watched, and occasionally a shoot may require stopping, or a tie may be given to keep the plant in bush form. Lady Alice Fitzwilliam, fragrantissimum, Gibsoni, Edgeworthi, and others of similar character will require supporting, which can be done by wire frames in pyramid or globular form. This section can also be utilised as climbers, or for covering walls, where their large evergreen leaves prove effective even when not in bloom. Many of the Java section will require some slight support, which should be done with as few sticks as possible, and fine ties.

SELECTION OF VARIETIES.—Although no mention is made of this matter in the title, yet it appears requisite, for to have a thorough knowledge of the cultural requirements of any class of plants it is essential to have a full acquaintance with their habits, size, and any peculiar traits they may possess, and for this purpose the species may be divided into two sections—the Java, or perpetual flowering, and the Himalayan. In the first named we have the brilliant and beautiful hybrids, for which we are chiefly indebted to Messrs. J. Veitch & Sons of Chelsea, and Messrs. Fisher, Son, & Sibray, Sheffield; and in addition to those well known in our gardens we have R. balsaminæflorum varieties, with exquisite double flowers which have been compared to the Tuberose, Gardenia, &c. The three varieties in commerce bear white, yellow, and rose coloured flowers. Among the stronger growing varieties the following are recommended:—Dalhousiæ (an epiphyte), Falconeri, fulgens, Maddeni, Nuttalli; and for moderate-sized houses the following will be found suitable:—Veitchianum, fragrantissimum, Lady Alice Fitzwilliam, Edgeworthi, Virginalis, and others.

THE LATE MR. JOHN DOMINY.

WE hear with much regret that Mr. John Dominy died at the age of seventy-five on February 12th, after two days' illness, from inflammation of the lungs and pleurisy. The following account of his career, with the portrait, was given in this Journal in 1880, when, after a term of forty-three years' service with Messrs. J. Veitch & Sons, he retired on a substantial annuity. He was born at Gittisham in 1816, and in due time was apprenticed to Mr. Guscott, gardener to the Misses Putt, Pomeroy House, Gittisham, Devon. At eighteen years of age—namely, in 1834—he went to Messrs. Lucombe, Pince, & Co.'s Nursery at

Exeter, and remained there three months. From thence he removed to Messrs. Veitch's nursery in the same town, and remained there until June, 1811. He then went as head gardener to J. Pellagor, Esq., Redruth, and remained in that capacity four and a half years. During that time he took between seventy and eighty prizes for fruit, vegetables, and flowers. He returned to Messrs. Veitch's Exeter Nursery, working

cream jug to match "in commemoration of his having been the first successful hybridiser of *Nepenthes* and Orchids in Europe." He also had the large silver medal of the above Society "for his perseverance and success in raising the first hybrid Orchid," this medal being dated 1858, and refers to *Calanthe Domini*, the result of a cross between *C. masuca* and *C. fureata*. About twenty-nine hybrid Orchids, *Nepen-*



FIG. 28.—THE LATE MR. JOHN DOMINY.

in conjunction with the late Mr. James Veitch until his removal to London, and he remained at Exeter with Mr. James Veitch, senr., twelve years. During his stay at the Exeter Nursery he commenced his first attempts at the hybridisation of *Nepenthes* and Orchids, the results of which have now become so widely known. In 1861 he removed to London to take charge of the Royal Exotic Nursery, Chelsea. On Mr. Dominy leaving Exeter he was presented with a silver tankard and cream jug, value £20, by the Devon and Exeter Horticultural Association, "in acknowledgment of his valuable services to the Society during his connection with Messrs. Veitch," who also presented him with a

thes, and Fuchsias were also raised during Mr. Dominy's service at Exeter and Chelsea. In late years he has been a member of the Orchid Committee of the Royal Horticultural Society, at whose meetings he was a regular attendant.

AMERICAN AZALEAS AND AZALEA MOLLIS.

THESE beautiful and floriferous plants are worthy of more extensive cultivation, as few are so easily forced during the early spring months or give a better return for the labour bestowed upon

them. Large numbers of seedlings have been raised from *Azalea mollis*, which are commonly known as Japanese Azaleas. These appear to be more popular at the present time on account of the greater size of their flowers, and there are few plants so bright and attractive for indoor decoration as well-flowered shapely specimens of these Azaleas, when they are arranged singly in vases or in mixed groups with plants of a dwarf nature. When used in a cut state the flowers are well adapted for filling specimen glasses. The flowers of American Azaleas are not so imposing, being smaller, but on that account they are much more suitable for using in wreaths, sprays, and buttonholes, or for arranging in vases with mixed flowers. They possess, moreover, many beautiful tints, which might with advantage be infused into flowers of the Japanese type.

In the matter of cultivation they require the same treatment. Both are admirable for planting in beds in the pleasure grounds, or in bold masses in the front of shrubberies form a great attraction when surrounded by the fresh green leaves and varied forms of other trees and shrubs. When planted in the open air, if possible a peat bed should be prepared for them, although in some cases they thrive well in the natural soil if a heavy dressing of leaf soil is first given, and I know of one instance in which they grow and flower remarkably well in a strong clay; but as it is only in rare cases that they succeed in soil of this nature, it is, I consider, a wise policy to plant in peat, unless it has been ascertained beyond question that they will thrive in the natural soil.

Where the plants are grown in pots for forcing, a regular system of cultivation ought to be pursued. In too many cases they do not receive enough attention when they have done flowering and the growing season commences, the consequence being that shoots which ought to have been strong and sturdy become weak and stunted—an undesirable state of affairs, which it takes at least a year to put right again. Those plants that have been subjected to a high temperature to bring them into growth should, as soon as their flowers have faded, be again placed in structures where they receive a temperature of from 60° to 70° by fire heat; later plants will require less fire heat, but a little is of benefit during cold nights up to the end of March. Throughout the growing season when the weather is bright the plants should be syringed once a day, and a weak solution of guano water given two or three times a week when they require water at the roots. As soon as growth is fully completed place the plants in cold pits for a couple of weeks to harden before placing them in a sheltered position in the open air. Here they should remain till the end of May. A few of the strongest plants should then be selected to retain in pots and supply the earliest for forcing the following year. As a rule the selected plants are those which carried fewer trusses of flower, and were, therefore, less weakened by the process of forcing than their more floriferous companions, consequently the energies of the plants were to a greater extent directed toward the production of young shoots. We find these strong plants if kept in pots may be forced into flower the following season more quickly than those potted during the autumn. They must, however, be well attended to in the matter of watering during the summer months. They are benefited by having the pots plunged about two-thirds of their depth in cocoa-nut fibre or coal ashes if placed in a very sunny position.

After selecting the requisite number to remain in pots the others should be planted out in the reserve garden for two seasons—*i.e.*, till the following November twelvemonth, when they will, in the majority of cases, be ready to lift for forcing again, the exceptions being any that have not made satisfactory progress. These should be taken up and replanted in a batch by themselves, and not be used for forcing till they are well studded with flower buds. When once a good stock of these showy Azaleas is obtained by working them in succession, and following a regular system of culture, a given number of plants in proper condition for forcing may each year be ready for use.—
H. DUNKIN.

SEDUMS.

(Continued from page 104.)

ANOTHER section may be described as having thicker and more fleshy leaves than those last mentioned. *S. dasyphyllum*, the Thick-leaved Stonecrop, might, however, almost be included among the former. It has neat, broad, thick, glaucous green leaves and white flowers, and is a native of Britain. *S. album*, a native plant, has leaves which are, to give the exact description, "scattered, oblong, cylindrical, $\frac{1}{4}$ to $\frac{1}{2}$ inch long, of a brownish green, stalkless, smooth." The flowers are white, or rather pinkish in tone, and are produced in corymbs. This is a native of Britain and several parts of Europe. What would only appear to be a variety of this is figured by Wooster as *S. turgidum*, and is a native of the south

of France. This also has been the victim of some doubt as to its name. Ramond gave it the name of *S. turgidum*; ten years later Bastard or Batard named it *S. micranthum*, and De Candolle, considering it only a variety of *S. album*, named it *S. a. β. micranthum*. The leaves are more inflated in appearance than those of *S. album*. To come to what may also be accounted a different section, with broader, flatter leaves, and mostly herbaceous in habit, one of the most useful and beautiful is *S. kamtschaticum*, a native of Eastern Siberia, whence it was introduced in 1829. It grows from 4 to 6 inches high, and has brilliant orange flowers, dark green bluntly toothed leaves, and is procumbent in habit. I value this as highly as any in my collection. There are several in this section with red or pink flowers, and one of the best of these is *S. spurium*, a native of the Caucasus, and introduced in 1816. This has bright pink flowers and green unequally toothed leaves. A brilliantly coloured variety is in cultivation under the names of *S. s. coccineum*, and *S. s. splendens*. It is extremely pretty, and worthy of a place everywhere.

S. Sieboldi is fairly well known, and is certainly one of the rest of the red-flowered kinds. It makes a good basket or pot plant, but is unfortunately not seen to the best advantage unless below the eye. The leaves are of a glaucous grey in summer, but in autumn if in a dry position assume a brilliant red colour. The flowers are freely produced on stems 6 to 8 inches long, and are of a purplish rose. There is a variegated variety which is also very pretty, a native of Japan. *S. pulchellum*, a North American species, is very handsome and distinct, being of an erect habit, and rising from 8 to 10 inches high; the flowers are a rosy purple, the leaves greenish in colour, linear, and flattish. *Sedum spectabile* or *Fabaria* is pretty well known, and is one of the most valuable of the late flowering and erect species. It is of great value in the border, on rockwork, or in pots, its large bright heads of purple rose flowers giving a distinct charm to the spot on which it is grown. In some places it is rather largely used for bedding out, and a large mass in flower will not readily be forgotten. It is a native of Japan. There appears to be some confusion in the names of this plant. The original *S. Fabaria* seems to have been white, a native of Europe and a biennial, and I should be glad to have some light thrown on this question. *S. Ewersi*, pink, and several others might be profitably mentioned, but the length of my M.S. reminds me that I must unwillingly draw these notes to a close. I should like, however, to refer briefly to an erect yellow-flowered species, which grows about 9 inches high. This is *S. hybridum*, a native of Siberia, and introduced in 1776. Why named "hybridum" I know not, as it appears to have a good claim to specific distinction. The only other I shall speak of at present is *S. cœruleum*, an annual species and a native of Africa, whence it was introduced in 1822. It is one of those fascinating fairy plants which compel us to return to them again and again. A carpet of green leaves, bespangled thickly with exquisite light blue flowers—such is the only description we can pen of this gem of the genus; but this description only makes one regret that no language of mine can fitly portray this fairy Stonecrop.

There is little to be said about cultivation. All like full sun, and most prefer a little lime rubbish in the soil; but most are so accommodating in their habits that they bear a great deal of bad treatment without apparent injury. Treat them well, however, and give them an opportunity of displaying themselves, and they will well repay the trouble given them. Propagation is easily effected by seeds, division, or cuttings. The latter mode is so easy that little is gained by the others. It is as well to let the cuttings dry for a few hours before inserting in light sandy soil.

I feel that I have done but scant justice to these singular and interesting plants. There are still a number in my collection and others that I am well acquainted with, and of which I have said nothing; but at some future time I may recur to the Stonecrops, and trust that meantime the subject may be dealt with by an abler pen.—S. ARNOTT.

THE EAST ANGLIAN HORTICULTURAL CLUB.

THE APPLE.

THE monthly meeting of the above was held on Wednesday, February 11th, 1891, at the usual place, about forty members being present. A very able paper was read by Mr. Baxter, The Gardens, Marlingford Hall, on the culture of Apples, in which he dilated on the varieties he had found most adapted to the soil and situation with which he had to contend, together with the stocks found most suitable in his experience.

On entering his present situation, eleven years ago, he found some 160 trees had been planted some ten years previous, three parts of which were Apples, the remainder Pears and Plums. The former comprised pyramids and bushes, fine healthy and shapely trees, full of vigour, had been regularly pruned, but seldom bore any fruit. The first year he half-roct-pruned them with but little success. Soil is a strong heavy loam resting on a clay subsoil. The following season he

entirely lifted and replanted, and the second year after this process was rewarded with a fine crop with few exceptions, these latter being destroyed and more fruitful trees established.

Seven years ago several hundred trees were procured, planted 7 feet apart and 8 feet from row to row, the land being well trenched and drained. The first year these made little progress, the second year sending out shoots a yard long, the third year a good growth, but no fruit to mention. The fourth year all the strongest were lifted and replanted as near the surface as possible, this being done in October and November, the result being that for the last two years he had fair crops of clean, good-sized fruit. It is now his rule to lift a few every year, resulting in a collection of clean thrifty trees far exceeding his expectations. The intervening space from row to row was up to the past year utilised in cropping Potatoes, but since then the trees have had full possession. The Crab stock is, in his opinion, the best for general purposes, the Paradise for bushes. As it dwarfs the trees, their growth is more sturdy, consequently more fruitful, the fruit is finer and not so apt to be blown off by the winds. Some few varieties, however, will not do on the Paradise, notably Blenheim Orange, but on the Crab as a bush it grows and fruits well. Mr. Baker then went on to state that he did not believe in severe pruning, but favoured the extension system. As regards summer pruning, in his opinion this does more harm than good, as the trees often make a second growth, which must of necessity weaken them. Manures in his opinion were not needed except on poor soils, or when the trees begin to decline, and then a mulching of good loam is preferable. The Apple with other trees is prone to disease, foremost of which perhaps is the canker, with the American blight or aphid. The latter will disappear after an application of petroleum, but for the former he had never found a remedy. As prevention, however, is better than cure, he might say that his inclination led him to believe that over-rich soil and severe pruning were the primary cause of canker.

As to varieties he had proved under the conditions named he would enumerate Irish Peach, Early Harvest, Kerry Pippin, Pine Golden Pippin, Margil, Cox's Orange Pippin, Old Nonpareil, Braddick's Nonpareil, King of the Pippins, Cornish Aromatic, Cockle's Pippin, D'Arcy Spice, Court Pendu Plat, Blenheim Orange, Adam's Pearmain, Boston Russet, Hawthornden (New and Old), Lord Suffield, Keswick Codlin, Alexander, Warner's King, Beauty of Kent, Cellini, Cox's Pomona, Wellington, Ecklinville, Lady Henniker, Lane's Prince Albert, Stirling Castle, Dr. Harvey, and above all Norfolk Bearer, of which latter, as an all-round variety, he could not speak too highly.

THE VIOLET AND ITS CULTIVATION.

A short paper on this subject followed by Mr. Pell, The Gardens, Great Melton, who dealt chiefly with the variety Comte de Brazza (White), stating how it had been grown by him during the past four years, and had given him flowers eight months in the year. He first takes cuttings in the same way as Pelargoniums from the old plants the first week in June, throws the old plants away, cleaning the pits and frames thoroughly, and fills up at once with good turfy maiden loam and decayed manure mixed together, the whole being pressed firmly down, the top of the soil being 6 inches from the glass.

The cuttings are then inserted in the bed at a distance of from 6 to 8 inches asunder, with a little seasand to each cutting. The lights are placed on the pits immediately, and are kept closed night and day for about three weeks, syringing the cuttings every afternoon. They will by this time be well rooted, when air is given freely night and day for about one month, still syringing every afternoon. After this the lights are taken away altogether till August, and frames also, should they be wanted for other purposes. Now the frames and lights are put on again, giving plenty of air, still syringing every afternoon to keep the plants from red spider, to which they are much subject. The first week in September the pits are lined with stable manure, this process being continued through the winter if artificial heat is not at command. All the runners are cut off close during the growing season up to the end of March, when they are allowed to take their course, and will be found to make good cuttings by the first week in June. With regard to the variety Marie Louise Mr. Pell stated that he usually takes cuttings instead of dividing, as is usually the practice.

It may be added in conclusion that this Club is making rapid strides towards becoming an important Society. This is mainly due to the assiduity and perseverance of Mr. Geo. Daniels, under whose auspices it was originally formed.

MIDLAND CARNATION AND PICOTEE SOCIETY.

BIRMINGHAM is evidently not satisfied that Midland Carnation and Picotee growers should be unrepresented except by the union at Oxford. Mr. Dodwell has stood by the helm there with a vigour and determination that has compelled respect, but the veteran's hands are growing feeble. The new Society at Birmingham is not hostile to its Oxford associate. It has been formed with Mr. Dodwell's approval, and is perhaps intended to carry his work on when declining strength compels him to retire altogether from the exhibition arena. The midland growers are choosing a new centre of activity and a new leader. Mr. Robert Sydenham is at the head of the new movement; he is not a born florist, nor has he had long experience, but he has qualities which may serve the Society in better stead. He is a business man to the finger tips, managing two trade concerns of such an entirely opposite character as jewellery and bulbs with success, while he has

contrived to obtain a foremost position as a grower and exhibitor in a few years. The energy and experience of the successful business man allied with the love and enthusiasm of the florist ought to effect such. The Committee over which he presides is composed for the most part of well known florists: they are—Messrs. Arthur Brown, C. H. Herbert, A. W. Jones, Jos. Lakin, W. B. Latham, Tom Lord, John Pope, J. P. Sharp, Wm. Spencer, jun., and Wm. Spinks. The Honorary Secretary, from whom particulars may be obtained, is Mr. Wm. Dean, Dolphin Road, Sparkhill, Birmingham, well known as a florist of life-long experience, and it is hard to imagine a more suitable man for the post.

The first exhibition of the new Society is announced to take place at the Botanical Gardens, Edgbaston, Birmingham, on Saturday, August 8th, 1891. The schedule has just been issued, but it is a little disappointing in one or two respects. Many will have looked for a fresh departure where Birmingham sets a lead, but the Committee seem content to follow on the old lines. It is true there are two classes for border flowers, but against these we have fifteen for the wearisome single blooms. There is no class for pot plants, nor for exhibits illustrating the value of Carnations and Picotees for cutting and vase furnishing. Free and graceful arrangements of this kind would impart beauty and interest to the show and give encouragement to amateurs. In respect to Carnations and Picotees even florists of the newest school seem afraid to break away boldly from the principle of *laissez faire*.

IRIS DANFORDIÆ.

WE already have several diminutive early flowering Irises which are specially fitted for culture in pots, but that named above is a most



FIG. 29.—IRIS DANFORDIÆ.

welcome addition. Mr. T. S. Ware's plant, for which the Floral Committee of the R.H.S. awarded a first-class certificate, was only 2 or 3 inches high, and consisted of flower stem chiefly, as the leaves were only beginning to develop. The flowers are of a very pleasing rich yellow tint, and their neat shape is also noteworthy. The standards are narrow and erect, the falls elliptical and spreading, having a few greenish dots in the centre and towards the base. Whether it is hardy or not is of little consequence, as so small a plant at this time of year could not be duly appreciated in a border out of doors. Grown in pots in a frame or a cool house, however, it will no doubt flower more strongly, and be free from the damage that must ensue to so delicate a flower by exposure.

With it were plants of *Iris reticulata* var. *Bakeriana* distinguished by the bluish colour of the flowers, deepening in the falls to a rich violet tint—a charming variety.

AS OF A DREAM.

(Continued from page 92.)

I SHALL not easily forget the combined fog, dust, and noise in which I packed up my case. Men had been set to work long before my exhibits could be cleared, I think they said for the purpose of enlarging the hall. I was single handed, my wares were tender and brittle, and, as for this reason I was first in, so I was last out, and I arrived at my son's the fac-simile of the historical "dusty miller." I will just add

that all the missus' jams, &c., found claimants in London, luckily for them, as I quietly amused myself next day in seeing how the porters studied "With Care: Top side up," made glaringly conspicuous on the lid of my case. No one must ever dream that such instructions will be attended to, unless, &c., &c.

Cider was my next alternative. A few Apples were passed through my turnip-cutter, but they offered thus too coarse a pulp. Jamming in a tub was out of the question. Said I to my wife, "The Dairy Show is on, I'll run up to Islington and try whether I can discover anything that will smash up those Apples." It was early in the morning of the second day of the Show. Without deigning to look at the cows I sprang up the staircase leading to the gallery, and to behold at once confronting, as it struck me, a solitary largely developed sausage machine. A solitary man was there looking down into the cattle area. When he became aware of my presence he said, "That's a very good machine, sir." "Well, ye-e-as; what name do you give it?" "A curd crushing machine." "O, ah, the old fashioned way is to crumble the curds with one's hands, and I can easily conceive how this will monopolise that proceeding; but what I want is a something that will pulp Apples tolerably well after they have been made to pass through a turnip-cutter." This was a poser. He "couldn't say." Another examination on my part, and—conclusion. "It will take me about three hours to examine through the Show, and, if by that time you can manage to send this curd-crusher to the Paddington Station to await me there, I will purchase it at once." A hitch; he had "only this one" in the compartment. "But your large Holborn firm must have got more than this in stock?" "Yes, they had." "Well then, either send this, and get another to replace it here at once, or have one sent from your shop. See?" "Yes he did." By 2 P.M. I was spinning away for Theale Station. Upon arrival at home my best bib-and-tucker was soon thrown off, and the curd-machine found to do its work, not so well as a cider mill, but if pulped the segments of fruit after their first manipulation, as above stated, well enough for my purpose. All my fruits since then are made to follow through this machine, and I have been enabled to snap my fingers in defiance at American Apples. Nevertheless, the shoe pinches unmercifully, now we find American fruit, Potatoes, bacon, butter, and one knows not what, come in to cut us out of our own local markets.

There was a mistake in the note respecting the Apple jelly as made from the "Pay-the-rent;" it should have been two jars out of the four were taken from those made from Lane's Prince Albert. The Prince Albert is the best for the purpose before it is ripe. It is such a great bearer that unless the fruit is thinned early the trees suffer. This ought especially to have been mentioned, for I have a profound respect for Prince Albert. My wife was born in Windsor Park; her father was gardener to the Deputy Ranger for fifty-two years successively under Sir William Freemantle and the Hon. General Seymour, till he succeeded to the title as Marquis of Hertford. Her father as working under the Crown in the purlieus of the Park, his children became educated at the Queen's School, where cooking and other branches relative to domestic affairs are inculcated. I need hardly perhaps mention here that the Prince Consort instituted and was President of the Royal Association. A framed and glazed certificated adorns the wall of my sanctum where I now write. It is emblazoned with the Royal arms, and states—"Royal Association for improving the condition of Labourers and others. H.R.H. The Prince Consort, President. Presented to Eliza Temple, who received a prize of £1 at the General Meeting held at Windsor, the 26th day of June, 1858, for having kept her first place of service for a long period.—ALBERT."

"His Royal Highness The Prince Consort, on presenting Eliza Temple with a prize of £1 for having kept her first place of service for a long period, told her she ought to be distinguished as she was the only girl educated at the Queen's School who had received a prize.—(Signed) C. OKES, Governor of the Naval Knights of Windsor, June 26th, 1858."

In the ways of Providence, what an eventful sovereign the above £1 may be likened to! Eliza Temple came to Woodstock soon after the above event, the gift defraying her travelling expenses thither. I remember telling her to "feel herself at home." It is now 1891, and Eliza Fenn is making herself at home, as you have seen, amongst her jams, jellies, &c.; but who can tell besides her husband how many seedling Potatoes she has cooked and judged for the British public before the fiat was given, "Go forth for commerce?" You may, however, conclude from the above that we are loyal people at Cottage Farm.

Now, as of a dream, other demonstrations become implied. About 1859 I was rated, I believe, as fanatical, in insisting upon carting up to the R.H.S. meetings what I then thought improvements on varieties of Potatoes by natural selections of the best. I now know that it would be as easy to improve monkeys without tails as to prevent the natural selections, when left to themselves, from harking back to their types, rough as they originated. At about the above date the glove manufacture was very prosperous at Woodstock. Journeymen went to and fro occasionally to New York and other places in America. One of them had Potato on the brain. He brought back with him some large black-skinned kidney Potatoes, a few of which he presented to me. Beyond than being an immense cropper I found it to be like most of our later productions coming from the "Land of the Setting Sun," big Potatoes, and very little else to brag about. Rare Donald Beaton was too before, and at the above date, enthusiastically hybridising the Pelargonium. It came to me whether I could not artificially cross the Potato. I prepared some blossoms of the old Red Regent, and introduced pollen to them from the American. The cross produced for me a profusion of

seed, the seedlings from which I took up to a South Kensington R.H.S. Committee in a shallow glazed box with partitions to contain the pretty little various coloured tubers. They "brought down the house," as Messrs. Laing, Paul, and many other gentlemen now living probably have not forgotten. Not one of those "pretty ones" proved upon further trials of sufficient good quality for me to offer to commerce. It led me on, however, to cross the old Fox's Seedling with the old Cambridge Kidney, &c., &c., &c., consecutively running over the gamut of our best old English sorts down to 1873, when I tackled some of the modern Americans, and improved their quality quite to my satisfaction.

My name, I read too but lately, had been patronisedly written as being "amongst the first hybridisers of the Potato." I should be very sorry to find it in print anywhere that I have taken credit in any way for what is not my due. But if I was not the first to artificially cross Potatoes can you kindly inform my friends who was the premier? The thing must have had a beginning, and whoever it was that hid the candle under a bushel it was their own fault. At any rate, from the day that I exhibited the above Anglo-American cross at South Kensington the Potato furore took its rise, and, more especially within the cycle of the last ten years, it has grown to such a hap-hazard system of crossing as to offer a fair prospect of spoiling the Potato for all purposes except size and prize money. Huge rounds, rhomboids, and parallelograms, of watery pulp, void of stamina, and doing positive harm in regard to our national food. In flowers, size with beauty, and symmetry, is praiseworthy, and can do no harm; but there is no high art or public benefit in creating by crossing large, to produce larger, inferior Potatoes, however polished their garb, if we are moved merely to get a prize, or grovelling to consider them as quickly capable for filling a sack. We do not want this sort of repetition for the million as human sustenance.—ROBERT FENN.

(To be continued.)



ROSES KILLED BY FROST.

THE Hybrid Perpetuals appear to have withstood the trying ordeal remarkably well. Standards on the Briar stock are the most liable to be killed, and in all probability where they are extensively grown many losses will have to be made good. As to the wisdom of planting standard Roses under any circumstances not much can be said beyond remarking that opinions are somewhat divided as to their value, and every cultivator would perhaps best meet the case by growing both standards and dwarfs. The standards could be interspersed among the dwarfs, and if the former fail there will yet be the latter to keep up the supply. Long, exposed stems are the vital parts of Roses, and a covering of snow or rough litter is lost on them, but would prove effective among the dwarfs or bushes. When the latter are on their own roots they will survive and push up fresh shoots even if the tops are killed down to the snow line or to near the ground. Unfortunately, Roses on their own roots cannot be bought, and must therefore be raised. It is not too late to purchase and plant Hybrid Perpetual Roses, and the following would prove a varied, serviceable, and fairly hardy selection:—Alfred Colomb, A. K. Williams, Baroness Rothschild, Boule de Neige, Captain Christy, Charles Lefebvre, Countess of Oxford, Duke of Edinburgh, Dupuy Jamain, Etienne Levet, Général Jacqueminot, John Hopper, Jules Margottin, La France, Madame Eugénie Verdier, Marie Baumann, Merveille de Lyon, and Ulrich Brunner.

TEA AND NOISETTE ROSES.

These have badly cut, all not protected in any way being apparently damaged beyond hope of recovery. Even those against walls are much crippled, many being killed outright. These ought to be made good at once, or otherwise there will be many blanks and a scarcity of the choicest Roses to regret later on. Most probably the nurserymen have contrived to save a good percentage of their stock, and Teas and Noisettes can also be had in pots. For wall culture they greatly surpass the other sections, and many of the varieties are also admirably adapted for growing as bushes or standards.

Some of the best for walls, pillars, and archways are Teas Catherine Mermet, Etoile de Lyon, Gloire de Dijon, Isabella Sprunt, Fra Capucine (for buds), Madame Berard, Madame Lambard, Reine Marie Henriette, Safrano, Souvenir de Therese Levet, The Bride, and Climbing Devonensis. The best Noisettes for a similar purpose are Celine Forestier, Jaune Desprez, Maréchal Niel, Triomphe de Rennes, and W. A. Richardson; the last named being grown for its lovely buds. Teas suitable for growing in the open are Adam, Alba Rosea, Belle Lyonnaise, Boule d'Or, Comtesse de Nadaillac, Devonensis, Hon. Edith Gifford, Madame Falcot, Madame Lambard, Madame de Watteville, Marie Van Houtte, and Souvenir de Paul Neyron. Hybrid Teas, Cheshunt Hybrid, Countess of Pembroke, Distinction, Grace Darling, and W. F. Bennett, may be grown either against the walls or in the open, and room in both positions ought always to be found for Bourbon Souvenir de la Mal-

maison. The latter on its own roots is especially valuable for affording a very long succession of blooms.

PLANTING ROSES.

More than ordinary pains ought to be taken with the preparation of the sites for Roses. They will not take readily to lumpy or poor ground, and are almost certain to fail in the hot dry positions against walls and fences, unless the ground is made good to a considerable depth. In the open the least that can be done is to surround the roots with fresh compost, consisting say of two parts of fresh loam to one each of leaf soil and decayed manure. Fresh root fibres soon form in this, and in time these will find their way into the moderately rich garden soil surrounding them.

Those laid in trenches in fine soil since may have already commenced forming fresh root fibres, and the greatest care should be taken of these. The poor, dry soil against walls and fences may well be completely removed to a depth and width of not less than 18 inches, and be replaced with fresh moderately rich loamy compost, some of which can be found in most frame grounds. Dwarfs on the Manetti stock should always have the latter buried to its full depth. Exposed it is liable to become stunted and be killed by frosts; buried, there is every prospect of the Rose rooting, and thus become independent of the Manetti stock. Standards must not be planted deeply, and the roots in this and every case ought to be lightly pruned where broken or bruised, and be spread out thinly and evenly in the congenial fresh soil. Mulch those in the open with strawy manure, but as this covering would be objected to near prominent walls and fences, the better plan in this case would be to thinly cover with Ivy, a few rooted plants being procured for this purpose. The pruning may be done now or deferred to the end of February.—W. I.

CAMPANULA PYRAMIDALIS.

THE subject of the paper read at the last meeting of the Walkley (Sheffield) Floral and Horticultural Society was "The Campanula pyramidalis," by Mr. W. Redmill, who gave a brief but practical paper on the cultivation of this old-fashioned hardy perennial, which he said was worthy of cultivation as a pot plant for conservatory decoration. It is not grown by the amateur as it deserves to be, although its cultivation is simple, and the plant bears abundance of flowers on stems about 6 or 7 inches long, set at right angles to the main stem, which often reach with good cultivation to the height of 6 feet. The flowers are produced from the base upwards, and the whole stem when covered with bloom presents that beautiful pyramidal appearance that renders this Campanula so effective. There are two varieties, blue and white. The latter is the more valuable, as the separate flowers can be detached from the main stem and used in wreaths, &c. The blue variety is often of different shades, the best, however, being a rich sky blue, and very attractive. Good plants of both varieties associated together produce a beautiful effect when in full flower in August.

There are two methods of raising plants—by seed and by side shoots. The latter method of course can only be practised by those who have old plants, or who can readily obtain cuttings. The best time for inserting cuttings is April, placing a number round the edges of 5-inch pots, using a compost of half leaf mould, half loam, and a little sand, and place the pots in a frame near the glass in a temperature of 45° to 50°.

Seed may be sown at the same time, the middle of April, in a similar compost. Place a piece of glass over the pan until the seed germinates, which it will do in about fourteen days in a temperature of 55° to 60°. When large enough to move the seedlings will require pricking out in boxes, and keeping near the glass in a cool greenhouse until they are strong enough to be placed in a cold frame towards the end of May. Afterwards as they require it both seedlings and cuttings must be repotted until they are in 6-inch pots, in which size they may flower. Some, however, place two or three in a 9-inch pot to obtain variety. Stopping is not essential, but by doing so the height of the plants can be reduced, and they are more useful for some purposes.

The first week in October the plants having stood outside all the summer may be placed in a cold frame where they are not so likely to damp if afforded free ventilation in mild weather. They commence growing in February, and when they are fairly in action liquid manure made from soot and cow manure may be frequently given them until the flowers show their colour. Insects trouble them little, though in dry weather and with neglect in watering red spider will attack them. After the flower stems are cut down, and the plants kept in good condition throughout the winter, the young growths appear which serve for propagation, or if thinned and the plants repotted they will each throw up another flowering stem the following or second year after the last flowering.

TRADE CATALOGUES RECEIVED.

- A. L. Rosseel, Tronchiennes, Ghent.—*List of New Chrysanthemums.*
 Bruant, Poitiers, Vienne, France.—*List of New Plants.*
 E. F. Such, Maidenhead, Berks.—*Spring Catalogue of Seeds and Plants.*
 E. Webb & Sons, Wordsley.—*Illustrated Catalogue of Farm Seeds.*



HARDY FRUIT GARDEN.

APRICOTS.—Trees of these against south walls are beautifully set with flower buds, and even those on south-west walls are more promising than usual. At present there are no signs of any bud movement; but Apricots are the first to flower, and a short spell of mild weather may soon stir them into activity. This being so, it is advisable to do all necessary work connected with them, and to be in readiness for any emergency. If the summer-stopping was well attended to there will be few or no long shoots to be cut from the trees; but all leading growths laid in where wall space requires covering should be shortened, if strong, to about two-thirds of their length, but if weakly to half their length. The fruit is principally borne on short natural spurs, formed at the joints of strong growths of the preceding year and at the base of lateral growths freely shortened; medium-sized to small shoots, formed last summer, also showing buds freely. Unless wood buds can be detected, those short spurs ought to be left their full length; but shortening them to about 1 inch in length is advisable where the cut can be made at a joint where there is a wood bud as well as the side fruit buds showing. Long spurs ought to be kept down as much as possible in the first instance by attending closely to the shortening back, more especially of the stout lateral growths, and if the mischief is already done by gradually reducing them in number, and taking better care of the young shoots that follow. Not a few of them might be shortened to back growths or spurs.

YOUNG APRICOT TREES.—In the majority of gardens where Apricots are grown the life of the tree is short, Moorpark, which happens to be the most superior in point of quality, being particularly liable to lose branches in a wholesale manner. Wherever gumming takes place, and branches affected by it can be detected now, their loss is inevitable. There is no remedy for gumming, and the best that can be done is to anticipate the loss of trees by planting young ones to take their place. This may be done any time during February, though the sooner they are obtained and planted the better. Those already established in the garden may be transplanted up to the time the buds are bursting. If large branches were lost last summer, or have to be cut out of trees now, it is not advisable to sacrifice the rest of the branches; but they may be trained in a more erect form, and young trees brought from less favoured positions and planted near them. In this manner little or no valuable wall space will be wasted, the young soon being large enough to supersede the now worthless older trees. Some of the most reliable varieties are Large Early, Royal, Hemskirke, and Shipley's, while Moorpark ought to be grown on account of the high quality of its fruit. If a new well drained border is made for them, moderately strong loamy soil only is needed, manure causing the young trees to grow far too rankly. Where, however, holes are made for them in old borders, much of the exhausted soil should be replaced by a moderately rich loamy compost, three or four barrowloads at the least going to each tree. The contents of a garden smother or "burn bake" freely mixed with the compost suits the roots of any kind of fruit tree, and is especially recommended for Apricots, as also is lime. Plant somewhat high, a low moist position being unfavourable for this choice fruit.

PROTECTING APRICOTS.—It is yet too early to cover Apricot trees—in fact the longer this is deferred, short of leaving advanced blossoms unprotected, the harder and later will most probably be the flowers; but if it is too early to cover, that is no reason why the coverings should not be in readiness for use, especially seeing how rapidly the trees sometimes expand their blossoms. Glass copings and blinds are particularly recommended for Apricot trees, no other fruit more requiring or better repaying for this care and outlay. Apricot trees ought always to be grouped together, and if given the hottest wall in the garden and further protected with glazed copings and blinds, failures to bear well will be few and far between. Most horticultural sundriesmen supply suitable material for making into blinds, that of a somewhat woolly nature being perhaps the best, though coarse meshed thick cotton blinds are often effective and the cheapest. These need not reach down to the ground, being nearly or quite as effective when 18 inches or 2 feet off it; may be attached to either glazed or wooden copings, and made either to run up and down, or open and close, by means of rings and lines. Light iron rods connected with the coping and let into the ground 2 feet clear of the wall would answer the double purpose of keeping the blinds in position well away from the trees, and also be convenient for the rings to run up and down on. The blinds made to go with glazed copings usually run on rods under the glass, and are connected with a stout wire strained near the ground.

PLUMS.—Wall trees of these are treated very similarly to Apricots, only they thrive well in much cooler positions. If they fail to bear well it is usually owing to either the loss of buds by birds or the destruction of the flowers by spring frosts. Good progress ought already to have been made with the pruning and nailing of the wall trees, the former

process being carried out on much the same lines as laid down in the case of well-established Apricots. Be particularly careful not to shorten the short natural spurs and which have a wood bud at the point only, as unless there are a few leaves beyond clusters of fruit they seldom attain perfection. Where there are plenty to select from extra long spurs can be cut hard back, and the stout stumps of lateral growth formed last summer and duly shortened ought also to be further reduced to about 1 inch in length. Leaders or branches required for furnishing will, if well matured, break more evenly when laid in to their full length. Plums are also frequently covered with copings and blinds, and pay well for the attention. The least that can be done is to fix poles at short intervals from the coping to the ground, and then hang fish netting in two or more folds over them. If birds are troublesome net over the trees soon, otherwise defer it till the flowers commence unfolding.

YOUNG PLUM TREES.—These may be planted at any time before the buds burst. They will succeed on either east, south-east, and even cooler sites, and a lengthened supply of fruit can be had by selecting and planting judiciously. Some of the best for moderately warm walls are Oullins Golden, Kirke's, Jefferson's, De Montfort, and Green Gage, while Victoria, Rivers' Prolific, Morocco, Early Orleans, Washington, Transparent Gage, and Coe's Golden Drop will succeed well in cooler sites. The last named is the most valuable of late Plums, and might well be grown far more extensively than it is in private gardens. Prepare sites for young trees much as advised for Apricots, making the soil somewhat firm about the roots, and which ought to be spread out evenly, or much as they spring from the stem. What pruning is necessary may be done at once, but the trees ought not to be very closely secured to the walls, a little allowance being made for a settlement of the soil. All sound branches on what are sold as trained trees may be laid into their full length, but any bruised should be freely shortened back. Fasten the branches to the walls or fences exactly as they were trained in the nursery, and fill in intervening spaces next summer. The leading shoots of any so treated last year may be allowed to extend, and the same treatment continued till their limit is reached. They break more evenly and are more quickly productive when not shortened, gaining strength gradually. All shoots not wanted for furnishing to be shortened to about 1 inch in length, and stumps of shoots summer stopped to be similarly treated.

FRUIT FORCING.

PEACHES AND NECTARINES.—*Earliest Forced House.*—This applies to trees started in December. If of the early varieties, such as Alexander and Early Beatrice, they will ripen their fruit at the end of April; if such varieties as Hale's Early, the fruit will not ripen until May; if Royal George, not until the end of that month. The trees must be syringed every morning and afternoon to check red spider. If, however, the weather be dull, the syringing must be practised early in the afternoon, so that the trees may become fairly dry before night, or if that does not take place the afternoon syringing must be dispensed with, damping the paths and borders instead, as keeping the trees dripping with water through the night causes weak growth and thin foliage. Outside borders must have protection from the cold, a light mulching of dry partially decayed manure is sufficient. Water inside borders as required, using liquid manure, which will assist the trees in swelling their fruit, especially in the case of weakly trees long subjected to repeated forcing. Vigorous trees will not require any stimulants, excessive vigour being unfavourable to the fruit safely passing the stoning period. When the fruit is the size of small marbles thinning may commence, but remove a few fruits only at a time, commencing with those that are badly placed. Disbudding must be continued, taking care to leave a growth at the base of each bearing shoot, and another at its extremity, or at least level with the fruit. The shoots retained for attracting the sap to and supporting the fruit should be stopped at the second or third leaf, but the basal shoots must be trained to take the place of those now bearing fruit. Shoots upon extensions must be left at 12 to 15 inches distance apart to form the bearing wood of the future. It is a great mistake to crowd the trees with growths, for which there is not space to allow of its full exposure to light and air, therefore avoid overcrowding, seeking to maintain an equal balance of growth throughout the trees, and its solidification by judicious ventilation.

Second Early House.—Let fertilising still be practised, gently brushing the flowers, or distributing the pollen by shaking the trellis. A camel's-hair brush secures this efficiently. Admit air freely on all favourable occasions, avoiding, however, cold currents, and provide a little ventilation constantly at the top of the house. Continue the night temperature at 50°, 5° less on cold nights, 55° by day artificially, and 60° to 65° from sun heat, not allowing a rise above 65° without a free circulation of air. Syringe the trees when the flowers fade and the fruit is set. The moisture will assist the fruit to throw off the remains of the blossom, but up to the fruit setting a genial condition of the atmosphere may be secured by damping surfaces other than the trees in the morning and early afternoon.

Houses Started Early in February.—The trees started early in the month are swelling their flower buds rapidly. Syringing must cease when they show colour. Maintain, however, a good moisture by damping the paths and borders two or three times a day as the weather may dictate, avoiding a close stagnant atmosphere. If the flowers are numerous thin them by rubbing the hand downwards on the under

side of the shoots, which will strengthen the remainder. Examine the trees closely, and if there be any aphides fumigate with tobacco, so as to destroy them before the flowers expand. Continue the temperature at 40° to 45° at night and 50° by day, above which ventilate freely. When the flowers expand raise the temperature to 50° at night, 55° by day, and 60° to 65° from sun heat with free ventilation. On cold nights the temperature may fall to 45°, or even less, also 50° by day, allowing a little ventilation constantly at the top of the house.

CHERRY HOUSE.—The temperature having been maintained at 40° to 45°, and about 50° in the daytime regularly, the trees are now rapidly unfolding their buds. Before the flowers expand it is desirable to fumigate the house, as aphides are almost certain to be present, or by syringing the trees with an approved insecticide, make sure that the trees are free from insects. An application of clear, rather strong quassia water (4 ozs. chips to a gallon of water boiled a quarter of an hour) will answer the same purpose, repeating it at intervals of a day or two. Any alterations in introducing fresh trees must be completed without delay, and taking precautionary measures, so that shading may be applied to such trees whenever sunshine is powerful, and in order to promote the re-establishment of the trees as quickly as possible they should be lightly sprinkled more frequently, and other surfaces moistened.

A lean-to house erected against a wall with south aspect is suitable for Cherries, and it need not be more than 6 feet to 7 feet 6 inches in width. The back wall can be covered with trees, and the front to a height of about 6 feet with trees on the Mahaleb stock, but the finest fruit is had from trees trained a few inches from the roof lights, having low standard trees planted in front. Span-roofed houses also answer well, but are not so good for early forcing as lean-to houses. In span-roofs the trees can be in pots or tubs, or they may be planted out, growing as bushes, pyramids, or low standards, and they can be fan-trained and attached to trellises 9 to 12 inches distance from the glass. Provide in every case ventilation at the bottom and top of the house, and in the case of structures intended for early forcing the front roof lights must be moveable. The border must be inside, though the roots may also have access to an outside border, thoroughly drained to carry off superfluous water. Good loam, preferably calcareous, and rather strong is most suitable, adding a sixth of old mortar rubbish and a fifth of road scrapings, increasing the grit if the soil be too heavy, also the lime rubbish if the soil is not calcareous, but sand is essential to healthy growth in Cherry trees. Trees from the open wall between four and six years trained, if carefully removed to the house, come into bearing at once, but to ensure their success they must have been frequently lifted. Supply water freely to settle the soil about the roots, and ventilate, syringing in the morning and again early in the afternoon, employing fire heat only to exclude frost, but when the trees are fairly in growth let the day temperature from fire heat be 50° to 55°, rising to 60° to 65° from sun, increasing the ventilation at 55°, and close at that temperature, leaving, however, a little ventilation on day and night, 40° to 45° at night from artificial heat will be sufficient. Early Rivers, Empress Eugénie, May Duke, Archduke, Elton, Governor Wood, Black Tartarian, and Large Black Bigarreau are excellent varieties.

CUCUMBERS.—Examine the plants in bearing once or twice a week, removing bad leaves and exhausted growths, thinning the shoots, stopping, and removing old and deformed fruits. Thin the old growths so as to admit of training in young shoots, overcrowding and overcrowding being highly prejudicial. In securing the young shoots to the trellis do not tie them too tightly but allow room for development. Plants that have been in bearing for some time should have the surface soil removed and previously warmed fresh soil added. Turfy loam with a fourth of well decayed manure will answer; we, however, prefer for Cucumbers and Melons turfy loam without an admixture of manure, seeking vigour by rich surface dressings or liquid manure. The bottom heat should not be allowed to fall below 75° or exceed 90°, 80° being suitable; house temperatures 65° to 70°, 5° less in severe weather, 70° to 75° by day, rising to 85° from sun, closing early in the afternoon, damping the pathways on bright mornings and at closing time; keep the evaporation troughs charged with liquid manure, and damp the paths with the same at closing time.

MELONS.—The weather lately has not been favourable to the young plants, the growth not being free. In a Melon house, a ridge the whole length of the house or bed, about 2 feet wide at the base, with the top flattened so as to give a depth of 10 to 12 inches, is preferable to hillocks, the soil being made rather firm, and when warm the plants may be turned out, firming the soil well, and raising it within half an inch of the seed leaves. The plants may be placed 2 to 2½ feet apart, the leading or primary shoots being taken up without stopping until fully two-thirds the distance they are intended to travel is reached, then pinch out the point of each. When three or four lateral joints are made the points should be taken out. Some varieties will show fruit freely on the first laterals, and as early Melons are a consideration let them remain, taking out the point at a joint above them. To allow all the laterals to remain would very much overcrowd the foliage, therefore rub off every alternate one whilst they are quite young. After stopping the first laterals the succeeding growths will show fruit at the second or third joint. The growths should be trained thinly and regularly, so that every part of the trellis is covered evenly with foliage and fruit. The plants will require but little water as yet; nevertheless, maintain the soil in a moist state, avoiding anything approaching to saturation. Sprinkle every available surface in the morning of bright days, and again at closing time or early in the afternoon. Ventilate carefully,

avoiding cold currents of air. When the air is sharp some hexagon netting or scrim canvas placed over the ventilators will break the force of cutting winds. Maintain a night temperature of 65° to 70°, falling to 65° or 60° in the morning, 5° less in severe weather being better than seeking to maintain the higher temperature by sharp firing, 75° by day, rising to 80° or 85° from sun heat; bottom heat kept steady at 80°.

Melons in Pits and Frames.—Plants with the growths trained over the surface of the beds being stopped at the second leaf will produce two or more shoots, but two are ample, rubbing off the others. Stop the two at two joints of growth, this will give four shoots, take two to the front and two to the back of the frame or pit. Besides these other shoots may appear near the collar; rub them off whilst quite young, and do not encourage any laterals nearer the stem than 6 inches. This will keep the collar clear. Stop the principal shoots when within a foot of the sides of the pit or frame, and thus throw vigour into the laterals, which will show fruit at the second or third joint, stopping them at one joint beyond the fruit. Cover the lights with double mats at night, and see that the linings are regularly attended to, renewing the old linings as required. Prepare material for making up fresh beds. About a fortnight before it is desired to make up the bed the dung and leaves should be thoroughly incorporated. In a few days it will be seen whether there is sufficient moisture to produce decomposition, fermentation being the result; if not turn the whole, sprinkling with water so as to moisten the mass, and when in good heat turn again, outside to inside, and *vice versa*, two or three turnings being required at intervals of about four days. The bottom heat of fermenting beds should be 85° to 90°.

STRAWBERRIES IN POTS.—The fruit being fairly set remove all badly set or deformed fruits, leaving from four to half a dozen of the most promising fruits to each plant, and aid their swelling by liquid manure. The temperature should be 60° to 65°, advancing to 75° by day with moderate ventilation. Avoid drying currents of air, as they injuriously affect the swelling of the fruit. Examine the plants twice each day, giving water only to those needing it and in sufficient quantity to show at the drainage. See that succession plants are kept free from aphides, fumigating if necessary before the flowers open. British Queen and other late sorts may now be started, introducing, however, proportionate quantities of Sir Joseph Paxton to maintain the succession.

THE FLOWER GARDEN.

Herbaceous Borders.—It is yet too soon to state with any certainty whether or not there are many losses to lament, but to all appearances the bulk of the plants are alive. Already many of them are moving, and if any alterations in the arrangement are contemplated or fresh borders are to be planted this ought soon to be proceeded with. In numerous instances much good would be done if the whole of the plants and roots in borders that have been planted many years were lifted, the ground freely manured, deeply dug or trenched, and replanted. Dividing the strong clumps of the more vigorous kinds, even if many of the divisions are thrown away, is almost imperative. Left undisturbed for many years Phloxes, Pyrethrums, Heleniums, Sunflowers, Asters, Delphiniums, and such like push up a crowd of weakly growths, which do not flower satisfactorily or long retain their beauty. Divided and replanted all alike grow and flower more strongly, and do not so quickly succumb to drought as do those not replanted every three or four years. The least that can be done is to reduce the size of the clumps, and to lightly fork in a surface dressing of decayed manure or the best substitute for the same procurable. This must be deferred till it is seen where the bulbs are established, but the lifting and replanting may, if the weather is favourable, be proceeded with at once.

Bulbous-rooted Plants.—This is perhaps the best time for dividing large patches of Narcissi, Daffodils, Snowdrops, Crocuses, and Tulips, as well as the choicer kinds of bulbs. All will be rooting strongly and be making top growth. If carefully divided and replanted this will not prevent them from flowering strongly this season, while the majority are more likely to flower well next year if moved now than they would be if transplanted when in a dried off or dormant state. The commoner Narcissi, including the Pheasant's Eye, and Daffodils largely grown to afford cut flowers, succeed well in cool fruit borders, and a portion of the stock being planted in these positions these will give a good succession to those grown in warmer parts of the garden. Now is a good time to plant out Anemone and Ranunculus roots. They thrive best in a moderately rich very freely worked soil, being covered with a little sandy compost. Plant them 2 inches deep, and about 5 inches apart each way, or thinly in patches. Mulch with leaf soil or fine manure, and hand-weed whenever necessary.



FOUL BROOD.

THE Canadians some time since passed an Act for the suppression of foul brood. An inspector was appointed, and the method of cure adopted was the one known as the "purga-

torial" process, which was first given in this Journal about thirty years ago; I say first because, although methods similar had been employed a century previous, none described the method in the same terms.

If your readers who have the back numbers of this Journal in which the foul brood controversy was carried on about thirty years ago they will find an article by me stating that the queen transmitted the disease. They will also find Mr. Woodbury's reply to the effect, how was it he had cured so many cases of foul brood by the "purgatorial" process if the queen had anything to do with the introduction of the disease? Then as to its introduction, I am in receipt of a copy of a letter from Mr. Woodbury stating that foul brood was introduced into his apiary by feeding his bees with foreign honey, and during the Sikh war in Africa, when markets were high and wages small, cottagers here, in order to economise their small pittance, preferred buying foreign honey at 6d. per lb. to sugar at 8d. to feed their bees with, and in every case foul brood was generated. I have proof of numerous other cases; besides, I have cured scores of cases by the same method, and have been the means of clearing whole apiaries of the plague by the "purgatorial" process, the latest one being an apiary of nearly a hundred affected hives, after destruction had been advised and formic acid tried.

It will be observed that although I pointed out that queens carried the disease, and tried carbolic and other acids to effect a cure at so early a date, it is another person of a much later date that gets the credit. It does not surprise me in the least why one succeeds in effecting a cure while others fail, but it does surprise me to see people advocating what only one or two have been able to accomplish. In my numerous experiments I have never succeeded in destroying the germs of foul brood with phenol or carbolic acid, and I have reproduced the disease after I had the infection submitted to boiling heat and to a zero cold, which had lain latent for many years, and was engaged with some interesting experiments of that sort at the time of the fever epidemic in Glasgow when so many students died, and when there was so much discussion between medical men as to the possibility of the disease being carried by milk or by germs. I took to Glasgow two samples of milk, one infected, the other not. I reproduced from the above latent germs with the intention of taking it to a public meeting of sanitarians of high authority, but took it first to an eminent medical authority, who requested me rather to give him the samples, as I should frighten some of the meeting did I go amongst them. In a few days thereafter a sanitary journal had the facts, and declared there was now no further use for opposing them, as they, the germs, had been actually grown like a plant, which ended the controversy. The record of my milk experiment will be found in this Journal about 1862.

I only mention the above facts to show that I know something about bees and their diseases, and I will yield to none in what I know to be right. I am perfectly cognisant of the causes that might be the means of a queen transmitting foul brood; but I deny that a queen may be so diseased as to convey the infection more than a few weeks. If the germs of foul brood are introduced to the ovary of a queen and her not laying she would soon be rendered useless. Nevertheless, a queen may carry the infection for months upon her exterior.

Honey may, in a sense, contain no germs; but there is a fact that some attention might be paid to with profit. It may, and I believe it often, undergoes a change; that although harmless in itself, or an antiseptic if you choose, when mixed with pollen it becomes the best nidus for the germs of foul brood. If honey is not a means of direct infection, how is it that medicated food is so often advised? I have fed bees over and over again with syrup and honey perceptibly flavoured with carbolic acid, yet that honey or syrup stored had lost it all.

The reason that larvæ die from foul brood and not adult bees is the simple fact that larvæ food is a compound substance suitable

for the growth of youth, while honey is simply a heat giver; but give adult bees infected food, and the result would be the same, to a degree at any rate. But where is the origin of the germs that cause foul brood? In my experiments with germs I have found from three to five different sorts from one source besides animalculæ.

I lately observed a writer condemning hives covered with old bags, as if anything uncleanly from them would enter the hives! The bags referred to were in fact a benefit rather than otherwise, as they were of an antiseptic nature. Had that writer turned his attention to the pools where bees sip much moisture, and probably carry home directly the germs of disease, he would have been doing good had he told us how to keep the bees away. Honey may not have the contagion, nor yet the pollen, but the water may, and when mixed with the other two, under certain conditions the germs become active, and disease and death follow.

The most extraordinary statement made is that, "When bees are gathering honey freely almost any method succeeds." This is also the opposite to our recorded experience, as I fully proved between the years 1860 and 1862, the warmer the weather and the hive, the more virulent was the disease. Nothing incites the disease quicker than overheating, which affects both honey and pollen. Although my strong stocks have been sometimes forty-eight hours on a journey, the precautions I used against overheating and the radical means I took to cure nearly fifty hives by the "purgatorial" process, I have not seen a diseased cell amongst my hives for thirty years. Some years ago I gave to a neighbour several swarms, and in spite of my advice not to feed with honey taken from diseased stocks, he did so, with the result that both in a few weeks were affected in a virulent form.

Others near me, whose hives are never free from the disease, perpetuate it by feeding with honey. I do not know a single bee-keeper in this country nor in America that has succeeded in curing foul brood with acids, but can point to hundreds of hives cured by the P. process. With the latter everything that is likely to be contagious is removed, the bees alone being preserved, means being taken to purge from them as well as the queen that which is likely to infect. In the former case everything is allowed to remain in the hive, trusting to the form of acid used to perform the cure. Which, then, is the most reasonable method? I cannot say that it is a question of "doctors differing," but simply one rational the other irrational. Foul brood is to be dreaded, and the most simple way of avoiding it is rather to keep hives cool than to stifle them by contracting them into little space as recommended by some modern bee-keepers.

To investigate the disease thoroughly, tracing its whole history, many years would elapse, and even then mysteries will crop up. We cannot destroy nature, but that which by negligence threatens to destroy the useful, and beautiful can by proper attention and common sense keep the enemy in check. Foul brood germs may be latent for ten or twenty years, breaking out only when the hygiene of the hive has been neglected and under climatic influence favourable to the development of the disease. I am a strong believer in the old fact, that one germ or even fungus destroys the power of another, and am also of the opinion that this has been the case in more than one instance in my own apiary; and I know full well that the evidence on our side is greater than the purgatorial process is a success than the other, that it has "thoroughly proved a failure."

Keep your hives in a healthy state by attention to Nature's laws, and foul brood will not disturb the bees much; but if it should appear try the plan as I have advised, and it will surprise many more besides myself if you should fail to effect a cure more quickly and satisfactorily than any other method yet devised.—
A LANARKSHIRE BEE-KEEPER.



•• All correspondence should be directed either to "THE EDITOR" or to "THE PUBLISHER." Letters addressed to Dr. Hogg or members of the staff often remain unopened unavoidably. We request that no one will write privately to any of our correspondents, as doing so subjects them to unjustifiable trouble and expense.

Correspondents should not mix up on the same sheet questions relating to Gardening and those on Bee subjects, and should never send more than two or three questions at once. All articles intended for insertion should be written on one side of the paper only. We cannot reply to questions through the post, and we do not undertake to return rejected communications.

Oleander (*J. F. C.*).—Your letter shall have attention. It arrived too late for being satisfactorily answered this week.

Marketing Fruits (*Scotia*).—If you can give references to or indicate the articles to which you allude we shall be in a better position to answer your question.

Eucharises Unhealthy (*H. J.*).—The box and bulbs were much crushed in transit, but we examined the latter and failed to find any Eucharis mite. Their appearance suggests an imperfectly drained soil and a too liberal supply of water.

Troublesome Boiler (*H. B.*).—If the pipe from the feed cistern does not enter the lowest or return pipe close to the boiler, or the bottom of the boiler itself, the little alteration suggested may perhaps prevent the boiling over. If a feed cistern is full when the water is cold some of it is bound to be forced out when the water is heated in consequence of its expansion.

Stable Drainings (*F. S.*).—There is no need to mix potash with stable drainings unless you particularly wish that form of manure, then you may add 1 lb. kainit to every 100 gallons of liquid. It will not thicken the drainings to any material extent. Wood ashes are good chiefly in affording potash, but stable drainings that do not contain a large quantity of water used in washing down contain enough potash for any crop.

Starting Vines (*F. J.*).—It would have been better to have admitted air freely and kept the Vines dormant until they started naturally in March or April, when they would have grown away without check. A little stable litter on the outside border will not do any harm, but a thick coating, by excluding air, does more harm than good in the case of cool houses. There is no need to put any inside, or only a little as a mulch in a few weeks time.

Sulphate of Iron (*J. A.*).—Mix the sulphate with sand, and apply whilst the ground is wet. It has been found in America that the best prevention of Apple scab (*Cladosporium dentriticum*) is to spray the trees with a solution composed of 1½ ounce of carbonate of copper, 1 quart liquid ammonia, and 90 quarts of water, at intervals of about two weeks from the fruit setting to the middle of August, surpassing in results the soda hyposulphite hitherto used for that purpose; in fact, the beneficial results were nearly doubled in comparative experiments. The weak solution of iron sulphate is to be used over the trees before they come into leaf as a means of destroying the spores of the fungus, the ground dressing being for a similar purpose. The gas lime is certainly objectionable for a time near a house, but you may try the effect of iron sulphate at the rate of ¼ lb. per square rod (30¼ square yards), mixing with sand to insure equal distribution. Gas lime, however, is effectual against clubbing. We shall be glad to attend to further questions.

Fungus on Mushrooms (*N. H. P.*).—The specimens sent have been examined by Mr. Worthington G. Smith, who says:—"The Mushrooms are attacked by a parasitic mould named *Mycogone alba*. This is frequent on Mushrooms, and, I believe, it makes them dangerous to eat. When there is not much of it, it is not very apparent. At length it covers the gills; sometimes, but rarely, the stem and top. They generally remain firm and sound, not decaying, as in this case." As you say the enemy seems to thrive on salt and water, perhaps this may have accounted for the change. If the beds are in a house it would be a good plan to take advantage of an opportunity to clear them out and disinfect the structure.

Lichen on Lawn (*A. E.*).—The plant infesting your lawn is a species of Lichen, and indicates that the ground is not well drained and the turf weak. The following would be the best course for you to adopt. During the present month, as soon as the weather permits, apply a dressing of well-decayed manure, spreading it evenly, and letting it remain until the close of March, then with an iron rake scratch the ground well forwards and backwards, which will assist in getting in the manure and form an open surface. Early in April remove the loose portions of the manure by raking it evenly, and any stones should at the same time be removed. This will form a good tilth for the Grass

seeds, which may be sown early in April, with an early prospect of rain, and on a fine or calm day. The proper kinds to sow are *Festuca duriuscula*, 4 lbs.; *Festuca ovina tenuifolia*, 2 lbs.; *Cynosurus cristatus*, 8 lbs.; *Poa nemoralis sempervirens*, 2 lbs.; and *Poa trivialis*, 1 lb., a renovating mixture of the choicest Grasses for one acre. If the lawn is not used for tennis then add 6 lbs. *Trifolium repens*, and 2 lbs. *Trifolium minus*. This is a capital addition, the whole for a very bare lawn not being too much; but if there is a good growth of Grass already the quantities may be reduced one-half, and if used for tennis the *Trifoliums* must be very sparingly used, as they keep long damp towards the end of the season. Rake lightly over after sowing, roll it firmly, and spare the lawn as much as practicable early in the season, so as to give the Grasses a chance of becoming established. Rake off as much of the lichen as possible before commencing the operations described.

Manure for Mushroom Beds (*F. Gill*).—The following appears in a later edition of the work you name, and seems to meet your case exactly:—It has been suggested that the injunction as to "every lock of straw and flake of manure which adheres together being separated" has in some instances led to the material being "knocked about" too much. All that can be said on this subject is this: It is not necessary to smash the manure into small particles, but there must be no unpurified lumps. Avoid these, and the less the droppings among the straw are broken the better. Doubts are sometimes entertained as to whether manure from cow stables may be mixed with that from horse stables. Let the incorporation of the manure with the straw be as complete as possible, and such a mixture is excellent. Very productive beds have been produced with manure from cow stables alone, short litter or partially decayed straw largely predominating, but due care was exercised in its preparation. When manure is not sufficiently purified, or insufficiently cased with soil, the escaping gases often turn the gills of Mushrooms silvery white. In that condition they are not marketable, and though safe to use they are only fit for ketchup.

Gardeners as Servants (*W.*).—It has been decided that a head gardener at £100 a year wages who resided in a detached house belonging to his master is a menial servant, and as such only entitled to a month's wages (when his services are not continued) on the death of his master, *vide* *Nowlan v. Ablett*, 2, C. M. and R., 54. A gardener is a servant also for purposes of taxation. The "Customs and Inland Revenue Act, 1869" (32 and 33 Vic., cap. 14) provides that a sum of 15s. for every male servant shall be paid annually upon licenses to be taken out under the provisions of the Act by the person who employs the servant. The Act defines a male servant—"Any male servant employed either wholly or partially in any of the following capacities—that is to say (*inter alia*), gardener, under gardener, or in any capacity involving the duties of any of the above descriptions of servants by whatever style the person acting in such capacity may be called." A solicitor of standing will soon tell you whether you have a good claim or not, and not overcharge you for his advice. There are generally peculiarities in each case, but broadly stated a gentleman's gardener is a menial servant, but whether that constitutes him a "domestic" or not we are not in a position to affirm. We are obliged by your letter on another subject. The story has been published, but perhaps worth publishing again, but under any circumstances it cannot appear this week.

Warts on Vine Leaves (*Scottie*).—Your expert countryman, Mr. William Thomson, Clovenfords, writes on the subject as follows in his excellent Treatise on the Vine, which is published by Messrs. Blackwood:—"This is a sort of conglomerate of little green warts that form on the lower surface of the leaf, as if the result of an extravasation of sap through its epidermis or skin. Some writers say this is not a disease. If it is not such, strictly speaking, it is at least organised matter in the wrong place; and I am confident it seriously impedes the important functions of perspiration, digestion, and respiration; so that if not in itself a disease, it leads to functional derangement, which is nearly the same thing. As has been remarked while treating of the effects of sulphur, these green warts are more easily affected by the particles thereof floating in the atmosphere of the vinery than any other portion of the Vine, except the embryo berries. I can undertake to produce or prevent this disease—shall I call it?—at any time betwixt the first expansion of the foliage and the stoning of the fruit. A close, warm atmosphere, saturated with moisture, will produce it; whereas a free circulation of air, moderately charged with moisture, will prevent its appearance. I have seen instances where the leaves were so affected by it that they all cupped themselves up round the edges, the fruit did not swell to much more than half its natural size, and the general progress of the Vine was retarded."

Barbarossa and Alnwick Seedling Grapes (*Disputant*).—You appear to be right in one case and wrong in the other. The bunches of the true Barbarossa Grape (which you have probably never seen) are medium sized, shouldered. Berries, slightly oval, or obround. Skin, thin and delicate, of a grizzly colour, or pale red, covered with a thin grey bloom. Flesh, delicate, juicy, sweet, and with somewhat of a Royal Muscadine flavour, but very much richer. The Grape which has been grown in this country for some years under the name of Barbarossa is a totally different variety. Its correct name is Gros Guillaume, and it is black, while the Barbarossa is, as its name implies, a rose-coloured or grizzly Grape. Alnwick Seedling was raised about the year 1857 in the garden of Alnwick Castle, the seat of the Duke of Northumberland, by William Caseley, who was then employed in the forcing houses there. The female parent was Black Morocco, fertilised with Syrian for the purpose of making it set its fruit better, as it is one of those varieties inclined naturally to sterility. By the time the Grapes

were ripe some of the berries were observed to be of unusual size. From these Mr. Caseley saved seeds, which were sown by him, and produced several plants, the fruit of some being black and others white. Only two were found to be worth cultivating, and one of these is that which is known as Alnwick Seedling. It is called Clive House Seedling from having been first brought into notice by Mr. D. P. Bell, of Clive House, Alnwick, who exhibited it before the Fruit Committee of the Royal Horticultural Society, Dec. 6th, 1876, when it was awarded a first-class certificate under that name.

Names of Fruits.—The names and addresses of senders of fruit to be named must in all cases be enclosed with the specimens, whether letters referring to the fruit are sent by post or not. The names are not necessarily required for publication, initials sufficing for that. Only six specimens can be named at once, and any beyond that number cannot be preserved. (*J. Longton*).—1, Braddick's Nonpariel; 2, D'Arcy Spice; 3, Wyken Pippin; 4, Lane's Prince Albert.

Names of Plants.—We only undertake to name species of plants, not varieties that have originated from seed and termed florists' flowers. Flowering specimens are necessary of flowering plants, and Fern fronds should bear spores. Specimens should arrive in a fresh state in firm boxes. Slightly damp moss, soft green grass or leaves form the best packing, dry wool the worst. Not more than six specimens can be named at once, and the numbers should be visible without untying the ligatures, it being often difficult to separate them when the paper is damp. (*J. J. S.*)—*Odontoglossum pulchellum*. The address for which you ask is Mr. W. Collins, 9, Martindale Road, Balham, London, S.W. (*J. B.*).—1, *Iris reticulata*; 2, *Iris reticulata Bakeriana*. (*S. M.*)—1, *Asplenium bulbiferum*; 2, *Asplenium cicutarium*; 3, *Adiantum trapeziforme*; 4, *Davallia parvula*. (*R. O.*)—1, *Odontoglossum Rossi majus*; 2, *Masdevallia Veitchiana*; 3, *Oncidium splendidum*; 4, *Oncidium flexuosum*. (*J. L.*)—The two Orchid flowers through having been embedded in dry cotton wool and remaining in the post during Sunday arrived quite shrivelled, and though we have had them in water since they are still unrecognisable. (*S. M.*)—*Odontoglossum triumphans*. (*T. B.*)—1, *Pteris umbrosa*; 2, *Lomaria gibba*; 3, *Adiantum tenerum*.

COVENT GARDEN MARKET.—FEBRUARY 18TH.

BUSINESS quiet, with supplies somewhat shorter.

VEGETABLES.

	s.	d.	s.	d.		s.	d.	s.	d.
Artichokes, dozen	0	0	0	0	Mushrooms, punnet	1	6	0	0
Beans, Kidney, per lb.	1	6	1	9	Mustard & Cress, punnet	0	2	0	0
Beet, Red, dozen	1	0	0	0	Onions, bushel	3	0	4	0
Brussels Sprouts, ½ sieve	2	6	3	0	Parsley, dozen bunches	2	0	8	0
Cabbage, dozen	1	6	0	0	Parsnips, dozen	1	0	0	0
Carrots, bunch	0	4	0	0	Potatoes, per cwt.	3	0	4	0
Cauliflowers, dozen	3	0	6	0	Rhubarb, bundle	0	2	0	0
Celery, bundle	1	0	1	8	Salsafy, bundle	1	0	1	0
Coleworts, doz. bunches	2	0	4	0	Scorzoneria, bundle	1	6	0	0
Cucumbers, doz.	4	0	8	0	Seakale, per bkt.	2	0	2	6
Endive, dozen	1	0	0	0	Shallots, per lb.	0	3	0	0
Herbs, bunch	0	2	0	0	Spinach, bushel	5	0	6	0
Leeks, bunch	0	2	0	0	Tomatoes, per lb.	0	6	0	8
Lettuce, dozen	2	0	2	6	Turnips, bunch	0	0	0	0

FRUIT.

	s.	d.	s.	d.		s.	d.	s.	d.		
Apples, ½ sieve	1	6	to	6	0	Lemons, case	15	0	to	20	0
" Nova Scotia and Canada, per barrel	15	0	23	0	Melons, each	0	0	0	0	0	
Grapes, per lb.	1	6	3	6	Oranges, per 100	4	0	9	0		
Kentish Cobs	45	0	5	0	St. Michael Pines, each	2	0	6	0		
					Strawberries, per lb.	0	0	0	0		

AVERAGE WHOLESALE PRICES.

CUT FLOWERS.

	s.	d.	s.	d.		s.	d.	s.	d.		
Arum Lilies, 12 blooms	2	0	to	4	0	Marguerites, 12 bunches	4	0	to	6	0
Azalea doz. sprays	0	6	1	0	Mignonette, 12 bunches	3	0	6	0		
Bouvardias, bunch	1	0	1	6	Mimosa (French), per bunch	1	0	2	0		
Camellia, white, per doz.	2	0	4	0	Narciss (Paper-white), French, doz. bunches	4	0	10	0		
" red	1	0	1	6	Do. Do. English, per bunch	1	0	1	6		
Carnations, 12 blooms	1	0	2	6	Pelargoniums, 12 trusses	1	0	1	6		
Christmas Roses, dozen blooms	0	6	1	0	" scarlet, 12 bunches	8	0	12	0		
Chrysanthemum, 12 bchs.	3	0	6	0	Poinsettia, dozen blooms	3	0	6	0		
Cyclamen, doz. blooms	0	3	0	6	Primula (double) 12 sprays	0	6	1	0		
Daffodils, doz. blooms	1	0	2	0	Roses (indoor), dozen	0	6	1	6		
Epiphyllum, doz. blooms	0	4	0	6	" Red, 12 ble. (Fench.)	2	0	4	0		
Eucharis, dozen	3	0	6	0	" Tea, white, dozen	1	0	3	0		
Gardenias, each	2	0	3	6	" Yellow, dozen	3	0	9	0		
Hyacinths (Roman), doz. sprays	0	6	1	0	Snowdrops, doz. bunches	1	0	3	0		
Lapageria, 12 blooms	2	0	4	0	Spirea, per bunch	0	9	1	0		
Lilac (French) per bunch	4	0	6	0	Tuberose, 12 blooms	1	6	2	6		
Lilium longiflorum, 12 blooms	6	0	9	0	Tulips, per dozen	1	0	2	0		
Lily of the Valley, dozen sprays	0	6	1	0	Violets (Parme), per bch.	4	0	6	0		
Maidenhair Fern, dozen bunches	4	0	9	0	" (dark), per bch.	1	6	2	6		
					" (English), doz. bunch	1	0	2	0		
					Wallflower, doz. bunches	3	0	6	0		

PLANTS IN POTS.

	s.	d.	s.	d.		s.	d.	s.	d.		
Aralia Sieboldi, dozen	6	0	to	12	0	Foliage plants, var., each	2	0	to	10	0
Arbor Vita (golden) doz.	6	0	8	0	Genista, per doz.	9	0	18	0		
Azalea, per plant	2	0	3	6	Hyacinths, doz. pots	6	0	9	0		
Cineraria, per doz.	9	0	12	0	Lily of the Valley, per pot	1	0	2	0		
Cyclamens, per doz.	9	0	24	0	Marguerite Daisy, dozen	6	0	12	0		
Dielytra spectabilis, per dozen	9	0	18	0	Mignonette, per dozen	4	0	6	0		
Dracena terminalis, doz.	24	0	42	0	Myrtles, dozen	6	0	12	0		
" viridis, dozen	12	0	24	0	Palms, in var., each	2	6	21	0		
Erica, various, dozen	12	0	18	0	Pelargoniums, per doz.	0	0	0	0		
Euonymus, var., dozen	6	0	18	0	Poinsettia, per doz.	9	0	15	0		
Evergreens, in var., dozen	6	0	24	0	Primula sinensis, per doz.	4	0	6	0		
Ferns, in variety, dozen	4	0	18	0	Solanums, per doz.	9	0	12	0		
Ficus elastica, each	1	6	7	0	Spirea, per doz.	10	0	18	0		
					Tulips, dozen pots	6	0	9	0		



AGRICULTURAL EDUCATION.

HARDLY ever do we take up an agricultural paper now but it contains some mention of theoretical methods for the improved education of the rising generation of farmers, methods which appear to aim with singular unanimity at imparting a thorough groundwork of scientific knowledge as a safe and necessary basis for the practice which must follow in due course. That this is all very right and praiseworthy we have no doubt, but it will be as well to see that it is not done at the expense of practice, so far at any rate as refers to the formation of habits of industry, of close observation, strict attention to detail, and a thorough mastery of the routine of what may not inaptly be termed applied farming.

Even more important than all this is the formation of character in its literal sense of decided qualities. Force of character invariably tells, and though a man may be born a genius, a noble character is built up and formed both by careful training and by the thousand and one incidents of daily life, the knowledge springing from which we include under the comprehensive term of experience. Just so is it with an able and successful farmer, for he has applied the lessons of youth to good purpose, has built upon them a superstructure of sound practical experience, which enables him to be ever upon his guard against possible evils of all kinds, and so to prevent very many of them from causing that damage and loss which so frequently cripples or defeats the efforts of many a worthy man whose industry is not tempered and guarded by such prudence and foresight.

By way of illustration we may take outbreaks of pleuro-pneumonia. Can anything be more lamentable than the manner in which this fell disease is brought into a neighbourhood? But too often infected cattle have been purchased and taken to a farm previously uncontaminated. An outbreak follows sooner or later, leading to the slaughter of many valuable animals. On Friday, January 30th, sixteen head of cattle were slaughtered at a farm two miles west of Stockton, where an outbreak of pleuro was discovered some days previously, and as the stamping out process is now rigorously enforced by the Privy Council, the whole of the cattle on five adjoining farms were slaughtered too, because the evidence and supposition were that there had been contact between the animals on those farms. In the report of this outbreak which appeared in *Bell's Weekly Messenger* it was said that "the disease is a very subtle one, and may be latent for some time; and as Lord Londonderry's Red Marshall herd had been grazing in a field contiguous to the infected farm, the stamping out process was, by order of the central authorities in London, extended to his lordship's herd. It is, however, some months since the animals grazed there, and they had not betrayed any symptoms of disease; and on Friday when they were brought in from a field near the farmhouse to the foldyard for slaughter, they appeared to be perfectly healthy. The herd consisted of eighteen very fine black polled pedigree Scots, sixteen of which were in calf." Now, we do not know the history of the animals in which the disease appeared, and simply quote this particular case as an instance of loss, arising from possible infection which might have been prevented by the exercise of due precaution.

The same journal tells of a serious outbreak of swine fever at a farm where there were eighty-five pigs, of which twenty had already died, eleven more were suffering from the disease, and there was, of course, a probability of the remainder having to be slaughtered. If in either case the disease was taken to the farm by purchased animals it is obvious that somebody was to blame, for newly purchased animals should always be kept separate from all

home stock till it is certain they are quite healthy. The intelligent experienced farmer, however deficient in scientific knowledge, is ever on the alert to safeguard himself from such loss and annoyance. Not only does he see that due precaution is taken as we have indicated, but also that disease does not arise from any preventible cause at the farm.

It is notorious how prone farmers are to fall into a groove, to follow a beaten track, to give rigid adherence to routine from mere habit. Essex farmers did this to their cost in the last decade, for when the price of corn fell, and continued falling, they continued growing it with stolid persistence till many of them were ruined. Essex farms became vacant by the dozen, so much land came upon the landlords' hands that plenty of it was offered for sale at £10 and £12 an acre. Yet those farms were most favourably situated near London, with its ever increasing demands for dairy produce. Scotch farmers, who evidently had the right kind of agricultural education, saw their opportunity, hired the farms, got most of the land speedily under forage crops, stocked them with cows, took up milk contracts, and went straight to the success which has, and still is, crowning their enterprise and shrewdness.

WORK ON THE HOME FARM.

Last week we drew attention to the opportunity which the exceptionally clean condition of the land now offers to sow extensive leys of mixed seeds. Bear also in mind the high value of Tares, Rye, Beans, and Oats as forage crops. More and more of them, as well as Rye Grass, Cocksfoot, and Sainfoin will be grown as the prejudice against silage dies out, and ensilage takes its legitimate place in farm economy. Despite the objections raised, silage is slowly yet surely making its way, and, what is still more important, the process of ensilage is becoming more certain and more simple every year. Pressure, steadily applied to the stacks from the first day of building, is the key to success. Only give strict attention to it, and sweet, wholesome, nourishing silage is a certainty. Let not the severe lesson of a wet haymaking be forgotten. Not only was much bad hay made last summer, but much good money wasted in doing it. To waste time and money in making bad hay is about as sensible as the purchase of store cattle at prices which preclude the possibility of profit. Breed your own cattle, and breed it well; let ensilage take the place of haymaking, and two frequent sources of loss to the farmer will be avoided.

With such dry open weather the sowing of spring corn should be pushed briskly on. Barley especially is always better for early sowing, and Oats cannot well be got in too soon, provided the work is well done. With land wintered so thoroughly and the surface drying so fast there should be very little need for broadcast sowing. We prefer to drill thickly with sound heavy seed, and to drill-in chemical manure with it. We recently had our attention called to an enthusiastic statement in a Leicestershire newspaper of the saving effected by farmers who were so sensible as to procure each kind of manure separately, and to mix them at the farm. Well, we have pointed this out to our readers often enough, and also the still more important fact of the avoidance of adulteration in home-mixed manures. We have also repeatedly insisted upon the possibility of an average yield of Oats of 80 bushels per acre. But in a catalogue of farm seeds just received we find mention of crops of Black Tartarian of 104 bushels per acre on one farm, and 108, 90, 116, and 121 bushels per acre respectively on other farms. Merit is of course claimed for the pure carefully selected seed used, but it is certain that high cultivation also played an important part in the development of crops of such remarkable abundance.

METEOROLOGICAL OBSERVATIONS.

CAMDEN SQUARE, LONDON.

Lat. 51° 32' 40" N.; Long. 0° 8' 0" W.; Altitude, 111 feet.

DATE.	9 A.M.					IN THE DAY.				Rain	
	Barometer at 29.92 and Sea Level.	Hygrometer.		Direction of Wind.	Temp. of soil at 1 foot.	Shade Temperature.		Radiation Temperature.			
		Dry.	Wet.			Max.	Min.	In sun.	On grass		
1891.											
February.											
Sunday	8	30.447	39.7	39.1	N.E.	40.0	43.7	38.8	48.8	38.3	—
Monday	9	30.416	36.2	35.1	N.E.	39.7	30.0	35.2	44.9	29.9	—
Tuesday	10	30.403	34.2	33.4	S.W.	38.9	42.6	30.2	55.4	24.1	—
Wednesday ..	11	30.341	34.0	32.9	S.W.	38.0	48.2	31.1	81.9	25.6	—
Thursday	12	30.314	42.1	39.3	N.	38.1	47.3	33.9	75.9	30.3	—
Friday	13	30.499	33.7	35.3	N.	38.2	41.0	32.8	79.4	26.1	—
Saturday	14	30.703	37.7	34.7	S.W.	37.8	44.6	33.9	56.0	27.2	—
		30.443	37.2	35.7		38.7	41.5	33.7	63.2	28.8	—

REMARKS.

8th.—Slight fog in morning; overcast all day.
 9th.—Overcast throughout.
 10th.—Overcast early. Fine bright day, but no strong sunshine.
 11th.—Bright and cold.
 12th.—Fine and bright.
 13th.—Cloudless morning, and bright throughout.
 14th.—Generally overcast, but a little faint sunshine in morning. Spots of rain about 2 P.M.
 Very fine week, barometer very high, temperature just the average, and no rain.—
 G. J. SYMONS.



FRANCE IN FEBRUARY.

THE injurious effects of the present winter upon vegetation are by no means confined to the British Isles; indeed, our neighbours on the other side of the English Channel have even greater cause for complaint than our own cultivators. The average temperature in northern and eastern France appears to have been lower than here, while it has been equally prolonged, with proportionately disastrous results. Journeying from Calais to Paris and from the latter city through Normandy last week, it was strange to observe the total absence of all green vegetables, both in fields and gardens—this, too, in a country where salads and vegetables are much more generally grown and appreciated than in England. Here the loss is bad enough, but will be more severely felt in the early spring; but there it is difficult to imagine how the gaps in the supply will be filled for some time to come. Those who succeed in procuring early crops of Radishes, Lettuces, and Endive will obtain good prices; at present Watercress seems to be taking their place, and is served in a variety of ways with different dishes. Though Watercress has suffered to some extent, much has been preserved by flooding the beds with water to a sufficient depth, and now the cultivators are reaping their reward in prices three or four times higher than those usually obtained.

The elongated and blanched form of Chicory named "Barbe du Capucin" is also fairly abundant, and it is not uncommon to see men walking about the Parisian streets with large baskets on their backs loaded with this production, the long yellowish leaves and stems hanging over the sides. It is not, however, all Chicory, for the common Dandelion is grown in a similar manner, but does not produce such long attenuated leaves, though it is scarcely less esteemed when properly prepared. In the hotels and restaurants Celeriac is generally utilised at the present time, and is served in small thin slices with a sauce in which mustard and vinegar predominate, and to some extent takes the place of the delicious little early Radishes, which are as yet very scarce. Instead of the ordinary fresh salad, preserved Peas, finely sliced Carrots, &c., are mixed with the indispensable ingredients of oil, vinegar, pepper, and salt, into a vegetable salad of a rather more substantial, and certainly very agreeable character. Concerning the ordinary Globe Artichokes, which are much in demand in France, complaints are general that the winter has dealt most severely with the home cultivated plants, a large proportion being killed, and though supplies are obtained from the South and from Algiers during winter, for spring and summer large quantities are grown in France. Seedsmen and others are eagerly inquiring respecting the condition of the plants in England, and the prospect of obtaining supplies to make up the deficiency. Unfortunately these Artichokes are by no means largely cultivated here, and although some have found them profitable the demand is much more restricted than in France.

The effects of the frost are still more apparent amongst the Roses and shrubs, and nurserymen would have the prospect of extensive business before them were it not that they also are victims. With regard to Roses, if one-tenth of the reports I heard are correct the damage must be exceedingly serious, and will prove the ruin of many small traders. In a few instances a careful system of protection has been provided, and plants have been housed as additional security with considerable satisfaction to the cultivators,

now they find how much the unprotected Roses have suffered. Amongst the shrubs common Laurel, Aucubis, Euonymus, and Hollies are the chief victims, and a terribly bare and browned appearance they present in many gardens. To render them anything like respectable hard cutting back will be needed in the majority of cases, and there will be gaps to be filled. Tender trees, like Magnolias, which have stood out for years are also affected, and the list of killed and wounded will, it is feared, be a long one.

Visiting the principal florists' shops in the boulevards of Paris would, however, afford a very imperfect idea of the winter's results. Plants and flowers are as abundant as in spring, and though the range of variety is more limited, there is ample to delight the intending purchaser or the mere spectator. The Parisian florists' shops are in fact floral bowers or artistic exhibitions worthy of something more than a cursory glance, and whatever difference of opinion may exist with regard to the taste displayed in the special arrangement of flowers, there can be none respecting the general appearance of the shops themselves. In comparatively few instances in London is any attempt made to render such establishments attractive; in Paris it is the rule, and one of our style is the exception. Nothing very pleasing can be found in a prominent display of bright red flower pots, or if these should be, which is frequently the case, none too clean, the effect is even more disagreeable. To avoid all this, forced and other plants in flower are placed in neat baskets of varied form, and arranged upon pedestals of different heights, while in recesses and as a background Palms, Ferns, and foliage plants generally are freely employed. Indian and deciduous Azaleas furnish abundant colour at the present time; then there are forced bulbs like Hyacinths, Tulips, and Narcissus, the little white Roman Hyacinth being a great favourite as with us. Lilies of the Valley also are handsome, with long spikes of large pure bells, and well developed foliage. Orchid plants are much more frequent in the florists' shops than was the case a few years ago; at this time of year *Lycaste Skinneri*, *Cœlogyne cristata*, *Cypripediums*, and *Dendrobiums* are seen, both as fine specimens and cut flowers, and furnish an important attraction. Amongst the cut flowers Violets largely predominate, the supplies from the South of France coming exceedingly fresh, large, and sweet. Scores of hawkers and flower girls are seen every fine day in some of the principal thoroughfares selling Violets at ten to twenty centimes (1d. to 2d.) a bunch, the selected flowers being of exceptional size and depth of colour. The fragrant yellow Acacias from the warmer southern regions are represented by long branches, in some cases of tree-like dimensions, and it is difficult to imagine how such a supply is maintained, however rapidly the trees may grow. Roses are scarce, but are now appearing in the markets in the usual Parisian style, cut with foliage and stems 2 or 3 feet long, and stately groups they form in massive vases. Chrysanthemums are over, but they have been in great demand until recently, owing to the scarcity of other flowers, and it is said that fine blooms have been sold late in the season for four and five francs each. I have heard of 2s. 6d. being obtained for a specially handsome Chrysanthemum bloom in London; but 3s. to 4s. each surpasses our record on this side of the Channel.

Fruit at this time of year is necessarily much restricted in supply, but handsome Pears of the Channel Islands type are displayed in the fruiterers' windows, also good Apples and quantities of black Grapes, chiefly Gros Colman. Of the last named, in one of the chief shops in the Palais Royal I saw some capital examples from M. Phatzer, who, with his partner M. Cordonnier, has established extensive vineries at Roubaix on the English market garden principle. A few extra early Strawberries were shown, but they did not look particularly tempting. Imported Pine Apples were, however, unusually handsome, but the prices were somewhat higher than those which prevail in London for similarly fine fruits. Large quantities of Oranges are sold both in the shops and on the

hawkers' barrows, and in some quarters of Paris it was strange to see large Oranges stripped of their peel exposed for sale. It is said that the peel is utilised in the preparation of a liquor, and the Oranges are then sold at about the same price, thus realising two profits. One curiosity in the fruiterers' and other shops were the "Nids des Hirondelles de la Chine" (Chinese swallows' nests), which are sold for eating, but I did not have an opportunity of testing their qualities.

February is not precisely the best time for a visit to France, but the preceding notes will indicate that some interest can be found in the gay city even during such a dull month and after such a winter. But they only afford a general survey, for in the few days at my disposal I succeeded, by the strictest economy of time and the kind assistance of good friends, in inspecting the astonishing Peach gardens at Montreuil, the extensive bedding plant producing establishment at La Muette, the Orchids and Palms in the Jardin d'Acclimatisation at Neuilly, MM. Vilmorin, Andrieux & Cie.'s great emporium of seeds at Reuilly, with several other horticultural attractions in the Paris district. Then, too, I had a most enjoyable trip through the Apple orchards of Normandy, but as it would be obviously impossible to relate in this article all that was seen in this journey some notes will be reserved for subsequent letters. It may be remarked that the absence of rain in France, as here, has brought the soil into good condition for the plough and spade, and full advantage has been taken of that, for the land is being rapidly prepared for the spring and summer crops. Unfortunately I hear on good authority that much autumn-sown Wheat has been killed by the frost, and spring sowing is required in many districts. During my brief sojourn, too, there was ample evidence that our neighbours are not entirely exempt from the fogs which trouble us so much; they are, however, less dense and of shorter duration, so that little damage is done to plants or flowers. When a fine day comes, such as favoured my visit to Montreuil, we realise the difference between a continental and an insular atmosphere. Such a deep blue sky and peculiar clearness of the air are unknown here even in summer.—LEWIS CASTLE.

PEACHES AND NECTARINES.

GOOD varieties of both Peaches and Nectarines are very plentiful, so much so that it is difficult to select any one sort as the best. With some the very name Royal George is sufficient to distinguish any dish bearing that name in the show as the best. Allowing them to be true, for it is no uncommon thing to see several sorts bearing that name in an exhibition, unless they were above the ordinary standard I prefer Grosse Mignonne for quality, but for general usefulness, appearance, and quality combined I would select Bellegarde as the best one Peach for all purposes. It would also keep good a considerable time if gathered just before it is ripe. Nevertheless, Royal George is a fine sort, and succeeds admirably in some localities in a free open soil on a gravelly subsoil, but in a low cold damp soil it is subject to mildew, and the fruit is often undersized and of moderate quality, but there are exceptional instances where it is the reverse. Perhaps the fine old specimen in the gardens at Chatsworth affords the best example; this Peach tree has done well for very many years, but it is growing in a raised border in a peachery.

As I have tried numerous sorts of both Peaches and Nectarines my experience and selection may be of service to those in less favourable circumstances. As some Peaches are difficult to distinguish by their fruits alone, I will endeavour to describe them by their flowers, as they are in many instances most distinct and more readily recognised when in flower. I will take them in the order of ripening, earliest first.

Alexander.—Flowers large, pale pink, narrow petals, rather sparsely produced; anthers long, dark pink, the pistil the same length; free setter. Fruit rather small, colours well, and of fair quality. It forces well, and is useful on account of its earliness.

Hale's Early.—Flowers large, pale pink; anthers pale pink, pistil same length as anthers; very liable to cast its buds, but nearly every one that opens will set a fruit, which is of good size, round, handsome, and of fair quality.

Grosse Mignonne.—Flowers large, pale pink; anthers dark

purplish pink; pistil yellow, longer than anthers; fruit very delicate, pale pink, somewhat flattened, uneven outline, one side often much larger than the other; fine quality.

Stirling Castle.—Flowers small, dark red; anthers dark red; pistil a little longer than anthers; sets freely and forces well; fruit medium sized, well coloured, and of uneven shape, sometimes almost cut in half; quality good.

Royal George.—Flowers small, dark red, plentifully produced; anthers dark dull red; yellow pistil often shorter than anthers. Fruit medium size, bright red, good even outline, and handsome; good quality.

Violette Hâtive.—Small dull red flowers; anthers dull red; pistil a little longer than the anthers. Fruit medium size, dark purplish dull red, rather flat shaped, handsome, and good quality.

Bellegarde.—Flowers small and pale pink; anthers purplish pink; pistil yellow, slightly longer than the anthers. Fruit medium-sized, dark dull red, splashed with violet stains, nearly round, and good quality.

Crimson Galande.—Flowers large, pale pink; anthers bright purplish red; pistil a little longer than anthers of the same colour. Fruit very similar to Bellegarde, perhaps a little brighter colour, and somewhat flat, but good quality.

Sea Eagle.—Flowers large, pale pink; anthers the same colour; pistil yellow, same length as the anthers; very handsome flower. Fruit splendid size and beautiful shape, perhaps the handsomest Peach grown, and fair quality.

Barrington.—Flowers large, bright pink; anthers purplish red; pistil yellow, rather longer than anthers. Fruit very large, oval shape, bright red on sunny side, handsome fruit, and good quality, rather shy.

Noblesse.—Large bright pink flowers, dark purplish pink anthers, yellow pistil, rather longer than anthers. Fruit medium size, pale pink, round, somewhat flattened fruit, when well grown is very handsome and good.

Downshire.—Flowers small, dull red; anthers dark dull red; pistil very stout, dull red, same length as anthers. Fruit medium size, very bright red, round shape, sometimes bearing a nipple, very handsome, free bearing, and good quality.

Dymond.—Flowers large, pale pink; anthers long, pale pink; pistil yellow, same length as the anthers. Fruit large, round, dull red, and good quality; does not stand forcing so well as others.

Goshawk.—Flowers large bright pink; anthers pale pink; yellow pistil, little longer than anther. Fruit moderate sized, pale pink, round even outline, good quality, but does not force well.

Walburton Admirable.—Flowers small, pale pink; anthers very pale pink; pistil yellow, level with the anthers. Fruit large, handsome, pale pink, round even outline, and when there is plenty of sunshine of fair quality.

Golden Eagle.—Rather small flowers, dull pink colour; anthers dark purplish pink; pistil yellow, projecting beyond the anthers. Fruit medium to large, very bright red next the sun, dark orange on shaded side, moderate quality, but the best late Peach.

Princess of Wales.—Flowers very large, pale pink; anthers same colour; yellow pistil, same length as anthers. Fruit very large and handsome, pale pink, sometimes it has a nipple, and fair quality, good keeper.

Late Admirable.—Flowers very small and insignificant; almost white anthers; pistil white; a little larger than anthers. Rather shy setter and poor quality, but a very large, showy, useful late Peach.

As I have dwelt so long on the Peach my notice of Nectarines must necessarily be brief, but as they are not in such great demand it will be of little consequence; however, the following few are among the best:—

Lord Napier.—Flowers large, pale pink; anthers very pale pink; pistil yellow, longer than the anthers. Fruit large, round, even shape, well coloured, and of fine quality; keeps good a long time.

Rivers' Early Orange.—Very large pale pink flowers; anthers same colour; yellow pistil, longer than the anthers. Fruit very bright dark red, nearly round, yellow flesh, fine quality; and keeps well.

Ebruge.—Flowers small, dull dark red; anthers same colour; pistil yellow, slightly longer. Fruit large, bright crimson, oval shape, very handsome, and of fine quality.

Violette Hâtive.—Flowers small, pale pink; anthers very pale pink; pistil yellow, longer than the anthers. Fruit medium sized, dark crimson, with little grey specks, cone shape, fine quality.

Victoria.—Flowers small, bright pink; anthers dark purplish red; pistil yellow, longer than the anthers. Fruit large, round, bright red on sunny side, almost green shaded side, good quality.

Albert Victor.—Flowers small, bright pink; pale pink anthers;

pistil yellow, same length as the anthers. Large cone-shaped fruit, dull red on sunny side, dark green shaded side, fair quality, useful late kind.—J. H. GOODACRE.

A SCARCITY OF PARSLEY.

ON all sides complaints are heard of the damage done to Parsley by the severe frosts, and personally I never knew it to be so scarce generally. A moderately severe frost will destroy the extra finely curled or "double" Parsley, but the common or "single" forms, to be found in the gardens attached to many farm houses and some cottages, and which are invariably self-sown, are not nearly so tender. Even these have collapsed this winter, and in most instances a fresh start will have to be made. Those who had proper conveniences and were "wise in time" have a considerable number of roots stored in pots and boxes under glass, and in frames and pits; but these will be so closely gathered from that in but very few cases will there be sufficient to meet the never-ceasing demand till such times as abundance will be forthcoming from newly raised plants.

Seeing how proverbially slow Parsley seed is in germinating, and the time in which the plants are in reaching a serviceable size, it is evident that extraordinary efforts must be made to forward them, otherwise the supplies during the next four months will be altogether inadequate. Years ago I discovered that Parsley could be forced as readily as Carrots—in fact it was the presence of seedling plants among the Carrots in frames that first suggested the idea of forcing Parsley to me. One or two-light frames set on a gentle hotbed, and otherwise prepared as for Carrots, will answer well for Parsley. The seed may either be sown in drills 6 inches apart or broadcast, and in each case if need be with Radishes between or among it. We usually water the surface of the bed or the drills, as the case may be, prior to sowing the seed thinly, and cover the latter with a little finely sifted soil. It is not long in germinating, much naturally depending upon the heat in the bed. Unless the seedlings are very thick no thinning is necessary or advisable, and a great amount of air need not be admitted, the frame, in common with the rest, containing Carrots and other vegetables being matted over every evening. Those who have a few live roots left in the open might well dibble these in between the rows of seed, and an early supply of young leaves be obtained thereby, the seedlings giving a succession.

When the young plants are fairly strong, and have tap roots nearly the size of the stalk of a Vine leaf, the time has arrived for transplanting a considerable number of them to a fairly warm border. This ought to be well prepared for their reception, being manured and dug early enough for it to become thoroughly pulverised. For several years past it has been my custom to prepare a border principally for Parsley, but which also does good service as a Shallot and Garlic bed. Bulbs of these are put out during February in rows 12 inches apart, and by the time the Parsley is ready to dibble out are nearly fully grown, coming off long before the latter requires all the space. The Parsley being duly dibbled in 6 inches apart midway between the rows of Garlic and Shallots does not suffer greatly from the transplanting, the thick tap root doing good service. Without much further trouble a fine even bed of Parsley is produced, surpassing in every respect any that can be produced without transplanting. We have twice missed sowing Parsley in frames during the past ten years, and each time had good cause to regret having done so. All things considered it is much the most satisfactory plan to raise the requisite number of plants in heat, while those left in the seed bed or frames produce fine early leaves, and continue to do so as long as needed. All cannot devote a frame to rearing Parsley plants, but there is nothing to prevent most gardeners from raising all they may require in boxes or pans set in heat.—W. I.

PRIMULAS AT PERRY HILL.

YEAR by year it has been a pleasant task to record the advance made by Messrs. J. Carter & Co. of High Holborn in the improvement of that important race of Primulas comprising the varieties of *P. sinensis*. Again we have to refer to the subject, for at the firm's Perry Hill nurseries there is at the present time a bright and beautiful display of these useful plants, surpassing in some respects those of previous years, notwithstanding the trying meteorological conditions with which cultivators have had to contend. Over 6000 plants are grown for seed bearing alone, and to these three large houses are devoted, one fully 150 feet in length presenting a Primula exhibition of much interest, as showing what has been effected in extending the range of variation, improving the colours, the form, the substance, and the size of the flowers.

It is only by continued close attention during a number of years that such results can be attained, and the number of carefully considered crosses needed to effect any particular object is astonishing. There are so many points to be regarded, as besides the floral attractions of the plant the habit demands attention, and in this also the advance accomplished is very noticeable. Sturdy compact growing plants with vigorous trusses of flowers borne just clear of the foliage, yet not tall enough to appear weakly, are the characters required and worked for, and the success achieved is well illustrated in the plants at Perry Hill.

It is unnecessary to enumerate all the varieties represented, as they are duly catalogued and described, but some of the chief types may be noted, the prefix "Holborn" to each indicating its origin. Similar classes run through both double and single forms, also through the two distinct types of "round" and "Fern" leaved, so that considerable diversity may be secured by those desirous of forming a collection. Queen is a pure white variety of great merit, the flowers of fine substance, and the habit excellent. Elaine is ivory white, a delicate and pleasing colour, good flowers, and free. Magenta, Vermilion, Carmine, and Ruby represent rich and pure shades of colour, well indicated by their names, and are varieties of considerable value and usefulness. The blue varieties must also have special mention, for to them much attention has been paid in recent years, and the improvement is evident in all the qualities that render a Primula desirable. There is promise of many more novelties, but the qualities of those named have been so well established and proved that it is not easy to obtain departures from the types worthy of preservation.

THE LONG FROST AND INSECT LIFE.

THE recent long and exceptional frost has told and is still telling its tale in all directions. Nurserymen, like other folk, have not escaped annoyance and actual loss. Evidently it is likely to delay somewhat the customary spring orders for seeds and plants, by the retardation it has produced generally; while if it be true that the destruction of evergreens and other plants must ultimately oblige people to replace these by new stock, nurserymen have themselves been sufferers, for taking all precautions possible, they could not save many of those species upon which severe and long-continued cold is sure to have its effect. Some of our friends, however, who try to take the optimist view of matters (which is, after all, the better one, for despondency checks wholesome efforts to improve things) are encouraging themselves by the supposition that a probable result of the intense cold will be a great diminution in the number of insect pests during the approaching season.

Now, there are several reasons for hoping that such may be the case, especially when we consider the period over which the frost extended, at least in the south, for both in the north of England and in Scotland it seems, on the whole, to have been less severe. But, as I have pointed out, when writing upon the subject in this and in other journals, the effects of cold weather upon the insect world generally are not so unfavourable as many might think, that is to say, cold weather in winter. On the other hand, damp and mild winters have been proved beyond all doubt to cause frequently the death of a great many hibernating species. Pupæ or chrysalids that are lying in the earth become sometimes so damp that decay commences, and the insects never emerge; and then again, owing to the soil being loosened by the moisture, insect-eating birds are able to dig up and devour many kinds that escape them during such frosts as we have had this winter. Also the caterpillars which hibernate amongst low plants, or on twigs of shrubs and trees, suffer from a fungoid malady connected with dampness, by which a proportion are killed. No particular effect appears to be caused on the eggs of insects by excess of moisture, unless it should in conjunction with warmth produce premature hatching. Certainly injurious is mild weather early in spring, speedily followed, as is not unusual, by strong winds from north or east. Myriads of caterpillars emerge to attack the young buds, but fortunately a considerable number are blown from their food, being small and weak, perishing when a few days old.

Looking particularly at the influences of the recent long frost, it is evident that by its means many insectivorous birds were deprived of their usual winter food. They could not possibly break up the earth in fields or along the hedgerows, but of course the species which occupy themselves with hunting insects in the cracks and hollows of trees were not quite so badly off. Upon some caterpillars that hibernate the cold might have a somewhat bracing effect, and with others it would produce a deeper torpor than usual, but they would be none the worse for that, for caterpillars have been found actually frozen and hard enough to rattle like

little stones, yet they have afterwards revived, and seemed none the worse. So, too, is it with regard to all or nearly all the eggs of insects. As already remarked, many of them have not only strong shells, but they are protected from the weather by a coating of varnish, and also often placed in angles or corners where they are sheltered. Spallanrani tried some with a freezing mixture, and found 23° below zero did not harm them. The autumn-laid eggs of such species as the lackey moth and the little ermine will, if left undisturbed by the fruit-grower, hatch out when spring arrives; so, too, the winter-laid eggs of the mottled umber or the winter moth and kindred species, wherever they have been deposited. I may remark that some naturalists have suggested that birds in times of distress may seek out and devour the eggs of insects, but of this we have no proof. Not a few of them, however, are attacked by tiny parasites. Some flies deposit eggs within the eggs of other species, and the carnivorous grub sooner or later kills and eats the vegetable feeder.

The cold of last winter must have influenced those moths which appear in their final stage between November and February, and amongst these are included some very persistent enemies of our fruit trees. By a special provision of Nature, designed for the preservation of certain species, we find that there are cases, like that of the small egger moth, where only a portion of the brood emerges each winter, some of the insects remaining two, three, or four years in the pupa state. Our enemy the winter moth does not seem to be thus provided for contingencies, and I suspect this insect, in places where it had not emerged before the frost set in (and probably the mottled umber also), would often die from being unable to extricate itself from the pupa shell. Other pupæ in the earth, lying there awaiting spring and summer, would be injured when the frost struck deeply, since their vitality is less strong than that of hibernating caterpillars. Of those caterpillars some that feed at intervals during the winter would be unable in the long frost of 1890-91 to obtain grass, chickweed, or other low plants that afford them nourishment, and then they will have become too feeble to feed in the spring. Amongst the root-gnawing caterpillars some that usually feed only a short distance beneath the surface, may have suffered from inability to pierce the ground and continue their tunnels. Those hibernating caterpillars would fare best that habitually sleep on without any winter food. I do not think the heavy rime frosts which have sorely tried our trees and shrubs have done much harm to caterpillars that feed within their branches; for example, that of the Currant Clearwing, from its horny skin, would not mind the cold, nor the larger caterpillar of the Leopard moth. There has probably been some destruction of the insects that hide under loose bark and stones. Centipedes, like worms and slugs, would guard themselves from the cold by remaining in their retreats, where the frost, if it reached them, could injure them but little. On the whole, I should say we might hope in 1891 to have, if not a very small number of insect pests, certainly no extensive appearance of any troublesome species.—ENTOMOLOGIST.

THERE seems to be a general opinion that the frosts we have experienced recently will have destroyed most of the insect enemies of the gardener and fruit grower. I hope such may be the case, but I doubt it. A well known fruit grower wrote me some little time ago to the effect that there would be no caterpillar plague in 1891, as the frost would no doubt have destroyed the eggs. To test this, and also to try some experiments, I put some Pear shoots infested with eggs of the winter moth in heat in our earliest Peach house. The result was that the eggs commenced hatching freely during the past week, each young caterpillar going on the war path as soon as hatched. Much harm is done by not commencing spraying fruit trees early enough. Our experience here is that it is unsafe to leave it later than the first week in April before beginning operations. I would strongly urge gardeners and fruit growers to procure Miss Ormerod's report as soon as published, for it will contain the latest information from America and this country on destroying insect enemies.

Another prevalent idea is that a hard winter is followed by a bounteous season. From a print before me it seems this is not a fact, as it appears that the seasons following the hard winters of 1854-55 and 1860-61 were the reverse of good. Some have a strong belief in an "old-fashioned winter" retarding the flowering of fruit trees, and thus causing heavy crops to follow. This is opposed by facts. Both my employer and I have taken notes over a series of years, and it is rather astonishing how little the flowering time is affected by seasons, being in the majority of cases seldom more than two or three days. Unless we have colder weather fruit trees will flower earlier than usual this year, as Pears, Apples, Plums, &c., are moving rapidly; Pears especially are in some instances particularly forward.—S. T. WRIGHT.



DENDROBIUMS.

THIS genus comprises some of the most beautiful and best known Orchids. Most of the species are of easy culture, and some are fragrant. There is a considerable difference in the habit of growth of some of the species, which as cultivated plants enhances their value. The erect-growing species show themselves to advantage grown in pots and arranged on stages like most other plants, while those of drooping habit—and they are many—suspended from the roof are very graceful, besides saving much valuable space.

Perhaps the greatest stumbling block to beginners is the resting period, which is an essential condition. With a little observation anyone will soon learn when growth has been completed, and will therefore know that the period for rest has arrived. The plants should then be placed in a cool house, and as near the glass as possible, and kept moderately dry. The drying process, as practised years ago, is now discountenanced by many growers as injurious. If deciduous plants show the least sign of distress by the softness or shrivelled appearance of their pseudo-bulbs water sufficient to well moisten the whole compost in which they have been growing should be afforded, and the plants left alone until water is again required. The evergreen species must receive a little more attention, as if they become too dry they are apt to turn yellow at the tips and margins of their leaves, thus becoming unsightly. A low and moist temperature has also the same effect.

A cool and dry atmosphere has more to do with the well-being of Dendrobiums than dryness at the roots during the resting period. To this end choose a cool house with a southern aspect. It is not advisable to allow the temperature to fall below 40° Fahr., though we had some of the species in a lower temperature this winter without any apparent evil results. *Dendrobium McCarthiae* and a few others require warmer treatment during the resting period, a temperature of 50° to 55° being the best suited to their requirements.

What was at one time a craze for pruning Dendrobiums seems to have passed away, and fortunately, for many good plants were injured and even lost by the injudicious use of the knife.

Of the species best adapted for pot culture *D. Dalhousieanum* is among the best, which, when well grown, forms a handsome exhibition plant. Its large buff-coloured flowers are delicately shaded with pale lemon, and have on the labellum two dark crimson spots and margined with rosy pink. Its pendulous racemes, which are many-flowered, are produced on the ripened growth of the previous year. The height of the pseudo-bulbs in strong examples is considerable, often as much as 5 feet. They are stout, and lined with purple their entire length. It is a native of India and requires stove treatment. *D. Brymerianum* is another suited for pot culture, and is less grown than it deserves. It bears yellow flowers, which are beautifully fringed and produced singly or otherwise from the upper nodes of the two-year-old and older growths. It is evergreen, and requires stove treatment.

D. Calceolaria is another species of merit, and should, together with its allied species, all of which are comparatively cheap, find a place wherever Dendrobiums are grown. Dendrobiums of the densiflorum type are too well known to need description. *D. Farmeri*, *D. Findleyanum*, *D. Wardianum*, and many others are already represented in most collections.

The old favourite, *D. nobile*, is perhaps the cheapest of all the species, and one of the most beautiful. It is a native of China, and succeeds well under cool as well as warm treatment. It bears without injury more hardships than any other we are acquainted with, and is essentially the Dendrobium for amateurs. It bears pruning better than most others, and is propagated readily from the growths thus cut, if tied round a block of wood and suspended in the stove and frequently syringed. We have known half a dozen growths thus treated to make a good panful, and producing a good panful of flowers the third year. The old pseudo-bulbs must not be removed before the young growths have made a start, when, after the pruning has been done, both plants and prunings should receive stove treatment. There are now many good varieties of *D. nobile* in commerce. It is interesting to note the important part which this old favourite has played in the production of hybrids. *D. Dominyanum* was one of the first successes of the late Mr. John Dominy, and is a hybrid between

D. nobile and *D. Linawianum*; *D. Ainsworthi*, *D. Leechianum*, and others also have *D. nobile* for one of their parents.

Of the species which on account of their drooping habits are best suited for basket culture *D. Devonianum* is one of the best, probably the most showy of all. Its principal attraction consists of the delicate lace-like fringe of the lip. It is a noble species and very floriferous. *D. primulinum* and *D. Pierardi* are beautiful basket plants, though of less imposing appearance than the foregoing.

The Australian species have not found much favour in gardens, probably because their requirements are as yet little known. A few of the species which are generally accorded stove treatment succeed well under cooler conditions, and in some cases even better, such for instance as *D. Jamesianum*.—W. R. WILLIAMS, *Great Marlow*.

ODONTOGLOSSUM MACULATUM.

A RATHER curious freak has occurred here with a plant of this pretty Orchid, which I thought might be of interest to some of the readers of the Journal. Instead of the flower spike growing from the base of the pseudo-bulb, as they usually do, two have grown from the apex, one with four and the other with five flowers. The pseudo-bulb from which they have grown is not much larger than a walnut, so over-luxuriance could not have been the cause of its doing so. A larger pseudo-bulb on the same plant has produced a spike in the ordinary way. There is very little difference between the flowers. The sepals of the flowers of the larger pseudo-bulb are a trifle longer than the others; in other respects they are alike. The varieties of this, as of most other *Odontoglossums*, appear to be almost endless, as no two which have come under my notice have been exactly alike, and some of them are very handsome. Not the least of its good qualities is the time the flowers last in perfection, and flowering as it does at the dull season of the year greatly increases its value.—A. WHIBLEY, *Eastbourne*.

ORCHIDS AT CAMP HILL, WOOLTON.

AMONG numerous varieties of Orchids in bloom at Camp Hill, Woolton, the residence of F. H. Gossage, Esq., the following varieties are vigorous in growth and have abundance of flower. There are six pans of *Ceogyne cristata* and its varieties, one pan of *C. cristata* with 365 flowers, and one of *C. Lemoniana* with 232 flowers, being especially good; a very fine plant of *Cymbidium Lowianum* with six spikes and seventy-six flowers; a grand piece of *Lælia anceps* carrying thirty spikes, some of which have five flowers on a spike. *Dendrobium nobile* is represented by four pans all well flowered, and *Dendrobium Wardianum* Lowi, six pots, with eighty-eight flowers remarkably good; a beautiful plant of *Dendrobium heterocarpum* bearing sixty flowers, and another of *Dendrobium fimbriatum* with twenty-four fine spikes. The above are only a few of those in the very choice collection grown at Camp Hill. Mr. Jellicoe, Mr. Gossage's head gardener, knows the treatment they require, and it is astonishing how rapidly many of them have thrived, and they are certainly the finest they have ever had in bloom. Another feature at the present time is a splendid collection of *Primulas* in full bloom.—R. P. R.

ORCHIDS AT FOREST HILL.

AN attractive display of useful Orchids is now to be seen in Messrs. J. Laing & Sons' nursery, Forest Hill, where the plants are extremely well grown. *Dendrobium Wardianum* is a special feature, producing long pseudo-bulbs and fine flowers. *D. nobile* and its best varieties are included, together with *D. crassinode* and the variety *Barberianum*. *Phaius grandifolius* is well represented by strong plants and flower spikes. *Dendrobium Ainsworthi*, *D. primulinum*, *Lycaste Skinneri alba*, *Cattleya Trianae* varieties, and *Cypripedium callosum* constitute a bright group at the entrance to one of the houses. In the cool house *Odontoglossum Rossi*, *O. crispum*, *O. Pescatorei*, and a very richly coloured *Oncidium cucullatum* are noteworthy amongst those in flower. In other houses there is a brilliant display of forced flowering plants, and in the Tuberous *Begonia* department great activity prevails in preparation for the coming season.

DEATH OF MR. FRANK CASEY.

MANY readers will learn with the deepest regret that Mr. Frank Casey of Clapton died suddenly on Thursday last. Mr. Casey had been for many years manager for Messrs. Low & Co., Clapton, and was widely known and respected in the horticultural world. He possessed an extensive knowledge of plants, but had been especially identified with Orchids, his geniality having rendered him a general favourite. His death appears to have been occasioned by hurrying to catch a train at Liverpool Street station.

SCHOMBURGHKIA SANDERIANA.

THE members of this genus are not very abundant in cultivation, though *S. tibicinus* is occasionally seen as a curiosity. The new species, of which a flower is represented in fig. 30, appears, however, likely to be a useful addition to the list of cultivated forms. The flower is about 3 inches in diameter, the sepals lanceolate, half an inch apart at the widest part, $1\frac{1}{2}$ inch long, and pale rosy purple. The petals are broader and less tapering, the same length as the sepals, but deeper in colour. The lip is $1\frac{1}{2}$ inch long, the central lobe rounded, an inch across, and slightly cut at the margin, rich crimson-purple, like the lateral lobes, which are folded over the column, and the white blotch in the throat brings the colour into bold relief. In general appearance the lip is suggestive of a small *Sobralia*.

The plant produces hollow pseudo-bulbs like its relative, the "Cow Horn Orchid," as *S. tibicinis* is sometimes termed, and it is supposed that these cavities are utilised for a similar purpose by the ants of the districts in tropical South America where the plants are found. The flowers are produced in short racemes of four or five each; but it is said to be very free, and its colour will



FIG. 30.—SCHOMBURGHKIA SANDERIANA.

render it a favourite. The plant was introduced a few years ago by Messrs. Sander & Co., St. Albans, and flowered a week or two back for the first time.

BRITISH FRUIT GROWING AS AN INDUSTRY.

ON Saturday evening, at the Grosvenor Museum, Chester, the usual fortnightly meeting of the Chester Paxton Society was held, when the President, Mr. John Taylor, took the chair, and Mr. E. J. Baillie delivered a lecture on "British Fruit Growing as an Industry."

Mr. Baillie pointed out that the question of fruit growing had latterly been very much in the mind and upon the lips of the public, and this was due to a multiplicity of causes, which he enumerated, and upon which he commented. He reminded the members that there was a great difference between growing fruit for the needs of a private establishment and growing fruit as an industry. When a man had to get a living out of a followed occupation he had to put his faculties into motion, and look about him to see what should be done, so that it would be well to take a brief review of the class of man wanted to meet the requirements of the new industry.

A good deal of misconception prevailed on this matter. It was believed that the British farmer would also be the British fruit grower. He probably would be a fruit grower in greater measure than was at present the case, but we would have to look further afield for the class of man required to meet the spirit of the times in this particular undertaking. In horticultural parlance he would have to be somewhat of a hybrid. He must have the qualifications of three or four personalities, so to speak. He should be something of a farmer, much of a gardener, must possess business tact, commercial enterprise, indomitable energy, the spirit of the student, the suavity of manner of the salesman, with the instinct of the artist and Nature lover, so to speak, which sees what is pretty and proper, and puts it so. There were other features, but the catalogue was long enough for the present. Poets, it was said, were born, not made. He ventured to improve upon the aphorism, and say a fruit grower must be both born and made, but he will not be made by taking a twelve months' course at any so-called horticultural college, or any other establishment where the experience of half a lifetime is

supposed to be acquired in a season. Nature will not be hurried in her processes, and the lesson of a given period is only to be perceived once in the course of a year. But, after the man, the land must be studied and dealt with, and that opened up a wide vista for thought and argument.

Having dealt with the land, Mr. Baillie proceeded to speak of market aspects and arrangements, pointing out that whilst the producer must aim at both quality and quantity, it was absolutely necessary for success that he should insist upon quality. He then spoke upon fruit preservation, and upon the various phases coming under this head, and spoke at length on British Apples as probably the staple product of the British fruit farm. During the delivery of the address several instances were given of failure and of blunders made by those who in their zeal had taken up the cult before they had fitted themselves for its needs. Some puzzles of horticulture, and hindrances and disadvantages were dealt with at length, and apparently to the satisfaction of the audience, who frequently emphasised the speaker's remarks.

Mr. Baillie concluded by pointing out that they had considered the matter perhaps too exclusively from a pounds, shillings, and pence point of view, but he had tried to bear in mind that he was treating the subject as an industry, and it was therefore necessary that they should keep their eye on the profit and loss account. But there was another side of the question, a most important side, for the future happiness and welfare of the nation could be largely influenced by an extended practice of fruit growing, involving of course an implied effect of this system of cultivation, that, namely, of a largely increased use of fruits as the food of the people. There were weary eyes aching over the needle night after night; to these there was nothing to look at in this beautiful world but the dull dim street; there were heavy hearts which heard no music but the dinner bell at the factory; there were languishing spirits in close crowded courts fainting for the breath of the breeze, and toilers in the towns whose lives were joyless and hopeless. Let them open the gates of Arcadia, lead the children out into a peopled Paradise, and how grandly would everything go in the way in which those who saw rightly and felt rightly wished. Coming face to face with the freshness of Nature one seemed to strike off the chains that bound humanity down to the dull routine of a sunless life where smoke and chimnies took the place of sunshine and trees, and the hissing of steam and fumes of chemicals tormented and stifled those who might find freedom and fulness of life in the work of the orchard and the garden or rest in the grove. (Applause.)

The President, Messrs. Siddall, Wynne, Sheppard, Newstead, and others addressed the meeting, and one of the members displayed a collection of Pears and Apples in splendid condition to show in what state of preservation British fruits could be kept with ordinary care nearly through the entire season. A vote of thanks to Mr. Baillie brought an interesting meeting to a close.



THE ROSARIAN'S YEAR BOOK.

WORTHY of more than a passing note, we have for some time past been seeking an opportunity for glancing through the pages of the last issue of the work of our respected coadjutor, Rev. H. H. D'Ombraïn, with the object of indicating the character of the different chapters in the Rose columns of the Journal. Generally speaking the work may be fairly described as one of the best of the series, and if there are any Rose growers yet unsupplied with a copy they had better at once tell their booksellers that the publishers are Messrs. Bemrose & Sons, and thus obtain one, for there is certainly matter to interest, instruct, and amuse in its seventy-two well printed pages.

The portrait of the year is an admirably executed photograph of Mr. George Dickson of Newtownards, a name that has become very prominent during recent years in the Rose world in consequence of his success in raising several varieties of Roses which the world will not willingly let die. The chief of these are enumerated by Mr. D'Ombraïn, who also indicates their characters, and further tells us that Mr. Dickson carefully hybridises about 300 plants annually, and sows about 3000 seeds. His gold medal Rose of last year, Margaret Dickson, is highly spoken of as likely to supersede Merveille de Lyon, one of its parents. Something is usually "going on in Ireland" that is apt to give rise to differences of opinion, but we apprehend there must be a very close approach to unity in desire that the sister isle will send us yet more beautiful Roses.

The Editor passes in review the work of the National Rose Society during the past year, and finds it on the whole satisfactory. The Society has more members than ever, a surplus of income over expenditure, and had very good shows, considering the singularly unpropitious weather during the show season. There appear to have been two champion amateur exhibitors during the year, for we are told that "Mr. Lindsell, besides winning the challenge trophy, won twenty-six

first prizes, fifteen seconds, three thirds, one fourth, one gold, and four silver medals; and not less remarkable was Mr. Burnside's record for Teas and Noisettes only, for besides the challenge cup and the Townsend Boscawen Memorial cup, he won twenty-seven first prizes, nine seconds, two thirds, with four silver medals, and the £5 cup at Wirral." Such remarkable achievements deserve to be made widely known, as showing what can be done by earnest able men in the culture of the Rose. Mr. D'Ombraïn regrets the loss of two or three exhibitors, but expects others are "coming on." He does not say that one of these did a foolish thing, but he does say "Mr. Fowler must needs go and get married just at the time he ought to have been exhibiting," adding, however, a sympathetic word, "so I suppose he must be forgiven, and make a better score next year." This does not mean better than marrying, but in exhibiting, than he would have made last season if he had not, as they say in the north, "bean and gan and gat wed."

But we must pass on. The Rev. A. Foster Melliar discourses on stocks for Roses, and relates his experience on going a-briaring. He tells us how Dean Hole was reminded of the proper time for this by the man who supplied him with standard stocks "unexpectedly coming to church." However, Mr. Foster Melliar evidently belongs to the muscular order of rosarians, for he determined to go head first into the hedges and dig up his own; at least, he says he bent an old felt hat over his ears, because, to quote his own words, "You must get your head into the very thick of it," which is quite true; and no doubt equally true that after working, we may be sure with great energy for a time, his dress was so tattered and torn as to be "more fitted for a scarecrow than for a parson." Though he had "never seen a professional stock collector at work," he seems to have proceeded in a very professional manner, for he says, "When going up hedges I laid the stocks out as I got them, and collected them as I came back; cut an Elm or Hazel shoot as a withe and made a faggot, which, utterly heedless of the sufferings of the poor coat, I carried home on my back rejoicing." In that way he collected 1800 stocks one winter, and it is just the way of professionals. But a professional would not have been surprised if he had gone into a shop for thick hedging mittens and found them "all left-handed," and if he had found one of them right-handed he would have known it was for a left-handed man—to hold the bushes back with and chop with the other and softer-gloved hand. This, it seems, was explained to the tattered rosarian; but perhaps he knew all about it, and we have a suspicion he did. However, be that as it may, he describes thoroughly sound practice on stocks and budding, and he would evidently be a wise man who could teach him much on the subject on which he writes so well.

"Tea Roses in North Yorkshire" is the theme of Mr. John Harkness, who is evidently an enthusiastic Tea man. He tells how until recently Tea Rose growing in the north was confined to glass structures, but experience has proved that all the best varieties adapt themselves to the cold Yorkshire climate with "no shelter to speak of save the 'grand auld hills' nearly twenty miles away." Drawing the soil round the plants appears to be usual method of protection. It will be interesting to learn how they have fared during the present season, but as a rule cutting the plants down to the ground is followed by stronger growth. Tea Roses have served Mr. Harkness well, and to them he mainly attributes his success in winning the Jubilee challenge trophy four consecutive years, the stands having contained one Tea to three Hybrid Perpetual blooms. Mr. Harkness also gives a hint on spring planting that ought not to be lost. He says, "All the Teas shown by us last year were cut from March-planted plants. They were awarded eleven first prizes, the premier Tea (Catherine Mermet) at the Crystal Palace, and the premier (Souvenir d'Elise) at Worksop. The plants were lifted before winter, laid in, and covered with mats, which is described as a sure and certain mode of preserving them. His short well written paper contains many good hints.

Mr. Alexander Hill Gray contributes a dozen pages of "Rose Jottings," the greater part light and anecdotal; indeed, the "Year Book" must come as a boon for relieving him of quaint sayings which he has treasured up. The rainy season last year did not suit his Teas, the blooms being so besmeared by drops of rain as to remind of the negro woman who disliked one of her children "kase dat brat showed dirt so easy;" and his Cloth of Gold on the Griffieriae stock looked as melancholy as the "auld wifie" must have been who, on being twitted on marrying a fourth time, exclaimed, "Was ever wumman sae troubled wi' sic a set o' deen' men?" But his paper is by no means all in that vein, and he pays an eloquent tribute to the memory of the late Henry Bennett. "What pæans of praise have been accorded to, among other of his triumphs, Mrs. John Laing, Princess of Wales, Her Majesty, Lady Mary Fitzwilliam, and Grace Darling we all know; and though as time rolls on these also, with our other Roses of to-day, may have to make way for 'immortals' yet unveiled—the name of Henry Bennett will ever deserve an honoured place in the niche of fame as the founder of pedigree Rose culture in Great Britain."

"The Moss Rose," writes Mr. T. W. Girdlestone, "is the living explication of the impotence of the florist," and goes on to prove the truth of the bold proposition. He says a collection of a hundred varieties of Moss Roses could be made at any moment, then asks and answers two or three questions. How many of them are found better than the

original Moss Rose? Not one! How many as good? Not one! How many worth growing at all? Not half a dozen! and goes on to state their imperfections. The best three Moss Roses he places in the following order—Old Moss, Blanche Moreau, and Little Gem; three others to follow them—Crested Moss, White Bath, and Celina. There his selection ends, and asks if it is a worthy record of Rose culture? He describes how these Roses should be grown for having the greatest abundance of their charming pointed buds and mossy sepals such as are sold in the streets of London in the early days of June.

An altogether different contribution, and a very excellent one, is that of Mr. Lindsell on "Preparing Roses for Exhibition." A very close observer and diligent worker is this gentleman. He tells us of "Teas that show a too near approach to mother earth," notably *Maréchal Niel*, *Niphotos*, *Comtesse de Nadaillac*, *Madame de Watteville*, *Madame Cusin*, *Ethel Brownlow*, and are therefore best budded on standard Briars. He passes through the routine of culture, the exact reverse of tediously, names from five to six o'clock on the evening before the show day as the best time for cutting as a rule, as "no other time gives such assistance in judging how the flowers will stand at the fateful eleven o'clock on the following morning." He also reminds that "Rose blooms chiefly make their growth between 7 and 9 A.M., and if the latter hour can be safely tided over, the chief time of peril for overblown Roses will be passed." After advising that Roses should be taken to shows at night, even if time tables show the journey may be deferred till the morning, and "making friends" with railway guards, Mr. Lindsell dwells a little on dressing blooms, believing it "legitimate to assist a bloom to expand and remove a defective petal, but not alter its character." Within those limits, he thinks "the exhibitor should not be debarred from obtaining any legitimate advantage which his skill in presenting the blooms may give him. Another exhibitor may excel in staging or arranging his flowers, and he does not see why any advantage arising from this should be readily conceded to him, when a similar benefit is denied to the clever manipulator"—rather a hard nut for the total prohibitionists of dressing to crack. "But the pleasure of Rose-growing is not," says this successful exhibitor, "limited to achieving victories. The memory recalls sweet June mornings, when the Rose foliage bathed in dew is in itself a glory of the garden. The distant clock strikes five as we wander round our plants attending to their needs. Then as the sun rises high, and the morning wears on, we leave our plants for such daily work as is allotted to us, but gladly return in cool eventime, and watch them settling down to rest. Truly a happy, peaceful pursuit, which gives pleasure to many beside the Rose grower, and in the enjoyment of which the short-lived excitement of exhibitions has but a trivial share." So closes this admirable little essay on the Rose.

Mr. George Paul contributes three or four pages on "Dijon Tea Roses," and after a short historical review, and an enumeration of varieties, embodies a practical suggestion in his last paragraph. "The Dijon Teas, be they *Gloire*, *Madame Bérard*, or *Bouquet d'Or*, make great bushes, or in threes or fives together, large clumps of colour just when they are wanted in early summer. A good barrowful of manure to each bush or clump ensures each year a finer and freer show of flowers, useful alike for decoration where it stands or to cut and forward to gladden the town dweller, the sick-room or hospital, or to fill the china bowl of the cottage, whose garden it adorns." Very good, Mr. Paul.

Mr. Edward Mawley tells all about the weather of the past Rose year, and its influence on plants, blooms, insects, and shows. The National Show at the Crystal Palace we are reminded was held on the coldest day (July 4th) of the singularly cold summer of 1890, and the Roses were as fresh at the end of the day as at the beginning; also we are informed that the 18th of July was in many parts of the country the wettest of the whole year; but at Birmingham, where the Society's Provincial Show was held, only a slight shower fell. This was the largest and finest N.E.S. "provincial" yet held, and notwithstanding the wet weather after midsummer, the Rose season was above the average. So let us say is the "Rosarian's Year Book," thus lightly skimmed over; and to make room for these jottings the publication of some other Rose notes in type must be postponed, and we trust the author of them will not be grievously disappointed in consequence.

MELONS AND THEIR CULTURE.

[Read by Mr. W. PALMER, Thames Ditton, at a recent meeting of the Eding and Chiswick Gardeners' Mutual Improvement Society.]

OF late years much has been written on Melons and their culture, yet rarely do two persons recommend or follow the same system of cultivation. I shall therefore in this paper only detail experience which I know to have been successful. The Melon came originally, I believe, from the West Indies as long ago as 1571, but was never grown with such success as now, great strides having been made in the improvement of the varieties in the last ten years or so, which might be fairly said to have done much to make it one of the most popular fruits of the present day. For the purpose of giving some little method to my paper I have divided it into four parts—viz, I., General remarks

as to cultivation; II., Select list of Melons; III., Judging Melons; IV., Diseases to which Melons are subjected and their prevention.

I., CULTIVATION.—The soil employed should be good stiff yellow loam. The nearer it approaches a clayey nature the better, as in that the Melon thrives best; but if this is not obtainable, and loam of a lighter texture has to be used, a little clay can be mixed with it, as stiff soil prevents the plants growing too freely and the wood becoming sappy. The compost should be formed as follows:—One cartload of loam, to which should be added one barrowload of Mushroom-bed refuse and one of leaf mould, made if possible from Oak or Beech leaves thoroughly decayed (this and the former should be put through an inch sieve), a 6-inch or 8-inch potful of the following:—Soot, bonedust, charcoal, and one of Clay's fertiliser, native guano, Thomson's Vine manure, or any such prepared manure, of which we have at the present day a good variety to choose from; also of quicklime, or if lime rubble be obtainable a double quantity of that in preference to lime. The loam must be chopped to about the size of a duck's egg, and mixed well with the above several weeks before putting it in the Melon house, in which it should be conveyed at least three days before planting, to have a good temperature in the soil.

The seeds for the earliest supply, if required for the end of April, should be sown in the beginning of January singly, or where seed is plentiful two seeds in a 60-sized pot. The pots must be well cleaned before use, well drained, and about three parts filled with loam, a little leaf mould being added. Place the seeds in a small bed of sand to prevent their decaying, this being often the case with early sown seeds. Plunge the pots in a slight hotbed, or an evaporating pan will answer the purpose well if the plants are plunged in leaf mould and placed on the pipes. As soon as the seed germinates remove the pots to a shelf near the glass to prevent the young plants being "drawn." After the second leaf appears top-dress with more loam and a little native guano added, as I find the latter encourages root action. A slight stake will be required in the pot ready to support the stem. As the roots reach the sides of the pot repot the plants into 5-inch size, making the compost a little richer, and at this stage they must be potted firmly, taking great care not to injure any of the young roots, giving water for a few days only in sufficient quantity to prevent flagging.

The next matter requiring attention will be placing the compost in the beds, which have already been prepared as before stated. Form the beds by placing a single brick wall about 2 feet from the outer wall, and 2 feet high, and have a good layer of brick ends placed in the bottom for drainage; if for very early Melons, a small hotbed on the top will be found beneficial. Make the compost as firm as possible with a potting stick, unless it be very wet, and it then should be made only moderately firm. This is necessary to cause the plants to produce short-jointed wood. I do not advocate the system sometimes adopted of growing them on mounds, adding soil at intervals through the growing season, as very often the plants are allowed to suffer by the roots, which push through the surface, perishing before the dressing is added.

When the plants are ready for putting out make a hole with a hand fork or trowel deep enough to allow the ball to be just below the surface, the surplus soil being placed round the stem, forming a little mound. Perform the operation if possible on a bright afternoon, syringing the plants well, and closing the house. Two or three plants to a light will be found sufficient, and they may be supported with a stake placed well in the soil and secured to the trellis, to which the plants are tied as they advance in growth. Pinch all laterals out until the wires are reached, then one can be allowed to grow as well as the leader; these will be found sufficient to carry the crop if three plants are grown to a light. Stop the other laterals one leaf beyond the fruits, and when the flowers are open they should be fertilised. This operation must be performed before syringing in the morning, or before the same is done in the afternoon, as the pollen is then drier than at any other time during the day.

After the early fruits have reached the size of a walnut select those intended for the crop. If small fruits only are required leave three, if large two. Carefully remove the other laterals by degrees. A little quicklime being rubbed on the place greatly assists it to heal, and often through this neglect the joint decays, and causes the whole stem to do the same. From this stage the plants may be assisted by liquid manure.

We now come to the most trying period to Melon growers, which is from the time the fruit is half grown to the ripening. Melons at this advanced stage need all the gardener's skill and attention to finish the

fruits, so as to retain a good flavour, so desirable when placed on the table; but how often, alas! do we hear of growers losing their plants when the fruits are about three parts developed, and generally through not giving sufficient attention to them. At this stage the plants require looking over at least once a day, as the cause of the loss, whatever it may be, is quick in action. I know no plant which perishes so quickly as the Melon, as they seem to be enjoying the best health one day and are gone the next, with no hope at all of their recovery, canker being one of the most dreaded foes, and only a quick and practical eye can detect it in time to prevent the loss.

In watering Melons discretion should always be used, as although the plants are lovers of water they should never be heavily watered on a cold dull day; better far to give them a little to keep them fresh (so to speak) until the first opportunity occurs to perform this with safety. "Never allow them to suffer by the want of water, and never give it them when they do not need it," is a good maxim to follow. Tepid water must at all times be used, at least 70° or 80°, cold water being death to the roots. Young beginners would do well to note this, and as with the watering, so with the syringing, let the weather be the guide. When cold and dull cease syringing, or only do so round the walls and on the floors of the houses three times a day, but as soon as a fine day comes, and the temperature in the house has risen, syringe every part of the foliage, giving ventilation at the same time, also slightly in the afternoon when closing the house. As the crop advances towards the ripening stage cease syringing the foliage and give less water to the roots. Some years ago I learnt the above lesson by overhearing one of our most successful Melon growers and exhibitors saying to a friend of his at one of the Reading shows, "How stupid gardeners are to dry their Melons off to put flavour into them. If they would try to keep the foliage on them instead, how much better they would find them." I have often felt thankful that I overheard those words; I was then only a youngster at Melon growing, but I have proved since how much help they contained towards cultural success.

(To be continued.)



EVENTS OF THE WEEK.—The Royal Society meet to-day (Thursday) at 4.30 P.M., and the Society of Arts on Wednesday, March 4th, at 8 P.M. On Tuesday, March 3rd, the Exhibition of Horticultural Sundries at the Crystal Palace will be opened, and will continue until Saturday, March 21st.

— THE WEATHER IN THE METROPOLITAN DISTRICT has been very dull during the past week; frost has been experienced to the extent of 10° below freezing point, but fogs have been dense and have scarcely lifted for several days. On the west coast, at Holyhead, and in Scotland comparatively high temperatures have been registered. The weather is still dry.

— THE WEATHER IN SOUTH PERTSHIRE for the past fortnight has been fine. Occasional slight frosts have occurred (7° on morning of the 20th), which are welcomed by the farmers on our heavy coarse land. Some of the days were foggy in the earlier part, with fine afternoons and evenings. Snowdrops, Crocuses, the Winter Aconite, Hepaticas are in bloom, and the mavis fills the air with song.—B. D.

— MESSRS. SUTTON & SONS, READING.—The *Mark Lane Express* of the 16th inst. devotes a large amount of its space to an illustrated description of the premises of the above firm, and especially to the farm seed room, which is also shown as transformed into a royal banqueting hall last December, and referred to at the time in our columns. An admirable portrait is given of Mr. Martin J. Sutton, and a pair of his famous Dexter Kerry cattle are admirably represented.

— THE EXHIBITION OF HORTICULTURAL SUNDRIES AT THE CRYSTAL PALACE, which is advertised to open on Tuesday, March 3rd, and continue to March 21st, appears likely to be very successful and interesting. We understand that nearly the whole of the available space has been engaged, and a large number of important firms will be represented. The exhibits will comprise a great variety of appliances machines, apparatus, structures, &c.

DEATH OF MR. E. R. CUTLER.—On the eve of going to press information reaches us of the sudden death of Mr. E. R. Cutler, whose fiftieth year of secretaryship to the Gardeners' Royal Benevolent Institution was recently acknowledged by a presentation to him on the occasion of the dinner and annual meeting on January 15th, as reported in the Journal of January 22nd. During the half century of his connection with the Institution Mr. Cutler laboured zealously on its behalf. His loss will be mourned by a very wide circle of friends.

— HIGHGATE AND DISTRICT CHRYSANTHEMUM SOCIETY.—We are informed that the next annual Exhibition of the above Society will take place on Thursday and Friday, November 5th and 6th. The radius of the Society has been extended to four miles from St. Michael's Church.

— DAFFODIL BLOOM A MONTH LATE IN IRELAND.—Instead of our bloom being gathered in the middle of January as in 1890, particularly Ard-Righ or Irish King, it is only now appearing in quantity. In a week there will be a grand display of this early market sort out of doors.—W. BAYLOR HARTLAND.

— GARDENING APPOINTMENTS.—Mr. Arthur Wilson, late foreman at Temple House Gardens, Great Marlow, has been appointed head gardener to H. Willan, Esq., J.P., Albion Lodge, Manley Castle, Worcestershire. Mr. F. B. Burbidge, general foreman of the Grove Gardens, Watford, succeeds the late Mr. Haycock at The Goldings, Hertford.

— CHISWICK HORTICULTURAL SOCIETY.—I have pleasure to send you by this post our report for last year, and the schedule of prizes for our summer Show, July 2nd, this year. We are offering two silver cups for competition, and the amount for prizes, including them, is £195 17s. 6d. We have introduced several new classes.—G. G. HARTLAND, *Hon. Secretary*.

— DESTROYING BULLFINCHES.—As a member of the Selborne Society for the preservation of wild creatures, when possible, I regret to see the attacks to which the Bullfinch has been subjected lately. It was once common hereabouts, but has been hunted down. I do not believe it is injurious to anything like the extent which has been represented by some.—C., *Kent*.

— APPLE PRINCE BISMARCK.—This Apple is not quite such a novelty as some of your correspondents appear to consider. In the nineteenth edition of "The Miniature Fruit Garden," published by Mr. Rivers in 1886, it is recommended as an Apple suitable for wall culture, As this gentleman does not advise the cultivation of fruits without a personal knowledge of their merits or defects, the Apple must have been well known to him before the publication of this edition.—A. F.

— AN Essex correspondent writes as follows respecting the WEATHER AND HEDERA MADERIENSIS VARIEGATA :—"We have had five days fog. It is the most dense I have ever seen here, and is bad for our Strawberries and Peaches, which are now in flower. Have any readers of the Journal noticed how the frost has affected the above variety of Ivy? We have several plants on the house which look as if they are killed. It will be a pity if it does not prove hardy enough for our winters, as it is a beautiful variety."

— An interesting history of the "COMPANY OF GARDENERS" OF LONDON has been sent to us, and contains a brief review of the origin of one of the City Companies, which ranks seventieth amongst the City Guilds, but which appears now to be almost forgotten. "After existing for centuries as a mystery or fellowship, the gardeners were at length incorporated into a company by a charter in 1605." Concerning the work of the Company in recent times we have no information, but it is said there is a prospect of its being revived.

— THE schedule of the CRYSTAL PALACE HORTICULTURAL EXHIBITIONS FOR 1891 is now issued, and gives particulars respecting the following Shows :—Spring plants and flowers, Saturday, March 21st. Summer Show of plants and flowers, Saturday, May 9th. National Rose Society's Show, Saturday, July 4th (schedule not included). National Co-operative Show, August 15th. Fruit and Dahlia Show, Friday, Saturday, September 4th and 5th. Autumn Fruit Show, October 8th to 10th; and Chrysanthemum Show, November 6th and 7th. In connection with the Fruit Show on September 4th, the British Fruit Growers' Association will hold a Conference, the programme of which will be subsequently issued.

— **BLANCHED LAUREL SHOOTS.**—In reply to your query in the Journal of February 12th in reference to "Dorsetshire Correspondent" relating to blanched Laurel shoots, I beg to inform "Dorsetshire Correspondent" that it is no uncommon sight here to see perfectly white shoots on the common Laurel. About six years ago I propagated a few of these blanched shoots, and which are now good sized plants but they have lost the beautiful whiteness of the thin cuttings, and are now merely mottled and green, and will, I am sure, eventually revert to the original type. I enclose three small shoots from one of these plants, showing as the plant increases in age so the colour diminishes.—**SOMERSETSHIRE CORRESPONDENT.** [The leaves sent are partially variegated, but not wholly white, as were those previously received.]

— **DEATH OF MR. THOMAS GILBERT.**—The Vice-Chairman of the Hastings Board of Guardians, Mr. Thomas Gilbert, died at his residence, Springfield Nursery, Old London Road, on Sunday, Feb. 15th, after several weeks' illness. The deceased, who was greatly respected by all classes, came to Hastings over thirty years ago from near Maidstone, where he was gardener. For many years he was head gardener to the late Mr. McMurdo, at Castledown, and whilst holding this position Mr. Gilbert came to the front as one of the leading exhibitors and prizetakers at the flower shows in this part of the county. On leaving Castledown Mr. Gilbert succeeded the late Mr. H. Barham as the proprietor of Springfield Nursery, which business he successfully carried on till the time of his death. Since April, 1874, Mr. Gilbert has represented All Saints' Parish as Poor Law Guardian, and in this capacity he won the esteem of all his colleagues.

— **WOOLTON GARDENERS' MUTUAL IMPROVEMENT SOCIETY.**—A meeting of the members of the above useful Society was held at the Mechanics' Institute last Thursday. Mr. Craven, Allerton Priory, occupied the chair. A new departure from previous meetings took place, the evening being set apart for impromptu speaking on subjects connected with horticulture. Various subjects were on papers, which were folded up. They were then placed in a hat and handed round, when each member had to take one, read the title, and give his opinion on it. The intention of this arrangement was to induce a greater number of members to speak. This object was attained, nearly every member assisting in the evening's business. At the conclusion the members reported the arrangements as highly satisfactory, and expressed a wish that in future sessions an evening might be set apart for a similar arrangement.

— **THE WEATHER.**—If "a' months of the year curse a fair February," we are in for another unseasonable year. We have had a number of fine days. The 18th was summer-like, clear, and mild, but since that it has been foggy and frosty, the temperature on the two following mornings being 25° and 22° respectively. The 15th was very fine, the day temperature was 52°, and the bees made their *debut* for the season, gathering pollen from Snowdrops, Crocus, and Hellebores, all three coming into bloom simultaneously, while the Aeonite seems to slumber for a little longer.—**LANARKSHIRE.**

— **A LARGE TREE.**—Like other correspondents, I observed the statement of a 22 feet saw cutting a 33 feet in diameter tree, and considered it a printer's error. But now "A. H." vindicates the accuracy of the statement. Supposing the saw made a cut in width to about 3-16ths of an inch, or even a quarter of an inch, where is there room for a "strong cord" or "wire rope" to pass through so as to allow the movement necessary for the saw to cut and clear itself of the sawdust? The less "set" a saw has the keener it cuts, and if too much it will not cut at all, and when wedges are applied they often do more harm than good. When the cut is a deep one a narrow saw should be used, and it requires no wedge applied to the serf. All that is necessary is to keep the wood from closing where the saw entered. This is my experience, and I fail to see how a 22 feet saw with either ropes or wire at the ends can be made to cut a diameter of 33 feet; but I shall be glad to be enlightened.

— **THE EFFECT OF FROST UPON VEGETABLES.**—Vegetables have been, with the exception of Savoys, very much spoiled, if not actually destroyed. This refers to those in my own garden, for only a short distance, on the other side of the smoke as it were, vegetables of the same nature are uninjured, while the same thing to a greater degree exists in more exposed districts, clearly proving that the frost in pure atmosphere is less hurtful than where it is contaminated with smoke. At first thought one would be inclined to opine that, soot being bene-

ficial to most of the Brassica family when in a growing state, would not be so destructive as it seems to be during the winter. It is not, however, soot alone that is the cause of the mischief, but the compounds formed from it that play the havoc with our vegetables, fruit trees, and flowers; and it would not surprise me to hear that it is from these that Orchids suffer so greatly. A light awning over and around stoves and greenhouses during these fogs might save many of the plants. I would raise a light framework 2 or 3 feet above the roof and from the sides of the house and cover with tiffany or other material. I should have the blinds in 6-foot widths, and draw every alternate one first, then the other, so that they would overlap a few inches. Two sets of rollers would be necessary, the one in and the other out, from a top rail. By such an arrangement they could be worked by one man as window-blinds are, easily put up or taken down, and not prove expensive.—**W. T.**

— **M. MEISSONIER AND HIS GARDENER.**—The death of the famous French artist reminds me that the following amusing story may be worth repeating, and possibly it may be fresh to some gardeners. M. Meissonier possessed one of the most beautiful gardens and the most *recherché* collections of plants round Paris; he was, in fact, a thorough-going enthusiast in all horticultural lore. One of his gardeners possessed a special aptitude for naming all kinds of seeds. M. Meissonier had often endeavoured to trip him up, but without success. So one day, when having several gentlemen assembled at his hospitable luncheon table, he unfolded to them a plot of how he would at last humble his gardener by submitting for his inspection some dried herring-roe. Having sent for the man, his employer told him that a gentleman had sent him a packet of seed, of which he asked the name, habitat, how long it would require to germinate, &c. The gardener replied, "The plant from which the seed was gathered was indigenous to the shores of the North Sea, and would require about a fortnight for germination, when he would tell him the name thereof." M. Meissonier handed the packet over, and strictly enjoined the gardener not to fail to let him know when the young plants were fairly growing. This he did about a fortnight afterwards, and at a time when his master had several of his fellow conspirators again at his house. "Now we shall have a lark, Messieurs," he gleefully announced to them, and sallying forth, they followed the gardener to one of the stoves, where in a propagating frame about two dozen 3-inch pots were standing close together, each with a herring's head looking out of the centre. The hilarity of the great painter's guests was unbounded, but he himself was also equal to the occasion, for he drew a 100 franc note from his pocket and handed it to his gardener for the extremely clever manner in which he had gone through the ordeal.—**A. W., Lincoln.**

— **WINTER CUCUMBERS.**—The long spell of severe weather with which we have been visited has had an unfavourable effect on the production of the above, as in addition to the low temperature we had weeks of sunless weather. In many establishments a constant supply is requested, and indeed expected. In such cases it is not always an easy matter to meet the demand. However, providing the necessary heating power is at command, suitable varieties selected, and an intelligent routine of culture followed, failures may in most instances be avoided. I am somewhat inclined to think that failures are occasionally brought about by allowing the plants to produce their fruit too early, or at all events allowing too many to remain on them when in a young state. I have found by experience that the more prudent course to pursue is to encourage the growth of the plants during late autumn by allowing them to carry no more fruit than is absolutely necessary, and thus building up strong robust plants for the depth of winter; such plants, when the pinch comes, being much more likely to produce the required supply than others that have been crippled during their infancy by a system of overcropping, and their constitutions are then unable to withstand the vicissitudes of the wintry season. Even if the plants survive, the desired Cucumbers may be few and far between, and poor puny things to boot. Planting during the early days of October in small hillocks of rough fibry loam, to which is added a liberal supply of stick ashes and charcoal, and proceeding on the lines indicated, a supply of Cucumbers is almost a certainty. I am no advocate for raw manure for winter Cucumbers, preferring a liquid, such as soot water, if it is thought a stimulant is necessary. As to varieties. Having tried many, possibly the majority of sorts in commerce, I find Cardiff Castle the best. Telegraph was my sheet anchor for many years, and had no rival till the advent of Cardiff Castle some few years ago. I have grown them side by side for some years. This old-fashioned winter has, however, proved to my satisfaction that the latter is at least the most valuable Cucumber for winter.—**W. W. T.**

— CROYDON GARDENERS AND AMATEURS.—There was a pleasant gathering at Croydon on the 18th inst, the three gardening societies there—the Croydon Horticultural, the Croydon Chrysanthemum, and the Croydon Amateurs' and Mutual Improvement—combining for a dinner and social evening. The affair was presided over by the Mayor, Mr. Frederik Edridge, and there were also present Sir Thomas Edridge, J.P., the Hon. Sidney Herbert, M.P., the Rev. W. Wilks (Secretary of the R.H.S.), Messrs. Phillip Crowley, E. W. Grimwade, F. Cooper, P. A. Peacock, J. A. and J. H. Laing (who had decorated the room in a very beautiful manner), J. Cæcal, Wickham Jones, S. Baxter, and a great number of gardeners and amateurs. The speeches were above the average order. That of Mr. Wilks, in which he made an eloquent appeal for support to the R.H.S., was perhaps the best, and Mr. Herbert (member for the borough) also spoke admirably. His remarks on the trials and troubles of amateur gardeners, learned from experience, were highly entertaining, and something of a pathetic chord was touched by his description of a visit to an East End slum loaded with Roses, and of the manner in which the tenements poured forth eager throngs to share in the distribution of the flowers. Mr. Wilks briefly epitomised the history of the Royal Horticultural Society, referring to its valuable work in the days of its intrepid collectors Douglas and Fortune, touching upon its departure from its recognised horticultural standpoint—a departure that was strenuously opposed by Dr. Hogg—after the Prince Consort's death, and enlarging upon the efforts now being made to revivify it. It was a fine speech, and its reception must have been very gratifying to the popular Secretary. Mr. Baxter, the Secretary of the Amateur Society, was very warmly received on rising to respond on its behalf, his reception proving the enthusiasm of the Croydon amateurs, and their appreciation of his services. Messrs. Grimwade, Wickham Jones, G. W. Cummins, Roffey, T. W. Sanders, and others were among the speakers. The gathering was a great success.

— A NEW REMEDY FOR MILDEW AND BLACK SPOT.—In looking up the nature of the "sulphur and lime mixture" which has long been used as a remedy and preventive of mildew in greenhouse culture of plants, after consulting every source of information I could in the various encyclopedias within my reach, and finding only brief mention of it, I went to the druggist with my query, and he kindly loaned me the "United States Dispensatory." In it I found a formula for making the sulphur and lime mixture, very similar to that given in Henderson's "Practical Floriculture," and a description of its use in medicine. The remark that it contained hyposulphite of lime as the active element led me to look up other hyposulphites, and I found under "Hyposulphite of soda" the following:—"Hyposulphite of soda is a very powerful poison to fungi and other low organic forms." It then went on to speak of its use in medicine in the treatment of fungoid diseases. This seemed to be just the information I wanted. I purchased a quarter of a pound to try it. This was in October last, just when mildew and black spot was appearing on the Chrysanthemums and Carnations. I have used the sulphur and lime mixture successfully for many years against mildew. The objection to it is it is not readily obtained. Druggists do not keep it, and it is troublesome to prepare with the appliances usually at the command of the florist. I had a small quantity of it. I began using this on half the greenhouse and the hyposulphite on the other half, dissolving half an ounce to a gallon of water, and applying with a spraying pump. Both remedies seemed equally efficient. I applied once a week until colder weather required constant firing and the "mildew season" was over. I do not remember seeing this salt recommended for mildew anywhere. It is worth trying for all the various forms of fungus which destroy plant growth of every sort. It has these advantages: First, it is easily obtainable, every druggist keeps it; second, it is cheap, as it is used in large quantities in the arts; third, it is not poisonous; fourth, it makes a clear solution, and leaves little or no stain when it dries off. As I grow Carnations chiefly I have no opportunity to test its value on other plants. I hope that others may try it on Roses and Violets, on Grape Vines, Plum trees, Potatoes, Gooseberries, and all plants infested with fungoid diseases.—SEWALL FISHER, Framingham, Mass. (in *American Florist*).

— ROYAL METEOROLOGICAL SOCIETY.—The usual monthly meeting of this Society was held on Wednesday the 18th inst., at the Institution of Civil Engineers, 25, Great George Street, Westminster, Dr. C. T. Williams, M.A., Vice-President, in the chair. Mr. C. L. Brook, Mr. C. E. De Rance, F.G.S., Assoc.Inst.C.E., Mr. J. Eden, Assoc.M.Inst.C.E., Mr. J. C. Mundell, and Mr. J. Sidebottom, J.P., were elected Fellows of the Society. The following

papers were read:—1, "The Great Frost of 1890-91;" by Mr. C. Harding, F.R.Met.Soc. This paper dealt with the whole period of the frost from November 25th to January 22nd, and it was shown that over nearly the whole of the south-east of England the mean temperature for the fifty-nine days was more than 2° below the freezing point, whilst at seaside stations on the coast of Kent, Sussex, and Hampshire the mean was only 32°. In the extreme north of Scotland, as well as in the west of Ireland, the mean was 10° warmer than in the south-east of England. In the southern Midlands, and in parts of the south of England, the mean temperature for the fifty-nine days was more than 10° below the average, but in the north of England the deficiency did not amount to 5°, and in the extreme north of Scotland it was less than 1°. The lowest authentic reading in the screen was 0.6° at Stokesay in Shropshire, but almost equally low temperatures occurred at other periods of the frost. At many places in the south and south-west of England, as well as in parts of Scotland and Ireland, the greatest cold throughout the period occurred at the end of November, and at Waddon, in Surrey, the thermometer in the screen fell to 1°, a reading quite unprecedented at the close of the autumn. At Addington Hills, near Croydon, the shade thermometer was below the freezing point each night with one exception, and there were only two exceptions at Cambridge and Reading, whilst in the Shetlands there were only nine nights with frost, although at Biarritz frost occurred on thirty-one nights, and at Rome on six nights. At many places in England the frost was continuous night and day for twenty-five days, but at coast stations in the north of Scotland it in no case lasted throughout the twenty-four hours. On the coast of Sussex the temperature of the sea was about 14° warmer than the air throughout December, but on the Yorkshire coast it was only 6° warmer, and in the Shetlands and on parts of the Irish coast it was only 3° warmer. The Thames water off Deptford, at 2 feet below the surface, was continuously below 34° from December 23rd to January 23rd, a period of thirty-two days, whilst the river was blocked with ice during the greater part of this time. In Regent's Park, where skating continued uninterruptedly for forty-three days, the ice attained the thickness of over 9 inches. The frost did not penetrate to the depth of 2 feet below the surface of the ground in any part of England; but in many places, especially in the south and east, the ground was frozen for several days at the depth of 1 foot, and at 6 inches it was frozen for upwards of a month. In the neighbourhood of London the cold was more prolonged than in any previous frost during the last 100 years, the next longest spell being fifty-two days in the winter of 1794-5, whilst in 1838 frost lasted for fifty days, and in 1788-9 for forty-nine days. 2, "The Problem of Probable Error as applied to Meteorology;" by Mr. T. W. Backhouse.

A JOURNEY TO BURMA.

[A paper by Mr. A. WINKLER WILLS, read at a meeting of the Birmingham Gardeners' Association.]

(Concluded from page 130.)

I MUST, if I have not exhausted your patience, now tell you of a delightful excursion which we made, accompanied by my daughter and her husband, to Mandalay, the ancient capital of Burma and of King Theebaw, now the seat of Government of our newly acquired province of Upper Burma, to which city the railway is now extended, and takes the traveller in twelve hours from Toungoo. The distance is 200 miles only, but then trains, like other things, move deliberately in these parts, and stop for all meals at certain stations, not only long enough for the traveller to eat his food, but to enjoy his cigar afterwards, and have ample time to take stock of the strange cosmopolitan crowd with which he finds himself surrounded; pure Burmese in their neat and delicately tinted dress; native labourers from India, with no dress at all save a waistcloth; well-to-do Indian traders in their robes; the universally present Chinaman, with his pack of wares; Shans in baggy blue trousers, loose jackets, and huge flapping straw hats from the mountains; Karens, and perchance here and there a Paleung or Padoung from more distant country, to whom the train is as yet an unaccustomed spectacle, although, like all Orientals, they betray no expression of surprise.

For fifty miles north of Toungoo you run through dense forests, where the trees are thick with Dendrobes, and here and there high up Vanda teres climbs over their topmost branches like Ivy, and expands its glorious blooms in the blazing sun, although for four or five months it has not tasted a spot of rain, nor will it do so for three months more. Large tufts of a Platycerium, closely resembling *P. grande*, cling to the tree trunks, their fronds

parched and brown as sheets of paper, yet marvellously retaining a vitality which will enable them to throw out their sudden foliage as soon as they are bathed in the floods which descend when the rains set in in May. By the side of the line huge grasses rise 12 or 15 feet high, great clumps of Bamboo occupy occasional open spaces, Convolvulus and wild Gourds ramp and scramble among the bushes, and a lovely plant with small three-petalled pink flowers climbs to the top of trees 70 or 80 feet high, and sheets them over with tresses and cascades of lovely colour.

Here and there a native village occupies a clearing in the woods, and now and again a larger town with pagodas and monasteries comes suddenly into view, while on occasional points of vantage are situated barracks or stockades occupied by small bodies of troops or of native police.

Then the scene changes entirely, and for fifty or sixty miles on end the eye rests on nothing but huge stretches of Cactus bushes from 5 or 6 up to 20 feet high; Cactuses close up to the

grasses, and makes a dart at the face of the passer-by, is scarcely less certainly fatal. These and other species are numerous, but fortunately they are timid creatures, and fly from man; moreover, they are easily killed by a cut with a light and pliable stick. Not so the dreaded hamadryad, a huge serpent, which attains a length of 12 or 13 feet and the thickness of a man's thigh. When suddenly confronted or disturbed this beast pursues and attacks, and it needs a swift horse to carry its rider out of danger. Col. Plant of Moulmein assured me that he had been chased by a hamadryad for a full mile, and only escaped by reason of his horse being one of the fleetest in the station. Fortunately this snake is as rare as he is formidable, but it was scarcely comforting to hear that not long ago one was seen in the elephant lines, only a mile from our place of dwelling at Toungsoo. The number of persons killed annually by snake bites in India is, according to Dr. Fayrer (the great authority on the subject), 20,000; but it is the barefooted and careless natives, who often, moreover, actually

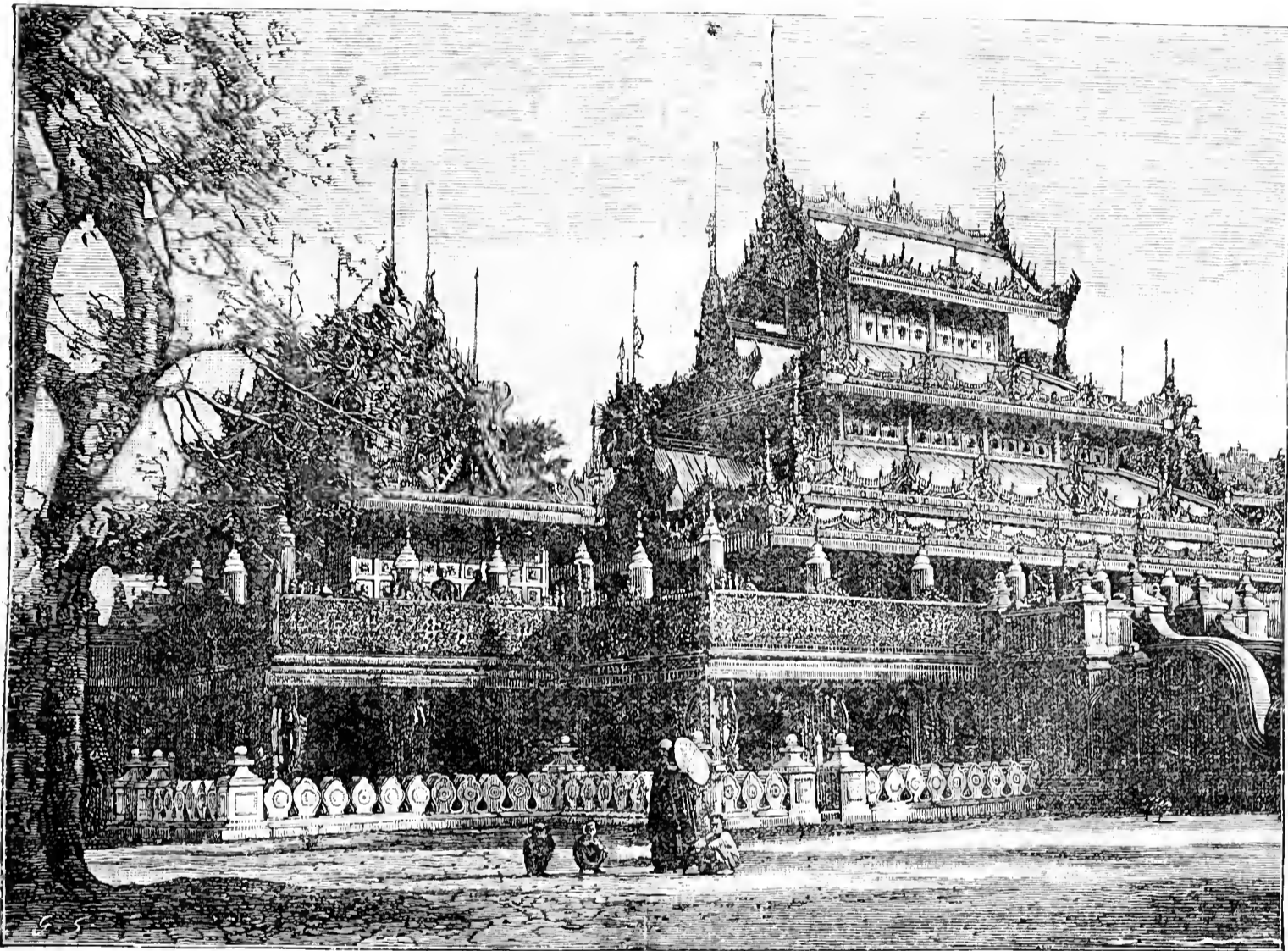

FIG. 31.—BURMESE KYOUNG.

line, Cactuses for miles and miles over the level plain on either side, save where here and there a Tamarind tree or other member of that great tribe of leguminous plants, which form so large a proportion of Indian and Burmese vegetation, rises solitary from the midst of the desolation. The prospect is indescribably wild, and is only relieved by the distant hills still 4000 or 5000 feet high, whose flanks and spurs are densely timbered, and crimson in places with the bloom or foliage of some great forest tree. In the almost impenetrable recesses of this jungle many a tiger roams, and many a deadly snake lies hidden. It was our ill fortune not to see a single one while we were in Burma except the cobras and pythons of the conjurers, for it was winter and the dry season, and at this time they betake themselves to the cracks and crannies of old ruins, or coil themselves up beneath fallen timber or in holes in the ground. During the rains they are constantly seen, and even in the dry season one soon acquires the habit of avoiding long grass or low bushes, or at any rate of beating them with a stick as one goes along, and of summoning a servant with a lantern to precede one after dark.

The deadly cobra abounds in Burma, and the green whipsnake of the jungle, which coils itself round the stems of reeds or tall

protect the cobra in their mud huts from superstitious motives, who swell this terrible deathroll. The European who dons his boots and leggings before entering the grass or scrub of the jungle, whose rooms are swept carefully every few hours, and who certainly has no conscientious scruple about killing a cobra, a ticpalonga, or a viper, very rarely falls a victim.

Finally you enter a third zone of vegetation. Forest trees reappear; Mangoes, Tamarinds, Peepul trees and occasionally huge Banyans. Villages become frequent, often stockaded, but with their defences falling to pieces, since the establishment of law and order under English rule has made them no longer necessary; then great stretches of Paddy with ample canals for irrigation; plantations of Bananas, Sugarcanes and Betel Pepper, groves of Cocoa and Fan Palms. Betel Pepper (*Piper Betel*) is extensively cultivated for its aromatic leaves, which are chewed, mixed with lime and the nuts of the Areca Palm (*A. catechu*), an unpleasant habit unhappily prevalent among the Burmese, whereby their naturally ivory-white teeth are blackened. By the side of the line and among the trees, as night comes on fires blaze and flicker, and you see that the peasants are busy treading out their grain under the feet of patient white skinned bullocks in the same primitive

fashion as prevailed when the Pharaohs ruled over Egypt or the Assyrian kings over Nineveh, thousands of years ago. At last the train rolled into the fine station of Mandalay, and in five minutes we were settled in the Dak Bungalow or Government rest house, and our servants unpacking our ample supplies of eatables and drinkables. The old city was enclosed within thick battlemented walls of brick and rubble 20 feet high, and occupied a space $1\frac{1}{4}$ mile square; these are surrounded by a large moat some 60 yards wide, which is covered with sheets of purple Lotus flowers, the Sacred Lily of the East. The centre of this space was and is marked by the king's palace and a vast collection of minor buildings occupied by his queens, ministers, and officers of high and low degree, and round these lie extensive grounds, gardens, and artificial lakes, the whole being formerly surrounded by an inner wall and a great palisade of baulks of teak. The entire city was indescribably filthy, and the only scavengers were herds of black pigs, who performed their sanitary offices even within the precincts of the palace. The people were extremely poor, while the king and ministers rolled in ill-gotten riches, nor was there any inducement for the humbler classes to improve their condition, for the slightest sign of prosperity was but the signal for fresh exaction; even for worse than exaction, for sudden and violent deaths were common, and many a corpse found its last resting place among the Lotus stems of the great moat, or was cast out headless among the bushes outside. The first thing the English did after the easy capture of Mandalay in 1886 was to evict the entire population, and bid them take up their quarters outside the walls. This sounds a harsh proceeding, but it was a necessity alike for sanitary and military reasons. Moreover, as a Burman builds a house in three days, and as everyone received fair money compensation, and there were no vested rights of publicans or others to be considered, no hardship whatever was inflicted. Now broad roads intersect the great square space, and the barracks of our troops and the bungalows of the officials and other European dwellers in Mandalay alone occupy it, save that the old palaces remain intact. The queen's palace is converted into the English club, and many of the other buildings are occupied as offices of the military and civil powers. But a large part of the minor quarters of the old *régime* have been swept away, being found to be in a condition of general ramshackle, which involved either extensive repairs (which were out of the question) or removal before they tumbled to pieces of themselves.

Vast rambling buildings are these old king's palaces; audience and throne rooms, banqueting halls, and chambers for queens, concubines, ministers, and officers, all built of teak, with endless carving and decoration, consisting of geometric patterns worked mainly in pieces of silvered glass, intermingled with profuse gilding and acres of vermilion, the whole rude in execution but producing an effect of barbaric richness and splendour. Over the end of the huge pile rises a gilded Chinese pagoda-like tower of seven lofty storeys, each narrower than the one below it, and of great height, glittering against the blue sky. We stood on the raised dais on to which Theebaw was wont to step through a gorgeously decorated doorway from his private audience room to give his commands to the crowd of grovelling courtiers who thronged the outer court below, and touched the ground with their foreheads as token of servile obedience when he appeared, and on a door close by we saw the marks of a bloody hand, which told where one of his queens had executed summary vengeance on a maid in waiting whom she suspected of casting too affectionate a glance on her own amiable spouse. We wandered among the Palm groves of the gardens, and gathered Ferns and Selaginellas in the summer-house in which Theebaw gave himself up to his captors. These and many other interesting things we saw in and about the imperial palaces, but I must hasten to a close, and only tell you in conclusion of what, for want of a better term, I must call the ecclesiastical architecture of the place. In Theebaw's time he himself maintained 1000 brethren or monks, and when a new monastery was required or an old one needed repair or decoration an extra turn of the imperial screw or the decapitation of a minister and seizure of his wealth, generally as ill gotten as that of his master, furnished the needful funds to this pious Defender of the Faith.

Time fails me, and power is denied me to describe in detail the marvellous religious buildings which rose by scores in these palmy days of state-protected Buddhism. Of these three, the King's, the Queen's, and the Golden Kyoung (fig. 31) stand pre-eminent for beauty. Supported on a vast framework of teak timbers—whole trunks of forest trees—they rise in tiers of woodwork adorned by the most skilful carving, and are surmounted by spires or towers similar to the one which forms the crowning adornment of the king's palace, and from floor to topmost pinnacle every foot is gilded, so that they rise in fairy delicacy of intricate fretwork tier upon tier, and storey upon storey, and shine in the tropic sun

against the cloudless sky, until the eye almost aches with excess of light and beauty. Within are temples, images of Buddha, dormitories for the priests, libraries of sacred literature. Yellow robed abbots, brethren, and acolytes pace round the corridors which always run round the first stage of these monasteries, or sit in the shade printing in quaint characters on prepared Palm leaves fresh additions to their libraries, and everywhere these good people received us with dignified and studied courtesy, which we endeavoured to reciprocate.

Then there is the great and sacred structure known as 451 Pagodas, where a central pagoda is surrounded by 450 miniature ones, each with a chamber in its base where stands a stone something like a tombstone, but broader at top than bottom, on which is carved a passage from the Buddhist scriptures—a pious work executed some centuries ago by a Burmese king, who declared that he would make these writings imperishable for all time. Finally there is the wonderful Aracan Pagoda, its entrance guarded by huge lion figures 40 feet high, strange and barbaric, but indescribable within my limits, with its great bronze Buddha, its thousands of strange votive offerings, its approach through galleries and chambers horrible with pictures of an Inferno more ghastly than that which Dante painted in words, and above all its wonderful assemblage of pilgrims and devotees of wild aspect and strange physiognomy—men and women from the plains and hills of the northern extremity of Upper Burma, their habits and ornaments as quaint and barbaric as themselves, for what in sacred associations the Great Schway Dagon of Rangoon is to the people of Lower Burma and Ceylon, the same is the Aracan Pagoda of Mandalay to the tribes of Upper Burma and the great tracts of country between it and the border of China.

I must not dwell on our return to Rangoon or describe the wonders of tropical vegetation which we saw on the way home at the foot of the vast peaks of the Himalayas; the Tree Ferns 70 feet high and the Gold Ferns which we gathered from our seats on the Darjeeling railway; the sights of Calcutta or the broad waters of the Hoogly and the Ganges; the festivals we witnessed in the sacred city of Benares, its temples and its crowds of devotees, its holy fakirs, some with withered arms, others with amputated fingers, and others again with nails grown through from the palm to the back of the hand; the engrossing interest of the Residency at Lucknow and the fatal well at Cawnpore; the palaces of Jeypore; and the thousand wonders of our journey home across India. Were I to do so, long before I had finished my recital, you would reverse the words of my Burmese friends, and say, "You can go, but don't come again."

I trust I have said enough to show you how interesting a country farther India is and how charming are its people. I would add that its future is one of assured and increasing prosperity. In four years the revenue of our new province alone has increased fourfold; in many parts three crops of Rice are grown in the year, and everywhere a clearance in the jungle is enough to convert the fertile soil into a garden of abundance. It is bounded on the east by a great country accessible to railways, whose people are born traders desirous of intercourse with Europeans, and through which a single line would suffice to tap the commercial wealth of the southern states of the great Chinese empire.

Outrage and dacoity—that form of crime of which we hear so much more here than is known there—vanish before the just and firm government of our commissioners. Stockades are falling to decay, being no longer a needful protection to the villages. The people who two years ago dared not be even suspected of possessing more than the bare necessities of life, and who were forbidden by sumptuary laws from building anything better than a hovel, are already surrounding themselves with evidences of prosperity, exercising their crafts of growing, dyeing, and weaving silk; embroidering cloth; cultivating Rice, Maize, and Sugarcane in their fields, Oranges in their gardens; dwelling in comfortable houses, of which formerly they dared scarcely to dream; following their various occupations in peace and security; travelling by thousands up and down the country in pursuit of their several callings; clearing, planting, trading, and prospering.

Already this far-off country is the richest, yes by far the richest of our Oriental possessions. It is already, and it is destined to remain, so long as English hearts are true and English heads are strong, the brightest jewel in the Crown of our beloved Queen Empress of India.

STACHYS TUBERIFERA (CROSNE DU JAPON. OF THE FRENCH).

DURING the last year or two much has been said and contradictory opinions have been expressed concerning this new Japanese vegetable. We were inclined to judge for ourselves, and last spring we planted a line of tubers in one of our gardens. The plants

developed themselves rapidly, and became during the summer good bushes 2 feet high, full of leaves, but no flowers. We let them at rest till now, and without any protection. After this long and severe winter we could judge of the hardiness of this vegetable, and were surprised to see that, after having been frozen hard like stones during several weeks, the tubers had not suffered in the least, and are healthy and fresh like early Potatoes in June. We tried one of the tubers raw, and found it palatable, having a soft flesh and an agreeable flavour, something like a Hazel nut.

In preparing a dish of them for the table we admired their extreme tenderness, and the total absence of peel or fibrous matter; they melt in the mouth like Cauliflowers or Broccoli. As to flavour, we should range it between that of Cauliflowers and Salsafy or Scorzonera, and at this season when scarcely any fresh vegetables are left, it gave us a great deal of pleasure.

The following is the way in which they were prepared:—We let them boil in water, set them to drain, and then stew them in a pan with butter, pepper, salt, a yolk of an egg, and some lemon juice. Coupled with cutlets, or with cold meat, they make an excellent dish. My cook, who could not be induced to articulate the difficult names of *Stachys tuberifera* or *Crosnes du Japon*, at once termed them Catstails.—CHARLES VAN GEERT, *Antwerp*.

SPRING PLANTING.

WHEN I read Mr. J. Wright's leading article in the *Journal* of the 12th inst. on the above subject I felt somewhat consoled, as I have recently been replanting some rather large Pear trees which I intended to remove in the autumn. At the commencement of the planting season I had a number of fruit trees and Roses from nurserymen, and by the time their planting was completed severe frost set in. When the ground became workable again I set about the Pear trees and carried out my previous intention. I do not know what the age of the trees may be, but some of them appear at the least twenty years old, and I am inclined to think their roots have never been seen since they were planted until now, for they had gone right away from the trees for several feet without showing any sign of having been pruned. The heads of the trees are vigorous, but have not borne any fruit for some years. I carefully lifted the roots and notched the largest of them with a sharp knife, hoping they may callus and make some small roots therefrom. The trees were then replanted in a mixture of stiff loam and decayed manure. I am not an advocate for spring planting, especially such large trees as these, but have hopes that the trees will succeed. My views are entirely in unison with Mr. Wright's respecting shortening the branches, and the heads of these Pear trees have been reduced correspondingly with the roots. I am an advocate of early autumn planting, and will give a reason for my preference. Some Rose trees which I planted at the end of October had to be taken up again a week or more ago in consequence of a little alteration. When I took them up I found many of them had already made numerous white roots half an inch long. There are some fruit trees which I believe will respond as well to spring planting as autumn planting, Peach trees to wit. I have a dozen of these to replant, and the work cannot be done until the first or second week in March, in consequence of a horticultural builder not finishing the erection of a Peach house for which he has had the order for three months, but I shall not feel at all uneasy if I can have the trees planted by the time mentioned.—R. M.

ERYTHRONIUM GRANDIFLORIUM.

THE common "Dog's-tooth Violet," *Erythronium Dens-canis*, is a favourite with all lovers of hardy plants, and the "large-flowered" species has nearly an equal popularity, but deserves to be still more widely known. At Mr. T. S. Ware's nursery, Tottenham, we have frequently noticed this *Erythronium* in early spring, and the beautiful effect, especially in contrast with several other beds of the older species in variety, was sufficient to recommend the plant most strongly. It is well known that most members of this genus produce their flowers singly, but in *E. grandiflorum* we have a spike or raceme bearing three, four, or more creamy white flowers of good size. There has been some confusion between this and *E. giganteum*, but they are quite distinct and easily recognised. On April 26th, 1881, Mr. G. F. Wilson exhibited flowers of both species at South Kensington, and was awarded a certificate for *E. giganteum*. In a note appended to them he observed that they were quite distinct, the latter named "having only one flower to the stem, the flower being also of different shape, colour, and marking." It is, indeed, much larger, pure white, with a ring of red in the centre. A coloured figure of the plant, described by Pursh as *E. grandiflorum* was given in the "*Botanical Register*" in 1836, but the flowers are smaller, bright yellow with red anthers—very different from Mr. Ware's plant. Under the same plate reference is made to another also, found by Mr. Douglas, and described as having "an irregularly branched scape." This is named *E. giganteum*, whereas the one now grown

under that name has only "one flower on a stem," as Mr. Wilson has stated.

E. grandiflorum is a thoroughly useful plant, free, and easily grown in any moist shady border if the soil is not too heavy. A variety named *albiflorum*, rather dwarfer and later in flowering, also grown in Mr.



FIG. 32.—ERYTHRONIUM GRANDIFLORIUM.

Ware's collection, is a pretty companion for the above. The woodcut (fig. 32) shows a spike and leaf of nearly their natural size, and conveys the information required by "A Journal Reader."

THE ROYAL HORTICULTURAL SOCIETY.

INTERPRETATION OF BY-LAWS.

MAY I trouble you to insert the following statement in your next issue.

In October last Mr. Morris, a member of Council and Treasurer of the Society, announced to us his incapacity to continue in office owing to his projected absence from England until March, 1891. The Council at once had recourse to the by-laws of the Society regulating the election of Council, and have conformed strictly thereto.

By-law 68 reads thus:—"If any member of the Council dies or becomes incapacitated from any cause whatever in the interval

between any two annual meetings, the other members of the Council may fill up the vacancy so created by the appointment of some other discreet Fellow; and any Fellow so appointed shall for all purposes be deemed to occupy the position of the person to whose seat in the Council he has been appointed."

By-law 69 adds, "For the purpose of the last by-law a member of the Council may be deemed incapacitated who is absent from England for more than three calendar months, or declares that he is incapable from illness, urging duties or otherwise, from efficiently performing his duties as member of the Council."

Acting in conformity with these the Council appointed Mr. Philip Crowley to the vacancy on the Council created by the "incapacity" of Mr. Morris.

By-law 76 enacts that—"The President, the Treasurer, and the Secretary shall vacate their offices on the second Tuesday in the month of February in every year, but shall be re-eligible, as hereinafter mentioned. In the event of any vacancy occurring in any of these offices by the death, resignation, or incapacity of any of the officers, such vacancy may be filled up by the Council."

Acting upon this the Council further appointed Mr. Crowley to be Treasurer in the room of Mr. Morris (incapacitated), and in accordance with the former half of it Mr. Crowley duly resigned his office of Treasurer on the second Tuesday in February last, and was re-elected thereto by the unanimous vote of the general meeting of Fellows.

From these by-laws it did not occur to the Council that it was necessary to submit Mr. Crowley's appointment to the Council to the annual meeting for ratification (though they would gladly have done so had anyone so much as suggested the desirability thereof). Mr. Crowley "being deemed to occupy the position" Mr. Morris held on the Council nothing further seemed needful; indeed, by-law 70 seems to infer that such submission of Mr. Crowley's name for election would have been out of order, for it directs that, "If at the time of any annual meeting a vacancy in the Council, created by the death or incapacity of any member *has not been filled up by the Council*, such vacancy shall be filled up at that meeting in the same manner as if the member vacating were one of the three who had been removed by ballot at the meeting; and in such case the number of members of the Council to be balloted out at the meeting shall be proportionately reduced." There is no sense or meaning in directing what is to be done if the Council have not filled the vacancy if, as you urge, the same is to be done if they have filled it!

As to the by-laws being in accord with the Charter I do not venture any opinion; it is a matter for lawyers, who drew up both the Charter and the by-laws, and certified the latter to be in harmony with the former. I will only point out that the particular by-laws in question are of very old date indeed, and that the Supplementary Charter enacts, "And further that the existing by-laws of the said Society shall continue in force in their integrity, and shall be binding upon 'the Society' and the members thereof, except and in so far as they shall be repealed or altered by any by-law to be made by 'the Society.'" This, I believe, fully covers the by-laws in question.

But even if we go behind this, it does not appear to me that Mr. Crowley's appointment to the Council needed to be submitted to the general meeting. The Supplementary Charter says:—"In case of the incapacity from any cause whatever of any member of the Council, or of the President, Treasurer, or Secretary, between any two annual meetings, the Council shall nominate or appoint some other discreet person, being a Fellow of 'the Society,' to supply the place of the member of Council, and of the President, Treasurer, and Secretary respectively, until the annual meeting next following: and such member of Council, President, Treasurer, and Secretary, so nominated or appointed *shall until and on* such next annual meeting be deemed to stand for all purposes in the place of the person or officer in or to whose place he shall have been so nominated or appointed, or should have succeeded."

It is true that in the above the words "until the annual meeting" appear to limit the appointment, but inasmuch as at the annual meeting any member of Council may be displaced by a vote (duly given notice of) of the meeting, the Council could not absolutely appoint Mr. Crowley beyond the annual meeting, but only "until" it, but at the same time if not removed by vote of the meeting he, in common with all other members of Council not removed, continues in office. This appears to be further emphasised by the words "*and on*;" the only meaning of which addition can be that the member appointed by the Council to fill the vacancy not only does so "until" but "on" the annual meeting. If, therefore, Mr. Crowley was a member of Council not only "until" but "on" the annual meeting, he did not require to be "elected on to the Council" of which he was already a member.

That this is the legal and correct interpretation appears to be proved by the following paragraph of the Charter, which would be absolutely senseless if the same procedure was to be followed in the precisely opposite case to that which it contemplates:—"And further, as regards any member of Council becoming incapable in the interval between any two annual meetings, and whose place shall not be supplied by the Council as aforesaid, the place of such member of Council shall at the next annual meeting be supplied from the Fellows of 'the Society,' by ballot as aforesaid, and in such case the number of Fellows to be balloted out at such meeting shall be proportionately reduced, *it being our will and pleasure that the vacancy or vacancies by reason of death or incapacity, not supplied by the Council, and actually existing at the time of any annual meeting, shall be treated and supplied as and in lieu of a vacancy by ballot.*"

This tells us what is to be done if the Council shall *not* have filled the vacancy, and it therefore "actually exists," but if I understand your last week's issue aright, you tell us we are to do precisely, exactly, and identically the same when the Council *have filled* the vacancy, and which therefore does not "actually exist at the time of the meeting." Considering these points, I think the Council will prefer to abide by their lawyer's advice that the by-laws are correct than to adopt your most kindly tendered advice.—W. WILKS, *Sec. R.H.S.*

[We insert the above letter with pleasure. We have not questioned the accuracy of the by-laws, neither have we questioned Mr. Wilks' interpretation of those he has called into operation. But may we suggest that Mr. Wilks does not commence his citation soon enough and ends it too soon? By-law 66 has precedence over by-law 68, and governs it on a vital point, as it does another which is quoted; indeed it is the key to the whole position affecting resignations, and, consequently, re-elections, and embodies a cardinal principle in the constitution of the Society. By-law 66 runs thus: "Any member of the Council may resign his seat on the Council, but *such resignation shall not be deemed complete until it has been accepted by a resolution passed at the next ensuing annual meeting*, and the acceptance of any such resignation shall not be entertained by such general meeting unless the member proposing to resign has signed a paper in the form marked E in the Appendix, and has left it with the Secretary on or before the 1st of January preceding such annual meeting." We seldom use italics, but in this case follow the example of the Secretary of the R.H.S.]

It is to be observed that unless the stipulated form is complied with a resignation cannot even be entertained (considered); and if the resignation *has* been made in due form it cannot then be "completed" except by "resolution" passed by the Fellows of the Society at their annual meeting. We should like to know Mr. Wilks' interpretation of that by-law which he appears to have overlooked. We hold that it governs every other providing for the resignation of office bearers; and for a very substantial reason—namely, that the rights of the Fellows shall be safeguarded. They constitute the Society, and the appointment of officials is invested in them. We do not for a moment suppose that the present Council has the remotest desire to usurp the privileges of the Fellows, but precedents, even if established by accident, may be, as they have been, dangerous things.

We have now to turn to another by-law, which also appears to have been overlooked by the Council. Mr. Wilks cites by-law 76 as bearing on resignations by "incapacity," but in the case of Mr. Morris' resignation it is necessary that by-law 81 be complied with. This really provides for the resignation of that gentleman under the circumstances, and most assuredly, in our opinion, its provisions have not been complied with. It would be interesting to have Mr. Wilks' interpretation of that by-law, and of the procedure which it involves.

Certain points in the Charter of the Society may be debatable, as no doubt they are, but that contingency is provided for, and in all cases of even "seeming" contradiction, the "words and meaning of the Charter *must* prevail."

Our contention is that neither the words nor meaning of the Charter has been complied with. 1, Mr. Morris' resignation has not been completed in accordance with the Charter and by-law 81. 2, The vacancies in the Treasurership have only been temporary vacancies, and filled in a temporary manner. 3, Mr. Crowley's nomination to the Council has not been submitted in prescribed form to an annual meeting. 4, The balloting lists were not in accordance with the Charter; and (5) in consequence of the irregularities (accidental, we admit), Mr. Morris remains responsible both as a member of Council and Treasurer of the Society.

It is no pleasure to us that this is so. We should only be too glad for the wishes of the Council to be carried out without any infringement of the Charter, and the valuable services of Mr. Crowley secured consistently with those of Mr. Morris being retained. We have pointed out how this could be done without any question, we believe, as to its legality, and if the objects in view can be accomplished in any other way, within the law, we shall not raise the slightest objections to the procedure.

But "outsiders" may excusably wonder why we attach importance to adherence to prescribed forms. It is the Royal Charter that was granted to the Society by the Sovereign that gives to the Society a rank and position above all horticultural societies in the kingdom, and it cannot be generally known that supporters of any other Societies are not entitled to rank as "Fellows," otherwise there would be no pedantic usurpation of that title either established or proposed. We think it would be a pity if at this juncture, when the Royal Horticultural Society is, we trust, on the threshold of prosperity, that anything should occur through misconception to strain the law by which alone it has been held together so long, and under which we are convinced its influence, usefulness, and stability can alone be maintained.]

SCIENTIFIC COMMITTEE.—W. T. Thiselton Dyer, C.M.G., in the chair. Present: Mr. McLachlan, Professor Scott, Professor F. Oliver, Professor Marshall Ward, Professor Church, Dr. Müller, Rev. W. Wilks, G. F. Wilson, Dr. Bonavia, and Dr. Masters.

Action of Galvanised Wire on Peach Trees.—The Rev. W. Wilks showed specimens of the injuries observed on shoots of Peach trees which were in contact with galvanised wire during the recent severe frost. The shoots at the point of contact with the wire were apparently blackened and frozen through, so that the distal part of the shoot,

although for a short time retaining its healthy appearance, shortly dies of starvation. Similar illustrations have been before the Committee on other occasions.

Effect of Fog on Plants.—Professor F. Oliver showed a number of water-colour drawings showing the effect of fog on the leaves and flowers of various plants, but reserved a full statement of his observations till a future time.

The Aboriginal Chinese Primrose.—From Mr. Myles, Appley Towers Gardens, Ryde, came plants of *Primula sinensis*, raised from seed collected at Y-Chang by Mr. Pratt, under conditions very unlike those under which the plant is cultivated in this country. The history of the plant was alluded to at the Primula Conference in 1886, and was also adverted to in Mr. Sutton's paper on the Chinese Primrose, which will shortly be published in the Journal of the Society.

Self-sown Seedlings of Chamærops Fortunei.—From the same garden came seedling plants of this Palm, which is growing in the shrubberies at Appley Towers, and beneath whose shade a large number of seedlings spring up.

Species of Pinus.—From Mr. Rashleigh came cones of *Pinus* "El Doctor," which appeared to be very closely allied, if not identical, with *Pinus Montezumæ*. A cone of an undescribed species collected by Captain J. Donnell-Smith at a height of from 10,000 to 12,000 feet on the Vulkan de Agua in Guatemala, was also exhibited. Mr. Godman and other travellers make mention of the forest composed of this tree, which forms a belt round the mountain at the above elevation, but which does not appear to have been described; indeed, in the Loudon *Herbaria* there are no specimens that correspond with it. It will be described as *Pinus aguensis*.

Timber and Cones of "Wellingtonia."—From Mr. Leach, gardener to the Duke of Northumberland, Albury Park, Guildford, came a fine cluster of cones of *Sequoia gigantea*, and also a transverse section of the trunk of a tree that had been planted twenty years, and had grown with great regularity and rapidity, as evidenced by the rings.

Ivies and the Frost.—Various leaves of Ivies from plants growing on the same wall were exhibited, showing the varying effects of frost on the different varieties—some being completely killed, whilst others were scarcely if at all injured. The Himalayan form, as pointed out by Mr. Dyer, was the most severely injured of all.

The Rind of the Orange.—With reference to this subject Dr. Bonavia read a communication referring to the two specimens shown at the last meeting. One had of course an enveloping peel. Within this was a whorl of pulp carpels. Within this again was a second whorl without peel on its outside. So that we can hardly consider the peel as the outer side of the pulp carpels. The peel is evidently not an essential part of the pulp carpels. It can be suppressed, while the pulp carpels remain as in this case of the inner Orange.

But what is most interesting in this specimen is that in the centre of the inner Orange there were two strips of peel adherent to the placental margins of the inner carpels, each strip having its oil-cell-coloured surface directed towards the centre, and not, as is usual, towards the outside of the Orange.

To my mind this would indicate that the peel is a distinct whorl independent of the pulp carpels. In the doubling of this Orange we have (a) a peel whorl, (b) a pulp whorl, (c) another pulp whorl, (d) a peel whorl represented by two strips only, and with the coloured glandular surface twisted towards the central axis of the Orange, showing that these peel strips are no other than transformed stamens, or carpels, or leaves.

In my opinion the relation of the coloured peel to the pulp carpels is exactly that of the purple sheath of the Moutan Pæony to the green carpels it encloses. The peel is no more the outer surface of the carpels than the calyx of *Physalis Alkekengi* is the outer surface of its pulp carpels.

In the Tangerine Orange there is only slight adhesion between the peel and the pulp-cells, and you will find one-third of an inch of space between the peel whorl and the pulp whorl; all degrees of adhesion and non-adhesion are to be found. Some varieties of Citrus have the peel so closely adhering to the pulp that it can only be detached with a knife, while in others the pulp ball actually rattles within the peel envelope.

What is most convincing of all, however, is that in those species of Citrus, in which the peel is divided into segments, with their edges covering, and thus forming a continuous envelope, the segments of the peel do not tally with the segments of the carpel ball. How can I, therefore, believe that each peel segment is the outer surface of a carpel?

The second specimen you gave me was of common occurrence. The small inner Orange was enveloped in its own peel. That is the doubling occurred—peel pulp, peel pulp. This is exactly what occurs in the doubling of some kinds of *Narcissus*. In these we have the doubling occurring in this fashion—calyx corolla, calyx corolla, calyx corolla, and so on up to the centre of the flower. In some cases the calyx retains its greenish colour throughout the series.

The interest of the second specimen was in the smallness of the inner Orange. Its juice vesicles were so small and sessile, that they were almost indistinguishable from the oil-cells of the peel, the prominent difference being that the former had an acid taste.

Yucca flaccida.—From Mr. Burbidge, Trinity College Garden, Dublin, came leaves of this plant, bearing at or near the margin, and sometimes from one surface, sometimes from the other, short tubular, horn-like processes, the significance of which is not apparent. Dr.

Masters gave the details of the histological structure of the leaf, the main points of interest being, that in addition to the central row of vascular bundles, there are two other series of smaller bundles, one between the central bundle and the upper epiderm, the other between the centre and the lower epiderm. In the central bundles the relation of the xylem and phloem is normal, that is to say, the xylem is directed towards the centre of the leaf, the phloem towards the lower epiderm. In the lower or outer series of bundles the phloem is external, the xylem central. In the upper or inner series the phloem is also external, the xylem internal, so that the section of the central bundles and of the uppermost ones taken together resembles a section of a stem. In the horn-like portions, the palisade cells are absent, and the cells are nearly uniform in size and shape, the vascular bundles arranged in a ring, each bundle having its bast towards the periphery, its wood towards the centre. Thus, while the flat portion has the structure of a leaf with indications of stem-structure also, the horn-like portion assumes completely the appearance of an axis.



FRUIT FORCING.

PINES.—*Plants Starting into Fruit.*—Those which were selected about the beginning of last December, and started by an advanced temperature and an increase of moisture, will now be showing fruit: and as it is advisable to advance the ripening of the fruit of these plants as much as possible, the temperature may be maintained at 65° to 70° at night, and 75° to 80° in the daytime under favourable circumstances, ventilating at 80°, allowing an advance to 85°, and closing at about that figure, utilising the sun heat as much as possible. The plants will require more water at the roots, examining the whole stock once a week, as with increased light and heat the need for water will correspondingly increase. Recently started plants to follow those already named should have a night temperature of 65° and 70° by day artificially, which will be sufficient for them for some time longer.

Starting Suckers.—Some of these will have to be started at the commencement of March to give a succession of fruit from next December onwards; therefore, attend to the preparation of the soil for potting, and a fermenting bed in some close structure to generate and maintain a bottom heat of 85° to 90° near the surface, and with means of maintaining a temperature of 55° to 65° by fire heat with regularity.

VINES.—*Early Forced in Pots.*—These must not sustain any check either through dryness at the roots or in the atmosphere. If the roots cannot have the run of the fermenting bed place strips of zinc 3 or 4 inches deep round the top of the pots, inserting them just within the rim, and top-dress with rich turfy loam and decayed manure in equal parts, intermixed with a small handful of superphosphate to each pot, but with the pots plunged to the rim in fermenting material; strips of turf about 3 inches thick should be laid over the rim so as to form the necessary dish. Keep them watered with liquid manure a few degrees warmer than the house in which they are growing; also have the plunging material moist, especially where the roots are allowed to find their way from the bottom of the pots, there being nothing like plenty of feeders to secure well filled berries. Use also liquid manure for watering the Vines, not keeping them sodden, but allowing the soil to become fairly dry, then afford a plenteous supply. To encourage the swelling of the berries keep the laterals below the fruit somewhat closely stopped, but allow those above the bunches more liberty, but avoid overcrowding the trellis with foliage that cannot have full exposure to light. The earliest started are stoning, and this is a critical time, therefore careful treatment is necessary in ventilating, taking care to avoid cold currents, which cause "rust" and harden the epidermis so that the berries do not afterwards swell freely and in some varieties cause cracking. Ventilate early in the day, affording a little air at 70°, increasing it with the sun heat to 85°, closing at 80°, and if an advance follow to 85° or 90° all the better. If red spider appear let the affected leaves be promptly sponged with weak softsoap and water, keeping the atmosphere duly ammoniated by damping available surfaces occasionally with liquid manure, 1 lb. guano to twenty gallons of water, or stable drainings, mostly urine diluted with six times the bulk of water, answer well, applying in the evening and not overdoing it, but using it discreetly at the rate of a gallon per dozen square yards and always on damp not dry surfaces, for it must not take the place of the essential damping with water for maintaining a genial condition of the atmosphere. Painting the return hot-water pipes with sulphur brought to the consistency of thin cream with buttermilk or skim milk is an antidote to red spider and mildew.

Early Forced Planted-out Vines.—Houses closed in November and the Vines started early in December will need to have the berries thinned, in effecting which lose no time as soon as it can be seen which berries are properly fertilised by their taking the lead in swelling. Tolerate no surplus bunches; remove badly set and ill-shaped clusters, seeking a full crop of compact, good shaped, well-furnished bunches.

properly swelled, and perfect in colour and finish, which are more profitable and much more creditable than an enormous crop of large, loose bunches, unevenly swelled berries, red in colour, with a large percentage shanked. Let laterals extend beyond the fruit where there is room for its exposure to light, but in no case must laterals be encouraged to the prejudice of the principal leaves. Attend to stopping frequently, for the alternating accelerations and check to root action consequent on encouraging the laterals and then removing them by armfuls, are attended by the worst consequences to the foliage and fruit. Afford a thorough supply of tepid liquid manure to the inside border at intervals as required to maintain the soil in a thoroughly moist state, and mulch with a couple of inches thick of short lumpy manure, sweetened horse droppings as prepared for making Mushroom beds being most desirable, but avoid using them too freshly, for though a moderate amount of ammonia vapour is beneficial, when too powerful, particularly when the house is kept close as too commonly prevails in dull periods, it is productive of serious injury to the foliage and fruit. Maintain a night temperature of 60° to 65°, 70° to 75° by day, advancing 10° to 15° from sun heat, commencing to ventilate from 70°, keeping though the day at 80° to 85°, when external conditions are favourable, closing between those temperatures, damping at the time. Avoid syringing the foliage and fruit, as, however, clear and soft the water may be, there is danger of sediment; in fact, we find a deposit on the berries inseparable from the use of the syringe after the Vines have set their fruit. All appears clear until the Grapes begin to finish, then the purple or golden hue stained with white is a serious blemish. Outside borders must be well protected against the chilling effects of cold rains or melted snow.

Early Muscats.—Where there is a house devoted to these, and assuming it was closed by the early part of December, and the Vines started by the middle of that month, the bunches are now approaching the flowering stage, and will require a night temperature of 65° to 70°, with a rise of 10° to 15° by day, closing at 80° to 85° when bright weather prevails. When they commence flowering it is desirable to dust the bunches with a large camel's-hair brush, and fertilise every bunch with Black Hamburgh pollen, this being very necessary for the best forcing of all Muscat Grapes—the Black or Muscat Hamburgh, which is very liable to have a large percentage of small seedless berries; Madresfield Court sets very much better, but it has not the Muscat nor in any case the high quality of the Muscat of Alexandria and Black Muscat. These are unapproached in quality, and to succeed, the roots must be inside, particularly the early forced and late. Early Muscats are prized, and to have them ripe early in June the Vines must be started at the time named, or to have them in the highest perfection they require time in ripening, the wood being thoroughly ripened and the roots having the benefit of a warm inside border, which has been duly mulched. A dry surface causes the roots to descend in search of moisture and nutrition, and the roots of Vines are often more abundant in the soil immediately beneath the drainage than in the expensive border prepared for them, simply because they find there the requisite uniform moisture of which Muscats require full supplies along with plenty of warmth and air.

KITCHEN GARDEN.

FORCING ASPARAGUS.—It is a comparatively easy matter to force Asparagus, the greatest difficulty being to procure the requisite number of roots without crippling the ordinary spring supply. Only strong roots, or, as a rule, any three years old or upwards, ought to be lifted for forcing, and seeing that they are of no service afterwards no one should lightly break up established beds without calculating what will be the effects upon the main crops. Where it is systematically forced a few old beds are broken up every year, new ones being planted to take their place, and this plan answers well. Hard forcing ought always to be avoided, a strong dry heat being especially objectionable. A gentle hotbed formed principally of leaves in a heated pit, or even in the open, and surmounted by frames is found the best means for forwarding Asparagus. Cover this with rich soil, set the carefully lifted roots close together on this and surface over with a thickness of not less than 3 inches of rich moist soil. Thus treated, and never allowed to become dry, strong succulent shoots will be quickly and continuously produced for the space of about six weeks. From two ordinary pit lights closely filled with roots it ought to be possible to pull or twist off, not cut, about three bunches of fifty shoots, and one bundle of "sprue" or small shoots for soup, weekly. If strong sound roots fail to do well this most probably is due to overforcing and an insufficiency of water, poor dry soil too often surrounding Asparagus being forced.

KIDNEY BEANS.—Of these again it is hardly possible to force too many this season. What they require is plenty of heat, light, and room. Crowded either by being sown too thickly or stood close together causes a weakly growth, and the crops are light and of short duration accordingly. Better, therefore, grow twenty-five pots in a batch, giving these good room, than many more crowded together. Fitful supplies are unsatisfactory, and successions ought to be sown every fortnight. If room can be found the simplest plan is to sow the seed direct into 8-inch or 9-inch pots, lightly drained, and nearly filled with rich loamy soil. The old plan of leaving space in the larger pots for top-dressings is quite uncalled for, this being so much useless labour. Give the preference to new seed of either Ne Plus Ultra or Canadian Wonder; place about nine seeds in each pot, set them on hot-water pipes if wanted up very quickly, and shift to a lighter position before

the plants become tall. Thin to about seven plants in a pot, support with either Birch spray or stakes and raffia; water carefully at first, but when the plants are approaching their full size they will require abundance of water and liquid manure. They succeed best on shelves in forcing houses, and in these positions receive the most light, air, heat, and best attendance. The pods ought to be gathered before the seeds are large, and the sooner they are cooked the more tender they will be, keeping them in water having a very hardening effect.

EARLY LETTUCES.—The early Paris Market Cabbage Lettuce forces readily either in boxes placed along the light fronts of vineries, Peach houses, or in warm pits, or better still in frames or slight hotbeds prepared principally for it. Supposing a pinch of seed was sown in a pan late in January, a very little heat would have sufficed to grow the plants to a good size by the present time, and they may at once be pricked out where they are to grow. Moderately deep boxes may be filled with rich loamy soil, and in these the plants should be pricked out 4 inches apart. Being assigned a light position, and only gently forced, they will soon be large enough for use. One-half of them ought to be cut early, and will be found tender and suitable for mixed salads, while the rest will form surprisingly good hearts long before any are available outside. If a frame can be spared, set this on gentle hotbed, throw in sufficient short manure to bring a layer of rich, somewhat fine soil, well up to the glass. Prick out the plants 4 inches asunder, keep them rather close and shaded till growing afresh, after which air should be given somewhat freely, on warm days especially; keep well supplied with water, and protect the frame during the night. Commence thinning out early, those left continuing to increase in size and value. No frame crop pays better than these. Sow more seed of the same variety, and also of Perfect Gem or any other good Cabbage Lettuce, while if Cos Lettuce is appreciated, sow seeds of Paris White, or selections from the same. If the seed is sown thinly in boxes, and the plants are not long kept in heat, they may be pricked out on warm borders where they are to grow. The Paris Market treated in this way will usually heart in more quickly than autumn raised plants of any other variety.

PLANT HOUSES.

Stephanotis floribunda.—Plants that have enjoyed a good season of rest in a temperature of 50° to 55° may be started into growth in any structure that can be kept 60° at night. If gentle bottom heat can be given all the better, but directly growth commences lift them out of any material in which they may be plunged on to the surface, for they will be better without it. If these are in pots that are considered large enough top-dress with loam and manure. Directly root growth commences place on the surface of the soil a good layer of decayed manure. Syringe the plants twice daily when fine with tepid water, and give the shoots a good soaking if they have been kept on the dry side. If the plants have been infested with mealy bug watch carefully for any that may have been left. Plants that have been carefully and thoroughly cleaned will often, if neglected at this season of the year, be as bad as ever by the end of the season. Constant watchfulness is needed during the spring after a thorough winter cleaning if mealy bug is to be stamped out.

Clerodendron Balfourianum.—Start plants that have been resting in a temperature of 55°. All unripe wood should be removed, and then give the conditions advised for *Stephanotis*. If the plants were placed into large pots last year remove a good portion of the surface soil, and top-dress with equal parts of loam and manure. Plants subjected to this treatment may be carefully trained upon their trellis. Those to be potted should have the trellis removed and painted, supporting the plant with a few stakes until it breaks into growth, when potting may be done. About one-third of the old ball should be carefully removed, and then repotted in the same or a larger pot as the case may be. Use for a compost two parts good fibry loam, while the other two may consist of leaf mould, sand, manure, and charcoal. Press the soil firmly and water carefully until the plant is rooting freely. A few seeds of *C. fallax* may now be sown.

Bougainvillia glabra.—Prune out all weak growths and cut others back to one or two eyes if not needed for the extension of the plant. When this is needed strong growths may be laid in nearly their full length. The ball of this plant must be carefully reduced. Work from amongst the roots about one-third of the old soil just as the plant is starting into growth. Those that do not need potting may be top-dressed with manure. Start this plant the same as advised above, and when it has commenced to grow freely remove it to a lower temperature, 50° to 55° will be ample, where air can be admitted whenever the weather is favourable.

Allamandas.—Young plants that were not well ripened at the approach of winter, and have since been kept dry to harden their wood, may be placed into larger pots if the object is to push them on as fast as possible. If in 8 or 9-inch pots, those 12 inches in diameter may be used. Pot the plants in good loam, one-seventh of manure, and sand. Press the soil firm. Cut back the growths to where the wood is firm and train the shoots horizontally. By the end of the year they will have furnished a large space, and if exposed to the sun will flower profusely. Start into growth a plant that has enjoyed a good period of rest, prune the wood well back if not already done, and repot in the compost advised above. The old ball may be reduced one-half and then started in the temperature advised for *Stephanotis*.

Eucharis.—Plants that need to be repotted should be done at once if they are not in active growth. Under these circumstances potting must

be delayed for a time if the plants are to be broken up. If not it does not matter, as they can be potted without injury provided the old soil is worked carefully away and the new compost has been well warmed. When the plants are broken up pot all the small bulbs in pots by themselves. Use for a compost good fibry loam, one-seventh of manure, plenty of sand, and a little chareoal to keep the soil open and porous. Plunge the plants after potting, if possible, where they can enjoy gentle bottom heat, by which they will soon become established. Syringe the plants twice daily until they are established. It must be remembered that these are not deep rooting plants, and that if grown in large pots liberal drainage should be employed.

Paneratiums.—These may also be repotted if they need it. Place young stock into larger pots, or any plants that it is necessary to increase in size. To increase the stock take off the young plants that nestle round the base of the large bulbs. Use the compost advised for *Eucharis* and give the plants the same treatment—that is, all that have been disturbed at their roots; the remainder may be grown in the stove in the ordinary way.

THE BEE-KEEPER.

APIARIAN NOTES.

ADVANCED STATE OF HIVES.

ALTHOUGH I fully expected to see many young bees, I was rather surprised on the 15th of February to see them so numerous. Several hives swarmed with them, and looked more like hives in May than in the middle of February, and which had sprung from eggs laid during the coldest time of the year. The heaviest hives had most of them. In order to keep them in a forward state when the weather is mild I shall supply them with sufficient, but not excessive, syrup. At the same progress for two months as they have been making in the past six weeks they will be crowding out end of April or beginning of May. But we may experience severe wintry weather yet, which will prevent their maturing swarming symptoms so early. Be that as it may, I shall encourage the most forward to swarm early, and from them prepare young queens for late summer work.

ROBBING.

One extra strong Carniolian hive attacked another before it was rightly wakened up, and was making rapid progress towards the attacked one's destruction when I observed it. I immediately carbolicised the alighting board of the marauders, and after a little closed it in. Meanwhile I altered the entrance of the attacked hive a few inches. The slight disturbance on so fine a day caused them to sally forth, and immediately put themselves into a state of defence, when the others were released, but to make another attack, but this time were repulsed. A heroic defence by the attacked is the best means to put a stop to robbing. I have at times stopped it by breaking up a portion of the attacking hive's honeycomb, but it is better when it can be prevented by using every precaution necessary than have recourse to extreme measures.

When bees get into a state of persistent robbery it becomes a great drawback to the hives and a serious loss to the apiarist, as they take a long time to make up the loss of bees, and the brood may never be extended to what will bring the hive up to the standard strength, at least often till it is too late.

APPLIANCES.

Without attempting to forecast what the weather will be during the honey season, it will be quite safe to predict that if we are favoured with three weeks or more settled weather during the honey months, the bee-keeper will not be studying his own interest if he fails to have sufficient super accommodation provided beforehand for a large yield of honey, which may be 112 lbs., or even more, from good stocks. I have frequently had upwards of 200 lbs. from each stock hive, and it is better to be provided with extra than to be short of super accommodation.

EXCESSIVE SWARMING.

Excessive swarms do not demand an extra number of hives, as in the case of supers, as swarms in many cases can be manipulated by joining to one another, so as to secure strength with a larger yield of honey from fewer but stronger hives than from a greater number but weaker ones. But even in this the bee-keeper should always have a few extra hives on hand, in case of a fine honey season appearing, as we all hope it may in 1891.

When a spell of fine weather comes the bees must either have excessive room in the body of the hive or the supers. When in the former, and the bees crowding the supers, it is, generally speaking, most satisfactory, as then where healthy queens are at work there is less likelihood of the bees preparing to swarm as when the breeding boxes are crowded with a paucity of bees in the supers, and swarming always takes place most frequently where queens are faulty.

It is one of the common errors of the present time amongst bee-keepers to suppose, as they do, that swarming is provoked by a manipulation, or in other words by some act done or omitted in the course of one or two days' time. An already crowded hive's swarming may be hastened by some manipulation or other, but bees prepare for the event in a regular and systematic manner according to Nature's laws, and which man in most cases cannot control.

I hope the foregoing hints may enable all bee-keepers to be prepared with all appliances to meet the contingencies of the season, whether they be favourable or unfavourable.—A LANARKSHIRE BEE-KEEPER.

BEE NOTES.

THE bees have thawed at last, so we may expect a little more activity amongst their masters. I intended some months ago to send you a few notes on the past season's work, but it was unavoidably put off, and during the freeze-up we have had one seemed to have but little heart to settle to anything. Well, after having been practically frozen up for eight weeks the bees are on the wing again. Sunday, the 25th ult., was a fine bright day, and though the temperature in the shade only rose to 45° the bees were out and had a good airing. So far all my stocks are alive except one, which I knew was weak early in the autumn, and scarcely expected it to survive the winter. Never in my short experience were things more promising than they were in May of last year for a good honey harvest. Stocks were uniformly strong, and six of my seven hives were working in supers by the middle of that month, and all had made a little surplus from the fruit trees and Sycamores by the end of the month. June, as we all know, proved cool and wet, 2° below the average temperature, and a rainfall of 1 inch above the average. The bees increase in numbers amazingly, but diminished rather than increased their surplus until the white Clover came into bloom.

July was again 2° below the average temperature, with a rainfall of nearly 4 inches. White Clover was never more abundant, but the rain was so incessant that there was no chance of the honey coming in, and as this is what bee-keepers in this district have to depend on for their surplus, as may be imagined the result was disastrous to all but those whose colonies were very strong. A few dry days after the 20th of July enabled the bees to get a little out of the fag-end of the Clover, strong colonies making fair progress, and weaker ones fairly filling up their stores for the winter. According to our custom all supers were cleared off by the 10th of August, with the result that we had 190 lbs., or an average of 27 lbs. per hive. Of this 154 lbs. were 1 lb. sections fit for market, the remainder, 36 lbs., extracted from over 100 unfinished sections, leaving us that number filled with beautiful white combs for this year's use.

I had no swarms during the year. From six small straw skeps which I manage for my employer we had 60 lbs. finished sections, and finished the season with an increase of two stocks in bar-frame hives. Altogether our returns were not so bad as many had to be content with. Six or eight years ago when I started bee-keeping, my greatest difficulty was to find a market for the honey. This I have overcome. By glazing the sections I find the local grocers are pleased to handle them, and give 10s. per dozen for them. This may not seem a large price to those who talk of getting 1s. 6d. per lb., but I have found that in Brighton,

no matter what the season is, you can get comb honey in the shops at 1s. per lb. That seems pretty well the fixed price of honey in that town.

What has become of "A Hallamshire Bee-keeper" and his glass sections? I exhibited some of these taken off 1st of June at a local show in August, and was disqualified by the clever professional who judged them, because they showed some slight signs of granulation, and was, forsooth, told that they had been at least partly filled the previous year. I satisfied myself afterwards that the granulation was confined to the first row of cells next the glass. Has "A. H. B." found this state of things with his pet sections? It is certainly a disadvantage if it takes place to any extent. I think it stands to reason that the cool glass will have that effect more quickly than wood.

Why do we hear so little of bee-keeping in the south in the pages of the Journal? The north is very well looked after by the sound articles of our friend who writes so constantly from Lanark, but it is surely possible to get some of our southern experts to give us a word in season occasionally. It has been said that all gardeners ought to be bee-keepers, and I think it would be something to their advantage if they were.—A SUSSEX AMATEUR.



All correspondence should be directed either to "THE EDITOR" or to "THE PUBLISHER." Letters addressed to Dr. Hogg or members of the staff often remain unopened unavoidably. We request that no one will write privately to any of our correspondents, as doing so subjects them to unjustifiable trouble and expense.

Correspondents should not mix up on the same sheet questions relating to Gardening and those on Bee subjects, and should never send more than two or three questions at once. All articles intended for insertion should be written on one side of the paper only. We cannot reply to questions through the post, and we do not undertake to return rejected communications.

Report of Meeting (G. F.).—The report of your meeting held eight days ago arrives just as we are going to press, and too late for insertion.

Wednesday Morning's Letters (Griffin and Others).—Letters of inquiry which arrive at this office on Wednesday can seldom be satisfactorily answered in the current issue.

Erythronium grandiflorum (A Journal Reader).—You will find the information you desire on page 171, and the illustration will convey to you a better idea of the characters of the plant than a mere verbal description.

Seedling Grape (Co. Down).—The berries received were not in good condition, and the colour is much against them; they were, however, sweet and of fair flavour. You must exhibit a good bunch next season, and it will stand some chance of being recognised.

Scotch Fir Infested by Insects (Rockwood).—We have carefully examined the specimen sent, but failed to detect insects of any kind. Possibly they were dislodged or dried up in transit. The Scotch Fir is subject to the attacks of scale, aphides, and other pests, and small specimens can be syringed with softsoap or other insecticide. It is, however, difficult to deal with large specimens in that way.

Myrobalan Hedges (H. R. W.).—We have seen a hedge one portion of which was planted with the Myrobalan and the other with the common Thorn at the same time alongside of a plantation. The former proved by far the quicker grower, but though it made a fence much sooner, it was not so close and neat as the Thorn. Our readers who have had experience with the Myrobalan for the purpose named are at liberty to write us on the subject.

Orchid Flowers (E. C.).—The flowers sent are all good and in excellent condition owing to your careful packing. 1 and 2 are fine varieties of *Dendrobium nobile*; 1 is a near approach to *D. nobile* Sanderianum in size, form and colour, but the rich crimson hue does not extend so far down the sepals and petals in your variety. No. 2 resembles a good form of *D. nobile* *cerulescens*, a useful and bright variety. No. 3 is a dark form of *Cypripedium Harrisianum*, but it is not so fine as *C. Harrisianum superbum*, though well worth keeping.

Gardeners as Domestic Servants (W).—In reference to our reply on this subject last week we are supplied with the following

extract from page 342 of the last edition of "Every Man His Own Lawyer":—"The term 'domestic' or 'menial' is now to be considered as applying to coachmen, grooms, gardeners, and huntsmen." We omit the enumeration of other servants as not pertinent to the question. The authority given for the above definition is *Nicholl v. Greaves*, 33 L.J.C.P., 259.

Packing Fruit (Scotia).—You still do not indicate the articles to which you made reference. Grapes, Peaches, and such like choice fruits grown in this country are packed and placed in the market as well as any that come from abroad, so are Strawberries, also choice samples of Plums, Cherries, Tomatoes, as well as Pears and Apples by growers who know their business. American and Canadian Apples are sorted and packed in barrels, but tons of home-grown fruit have been sent to market in a rough unsorted condition. You can find examples of packing most kinds of fruit in markets and shops in Manchester.

Grass Edging Broken (F. J.).—You cannot make a firm edge by outside additions, but you can do so by cutting through the turf in line a foot or so from the edge, then with a sharp spade raising and drawing the portion so sliced off as far as is necessary into the walk, rolling it well, then with a line and sharp knife slicing the rough margin away to a fine smooth edge. The vacancy made in the lawn can be filled with fresh pieces of turf made level and firm, or by filling them with soil and sowing grass seeds.

A Curious Address (Lew).—No doubt the address you send is novel, but not quite so unique as the following:—As is well known, Messrs. Carter & Co. announce in their catalogues and advertisements that they hold warrants as seedsmen to the Queen and Prince of Wales. This has been interpreted in a distinctly novel manner, for before us is an envelope which was posted at Haeght (Belgium), on the 20th inst., and thus addressed:—"Messieurs H.M. the Queen and H.R.H. the Prince of Wales, 237 and 238, High Holborn, London." We presume the sender wanted some real Royal seeds.

Iron Sulphate—Worms and Strawberries (S. J. A.).—Iron sulphate has been found excellent for Potatoes, both in increasing the crops and arresting the disease. It will be better to apply it before planting than between the rows afterwards. We think your land either requires draining or a great deal more lime, perhaps both. The worms which devour your Strawberries are not wireworms, but a kind of eelworms, and are often very troublesome in wet seasons. Mr. Wright, on page 29 of "Profitable Fruit-Growing," recommends straw passed through a cut box, as if preparing food for horses, for placing between rows of Strawberries for keeping the fruit clean and baffling slugs, which cannot travel freely over the unstable particles, nor can worms move so freely over them as on a firmer surface. Some persons find it necessary to place twiggy sticks for supporting the fruit above the foliage in wet weather, and find the end well justifies the means. We believe the subject of eelworms and Strawberries will be found specially treated in Miss Ormerod's Report of Injurious Insects, which is in the press, and will be shortly issued. In spraying the moisture rests on plants like dew; in syringing they are washed as by rain.

Enriching Vine Borders (A Subscriber).—Possibly neither of the manures applied alone would be the best for your purpose. If the poor soil is sufficiently porous, or well drained for water to pass down freely, probably the best thing you can do will be to apply liquid manure at once. It may be given stronger now than in summer, and 5 gallons may be given to each square yard, this being equal to a little more than an inch of rain. The liquid that drains from both horse and cow stables contains exactly what Vines require—potash; the solid matter used containing very little indeed of this essential Vine food. In the absence of stable drainage or sewage, a pound of guano and half a peck of soot dissolved in about forty gallons of water would be good for enriching the Vine border at the present time. Mix the best manure you have for spreading on the border, not too open on the one hand or like a close soapy mass on the other. Some of the finest Grapes exhibited last summer were the result mainly of liquid manure applied to the border during the preceding winter. "There is no mistake about the efficacy of the plan," wrote the gardener who won many prizes in strong competition, and he expects to win more.

Sparrows and Gooseberry Bushes (J. Sharman).—Pruning on the "spur system" as referred to by a correspondent on page 111 means that a certain number of main branches a foot apart or thereabouts form the framework of a bush, and all annual growths from these branches are cut back to within an inch of their base every winter, this practice resulting in the production of clusters of fruit buds or "spurs," especially where summer pinching or pruning is also practised. You will find spur pruning in its integrity as applied to Currants illustrated in Wright's essay on "Profitable Fruit Culture," and also shown in combination with the retention of some annual growths in pruning Gooseberries. Our correspondent, "W. T.," is quite right. Where sparrows abound they do more injury to spur-pruned bushes than to those that are not so pruned, because of the readier accessibility of the former to the birds. Where these are unusually persistent in their attacks some fruit growers have found it advantageous, instead of pruning Gooseberry bushes after the leaves fall, to pass strong string: tarred cord round them, and tie each bush into a close bundle, the birds then only denuding the outside branches of buds, sufficient being preserved inside the bundle for the production of fruit. The string is not

removed until the buds have pushed growths in the spring sufficiently to be no longer inviting to the mischievous depredators. At that time the opened bushes are pruned more or less according to the judgment of the owner or cultivator. Where sparrows are not so numerous as to become a pest, or where the buds can be preserved by dressings of lime and soot, the system described in the essay is the best to adopt in pruning Gooseberry bushes. The work can be had by post for 1s. 3d. from this office.

Improving Soil (T. W. W.).—The land, which you say has been "laying under fallow for three years," has probably simply been left alone, and has grown luxuriant crops of weeds. This is very different from fallowing, which means exposed soil moved occasionally to prevent the growth of weeds to any material extent; we suspect therefore the soil has been really cropped—that is, cropped with weeds, and these abstract from it similar constituents that are appropriated by food crops. The soil is of good staple but poor, and when well worked, cleaned, and enriched will grow both fruit and vegetables. It is deficient in humus, and you cannot err in applying all the stable manure you can obtain, with vegetable matter of any kind that you can collect, such as moss litter that has been used in stables, spent hops, fibre refuse, and kiln dust; even sawdust would do good. It would probably be a good plan to clean the land well and plant it with Potatoes this spring, ridging it after ploughing, then levelling down the ridges over the sets. Such manure as you can obtain may be spread in before planting. Kiln dust is excellent, but not always obtainable; and soot would undoubtedly be beneficial in such land. As a chemical mixture 4 cwts. of superphosphate of lime and 2½ cwts. of kainit per acre when planting has been found good, especially when supplemented by a top-dressing of 1½ to 2 cwts. of sulphate ammonia at the first hoeing, or just when the Potato growths are pushing through the ground. Nitrate of soda forces growth more quickly, but might not be better for your cold soil, while sulphate of ammonia is of more benefit to an aftercrop than is nitrate of soda, as we have seen after trials on a very large scale by Potato growers in Lincolnshire. Keep the Potatoes absolutely free from weeds and you may have a good crop of tubers, while the land will be in much better condition for planting with fruit trees and bushes in the autumn than it is now.

Names of Fruits.—The names and addresses of senders of fruit to be named must in all cases be enclosed with the specimens, whether letters referring to the fruit are sent by post or not. The names are not necessarily required for publication, initials sufficing for that. Only six specimens can be named at once, and any beyond that number cannot be preserved. (J. L.)—The specimens are so extremely small and inferior that we cannot speak positively as to their identity. However, we think the green one is the Northern Greening and the red fruit is possibly Winter Queening. (J. H. D.)—1, Fearn's Pippin; 2, Dume-low's Seedling.

Names of Plants.—We only undertake to name species of plants, not varieties that have originated from seed and termed florists' flowers. Flowering specimens are necessary of flowering plants, and Fern fronds should bear spores. Specimens should arrive in a fresh state in firm boxes. Slightly damp moss, soft green grass or leaves form the best packing, dry wool the worst. Not more than six specimens can be named at once, and the numbers should be visible without untying the ligatures, it being often difficult to separate them when the paper is damp. (B.)—1, *Cypripedium villosum*; 2, *Cattleya Trianae*; 3, *Phaius grandifolius*; 4, *Masdevallia ignea*. (J. H. R.)—1, *Tillandsia splendens*; 2, *Tillandsia usneoides*; 3, *Tillandsia Lindenii*. (J. C. S.)—We do not undertake to name Potatoes, as the tubers vary in character in different soils. If you describe the growth of the variety, also send a tuber to any of the advertising seed firms who give special attention to Potatoes, you may probably obtain a supply of what you require. (G. P.)—*Ada aurantiaca*, an extremely useful Orchid. (J. L.)—The flowers sent last week freshened considerably in water, enabling us to recognise the *Cœlogyne* as *C. flaccida*, and the other as a dull yellow variety of *Odontoglossum crispum*. Those you send this week are quite distinct, but no numbers are affixed. The two larger are varieties of *Odontoglossum crispum*; the smallest is an ordinary *O. Pescatorei*.

COVENT GARDEN MARKET.—FEBRUARY 25TH.

BUSINESS quiet, with supplies somewhat shorter.

VEGETABLES.

	s.	d.	s.	d.		s.	d.	s.	d.
Artichokes, dozen	0	0	0	0	Mushrooms, punnet	1	6	2	0
Beans, Kidney, per lb.	1	6	1	9	Mustard & Cress, punnet	0	2	0	0
Beet, Red, dozen	1	0	0	0	Onions, bushel	8	0	4	0
Brussels Sprouts, ½ sieve	2	6	3	0	Parsley, dozen bunches	2	0	3	0
Cabbage, dozen	1	6	0	0	Parsnips, dozen	1	0	0	0
Carrots, bunch	0	4	0	0	Potatoes, per cwt.	3	0	4	0
Cauliflowers, dozen	3	0	6	0	Rhubarb, bundle	0	2	0	8
Celery, bundle	1	0	1	8	Salsafy, bundle	1	0	1	0
Coleworts, doz. bunches	2	0	4	0	Scorzoner, bundle	1	6	0	0
Cucumbers, doz.	4	0	8	0	Seakale, per bkt.	2	0	2	6
Endive, dozen	1	0	0	0	Shallots, per lb.	0	3	0	0
Herbs, bunch	0	2	0	0	Spinach, bushel	5	0	6	0
Leeks, bunch	0	2	0	0	Tomatoes, per lb.	0	6	0	8
Lettuce, dozen	2	0	2	6	Turnips, bunch	0	0	0	4

FRUIT.

	s.	d.	s.	d.		s.	d.	s.	d.
Apples, ½ sieve	1	6	0	0	Lemons, case	15	0	20	0
" Nova Scotia and Canada, per barrel	15	0	26	0	Melons, each	0	0	0	0
Rapes, per lb.	1	6	8	6	Oranges, per 100	4	0	9	0
entish Cobs	45	0	50	0	St. Michael Pines, each	2	0	8	0
					Strawberries, per lb.	0	0	0	0

AVERAGE WHOLESALE PRICES.

CUT FLOWERS.

	s.	d.	s.	d.		s.	d.	s.	d.
Arum Lilies, 12 blooms	2	0	4	0	Marguerites, 12 bunches	4	0	8	0
Azalea doz. sprays	6	1	0	0	Mignonette, 12 bunches	3	0	6	0
Bouvardias, bunch	1	0	1	6	Mimosa (French), per bunch	1	0	2	0
Camellia, white, per doz.	2	0	4	0	Narciss (Paper-white), French, doz. bunches	3	0	6	0
" red	1	0	1	6	Do. Do. English, per bunch	0	9	1	0
Carnations, 12 blooms	1	0	2	6	Pelargoniums, 12 trusses	1	0	1	6
Christmas Roses, dozen blooms	0	6	1	0	" scarlet, 12 bnchs	8	0	12	0
Chrysanthemum	0	0	0	0	Poinsettia, dozen blooms	3	0	6	0
Cyclamen, doz. blooms	0	3	0	6	Primula (double) 12 sprays	0	6	1	0
Daffodils, doz. blooms	1	0	2	0	Roses (indoor), dozen	0	6	1	6
Epiphyllum, doz. blooms	0	0	0	0	" Red (English) per bloom	1	0	1	6
Eucharis, dozen	3	0	6	0	" Red, 12 blz. (Fench.)	2	0	4	0
Gardenias, each	0	9	1	6	" Tea, white, dozen	1	0	3	0
Hyacinths (Roman), doz. sprays	0	6	1	0	" Yellow, dozen	3	0	9	0
Hyacinth, Roman (French) doz. bunches	1	0	2	0	Snowdrops, doz. bunches	1	0	3	0
Lapageria, 12 blooms	2	0	4	0	Spiraea, per bunch	0	9	1	0
Lilac (French) per bunch	4	0	6	0	Tuberose, 12 blooms	1	6	2	6
Lilium longiflorum, 12 blooms	6	0	9	0	Tulips, per dozen	1	0	2	0
Lily of the Valley, dozen sprays	0	6	1	0	Violets (Parme), per bch.	2	6	3	6
Maidenhair Fern, dozen bunches	4	0	9	0	" (dark), per bch.	1	0	2	0
					" (English), doz. buch	1	0	2	0
					Wallflower, doz. bunches	1	6	2	6

PLANTS IN POTS.

	s.	d.	s.	d.		s.	d.	s.	d.
Aralia Sieboldi, dozen	6	0	12	0	Foliage plants, var., each	2	0	10	0
Arbor Vita (golden) doz.	6	0	8	0	Genista, per doz.	9	0	18	0
Azalea, per plant	2	0	3	6	Hyacinths, doz. pots	6	0	9	0
Cineraria, per doz.	8	0	10	0	Lily of the Valley, per pot	1	0	2	0
Cyclamens, per doz.	9	0	24	0	Marguerite Daisy, dozen	6	0	12	0
Dielytra spectabilis, per dozen	9	0	18	0	Mignonette, per dozen	4	0	6	0
Dracena terminalis, doz.	24	0	42	0	Myrtles, dozen	6	0	12	0
" viridis, dozen	12	0	24	0	Palms, in var., each	2	6	21	0
Erica, various, dozen	12	0	18	0	Pelargoniums, per doz.	0	0	0	0
Eunonymus, var., dozen	6	0	18	0	Poinsettia, per doz.	0	0	0	0
Evergreens, in var., dozen	6	0	24	0	Primula sitchensis, per doz.	4	0	6	0
Ferns, in variety, dozen	4	0	18	0	Solanums, per doz.	9	0	12	0
Ficus elastica, each	1	6	7	0	Spiraea, per doz.	10	0	18	0
					Tulips, dozen pots	6	0	8	0



SHELTER FOR LIVE STOCK.

HAS the hard winter left behind it "a heritage of woe" to farmers in the guise of disease, exhaustion, or absolute losses among their live stock? We know it has on many a farm where the provision of shelter is inadequate for reasonable requirements, or where the buildings are faulty either in design or construction, or both. It is true enough that even with proper shelter animals are lost through mismanagement, but that is the farmer's affair, just as much as the provision of shelter is the joint concern of himself and his landlord. It is a matter wherein both should see their interest so thoroughly that there should be no hesitation or misunderstanding about it.

Imppecunious landlords are so numerous now that with their new farm buildings are out of the question. We may remind them, however, that very much may often be done for the tenant's aid and convenience by alterations and slight additions to old buildings. On large estates the agent or clerk of works should be able to suggest and arrange many useful contrivances, and this will be done when practical knowledge is tempered by discretion and sound judgment. Well aware are we of the unfair, unreasonable demands of many tenants, but they should at least be heard with courtesy and treated with fairness. Shelter is a matter of such importance to tenants that something more should be done by them than calling to Jupiter for aid. Since hedges have been left to grow wild so generally they afford an ample supply of materials for the contrivance of rough and ready hovels, which if only made in the literal sense of an open shed may yet afford protection to cattle from rain, wind, and snow, and so prevent the loss of many a valuable animal. Far better would it be to do this than to suffer whole herds of dairy cows and store cattle to be out in all weather with no other shelter than hedges or trees. A heavy bill of

mortality would be forthcoming if it were possible to ascertain the number of cattle lost at midland dairy farms during the last two months. It is hardly possible to visit any of those farms without hearing of occasional losses taken quite as a matter of course. At a farm near Melton Mowbray two stirks were lost before the cold weather set in from exposure to the chill blasts and colder rain of November, and there have been three cases of abortion since the long spell of frost and snow to which the cows were fully exposed. From thirty to forty cows are kept at the farm, and the farmer is naturally anxious about the remainder of them; but he does not appear to regard exposure as the cause of the abortion, although he is unable to give any other reason for it.

To those having adequate means of shelter it is worth while saying now, Have you found your buildings really efficient in the long hard winter? Are they free from draughts, yet well ventilated? Remember that the heat from the bodies of cows or horses causes circulation of air in the building, the warm air ascending and displacing cold air, which descends among the cattle. If there is roof ventilation no harm is done; if not, the air becomes foul, and if this goes on steadily throughout the winter, can we wonder that it at length brings disease in its train? For such shelter to be really wholesome and efficient there must be louvres in the roof ridge, and also eave openings, but no draughts below the eaves. The animals will then be quite as warm as is good for them, and they will always breathe pure air, which is fully as important to them as pure water and wholesome food. Never shall we forget entering a stable one winter's night at ten o'clock, in which about a dozen horses after being driven fast from a distance, had been shut in closely for some three hours. There were ridge louvres, but with shutters at the bottom, which had been closed, as we were told, because it was a cold night, and the air had consequently become so foul that we were glad to beat a hasty retreat. The lesson was useful, for in the numerous stables we have built since then the openings of roof ventilators have been made so that no rain or snow could enter, and no shutter or means of closing them has been fixed to any of them.

With an open roof light in abundance may be had in the cheapest way by means of a few rows of Hartley's rough plate glass, cut to the size of roofing slates, and fixed upon the roof in the same manner as the slates are, thus avoiding all outlay for windows and frames, which must be had when there is a loft overhead, in which case there are two points worthy of attention—to have no windows to open and no ceiling or anything but a substantial tongued floor between the cowhouse and loft. A double floor or ceiling means a harbour of refuge for rats and mice.

We have had so much disease among pigs from foul litter that we have decided to use no more litter for bedding. A clean hard floor in a snug well ventilated and commodious building is all they require. Thorough cleanliness and a wholesome mixed dietary—dairy feeding, if the term is liked, and no litter, appears to answer best for pigs large and small. Certainly there is no risk of fever among pigs so treated, provided they are kept from contact with any other pigs which are brought to the farm.

WORK ON THE HOME FARM.

Never have spring Beans been sown better than in this remarkable month of February; seldom so well, and Pea-sowing for "podders" on the heavy Essex clays has been done with such ease and expedition as is known usually only to light-land farmers. Wind and sun have certainly favoured us for all such work, and also for the lambing. The soil crumbles under the harrows to a pleasant degree of fineness. Everything has favoured such a condition of soil—six weeks of perfect autumn weather, a long hard frost at the right time, and now fine dry open weather. The only drawback is the rotting of Turnips left out in the open for folding. Luckily, we have an excellent store of roots in clamp, and a fair proportion placed together thickly in rows with soil ploughed over; but even the late Swedes left out for the ewes and lambs have been so frostbitten that tops and bottoms are dead, and the roots have lost much in quantity. Should rottenness set in now it will be quite unsafe to fold upon them, as it would be certain to cause scouring and loss among the lambs.

Having the possibility of this in view, it will be advisable to withhold roots from horses and cattle as much as possible, and to use

silage as a substitute. Complaints are rife of fast-diminishing hayricks, and of having to purchase hay on dairy farms, and the emergency may help to enforce the value of silage better than anything else can do. Certainly the man who has a plentiful supply of it is practically independent of roots, and is not anxious about the price of hay, which, by the way, keeps low. This is, doubtless, owing to the large quantity of excellent 1889 hay still unused, and which was advisedly held over for a market.

Let not the lessons of the late summer drought of last year be forgotten, and let successional crops of spring Tares be sown in rich soil, so as to ensure vigorous growth and comparative immunity from drought; also, wherever it is possible, increase the area of land under Lucerne. If sown early it will come into use this year at the critical time when green crops are often scarce. Let, also, a field of green Maize enter into every farming scheme south of the Trent. The sowing need not be done till the end of May; but it is well to see one's way for the ensuing season now, and to make due provision for a crop that gives more weight of wholesome green food per acre than any other. We are not even forgetful of the weight of Rye Grass obtained on sewage farms, for Maize 10 and 12 feet high is no uncommon thing when sewage is used for it.

HOGG AND WOOD'S SEED REPORT FOR 1891.

As usual with us at this period of the year we have pleasure in submitting our annual seed report on the probable supplies of farm seeds for the coming season, and are sorry that the prospect of an abundant yield has not been realised to the same extent as in some recent years.

English and Welsh Red Clover and Cow Grass or Perennial Red Clover.—The crop of these is reported as under an average, and bold, large grained seeds of good colour are scarce, and correspondingly higher in price than last year.

Foreign Red Clover.—On the continent of Europe and America the reports state the yield to be very small, and instead of exporting some of the districts are buying to supply their own requirements. Rates will be somewhat higher than those current in 1890.

White Clover.—This is reported to be a poor crop in all the producing countries, and prices will be somewhat higher than those of last year.

Alsike Clover.—The smallest crop for many years is reported, and high prices are likely to rule. Inferior samples are very full of weed seeds, and we would advise the use of the higher class qualities.

Trefoil or Yellow Clover.—Crop much below an average both at home and abroad, and rates considerably in advance of those of last year, which will doubtless lead farmers to use less of this variety and increase their quantities of Red Clover.

Perennial and Italian Rye Grass.—The yield of Italian is fair, but of Perennial very short; and prices of the latter, although still moderate, are much above those of the past season, which were exceptionally low. In both cases the quality is good.

Timothy, Cocksfoot, and other natural Grasses are reported to have yielded a small crop, and prices will exceed those current last year, but they are still very reasonable. Timothy, Cocksfoot, and Meadow Fescue continue in favour, and are extensively used by farmers for two and three years' pasture along with the usual mixture.

Tares.—Large Scotch and foreign are expected to be abundant, and prices moderate.

Turnips and Mangolds.—The yield of these varied very greatly in the different growing districts, and some sorts are in short supply, meantime prices remain similar to those of recent years.—HOGG & WOOD, *Coldstream.*

METEOROLOGICAL OBSERVATIONS.

CAMDEN SQUARE, LONDON.

Lat. 51° 32' 40" N.; Long. 0° 8' 0" W.; Altitude, 111 feet.

DATE.	9 A.M.					IN THE DAY.				Rain
	Barometer at 32° and Sea Level.	Hygrometer.		Direction of Wind.	Temp. of soil at 1 foot.	Shade Temperature.		Radiation Temperature.		
		Dry.	Wet.			Max.	Min.	In sun.	On grass	
1891.	Inches.	deg.	deg.	deg.	deg.	deg.	deg.	deg.	deg.	In.
February.										
Sunday	30.645	41.8	40.4	N.W.	33.4	51.8	38.2	74.9	37.5	—
Monday	30.665	34.7	34.7	W.	38.4	51.5	32.2	78.9	28.4	—
Tuesday	30.697	34.1	34.1	N.E.	37.9	39.9	32.1	42.6	26.2	—
Wednesday ..	30.703	31.2	31.2	N.E.	36.9	45.1	29.4	61.4	22.9	—
Thursday	30.594	32.6	32.4	N.E.	33.3	36.2	28.2	41.4	26.9	—
Friday	30.411	33.3	33.2	E.	36.4	38.4	31.9	48.9	32.8	—
Saturday	30.333	30.3	20.3	E.	36.6	36.7	29.0	38.8	30.8	—
	30.535	34.0	33.8		37.3	42.8	31.6	55.3	29.1	—

REMARKS.

15th.—A beautiful spring day, mild and bright throughout; clear night.
16th.—Clear and cold early, slight fog between 8 and 10 A.M., followed by an almost cloudless day.
17th.—Fog all day, generally dense.
18th.—Fog all the morning, then sun for two or three hours, and fog again in evening.
19th.—Overcast all day; wet mist till 11 A.M.
20th.—Generally overcast, with wet mist morning and evening, but a little sun in afternoon.
21st.—Wet mist all the morning, and again in evening; overcast afternoon.
A cold and foggy week, with an exceptionally high barometer, and no rain.—G. J. SYMONS.



“HAVING almost completed the erection of a range of glass for fruit culture chiefly, I am not satisfied about the best method of heating the houses. I do not ask which is the ‘best boiler,’ as I have more than one kind already, and I am not able to say there is a ‘best’ among them. It is not a question of boiler, but of arranging the pipes, on which I seek information. The pipes in existing houses are arranged in a ‘stack’ along the front. My gardener says he would like those in the new houses ‘spread out more,’ as at present he has ‘too much heat in one place.’ I think there is something in what he says, but shall be glad if you can publish the experience of some gardener who has given what I may call the ‘spreading out plan’ a fair trial and found it satisfactory, or rather, I should say, more satisfactory than the orthodox method of arrangement.” Thus writes a correspondent, and it so happens that what appears to be the exact information needed has also come to hand this week in the following communication. As the subject is important we give it prominence, and though we know the system advocated answers admirably, we are bound also to observe that some of the finest fruit in the kingdom is grown in houses that are heated, as he describes, in the “most objectionable” way. “Heating Reformer” writes:—

“At this time of year many persons are busy erecting new glass houses for the production of fruit, and it is a good opportunity to consider the best mode of arranging hot-water pipes. The most objectionable though still a common plan is, in the case of vineries, to have the hot-water pipes close together along the front of the house just over the surface of the border; say, if four pipes are employed, placing two upon two, or if in a larger house, three pipes over three others. This plan may be carried out for the sake of appearance or convenience in the house, or a stage may be erected over the pipes upon which plants are to be grown. As far as the welfare of the Vines is concerned the arrangement is bad, because the heat which is meant to be spread over the whole of the vinery is concentrated in one place underneath the Vines along the front of the house, which causes that part to be at least 10° hotter than the other parts farthest from the pipes. Seldom do Vines growing in a house heated in this manner escape an attack of red spider, for the heat at times arising from the pipes is excessive, causing the air to become dry. Pipes arranged in this manner also often dry the surface of the border far more quickly than is good for the roots. I have seen many of the bunches which hang over the hot-water pipes spoiled owing to so many of the berries being “rusted,” caused by strong heat immediately underneath them when the Vines were in bloom. Especially will the berries be liable to be rusted if much moisture arises from the pipes owing to the presence of plants on stages over them.

“I will now give my opinion as to the best means of averting the evils named. Presuming a house which is 18 feet wide, or 2 or 3 feet less, is intended to be a vinery in which the Grapes are to be ripe at the end of June, six rows of hot-water pipes would not be too many to maintain the necessary temperatures during the various stages of growth. It is misplaced economy to have too few pipes; the consumption of fuel is sure to be greater where the pipes are limited, it being necessary to maintain them hotter than if there were a greater radiating heat surface. Instead of placing

these six pipes together at the front of the house they should be spread over the border at a distance of 2 feet apart. The first pipe being fixed close to the front wall and just below the sill of the woodwork of the front ventilators. The heat will then be equalised throughout the whole house in a much more useful manner than by the method previously named.

“Another advantage gained by this arrangement is that the moisture arising from the evaporating troughs will be more evenly distributed to the Vines, as the troughs can be arranged on alternate pipes starting at the second from the front. They should not be placed opposite each other, but in alternate spaces. If the evaporating troughs are 6 feet long they will emit a good supply of moisture. Five of these six pipes should be flow pipes, being connected at one end with a pipe across the border with angular connections, which admits of a rapid and regular circulation. One return pipe is sufficient to convey the water back again into the main pipe for transmission to the boiler. Where the five flow pipes are taken direct from one source the circulation is much more rapid and even than where the supply is taken by two flow pipes, for instance, the length of the house, returned, and again carried round without any connection, as is sometimes the case. Light abutting pillars built in the wall at each end to carry the cross pipes and one or two light wrought iron I-shaped girders let 3 inches into the front wall of the vinery and supported on the retaining wall at the outside of the border, or a 9-inch brick built pier put up to secure the opposite end of the girder, will be sufficient support in the middle of the border for the hot-water pipes, and no interference with the Vine border will be needed. The pipes will require but little rise to make the water circulate freely; 1 inch in 24 feet is sufficient provided the main from which the vinery pipes is taken is well arranged in that respect.

“Where other houses besides the vinery are heated from the same boiler it is wise to have a separate main running behind the houses, so that the connection for each house can be made with the main, both flow and return, independent of any other house. If both flow and return pipes in the vinery, for instance, are fitted with watertight valves the heat is thoroughly at command at all times, and in the case of a breakdown in any other part of the heating arrangement, it is necessary to drain the water from the boiler and mains, the water in the pipes in the vinery may be saved, which in some situations is a gain. If both flow and return pipes are not fitted with valves the heat in the vinery is not nearly so well under command, as it will “back up” through the return pipe when the circulation is cut off by the valve on the flow pipe being closed.

“In the case of heating a Peach house in which the fruit is not required before the middle of June three rows of hot-water pipes will be sufficient to maintain the desired heat. If the house is fitted with a curved trellis at the front of the house, the trees planted say 2 feet 6 inches from the front lights, two rows of pipes may be laid parallel to each other on the level close to the front wall and immediately underneath the front lights, with a view to warming the air coming through the ventilators, as in the vinery. These two pipes may both be flows, connecting at the end from the single flow pipe from the boiler. The third pipe in the Peach house will be the return, which will provide ample heat for Peaches except the house be in a very much exposed situation. Where possible the air-pipes should be self-acting, one to each house being sufficient, selecting the highest point in the flow pipe, where the air is sure to collect if at any time the pipes are not full of water. Some persons have taps fitted to the air-pipes. This is a mistake, as they are likely to be forgotten at times. The air accumulates, the circulation of the water is checked, and consequently the heat is lessened. Self-acting air-pipes may be fixed into the top of the pipe, that part being either half-inch iron or copper pipe for at least 2 feet above the pipes, which is better than lead or, what is more generally used, a composite metal; it is soft,

easily bent, and more readily fixed round rafters or angles of the wall than iron or copper. Either of the latter, though, are better for the base, as they are not so likely to be bent or injured by attention to the Vines or the border. The composite pipe is easily connected to the iron one by means of soldering."

BUSH AND PYRAMID PEAR TREES.

PEARS with us last season were exceptionally good in size, quality, and appearance; the continuous hot sun of September and October ripened both fruit and wood splendidly. Many are of opinion that Pears can only be grown successfully on walls in the Midlands; but that is not my experience, as our pyramid and bush trees, with few exceptions, carry full crops every year, and unless the season is exceptionally wet and dull they ripen well with good flavour. Of course, the trees have garden culture, and are somewhat sheltered with high walls, and care is taken to prevent the roots from penetrating our stiff clay. We also incorporate about a third of finely sifted ballast with the natural earth, and that greatly increases the porosity of the soil and encourages fibrous roots. The branches are thinly disposed, and no bifurcations are allowed. The sun and air is thus freely admitted, which greatly facilitates the ripening of both wood and fruit. Only on lines such as these could we grow eatable Pears on pyramid trees in this cold district and on our impervious clay. The roots must feel the warmth of the sun as well as the branches, or the tree will not properly ripen its fruit, and this is secured by careful root-pruning and surface feeding. In Pear and other fruit culture an equal balance between root and branches must be striven for, and useless growth prevented. The sterility of many fruit trees can be traced entirely to the violation of this fundamental principle.

If the roots are allowed to penetrate a cold wet subsoil the trees can only produce strong unhealthy shoots that do not ripen, and when these shoots are cut off, as they frequently are, the evil is only aggravated. By this baneful practice the balance between root and branch is destroyed; the superabundant roots have to direct their force on fewer eyes, and the result is stronger and more abundant shoots. I remember seeing some barren Apple trees that had been subjected to this treatment, presumably "to keep them within bounds," rendered fruitful by simply allowing the strong shoots to remain full length, and cutting out entirely those shoots that crowded the tree. There are, doubtless, many sterile Pear trees that only require similar treatment to render them fertile. The strong shoots should be left full length and thinly disposed. This would induce a more tardy circulation of sap, and result in the formation of fruit spurs. Every gardener delights in a well formed tree, but shape and size should be made subservient to fruitfulness. To restrict the growth of a tree and at the same time secure its fertility, the knife should be chiefly used at its roots and not much at its branches.

The following are some of the varieties we grow as bush and pyramids:—Colmar d'Été.—This is a small Pear, averaging from six to eight to the pound. It is a constant bearer, ripens early in September, and is very sweet and juicy. It is grafted on the Pear stock, and forms naturally handsome pyramids.

Williams' Bon Chrétien is well known handsome Pear. Our crop of it last season was exceptionally good, being very clean and ripened well. The fruit, however, from pyramids is never so large as from walls, they average three to the pound. The trees, although grafted on the Quince, make long, strong shoots, which are clothed their full length with spurs, and they usually carry a full crop of fruit. The great drawback of this fine Pear is that it will not keep long, hence only a few trees of it should be planted for private use. Our main crop was gathered September 18th.

Beurré d'Amanlis is a great favourite with us, even more so than Bon Chrétien. It has not failed to carry good crops the last eight years, and the fruit invariably ripens well. We sometimes have fruits half a pound each, but they average a little under three to the pound. They begin to ripen with us early in October, and being, for an autumn Pear, a good keeper, they can be had in use for four weeks with a little management. The trees are on the Quince stock and make fairly strong growth, but it does not form a good pyramid, the branches having a horizontal and sometimes a downward tendency.

Comte de Lamy is a small but most delicious Pear, a constant bearer, and in use all through November. They are worked on the Pear stock, and are weak and rather sprawly growers.

Beurré Diel.—This variety bears well with us as pyramids, but the fruits are not large, averaging four to the pound. They ripen well, and are exceedingly useful from middle of November to the end of December. The trees are on the Quince, grow moderately strong, and make good pyramids. Winter Nelis is, without doubt,

one of the richest flavoured Pears in cultivation. It does well with us as pyramids, and is our chief Pear for January and early part of February. The trees are on the Pear stock, but the growth is weak and the fruit small, averaging eight to the pound. Fondante de Noël bears well, ripens in February and March, but the flavour is little better than that of a Turnip.

Duchesse d'Angoulême and Nouveau Poiteau both form handsome pyramids, but they bloom too early, and on that account seldom carry a crop of fruit.

Easter Beurré and Knight's Monarch bear well, but the former has no flavour, and the latter never ripens; these are, therefore, used for stewing purposes.

Marie Louise and Hacon's Incomparable bear too seldom as pyramids to be profitable. The latter, however, is a fine Pear and of good flavour, being useful through December and January.—
J. H. W.

THE CULTURE OF SALVIAS.

SALVIAS, when well grown, rank amongst the most useful of our autumn-flowering plants. At the present time the varieties are so good that it is a great wonder they are not more extensively grown when we take into consideration that their culture is of the easiest. The colours of the flowers are so varied as to make very pleasing combinations; many of them possess pretty foliage, and they come into bloom at a time when flowers are eagerly sought after. As regards their cultivation, anyone can succeed in growing them. Cuttings will be plentiful now on the old plants, and may be taken at once. Fill some 4-inch pots with a compost of any light soil, and give a surfacing of silver sand. After preparing the cuttings insert three or four in each pot and give sufficient water to moisten the soil. Place the pots in a close propagating frame, or those not having one will experience no difficulty in striking the cuttings in any warm house.

As soon as they are rooted place them singly in small pots, or if larger plants are required three plants may be grown in one pot, using a compost of loam and leaf mould in equal portions, a little well-decayed manure and silver sand sufficient to render the whole sweet, and keep them steadily growing. When the young plants have attained a height of 6 inches pinch out the points so as to induce a bushy habit of growth. As the pots become full of roots shift the plants into a 6-inch size, using a little less leaf mould in the compost than before recommended. Particular care should be taken in not allowing the plants to become root-bound previous to this potting, as if this occurs the growth is never so satisfactory, and flowers are never of such fine quality. About the end of May they may be removed into cool frames, and if syringed twice a day the foliage will be kept in a healthy condition. If the frames are required the plants may be removed into the open air, as they will not suffer if all danger of frost and cutting winds is over.

The last pinching should take place at the middle or end of June, and the plants kept neatly staked. As the pots become filled with roots weak applications of liquid manure should be given at intervals. This will be found of the greatest possible benefit in building up fine strong flower spikes. During the latter part of September remove them to a greenhouse or conservatory, when they will commence flowering immediately, and last during the earlier portion of the winter. We also secure good results by potting some of the old plants. The flowers are not quite so good, but the plants attain a large size. This especially is the case with *Salvia splendens*. The following varieties are all useful for a greenhouse, but any good nurseryman would make a selection. *Albo-cærulea*, *Betheli*, *Grahami*, *Heeri* (a rather tall grower, but most useful for grouping), *Mons. Issanchon*, *Pitcheri* (a lovely blue), *rutilans* (a neat-growing useful variety, sweetly scented), and *splendens*. Of the variety *Grahami*, I may mention that the finest plants I ever saw were grown by Mr. Day, the able gardener at Galloway House, Garlieston, Scotland, some four years ago.—
R. P. R.

BARBE DE CAPUCIN SALAD.

BY forcing it in winter in darkness the common Chicory yields a winter salad known under the name of Barbe de Capucin, which is very much esteemed in Paris. To produce it the seed is sown thinly in the open ground from April to June. At the beginning of winter the roots are taken up, and after cutting off their leaves about half an inch above the neck they are placed horizontally on sloping heaps, composed of alternate layers of sand or soil, and of Chicory roots. The latter, of course, should have the necks pointing outwards to induce a free growth of the leaves. Give a gentle watering if the soil used is rather dry, and supposing the temperature not to be too low, you may look for a crop of fine shoots, 10 inches long, in about three weeks from planting.

Our market growers sow the common Chicory broadcast, rather thinly towards the end of March or the beginning of April, in the open ground. During the summer they sometimes sell the leaves to the herborists. In October they take up the roots to start them into growth in cellars, and they continue doing so during November, December, and even January. The roots are brought in, and after having cut off their leaves near the collar, they are made into bundles measuring about 13 inches in diameter, taking care that all necks be at the same level. During that time the growers have prepared in a very dark cellar a layer of horse manure, 10 to 12 inches deep; no soil or compost is placed over that bed, but a first row of these large bundles is set on it in an upright position against the wall, then a second row against the first, a third against the second, and so on, leaving the least spare room possible. There remains usually only a small path in the cellar, just wide enough for the work.

In twenty to twenty-two days the roots of these bundles will give us a crop of narrow leaves, 10 to 12 inches long, of a clean white colour. The bundles are then brought to the light, divided into six to eight smaller ones, each containing some hundred roots with their leaves on, and are fastened with an osier. In that state they are brought to the market (under the name of Barbe de Capucin) from the end of October until the end of January, when it is replaced by the Lettuce.—EUG. SCHAEFFEL, *Paris*.



DEATH OF MR. WILLIAM MARSDEN.

ONE of the oldest and most successful amateur Orchid growers of this district has passed away in the person of Mr. William Marsden of Bloomfield, near Bolton, at the ripe old age of eighty-four years. Mr. Marsden, with his brother James (who died some three years ago), belonged to a firm of brass founders in the town, and as neither married they lived together, their only hobby seemed to be the cultivation of Orchids. Retiring from business some twenty years ago they built the beautiful residence of Bloomfield, and made special preparation for a collection of Orchids, to the care of which they devoted the whole of their time, anyone interested in the cultivation of Orchids being always welcome to have a peep at the treasures stored in the houses of Bloomfield. I had the opportunity of looking through only a few weeks since, and the plants looked the picture of health and cleanliness, and reflected great credit to the gardener, Mr. J. Wicks, and his staff.—J. H., *Bolton*.

A WARNING.

UNDER the head of "Jottings," Mr. Lewis Castle, commenting on Mr. Young's letter concerning the employment of leaves and other fermenting materials, wisely points out the principal objection to the use of leaves in Orchid houses. The question of insects is a very important one, and may result in an endless amount of labour and annoyance through using these materials. If there are any woodlice on the place, my advice is, Do not use them. In leaves and such material woodlice increase so rapidly that they are capable of devouring nearly every plant they find. I have been contending with these pests for a whole season in two houses in which litter and leaves have been employed. An attempt had been made to exterminate them, but in a few months they were as numerous as ever. If growers want their Orchid spikes devoured and the tender roots destroyed, they cannot do better than place leaves in the houses.

A few years ago there was a demand for leaves in Orchid houses, and those who urged their employment most strongly were, in some instances, the first to discontinue the practice. It looks to me much like going back to the days when these materials were used mainly for supplementing the heat. To prepare leaves in a suitable manner for placing in these structures, the wheeling in and out again entails a good deal of labour that cannot well be spared in many gardens if things can be well done without. If Orchids need "manurial assistance," cannot it be applied by a less expensive method? I do not dispute that these plants can be stimulated, their appearance changed, and the size of their pseudo-bulbs increased; but do these methods of culture add to the longevity of the plants? Is it not possible to overgrow them, and thus shorten the length of their existence?

There is another matter worth consideration, and that is, all houses are not constructed in such a manner that leaves and other materials of a similar nature can be used without proving offensive. In perhaps the majority of the houses used for these plants leaves would present an untidy appearance, and would on this account be strongly objected to. In private gardens, at any rate, appearances must be considered, and I do not think the trade will long follow, even if they start, the practice that has been advised, simply because it will prove too costly.—WM. BARDNEY.

TOUCHED BY THE STEEL; OR, THE SLAUGHTER OF THE INNOCENTS.

WE can only judge darkly as yet of the effects of a severe winter and the prospects of a late spring, so dense have been the fogs of the last few days, so chilling

The envious sneaking frost
That bites the first-born infants of the spring.

After the snows left us and the long great frost broke up, now and again came a day of rare warmth and brightness, when one might work and plan, aye, and notice too, that so far things seemed healthy of late. Fruit trees were bristling with buds, bulbs breaking bravely upwards through the heavy but by no means very saturated earth; patches of Snowdrops whiten the borders, Crocuses gleam in the grass. And the Rose trees. Teas as well as hybrids show only reasonable signs of rosy vitality, regarded as they are now with greater hope and interest, because a Chestnut tree which had too long shaded a corner of our small rosery and darkened our windows has at length been removed.

Not all the aggressors had fallen, however; one, a Lime tree, a favourite from associations as well as from its fragrance when in flower, was still too near the generous soil its roots were always seeking to share; year after year throwing into the midst of our Rose beds dense masses of fine fibrous rootlets, making a drought wherever they went, and but little restrained by the frequent cutting-in of the leading fangs close to the beds.

The war must be carried on nearer the camp on the other side of the walk. The grass edging was to be lifted, and all along the sides the offending roots were to be divided, say about a distance of 12 feet from the nearest beds, leaving the Lime tree roots unmolested in the border to the length of 6 feet or more, where over them close up to the trunk of the tree reposed in order and by name a small collection of Daffodils, dear as Daffodils are to those who care for them and watch for their first appearing.

Easy to anticipate the sequel. Urgent business prevented my remaining to superintend the operation. My man was handy, intelligent, and light of foot; he understood everything. My mission was meantime disappointing. I returned, but had I not something to lighten and refresh me? I should be in time to help. All was over; my man was standing at ease leaning on a rake, a basket of *débris* by him. The mould had been disturbed, chips were about, more had been taken off. It was quicker work to step on the border nearly close up to the tree, open the ground a little way, and then amputate the offending roots. Alas! and alas! Who can tell how many unborn flowers may not have perished—how many innocents executed? I gathered up the fragments with a heavy heart, the mischief was done all unintentionally. I shall not know for a while what is left. The Roses may be richer, but the Daffodils in many cases have been, I fear, done to death. How I shall miss them and mourn their fate can easily be understood.—A. M. B., *Mid-Lincoln*.

REMOVING FLOWER BUDS OF PEACHES.

A CAUTION.

THERE is some danger of mischief following a too rigid adherence to rule in carrying out this practice. The principle on which it is based is sound, as everyone who has succeeded, in some degree at least, in the production of large blooms of any given plant fully understands, for the fewer the flowers left on a plant the larger, all things being equal, will be those remaining to develop. But in the case of Peaches there are, I venture to think, one or two circumstances which ought to be duly considered by cultivators before too hastily packing the whole of their eggs in so small a basket.

The first point is partly theoretical. Growers with an intelligent grasp of the subject are so well assured of the bearing which the previous season's treatment exerts on the current season's production of normally healthy and perfect flowers that this forms a most important item in the successful management of Peach trees. No more young growth than will fill the place of exhausted

shoots is allowed to remain, and directly the fruit has ripened and been removed these exhausted shoots are cut out. The result is that the energies of the tree are completely absorbed in the production of flower buds on the comparatively few growths which are left, and, as practice has proved, the tree performs its work so well that a crop may be counted on with an almost unfailing certainty.

The proper time, therefore, to relieve the tree after the buds have been formed would be at the earliest stage possible, and not when they are well forward, for the mere opening of the buds into flower and the production of pollen is not a matter of much importance. No doubt directly the fertilisation of the ovule has been consummated a strain is placed on the powers of the tree, and the sooner extra fruit is cleared off the better; but immediately previous to flowering the benefit cannot be anything great.

The other point I wish to notice to this. Numbers of Peaches are not accorded the treatment described above. It is perhaps the exception rather than the rule. This of course should not be so, and, indeed, it may be safely affirmed that wasteful of the energies of the tree as the practice of overcrowding is, it is equally wasteful of time to the cultivator. However, the fact remains that Peach houses in numbers are filled with trees which annually have an unnecessary quantity of young growths laid in, much of which, along with the exhausted bearing shoots, is removed, not at the time the crop is ready, but some time during the season of the tree's annual rest. It is no uncommon occurrence for trees cultivated in this manner to set very thin crops, not because there are no flowers, but because the greater number of these are abortive or deficient in energy in some one or more of the parts of fructification. Now if it were possible to determine "which is which" before the buds open, the practice of disbudding might be of some benefit here, but that is impossible before the flower has opened. And so we arrive at this point, that in all such cases the danger of removing perfectly equipped floral organs is so great that any compensating advantages that might be gained cannot fairly be assumed to have any practical importance.

The only matter which I will further refer to is the bearing this practice has on the size of the fruit. This is the final test. It cannot, I think, be assumed that there is any taxing of the energies of the tree in producing flowers when a good method of cultivation has been followed. And in the case of carelessly managed trees, enough has been said to show the danger of the practice, but if the size of the fruit is to be appreciably increased, there would be some reason for embarking on a hazardous scheme. Personally I have given the practice a trial, and I discerned no difference, the fruit of course being thinned after setting at a very small size. I have not noticed anything extraordinary at shows either. There are sure to be some readers of the *Journal of Horticulture* who can say something definite on this phase of the question, either for or against.—B.

MELONS AND THEIR CULTURE.

[Read by Mr. W. PALMER, Thames Ditton, at a recent meeting of the Ealing and Chiswick Gardeners' Mutual Improvement Society.]

(Continued from page 167.)

EARLY Melons may, with advantage, be grown in pots under favourable conditions, using well drained Seakale or the ordinary 12-inch pots; these do not take up much room and the plants ripen fruit in advance of those planted out. The plants should only be allowed to carry one stem, and one or two fruits taken as required. The temperature of the house is also important, and should range in early spring from 65° to 70° at night, and from 75° to 80° in the daytime, raising it a little as the season advances, and also allowing it to rise and fall with the temperature out of doors. Air should at all times be judiciously given when the weather permits. Cucumbers may be grown in the same house as Melons where the space for both is limited, always reserving the south or sunny side for Melons, and using the syringe more on the Cucumbers than the Melons; in fact, where this is practised the Melons will hardly need syringing only where they come in close contact with the pipes, the moisture from the Cucumbers being sufficient. Some growers shade their Melons: but if Melons of first class flavour be required this practice should not be resorted to unless the leaves "flag" or "scorch;" then, of course, it is absolutely necessary. The fruits will be found most subject to the latter on a bright day after a period of dull weather. This may be prevented by putting a very light class of tiffany over them from 11 A.M. to 3 P.M., always removing it when the house is closed and syringed in the afternoon. When the Melons are about half grown the fruits will require support, a good plan being to make a network of bass round the fruit, making firm to the trellis, and allowing room for the fruit to swell. This plan I invariably follow;

using a net prepared for the purpose, and also a piece of wood 6 inches square with holes at the corners for strings, are other methods of support.

Late Melons are often grown with great success, without any fire-heat, in cool houses or brick pits on similar conditions to the above, but may be planted out straight from the 60-pots, and will also require much more water at the roots, as during the summer months, owing to the increased temperature outside, they dry up much quicker. A fine example of successful culture under this system may be seen in the gardens at Rood Ashton Park, under Mr. Miller's superintendence, there being for several years past grand crops of fruit ripened in an unheated house, this being noted some time back in the *Journal of Horticulture*. In brick frames I would advocate the bed being cleared out, wires put overhead similar to Melon houses, as in this way a more certain and better flavoured crop may be had. Melons are often grown in an ordinary box light, but rarely, only in bright seasons, with much success. When this has to be done the plants should be raised in the houses and grown in 5-inch pots before planting, the seed being sown two or three weeks before making up the beds, the preparation of which should be done with care, so as to retain the heat as long as possible in them. If dull, cold weather follows the planting out of the Melons the beds should be well lined on the outside; the foliage should never be allowed to become crowded, as Melons will not set freely unless the growths are thinly disposed.

II. SELECT LIST OF MELONS.—This at the present day is rather a hard task, as within the last few years many good varieties have been introduced, and I have often heard it said that every grower has his own favourite, so I propose to name only those I have tried myself, and the varieties I have known others try with good success. In green and white-fleshed varieties we have Hero of Lockinge, sent out by Messrs. Sutton & Sons of Reading. This I have no hesitation in classing as the king of Melons, as it is easy to grow, a free setter, of medium size, and a flavour pleasing to all. Good fruits of it are seldom beaten on the exhibition table; and if I were asked to name one Melon only, I should certainly name the above. Imperial Greenflesh, also sent out by the same firm; La Favourite, sent out by Messrs. Veitch; William Tillery, a great favourite with many; Best of All; High Cross Hybrid, a very hardy variety with a white skin; Monarch, a new one sent out by Messrs. Sutton last year, and Conqueror, a good market variety, it being a fine-looking Melon when ripe, of good flavour, and easy to grow. In scarlet-fleshed varieties we have that good old standard variety Scarlet Premier; Triumph, sent out by Messrs. Sutton last year, being a great improvement on the above variety. I do not hesitate to recommend it to all, having raised it some few years ago, and having for the last three years relied solely on it for my crops. It is of very hardy constitution, and without doubt one of the freest in cultivation, each lateral having one or more fruits at the first joint. It is also very thick in flesh, with a band of green on the outside, which gives it a pleasing appearance. The fruit is of a good flavour, and is well adapted for frame work. Carter's Blenheim Orange is a great favourite with many, and often seen at the head of the prize list for scarlet-fleshed varieties. Read's Scarlet Flesh is a good old favourite. In addition to these there is a host of others, some of which have lately been certificated by the Royal Horticultural Society, therefore should be good and worthy of a trial, though I have often thought that it would be a better way of judging a Melon if the Committee would see the variety twice before awarding it a certificate; as although many have received that distinction in the last six or seven years, they have not been good enough to lower the colours of such Melons as Hero of Lockinge and Blenheim Orange.

(To be continued.)

THE KEW OBSERVATORY.

A FEW weeks ago a complete record of the long frost as registered at the Kew Observatory was published in this *Journal*, and it was then intimated that further reference would shortly be made to that important institution. The opportunity has now presented itself for the fulfilment of the promise by furnishing an outline sketch of the history of the Observatory and the work there performed, which cannot fail to possess some interest to many horticulturists who are so closely concerned with meteorological observations.

Comparatively few visitors of the thousands who journey to Kew and Richmond yearly have the slightest knowledge of the whereabouts of the Observatory here described, and even those who have noticed the building in the Old Deer Park have little idea of

the special object of its existence. It is somewhat strange that although known for a long period as the Kew Observatory, it is not really in Kew, but in Richmond, and is in no respect a portion of, or even connected with, the Royal Gardens. There is no very direct means of communication with the high road, but the appended plan (fig. 33) indicates the position and approach for visitors who are furnished with the necessary admission orders obtainable on application by letter to the Committee. A few minutes' walk from the Richmond station conducts to the farm gate, and after a long walk across an open expanse of meadow land the low and unpretentious building (fig. 34) is reached standing upon slightly raised ground near the Thames.

The principal facts in the history of the Observatory are as follows. It was erected by order of George III. to enable observations to be taken of the transit of the planet Venus in 1769, and is believed to occupy a portion of a site of considerable historical interest. Somewhere in its immediate vicinity were the village of West Sheen, a Carthusian Priory, and the old Palace of Sheen, every trace of which has disappeared, as also has Richmond Lodge or House, with which were connected some extensive gardens famous in the time of George II. The institution was known as the King's or Royal Observatory, but gradually obtained the title of the Kew Observatory, the original of that name which stood near the Kew Palace having fallen into disuse. For seventy years it was employed for various scientific purposes, but in the meantime the Greenwich Observatory had grown in importance, and it was resolved to discontinue the maintenance of that at Kew. In 1842, therefore, it passed into the care of the British Association, and for thirty years the work was carried on under the supervision of a Committee appointed by that body. Then the expenses having become too heavy the Association resolved to give it up in 1872. Quoting from the official history, the result of this resolution was as follows:—

"At this critical period in the fortunes of the Observatory, Mr. J. P. Gassiot, who was then the zealous Chairman of the Kew Committee, made a munificent offer. He expressed himself ready to endow the Kew Observatory forthwith with a sum of £10,000 if the Royal Society would, on their part, consent to act as trustees, to apply for the use of the Observatory, and if it were granted to them to take it under their general charge, and to nominate a Kew Committee, who should have entire control over the management of the Observatory, and over the income from the trust fund, and

cause magnetic and meteorological observations to be continued in perpetuity. Mr. Gassiot's offer was accepted, and the trust deed was signed in 1871. The members of the Meteorological Council of the Royal Society were constituted the first members of the new

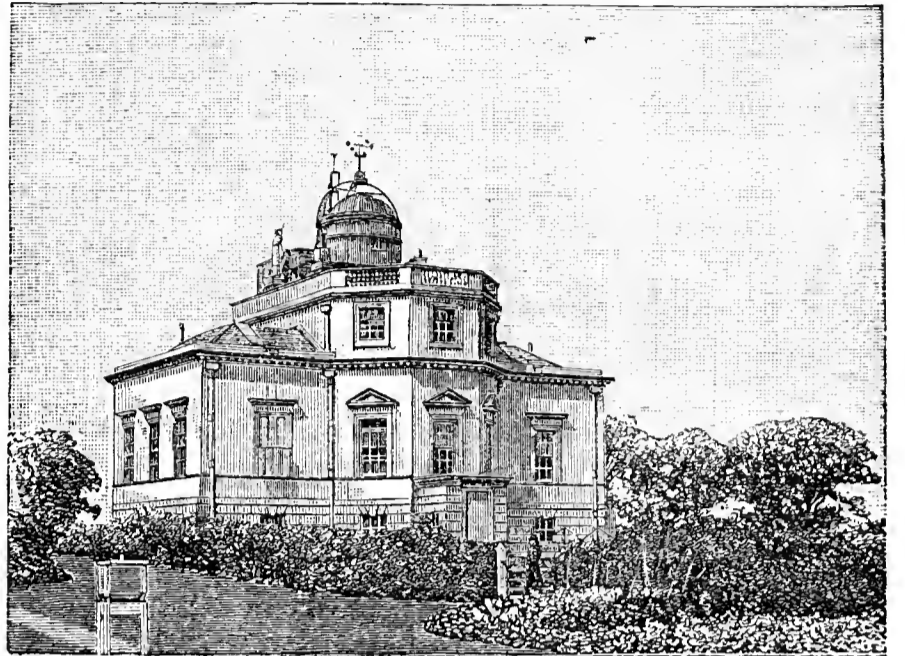

FIG. 34.—THE KEW OBSERVATORY.

Kew Committee (they had for the most part been members of the old one), and the management of the Observatory was then established upon the footing on which it now stands."

It will thus be seen that the Observatory is really a department of the Royal Society under the management of a Committee, with F. Galton, Esq., M.A., F.R.S., as Chairman, and G. M. Whipple, Esq., B.Sc., as Superintendent, who has a staff of experienced assistants to help in the multifarious and important duties of the establishment. The work consists of two kinds—first, in keeping an exact record of meteorological observations; barometrical pressure, temperature, rain, wind, sunshine, cloud, electricity, magnetism, all being noted with the greatest care, and by self-recording instruments of most ingenious construction, for the Institution also ranks amongst the first-class stations of the Meteorological Office, from which an allowance of £400 is granted for the purpose. The instruments employed, and the exactitude with which the work is performed, merit a full notice; but as it would be impossible without the aid of illustrations to convey a clear idea of the former by verbal descriptions they must be passed, with the remark that comparatively few horticulturists, except those who have made scientific meteorology a study, have any idea of the progress accomplished in recent years. The possibility of inaccuracy is reduced to a minimum, and the self-recording principle now applied to nearly every instrument employed in the work obviates the danger of errors either in observation or transcription, and saves much time. Whatever difference of opinion may exist respecting the value of meteorological observations generally, there can be none as to the importance of their being accurately recorded, also carelessness and unreliable instruments is responsible for many of the inconsistencies with which meteorological predictions have been charged. It has become a standing joke in the comic papers to refer to the meteorological warnings as noted for their uncertainty, whereas, as a matter of fact, which can be proved by the official charts and reports issued from time to time, a large percentage of these predictions have been verified by the weather subsequently experienced. The difficulty has been to obtain a sufficient number of stations where observations can be taken in the same manner as at Kew, and a few in the centre of the Atlantic Ocean (the origin of many of our weather disturbances), with telegraphic communication to Europe and America, would facilitate matters enormously.

The other portion of the work at Kew is of great practical importance, and contributes very largely to the income of the institution. This consists in testing and verifying meteorological and other scientific instruments, and the magnitude of this business may be realised from

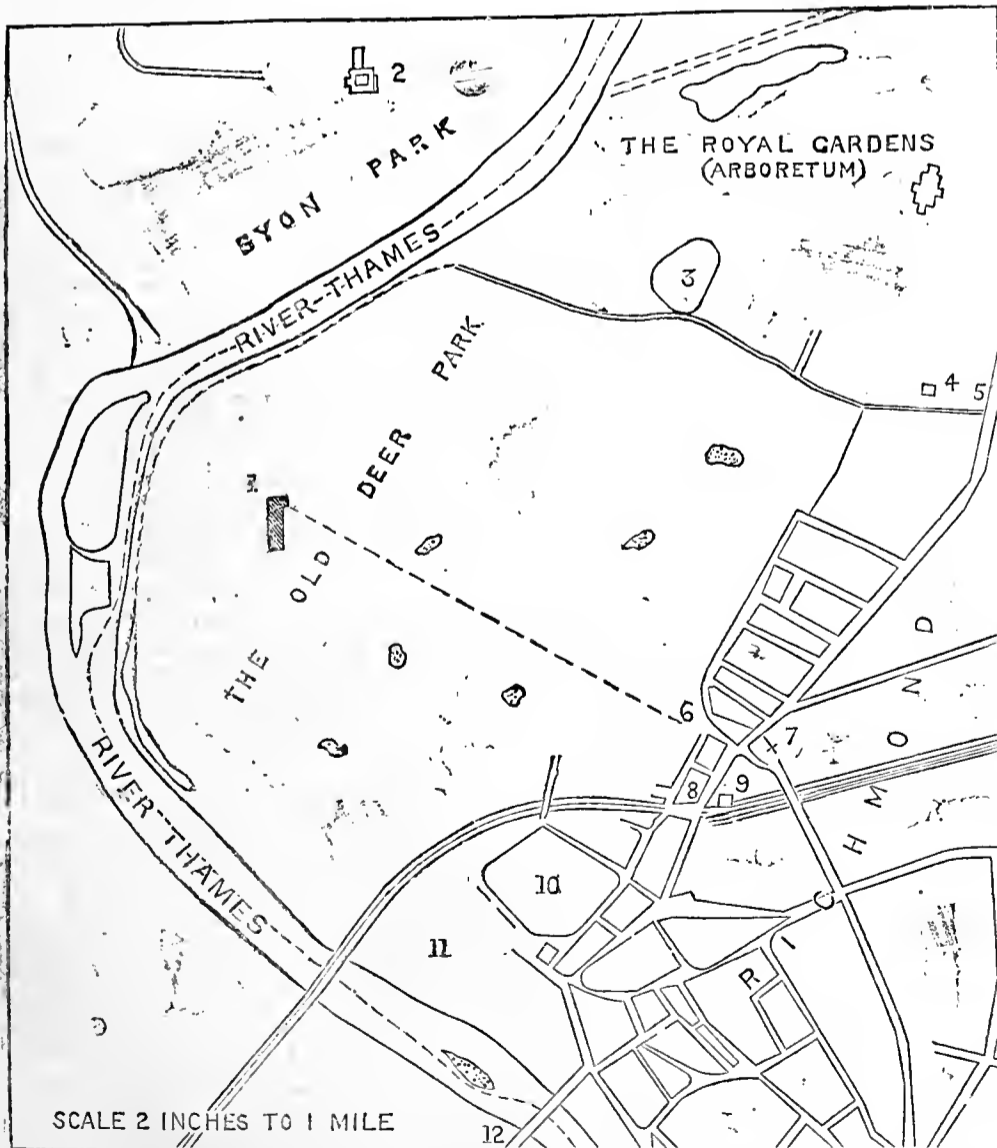

Fig. 33.—PLAN.—1, Observatory; 2, Syon House; 3, Queen's Cottage; 4, Pagoda; 5, Lion Gate; 6, Fuller's Gate; 7, St. John's Church; 8 and 9, Richmond Station; 10, Green; 11, Palace (Site of); 12, Bridge.

the fact that in the year ending with October, 1890, no less than 19,770 instruments were tested. These include barometers, rain measures, anemometers, aneroids, rain gauges, sextants, theodolites, magnets, and compasses, but the principal part of the work consists in testing thermometers, for in the year named over 18,000 were submitted for verification. Most of them were clinical thermometers; but about 5000 ordinary meteorological or horticultural thermometers were included, and the moderate rates at which this work is performed (1s. 6d. for each ordinary instrument) render it of great service to many. The method by which this is performed is a simple one, but requires care and close attention, together with very reliable standards for comparison. A vessel is filled with water, and heated from below by gas or spirit, so that it can be raised to any temperature up to boiling point. In a frame or cage of circular form the thermometers to be tested are then fitted together with the official standards; the cage is placed in the water and is made to revolve slowly, bringing the scales of the instruments in succession opposite to a long glazed aperture in the side of the vessel, when their respective registrations can be noted and compared with the standard. The temperature of the water is gradually raised, comparisons are made at every ten degrees and the inaccuracies recorded at each temperature. When found satisfactory the Kew monogram is etched on the glass as an indication of accuracy, but this is not done in the case of any thermometers of which "the errors at ordinary temperatures exceed 0.4° Cent. or 0.7° Fahr." Barometers and other instruments require a more elaborate system of testing, and cannot be entered upon here. It may, however, be added that watches, chronometers, and telescopes are included amongst those examined.

Beyond all this, experimental work of an important character is carried out at Kew, and commissions from foreign and colonial institutions furnish another portion of the business transacted. Very seldom, indeed, is so much practical and profitable work performed in a strictly scientific institution, and the Kew Observatory deserves to rank high amongst the most useful establishments of this description in Great Britain. I should be wanting in courtesy if I omitted to add that my visit was rendered both instructive and entertaining in no ordinary degree by the kind attention of Mr. Whipple and his able assistants.—
L. CASTLE.

THE CULTIVATION OF PEAS.

THE Pea is said to be a native of the Levant, and whether in a green or ripe state, it is highly nutritious. The number of varieties now in cultivation, however, do not fall far short of 100; but those enumerated below may be considered the best of the different sections:—

First Earlies.—American Wonder, Bijou and Chelsea Gem, being from 12 to 15 inches high, are good varieties for yielding early supplies, either planted in shallow pits at from 15 to 18 inches between the rows, or grown in pots, and for the same purpose for sowing or transplanting out of doors. Lightning, 2½ feet high; Ringleader, William I., Emerald Gem, and Day's Early Sunrise, all ranging from 2½ feet to 3½ feet high.

Second Earlies.—Sutton's Perfect Gem, Laxton's Supreme, height 5 feet to 6 feet; Carter's Stratagem, 2 feet high; Telegraph, height 6 feet; Veitch's Perfection, height 3 feet; and Pride of the Market, haulms 2 feet high.

Main Crop.—Sutton's Royal Jubilee is a very profitable Pea, and fine for exhibition, height 4 feet; Main Crop and Marrowfat are also excellent main crop varieties; Telegraph, Telephone, and Stratagem are quite as good for the main crop as they are for the second crop.

Late Crop.—Ne Plus Ultra, 5 feet high; Veitch's Sturdy, 3 feet high; Latest of All, Green Marrow, and Reading Giant.

Soil.—A deep, rich, loamy soil, inclining to be heavy rather than light, but not stiff, is very suitable to the growth of Peas; but very good crops of Peas are annually secured from light soils, especially during wet summers, when plants growing in light rather than heavy soils yield the most satisfactory crops.

Preparing the Ground.—There is no garden crop that pays much better for good cultivation and generous treatment than Peas; therefore the ground should be liberally manured and trenched to the depth of 18 to 30 inches, according to the natural depth and quality of the soil, and this as early in the autumn as possible. If the soil be of a stiff adhesive nature it may be ridged roughly to be acted on by the winter frosts and exposure to the weather, at the same time adding burnt earth, leaf mould, wood ashes, or chalk. The ridges must be levelled when the soil is dry, just before sowing time. When the crops have not been cleared off the ground until a few days before it is time to put the crops in, a trench or trenches about 1 foot deep and the same width should be opened, and a good dressing of short manure dug into them, returning the soil and then drawing a drill in the centre of the trenches for the reception of the seed.

When and How to Sow the Seed.—The majority of gardeners sow three or four times as many seeds as are necessary for a crop, thereby not only wasting seed but thwarting the object in view—namely, the production of well developed, heavily cropped stems. They have not

room to make healthy growth. Hence they become a prey to mildew and other diseases. In making early sowings of Peas out of doors the seeds should be, say, 1 inch asunder in zig-zag fashion in spring and early summer, so as to make allowance for any mishaps that may occur during the winter months by the seed perishing, the plants damping, or being eaten off by mice or slugs. From 2 inches to 3 inches asunder in the row is quite close enough to sow such branching varieties as Day's Early Sunrise, Laxton's Supreme, Carter's Stratagem, Pride of the Market, Telephone, Telegraph, Sutton's Royal Jubilee, Main Crop, Marrowfat, Ne Plus Ultra, and Veitch's Sturdy. Indeed, sowings of the last named eight varieties made any time between the first week in March and the end of the first week in June may be allowed 1 or 2 inches more space between the Peas. I have secured splendid gatherings of extra long (6 inches) well filled pods of Culverwell's Giant Marrow Pea from seed sown 9 inches to 12 inches apart. But this is a strong-growing and free-branching Pea, and the soil in which I grew it was extra good, and the treatment special and generous. This distance must not, therefore, be taken as a guide in ordinary cases, even with the same variety. It is also a mistake to sow or plant rows of Peas as near to one another as is generally done, because by so doing light and air are prevented reaching the plants in every stage of their growth.

All Peas should be sown or transplanted in drills running north and south, and about 3 inches deep. American Wonder and Chelsea Gem may be sown or transplanted in rows at from 15 to 18 inches apart, giving such varieties as Carter's Lightning, Stratagem, Pride of the Market, and Sutton's Perfect Gem 3 feet between the rows; and Ringleader, William I., Royal Jubilee, Sturdy, Main Crop, and Marrowfat 5 feet, growing a rank of Cauliflower between the rows of Peas; allowing from 8 to 10 feet between rows of Telegraph, Telephone, Ne Plus Ultra, Carter's Elephant (new), British Queen, and Sutton's Reading Giant, planting from two to three rows of Cauliflower or Cabbages between them.

The best method of raising early Peas as well as some of the second early large-podded varieties is to sow about six Peas each in 3-inch pots three parts filled with light rich mould the end of December or early in January, covering the Peas with a couple of inches thick of the same description of mould, watering, and then placing the pots so filled in an early Peach house or vinery, or any place under glass in which a minimum temperature of between 40° and 50° is maintained, putting the Peas into a cold house or pit as soon as they have made about 2 inches of growth to harden them before transplanting into a warm border about the middle or end of the following February. They should then have a little soil drawn up to the plants on each side, and be supported by short spray or spreading sticks being stuck firmly into the ground on each side of and close to the plants, following this with a good dusting of a mixture of lime and soot as a means of preventing slugs attacking the plants, and mulching with half-decayed manure to the thickness and width of 6 inches. The latter application will have a fourfold effect—it will shield the plants from the effects of cutting winds, prevent the soil about the roots of the Peas being frozen, preserve the ground in a more equable condition than would otherwise be secured; and, in addition to conserving the moisture at the roots in the spring and summer months, every time that water is applied it will wash the substance of the manure down to the roots. Protect the plants by sticking Spruce or other evergreen spreading boughs into the ground on each side of the plants. These should be removed on fine days, and replaced in the evening two or three times a week, weather permitting, until the second week in March, when they should be removed altogether and the ranks of Peas be finally staked; always keeping the sticks close to the haulms so as to prevent their swaying.

Where there is any difficulty in procuring the pots pieces of turf about 3 inches square and 2 inches thick may be substituted for the pots, the Peas will soon take possession of the soil side of the turf. Where there is not glass accommodation at hand make the first sowing early in November on light soil on a warm border sheltered from the north and east. The soil should be closed over the Peas with the feet, and, if of a light description, trodden, and afterwards raked, marking the position of the rows by putting a stick in the ground at each end of the rows. As successions to the first sowings, sowings of the same early varieties and Sutton's Perfect Gem, Laxton's Supreme, Stratagem, Telegraph, Royal Jubilee, and Duke of Fife, a grand new Pea, from 5 to 6 feet high, producing handsome pods nearly 6 inches long, containing nine to ten large light coloured and deliciously flavoured Peas each, should be sown in the open, weather permitting, about the first week in January. Another sowing of as many of the second early varieties as there is room and necessity for should be made three weeks later, repeating this sowing of the same varieties the middle of February, making sowings of the main crop varieties afterwards at intervals of a fortnight or three weeks, according to the nature of the weather, up to the end of the third week in May, sowing for late crop the end of the first or second week in June according as the district is cold or warm in a situation close to plenty of day traffic, otherwise the sparrows will be very troublesome. Twice or thrice the number of rows can be sown as on the preceding occasion, as three months later the pods will take a longer time than previous crops did to fill. If sowings are made later in June than the dates indicated, they should be made in warm situations and consist of early varieties.

After Treatment.—This consists in drawing a little soil up to the haulm on both sides as soon as the Peas have made a couple of inches of growth, supporting them with Hazel or Beech branches correspond-

ing with the known height of the respective variety of Peas, breaking off the tops evenly at that height. This being done, lay on a good mulching of short manure in the manner set forth above. Thus treated it is seldom necessary to apply water at the roots of Peas resulting from the first and second sowings, which in favourable districts, and under the influence of fairly good spring weather, will yield gatherings of Green Peas from about the end of the third week in May to the middle or end of June. The plants must not at any time during their growth, except when the Peas are being saved for seed, be allowed to become dry at the roots. Hence during dry hot summer weather the plants require copious supplies of water or diluted liquid manure. This will be more necessary if the soil be light.

Stopping the Plants—In order to hasten the process of podding, pinch off the tops of the haulms as soon as the flowers are open. The temporary check thus given to the plants will enable a gathering of Peas to be made a few days earlier than would otherwise be the case.

Insect Attacks.—The enemies of the Pea are numerous. They include mice, birds, snails, slugs, and the Pea weevils—*Sitona crinita*, *S. lineata*, and *Otiorynchus picipes*. These depredators devour the young plants as soon as they appear if preventive means are not adopted. Mice and the snake millipedes eat the seeds committed to the ground. The caterpillars of the V-moth (*Plusia gamma*), and the maggots of a small fly (*Phytomyza nigricornis*) feed upon the leaves. Birds and the pea maggots, which are the offspring of a moth called *Tortrix pisana*, attack the Peas in the pods, and the maggots of the Bean grain beetle (*Bruchus granarius*) eat out the interior of the seed Peas. Mice can easily be trapped, and the birds can be kept at bay by placing a length of small-meshed garden netting over the ranks when the plants appear, and again when they begin to pod. Slugs and snails may be kept at a distance from the plants by laying at the sides and ends of the several ranks a good dusting of a mixture of fresh soot and lime, repeating the application when necessary. The pea weevils may be dislodged, and further attacks averted by dusting the affected plants while damp with the soot and lime. Mildew in Peas is generally caused by excessive dryness at the roots, and an unduly wet and cold atmospheric temperature during the growing stages of the plants. The remedy, or rather preventive, being in the former case adequate supplies of water given at the roots, and in the latter the dusting of the affected leaves of the plants while damp with flowers of sulphur.—H. W. WARD, *Longford Castle Gardens, Salisbury*.



STRAY NOTES.

So there are to be three East Anglian Rose Shows on one day, two of these being the exhibitions of societies which are affiliated to the N.R.S. It is really getting too bad. What are we to do? I am afraid we cannot give any disciplinary powers to the Secretaries of the N.R.S. of "coming down" upon offenders, but I think it might be made a condition of affiliation that the days chosen be submitted to the Committee for approval before a certain date, or at least that pains should be taken to avoid such thoughtless arrangements. I do not know whether anything is done beyond the mere offer of advice and assistance in the report, or whether the report is sent to the Secretary of each affiliated Society, for it by no means follows that the Secretary or any one of his Committee is a member of the N.R.S. It is a delicate subject for exhibitors to bring forward, for they are almost the only sufferers, and it is easy to accuse them of greediness and pot-hunting, and I hope therefore that those in authority who are not exhibitors will do their best to remedy the present state of things.

P.S.—Since writing the above there seems some prospect of the matter being settled amicably between the affiliated Societies, and it appears that the date of the other Show was a misprint in the local paper.

In the last supplement to the N.R.S. catalogue of Roses there are certain recommendations as to duplicates and future omissions, which were I believe agreed to at the last general meeting. The following H.P.'s were to be omitted from the list of show Roses:—Abel Grand, Antoine Ducher, Catherine Soupert, Centifolia Rosea, Comtesse de Serenye, Duc de Rohan, Duchesse de Caylus (Penelope Mayo), Edouard Morren, Egeria, Lord Macaulay, Maréchal Vaillant (Avocat Duvivier), Nardy Frères and Thérèse Levet. The only name I regret to see here is Lord Macaulay; it is not quite first class, but I find it big enough, very useful, and a capital Rose to stand. Duchesse de Caylus is of considerably better quality, and was much esteemed ten or twelve years ago, but it is not big enough and must go. I would also have omitted Elie Morel and Henri Ledechaux at least, and how Centifolia Rosea ever got into the exhibition list I cannot think.

The list of dethroned Teas is:—Comtesse Riza du Parc, Jean Pernet, Marie Guillot, Mons. Furtado, and Souvenir de Madame Pernet. Here I am sorry to see Marie Guillot given up; it is very difficult to grow and show well, but it certainly possesses capabilities of being exhibited

in first-class and most distinct form, and as such I have seen it at a N.R.S. Exhibition. I should certainly have also cut out Madame Charles; and Adam, Amazone, Bouquet d'Or, and Madame Berard are hardly worthy of the place they hold. The new synonyms are:

- | | | |
|----------------------|--------------------------|-----------------------------|
| { Alfred Colomb. | { Duke of Wellington. | { Duc de Rohan. |
| { Marshal P. Wilder. | { Rosieriste Jacobs. | { Mrs. Jowitt. |
| { Wilhelm Koelle. | | |
| { Grand Mogul. | { Lady Mary Fitzwilliam. | { Madame Alphonse Lavallee. |
| { Jean Soupert. | { Lady Alice. | { Marie Baumann. |

I was rather surprised at the union of the third couple, but they are not Roses that I know very well; at any rate Duc de Rohan figures in the list to be omitted, while Mrs. Jowitt has certainly been shown, not unfrequently, in fine form.

I am surprised that more of the leading nurserymen, or even amateurs, do not attempt the raising of seedling Roses. It is true that the whole thing is rather a lottery; that neither artificial crossing nor due ripening of seed can be depended on out of doors, and that the seedling plants, previous to blooming, often take up to little purpose a large amount of valuable ground. Still, both the glass and the room could be found by many, and all amateurs can buy foreign ripened seed such as a large majority of our best Roses come from. What interest there is for the enthusiast in watching the first opening buds in search of the chance gem among the refuse; or, better still, of the result of a carefully studied and duly worked-out cross. Of course, the most perfectly shaped and sound seeds are likely to produce the best Roses; but I have often wondered if the actual seeds which produced the most famous French Roses were in any way different to look at from the others with which they were sown.

A day or two ago I was looking at a plant of Rubens on a south wall, and wondering to see how completely it, and others on walls, had withstood the frost, though quite unprotected, when I saw a ripe-looking hep on a small shoot. On opening it I found it contained one seed only, but that a whacker! as big as three ordinary seeds, and looking something like three seeds fasciated into one. I daresay it will not germinate, though it seemed fairly ripe; but my faithful assistant, as he carried it off for careful sowing, already, I fancy, "in his mind's eye," was fingering the gold medal of the N.R.S.—W. R. RAILLEM.

PRUNING TIME.

THE time is fast coming when it is possible to take stock of the Rose garden. Going over to prune shows the state of the case. It may have a melancholy interest for friends, and perhaps a different sort of interest for rivals, to hear something of "the cruel winter's rages" in the Mole Valley in Mid-Surrey. I find every standard Tea killed dead, every part of the unprotected Teas dead, and Maréchal Niel everywhere killed to the ground. Only earthing-up has been any protection. Fern and straw are worthless after 20° of frost, and over 20° of frost this winter has been an ordinary occurrence. The first and worst frost was on November the 29th, the more fatal for being so unexpected. In this, the hottest and coldest part of south-east England, it is no unusual thing to have to cut back, so to speak, to the quick.

I have just reduced my standards, as is not unusual, to walking sticks with very small knobs. But for experience it would be impossible to believe that such dead-looking stocks would ever see a leaf again. They do get over it, however, somehow. This year recovery is much less certain. Softwooded H.P. standards are also killed. The difficulty is to mention those which have escaped, not those which are dead. E. Y. Teas, Michelon, and Marie Baumann have fared pretty well; also Baronne de Rothschild, though not its descendants. Of climbers W. A. Richardson is everywhere killed, and R. M. Henriette nearly so. A little known but most valuable garden Rose comes out best of all. Reine Maria Pia is hardly injured. This Rose grows like a Willow. It is a handsome, solid, dark pink in colour. It is also one of the sweetest Roses in existence.

"This Rose, of brilliant hue and perfumed breath,
Buds, blossoms, dies, and still is sweet in death."

I fear Mr. Congreve's remark will this year be applicable to many portions of many Rose gardens—

"I've seen the time when on that withered thorn
The blooming Rose vied with the blushing morn."

—A. C.

MYROBALAN HEDGES.

I HAVE found these hedges equal to the Whitethorn as an efficient fence, and superior to it in rapidity of growth. Any thinness of the Plum hedges is owing to mismanagement. Plant carefully in well trenched fertile soil, clip regularly twice a year from the outset, and no Thorn hedge will be thicker or neater. It is owing to careless planting or subsequent neglect that there have been failures, and yet to see the extraordinary vigour of this Plum under good treatment one would suppose failure to be an impossibility. It is because I have seen good and bad hedges of it that I am able to afford positive information about it.

The failures were all owing to the "sticking in" folly of planters, who because they were told the Myrobalan Plum was so robust and vigorous must needs buy the cheapest plants of it to be had, stick them in—for it cannot be called planting—in the gaps of old Thorn hedges,

or alongside old plantations where they were just starved and smothered to death, and then they complain of a failure brought about by their own negligence and folly.

I fearlessly assert that we possess no better hedge plant than this Plum. It bears the dwarfing process of close clipping with impunity, or grows upwards so quickly and with such vigour as to make excellent enclosures for plantations of fruit or Hops, both as an efficient fence and wind screen. Only attention must be given to the common principles of tree culture in the selection of healthy, well-rooted young trees; two-spit trenching, and, if necessary, drainage of the soil; subsequent careful cultivation of the hedge, and then there will be success full and ample.

Is hedgerow management becoming a lost art? Certainly most farmers have let their hedges become mere wild thickets of late years, but I am not aware that gardeners have fallen into such slovenly habits. It may be so. Look to it, you blue aprons, for if I find it is so now that my attention is aroused, I shall not rest content till the fault and its remedy have been discussed in the *Journal of Horticulture*.—FORESTER.



EVENTS OF THE WEEK.—To day (Thursday) the Royal Society meet at 4.30 P.M., and the Linnean Society at 8 P.M. On Friday, March 6th, the Quekett Club meet at 8 P.M., and on Saturday the Royal Society have a meeting at 4 P.M. A general meeting of the United Horticultural Benefit and Provident Society will be held at the Caledonian Hotel, on Monday, March 9th, at 8 P.M., for the purpose of altering rule 20, the rule to read, "second Monday in March," instead of "second Monday in February." The Royal Horticultural Society's Fruit, Floral, and Orchid Committees will meet at 12 noon on Tuesday, March 10th, when a medal is offered for a collection of forced Daffodils, and lectures on Snowdrops will be delivered at 3 P.M. by Messrs. James Allen and W. Boyd. The Society of Arts also meet on Wednesday, March 11th, at 8 P.M.

— REPORT OF THE WEATHER DURING FEBRUARY, 1891.—The past month here has been remarkably dry. There has only been 0.02 of rainfall during the whole month, and that fell on the 6th. There is no doubt but it was the driest month on record here. There has been little or no wind, but some cold dense foggy days, whilst ten of the days are to be remembered as being some of the brightest and grandest days ever known in February, but each day was succeeded by very sharp frost at night. The amount of rainfall registered here during February, 1890, was 0.71.—E. WALLIS, *The Gardens, Hamels Park, Buntingford*.

— THE WEATHER.—Fogs of a remarkably dense character prevailed in the metropolitan district for ten days, but gradually dispersed at the close of last week, and the weather has been remarkably fine on several days since. On Monday the temperature rose considerably, standing at 56° at 6 P.M. Tuesday morning was colder, but very clear. Outdoor plants, fruit trees, and shrubs are now advancing, and a few days' warm bright weather will make a great difference.

— NATIVE GUANO.—We are requested to notice the list of testimonials published by the Native Guano Company. It is a most comprehensive list, comprising records of experience from cultivators in the different counties, who have found the product highly satisfactory in the cultivation of vegetables, fruit, and flowers in gardens and various kinds of crops on farms. This is a very safe manure for amateurs, who are apt to deal too liberally with powerful fertilisers, and its soundness is testified to by hundreds of persons whose names and addresses are published in the compilation before us.

— THE ANNUAL EXHIBITION OF THE CHISWICK HORTICULTURAL SOCIETY will be held on Thursday, July 2nd, this year, in the Royal Horticultural Society's Gardens, Chiswick. The schedule enumerates eighty-eight classes, and the prizes are good, including two silver cups and two silver medals. A five-guinea silver cup and £2 are offered as the first prize for a group of Gloxinias, Ferns, and Palms; while for twenty-four Roses, distinct varieties, a silver cup, value twenty-five guineas, and £3 constitute the chief prize. The cup is presented by J. Mantell, Esq., Ringstead, Gunnersbury, and becomes the property of the exhibitor gaining the first prize three years, not necessarily in succession.

— THE next meeting of the CROYDON GARDENERS' AND AMATEURS' MUTUAL IMPROVEMENT SOCIETY will be held on Tuesday, March 10th, at 8 P.M., in the County Tavern, West Croydon, when Mr. W. B. Glasscock of Shirley Park will read a paper on Peaches.

— THE usual monthly dinner and conversazione of the Horticultural Club will take place on Tuesday, March 10th, in the Hotel Windsor at 6 P.M. The chair will be taken by Sir J. D. Llewellyn, Bart., and the subject for discussion will be "Seeds, Curiosities in their Germination and Distribution," to be opened by Mr. George Bunyard.

— STACHYS TUBERIFERA.—This plant is growing in favour in some places where it has been fairly tried. An experienced gardener finds it necessary to grow it extensively for the demand in the kitchen, and the cook sends it to table fried in butter. It is grown best in warm sheltered places, and kept well watered in dry weather, growing it like Potatoes.—W. D.

— SULPHUR FOR ONIONS.—For the benefit of persons who are unable to raise a good crop of Onions on account of the grub, I can offer a very good recipe, and it is as follows:—When the Onion bed is prepared and the drills made ready for sowing sprinkle a good pinch of flowers of sulphur in each drill from end to end, or if it is desirable to sow the Onions broadcast, sow the sulphur the same way, and dig it in. This will produce a sure crop of Onions, and no grub will trouble them.—THOS. FOTHERGILL.

— THE GLASGOW AND WEST OF SCOTLAND HORTICULTURAL SOCIETY'S SHOWS FOR 1891 are announced in the schedule to be held on March 25th and September 2nd in St. Andrew's Hall. The schedule for the spring Show comprises sixty-three classes for forced plants and bulbs, but cut flowers and vegetables are also provided for. At the autumn Show there are 147 classes; plants, flowers, fruit, vegetables, table decorations, and honey having special sections. The Secretary is Mr. Franc Gibb Dougall, 167, Canning Street, Glasgow.

— RAINFALL IN MID-SUSSEX.—The total rainfall at Cuckfield, Mid-Sussex, for February was 0.04, the average for the month being 2.40 inches. This is the smallest amount of rain for any one month on our record of eleven years, the nearest approach to it being that of June 1889, when 0.23 inch fell. Highest temperature 57° on 28th, lowest 22° on 24th, mean max. 46°, mean min. 30°, mean 38°. Partial shade readings about the average. Thermometer below 32° on twenty-one nights, and on seventeen days it rose to 45° or above it.—R. J.

— WE are desired to state that the next meeting of the ROYAL HORTICULTURAL SOCIETY will take place in the Drill Hall on Tuesday, March 10th. Besides the usual novelties in the way of flowers, fruits, vegetables, Orchids, &c., an open competition will be held for the silver medal offered by Messrs. Barr for the best collection of forced Daffodils. All varieties of Daffodils with the exception of Polyanthus may be entered for competition. There will also be a good collection of Snowdrops, and at three o'clock Mr. James Allen, of Park House, Shepton Mallet, and Mr. W. Boyd, of Melrose, N.B., will read papers on their culture.

— THE LONG FROST AND INSECT LIFE.—I quite agree with your excellent correspondents, "Entomologist" and Mr. S. T. Wright, that severe winters do not extirpate our field and garden enemies, but am inclined to believe that we shall have fewer of some caterpillars this year, as I observed in November and the beginning of December, principally in the first named, myriads of moths upon the wing, when suddenly the weather changed from fine to stormy, the moths were overtaken, and I think most of them were killed. As the storm lasted more or less for days I think few of them survived, while the early frosts put a stop to their breeding.—W. T.

— NATIONAL PINK SOCIETY (MIDLAND SECTION).—We have received the schedule of the first Show of this newly formed Society. It comprises nine classes, five prizes, with one exception, being offered in each class, the amounts ranging from 20s. downwards. The Exhibition is to be held in connection with the Floral Fête at Wolverhampton on the 14th, 15th, and 16th of July. The object of the promoters of the Show is "to restore this lovely, interesting, and sweetest of sweet-scented flowers to the high position it held in the estimation of the public forty years ago." We wish them success in their sweet and loving object so sweetly and lovingly expressed. Mr. Charles F. Thurston, Penn Fields, Wolverhampton, is the Honorary Secretary of the new Society, and will be glad to hear from all persons who may be willing to give their countenance and support to the Exhibition.

— **FORCING LILACS.**—The fragrant flowers of Lilacs are always prized when they are obtained early. After being potted they should always be kept for a few weeks in the open air, with the pots plunged in ashes or cocoa-nut fibre, as the plants respond more quickly to the influence of heat and moisture when taken into the forcing houses than do those which are lifted and placed under glass at once, even if they are brought on slowly. It also frequently happens that both Lilacs and Guelder Roses flag badly in bright weather about the time the flowers begin to show colour. This may be partially prevented by plunging the pots in the open air after lifting, and then bringing the plants on gradually in vineries from the time the Vines are started.—H. D.

— **PEACH GROWING AT BEXLEY HEATH.**—Last year the remarkable crops of Peaches grown for market by Mr. T. Burton were fully described in this Journal. The trees are now in full blossom, or at least the naturally grown standards are, the trained trees setting their fruit. A span house of these, 220 feet long, and every part of the trellis practically within reach, presented a remarkable sight last week, as most of the varieties grown in it have large blossoms. Mr. Burton does not remove any of the flower buds, crowded as they may be, but from one tree, and not a very large one, 3000 fruits were removed last year in thinning the crop, and this, when ripe, would average five or six fruits to the square inch. The crops on the standard trees would drag the branches to the ground if they were not supported with strong cords to the roof.

— **SCARCITY OF PARSLEY.**—The most suitable places I have found for growing it to stand the winter has been odd corners under trees or hedge bottoms. Last season, having lost nearly all that was not in boxes and covered, more from damp than frost, I was obliged with a supply by a cottager, who had a fine lot growing under a Yew tree. Having cut about 6 feet of rough Yew hedge, planted on mound of very rough material, and full of roots, I grubbed the surface, and gave it some potting-shed refuse, then sowed half with Parsley, and planted other half. It did not grow very much and had to struggle amongst the weeds. The Parsley has, however, stood the winter all right, and there is a nice lot of small leaves now, and with a change to genial weather there will soon be plenty for gathering. In many gardens there are corners where Parsley might be grown, even if out of place. The cook will not mind where it comes from.—J. M.

— **THE WEATHER IN SCOTLAND.**—Up to the 27th of February we have had but one stormy day, and although I do not believe in "frets," 1860 and 1861 February's were both very fine here throughout, and were the best months of both years. Nor do I believe a fine summer follows a severe winter, for experience has proved the reverse; but, again, where have we taken our data from? The winter has evidently been severe in the south of us, while here it has been a moderate winter, but frosty. Now, at which of these places are the forecasts to be taken? The day temperature of February 23rd for between five and six hours was 60°, sinking to 30° during the following night, falling gradually every night and day, but maintaining the same alternations. Whatever the day temperature might be the night temperature was 30° lower; and on the morning of February 27th the thermometer stood at 20°, while the day was the most foggy we have had. The clear sky, with bright sunshine on the previous days, favoured evaporation, consequently there was much hoar frost, giving the landscape a wintry looking aspect in the mornings.—LANARKSHIRE.

— **IMPORTED TOMATOES.**—In recent years much attention has been paid in the Azores and Canary Islands to fruit production for the European markets, and especially for England. It is well known that enormous quantities of Vines are now imported from these Islands, but Tomatoes for early supply are now being cultivated extensively, and a considerable consignment reached London a few days ago. It was said that several ships laden with Tomatoes, having been delayed by the fogs, had arrived together, and Covent Garden Market was in consequence flooded with boxes of this fruit; nearly every salesman seemed literally to have his "hands full," and the quantity sold by auction necessarily reduced the prices much below what would have otherwise been obtained at this season. The fruits were packed in neat, shallow boxes, each containing a single layer of fruits and a probable weight of 3 lbs. or 4 lbs.; they were sold at 1s. to 1s. 6d. each, finer fruits bringing rather more and damaged samples less. The fruits were generally in fair condition, as they were carefully packed, but some had suffered in transit, the injured fruits much reducing the value of the others, as can be imagined. The majority were said to have been received from Teneriffe.

— THE most recent issue of the *Kew Bulletin* constitutes an appendix, giving a list of Seeds of Hardy Herbaceous Plants and of Trees and Shrubs saved during the past year, and "available for exchange with Colonial, Indian, and Foreign Botanic Gardens, as well as with the regular correspondents of Kew." The list comprises thirty-one pages of names printed in double columns, and about 2500 species or varieties are enumerated. The authorities are given for the names, the native countries, and the principal synonyms. It is added that the seeds are only available in small quantities, and "are not sold to the general public."

— **BULLFINCHES AND BIRD PESTS.**—In your notes of February 26th, "C., Kent," laments the attacks made on bullfinches. I am inclined to think if "C." had to get his living by growing fruit he would very soon change his opinion, "and wish all the bullfinches in Covent Garden learning to sing." At the present time I could show him the ground covered with fruit buds of Gooseberries in spite of all we can do to keep the birds down. It is astonishing what a pair will do in a few hours if left alone. This year, so far, they have confined their attentions to Gooseberries and Mulberries, while last year Gooseberries, Currants, Mulberries, Pears, Plums, and especially Damsons, were almost completely cleared of buds, while to finish up with starlings and blackbirds ate the Apple blossoms as they were opening. Birds became so numerous here they were a perfect pest. The severe winter has thinned them considerably, especially the thrushes; blackbirds became as cheeky as sparrows. The latter do not seem to have suffered much. One of the farmers has shot over 3000, and still they come. It is calculated they destroy a quarter of Wheat per acre that is grown in this district.—J. M., *Camerton Court, Bath.*

— **NATIONAL AURICULA AND NATIONAL CARNATION AND PICOTEE SOCIETIES (SOUTHERN SECTION).**—We are pleased to see in the fourteenth annual report of these Societies that both of them are in a healthy financial state, the income of the former last year having exceeded the expenditure by a little over £11, the balance in favour of the latter being a pound or two less. The Committees regret the loss of two excellent supporters of the Societies—the late Mr. James McIntosh and Mr. Shirley Hibberd. Information that will be of great service to florists is embodied in the reports in the form of select classified lists of varieties of Auriculas and Primulas, also Carnations and Picotees, as compiled from the aggregate number of votes accorded to different varieties by leading growers who sent in selections. In the list of green-edged Auriculas, Rev. F. D. Horner and Colonel Taylor are placed equal first with 12 votes each; grey-edged, G. Lightbody stands first with 14 votes; white-edged, Conservative, with 11 votes; selfs, Heroine with 13 votes. Rosea grandiflora heads the Primula list. The premier Carnations are as follows:—Scarlet bizarres—Robert Lord (15). Crimson bizarres—Rifleman (14). Pink and purple bizarres—Sarah Payne (15). Purple flakes—James Douglas (14). Scarlet flakes—Sportsman (15). Rose flakes—Thalia and Sybil (14 each); and selfs, Germania (9 votes). Picotees:—Heavy red-edged—Dr. Epps (13). Light red—Mrs. Gorton, Violet Douglas, and Thos. Williams (15 each). Heavy purples—Mrs. Chancellor (14). Light purple—Clara Penson (14). Heavy rose—Mrs. Payne (14). Light rose or scarlet—Favourite (15); and yellow ground—Agnes Douglas, 13 votes. Some others follow those named very closely, and the selections may be taken as representing the standard of merit at the present time. The number of subscribers to these Societies are not sufficiently numerous. Mr. James Douglas, Barking Side, Ilford, is the Secretary of both Societies.

THE ROYAL HORTICULTURAL SOCIETY. CHARTER AND BY-LAWS.

As you say it will "interest" you to hear from me again touching by-laws 66 and 81, I feel that it would really be cruel on my part to deny you such pleasure. You will, I hope, forgive me for reminding you and your readers that in your first attack upon our action you based your arguments on the by-laws, and when I had answered you there, your next article said in effect, "Well, you may be right on the by-laws; but if so, both they and you are wrong by the Charter." In my last letter I endeavoured to answer you by the Charter, and most people think I succeeded. Now you return to the charge and base your position again on the by-laws. Well, as it "interests" you, I have no objection to hark back again, but it compels me to repeat that the Council have acted in plain and distinct accordance with by-laws 67, 68, and 76, which read as follows:—67: "If any member of the Council dies, or becomes incapacitated, between two annual meetings, the Council may fill up the vacancy; and any Fellow so appointed shall, for all purposes, be deemed to occupy the position of the person to whose seat he has been appointed." 68: "A member of Council

may be deemed incapacitated who is absent from England for more than three months." And 76 orders that, in the event of a vacancy in the Treasurership through incapacity, "such vacancy may be filled up by the Council." Mr. Morris became incapacitated under 68. The Council appointed Mr. Crowley under 67 to the vacant seat on the Council, and under 76 to the vacant Treasurership. (I need hardly say the numbers refer to the by-laws, and have no reference to the gentlemen's ages). Kindly note that there is no mention of the word "resignation" in by-laws 67 and 68, under which the Council acted; whereas by-law 66, in which you are so "interested," refers only and solely to resignation. There is no question of Mr. Morris's resignation, that is an erration of your own invention. Mr. Morris became incapable, and it does not appear to me to require any Machiavellian intellect to perceive the distinction between "resignation" and "incapacity"—the former is active, the latter passive. The former says, for some reason, "I will not continue," the latter, "I cannot continue. I am forbidden by the by-laws to continue." And the by-laws, very reasonably, in my opinion, direct (by-law 66) that the man who, in the interval between two annual meetings, says, "I will not," shall, at the next annual meeting, give a reason for such active resignation and sudden throwing up of his responsibilities, and his place be left open (his resignation not being complete) until after such annual meeting; whereas equally reasonably when a man dies, or becomes incapacitated and cannot continue. Then (by-law 68) the Council is to fill the place, and the new occupant is "to be deemed, for all purposes, to occupy the position of" him incapacitated.

Again, you do not appear to dispute that the appointment of Mr. Crowley was valid; you only question the *duration* of such validity. Now there would have been no need for Mr. Morris to have been re-elected on to the Council at the annual meeting had he continued in England. Does it not, therefore, follow that if Mr. Crowley "*for all purposes occupied*" Mr. Morris's place that therefore there was no need for Mr. Crowley to undergo a process which Mr. Morris would not have undergone?

By-law 81, in which you now for the first time profess an "interest," does not appear to me to touch the subject from either point of view, and I am entirely at a loss to understand your reference to it. I do not question but that a member of Council may resign. By-law 65 says he may. Nor do I question that the annual meeting may remove an incapable. By-law 71 says it may. I can only imagine the figures 81 were a misprint. Your argument that by-law 66, which treats of "resignation," overrules 68, which treats of "death and incapacity," because the one happens to be numbered 66 and the other 68, is of such astounding audacity that the mere writing of it down would suffice, except that evidently you do not perceive what a ludicrous position it lands you in, and how clearly it proves your whole argument wrong. Sixty-eight says that if a member of Council die, or become incapacitated, the Council are to fill the vacancy—that is plain, you do not dispute it—but you say 66 overrules this. Very well, let us try. Suppose a member of Council die, and under 68 the Council fill the place, as you admit they should do, then if 66 overrules it, "such resignation shall not be deemed complete until it has been accepted by a resolution of the next annual meeting, and the acceptance of such resignation shall not be entertained by the meeting unless the member proposing to resign has signed a paper, &c." Poor member of Council, he is not completely dead until the next annual meeting of R.H.S. ! Poor R.H.S., it is not to accept *such* resignation until the dead man has signed a paper ! Really, Sir, I think even you must perceive what a ludicrous corner your argument lands you in, because if 66 overrules 68 in the case of an incapable, it obviously does so also in case of a death, for the two things are bracketed together to be treated in the same way, "If a member of Council die, or become incapacitated, &c." After this I hardly think we need pursue the subject any further. That you should take so much interest in the old Society is not surprising, as you certainly are aware of all that it has done and is still doing for gardening in all its branches and aspects, and you know how hard some of us have worked during the last three or four years to deliver the Society from the almost Slough of Despond in which we found it. Pleased as I am, therefore, at this great interest on your part, I venture to hope that your particular interest just at the present may admit of a slight period of rest and quiescence, as it really is difficult for me to find time to assuage your strange and devouring appetite for the Society's by-laws. You had the first word, and as an omnipotent Editor you will doubtless also claim a right to the last (it seems to be a peculiarly editorial view of a fair argument), but as I really must make this my concluding letter, allow me to assure you that there can be no one who values the Society's chartered position or is more careful to keep to the rules and regulations enjoined than—W. WILKS, *Vicar of Shirley, Sec. R.H.S.*

[In this not unimportant discussion we have studiously avoided the use of language that would be in the least likely to unduly excite Mr. Wilks. We hope he appreciates this, and that the Vicar of Shirley does not intend to be severely satirical, though it is quite clear that the rejoinder of the Secretary of the Royal Horticultural Society lacks the calm dignity of conscious strength.

We have no desire to prolong the discussion, but must point out how distinctly wrong the writer of the above communication is on one important point. He says, "By-law 81, in which you now, for the first time, profess an interest, does not appear to touch the subject" (of Mr. Morris's vacation or Mr. Crowley's appointment).

The Secretary must either read hurriedly, write hastily, or forget

quickly. If he has time to turn to page 140 of the *Journal of Horticulture* he will find we took so much real interest in by-law 81 as to quote it, and point out that the action was in conflict with it, yet now we are told we for the *first time* (on page 172) "profess" an interest. If page 172 comes in chronological order before page 140 Mr. Wilks will be right in his assertion; if not he must be wrong, and we are ready to leave it for himself to determine whether he is wrong or right. Surely he will not find fault with that.

The Secretary has never answered what we said on page 140, and of which he was reminded on page 172, and we have yet to learn that it is in his power to give a good answer to what was then advanced, and to reconcile the action with the law which should govern that action. He even says he is "entirely at a loss to understand our reference to the by-law." That confession is significant, and there is no wonder the clearly prescribed form was not complied with. Mr. Wilks would now have us believe he does not know the difference between *ordinary* and *extraordinary* vacancies, and it is perfectly certain there has been a misconception on the point.

Neither does Mr. Wilks appear, until now, to have been able to distinguish between vacancies caused by resignation and those caused by death or incapacity "from any cause whatever." The former (resignations) are governed by by-law 66, and the latter by by-laws 68, 69, 70, 71, and 81. This he has found out, except in respect to the latter, and we suspect he will comprehend the influence of this before he is a year older.

Our remarks in previous issues have been, however, based mainly on Mr. Morris's resignation both from the Council and as Treasurer. Why? Because Mr. Wilks, in answer to a direct question at the annual meeting, stated that Mr. Morris had "resigned." We therefore took him at his word; and we have been justified in this by Mr. Wilks in every allusion he has made (until now) to the circumstance, speaking of the vacancy caused by Mr. Morris, as "Mr. Morris's resignation," and we have said all along, and we say still, that this resignation has never been completed according to the by-laws. Nor has it.

But *now*—and we draw particular notice to this fact—Mr. Wilks states "there is no question of Mr. Morris's resignation, that being an erration of our own invention;" and this, notwithstanding the direct and specific answer he gave to the contrary at the annual meeting! In another part of his letter he says something about "audacity," and evidently we do not monopolise it.

The Secretary now, for the "first time," admits that Mr. Morris's retirement was not a resignation under by-law 66, but a vacancy created by incapacity. He is evidently beginning to understand the case. That has been our contention all along; and he now completely turns round on himself—an example of "machiavellism" (to quote his own epithet)—that is, without a parallel in this discussion. By the admission, at last extorted, the vacancy was an "extraordinary" one, and could only be legally filled by the procedure under by-law 81. That is a fact, and there is another—namely, the procedure has *not* been complied with.

Mr. Wilks places emphasis on the condition that when Fellows are appointed to fill temporary vacancies they shall do so *for all purposes*. Of course, or what would be the use of the appointments? That is a rudimentary matter, as is another—that both are bound within the same limits by the Charter.

The Vicar of Shirley, as becometh a clergyman, charitably imagined that our reference to by-law 81 was a "misprint." There was no misprint; but we did give Mr. Wilks an opportunity of indulging his humour for facetiousness by an allusion we made to by-law 66 governing by-law 68 on a vital point, and if he thinks we were in error he is quite welcome to make the best he can of the discovery.

We should be sorry to spoil Mr. Wilks' attempt at being funny, but we would remind him that the little word *or*, in by-law 68, is disjunctive, and that any member of the Council who dies is not in the same position as one who becomes "incapable from any cause whatever," as is set forth in by-law 69. No person in his senses would suggest that the imaginary dead man should be asked to "sign a paper," but he would insist on the living man conforming to the conditions of the by-law.

The broad facts remain as we have previously stated them, and one of them is that Mr. Morris is still Treasurer of the Royal Horticultural Society, and the only person who can be held legally responsible for the duties pertaining to that office.

We fully accept Mr. Wilks' assurance that he values the chartered position of the Society, and desires to keep to the rules and regulations enjoined. It would sooner or later (to adopt his euphemism) be "poor old R.H.S.," if he did not, and through a misconception the recent action has been in conflict with them. This might have been averted, as we pointed out, and we suspect no such confusion as exists now will be allowed to occur another year. The Charter is right, the by-laws are right; but they have not been properly comprehended, and therefore the procedure has been wrong. That is the "case."

MR. E. R. CUTLER.

BOTH those of our readers who had the pleasure of the acquaintance of the late indefatigable Secretary of the Gardeners' Royal Benevolent Institution, and those who were familiar with his name alone, will be pleased to see his portrait, which represents him as he appeared not very long ago. The sad news of his sudden death at Wimbledon on the 24th ult. only reached us in time to make the announcement last

week. Mr. Cutler, though in his seventy-second year, was an extremely active man both physically and intellectually. When in his happy moods, and he was seldom otherwise, he was almost youthful in his vivacity. He was highly esteemed by many outside the ranks of horticulturists, but who were, and remain, in sympathy with the benevolent work in which he engaged unremittingly and with signal

HINTS ON PROPAGATING.

DURING the next few months, great numbers of plants will require to be increased, and the method of procedure adopted should be regulated according to the appliances at command. This is, in my opinion, the true secret of success in this matter, and failures may often be traced to a tendency to follow in a "beaten track" without taking into



FIG. 35.—MR. E. R. CUTLER.

success for more than fifty years. He was only just rising into manhood when appointed to the secretaryship of the Institution, then in its infancy, but now one of the strongest charitable organisations in the kingdom. Mr. Cutler's zeal in his work was unbounded, and he was aided and encouraged by zealous co-officials and prudent administrators. He is gone, and will long be missed and mourned, but they remain, and the future prosperity of the Gardeners' Royal Benevolent Institution is safe in their keeping.

consideration the altered circumstances under which this operation must sometimes be performed. Where large quantities of plants have to be propagated annually the right system to follow is that by which the best results can be obtained with a minimum of labour, and throughout my remarks on this subject I intend to keep that point steadily in view.

Where a properly appointed propagating house or pit is at command the matter is much simplified, and there can be but little doubt of the true economy of setting apart some structure for that purpose.

Where no propagating house exists other practices must be resorted to, such as placing handlights over hot-water pipes, or on stages in various structures where the advantage of bottom heat may be obtained. The time-honoured manure bed when covered with a frame is also of immense service for propagating plants from warm structures. If a bed is made up at the present time of manure and leaves well mixed, to prevent a too violent heat, the surface being covered with 3 or 4 inches of cocoa-nut fibre or sawdust to plunge the pots in, but little difficulty will be experienced in rooting many plants which under other conditions would fail. This we find one of the best methods of propagating Verbenas, Ageratums, Deutzias, and Lobelias, the cuttings being dibbled into boxes which are stood upon the surface; but in any instances where pots are used they are plunged to within 1 inch of the rim. Carnations strike wonderfully well in such positions, and the short sturdy side growths, which can be pulled from the plants with a little hard woody substance at the base, make much the best plants. Heliotropes and Iresines strike much the best when they are placed in a close propagating house or dung bed, where there is a fair amount of bottom heat; but they succeed fairly well when placed over the hot-water pipes in vineries or in Cucumber houses without any other glass covering. Alternantheras, when inserted in shallow boxes, succeed admirably under similar conditions, and as the varieties of these beautiful plants are in many places in great demand it is fortunate they are so easily propagated. Mesembryanthemum cordifolium variegatum roots with certainty when exposed on shelves to full sunshine; when shaded in the way that is beneficial to the majority of cuttings these succulent plants damp badly.

Leucophyton Browni is sometimes spoken of as a difficult plant to propagate. It should always be kept in a cold pit. Cuttings dibbled closely into boxes in September or October will by the spring time be well rooted. Where large numbers of Fuchsias are required they can readily be propagated without the aid of handlights, if placed in vineries before the shade from the Vines is dense, or in close pits. Sometimes it is necessary to strike cuttings of Tuberous Begonias. These can be placed under handlights, bellglasses, or in a dung frame. Coleuses will root with certainty if placed in either pots or boxes, and stood on the hot-water pipes in Cucumber or Melon houses. They flag a little at first, but in a few days recover, and root without the loss of a leaf. Many gardeners are careful to place these cuttings under handlights, and it may be of advantage to many to know they may be rooted easily without such aids. Of bedding Pelargoniums it generally happens that numbers of spring-struck plants are required, especially of such varieties as Mrs. Pollock, and, indeed, this kind can be rooted with greater certainty in the spring months than from cuttings taken from flower beds in summertime, provided the plants are in a structure where there is a fair amount of artificial heat. In many instances during February and March the plants are in vineries that have already been started, and the moderate amount of fire heat given from the time the Vines have broken till they come into flower is just enough to bring the young shoots into proper condition for striking freely when inserted in shallow boxes in sandy soil. These we place in any suitable portion of the house, so long as there is but little foliage on the Vines; but when the foliage is fully developed the boxes are placed near the front of the house or on shelves, otherwise the cuttings become drawn before they are thoroughly rooted. When well rooted they may be placed in 3-inch pots, the point of the shoot being removed a week later, and the plants allowed to remain in heat till the young shoots are growing freely, when they may be transferred to cold pits to harden. Treated in this way spring struck plants may be grown, which at bedding out time are but little inferior to those rooted in the ordinary way during the previous August and September.

Gardenia tops, taken at the present time and inserted in soil consisting of loam and peat in equal parts, with the usual addition of sand, if kept close in strong heat, will strike as easily as Pelargoniums or Fuchsias, and grow into good-sized plants for flowering next season. Suckers of Pandanus Veitchi, inserted in thumb pots, and placed on the hot-water pipes in Cucumber houses or Pine stoves, quickly become well rooted, and when well established they grow into useful sized plants rapidly if kept in such positions, a comparatively dry heat being just what they require to bring out their colour. Many other kinds of stove plants will now require to be propagated; but I will not touch upon the various methods of doing so, as they have been so well described in recent articles in the Journal. But before concluding I will point out the importance of preparing plants for propagation by placing them for ten days or a fortnight before the cuttings are wanted into a structure where they receive a temperature similar to that it is intended to root them in, as a large number of failures may be traced to the erroneous practice of taking cuttings from a cool structure and trying to propagate them in one where the temperature ranges from 10° to 20° higher.—H. DUNKIN.

NOTES ON SOME NEW OR RARE HERBACEOUS AND ALPINE PLANTS.

As my garden is a small one and my taste in matters horticultural somewhat omnivorous I am compelled to confine myself in most things that I grow to selections rather than grow collections. So while a Daffodilian will have his grand collection of some 200 kinds, I am content with my fifty or less, and while an "Alpine man" will plant his twenty roots of *Gentiana verna* I am obliged to be content with two or three. This has some advantages. I am obliged to be particular as

to what I do grow, and must endeavour to select the best of each class. It is easy, for example, to fill a rockery with a few very common things, to do the same with your herbaceous borders; but many of them, though fadly called the "dear old garden flowers," are not worth their salt, and are even so rampant in growth that they choke out other things. A thing is not necessarily good because it is old fashioned, nor a plant to be despised because it is a novelty; for while the revived taste for hardy plants has no doubt brought back into notice many an old garden favourite which had been undeservedly cast aside, it has also brought back some which might very well have been left to the obscurity into which they had fallen. The plants named in the following notes are some which I think are not as well known as they ought to be, and are deserving, I believe, of a place in my garden.

Aubrietia græca Ingrami.—A plant of this was given me some years ago by that most excellent gardener, Mr. Ingram of Belvoir Castle, whose spring gardening has given such a charm to the grounds of that fine residence. It is somewhat in the way of *A. g. superba*, with large, light purplish flowers. It grows very freely, and in spring is one sheet of the most brilliant light purplish blooms. No weather seems to affect it, and although the clump has to be cut back every year it still spreads.

Aubrietia Leichtlini.—A remarkable plant obtained by Mr. Max Leichtlin. It is a very decided rose coloured flower, having a tinge of carmine in it, and it may be possible that this very decided break from the colour of the older varieties may possibly lead to deeper colours still; it is quite as vigorous as the older kinds, and forms a pleasing addition to the early spring flowers we already possess.

Arnebia echinoides.—This is a very curious flower, sometimes called the Prophet's Flower, from the legend that Mohamed placed his fingers on it and made the spots on the petals, which are visible when the flower opens, but fade away in a day or two. It is a robust growing plant; the colour is a soft primrose yellow, and it does not seem in the least to care about either soil or situation, growing almost anywhere. When a good group can be made of it, it is very effective and showy.

Cistus algarvensis.—A very beautiful Rock Rose, but I am not quite sure of its hardiness. I had a good plant of it, but it has perished. Perhaps it may have been from bad management; but I have heard from others that some of these Cistuses are not quite hardy. It has very soft delicate yellow flowers, abundantly produced, with small black spots, and with soft pretty foliage.

Clematis coccinea.—It is rather a stretch of imagination to call this coccinea. The flowers are no doubt red, but not such a red as is indicated by coccinea. The growth is not like that of its congeners, and it may be best described as a hardy herbaceous climber. From what I hear I fancy there are varieties of it some brighter than others.

Coreopsis grandiflora.—There seems to be some confusion about this herbaceous species of a family mainly known by its beautiful annual varieties. The more ordinary name by which it is designated in the catalogues is lanceolata, and I am assured that the variety so designated in some catalogues is really grandiflora. In the "Dictionary of Gardening" both are given, but I do not find that both are given in many catalogues. It is a very showy perennial, blooming all through the summer and autumn, and giving a large quantity of flowers very suitable for cutting.

Cypripedium spectabile.—A very beautiful, perfectly hardy, and free growing terrestrial Orchid from the swampy regions of North America; and while it is a fact that it is very difficult, nay, almost impossible, to get some of our British Orchids to succeed under cultivation—that is, in the open ground, this very beautiful species succeeds with very little trouble. It rejoices in the swamps of the North American Continent, and must therefore be planted in a cool and moist situation, but not shaded, as in its native habitat it is exposed to the full glare of the sun. It is difficult in my garden to find such a place, but I have one small pot; and though a clump of it has flourished for some years, throwing up ten or a dozen flowering shoots, and sometimes with two blossoms on a stem. I found, however, that the hot dry summer of 1888 tried it very much, impairing, I imagine, the vigour of the bulbs, and it is now only recovering from the drought of that year.

Eremurus robustus.—This belongs to a somewhat limited genus, which has only been introduced into cultivation within the last ten or fifteen years. They are mostly natives of Turkestan, and seem to be perfectly hardy. Being plants of exceeding great beauty and stately in growth there is little doubt that they will be readily welcomed when they become plentiful; they are, however, of slow growth, and do not flower until the plants are four or five years old. This variety grows to a height of 7 or 8 feet. The soil best suited for them seems to be a friable sandy loam with some mixture of decayed cow manure. My friend Mr. Grant grew them well at Hope End near Ledbury, and has described his treatment of them in a contemporary, where he states that they flourished admirably with him, and were in the finest possible condition when he was obliged to give up his garden. *E. robustus* is the most vigorous, and probably the easiest to cultivate of the whole group. The roots are fleshy and spread out widely, and in planting care should be taken that they are not injured. The colour of the flowers is a beautiful peach shaded with lilac, and the form of the spike reminds one of a giant Asphodel.

Eremurus Olga is one of the dwarfest of the genus, but one of the most beautiful. It forms a dense spike of pinkish lilac flowers closely set together, and as large as a five-shilling piece. It is somewhat late in flowering, and a spike of it exhibited a couple of years ago by Mr. Ware at one of the Aquarium Shows in September was greatly admired.

There is one word of warning which ought to be sounded, Be careful that you get the right plant. There are some of the family very uninteresting, but being plentiful they are too frequently substituted for the rarer kinds to the great disappointment.

Exogonum or *Ipomœa purga*, the Jalap plant, a very beautiful and in some parts of our islands a hardy climber. I have seen it flowering in Canon Ellacombe's garden at Bitton, near Bath, where in a warm and sunny corner it seemed to be quite at home. The flowers are pale, and are abundantly produced. This is the plant from which the well known medicine jalap is produced.

Gypsophila paniculata.—It may be said, and said truly, that this is neither new or rare, but if we may take the latter in its meaning of "seldom seen," it is entitled to be so ranked, for I have been astonished in how few gardens it is to be seen. It has no pretensions to showiness, quite the reverse. Its flowers are very insignificant, and yet I know nothing more useful for making up a bouquet. I was most struck with it some years ago in Paris, and saw how very useful the bouquetists found it in giving lightness and elegance to their productions. It is quite hardy, and forms a large thick fleshy root. I may also mention that another plant I have found especially valuable for the same purpose is the pretty little annual *Omphalodes linifolia*. We find it much admired as giving lightness and elegance to a vase of cut flowers. Of course where people think that a bouquet ought to consist of as many flowers as you can lump together these plants will be thought little of, but where elegance and lightness is sought for they will be found most welcome adjuncts for the purpose.—D., Deal.

(To be continued.)



A LATE WHITE CHRYSANTHEMUM.

IN answer to "H. G.," who inquires for a white Grandiflorum for late work, I may say that I have not seen one which approaches that variety in form. The nearest to it for late use is L. Canning, a pure white Japanese, having long reflexed flat florets, which appears to be good for late flowering. It is only in this respect that I can liken it to Grandiflorum, which is well known to be an incurved Japanese. Unfortunately many of the late varieties are of poor quality, or this may be owing to the methods adopted in growing the plants for the production of late blooms. The variety I have named was sent out last year, and failed as an ordinary November flowering sort, owing chiefly, I think, to the rapid manner in which propagating was carried out to meet the orders for this variety, in consequence of which the stock was weakened. Anyhow, the blooms resulting from the plants came in perhaps at a more favourable period than though they had developed fully in November. I would advise "H. G." to grow L. Canning for the purpose of late flowering.—E. M.

MISTAKES IN CHRYSANTHEMUM CULTURE.

NEVER during the one hundred years that have elapsed since the introduction of the Chrysanthemum into England has it had so many admirers or so many new cultivators as at present, all of whom aim to excel and who try to grow the flower to perfection, and in their anxiety to do so sometimes mistakes are made amusing enough to everyone else except the growers. As from time to time many of these have come under my notice, I will chronicle a few of them to keep beginners from the rocks that wrecked others in the early part of their career as Chrysanthemum cultivators.

It is thought by many that some secret composition of soil is necessary before first-class blooms can be produced. A case of this kind came under my notice; some time ago at a large exhibition a gentleman in conversation informed me that he had that day been mixing his soil for the final potting of his Chrysanthemums the following season. He said he had a mixture of his own which was certain to produce fine blooms, and he was anxious to have some fine Japanese the following year. I intimated that I should like to be in possession of such a secret, and he said I should have it. Certainly it was a "mixture." This was the prescription:—One half loam, the other half to be made up of bone meal, dissolved bones, soot, charcoal, leaf mould, decayed horse droppings, dry blood, and pounded oyster shells. My opinion was asked as to what I thought of it. I inquired if he had grown Chrysanthemums before in such a mixture; the reply was "No; but I am certain it will suit them." I said my own opinion was there was no need for any such mixture, that some of the ingredients enumerated were in such a form that they could not be assimilated by the plants in their short season of growth at the same time. Something else is required, and that is unremitting attention from the cutting to the production of blooms, then success may be hoped for. The following year I saw the blooms produced by the mixture which had been relied on. Attention had not been given to the plants when they required it, the mixture was all-sufficient and the blooms were nil. But the gentleman profited by his mistake, and since that time he has won prizes with creditable blooms. Moral: Do not depend on "mixtures." The simpler the com-

post the better for the plants. Have the pots filled with roots, then other food can be given as they require it.

Feeding is another fertile source of mistakes. The beginner is anxious, and he is quite sure that there is some secret preparation which they must have. Some think sulphate of ammonia the best; it is no doubt a powerful stimulant, but should be used carefully, and not exceed $\frac{1}{2}$ oz. to the gallon of water. I received one morning a letter from a would-be exhibitor as to what was best to be done under the following circumstances. In order to have his blooms ready by a certain date he had been giving them double and treble supplies of the ammonia, under the impression that by these means he would hasten the blooms as they looked like being late; the result was the leaves hung limp about the stems, and altogether they had anything but a promising appearance. The only thing I could advise him to do was to carry them to the rubbish heap and try again. He did try again, and since that time has been fairly successful. At a small show one year an exhibitor had obtained a third prize in a class for twenty-four blooms, half Japanese the other half incurved; amongst the former were two fair blooms of Comte de Germiny and Fair Maid of Guernsey, which he declared were from plants that had been supplied with sugar. "I thought," said he, "if it was good for feeding animals it would make good blooms, and it has; look at them."

Taking the buds is a source of trouble and mistake to beginners, securing the bud would perhaps be more correct. Late in September I went to see a collection of 400 plants with which the proprietor was not satisfied. On my arrival I was taken to the kitchen garden where a temporary structure was erected in which to flower the plants; no signs of bloom could be perceived by the owner, nor could I. The general factotum who, amongst other duties, had that of attending to the Chrysanthemums, was sent for, and on my inquiring what he had done with the buds that ought to have been on the plants, he said, "Wha a tuke em off as t' beuke said a had." Some of the early varieties were again showing buds, and I pointed out to George that these must be left on or there would be no blooms. He said, "Then what's the good o' t' beuke sayin' I ha' ta tak' em off if I hev'n't?" Great things were expected from these plants in the shape of blooms at a local show; George had told everybody how tall they were, what thick stems and large leaves they had; but no blooms from these plants were at the show. This is not the only instance that has come under my notice where buds have been "taken—off."

Dressing Blooms.—Another grower who I do not think profits by his mistakes is an authority in his way on this subject, "tworling" he calls it. He has exhibited three years in succession; but although his Japanese are fairly good his incurved are always very rough, as a consequence his record for three years' labour comprises two third prizes. The mistake in this case is he is over-anxious; he secures the first buds that the incurved varieties produce, especially of the Queen family, depending on his ability "to tworl them up," the said "tworling" resulting in bruised unsightly blooms, hence his place at the exhibitions. Dressing of this kind should always be avoided; nobody can "tworl" a rough bloom into an exhibition bloom.

I must not trespass further, or I could multiply instances of mistakes, and if we only profit by our mistakes as did a young grower who had never seen a Chrysanthemum show, but who thought he had good blooms and carried three dozen blooms in a box of three twelve-stands seven miles on a frosty morning two years ago, his precious blooms he would not have jolted in any conveyance. I am sorry to say he did not obtain a prize; but he saw where his mistake was, and the same earnestness that helped him in his long trudge since that time has made him a dangerous opponent. In conclusion, I would say to all beginners, You are sure to make mistakes; but try again, remembering that there is no royal road to success, and that it is only by patient persevering industry anyone can hope to become a successful cultivator of Chrysanthemums.—T. B.

BOMBAY GARDENS.

(Continued from page 53.)

THE soil of most Bombay gardens is very different from what we are used to see at home. What principally strikes the new comer is the prevalent red colour of the soil of our hills, and many people will, no doubt, at the first sight think the colour and objection to its fertility as indicating a presence of iron. I have not been able to find any report on its exact chemical contents, but though there can be no doubt that the "red earth" contains a considerable per-centage of iron salts it is, on the other hand, certain that these must be comparatively harmless to vegetation, or that their action is so modified by the presence of other valuable matter that they only assist in forming a most valuable and fertile soil, which in regard to its physical qualities partakes of the most desirable properties of the varieties of soil known to us from home. It is porous and at the same time retentive, and has, I believe, a great capacity of absorbing power (a property upon which the fertility of a soil principally depends). In the lower lying districts of Bombay we meet clay, humus, and sand, only slightly differing from the same kinds of soil at home, but which it is not possible, even by artificial means, to so enrich as to compare favourably with the red earth of the hills, at least in respect to producing the brilliant colouring of shrubs, &c., for which, especially Malabar Hill, is justly famed. The public health department has always a large depôt of most valuable manure, by which means it is easy, at a comparatively small cost, to enrich the soil when required.

A few words about the legal aspects of gardens in Bombay may

perhaps be found useful. In nine cases out of ten the occupant of a house in Bombay is a tenant, and his rights to the garden, out-houses, and other parts of the property, comprised in the compound, are to a certain extent restricted. He will, as a rule, be required to employ a native gardener or a *mallee* to maintain the existing garden. He may not without the landlord's permission cut down any trees or remove any plants once established in the garden, nor remove any part of the ground, be it rock, soil, or other material. In regard to alterations of existing roads, drains, or water service pipes the owner must also be consulted. On the other hand, he is at liberty to plant whatever he likes in the ground, but it must be always borne in mind that, however much the tenant improves the garden or enhances its value by planting rare or choice plants in the ground, he can never claim any recompensation for such additions, and the plants once in the ground will for ever remain the property of the landlord. It is principally owing to these causes, and to the frequent changes of residence, that most of the Bombay flowering and foliage plants are cultivated in pots or tubs, the only way by which the grower can secure his ownership to the plants. In some compounds, however, the rock is so near the surface that the available depth of the soil will not allow of any other way of cultivation. It is therefore usual by a change of tenancy that the stock of plants is either sold by public auction or privately bought by the new tenant, who will often experience great difficulty in arriving at a fair valuation of such plants, especially when a new comer to Bombay.

Another difficulty will be to secure a good *mallee*. As a general rule one *mallee* will be found sufficient to maintain a well-kept garden averaging from 5 to 10,000 square feet in area; for a garden of greater extent an assistant will be required for every additional 10,000 square feet, while for very extensive gardens two men per acre will be found sufficient. Should the *mallee* be left entirely to himself he will soon become careless and negligent, and continue to do all kinds of work just as his father did and his grandfather before him. Unfortunately, the *mallee* is not a gardener in the right sense of the word, and he has, as a rule, no interest or love for his plants, which he treats quite mechanically, without ever thinking of them as living subjects. He will water a plant whether it is dry or not—that makes no difference to him; he thinks it his duty to water every pot, regardless of its contents, and he often wastes water by continuing to water a plant that has been dead for a long time. He will generally know when and how to propagate plants or to transplant or repot them, how to clip the lawn or grass border; but it is far from safe to leave him alone in any kind of pruning, or he is sure to disfigure the plant. He knows something about weeding, but his religious superstitions will rarely allow him to uproot certain plants as the sacred "tulsi" (*Ocimum sanctum*), or the holy "peepul" (*Ficus religiosa*), and should a plant which he knows not to be a weed happen to have found its way into a pot or tub containing quite a different plant, he will sooner allow the former to kill the latter than ever think of uprooting it. He has a perfect horror of caterpillars, chiefly the hairy ones, and it is only with the greatest reluctance that he consents to pick them off when told, and unless closely watched he will not willingly destroy them. He will seldom of his own accord think of supporting a plant with a stick or trellis-work before actually necessary, and he will then, as a rule, choose the thickest possible pole he can find, or the stoutest rope he can get hold of. At first he will probably, if you understand his language—which, by the way, is Mahratti—meet your remonstrances with incredulity, and use all his eloquence, which principally consists in varied repetitions, to persuade you that such and such a thing can be done in this country, that this plant must certainly die if you transplant it, or that that one will never flower any more if you prune it, and so on, until he discovers you are firm and knows more than himself. Then you will find that your labour is not wasted, and that he is willing to learn and be taught. One of his favourite games, which in most cases is but a kind of policy, is to simulate a perfect ignorance of your language, even if you talk Mahratti; but if you persevere he will soon understand you, and he will respect you the more the less knowledge of his language you show him. His ideas of art are generally limited to the acquaintance with the straight line and its use or abuse in forming squares, diamonds, &c. You may find him able to draw a circle, but as a rule he is totally incapable of using arcs or curves in laying out gardens or flower beds. As regards the arrangement of flowers and plants, you will in most cases find it necessary to give him a course of instruction, and he may occasionally attain to great proficiency in this art. The *mallee* is, as a rule, honest, sober, and very clean, his religion enforcing two or three ablutions daily.

(To be continued.)

HORTICULTURAL APPLIANCES AT THE CRYSTAL PALACE.

MARCH 3RD TO 31ST.

RELUCTANTLY it must be admitted that the Exhibition at the Crystal Palace has not realised all the expectations formed concerning it, not from any want of merit in the exhibits there, but because the range is too limited. To have rendered the display thoroughly interesting much more might have been included with advantage, and was, indeed, absolutely requisite to render the Show representative of an important department in horticulture. Of implements, for instance, the display is extremely scanty, being confined chiefly to insecticide distributors, but there was wide scope for an exhibition of these alone. Conservatories and houses of various descriptions are numerous and

good. Lawn mowers are not very abundant, but of excellent character. Boilers and heating apparatus come from few firms, and the remainder of the display is comprised within the wide term "sundries." No attempt has been made at classification, but each exhibitor has endeavoured to secure a good position, has paid a certain sum for the space allotted to him, and has there displayed his goods to the best advantage as he would in his own establishment.

It must not be understood from these remarks that the Show is devoid of interest; on the contrary, it is well worthy of a visit by professional or amateur horticulturists, who will be sure to find something to tempt the money from their pockets. But it falls short of what was desired as an exhibition in the Crystal Palace, because it is too much in the style of those seen at frequent intervals at Islington. Possibly the experience gained will lead to better results another year, for it is said the experiment is likely to be repeated.

This week we shall not be able to refer to the whole of the exhibits, but will give a general summary, and reserve for further comment some of the more important appliances that are distinguished by their novelty and usefulness. Taking the stands in the order they were visited, the first to be noted are the seed stands.

Messrs. Sutton & Sons, Reading, have one of their elaborate and handsome seed cases, such as are seen at the agricultural shows, comprising, with seed samples, models of vegetables, Potatoes, coloured illustrations of flowering plants, and photographs of the Reading establishment. Near to this is an admirable stand of similar character from Mr. C. W. Cousins, 13, High Street, Wood Green, in which seeds are very neatly displayed, together with samples of Potatoes, Mushroom spawn, &c.

The Stott Patent Insecticide Distributor Company, Manchester, have an important exhibit comprising "sprayers," "sprinklers," and "distributors" of various kinds, all constructed on the principle which has already found so much favour. Insecticides of several kinds are also included.

Messrs. Corry, Soper & Co., 16, Finsbury St., E.C., have a large pyramidal stand upon which are arranged a series of artificial manures and insecticides for which the firm is noted. Standen's manure, lawn sand, nicotine soap, zinc labels, the useful fumigator, the letherion, with tobacco juice, tobacco powder, and many other useful articles.

Messrs. Barford & Perkins, Peterborough, contribute a large exhibit of garden rollers and lawn mowers, amongst the latter being various sizes of the "Godiva" lawn mower, a light and efficient machine of proved merit. The Bowdon marker for lawn tennis and similar uses is a convenient machine well adapted for the purpose for which it is intended. Hemingway's London Purple Company, 60, Mark Lane, E.C., have samples of the substance which has been so extensively tried and recommended in America as an insecticide for fruit trees. An instrument for distributing the London Purple or Paris Green upon the trees is also shown. The Gwaun-cae-Gurwen Collieries show samples of their anthracite coal. The Standard Manufacturing Company, Derby, have a number of their tree and shrub pruners of various forms, including the Myticuttah, the Standard, and others of a similar character, simple in construction, and very powerful.

At the opposite end of the Palace Messrs. Wrench & Sons, Ipswich, have one of the most extensive and important exhibits in the whole Show. This comprises numerous spacious and handsomely constructed conservatories, greenhouses of various sizes, frames, wheelbarrows, and garden requisities of a miscellaneous character, such as seats, hammocks, tables, ladders, and scores of others. Very notable, too, are the folding-chairs, strong, yet light, and occupying but little room. Benjamin Edgington (Limited), 2, Duke Street, London, have tents, belting, shading, frigi domo canvas, and innumerable other articles well represented.

The Thames Bank Iron Company, Upper Ground Street, occupy a large square block with boilers and heating apparatus, valves, &c. The Champion horizontal tubular boiler is notable amongst many others of diverse forms adapted for special houses. Mr. W. Cooper, 747 to 751, Old Kent Road, also has a large space allotted to him, and filled with amateurs' greenhouses in many styles and sizes, lightly constructed, neat, and useful. A varied exhibit comes from Messrs. Osman & Co., 132, Commercial Street, E., including sundries of all kinds, insecticides, manures, and tobacco paper, with dried and artificial flowers, wreaths, baskets, bulb glasses, mats, netting, and syringes. In another portion of the Exhibition, specimens of Snow's patent hand pump are shown, for which Messrs. Osman & Co. are agents, and it deserves the notice of all visiting the Palace, as it appears to be a simple and easily worked instrument, likely to be very useful to amateurs.

Messrs. Ransomes, Sims, & Jefferies (Limited), Ipswich, have an excellent display of lawn mowers of the chain and new automaton types, both machines of considerable merit. Mr. Conway G. Warne, Weston-super-Mare, shows ornamental pottery in a variety of forms, as, besides the ordinary garden pots, there are vases, baskets, and stands of every imaginable form, and many extremely artistic.

In addition to those already named the following also exhibit—namely, Messrs. Chadborn & Coldwell, Thames Street, who have a series of their admirable lawn mowers; E. Newton & Co., Hitchin, reform glazing; W. Clark, Reading, samples of patent glazing; J. Groom, 12, King Street, Kensington Square, aviaries and wire-work; W. G. Iles & Co., Warner Street, Camberwell, ornamental pottery; Gaymer, Ipswich, samples of cider and Apples; and R. Hornsby & Sons, Lincoln, a specimen of the Strawsonizer.

We may remind intending visitors that the Show remains open every day until March 23rd.



HARDY FRUIT GARDEN.

PLANTING.—Arrears of planting should now be proceeded with while the weather continues open, using all possible speed to complete the work before the young growth commences. Gooseberries are the first to feel the effects of mild weather in spring, and their planting should therefore be finished at once. Raspberries and Currants come next in order with wall fruits of various kinds, and standard Apples, Plums, and Pears are generally the last to push into growth, but planting of all kinds should be finished by the last week in March, and sooner if possible. The holes for the trees should be dug out 6 inches farther than the spread of the roots in order that these can be laid out evenly all round. The bottom of the excavation should be loosened to allow the water to pass away freely. If the soil is very wet, it must not be trodden with the feet, but placed firmly over the roots with the spade. Take care that the trees are planted exactly the same depth as they were in the nursery. In cold wet soils it is often the practice to plant on mounds above the surrounding surface. This at best is only a partial remedy, and it is far better to drain the land and make it otherwise suitable, or to choose another piece.

STAKING TREES.—All standard trees and others that may require it should be secured with stakes when they are planted to prevent "wind waving," whereby the top of the tree is rocked about until the stem and roots are loosened and strained, and the soil worked into a puddle. This is no uncommon occurrence in orchards, and accounts for the ill condition and death of many fruit trees. Standard trees are best secured by inserting two stout stakes to each tree about 1 foot from the stem, and nailing a cross piece on the tops of these on which to fasten the tree just below the branches. The points of the uprights last longer if they are previously soaked in tar or creosote. A piece of old sacking or hayband should be wrapped around the stem of the tree before tying to preserve the bark from injury.

MULCHING.—Trees that are planted now may be at once mulched with some short strawy litter, or similar substance. This ought to extend about 1 foot beyond the extremities of the roots to prevent the drying winds of March penetrating to them, and also to keep out frost and cold. Planting should never be done while snow or hard frost is on the ground.

PRUNING.—The tops of newly planted trees can be pruned well back, either before or as soon as growth commences, provided they have plenty of good roots, and promise to do well, but if from any cause they are in a weak state some persons consider that pruning should be deferred until next season, which will give the trees time to get established, and enable them to make a vigorous start afterwards.

SELECTION.—APPLES.—*For Kitchen Use.*—Lord Suffield, Lord Grosvenor, Ecklinville, Manks Codlin, Grenadier, Cox's Pomona, Warner's King, Golden Noble, Stirling Castle, Blenheim Orange, Fearn's Pippin, Northern Greening, Wellington, Reinette de Canada, Court Pendu Plat, and Allen's Everlasting.

For Dessert Use.—Mr. Gladstone, Williams' Favourite, Early Margaret, Worcester Pearmain, Wyken Pippin, Cox's Orange Pippin, Herefordshire Pearmain, and Golden Knob.

For Exhibition.—Peasgood's Nonesuch, Emperor Alexander,* Lord Suffield, Blenheim Orange,* Cox's Pomona,* Ecklinville, New Hawthornden, Warner's King, Loddington, Lord Derby, Golden Spire, Golden Noble, Bismarck, Schoolmaster, Cox's Orange Pippin,* King of the Pippins,* Wyken Pippin,* Worcester Pearmain,* Wellington, Dumelow's Seedling, and Alfriston. Those marked * are used for dessert purposes. Soils and situation affect some varieties adversely, and planters should be guided to a certain extent by local advice.

PLUMS.—Early Rivers, Early Orleans, Victoria, Oullins Golden Gage,* Jefferson,* Kirke's, Pershore, Purple Gage,* Reine Claude de Bavay,* Coc's Golden Drop.* Those marked * require a wall in cold districts.

PEARS.—Beurré Giffard, Beacon, Williams' Bon Chrétien, Beurré d'Amanlis, Madame Treyve, Fondante d'Automne, Emile d'Heyst, Durondeau, Louise Bonne of Jersey, Doyenné du Comice, Marie Louise, Pitmaston Duchess, Passe Colmar, Winter Nelis, Glou Morceau, Bergamotte Espereu, and Nee Plus Meuris. As a rule, these should be grown either as bush trees or espaliers on walls or fences. Very few Pears can be relied upon for a good crop as standard trees, unless they are in favourable districts. Among the best for the purpose are Beurré d'Amanlis, Louise Bonne of Jersey, Beurré Bosc, Beurré de Capiaumont, Williams' Bon Chrétien, Beurré Diel, Marie Louise, and Hesse.

PEACHES.—Where warm south walls exist this fruit deserves more extensive cultivation outdoors, and better attention in keeping the trees entirely free from insects. They are perfectly hardy if the wood is thoroughly ripened in the autumn, and every precaution should be taken to secure this end. In doubtful districts only early fruiting varieties, such as Alexander or Waterloo, Hale's Early, and Early Louise should be planted. Other good hardy sorts are Dymond, Stirling Castle, Early Albert, Violette Hâtive, Princess of Wales, and Late Admirable. In cold districts much help towards ripening the wood may be afforded

by providing a lighter and warmer soil than is usually given to this fruit, and in making the borders firm, and from 1 to 3 feet above the level of the surrounding soil.

FRUIT FORCING.

Vines Started at the New Year.—Now that the best show of fruit can be determined the final disbudding must take place, but it is not wise to be in too great a hurry about that, for it is not always those that appear the best that develop into the best bunches, yet the sturdier growths, as a rule, are much best, therefore retain those only, rubbing off the others. Be careful in tying down the shoots, not detaching the shoot at its base, nor causing it to snap by bringing it down too sharply at the point. Bear in mind that the object of disbudding is to strengthen the growths left by giving them more space for exposure to light, and if erring at all it ought to be on the side of too much rather than too little space. Overcrowding the foliage is the greatest evil in fruit culture. Do not hurry the stopping; let at least two if not three good leaves be fairly formed before taking out the point of the shoot, and where there is room four or more leaves may be left, and these will have greater elaborating power than double or treble the number of lateral leaves. Stop all laterals below the bunch at the first joint, or they may be rubbed off except from the two lowest leaves, pinching these laterals at the first joint; but those on a level with or above the bunch may be allowed to extend as space admits, yet on no account must they be allowed to encroach on the principal leaves. When in flower afford a night temperature of 60° to 65°, 5° more when mild, with a rise of 10° to 15° by day from sun heat, closing at 80°. Muscats require a higher temperature, but it is a great mistake to attempt growing them in structures mainly devoted to Black Hamburgh and similar varieties. An overmoist or a very dry atmosphere must be equally avoided. For Vine flowers set best when the atmospheric moisture is not excessive.

Late Vines.—These require a long season of growth, as to insure the Grapes keeping well they should be fully ripe by the middle of September. In order to effect this start the Vines not later than March, and the best results attend giving them more rather than less time, therefore the Vines may be set to work at the end of February or beginning of March. Inside borders may be well watered, affording the water at a temperature of 85° to 90°, and if there are fermenting materials at command a bed may be made upon the border, which will lessen the necessity for fire heat and induce a regular break. Care must be taken that the roots of the Vines do not penetrate any portion of the fermenting material, that must afterwards be removed when the Vines are advanced in growth—in fact, the fermenting material must be turned over frequently as a means of liberating ammonia and allowing the moisture generated to pass off freely. The rods may be sprinkled two or three times a day, maintaining a night temperature of 50° to 55°, and 65° in the daytime, by which means the Vines will start freely, and there will be every chance of the Grapes becoming thoroughly ripe by September, even such varieties as Gros Colman and Gros Guillaume, which require a month or six weeks more time to ripen thoroughly than Lady Downe's and others. All late Vines should be dressed without delay, the house thoroughly cleansed, and the border surface dressed, removing the loose surface soil and replenishing it with fresh turfy loam, to which has been added an admixture of steamed bone meal and wood ashes, at the rate of a quart each per bushel of soil; about an inch dressing is ample. If these are not obtainable use 3 ozs. of superphosphate and 1 oz. nitrate of potash (saltpetre) per square yard, distributing it on the surface, leaving it for waterings to wash in. Artificial manures are excellent, indeed they are in some instances preferable to stable or farmyard manures, as they have not the tendency to leave a deposit of soapy matter and a close surface behind. Place a moderate covering of some protective material on the outside border to prevent chill from falls of snow or heavy rains and frost.

Late Hamburgh Houses.—Keep these cool and dry, but the borders must not be allowed to become dust dry and crack, yet a moderate amount of manure only will be necessary to preserve the roots in sound condition. Ventilate fully at and above 50°, and when that becomes the mean of the external air, or a little before, the Vines will break naturally, which usually takes place during April, the only assistance required is to maintain an artificial temperature of 50° to 55° at night and on dull days. The Vines will set their crops by the early part of June, and swell them with sun heat; artificial heat only being required after the Grapes begin to colour, as they are much improved in quality through ripening in a higher temperature: indeed, the Grapes must be thoroughly ripened or they will not keep well, either on the Vines or bottled.

Vines from Eyes.—Eyes inserted as previously advised have rooted, and if in small pots they may be shifted into a larger size as soon as the roots reach the sides, standing the pots on shelves over hot-water pipes in preference to plunging them in bottom heat, or if the eyes were inserted in pots or pans, several together, they may be placed in small pots singly, plunged in bottom heat to insure speedy root action, and when the roots reach the sides transfer them to 6-inch pots. Syringe well amongst them, and stop those intended for fruiting at the first joint of the laterals, but those intended for planting out this season, whether grown in pots or turves, may be allowed to retain all the growth made in order to manufacture roots, but thoroughly solidified wood is of vital importance to the production of fruit.

FIGS.—Earliest Forced Trees in Pots.—Plunged in bottom heat, water will be required abundantly, taking care to apply it at the same temperature as the bed, or 70° to 75°, and alternating with

liquid manure, which must not be too strong, nor less in temperature than that named. Maintain the temperature at 60° to 65° at night, admitting a little air at 70°, but not so as to lower it, closing at 75°. Thin the fruit as soon as the best placed and most promising can be selected for the crop. The thinning should be done some time before the last swelling commences.

Early Forced Planted-out Trees.—Those started at the new year are making good growth, and should have the points of the shoots which issue from round the base of the terminals pinched at the fifth or sixth leaf. Avoid overcrowding, keeping the growths sufficiently far apart for the admission of light and to insure the solidification of the wood; therefore thin the shoots where they are too crowded, and attend to tying them to the trellis as they advance. Keep the night temperature at 55° to 60°. When it reaches 65° by artificial means in the day admit a little air, increasing the ventilation with the temperature and reducing it in like manner, closing at 70°, syringing twice a day, and maintaining a genial atmosphere.

CHERRY HOUSE.—Upon ventilation depends success or failure in growing Cherries. Make sure to have a free circulation of air passing through the house whenever the temperature exceeds 50°, regulating the amount by the conditions of the external atmosphere. Maintain a night temperature of 40° to 45°, and employ fire heat to raise the temperature to 50° by 8 to 9 A. M., preventing its falling below that through the day, turning off the heat at closing time. Fertilise the flowers either by shaking the trees gently or distributing the pollen with a camel's hair brush, feather, rabbit's tail, or plume of pampas grass. Aphides must be kept in check, but it does not answer to fumigate or spray the trees with an insecticide whilst they are in flower, and it ought not to be necessary provided they were perfectly clean previous to the flowers expanding. If there be any aphides do not delay fumigation or syringing with an insecticide as soon as the fruit is set. Grubs infest Cherry trees. One kind rolls itself up in the leaves, and can be destroyed by squeezing, but the other is the greatest pest, and will be found encased on the under side of the leaves, giving them the appearance of being scalded. From the leaves it makes its way to the Cherries, perforating and destroying them. The only means of riddance is to examine the trees occasionally and destroy the grubs. See that trees in pots are well supplied with water, and that the borders are not allowed to become dry.

PEACHES AND NECTARINES.—*Earliest Forced House.*—The bright weather has advanced the fruit wonderfully, it having made the first swelling and will soon enter upon the stoning process. Early and gradual thinning having been carefully attended to there will be little more than the necessary quantity—namely, one fruit to every square foot of trellis covered by the trees. Vigorous trees may have the fruit left a little closer, but avoid taxing them too much. More Nectarines are usually left, which in some measure accounts for their being under-sized as compared with Peaches.

If there is more fruit than specified remove the smallest, and a few more than are required may be left for contingencies; but if the wood was ripe and the trees are healthy and well nourished there is little danger of the fruit falling. Vigorous trees are the most uncertain in stoning, as they are prone to rush into wood growth and throw off the fruit. The best remedy is lifting, so as to concentrate the vital forces on reproduction. Keep the temperature during the stoning process as equable as possible, as sudden checks by draughts of cold air in the daytime and too high a temperature in the night may prove disastrous. The night temperature may range from 60° to 65°, but 5° less is safer, particularly in severe weather, and in the daytime 70° to 75° with sun heat, and about 65° by artificial means when the atmosphere outside is cold and the sky overcast. Secure the growing shoots to the trellis as they advance, keeping those retained to attract the sap to the fruit stopped at the second or third joint. Red spider must be kept in check by syringing with water at the same temperature as the house, or if thrips and brown aphides appear fumigate carefully when the foliage is quite dry. An overdose cripples the foliage and brings off the fruit. For destroying the insects named nothing is safer and better than a solution of softsoap, 2 ozs. to the gallon of tepid water. Take care that the soil does not become too dry, not being deceived by the surface of the border, for that is often wet through syringing whilst the soil beneath may be dry; therefore examine, and if necessary give good supplies of water or liquid manure to weakly trees. Avoid, however, undue excitement, as over-stimulation causes the trees to rush off into growth leaving the fruit behind, it frequently being cast in stoning from that cause.

PLANT HOUSES.

Panicum variegatum.—Transfer into 5-inch pots plants that were rooted in a small size in September. If the shoots are pegged into the surface after potting they will grow rapidly, and become useful for furnishing the front row of stoves and other warm houses. Plenty of cuttings may now be inserted in 3-inch pots filled with sandy soil; they will root quickly if shaded from the sun, kept close and moist under hand-lights in a warm house. Those intended for baskets may be inserted in pans, and then transplanted into the baskets as soon as they are rooted and have been hardened so as to bear exposure in a warm house.

Selaginella casia.—This is a capital plant for edging when associated with *Panicum variegatum*. It is necessary, however, to place this plant into slightly larger pots than the *Panicum* or it will fail to show an even surface. Plants that have been kept cool may be divided and potted; they grow freely in any moderately light compost, for instance

equal parts of loam, leaf mould, and sand. They will start freely in a vinery, or may be placed into a warmer structure until they are ready for the stove, or where they are to be employed when in good condition.

Caladium argyrifolium.—These may be shaken out and started in small pots in a warm house. It is a good plan to plunge the pots, to prevent watering, and cover the surface with cocoa-nut fibre refuse until they commence growth. Other varieties may also be started. It may be pointed out that these beautiful foliage plants, after they are once started, are frequently grown too close and warm. They scarcely bear moving about when grown in warm stove. The conditions of a vinery, when the roof is not overshadowed with foliage and the night temperature can be kept from falling below 60°, suits them well. For conservatory decoration we have found them invaluable from the end of June or early part of July. Pot the tubers in a compost of light soil, and finally place them in good loam, one-seventh of decayed manure and sand; a little leaf mould will do no harm.

Achimenes.—Shake these out of the old soil if not already done, and place the tubers thickly together in pans in a compost of loam and leaf mould in nearly equal proportions; add one-seventh of decayed manure and a liberal quantity of sand. Place the pans in heat, and cover with fibre the same as advised for *Caladiums*.

Gloxinias.—Sow seed where an increase in the stock is needed. The surface of the pot or pan should be even and the soil fine, on which the seed can be sown, and then gently water with a fine rose can and covered with a square of glass and shaded. Shake out the tubers of those that have rested and start them in boxes of leaf mould. Those started some time ago will be ready for potting. Good loam, one-seventh of manure and sand, will grow these plants well. Plants may rest that have flowered and completed their growth. Do not hurry them, but allow them to gradually rest. It is a mistake suddenly to withhold water.

Amaryllis.—Plants that have been stored away to rest may be taken out and repotted. It is a good plan to repot these plants annually before starting them into growth. They will do well in three parts loam to one of leaf mould and manure, to which sand is liberally added. After potting plunge them in a low house or pit where they can enjoy gentle bottom heat, such as a bed of leaves and litter affords. A temperature of 50° to 55° top heat will suit them well, with a little air daily in fine weather after growth commences.

Cissus discolor.—Few plants are more ornamental than this for covering pillars and the ends of houses when formed of brick. Train them to the top, and then allow them to hang down naturally. Positions of this nature that are covered with Ferns and Begonias are doubly effective, when this free-growing climber is allowed to hang down amongst them. In large houses it is effective in baskets, and can be grown well in them, few plants being more suitable. Prune established plants to the ripe wood, and repot them if they need it or top-dress with rich material. Plants in baskets may have as much soil as possible removed, and equal proportions of loam and manure supplied, but this plant grows luxuriantly in any rich compost.

Nepenthes.—Cut back any plants that have grown tall or fail to form pitchers. They will soon break into growth, and should be pinched when they have made four or five leaves, so that they are never without young growth, which results in pitchers being produced all the year round. Place those that need it into larger baskets. It will be necessary to take the baskets in which they have been growing to pieces, and then only remove the loose material. Drain the baskets well, and use for a compost fibry peat and a good layer of sphagnum moss on the surface and round the sides. Where plants are pruned back, the stem removed may be cut into lengths of two joints and inserted in small pots filled with sphagnum and sand. If plunged in brisk bottom heat, shaded and kept close and moist, nearly every cutting will root.

THE BEE-KEEPER.

OBSERVATORY HIVE.

"If I am correct, the idea of an observing hive was first invented by Mr. Langstroth." So says A. J. Root in the A B C of Bee Culture. Whether "there is nothing new under the sun" or not in the way of material or invention, it is certainly not new for someone to claim to be the originator of what existed before their time.

The unicomb hive I promised to describe some years since was invented by the Rev. Wm. Dunbar, minister of Applegarth, Dumfriesshire, where bees are still kept by Mrs. Landel, wife of the present minister. The hive in question differs very little from those in use at the present day, being fitted with doors, &c., just as they are now, and if I believe my eyes, frames as well. It, being fixed outside, had for a support an iron rod at each side rising from the sole, passing through staples in the edge of the hive, and had two doorways, so that when turned round one had to be closed,

and the one on the opposite side from the observer opened. His great object was to prove Huber's discoveries accurate.

The hive was tenanted in the summer of 1819, which appears to have been a favourable one for bees; but "the bees perished from the intense cold of the 1st January, 1820," for which Mr. Dunbar was sorry, as he intended to have made the hive a study during the spring and summer, watching "the whole process *ab ovo* till the final emigration of the superfluous population." In order to remedy the misfortune he started the well-provisioned hive on the 25th March for further observations, but I am not in possession of them. The following, however, are those he made in 1819:—

Observation 1.—When the bees were put into the unicomb hive in June last they, of course, instantly began building comb; but the narrow limits of their new abode being only 1 inch and two-thirds between the glasses prevented any considerable number of them from working at the top. A large portion of them, therefore, began a comb in the stick which crosses the hive in the middle (see plate vi. fig. 6), and thus two combs were going on at once, which eventually became one when the upper half reached down to the stick. It appeared, however, that there was still a want of room and of employment for these willing and industrious labourers, for to my surprise a portion of them began a comb on the upper side of the cross stick, and, contrary to their natural mode of proceeding, *wrought upwards*, so that in four days or less the upper comb and this middle piece met, and the whole separate parts were joined and became one square.

2, When the queen is about to lay an egg she puts her head into a cell and remains in that position a second or two to ascertain whether it be fit to receive the deposit; she then withdraws her head, curves her body downwards, inserts her tail into the cell, and having kept this position for a few seconds turns half round on herself, and after laying the eggs withdraws her body.

3, When the queen lays a cluster of eggs to the number of thirty or forty, more or less, on one side of the comb, instead of laying in all the empty cells in the same quarter, she leaves it and goes to the other side, and lays in the cells which are directly opposite to those she has just supplied with eggs, and in none else. In this order she seems to be scrupulously exact, and probably it is to ascertain whether there be an egg in the opposite cell that she keeps her head inserted previous to laying, longer than would be necessary merely to find whether the one she is inspecting be empty. This mode of proceeding is of a piece with that wise arrangement which runs through all the operations of the bees, and is another effect of that remarkable instinct by which they are guided, for as they cluster closely in those parts of the comb which are filled with brood in order to hatch them, the heat will penetrate to the other side, and some part of it would be wasted if the cells on that side were altogether empty or filled with honey, but when both sides are filled with brood, and covered with live bees, the heat is confined to the spot where it is necessary, and is turned to full account in hatching the young. Part of the comb was filled with brood, the rest of the square being all sealed honey. On the opposite side the brood comb was exactly of the same shape, insomuch that on the narrowest inspection I could not discern one cell where there was brood in the one and honey in the opposite.

4, The shade round the brood comb is designed to represent cells filled with a mixture of farina and honey for nourishing the young, and which I saw often carried to them by the older bees. Where the brood cells covered a considerable surface these store cells were in three rows, as represented in the figure. Where they were of less extent there were two rows and at the neck of the figure only one, thus preserving a due proportion between the quantity of the food and the extent of the brood cells.

5, When a bee arrives loaded with farina, which is now known to constitute the principal ingredient in the food of the young bees while in a maggot state, she searches for a cell in which she may deposit her burden, and having found one she fixes her two

middle and two hind legs on the edge of it, and curving her body, seizes the farina with her forelegs, and makes it drop into the cell, after which she hurries away to renew the labours, while another bee inserts her head into the cell and packs it properly, probably mixing, as may be judged from the moist state in which it appears on her retiring, a little honey with it.

6, It was ascertained by Huber that wax is the produce of saccharine part of the honey, and that it exudes from the bodies of the bees between the rings of their bellies in the form of small thin scales. In confirmation of this fact I saw one bee, and only one, in the very act of squeezing out thin scales of very pure wax from the rings of her belly. She retreated from my view before I could discern her after proceedings.

7, I observed the queen at one time hard pressed to get quit of her egg, and not being able to find a cell readily, she dropped it on the edge of one, when half a dozen bees, like so many dogs after a bone, instantly ran to it and devoured it.

8, In the honey months of July and August, when the weather is very fine, the bees form comb intended for containing honey alone, and different from that which is destined for brood. The texture of this is much thinner, the cells considerably larger and deeper, and as the honey is then in the hot season of a rarer and more fluid quality, these cells are wisely made with a much greater dip or inclination than the ordinary ones that there may be less risk of the liquid running over before it is sealed.

9, It has been often said that the queen is attended in her progress through the hive by a number of her subjects formed in a circle round her, and these have, of course, the guards of royalty. The truth is her majesty has no attendants, strictly speaking, but wherever she moves the bees she meets with in her progress instantly clear the way for her, and all turning their heads towards her, fawn upon her (if I may use the expression), lavish their caresses upon her, touching her softly with their antennæ, and this appearance has given rise to the idea that she is attended by guards. The moment she has passed a circle of her admiring subjects they instantly resume their labours and she passes on, receiving from every cluster in her way the homage due to a mother and queen.

Such are the few observations I made during the first season my hive was at work. You have the simple facts as they were noticed at the time without any embellishment, for if they add little of importance to what is already known of the nature and habits of the bee they owe nothing to the colourings of fancy. If you think them worth sending to the "Edinburgh Philosophical Journal" you are at perfect liberty to do so, and I hope one good effect of their publication will be to induce others also to contribute their mite of information. I am myself an enthusiast in the cause; nobody can study them closely without becoming so. Fortunately I have a reverend brother in my neighbourhood whose enthusiasm equals mine, and whose experience is much greater. I allude to the gentleman whose humane method of saving the lives of these insects has been made honourable mention of in a recent number of that Journal. If he, and such as he, could be prevailed on to communicate the result of their experience to the public the natural history of the bee would be better understood and its cultivation much more profitable.—Applegarth Manse, March 27th, 1820.

I have omitted the introduction and explanation of plates, these also omitted, of a most interesting article, as much to-day as it was when conveyances were slow and few, and postal communication slow and uncertain. A better written article on the subject has perhaps never appeared, while the unicomb hive his observations were made from has been but little, if any, improved upon.

DEAD BEES.

I am in receipt of letters from different bee-keepers who have been giving the Lanarkshire hive a trial. Mr. Stevenson Hamilton says, "With the exception of the Lanarkshire hive, which is healthy and no dead bees, all my others have great bins of dead at the front, and the bees are busy carrying out dead ones, white moulded.

Some I have examined I found whole seams of dead bees all clammy and wet, with plenty of meat near them too. The fact that the Lanarkshire hive is the only one having no dead bees is proof your method of wintering is by far the best."

The other letters are of a similar nature, and do not surprise me, for while bees are kept in damp hives during winter the profit in summer will either be nil, or lower a great deal than with those kept in hives comparatively free from damp.—A LANARKSHIRE BEE KEEPER.

TRADE CATALOGUES RECEIVED.

Louis Boehmer, Yokohama, Japan.—*List of Bulbs, Plants, and Seeds.*

H. Gusmus, Klagenfurt, Austria.—*List of Bulbs and Roots, 1891.*

J. Peed & Sons, Roupell Park Nurseries and Mitcham Road, Streatham.—*Catalogue of Dahlias.*

Hogg & Wood, Coldstream, N.B.—*List of Agricultural Seeds.*

E. P. Dixon & Son, Hull.—*List of Agricultural Seeds.*

J. R. Pearson & Sons, Chilwell, Notts.—*Spring Catalogue of Pelargoniums, Dahlias, Chrysanthemums, &c.*

Dicksons (Limited), Chester.—*Catalogue of Select Farm Seeds.*

J. R. Pearson & Sons, Nottingham.—*Catalogue of Pelargoniums, Chrysanthemums, &c.*



All correspondence should be directed either to "THE EDITOR" or to "THE PUBLISHER." Letters addressed to Dr. Hogg or members of the staff often remain unopened unavoidably. We request that no one will write privately to any of our correspondents, as doing so subjects them to unjustifiable trouble and expense.

Correspondents should not mix up on the same sheet questions relating to Gardening and those on Bee subjects, and should never send more than two or three questions at once. All articles intended for insertion should be written on one side of the paper only. We cannot reply to questions through the post, and we do not undertake to return rejected communications.

Single Banksian Rose (*J. W. D.*).—We shall be glad to see the flowers if you send them, but they must be carefully packed in damp moss, or it is doubtful if they will reach us in satisfactory condition.

Pompon Dahlias (*Novice*).—The following are neat and useful, possessing the characters you require—Darkness, maroon; Fairy Tales, primrose; Gem, scarlet; Golden Gem, bright yellow; Mabel, lilac; and White Button. You desire only self-coloured varieties, but many of the parti-coloured forms are very pretty and equally as good as those named above.

Insects on Roses (*S. S.*).—Wednesday morning's letters can only be answered in the shortest possible manner in the current issue. Lay the plants on their sides and syringe them thoroughly with an insecticide as hot as you can bear your hand in for ten seconds, turning them round so that every point is reached. If there were no insects on them there would be no glutinous exudation.

Unpruned Vines (*Beginner*).—We should let the buds swell on the laterals, but not push to the extent you name, then gradually remove them from the end downwards to two or three at the base of each, and from these choose the best growth in each case for bearing. When the leaves on the growing laterals attain nearly their full size the old laterals may be cut off without any fear of the Vines suffering through bleeding.

Rough Glass (*R. C.*).—There are several different forms of "fluted and corrugated glass," and some we suspect would not prevent the scorching of foliage beneath, but the close-ribbed and somewhat opaque kind that is sometimes used for glazing ferneries and Palm houses, undoubtedly breaks up and subdues the scorching effect of the sun's rays. This glass is also, to some extent, used for glazing vineries and structures for flowering plants, and in nine cases out of ten we think does more harm than good, not by scorching, but shading, causing the tissues of the leaves to be soft and the growths drawn, as well as arresting the maturation of the wood. If we could rely on brilliant days generally prevailing the glass might answer better, but dull days often predominate for weeks together, and the further obstruction to light by the glass in question is then injurious. We consider that rough glass should only be used for horticultural purposes with great discrimination, if at all.

Spraying and Syringing (*S. J. A.*).—You asked a definite question and we gave you a definite and correct reply; and now you ask for further information on a question that is distinctly indefinite—namely, "Whether spraying is essential, or whether syringing will do as well." Do as well for what? For syringing plants generally, also fruit trees for promoting growth and maintaining cleanliness, the syringe is indispensable, but for applying insecticides a sprayer distributes them more effectually and economically. We do not know that the article you mention can be had; perhaps not, or it would presumably be advertised. If you write to the Stott Insecticide Distributor Company, Limited, Barton House, Manchester, for an illustrated trade list you will perhaps find what you require. Sulphate of iron must not be dabbled in with plants, but, as we previously stated, spread on the surface of the soil when it is wet. Used at the rate of $\frac{1}{2}$ cwt. to 1 cwt. per acre it has been found beneficial to crops of the Brassica family, but we can give no assurance that it will prevent clubbing, though it is worth trying. For small experiments $\frac{3}{4}$ lb. per square rod ($30\frac{1}{4}$ square yards) is a suitable quantity to apply.

Showing Cut Flowers (*T. W. Ashton*).—You must allow us to answer your question in our own way, as replies in this column are, we have reason to believe, often of service to others besides the querists. If a schedule stipulates for "five distinct varieties of cut blooms or flowers," according to its strict interpretation five varieties of Orchids, Fuchsias, Pelargoniums, or of any other genus or kind of plant could be legitimately shown; but whether it would be wise to show them is quite another matter. The judges would be quite likely to give preference to stands which they believed more fairly represented the intentions of the Committee, and if the judges' decisions are final they would not be easily overturned on a technical point, for "custom" would have weight in the case, and it is not the custom to show in the manner you propose. You would be in a stronger position if your five Orchids were distinct in genus. Framers of schedules should strive to formulate a set of words that can only have one meaning.

Burnt Soil (*M.*).—We gather from your letter that the soil was burnt more than was needful, still as you say the brick-like lumps fall by the action of wet and frost no great harm has probably been done. The excessively dry month of February has not been favourable to the preparation of the dry-as-dust land, and it appears to us that you must wait as patiently as possible for rain. We should wait even till the end of April before planting the Potatoes rather than plant with the soil in its present state. Mr. Jenkins, the weather prophet, stated in his chart that February would be a dry month, and he was right. He also tells us that March is to be dry also, but April wet. His small charts can be had by post for 1½d. from Mr. R. Morgan, 65, Westow Street, Upper Norwood, S.E. We have seen very full and fine crops of late Potatoes by planting at the end of April and the beginning of May. We do not think you can do better than carry out your proposition, and the interchange of soil you mention is undoubtedly good practice. The weed killer named will answer the purpose mentioned, though possibly more than one application may be required.

New Boiler—Heating Arrangements (*A Constant Reader*).—The boiler you mention is a good one, and consumes almost any kind of fuel; but whether it will be sufficiently powerful is only determinable by a knowledge of the length of piping to be heated. Your object, we presume, is to heat the whole of the houses from one boiler without alteration of the present system of piping, hence the 2-inch flow and return pipes between the boiler and the several structures. That system answers very well, effecting a considerable saving of heating power. You will need diminishing sockets where the 2-inch pipes join the heating system of the respective houses, the flow and return pipes having proper rise and fall respectively from and to the boiler, with valves on each flow so as to regulate the circulation as desired. The saddle boiler might be utilised in severe weather, but it will be necessary to put valves on the flow and return, so as to detach it from the other boiler when that only is worked. We cannot give you any idea of the cost, but it could readily be ascertained by stating your requirements to one or more horticultural builders, and asking for an estimate.

Planting Quickset Hedges (*Cratægus*).—The soil cannot be too well worked and enriched for promoting free growth, and you may prepare it as if for growing fine Cauliflowers. In the production of strong boundary fences it is customary to have a ditch on the outside 3 feet wide at the top, sloping to a foot at the bottom, raising a low bank on the opposite side on which to plant. Divisional fences in fields have a ditch on each side. For some purposes and in certain positions ditches are not requisite. You do not indicate the object in view. For producing strong thick fences, the "Quick" is planted about 6 inches apart in two lines, about a foot asunder; for lighter fences in one line but a little closer. At this season the roots should be kept as damp as possible when out of the ground, planted firmly, and the ground well mulched. It is, however, better to plant in the autumn, as the Quick makes better growth the first season, and if cut down the second spring following often grows luxuriantly. In some districts plashing is resorted to in the course of a few years; and this, no doubt, makes a very firm cattle-resisting fence. The method was illustrated in the *Journal of Horticulture* with other hedges in 1886, vol. xii., pages 297 and 441. If you cannot refer to those pages we might, perhaps, reproduce the figures if they would be useful. Read what a "Forester" says in another page. He has had great experience with hedges of various kinds.

Pressing Wild Flowers (Griffin).—The principal point needing attention is in the drying, as this process must be performed gradually, or the characters of the plants will not be preserved. Thick porous paper is used, and the specimens must be carefully spread out in as natural a manner as possible, preserving the form of flowers and leaves, and in the case of small plants the natural habit. The sheets of paper and specimens should then be placed in small piles, with a stout board below and one on the top; upon the latter weights can be placed to provide the necessary pressure. The specimens must be frequently examined in the early stages, and if there is much moisture on the paper fresh sheets should be supplied and the others dried before being used again. Do not be in too great a hurry to complete the process, some plants require a long time, and if any attempt is made to "mount" them before drying is completed it will cause much after trouble. When, however, it is seen that the substance of the plants is thoroughly dried the specimens can be secured to stout sheets of white paper, by means of thin glue or strong gum applied to the principal parts of the leaves or stem, or what is preferable, by means of narrow strips of paper placed across the stems, leaf and flower stalks, and fixed to the paper by their ends with the glue. Always employ large sheets of paper, so that ample room can be allowed to the specimen, and do not fix them all the centre of paper, but let some be near the sides, as it will be more convenient for arrangement in the herbarium, as it equalises the pressure. At the base of the sheet the botanical and common name of the plant should be given, its natural order, and the place where it was found, with the date.

Cyclamens (Humber).—Plants when grown for market by experts in their culture and sold, as they usually are, just when in their best condition, would not continue producing equally fine flowers, even under the most favourable conditions—that is, if they had not been sold, but kept in the structures in which the plants were grown and there accorded the best attention. What may be termed the first fine flush of flowers (there is alliteration for you) exhaust the plants and soil to an appreciable extent, the successional flowers being the smaller in consequence. The disparity is bound to be more marked when the plants have undergone a journey and then placed in a structure differing from the one from which they were removed. At home they would receive just what they wanted in respect to temperature, atmospheric moisture, light, and support. These essentials cannot be found in due proportion in a mixed house of plants, and particularly a lofty conservatory, and especially, perhaps, if the pots are arranged on dry open latticework stages. All you can do is to take care that the soil never gets so dry as to shrink and form a slight fissure next the pots; also give weak clear liquid manure at every alternate watering, soot water as clear and pale as pale sherry being good for the plants. If they stand on a dry base, such as an open stage over hot-water pipes, that will be the reverse of good for them, and the pots should be syringed occasionally. We have not yet arrived at any satisfactory conclusion in reference to your plant named "Philandris mimosa." The nomenclature is new to us, and if we reverse the names—Mimosa philandris—we do not gain the light we wish for the purpose of identification. By the way, can it be a certain mottled-leaved plant that figured somewhat effectively in a certain prize group with which you are not unacquainted? If so, it is neither a Philandris nor a Mimosa, but a sort of phonetic mixture of both those names. Perhaps you had better send us a leaf or two, and the matter shall have our further and ready attention.

Definition of a "Cottager" (G. Armitage).—It would be difficult, we suspect, to define the term in a manner that would be generally acceptable for purposes of exhibiting garden produce at local shows, as circumstances and conditions of life vary considerably in various districts. In the schedule of a well managed amateur and cottage garden society in what may be termed a suburban district, in which a number of men work in mills, the following is the simple, concise, and satisfactory definition:—"A 'cottager' must be a person of the working class, and must not receive any professional assistance or paid labour in the cultivation of his garden or produce." In a rural district in which prizes have been competed for over a series of years the definition runs—"Cottagers are understood to be persons belonging to the class which supports itself by manual labour, who occupy a cottage or part of a cottage, and who cultivate ground (without paid assistance) in their own occupation." This did not give general satisfaction on the ground that some cottagers were better off than others, and could afford to buy better seeds and plants. It was then decided to take the ordinary wage rate as a basis, which in that district is 15s. a week, and classes were provided for (1) cottagers who do not receive more than that amount weekly, and (2) for those who exceed it by manual labour. This division has answered well. We cannot approve of your prohibiting a cottager from using even a cold frame. That is discouraging, not encouraging, in its tendency. Many a thrifty, industrious, genuine working man at the ordinary wage rate of the locality has not only made himself a rough but useful frame, but even what might be termed a miniature greenhouse, and we think no society should discourage such efforts on the part of toilers in field, shop, or factory, and provided they do everything without "professional assistance" they remain, in our opinion, eligible for competing in cottagers' classes; but if they do employ skilled labour they should only compete in the amateurs' section of the exhibition. The magnificent Onions, Leeks, Celery, and other things staged at the cottagers' great co-operative show every season at the Crystal Palace could not be produced in the absence of glazed frames or glass shelter of some kind for advancing the plants early in the season. The conductors of the show would make a very great mistake in check-

ing this enterprise in cultivation by working men, and there is not the least fear of their doing so. We do not like your repressive definition, for, under it, if a cottager knocks the bottom out of an egg or other box and places glass across the top, and uses the little enclosure for raising plants of flowers or vegetables early, and thereby has superior produce for the show, he is rendered ineligible as a competitor. Try some other definition, based on a more generous policy, and greater interest will be taken by working men in their gardens, and in time a higher standard of excellence established at the shows.

Names of Fruits.—The names and addresses of senders of fruit to be named must in all cases be enclosed with the specimens, whether letters referring to the fruit are sent by post or not. The names are not necessarily required for publication, initials sufficing for that. Only six specimens can be named at once, and any beyond that number cannot be preserved. (J. G.).—1, Damelow's Seedling; 2, Minchull Crab; 3, Northern Greening; 4, Alfriston; 5, Orange Goff; 6, Tower of Glamis.

Names of Plants.—We only undertake to name species of plants, not varieties that have originated from seed and termed florists' flowers. Flowering specimens are necessary of flowering plants, and Fern fronds should bear spores. Specimens should arrive in a fresh state in firm boxes. Slightly damp moss, soft green grass or leaves form the best packing, dry wool the worst. Not more than six specimens can be named at once, and the numbers should be visible without untying the ligatures, it being often difficult to separate them when the paper is damp. (B. H. R.).—The plant is Tillandsia setacea, and it requires to be grown in a warm house. (Subscriber).—We cannot undertake to name your plants without flowers, and the only two therefore in suitable condition are—1, Acacia Farnesiana; and 2, Acacia dealbata. (Cave).—A fine variety of Dendrobium speciosum. (F. B. D.).—A small variety of Dendrobium speciosum.

COVENT GARDEN MARKET.—MARCH 4TH.

MARKET remains the same, with short supplies generally.

VEGETABLES.

	s.	d.	s.	d.		s.	d.	s.	d.	
Artichokes, dozen	0	0	0	0	Mushrooms, punnet	1	6	to	2	0
Beans, Kidney, per lb. ..	1	6	1	9	Mustard & Cress, punnet	0	2	0	0	0
Beet, Red, dozen	1	0	0	0	Onions, bushel	3	0	4	0	0
Brussels Sprouts, ½ sieve	2	6	3	0	Parsley, dozen bunches	2	0	8	0	0
Cabbage, dozen	1	6	0	0	Parsnips, dozen	1	0	0	0	0
Carrots, bunch	0	4	0	0	Potatoes, per cwt.	3	0	4	0	0
Canliflowers, dozen	3	0	6	0	Rhubarb, bundle	0	2	0	0	0
Celery, bundle	1	0	1	3	Salsafy, bundle	1	0	1	6	0
Coleworts, doz. bunches	2	0	4	0	Scorzoneria, bundle	1	6	0	0	0
Cucumbers, doz.	4	0	8	0	Seakale, per bkt.	2	0	2	6	0
Endive, dozen	1	0	0	0	Shallots, per lb.	0	3	0	0	0
Herbs, bunch	0	2	0	0	Spinach, bushel	5	0	0	0	0
Leeks, bunch	0	2	0	0	Tomatoes, per lb.	0	0	0	8	0
Lettuce, dozen	2	0	2	6	Turnips, bunch	0	0	0	4	0

FRUIT.

	s.	d.	s.	d.		s.	d.	s.	d.		
Apples, ½ sieve	1	6	to	6	0	Lemons, case	15	0	to	20	0
" Nova Scotia and	15	0	26	0	Melons, each	0	0	0	0	0	
" Canada, per barrel	15	0	26	0	Oranges, per 100	4	0	9	0	0	
Grapes, per lb.	1	6	3	6	St. Michael Pines, each..	2	0	6	0	0	
Kentish Cobs	45	0	50	0	Strawberries, per lb. ..	0	0	0	0	0	

AVERAGE WHOLESALE PRICES.

CUT FLOWERS.

	s.	d.	s.	d.		s.	d.	s.	d.		
Arum Lilies, 12 blooms ..	2	0	to	4	0	Mimosa (French), per	1	0	to	1	6
Azalea, doz. sprays	0	4	0	9	bunch	1	0	to	1	6	
Bouvardias, bunch	1	0	1	6	Narciss (Paper white),	2	0	6	0	0	
Camellia, white, per doz.	2	0	4	0	French, doz. bunches ..	2	0	6	0	0	
" red	1	0	1	6	Do. Do. English,	0	9	1	0	0	
Carnations, 12 blooms ..	1	0	2	6	per bunch	0	9	1	0	0	
Christmas Roses, dozen	0	4	0	9	Narciss (Various) dozen	2	0	4	0	0	
bunches	0	4	0	9	bunches, French	2	0	4	0	0	
Cineraria, 12 bunches ..	6	0	9	0	Pelargoniums, 12 trusses	1	0	1	6	0	
Cyclamen, doz. blooms ..	0	3	0	6	" scarlet, 12 bnchs	6	0	9	0	0	
Daffodils, doz. blooms ..	0	6	1	0	Poinsettia, dozen blooms	3	0	6	0	0	
Eucharis, dozen	3	0	6	0	Primula (double) 12 sprays	0	6	1	0	0	
Gardenias, each	0	6	1	0	Primroses, dozen bunches	1	0	2	0	0	
Hyacinths (Roman), doz.	0	6	1	0	Roses (indoor), dozen ..	0	6	1	6	0	
sprays	0	6	1	0	" Red (English) per	0	6	1	0	0	
Hyacinth, Roman (French)	1	0	2	0	bloom	0	6	1	0	0	
doz. bunches	1	0	2	0	" Red, 12 bls. (Fench.)	2	0	4	0	0	
Lapageria, 12 blooms ..	2	0	4	0	" Tea, white, dozen ..	1	0	3	0	0	
Lilac (French) per bunch	4	0	6	0	" Yellow, dozen	3	0	9	0	0	
Lilium longiflorum, 12	6	0	9	0	Snowdrops, doz. bunches	1	0	3	0	0	
blooms	6	0	9	0	Spiraea, per bunch	0	9	1	0	0	
Lily of the Valley, dozen	0	6	1	0	Tuberose, 12 blooms ..	1	6	2	0	0	
sprays	0	6	1	0	Tulips, per dozen	0	9	1	6	0	
Maidenhair Fern, dozen	4	0	9	0	Violets (Parme), per beh.	2	0	3	0	0	
bunches	4	0	9	0	" (dark), per beh. ..	1	0	2	0	0	
Marguerites, 12 bunches	4	0	6	0	" (English), doz. bnch	1	0	2	0	0	
Mignonette, 12 bunches..	3	0	6	0	Wallflower, doz. bunches	1	6	2	6	0	

PLANTS IN POTS.

	s.	d.	s.	d.		s.	d.	s.	d.		
Aralia Sieboldi, dozen ..	6	0	to	12	0	Foliage plants, var., each	2	0	to	10	0
Arbor Vitae (golden) doz.	6	0	8	0	Genista, per doz.	8	0	12	0	0	
Azalea, per plant	2	0	3	6	Hyacinths, doz. pots ..	6	0	9	0	0	
Cineraria, per doz.	8	0	10	0	Lily of the Valley, per pot	1	0	2	0	0	
Cyclamens, per doz.	9	0	24	0	Marguerite Daisy, dozen	6	0	12	0	0	
Dielytra spectabilis, per	9	0	18	0	Mignonette, per dozen ..	6	0	9	0	0	
dozen	9	0	18	0	Myrtles, dozen	6	0	12	0	0	
Dracena terminalis, doz.	24	0	42	0	Palms, in var., each ..	2	6	21	0	0	
" viridis, dozen	12	0	24	0	Pelargoniums, per doz. ..	0	0	0	0	0	
Erica, various, dozen ..	12	0	18	0	Poinsettia, per doz. ..	0	0	0	0	0	
Euonymus, var., dozen ..	6	0	18	0	Primula sinensis, per doz.	4	0	6	0	0	
Evergreens, in var., dozen	6	0	24	0	Solanums, per doz.	9	0	12	0	0	
Ferns, in variety, dozen..	4	0	18	0	Spiraea, per doz.	10	0	18	0	0	
Ficus elastica, each ..	1	6	7	0	Tulips, dozen pots	6	0	8	0	0	



GREEN CROPS.

AMONG the lessons of adversity taught by climatic variations last season one of the most important was the due provision of auxiliary green or forage crops for use in stall and yard, and also on pasture, or in folds upon the arable land. Such crops are known to be useful, but there is yet much to learn about their true value, culture, and place in the economy of farm management, and we invite special attention to them now as we approach the border line of seed time—nay, rather as we enter the busy time of seed-sowing once more, for as we write in the last week of February the corn drills are in full activity under the calm fine weather of an anticyclone, and much Lenten corn has already been sown.

Extreme measures very seldom answer in anything, and they certainly have not done so in agriculture. The low price of corn has induced such an extension of permanent pasture that very many dairy farms are now entirely under grass, and the occupants of such farms being dependent on pasture herbage for feeding their flocks and herds found feed become so scarce last autumn that it involved them in losses which in many instances were considerable. Some farmers were able to hire feed, others who were unable to do so sold part of their live stock at a sacrifice; nor did the loss end there, for the autumnal drought being followed by a long hard winter has led to much more stock being forced upon local markets, and a serious local reduction in prices. It is obvious, therefore, how the fine dry autumn which proved a blessing to corn farmers, who turned it to full account for clearing the land, became a curse to the graziers, who had so foolishly put all their eggs into one basket, or, in other words, who depended so entirely on pasture. Equally obvious is it how such a crisis might have been avoided, for had a moderate proportion of each dairy farm been cropped with Vetches, Lucerne, Cabbage, Italian Rye Grass, or Maize there would have been an ample supply of food for all possible requirements.

March is the month for sowing all these crops for autumn use except Maize, which is sown early in June, and we earnestly beg home farmers not to continue a risky dependence entirely upon pasture, but to cultivate some or all of them. In doing this do not be content with half crops. High farming is certainly safe farming among crops intended for use in a green state, as there is no risk of any part of them being spoilt by bad weather if only they are used in good time. As well grow a crop of Tares 4 feet high as 2 feet high, it is simply a question of more or less manure, and for this particular crop the latest teaching of science shows that we have only to see that the soil is fully stored with potash and phosphoric acid, and we may rest assured that the Tare plant will obtain sufficient nitrogen from the atmosphere for its full development. This fact has such an important bearing upon the culture of Tares, and all other leguminous plants, that we shall refer to it at greater length shortly.

A table headed "How Best to Meet a Deficiency of Green Stock Food or Green Crops all the Year Round" is given in Messrs. Carter's new farm seed catalogue, and attention is directed to it here because it is so admirably calculated for the assistance of all farmers, but especially of that particular section for whom we are now writing. All the crops so usefully enumerated are worthy of cultivation, but where *Trifolium incarnatum*—named Red and White Trifolium in the list—are grown especial care must be taken to sow early in August on a clean stubble, the best way being to sow the seed broadcast rather thickly, and to harrow the surface sufficiently to cover the seed. We usually follow Winter Oats with this crop because the Oats are in most seasons harvested

by the end of July. A moderate dressing of muriate of potash and superphosphate harrowed in with the seed is always to be recommended to ensure a full crop, for however fertile the soil may be there must be some degree of exhaustion from a full crop of Oats.

Messrs. Carter's list includes an "ensilage mixture," and rightly so, for that points to a provision of food for winter that is fully as important as the green crops for summer and autumn use. Essex dairy farmers are now buying all the Mangolds they can at £1 a ton, all which expenditure might have been avoided had they only made some stacks of silage last summer, but the change from hay-making to ensilage is very slow indeed. Strange it is that farmers generally cannot yet grasp the full significance of this change, and see how entirely their interests are bound up with it. The very simplicity, ease, and certainty of ensilage probably tell against its speedy adoption. But the scarcity of roots now induce more attention being given to it. Cannot more landlords give their tenants a lead in this matter? Let home farmers bestir themselves and show what can be done, and let them not trust any complaints from shepherds or stockmen of the animals under their care not liking silage or not thriving when fed with it, but rather look closely into the matter and ascertain the real cause of failure of appetite.

WORK ON THE HOME FARM.

More Barley has been sown in February than we are able to sow in March in many seasons, and the popular belief that early sown Barley yields a heavy big-grained sample will certainly have a fair test this year. The indispensable fine tilth is to be had so generally, too, that we fear it may induce an undue preponderance being given to this crop on heavy land farms; yet the fact remains that good malting samples can only be expected from light loams and sound free-working mixed soil. Far wiser will it be to go on with the extension of Oat crops on heavy land, and to curtail all doubtful crops, and rather than continuing to grow corn at a loss, more heavy land should be brought under green crops. Better to make such farms mere sheep runs than to keep on with the heavy labour bill which is inseparable from arable land; but cultivation must not cease, only labour must be economised so that at least each farm is self-supporting. Not an easy matter this, with beef, mutton, and pork all ruling so low at market.

With fat hoggets selling for very little more than could be had for them as lambs four or five months ago, the outlook is not encouraging for flockmasters. If it leads to a resolve to sell lambs freely next June or July then lamb food should be used as soon as the lambs will take it freely, so as to promote free growth and lusty condition. The fine dry calm weather is most favourable for the lambing, and the early lambs are both strong and healthy. We shall not have so much land under Turnip folds as usual, as the lambs must be kept from all rotten or decaying roots. Lamentable indeed is the sight, and most unpleasant the scent of many a field of Swedes just now. Where the roots are useless the best course to adopt is to plough them in and sow either corn or green crops for silage or grazing.

Bad as are so many of the Swedes, those farmers who grow green vegetables for market have suffered a still heavier loss of winter Greens and Broccoli, hundreds of acres being destroyed by frost, which told with great severity on the Essex clays. But the Broccoli on the lighter soil of Kent, near Bexley, also appears to be all cut off irrespective of sorts, "Protecting" or otherwise having suffered alike. The loss is a serious one, and the resources of many an earnest hard-working tiller of the soil will be sorely tried by it. All we can say is, Try again, and take comfort from the fact that the greatest frost of the century is a thing of the past.

METEOROLOGICAL OBSERVATIONS.

CAMDEN SQUARE, LONDON.

Lat. 51° 32' 40" N.; Long. 0° 8' 0" W.; Altitude, 111 feet.

DATE.	9 A.M.					IN THE DAY.				Rain	
	Barometer at Sea Level.	Hygrometer.		Direction of Wind.	Temp. of soil at 1 foot.	Shade Temperature.		Radiation Temperature.			
		Dry.	Wet.			Max.	Min.	In sun.	On grass.		
1891. February.	Inches.	deg.	deg.		deg.	deg.	deg.	deg.	deg.	In.	
Sunday	22	30.425	32.4	32.3	N.	36.7	42.5	29.9	53.8	31.7	—
Monday	23	30.599	27.8	27.8	E.	36.4	41.0	24.2	57.4	20.5	—
Tuesday	24	30.558	30.3	30.3	N.E.	35.9	38.8	28.2	45.4	25.3	—
Wednesday ..	25	30.343	23.9	23.9	N.E.	35.7	50.7	27.1	70.1	28.3	—
Thursday	26	30.082	31.9	31.7	N.E.	35.9	52.6	27.6	67.8	19.7	—
Friday	27	30.209	33.3	35.9	N.E.	35.4	59.6	29.9	83.8	22.3	—
Saturday	28	30.292	32.2	32.2	W.	35.4	61.2	28.3	80.8	21.7	—
		30.334	31.7	31.3		35.9	49.5	27.9	68.4	24.2	—

REMARKS.

22nd.—Foggy morning and evening; sunshine in afternoon.
 23rd.—Fog till 10 A.M., then sunshine till noon, and dense fog from noon to 1 P.M.; slight fog in afternoon, with sun shining through.
 24th.—More or less fog all day, but the sun shining through at times.
 25th.—Fog nearly all the morning, but very slight after 10 A.M.; bright mild afternoon.
 26th.—Bright and fine.
 27th.—Fine and bright throughout.
 28th.—Fog early, clearing gradually, and bright sunshine after 11 A.M.
 Another rainless week, with high barometer; temperature, as deduced from maximum and minimum, near the average, but mornings very cold.—G. J. SYMONS.

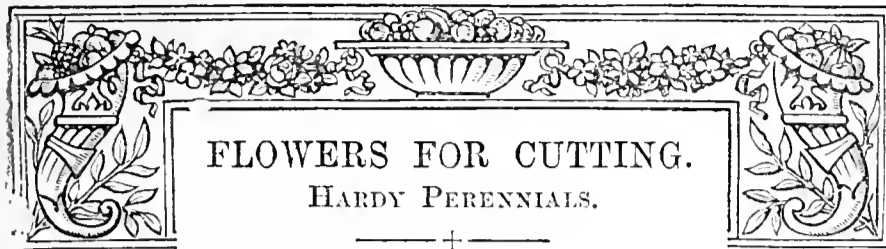

AMONG these a sufficient number may be found to furnish flowers throughout the year. For several seasons anterior to the present we had no difficulty in culling posies out of doors without break, so that it is not so much for want of a suitable selection of good hardy plants that a supply cannot be obtained as from too severe weather recurring at longer or shorter intervals. It is unnecessary to institute a comparison as between the merits of hothouse flowers and those of a hardy character. All classes are worthy of the best attention that cultivators can possibly extend to them. At the same time it may not be amiss to notice here the decided advantage that glass-protected flowers possess over those which are grown in the open air, and necessarily subjected to rain, wind, and hot sun. We have only to refer to such hardy plants as Lily of the Valley, Narcissus, and Lilies grown out of doors without protection, and to compare with them examples of the same kinds of plants flowered under glass protection, to be convinced of the exceeding advantages all glass-protected flowers possess. Cultivators of flowers for exhibition are obliged to protect the flowers they intend to stage if they are desirous of meeting other competitors on even terms. Growers for market in the same way find it to their advantage to protect choice hardy flowers, or in some cases to cut them at an early stage of development and to allow the flowers to fully expand in hothouses or other structures. The matter is worthy the attention of private gardeners as to the extent they may find it possible to adapt means of protecting some at least of such popular flowers as Carnations, white Pinks, Lily of the Valley, *Schizostylis coccinea*, Christmas Roses, and others. Daffodils, Rhododendrons, Gladiolus, and some other flowers expand well after being cut, and a supply of these should accordingly be cut a few days before there is a call for them.

With regard to the cultivation of hardy perennials there are a few points in common which may very well be treated of here. Perhaps the most important of all is to endeavour to steer clear of overcrowding. This defect may arise from more than one cause. Plants may be set out too closely, and while the stronger is ruining the weaker by overgrowing it, the despot so employed will not produce such a wealth of beautiful flowers as if it had in the first instance had a space allotted it sufficient for an unrestrained development. Overcrowding again may arise, and most commonly does arise, from individual plants being left either too long or one spot or from the stems being unthinned. Young plants yield the greatest quantity of flowers—that is to say, of course, if the plants are quite strong to begin with. As instances, a young plant of *Chrysanthemum maximum* or of *lacustre*, of Golden Rod or of Michaelmas Daisy, having in either case a maximum of five strong shoots each, and each shoot allowed room for the fullest development, will produce more flowers than old plants with numerous weakly shoots, which must be tied in bundles in order to keep them “tidy” looking. A very good method of obtaining cut flowers in the best condition is to plant annually, biennially, or triennially according to the nature of the plant.

It is generally an impossibility to manage all good hardy plants in this way, but the best of them can readily be treated so. It is wonderful what can be accomplished by a systematic method of doing these things, and I have no doubt that method in cultivating the best hardy plants for their flowers must come to

be recognised as of equal importance to growing annually beds of Seakale, Artichokes, Cabbages, or any other vegetable. With regard to plants arranged in borders for effect, where there is a difficulty about periodically overhauling the whole borders much may be effected by annual or biennial lifting, and dividing the stronger growing plants. In addition to securing finer blooms the borders are kept in good condition, and do not become so frightfully exhausted under this method. The labour is not much greater than is necessary in the general annual preparation of the border, and the result, as a whole, is well worth what little extra labour is incurred.

The undernoted plants are mainly those which are cultivated in borders; notes in greater detail will follow on the culture of the finer class, or at least those which enjoy the greatest popularity. Asters or Michaelmas Daisies hold a very prominent position as providers of valuable flowers. They range in height from the dwarf *A. alpinus* to those of six or eight feet like *A. novæ-belgiæ*. They are not all of equal value. At the same time it is only fair to admit that where there is a great demand for flowers alike for house decoration and for church and harvest festivals, any or all of the Michaelmas Daisies can be safely relied to furnish flowers in season. The earliest is *A. alpinus*, which with its white form is very suitable for vase furnishing. Then we have *A. longifolius formosus*, and closely following *A. Amellus bessarabicus*, the latter one of the very best and one of the most useful of hardy flowers. Soft and charmingly harmonious effects in table decorations are produced with this flower in conjunction with common Paris Daisies and yellow Corn Marigolds. But indeed it is hardly possible to so employ it as to make an unhappy combination. *A. versicolor* is also very good, more especially for large vases. When grown with only a few stems, and these allowed plenty of room, each stem is clothed with dozens of side shoots in addition to the central pyramidal cone which finished the spike. *A. elegans* and *A. multiflorus* are small-flowered forms, and both should be grown. *A. ericoides* is the best of the close growing small flowered sorts. Of tall growing kinds with good-sized flowers I like *A. carnosus*, *A. Chapmani*, and *A. turbinellus*. In a good autumn like that of last year the two distinct kinds—named respectively *A. novæ-belgiæ* and *A. novæ-angliæ*—were particularly fine and desirable plants.

In conjunction with Asters, *Stenactis speciosa* holds a very high position as a good decorative plant. I have already referred to the common Ox-eye Daisy, also known as the Horse Gowan, *Chrysanthemum leucanthemum*. Under cultivation—and I speak after some ten years' experience with it—good forms of this are superior to *C. maximum*. It combines with early flowering quite a perpetual character, as the same plant continues to open flowers until stopped by frost or by the near approach of winter. The habit is, moreover, dwarf, and has far more elegance about it than any of its garden congeners. Indeed, in this respect it stands very high as a flower for cutting. It is quite perennial in nature, and though most readily increased by seed, it can also be propagated by means of rooted growths in the same manner as *C. maximum*. The latter is well known for its high qualities as a decorative flower. Where large clumps of it are wanted it will be found much better to put out from three to six small healthy pieces at equal distances where the clump is wanted than it is to allow the old plants to grow into large clumps without let or hindrance. In the manner recommended we secure a much more floriferous mass, while the flowers are larger and the flowering season is much extended.

Very similar remarks apply to the autumn *C. uliginosum*. When each stem has plenty of room it becomes well clothed with side shoots from near the bottom. Last autumn masses of this were beautiful grown in this way. In addition to employing the single flowers in the usual way, entire stems may be cut for extra large vases, which they furnish in a most attractive manner.

The Golden Rods require to be treated in the same way as

advised for Chrysanthemums. The little growths which are furnished from the sides of the stems are most useful for the filling of the smaller glasses, while whole stems are cut for large vases. The best of this group is *Solidago canadensis*. *S. Shorti* is very pretty, but sometimes too late to be of any use.

Of quite another type from these is *Eupatorium fragrans*. The greenhouse species of *Eupatorium* are well known as being useful, but this hardy species, though perhaps on account of its period of flowering not so useful, is notwithstanding a much better plant. It flowers during the latter part of summer and autumn, and is suitable for all sorts of decorative purposes, bouquet and wreath furnishing in addition to the usual forms of indoor decoration. The best results are obtained from young clumps. It is a capital "dot" plant among mixed flowers. I will continue the subject.—B.

PEACHES AND NECTARINES.

DURING the past few weeks the readers of the Journal have had the cultivation of the Peach and Nectarine prominently brought before them, first in Mr. Tunnington's admirable paper, and secondly Mr. Goodacre's excellent notes treating especially on varieties, and which are certain to prove of value to those having a large portion of glass devoted to their cultivation, coming as it does from one able to speak with authority on such matters. In reading the list of varieties of Peaches I was pleased to notice a good description of *Crimson Galande*, as we purchased a young tree two seasons ago, and not having grown the variety before, it is only natural I should feel somewhat curious when I found the first bloom, which opened this morning, not a large flowered sort, as Mr. Goodacre describes it, but one of the small flowered varieties. I looked at the list in Rivers' catalogue of fruits, and found *Crimson Galande* with small flowers. I know how difficult it must be for nurserymen to keep everything true to name, but I shall be pleased to know which of us has the true variety, for it is disappointing to grow a variety under a wrong name.

In the list of Nectarines I do not see any mention of *Pine-apple*. It is an excellent variety, but perhaps Mr. Goodacre gives the preference to one of those he has named. We have, with the exception of Rivers' *Early Orange* and *Victoria*, all the varieties he enumerates. To the Peaches mentioned I should like to add the names of three other varieties which have proved first-rate for a number of years. Not that I am in favour of growing a large number of varieties, which to many become a perplexity, especially to those selecting a small number, still there may be many who plant largely, and to which a description of well tried sorts, others than those mentioned, may be welcome. The three I wish to mention are *Dagmar*, *Albatross*, and *Gladstone*. The former we have in our early house; it is a small flowered variety, a good forcer, and a free setter, and I could not do better than give Rivers' description of it.

DAGMAR.—Large, melting, and rich; skin very downy and of a deep crimson, very handsome; a seedling from *Early Albert Peach*. I may state that the fruit of this variety will keep firm on the trees even when fully ripe, so care should be taken so as not to let it remain too long.

ALBATROSS.—This variety is grown in the late house. It has large flowers, is a sure setter, and the fruit is of the largest size, juicy, melting, and delicious. It is more flattened than the fruit of its parent *Princess of Wales*, and comes in ten days later than the last named.

GLADSTONE.—A fine large Peach in use after *Albatross*. The flowers are small, and it is altogether a good late Peach. The fruit is beautifully streaked with crimson, and the flavour good if gathered at the right time.

In conclusion, let me say that I have not written these few lines with a view of disparaging any variety Mr. Goodacre mentions, but merely to add to his excellent list some which have given us the greatest satisfaction, and which, if well grown, will, I feel sure, give growers who are able to try satisfaction as well.—R. P. R.

VEGETABLES—THEIR VARIETIES AND CULTIVATION

[A condensed report of a paper read by Mr. J. LAMBERT, The Gardens, Onslow Hall, Sareway, at a recent meeting of the Birmingham Gardeners' Association.]

MANY different kinds of chemical compounds are found in vegetables, and some of these are more abundant in certain soils than in others, affecting the growth as well as the flavour of the

vegetables. A study of chemistry would often be a great assistance to all engaged in gardening, for could we but have our soils analysed to show us what substances are too abundant, or what are deficient, we should then know how to improve them. Without this knowledge all is guess work, and no doubt manures are often applied that are not the most suitable for the crops and the soil.

SOIL AND ASPECT FOR A KITCHEN GARDEN.

If I could choose I should select a good loamy soil as nearly 3 feet deep as possible, the ground sloping to the south but not placing the garden either at the top or the bottom of a hill, avoiding low-lying grounds especially, so as to avoid, as much as possible, the early autumn and late spring frosts. It should be open and free from the shade of all tall growing trees, but if protected from the cold cutting winds from the east, and strong winds from the west by a plantation of Fir trees, so much the better. The ground should be well drained, and for a large garden where land is plentiful I advise the walks to be made wide enough to admit a horse and cart for the conveyance of manure for vinery borders and for the gardens generally, but we seldom see this provision even in large gardens.

CULTIVATION.

The rotation of crops is studied by many, and it is not advisable to continue some crops long on the same ground. I never like to grow a crop the second time on one plot, but I trouble very little about a rotation if the soil is properly worked. Some insist on having Peas to follow Celery, and so on, and all I have to say is, Do not grow just the same crop on the same ground twice if you can help it. If possible, I have all our garden ground trenched every year, but only the top soil into the bottom about once in four years. I prefer bastard trenching—that is, keeping all the good soil on the top. My plan is this:—When starting the trench, instead of taking out all the soil 2 feet deep and 2 feet wide, and wheeling this soil to where you will finish trenching, the top soil is taken out only 1 foot in depth, and a dressing of manure is placed upon the remaining bottom spit, and this is well dug, working the manure in with it. Then the top spit from the next width comes on to the top of the first trench, turned upside down, and this process is continued throughout. We all know that well trenched ground retains moisture better in dry summers than in hard-trodden ground which has been dug only one spit in depth. A little gaslime or hot quicklime should be dusted on to the top of the bottom spit, only slaking enough lime for one day's use, so that it shall not become dead. Our garden at Onslow Hall has a stiff heavy soil, cracking badly in dry weather if at all trodden or washed by much rain, and I am no advocate for trenching early in the autumn, except for one or two crops. After the ground is trenched I give a dressing of lime over all, and this is lightly forked in.

Another mistake is often made in kitchen gardens in the country, in digging in very large quantities of decayed leaves year after year, so that in time the soil is full of a black humus substance, which often causes fungus, especially to fruit trees, whose roots come into contact with it, and vegetables find but little food in such poor material. It is a common practice in most gardens for the stable manure to be used, but I have found that crops get tired of this stable manure year after year. I always try to obtain cow manure, as it is cooler for the roots in summer, and such a change gives ample repaying results from the crops.

Burnt earth and refuse of all kinds in a charred form I strongly advocate; and I remember seeing that clever old gardener, the late Mr. Judd, when at Hawkstone, measuring out pure wood ashes, and applying so much to the square yard.

Time will only admit of a brief allusion to each crop, as a paper could be devoted to each. As to Peas, these I find to do best in trenches, not using nearly so much manure as for Celery; sowing them just deep enough that when earthed up the trench is still a little lower than at the sides. Many amateurs, cottagers, and some gentlemen's gardeners sow much too thickly. I sow the seeds as I would Broad Beans, placing the Peas 3 inches apart, in double rows, and look sharply after them to prevent their being ruined by mice or birds. Peas grown in this way yield a continuous crop, and one can keep on picking from the rows, as they have plenty of room for forming branches up the stems and give a more continuous crop. By sowing so thickly we procure a heavy crop, and the row is done with. Runner Beans should also have plenty of room.

Broccoli and Cauliflower are almost as useful to the gardener as Potatoes, because all fair sized gardens are expected to have these vegetables the year through, and in ordinary winters this can be done, but not in seasons like the present. By sowing early in the spring we have plenty of small Cauliflower by the time our latest Broccoli is finished. Cauliflower should have more liberal treatment, as I find that Broccoli planted on poor ground stands

the winter best. I have not for years gone to the trouble of laying down Broccoli for standing the winter, as I found it to be time wasted. In the autumn if they are growing in rich soil we go round them with a spade and chop off their roots to arrest luxuriant growth, and this produces a hardening of growth before severe frosts set in.

I am credited by many with having a weakness for very large heads of Veitch's Autumn Giant Cauliflower. Well, this is probable, from the fact of having served under a head gardener who, in 1870 or 1871, was the first to grow such marvellously fine heads of this Cauliflower. I well remember the circumstance, and my surprise at seeing the beautiful heads which were sent on to Messrs. James Veitch & Son, and obtained for them a first-class certificate from the Royal Horticultural Society. These were grown at Hawkstone by the late Mr. Judd. At the Vegetable Conference of the Royal Horticultural Society, held at Chiswick eighteen months since, I was awarded a first-class certificate for specimens of the true variety of this most valuable autumn Cauliflower grown at Onslow Hall. I once grew a specimen 28 lbs. in weight, but by proper treatment you can also have it almost as small as an Early London, and quite as white and as tender as that good old sort.

Carrots are an important crop, and difficult to obtain in some gardens. Visitors to Onslow generally know where to look for my Carrot and Parsnip beds; for nine years I have grown them on the same plot of ground, and during that time I have only once failed to have Carrots fit for exhibition. This failure was not caused by the much-dreaded maggot, but from an attack of green and black fly, and injury to the Carrots in trying to kill the insects. The plot of land selected for my annual crop of Carrots and Parsnips I have trenched, mixing in quicklime, gaslime, and salt until I think it is quite clear of any wireworm or other pests in any stage.

The very fine prize Carrots and Parsnips seen at exhibitions, and often are the cause of remarks such as, "What a soil they must have to grow such roots in," have a special preparation for their culture. They are not grown by me in our ordinary kitchen garden soil, but in "moulds," if I may so term them, and I will explain the process. A rounded dibber is made quite smooth, 2 feet long and 7 inches wide at the top, 5 inches wide 6 inches lower down, and 3½ inches wide half way down, and tapering to the bottom for growing prize Parsnips. For intermediate Carrots a dibber is used 13 inches long and 4 inches wide at the top, 2½ inches wide half way down and tapering. For a fine stock of the Early Horn section I use a dibber 7 inches long and 4 inches wide to near the bottom, where it is rounded off. By forcing these dibbers into the ground, holes are made and a compost used of sifted soil from underneath the potting bench, with sand and burnt earth if at hand, or any good light soil, mixing in a little lime and soot, but by no means apply the lime in immediate contact with the soot; a careful mixing will remedy this. I have tried transplanting Parsnips out of pots, but it is fruitless work. Clean, well formed roots of Beet are obtained by the same treatment as that for Carrots and Parsnips, but with holes not so deep.

(To be continued.)

QUICKSET HEDGES.

As correlative to your note on this subject in page 196, permit me to offer one or two hints to "Cratægus." It is decidedly better to plant in the autumn, and if the planting is done now not a day should be lost, and your advice about firm planting and mulching should be followed to the letter. I may go farther than you have done, and assure "Cratægus" that if due attention has been given to trenching, the selection of sturdy plants, and careful planting, then strong growth invariably follows the cutting down to about 6 inches from the surface the second spring. Robust growth is a certainty that season, and clipping must then begin. Use Ridgway's patent hedge-clippers, which are a sort of enlargement of Clark's horse clipper, and one made in sizes of 12, 18, and 24 inches, the number of inches showing the width of hedge surface covered at each clip.

I have tried single and double lines repeatedly, and am bound to give decided preference to single lines as making the best fence. Double lines are wider, but there is very little growth between them. Single lines, on the contrary, under good management make a perfect hedge, so thick and bushy from the base upwards that rabbits have some difficulty in getting through. But there must be regular clipping twice a year from the second year, and then plashing is very seldom required. It is for hedges that have been neglected, smothered, or starved by an overgrowth of timber that plashing becomes necessary. A good fence may be made against sheep or cattle by this process, and a tolerably neat appearance imparted to

it in the course of three or four years; but it can never equal the trim, compact effect of a really healthy well-managed hedge.

It is only when a ditch is necessary that I would plant upon a raised bank, as the hedge is much more liable to suffer from drought in its infancy than when planted upon the flat.—FORESTER.



COELOGYNE CRISTATA.

PLANTS that have flowered may be repotted or top-dressed whichever they need. Those that require the latter only may have any sphagnum removed used near the surface, and living moss supplied. Any growths that have exceeded the rim of the pot or pan in which they are growing may be pegged on to the soil, so that they will root into it instead of rooting down the side of the pan. By the time that plants need repotting they generally become crowded in the centre with pseudo-bulbs. To leave them in this condition is a mistake, as they injure one another, and small pseudo-bulbs are the result. Thin the centres carefully, cutting out portions with the rhizomes attached. These pieces, although they may appear to be dormant, will nearly all break into growth, and in two seasons make flowering pseudo-bulbs. The pieces taken out may be pegged on the surface of the compost that is used for potting. The pots or pans should be three parts filled with drainage, and if the soil is fairly elevated above the surface it will last for two years.

Established plants that need potting must be carefully turned out, and if the soil is wet or much decomposed the whole can be carefully worked from among the roots, even if tepid water has to be used for the purpose. The roots should not be much disturbed unless it is necessary to break up the plants and replace the pseudo-bulbs more thinly. This course is not advisable with the whole stock in the same season, because it will prove a severe check. If judiciously managed it will not be necessary even to pot all the same season, but if carefully done and watered with care afterwards no harm will result from potting. Pans are most suitable, and should be nearly three parts full of drainage, which may be slightly elevated in the centre. It will be observed that they frequently root freely round the sides.

The compost may consist of fibry peat, one-third living sphagnum chopped, charcoal in lumps, and a few broken crocks. Good leaf mould with the fine removed that is full of fibre and has been prepared naturally in the wood may be used instead of sphagnum. These plants like good leaf mould that has not been heated, and it will last in good condition as long as the sphagnum. If leaf mould is substituted use sphagnum only for covering the drainage, and near the surface. Press the compost moderately firm round the sides as well as amongst the pseudo-bulbs wherever space permits. After potting they must enjoy a moist position where the night temperature will not fall below 60°, the plants on fine days being lightly syringed twice daily to keep them plump. Very little water will be needed at their roots, in fact the less the better until root growth and root action commence.—ORCHID GROWER.

CYMBIDIUMS.

A FEW years ago the Cymbidiums were amongst the rarest of Orchids, fair sized specimens realising high prices. Even fresh imported small plants were expensive to buy, and these when purchased were also difficult to establish, as often they were not in a good state when received, although according to outward appearance they appeared perfect. This has special reference to the beautiful *C. eburneum*, which formerly was considered by many the loveliest Orchid in cultivation, and at the present time it is well able to hold its own. Occasionally we see large specimens, but these are rare, and a well grown plant is something to be proud of. The plants are now commencing to unfold their flowers, which are deliciously fragrant, and the colour is pearly white, lip stained with pale yellow. The flowers will remain in beauty throughout the month of March. The stately *Cymbidium Lowianum* is also now commencing to flower, and is remarkable for the lengthened time the flowers remain on the plant. Those now opening would be still fresh in June, although the colour may be somewhat faded. Unless required for any special reason it is advisable not to allow the spikes to remain on the plant too long. Unlike *C. eburneum*, which flowers from scapes that on strong plants have two or three each, the blooms are borne on long

arching racemes, and with as many as twenty-eight flowers each. Several spikes form on well grown plants, and I have known as many as sixteen, so it may well be understood how imposing a large plant is. Plants from 5-inch or 6-inch pots may be grown in about three or four years to huge specimens in No. 1 or No. 2 sized pots, the foliage reaching from tip to tip to the length of several feet. It may well be understood that it takes a large structure to accommodate such plants.

C. Mastersi is a useful species, flowering during November and December. In habit it somewhat resembles its more handsome relative *C. eburneum*, but the blooms are altogether different. The flowers are borne on erect racemes with several flowers to each. Other desirable species are *C. Devonianum*, *Hookerianum*, and *C. giganteum* (the type of *C. Lowianum*).

Being natives of Northern India growers were formerly of opinion that a very warm structure was needed for the accommodation of *Cymbidiums* in this country. But this subsequently proved to be a mistake. Although natives of India they are found high amongst the mountains, and at times are subjected to a rather low temperature, as according to collectors the foliage is sometimes broken down with the weight of snow; but this has special reference to *C. eburneum*. I mention this to show the extremes that the plants must be subjected to in their native country, not that it would be desirable or even wise to subject the plants to very cool treatment under artificial conditions. Another erroneous opinion formerly held, and unfortunately we often see it recommended at the present day, is because the *Cymbidium* happens to be an Orchid it must be grown in a mixture of peat, sphagnum, and crocks, and also be elevated above the rim of the pot. Now the *Cymbidiums* are not epiphytal, but are truly terrestrial, and instead of growing upon trees they find their home along the margin of watercourses, so the roots at times must be growing in very moist soil, or rather mud. These conditions indicate the course of treatment to be pursued. The plants must not be stinted for root room, and require something substantial to feed upon. I grow our plants at the cool end of the *Cattleya* house, where the winter temperature ranges about 55° as a minimum, and often less, as during the past severe weather the night temperature was nearer 50°. The pots must be efficiently drained, but not to the depth generally accorded for Orchids, as may be necessary, say, for a *Cattleya*. The compost employed should be two parts turfy loam, the same of peat, with a fourth of decayed cow manure, with a fair proportion of charcoal. The plants will require annual potting if they are to grow quickly into specimens. Pot them like any ordinary plant, below the rim of the pot, and during the growing season a plentiful supply of rain water must be applied. It is as well, however, to keep the soil rather dry during the winter months, but not by any means very dry. The temperature of an intermediate house should suit the growth of *Cymbidiums* admirably.—A. YOUNG.

CURLED AND BROAD-LEAVED OR BATAVIAN ENDIVES.

For early forcing seed of these Endives should be sown in the beginning of February in a hotbed, the temperature of which is from 85° to 95° Fahr. Immediately after sowing the seed the frames are covered with straw mats, shutting out all light and air. When the seedlings are well up (in about thirty hours) some light should be admitted, taking care if the sun be strong to afford the plants a little shade, and to accustom them but gradually to the light.

Although the seed may be sown direct into the hotbed it is considered better to sow it in pans or boxes, which are more under control, and may be removed as the temperature requires. A fortnight to three weeks after the seeds were sown the seedlings should be pricked out in another hotbed, with a temperature varying from 75° to 95° Fahr. They remain here one month, after which they should be transferred to another bed, also in heat, where they remain until fully developed.

During that time it is necessary to accustom the plants to light and air, which are given in increasing quantity, and are regulated according to the exterior temperature, care being taken to avoid the plants being scorched up by the direct rays of the sun or their tissues hardened. In the beginning of April, as a general rule, the frames may be removed entirely, and the plants be left growing in the open air until they are fit for the market towards the middle of May. They then make also fine exhibition salads.

To sum up the above notes, I may say that the conditions necessary to success with Endive are to sow in heat, to prick out the seedlings in a hotbed, and to grow the plants equally in heat. If sown before the 15th of May in the open ground the Endives quickly

run to seed, and even at such a late date our gardeners prefer to sow the seed in a spent hotbed.

Many varieties are adapted for that culture, the best for England appearing to be the Green, very fine Parisian summer; Louviers, fine lacinated; Imperial, curled; Rouen or Staghorn, very fine curled; Picpus, fine curled; Queen of the Winter; broad-leaved or Batavian; broad-leaved, white, or Lettuce-leaved.—EUG. SCHAETTEL, *Paris*.

INSECTS OF THE FLOWER GARDEN.

(Continued from page 13.)

If I am not mistaken it is remarked somewhere by the author of that amusing book, "Episodes of Insect Life," that the plant-lice or aphid tribe are the embodiment of insect stupidity, so helpless do they seem to be in escaping from or guarding against the many enemies that assail them. However, it is also true that in spite of their foes, large or small, they succeed in obeying the old command to increase and multiply! But a Canadian entomologist who has been a great observer of ants, and believes that they can communicate facts to each other, thinks that ants and aphides may exchange ideas upon the subject of their mutual enemies, or other matters interesting to both races. Then, he adds, that doubtless, originally, ants ate aphides as juicy morsels, till some genius amongst ants discovered the virtues of the aphid secretion, and the news being dispersed abroad, thenceforth ants regarded aphides in the light of milch-cows. That they attend upon plant lice and caress them we know; besides, they remove, at times, both aphides and their eggs into their own nests. Seeing, however, how predatory in character some of the larger ants are, I would not assert that they never seize and devour aphides, though they may seldom be caught in the act. Certainly they are not entitled to be spared by gardeners for their utility in this way. It is an unavoidable thing, in the course of our measures for the destruction of aphides, that in killing them we must kill many other insects, some of which at least are serviceable to horticulture. Feeble as aphides appear their vitality is strong; they can defy a cutting east wind, and the attempt to combine business with pleasure by smoking pipes or cigars in conservatories has no very marked effect upon any that may be about. Lastly, however, on the much debated question of the links between aphides and ants, that if the latter imprison aphides after their hunting expeditions, as it seems they do, it cannot be for the sake of their honeydew, because when cut off from leaves and twigs the insects cease to secrete this. Again, it does not appear that any species of ant depends mainly for support upon these "cattle," alive or dead. Sir John Lubbock thinks their storage of the eggs of aphides is done to preserve these from the severity of such winters as we have just experienced, but insects' eggs can bear a very intense cold. Still, the fact remains that ants do take possession of these eggs, and fight for them even, also in spring carefully bring them forth again.

Before referring to some other insects that are serviceable as aphid killers, I may mention a few more species that are notable foes of our plants. *A. subterranea* has been noticed in autumn, chiefly amongst the roots of Pinks and Carnations; earlier it may possibly infest plants of another group. It has a very round body, a broad head; the legs and antennæ are blackish, its body dull green, and it is coated over with a mealy powder. Allied to this species is the smaller *A. Sedi*, so named because in some years it occurs in crowds upon the stalks of Sedums. Here the head is black, the legs yellow, and the body light green; when winged these aphides have their wings very glossy and dotted. Then we come to *A. instabilis*, so called from its variable appearance, leading hasty observers to suppose two or three different species are in company. Some of them at the same age are pale brown or green, others yellow or red; their bodies being oblong, and the legs short. In the mature state they are green or brown, with red legs, and both head and thorax black. It is an aphid seen chiefly during the spring months and in August, and though its special favourites are *Epilobiums* and *Pyrethrums*, it occurs on various perennials along the beds. Too well known to most of us is *A. opima*, fortunately its size makes it conspicuous. Contrary to the usual habits of aphides, the young are very active, and move rapidly about the plants they frequent, drawing quantities of sap from the leafstalks. At first they are brownish green, almost transparent, with large red eyes and pale legs; gradually they darken as they grow till they become nearly black. Their winged state occurs latish in the year, they are then yellow with black legs, their wings having black dots. The *Cineraria* is a plant they frequently attack, causing its leaves to rot and fall, for their secretion seems to be poisonous. Indeed, with aphides generally the harm they do is not merely by causing exhaustion, they also obstruct the needful process of respiration.

It is not necessary to describe such a familiar group as are the Ladybirds, or coccinellæ, which most gardeners know to be great destroyers of aphides, but the lace-winged flies are less widely recognised as our friends. Sometimes we see these insects during the day, more frequently we observe them on flowers or leaves about dusk, moving as if either flying or walking was not a pleasant exercise to them. Amongst the commonest of these is *Chrysopa vulgaris*; its little head, placed on a long neck, has two golden eyes, which sparkle in the dark, the body is bright green, and the ample, gauzy wings show tints of pink and green. Admire it, my friend, spare its life certainly, but beware how you handle it, for a lace-winged fly when alarmed, ejects a fluid anything but fragrant, the smell of which clings to the hands after several washings. Singular objects are the eggs of these flies, often noticeable on the leaves of herbaceous plants, for each is mounted upon a tiny stalk, and they are arranged in groups of from six to ten. These produce the larvæ or grubs which devour aphides ravenously by the score; footless, slim-bodied creatures are they, gliding to and fro amongst their helpless victims; and when full fed each spins a compact cocoon of silk in the axil of some leaf.

Quite a contrast to these rather torpid, but pretty lace-winged flies, are the fierce and active two-winged flies belonging to the family of the Syrphi, insects which the old naturalists called hawk flies. We seldom see them in gardens near the metropolis and large towns, but in country districts they are frequent visitors during the summer, when they may be noticed in the act of poisoning themselves over flowers, vibrating the wings so rapidly that they are hardly visible. Many coloured are they. Most of them have some black tints about them, and the head, which is large and round, appears to be almost covered by the eyes. The tongue of a hawk-fly is like a beak, and when thirsty one of them is apt to settle upon the skin of hand or face, endeavouring to draw blood therefrom. But we have to thank the larvæ for their diligence in slaying aphides. These are white and leech-like in form; their busy season is the spring, when they travel about, hoisting into the air captive plant lice while they suck their juices.

Then we have a family of native bees called the Crabronidæ, containing many species—small insects with large heads, which come to our flower beds, not only for honey, but also to seize aphides. These are bees which dig burrows for their progeny in sandbanks, thatch, decaying wood, or bramble sticks, and store these with food for the young grubs. Some of them carry off live plant lice to their burrows, and it is thought the bees in some way stupify or numb them, so that they remain alive without food until the time arrives for them to be eaten, as the grubs would not touch dead prey.—ENTOMOLOGIST.

THE GARDENERS' ROYAL BENEVOLENT INSTITUTION AND THE LATE MR. CUTLER.

It will, I feel sure, interest your readers to know that at a very full Committee of the Gardeners' Royal Benevolent Institution, held at 50, Parliament Street, S.W., on March 5th, 1891, the following resolutions were unanimously adopted:—

"That this meeting desires to place on record its sense of the irreparable loss sustained by the Gardeners' Royal Benevolent Institution in consequence of the death of Mr. E. R. Cutler, its Secretary during the long period of fifty years, and who, by his untiring energy and devotion to its best interests from its commencement, succeeded in leaving it in the gratifying position of having an invested capital of £25,000, while at the same time pensions amounting to £2648 are being paid annually to 156 pensioners."

It was unanimously resolved that the following resolution be forwarded to Mrs. Cutler:—

"That the members of the Committee of the Gardeners' Royal Benevolent Institution desire to offer to Mrs. Cutler their very warmest sympathy and condolences in the lamented death of her husband, a loss felt by each member to be that of a valued personal friend, and of one whose memory will ever be affectionately cherished by all who had the gratification of knowing him."

A sub-committee was also appointed to consider the best steps to at once obtain the services of a new Secretary, and to carry on the general working of the office.—HARRY J. VEITCH, *Treasurer*.

DAFFODILS.

As soon as the spring exhibitions arrive we are reminded of the improvements still being effected amongst those popular spring flowering plants, the Daffodils, by the appearance of collections from the principal firms making them a specialty. This season, too, the display from amateurs may be expected to be larger and more interesting than usual at the Royal Horticultural Society's meetings, because prizes and medals afford some temptation to those who cultivate the plants. Many amateurs now grow considerable collections who a few years since had scarcely any beyond the ordinary Daffodils that have occupied our old gardens for so long a period. Still it is difficult to induce them to part with their treasures for the sake of exhibiting them, and where only a few bulbs are grown the reluctance is excusable. There are some



FIG. 35.—NARCISSUS PSEUDO-NARCISSUS SAMSON.

advantages, however, with regard to showing Daffodils that do not apply to many other plants; for instance, the flowers are easily packed in boxes, they can be readily conveyed to the place of exhibition, and last well when placed in vessels of water.

We shall have occasion to notice some of the best Daffodils exhibited during the season, and in the present issue we give an illustration (fig. 36) of a handsome variety that attracted much attention at the Daffodil Conference last year. This is one of the *Narcissus pseudo-narcissus* type, and belongs to the large trumpet section. As its name "Samson" and the woodcut indicate, it is a massive flower, with broad spreading perianth divisions, and a bold, elongated, trumpet-like corona, the colour being a fine golden yellow. It is of vigorous habit, and has a very telling effect amongst the smaller varieties.

ORNAMENTAL FOLIAGE PLANTS.—I cannot assume that the author of the article first published on the above subject intended his notes to apply to the winter season alone. I do not so read them. With regard to the variegated Pine Apple, as showing the appreciation it is here held in, we have three times had plants decorating the tables since I first wrote. I can safely assure "Rusticus" that it is really a first-rate decorative plant, the lower leaves curving down to the bottom of the large silver vases in which the pots are placed. My experience with it has gone to prove the impossibility of producing plants with long drooping foliage in any other manner than by first growing them to the required size in large pots, then cutting them down, and re-rooting into 5 or small 6-inch pots. I doubt if it can be done in any other way. The variegated Indianrubber must be treated in the same manner. Plants which have been propagated in the way trade growers do, require to be re-rooted under a good leaf. This plant needs good cultivation, but when well grown it is really grand.—B.



CHRYSANTHEMUM ANALYSIS, 1885-90.

In 1889 the principal Exhibition of the National Chrysanthemum Society contained a smaller number of exhibits than any previous Show, while that of last year was, on the other hand, much the largest the Society has yet held. This Centenary Exhibition proved a magnificent one, and in every way a worthy memorial of the able Secretary who had done so much towards planning it, but who never lived to witness the result of his exertions. Taking all the classes the cut blooms numbered over 3800. Besides these there were no fewer than 145 trained specimen plants, to say nothing of the many beautiful groups, and several exhibits not for competition. There were two circumstances in connection with this grand Show which happened fortunately for the present analysis. In the first place the extent of the Exhibition, for of course the larger the display the more valuable is the record for the year likely to be. Then, again, the early flowering kinds having been unduly favoured at most of the previous shows, it was very desirable that at this one the later sorts should be, as in 1889, well represented, and this I find to have been the case.

The figures which follow are very encouraging, as they clearly show a

steady increase in the number of exhibits in every year except 1889 since the establishment of the National Society.

	1885.	1886.	1887.	1888.	1889.	1890.
Incurved ...	839	1080	964	1147	682	1377
Japanese ...	835	1026	1221	1759	922	2054
	1674	2106	2185	2906	1604	3431

In order to place the newer Chrysanthemums as far as possible on an equal footing with the more established varieties the following system has been, as in former years, adopted. The 1886 kinds are given places according to the average number of times they were shown at the last three shows, those of 1887 according to their averages for the last two years, while the positions of the still newer kinds depend upon the number of times they were staged at the Centenary Exhibition alone.

On reference to the table of incurved varieties it will be at once noticed that Empress of India no longer stands, as in all the previous analyses, at the head of the list, this proud position having been taken by a comparative stranger—Miss M. A. Haggas. Queen of England has also had to give way to another new comer—Miss Violet Tomlin—for the second place. Considering what a very conservative section this has been in recent years regarded, surely this amounts to little short of a revolution, particularly when we consider that both of these usurpers were last year only two years old, while the varieties they have dethroned are two of the oldest on the list. Whether they will be able to hold their own as years go on against either of these two veterans appears very doubtful. Even last year, although the Empress was not

(Continued on page 206.)

INCURVED VARIETIES.

Position in Present Analysis.	Average Number of Times Shown in the Six Years.	Number of Times Shown in 1890.	Name.	Date of Introduction.	Raiser's or Introducer's Name.	Colour.
1	† 64.0	64	Miss M. A. Haggas	1888	Hayes	Soft bright yellow.
2	†† 62.0	62	Miss Violet Tomlin	1888	Doughty	Bright violet purple.
3	60.5	71	Empress of India	1861	Downie, Laird, and	Pure white.
4	53.2	55	Queen of England	1847	J. Salter [Laing	Delicate rose blush.
5	52.5	71	Lord Alcester	1882	Freemantle	Pale primrose.
6	49.0	59	Golden Empress of India	1877	Loader	Pale yellow.
7	46.0	59	Jeanne d'Arc	1881	Lacroix	Blush white, tipped purple.
8	39.8	52	Lord Wolseley	1883	Orchard	Bronzy red.
9	37.8	42	John Salter	1866	J. Salter	Cinnamon, orange centre.
10	36.2	58	Princess of Wales	1865	Davis	Blush, tinted rose.
11	35.0	44	Prince Alfred	1863	Davis	Rose carmine, shaded purple.
12	33.8	52	Golden Queen of England	1859	J. Salter	Pale straw colour.
13	33.5	38	Alfred Salter	1856	J. Salter	Clear lilac pink.
14	† 29.0	29	Mrs. S. Coleman	1889	Russell	Bright rose, shaded yellow.
15	28.8	32	Nil Desperandum	1862	Smith	Dark orange red.
16	27.0	4	Mr. Bunn	1881	Bunn	Bright golden yellow.
17	26.0	33	Lady Hardinge	1861	Clark	Silvery rose.
18	24.3	29	Jardin des Plantes	1859	J. Salter	Deep golden yellow.
19	24.0	40	Barbara	1869	J. Salter	Bright amber, shaded orange.
19	24.0	40	Mrs. W. Shipman	1878	Shipman	Fawn colour.
20	22.8	41	Mrs. Heale	1867	Heale	Pure white.
21	22.0	40	Princess of Teck	1868	Pethers	White, suffused pink.
22	19.3	28	Hero of Stoke Newington	1873	Forsyth	Rose pink.
23	17.5	24	Refulgens	1873	Cannell	Rich purple maroon.
24	16.0	17	Cherub	1862	Smith	Orange, tinted rose bronze.
25	14.0	27	Empress Eugénie	1866	Pethers	Rosy lilac.
26	13.8	27	Mr. Brunlees	1884	Smith	Indian red, tipped gold.
26	13.8	1	Prince of Wales	1865	Davis	Purple.
27	12.7	20	Princess Beatrice	1868	Wyness	Delicate rose pink.
28	12.0	9	White Venus	1872	Shrimpton	Pure white.
29	11.8	4	Venus	1863	J. Salter	Lilac, suffused pink.
30	11.5	6	Beverley	1863	Smith	Cream white.
30	† 11.5	20	Lady Dorothy	1887	Buss	Cinnamon buff, suffused rose.
31	10.0	2	Golden George Glenny	1876	Dixon	Bright yellow.
31	* 10.0	19	Mrs. Norman Davis	1886	Mizen	Rich golden yellow.
32	8.5	1	Mr. George Glenny	1870	Waters	Primrose yellow.
33	* 8.3	5	Bronze Queen of England	1886	Carter	Bronze brown, tinted rose.
34	8.2	2	Mrs. George Rundle	1868	Rundle	Pure white.
35	7.5	5	Golden Eagle	1863	Davis	Reddish bronze, tipped orange.
36	† 7.0	7	Alfred Lyne	1888	Lyne	Rose lilac.
36	† 7.0	11	Charles Gibson	1887	Mizen	Bronze red, centre fawn.
37	6.8	10	Mabel Ward	1882	Ward	Buff yellow.
37	6.8	15	Novelty	1860	Clark	Blush.
38	6.7	6	Baron Beust	1868	Pethers	Chestnut red, shaded yellow.
38	6.7	8	Eve	1865	Smith	Cream white.
39	5.5	1	Lady Slade	1864	Smith	Lilac pink.

* Average for three years only.

† Average for only two years.

‡ Number of times staged in 1890.

JAPANESE VARIETIES.

Position in Present Analysis.	Average Number of Times Shown in the Six Years.	Number of Times Shown in 1890.	Name.	Date of Introduction.	Raiser's or Introducer's Name.	Colour.
1	†84.0	84	Etoile de Lyon	1888	Boucharlat.....	Rosy purple.
1	†84.0	84	Sunflower	1888	Cannell	Rich golden yellow.
2	†58.5	85	Avalanche	1887	Cannell	Snow white.
3	*56.7	91	Edwin Molyneux	1886	Cannell	Chestnut crimson, golden reverse.
4	49.8	54	Madame C. Audiguier.....	1879	Marrouch	Deep mauve.
5	47.0	44	Mdlle. Lacroix	1880	Lacroix	White.
6	42.3	72	Val d'Andorre	1883	Pertuzès	Orange red.
7	41.0	41	Maiden's Blush.....	1885	Stevens	Creamy white, tinted blush.
8	39.2	48	Jeanne Délaux	1882	Délaux	Dark crimson maroon.
9	†39.0	39	Stanstead Surprise	1888	Laing	Reddish purple.
10	*36.3	54	Mr. Ralph Brocklebank	1886	Winkworth	Yellow.
11	†36.0	63	Stanstead White	1887	Laing	Pure white.
12	32.2	22	Fair Maid of Guernsey	1872	Downton	Pure white.
13	†32.0	52	Sarah Owen	1887	Owen	Golden bronze, shaded rose.
14	31.9	50	Madame John Laing	1885	Délaux	Creamy white, tinged rose.
15	†31.0	31	Condor	1888	Boucharlat	White.
15	†31.0	31	Mrs. Falconer Jameson	1888	Cannell	Orange-bronze.
16	*28.7	40	Carew Underwood	1886	Beckett	Bronze.
17	27.1	27	Criterion	1873	J. Salter.....	Orange amber.
18	26.8	14	Elaine.....	1882	Downton	Pure white.
19	26.5	18	Comte de Germiny	1881	Veitch.....	Nankeen, striped crimson brown.
20	24.8	15	Soleil Levant	1874	—	Delicate yellow.
21	*24.3	55	Madame Baco	1886	Davis	Deep rose.
22	24.2	29	Thunberg	1881	Veitch.....	Soft golden yellow.
23	23.0	33	Belle Paule	1881	Marrouch	White, edged rosy purple.
24	22.8	38	Meg Merrilies	1871	J. Salter.....	Sulphur white.
25	22.3	39	Boule d'Or.....	1882	Bernard	Rich yellow, tipped bronze.
26	22.2	39	Baronne de Prailly	1868	J. Salter.....	Pale rose.
27	21.2	21	Marguerite Marrouch	1878	Marrouch	Crimson, edged yellow.
28	20.5	15	La Triomphante	1885	Reydellet	White, suffused purplish rose.
29	*2.3	47	Mons. Bernard	1886	Laing	Rosy purple.
30	19.5	32	Japonais.....	1880	Délaux	Bronze yellow.
31	*18.7	32	Mr. H. Cannell.....	1886	Cannell	Deep lemon yellow.
32	18.5	7	Mons. Astorg.....	1883	Délaux	Silvery white, purplish centre.
33	18.2	2	Bertier Rendatler	1880	Délaux	Orange, shaded yellow and red.
34	17.7	5	Peter the Great.....	1875	Carey	Lemon yellow.
35	16.3	43	Gloriosum	1885	Waterer	Orange to golden yellow.
36	14.8	1	Mons. Tarin	1883	Délaux	Silvery mauve.
37	14.3	10	L'Adorable.....	1885	Délaux	Canary yellow, tipped purple.
37	14.3	5	Mdlle. B. Pigny	1885	—	White.
38	*14.0	21	Mrs. J. Wright	1886	Laing	Pure white.
39	13.5	9	Madame de Sevin.....	1884	—	Rosy purple.
39	13.5	5	Triomphe de la Rue des Châlets	1881	Pertuzès.....	Reddish salmon.
40	13.3	12	Duchess of Albany	1883	Jackson	Orange buff.
41	12.7	13	Mons. J. Laing	1884	Délaux	Reddish brown, golden reverse.
42	12.0	15	Yellow Dragon	1863	Salter	Bright golden yellow.
43	11.8	4	Hiver Fleuri.....	1879	Délaux	Creamy white, suffused pale rose.
44	*11.7	20	Lady T. Lawrence	1886	Cannell	White.
45	11.0	12	Mons. Freeman.....	1885	Délaux	Purplish rose, white centre.
45	†11.0	11	Volunteer	1888	Henderson	Flesh pink, tinted rose.
46	*10.7	14	Florence Percy.....	1886	Allen	Creamy white.
46	*10.7	23	Marsa	1886	Reydellet	Purple, white centre.
46	*10.7	17	Mons. H. Elliott	1886	Délaux	Salmon buff, tinted rose.
46	*10.7	10	Mons. J. M. Pigny	1886	Audiguier	White.
47	10.5	5	Triomphe du Nord	1857	—	Bronze crimson.
48	10.2	8	Fernand Féral	1884	Délaux	Rosy mauve.
49	†10.0	10	George Daniels	1888	Boucharlat.....	Pale pink.
50	9.7	11	Mons. Brunet	1879	Lacroix	Lilac mauve.
51	*9.3	18	Album Fimbriatum.....	1886	Laing	Pure white.
52	9.2	1	Mons. Ardène	1878	Lacroix	Rosy lilac.
53	8.5	0	Album Plenum.....	—	—	Creamy white.
54	8.3	0	Flamme de Punch	1883	Délaux	Orange, shaded red.
55	8.0	5	Comtesse de Beauregard.....	1867	J. Salter.....	Rosy lilac.
56	7.7	5	Mons. Délaux	1877	Délaux	Red crimson, yellow centre.
56	*7.7	15	Mrs. H. Cannell	1886	Cannell	Pure white.
57	*7.3	13	Edouard Audiguier.....	1886	Baco	Crimson maroon, silvery reverse.
58	*7.0	12	Hamlet	1886	Délaux	Cerise and salmon.
58	*7.0	4	Roi des Japonais	1886	Lacroix	Crimson maroon, tipped gold.
59	6.8	0	Margot	1883	Délaux	Rosy salmon.
60	6.5	1	Balmoreau	1878	Délaux	Rosy purple.
60	6.5	4	Fanny Boucharlat	1879	Délaux	Creamy white.
60	6.5	10	Grandiflorum	1863	Fortune	Bright golden yellow.
61	6.3	0	Dr. Macary	1878	Délaux	Rose and white.
61	*6.3	9	Mons. W. Holmes.....	1886	Délaux	Chestnut red, tipped gold.
61	6.3	31	Mrs. C. H. Wheeler.....	1885	Waterer	Chestnut crimson, golden reverse.
61	6.3	2	William Robinson	1884	May	Orange, tinted rose.
62	6.2	4	Dormillon	1883	Lacroix	Rose purple.
63	6.0	0	Bouquet Fait.....	1880	Délaux	Soft rose pink.

* Average for three years only.

† Average for only two years.

‡ The number of times staged in 1890.

in as good form as usual, and the Princess of Wales and her descendants were specially favoured by the season, yet Empress of India and her near relative, Lord Alcester, were both staged more frequently than any other incurved variety.

Most of the leading incurved were not as numerous exhibited in 1890 as at most of the previous shows. In fact, three of them, Queen of England, John Salter, and Mr. Bunn, have never before been so indifferently represented. In making this statement the relative extent of the different shows has of course been taken into consideration. There were, however, on the other hand, two notable exceptions, Princess of Wales and Mrs. Heale, both of which were remarkably well shown. To the first we are indebted for Miss Violet Tomlin, and to Mrs. Heale, itself a sport from Princess of Wales, for Miss M. A. Haggas.

There appear to be several very promising additions to this section. Taking first the 1887 kinds we find Lady Dorothy and Charles Gibson at Nos. 30 and 36 respectively. According to the official catalogue of the National Chrysanthemum Society these two varieties bear so close a resemblance to each other that it is not safe to stage both in the same collection. If this advice was strictly followed, and taking the Centenary Exhibition alone, their combined totals would at once raise them to No. 14 on the list. Unfortunately I am unable to tell whether this was the case or not. Nevertheless, it may be safely said that owing to their provoking similarity the positions accorded to them above are not nearly as high as those they are justly entitled to take. Two of the varieties sent out in 1888 have been mentioned above—Miss M. A. Haggas and Miss Violet Tomlin. Whether they are justly entitled to the prominent positions they now occupy or not, one thing is very certain, and that is they are very valuable and welcome additions to the class to which they belong. The remaining sort of that year is Alfred Lyne, which will be found at No. 36. There is only one representative of 1889, Mrs. S. Coleman; but this variety on its first appearance takes up a very hopeful position at No. 14. Unfortunately every one of these new incurved Chrysanthemums are either direct or indirect sports from well-known kinds, which have been in general cultivation for many years, so that the progress made in this section is not as great as would at first sight appear.

It may not be at all an uncommon occurrence to find two newcomers at the top of the table of Japanese varieties; but it certainly is a remarkable coincidence that the two leading flowers in both the incurved and Japanese sections should have been sent out in the same year—1888. Edwin Molyneux was last year much better shown, both as regards substance and colour, than in 1889, in addition to which it was more frequently staged than any other variety in the Exhibition. Maiden's Blush, Boule d'Or, and Baronne de Prailly also appeared in unusual force, whereas Madame C. Audiguier, Mdle. Lacroix, Jeanne Délaux, Fair Maid of Guernsey, Elaine, Criterion, Soleil Levant, and Marguerite Marrouch were never so poorly represented. Of Madame C. Audiguier, only a few years ago the leading Japanese variety, there were but very few good specimens at the last Show anywhere to be seen; indeed, there appears to be a tendency among exhibitors to favour somewhat unduly varieties of recent introduction, to the disadvantage of many of the older kinds.

The three 1887 sorts all take capital positions, Avalanche standing at No. 2, Stanstead White at No. 11, and Sarah Owen at No. 13. There are no fewer than seven varieties first sent out in 1888, which find places on the list, two of these occupy the premier position having each been staged eighty-four times. Sunflower is in every way a grand acquisition, and the finest of all the yellows, but Etoile de Lyon is, in my opinion, unworthy of the prominent position this year accorded it. It is certainly a huge flower, but there is a lack of refinement about it which at once becomes apparent when it is seen side by side with other leading varieties in a stand. I might almost say that what Paul Neyron is among Roses so is Etoile de Lyon among Chrysanthemums. Stanstead Surprise (No. 9), Condor (No. 15), and Mrs. Falconer Jameson (also at No. 15) are all well to the fore. Volunteer and George Daniels, however, lag sadly behind at Nos. 45 and 49 respectively, but judging by its last year's form the latter is evidently becoming much appreciated.

The following fourteen Japanese, which do not appear at all in the analysis for 1888, find places among the leading twenty-four kinds in the present one—viz., Etoile de Lyon, Sunflower, Avalanche, Edwin Molyneux, Maiden's Blush, Stanstead Surprise, Mr. Ralph Brocklebank, Stanstead White, Sarah Owen, Madame J. Laing, Condor, Mrs. F. Jameson, Carew Underwood, and Madame Baco. This will surely give some idea what remarkable advances have been made in this popular section even during the short period of six years.

There are but few changes in the following short lists of choice kinds since last year. The varieties in each list are placed according to the average number of times they were staged at the last three November exhibitions of the National Chrysanthemum Society.

Reflexed.—Cullingfordi, King of Crimson, Pink Christine, Cloth of Gold, Golden Christine, Dr. Sharpe, White Christine, Chevalier D'Orange, Peach Christine, Phidias, and Putney George.

Large Anemones.—Lady Margaret, Acquisition, Fleur de Marie, Georges Sand, Gluck, J. Thorpe, jun., Mrs. Pethers, Empress, Nouvelle Alvéole, Grande Alvéole, and Miss Annie Lowe.

Pompons.—Black Douglas, Golden Mdle. Marthe, Mdle. Elise Dordan, Mdle. Marthe, Marabout, Prince of Orange, President, Pygmalion, Charles Dickens, and Rubrum Perfectum.

Pompon Anemones.—Antonius, Perle, Astrea, Mr. Astie, Regulus,

Rose Marguerite, Madame Montels, Marguerite de Coi, Queen of Anemones, and Marié Stuart.

The varieties most frequently shown last year as trained specimen plants were as follows:—Bertier Rendatler, Dr. Sharpe, La Triomphante, Source d'Or, Peach Christine, Golden Christine, Fair Maid of Guernsey, Mdle. Lacroix, Margot, Madame de Sevin, White Christine, and W. Robinson.—E. M., *Berkhamsted.*



EVENTS OF THE WEEK.—To-day (Thursday) the Royal Society meet at 4.30 P.M. On Tuesday, March 17th, the Manchester spring Show will be held in the Town Hall. On Wednesday, March 18th, the Royal Botanic Society, Regent's Park, have their first Exhibition of the season, and the bulb Show at Bath takes place on the same day.

— WE are informed that THE COMMITTEE OF THE BROCKHAM ROSE ASSOCIATION have accepted the invitation of the Hon. H. D. Ryder to hold their Show for 1891 at High Ashurst on Wednesday, July 1st.

— THE CROYDON HORTICULTURAL SOCIETY'S twenty-fourth summer Show will be held in the grounds of Brickwood House, Addiscombe Road, on Wednesday, July 1st, this year. The schedule comprises 103 classes, of which twenty-two are devoted to Roses with good prizes, as this is one of the special features of the Croydon Show. Plants, fruit, vegetables, cut flowers, and floral decorations are also provided for. The Secretary is Mr. A. C. Roffey, St. Andrew's Villa, Church Road, Croydon.

— BISMARCK APPLE.—Your correspondent "A. F." suggests the Bismarck Apple was imported into this country before the time we named. Such is not the case. Mr. Rivers, no doubt, had some knowledge of it, and tried to import it, but failed to do so. He evidently was somewhat of our opinion that it would not be suitable for our climate by recommending its being planted against a wall. Our heaviest fruit was 16 ozs., grown on a pyramid 4 feet high on the Paradise stock.—JOHN LAING & SONS.

— A MEETING of the BRITISH FRUIT GROWERS' ASSOCIATION was recently held in the Horticultural Club Room, Hotel Windsor, when the arrangements for the Conference to be held at Cardiff on August 12th at 4 P.M., and at Edinburgh on September 11th at 3 P.M., were discussed at some length. The correspondence which had passed between Mr. A. H. Smee, the Rt. Hon. J. Chamberlain, M.P., and Mr. Jesse Collings, M.P., relative to a great County Council grant for technical education was also read. A sub-Committee was appointed to prepare a syllabus of lectures appropriate to the required conditions. Several members and Vice-Presidents were elected.

— A MEETING of the UNITED HORTICULTURAL BENEFIT AND PROVIDENT SOCIETY was held on Monday, March 9th, at 8 P.M., in the Caledonian Hotel, Adelphi, when eleven members were duly elected and several others nominated. It was announced that one member had died—namely, Mr. Vine of Tralee, and a cheque for the amount standing in his name—some £13—was drawn to be forwarded to the widow. Mr. Vine had drawn no sick pay, and as it was understood the widow is in necessitous circumstances, the Secretary was instructed to investigate the case. A balance-sheet showing the liabilities and assets of the Society was presented by the Treasurer, Mr. Hudson, and proved a highly satisfactory document, indicating a balance in favour of the Society of £180, the total assets being nearly £6000. It was resolved to invite members in distant districts to act as corresponding honorary secretaries, with a view to extending a knowledge of the Society and the advantages it offers to members.

— GARDENING APPOINTMENTS.—Mr. George Lewis, principal foreman at Madresfield Court for the past seven years, has been appointed head gardener to the Hon. G. H. Allsopp, M.P., Foston Hall, Derby. Mr. James Ralph, who for some time past has filled the appointment of head gardener to Colonel Heathcote, M.P., Apedale Hall, Newcastle-under-Lyme, retains his appointment for Colonel Heathcote's new property at Mersham Lahatch, Ashford, Kent.

— IN AN AVENUE OF HORSE CHESTNUTS one of the trees has lately developed a black mark on the bark, apparently rising from the roots on one side of the trunk, and gradually extending in size. It has a charred appearance, with fringe of a rusty colour. When the sap rises it is of a sticky bleeding nature. Can any reader tell me how I can stop its extending? I have lost one tree some 50 yards distant after a similar sickly condition lasting five years.—ANXIOUS.

— THE WEATHER.—After long waiting rain came at last on Saturday, and continued in the Metropolitan district throughout the greater part of Sunday. It became clear and cold towards night, and after falling rapidly the barometer commenced rising again with north-east winds and a low temperature. On Monday afternoon a sudden snowstorm of remarkable severity was experienced in London, recalling the great storm of January 18th, 1881. Driven by strong winds the snow descended continuously all night and far into Wednesday morning, accumulating in some places to the depth of a foot or more. Owing, however, to the soft moist state of the ground it is not likely to remain long, but it will seriously retard gardening and farming operations of all kinds. In the north and west of England the storm appears to have been still more severe, and it is said that there is a greater depth of snow in several western counties than has been observed for many years. Gardeners and farmers had during February a month of capital weather to prepare land for the crops, and it is many years since so dry a season has been experienced. The 0.47 inch of rain registered on Monday morning last was the greatest fall in twenty-four hours in London since August 25th.

— WEATHER IN THE NORTH.—After some very boisterous weather, with cold winds and occasional showers of sleet and snow, calm frosty weather has set in. The higher hills are covered, the lower dappled, with snow. On the night of the 6th inst. and two following 9°, 12°, 17° of frost were registered. The last has been reached only twice during the winter here on the nights of December 20th and January 9th.—B. D., *S. Perthshire*.

— THE WEATHER IN SCOTLAND.—The proverbial old weather lore has been verified this year. The month commenced with a beautiful day, the warmest of the season, 55.7°, the 4th 54.9°. A very strong gale prevailed nearly all week. On Saturday morning the mercury fell to 20.7°, with a slight fall of snow, but on Sunday we had 2 inches of snow, the thermometer registering 14.2°, or 18° of frost, at 9 A.M.; with a strong sun, we had 12° of frost. The highest for the day was 39°; the snow had almost all disappeared from the plain by night. On Monday at 7 A.M. the thermometer was standing at 12.8°, the lowest reading for the night with a beautiful sunrise and clear sky.—G. M'DOUGALL, *Stirling*.

— THE WEATHER LAST MONTH.—February was very dry. Only 0.09 inch of rain was recorded on five days, and of this amount 0.03 inch was precipitation from fog on three days; very little movement in the air was noticed except a strong breeze on the 11th. We had severe frost on 17th and 18th, and from the 23rd to the end of the month, also a large amount of fog, with a fair proportion of sunshine and five clear days. The barometer was high all the month, the maximum reading being 30.69 at 9 P.M. on the 4th, lowest 29.93 at noon on the 26th; highest shade temperature 63° on 27th and 28th, lowest 19° on 24th and 26th; lowest on grass 15° on 26th; mean temperature of the month 38.96°. The garden spring ran 12 gallons per minute on the 28th. There is no fresh growth on the grass lands at present, and all of them look very brown and dried up.—W. H. DIVERS *Ketton Hall, Stamford*.

— SUMMARY OF METEOROLOGICAL OBSERVATIONS AT HODSOCK PRIORY, WORKSOP, NOTTS, February 1891, 56 feet above mean sea level.—Mean temperature of month 39.5°; maximum on the 28th, 63.5°; minimum on the 26th, 21.6°. Maximum in the sun on the 28th, 104.1°; minimum on the grass on the 26th, 14.9°. Mean temperature of the air at 9 A.M., 34.9°. Mean temperature of soil 1 foot deep, 37.9°. Nights below 32°, in shade 18, on grass 21. Total duration of sunshine in month 76 hours, or 28 per cent. of possible duration; we had nine sunless days. Total rainfall 0.08 inch. Rain fell on four days. Wind, average velocity, 8.5 miles per hour. Velocity exceeded 400 miles on one day and fell short of 100 miles on fourteen days. Approximate averages for February:—Mean temperature 40.2°, sunshine fifty-six hours, rainfall 1.63. A fine, calm and dry month. The rainfall is less than in any month during the last fifteen years, and we should have to go back to December 1873, or perhaps even to July 1869, for one equally dry in this district. Half the sunshine was measured in the last week.—JOSEPH MALLENDER.

— MR. J. WALLACE of Abbots Langley sends an example of the CABBAGE BUTTERFLY which he caught in his garden last week, and which he thinks "upsets the idea that a hard winter kills all insects."

— A PAPER ON HORTICULTURE IN AMERICA, by Mr. James H. Laing of Forest Hill, was read at the Birmingham Gardeners' Association on March 9th last, in which an interesting description is given of his journey through the United States last year.

— ONE OF CLIBRAN'S PATENT FLOWER POT SUSPENDERS has been sent to us, and merits a few words of description as a useful contrivance for greenhouses. It is constructed of strong wire in the form of a large ring or oval, connected by hooks at each end, with a brass spiral spring, which is placed on the pots to be suspended immediately below the rim. The spring adapts itself to the size of the pot, clasps it firmly, and the hooks are readily removed, so that the plants can be changed as quickly and often as desired. The plants are seen to best advantage, as no obstruction to the spread of the foliage is caused by the wires, and they can be suspended in any portion of the house by a hook at the top of the wire ring.

— THE record of DEATHS IN THE HORTICULTURAL WORLD has been a terribly long one during the past few months, and we have now to add several others. Mr. Edward Kemp, the well-known landscape gardener, died at Birkenhead on March 2nd in his seventy-fifth year, having been born at Streatham, September 25th, 1817. His book, "How to Lay Out a Garden," has had a large sale, and one of his best works was Birkenhead Park, which is very tastefully designed and planted. Mr. George Parmenter of the Camden Road Nurseries also died very suddenly on the 24th ult., through hurrying to catch a train at Euston; while under the report of the Royal Horticultural Society's Orchid Committee, on another page, we record the death of the late Mr. J. Dominy's widow and second son.

— LATE MELONS.—The *Reading Mercury* of February 28th has this letter on the above subject:—Those who require late Melons should grow Suttons' Monarch. I have grown it for two years with perfect success, and have managed to have all fruit ripe by the first week in November; then, if carefully handled in cutting and storing away in a dry fruit room or any other dry place, you will be able to eat as good Melons on Christmas day as you would on a July day. I believe it to be the only good late Melon now grown. To-day, February 18th, I have just finished our November crop by cutting the last fruit; fruit sound, flavour and style excellent.—W. ALLEN, *The Gardens, Swallowfield Park*.

— BULLFINCHES, SPARROWS AND GOOSEBERRY BUDS.—Last winter my Gooseberry bushes were almost spoiled by bullfinches and sparrows, in fact I had not two bushels of fruit. Last December I put one of my men to cut Spruce branches and cover the bushes, which only took him a couple of days, and I am pleased to state I have not seen one bullfinch in the garden this winter. I have examined some of the Gooseberry bushes and not one bud is removed. The sparrows had not been seen in the garden till last week, when we had our Strawberry beds mulched with stable manure, but I have not seen them near the Spruce branches or Gooseberry bushes. Towards the end of this month I shall have the Spruce branches removed and the bushes pruned, and later on I will let you know what crop of fruit is secured.—GEO. CLINGING, *Marden Park Gardens*.

— DESTROYING BULLFINCHES.—I can sympathise with any body of kind-hearted individuals like the Selborne Society, banded together for the preservation of wild creatures, and up to a certain point I can and do assist them. Where bullfinches are plentiful, however, a fruit crop is out of the question if some of them are not destroyed, and if the Selborne Society will publish a practical method of preventing bullfinches eating the buds of fruit trees, gardeners would not have to waste their time in killing them. But to say that bullfinches are not nearly so injurious as represented is not correct, and in my case although birds abound, and we have plenty of netting, it is the only bird that I find it necessary to destroy. At least a dozen bullfinches were at work in our Plum and Cherry trees the other day.—R. MAHER, *Yattendon Court, Newbury*.

— DIELYTRA SPECTABILIS.—I have always considered this one of the most beautiful of hardy herbaceous plants, and whenever it is seen in positions where its pendant pink flowers and graceful habit are shown to advantage it always elicits admiration. In some parts of England it is frequently seen growing in cottage gardens, and I remember many fine old roots which a few years ago I

saw growing in various parts of Kent. But in some counties this *Dielytra* seems quite unknown. Where such in the case I feel convinced that those who can procure a few plants will be thoroughly satisfied. In addition to its usefulness and beauty as an outdoor plant it is also capital for pots, but it will not endure sharp forcing. Clumps must be lifted in the autumn or at the present time, be potted in rich light soil, and brought gradually on in cool houses or pits. When flowering in 32 and 24-sized pots they are exceedingly effective if arranged with *Spiræa*, Solomon's Seal, and Maidenhair Ferns, and the flowers are equally beautiful in a cut state. When the flowering period is over the crowns after being hardened should be planted in rich soil, and be left undisturbed the following autumn. Twelve months later they will be in fine condition for flowering in pots again if their wants have been well attended to. Keep them free from weeds at all times. Water occasionally during the summer time if the soil becomes very dry. Cover the crowns with a couple of inches of coal ashes in October, and give a coating of well decayed manure or leaf soil between the rows at the same time.—H. D.

— CAN anyone inform me as to the best way of CATCHING OR DESTROYING THE SHORT-TAILED FIELD MICE? They are fast clearing off a bed of Globe Artichokes for me. The first sign is the drooping of the plant, and on pulling them up the tap root is found to be completely eaten away and the stalk hollowed out. The mice never seem to come above ground, and it is therefore useless setting baited traps for them. I have caught some by setting small gins in their burrows, but this is a difficult operation, as the hole is small and generally rather deep, and the few caught this way seems to make little difference. It would be interesting to know where these mice come from. Perhaps some of your readers could give information about their habits, which would be useful as well as interesting. Round the Artichoke bed were some plants of Endive, the roots of which have also been eaten by the mice. Some three years ago these same beds were destroyed by the mice, and I had the ground deeply trenched, so as to get rid of their runs, and replanted. The crops were left undisturbed by the pests till this winter.—R. T., *Portugal*.

— BOLTON HORTICULTURAL AND CHRYSANTHEMUM SOCIETY. — A very pleasant evening was spent at the monthly meeting of this Society held at the Operative Spinners' Hall on Thursday last, Mr. Charles Jones presiding, when a paper was read by Mr. Pawson, The Pike, on "Annuals," giving a descriptive list of varieties best adapted for growing near large towns, and showing that by careful selection and a little more attention than is generally given to this group of plants in thinning, and after cultivation, many an unsightly spot may be made to look gay for several months at a very little cost. A lively discussion followed, Messrs. Corbett, Callow, Tatton, Wainwright, Harrison, and Smith taking part, votes of thanks to the essayist and Chairman bringing a very enjoyable evening to a close.—J. H.

— THE ROYAL METEOROLOGICAL SOCIETY. — This Society's twelfth annual Exhibition of instruments was opened on Tuesday evening, March 3rd, in the rooms of the Institution of Civil Engineers, 25, Great George Street, Westminster. The Exhibition this year is devoted to rain and evaporation gauges, and such new instruments as have been constructed since the last Exhibition. Almost every known pattern of rain gauge that has been used in this country is shown, and it is interesting to compare the old with the new patterns. Most of the gauges have funnels 5 or 8 inches in diameter. The Meteorological Office 8-inch gauge is generally regarded as the best for ordinary observers to whom cost is not a primary object, as it has all the good features of the Glaisher and of the Snowdon patterns, and being of copper is very durable. In mountainous districts, where the rainfall is heavy and the gauges can only be periodically examined, gauges capable of holding 40 or 50 inches of rain must be used. Specimens of these, as well as of the rain and snow gauges used in France, Germany, Russia, Switzerland, and the United States are shown in the Exhibition. Some interesting storm and self-recording instruments are also exhibited. The evaporation gauges include several employed for measuring the evaporation from a free surface of water, and others for use with growing plants. Numbers of new instruments are also exhibited, among which are various anemometers, recording barometers, and cameras for meteorological photography. An interesting collection of maps of rainfall over the British Isles and various parts of the world, as well as numerous photographs of floods, meteorological phenomena, &c., are also on view. The Exhibition will remain open till Thursday the 19th instant.

— EUCHARIS GRANDIFLORA. — This plant is well grown at Calderstones, near Liverpool, where that veteran in the Chrysanthemum world, Mr. Tunnington, is gardener. The plants were well clothed with dark green foliage, with a profusion of flower spikes, which were throwing up in the different plants in even succession, giving promise of a long continued display, which is just now much appreciated. The flowers were of exceptional high quality, being large and of more substance than sometimes seen. The plants were growing in a large span-roofed house not far from the glass, the pots were plunged in leaves up to the rim. At the bottom of the bed heat was obtained. By careful management in withholding water at various stages of growth a good supply of bloom can be had from the plants in the same house.

— ROYAL BOTANIC SOCIETY OF LONDON. — Dr. R. C. A. Prior presided at a meeting of this Society, held on Saturday. An interesting report by Mr. Lecky was read, giving a summary and digest of the sun record in the Gardens during the year 1890, showing the percentage of each month. As compared with the returns for the previous year this shows an increase of 156 hours of bright sunshine, a result due to the latter half of the year (the earlier months being comparatively sunless). The total recorded for the year amounts to 1092 hours as against a possible total of 4455 hours. A noticeable feature was the predominance of afternoon sunshine, due, it seems, to the position of the Gardens in the north-west of London and the difficulty the sun has in piercing the smoke and mists from the eastern districts as it rises. It is a curious fact that not the slightest trace of sunshine is recorded as occurring during December.

— LIVERPOOL HORTICULTURAL ASSOCIATION. — A good attendance of members of the above Association was held in the Lecture Room, William Brown Street, Liverpool, to hear a paper on Dendrobiums by Mr. John Glover, gardener to Sir A. B. Walker, Bart., Gateacre Grange. Mr. White, who presided, said Mr. Glover had charge, some years ago, of a large collection of Orchids, comprising some of the largest plants in England. He mentioned that he had read many good papers on the cultivation of Orchids. One he remembered in particular on the *Odontoglossum*, and on which he had composed a poem. The paper on this occasion proved highly interesting. A discussion followed. Mr. Cox differed from the reader with respect to drainage, and considered that pots half filled with crocks was not sufficient. He preferred baskets, and not such long rest as advised. Mr. Storey inquired as to cutting away the old growths of Dendrobiums, Mr. Glover's reply being that he would not cut away old growths until they turned yellow, as they afforded nourishment at resting time. Mr. Powell (Botanic Gardens), spoke of the use of dried cow manure. He had succeeded well with it, and strongly recommended its trial. He had also used it for *Lælias* with success, mixing it with the compost. Mr. Carling remarked that *Dendrobium chrysanthum* made two growths in the one year, and Mr. Glover, in reply, said that it was natural to the plant, which could be flowered twice a year with good treatment. Mr. Smith and Mr. Simpson also spoke on the subject, and Mr. Storey proposed a vote of thanks to the reader of the paper, which was carried unanimously.

— MIDLAND CARNATION AND PICOTEE SOCIETY. — Birmingham is not content to sit down calmly under the gentle reproach in the Journal of following the old lines too closely in respect to exhibiting Carnations and Picotees. With a spirit worthy of its progressive reputation it has set to work again, and the result is a schedule revised is so broad and liberal a spirit that we may hope to see a really representative Exhibition of one of the grandest of all florists' and garden flowers. The advanced florist will still have ample scope, and he will not be the worse for rubbing shoulders with those who cultivate Carnations and Picotees in a different groove to his own. In the revised schedule the wearisome separate classes for single blooms of Bizarres and Flakes, Heavy-edged and Light-edged, in the various colours are dispensed with. In the place of the fifteen before provided we now have one for Bizarre Carnations, one for Flakes, one for Heavy-edged Picotees, one for Light-edged, one for Selfs, and one for Yellow Grounds. In the first four the Judges will in each case select the three best flowers in each colour, nine in all (there are nine prizes), and then arrange these in their order of merit from one to nine. The arrangement, which is to be tried at Mr. Sydenham's express wish, may evoke criticism from some of the old school, but it is simple enough, and is a desirable innovation. Then there are two classes for Carnations or Picotees staged as cut from the open ground with their buds and foliage, no dressing allowed, a class for bouquets of Carnations or

Picotees with their own foliage, and a similar one for sprays, also a class for plants grown in pots of any variety. There are several classes for miscellaneous flowers, such as Selfs, Fancies, and Yellow Grounds, which have grown so largely in popularity of late years; in fact the schedule is now a close approach to what the schedule of a Carnation Show ought to be, catering liberally for all classes of growers. The prompt and thoroughgoing manner in which the midland growers have responded to a friendly hint is evidence of an earnest desire to pursue a broad policy, and advance the interests of a deserving flower.

CROSSWOOD PARK.

THE Manchester and Milford Railway is a large-sounding title; it is as well, however, to say that the title is one of the largest things connected with the line. Adjacent to this railway, about half a mile from the little country station of Frawscoed, which is the Welsh for Crosswood,

Farming is not his lordship's only interest, as a walk through the gardens proves, for on all hands renovations are in progress or in prospect. A large tract of park land has already been enclosed, adjoining the previously existing pleasure-grounds, and has been most tastefully laid out and planted with specimens of such dimensions as to bear the appearance of an old established plantation. The mansion itself is being considerably enlarged, and, among other improvements, will be a more commodious dwelling for the head gardener, Mr. Williams, whose hands are well filled whilst so much extra work is in progress.

A tour of the kitchen garden made it apparent that immediate and successional edible requirements are not neglected in the least for the more ornamental work elsewhere. Autumn and winter crops were abundant at the time of our visit, and new plantations of bush fruits, Raspberries, and Strawberries, spoke of new life on all hands. One end of this garden will shortly be required for building purposes, and at the opposite end the glass departments stand. Before entering these the fruit trees demand a passing notice. The walks are mostly avenued with pyramid trees—Apples and Pears—in very good form. They have all been overhauled—root-pruned and replanted—recently, and have

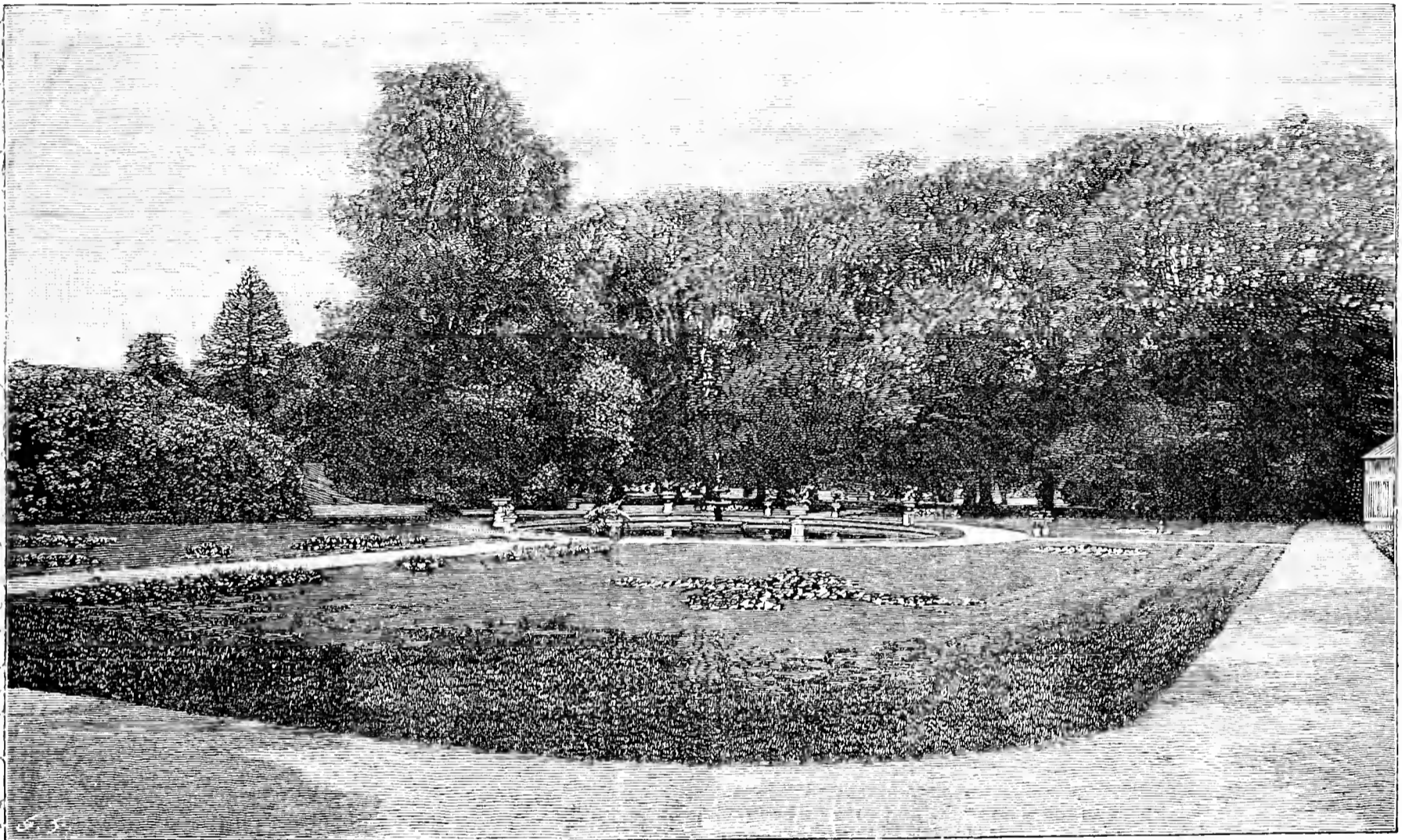

FIG. 37.—CROSSWOOD PARK.

stands the above mansion. Had it been situated on one of the great lines of railway, or in nearer proximity to the large industrial centres, it is more than probable that one of the many gifted horticultural scribes would long ago have "turned in" and done Crosswood far more justice in the pages of the Journal than I can hope to do. When I state that the famous watering-place, Aberystwith, is but six miles away from here your readers will know that I am still in "Wild Wales."

Lewis, in his topographical works, speaks of Crosswood as one of the modern mansions of Cardiganshire. He could not, however, have been aware of the fact that the present family, the Vaughans or "Vychans," have held undisturbed possession from the twelfth century, and it is believed have never ceased to occupy either. This is perhaps a fact without a parallel, and is a fact to be proud of by the present owner, the Right Hon. Earl of Lisburne, who came into possession in 1888, on the death of his father, the late Earl of Lisburne. The estate is about 42,000 acres, and is bounded by Radnorshire and Breconshire, and the Plynlimon Hills on one side, and runs almost to the Channel on the other. It is well wooded, and rich with lead, silver, copper, and probably other minerals. His lordship farms extensively in the lowlands, and plants the less profitable highlands. The tenantry, too, find in his lordship a good landlord, anxious to assist in rendering their homesteads happy and to improve their stocks, as evidenced by the large sums recently expended upon pedigree stock for their service.

well repaid the trouble with the enormous crops borne the last season, when fruit was generally a failure. Cherries, too, on the walls carried exceptionally heavy crops last season. These are very fine trees. Indeed the wall trees, including Peaches, which, as a rule, are not a success in these parts, appear to do wonderfully well. The monarch, however, of all the wall trees is a splendid old Fig in one corner of the garden, which deserves to have a protection in the way of a good glass structure erected over it.

Ranges of pits and frames were stocked with Violets, as usual Marie Louise being favourite; also with Carnations and Bouvardias, which have since our visit doubtless given a good account of themselves in bloom. Other compartments contained quantities of bedding plants, for which the demand is greatly increasing. Stoves and greenhouses, which in style are not the most modern, are full to overflowing; the roof carrying such useful flowering climbers as Allamandas, Stephanotis, and Passifloras, and suspended from the roof were Dendrobiums of the noble and Wardianum type, plainly demonstrating that they were at home. Several other Orchids are grown well, and among them a few plants of *Odontoglossum vexillarium* thrive very much better than they ordinarily do where not made a speciality. We may have more to say about his lordship's Orchids on a future occasion. Bulbous plants, such as Vallotas, Amaryllis, *Pancratium*, and *Eucharis*, are accorded, and prove themselves worthy of, good positions and care. The

Eucharis, however, have suffered from the ravages of the dreaded "mite," but thanks to careful nursing and the aid of "Clibran's Mite-killer" they too are themselves again. Ornamental foliage and flowering Anthuriums, fine pieces of Adiantum farleyense and Calanthes also were noticeable in the stoves, whilst in an adjoining cooler house greenhouse Rhododendrons are being well cared for, with Azaleas, Heaths, and a host of other useful plants.

Fruits indoors in the way of Grapes and Peaches have hitherto not been largely grown. One house of young Vines looked most promising, and a Peach house adjoining was in very good trim. Cucumbers and Melons in bulk were over for the season, but good fruit of the latter among other good things in the fruit room testified that they are grown and not played with by Mr. Williams. The conservatory, a spacious and convenient structure—"few conservatories are convenient"—is near the house on the south-west front, and is the receptacle for whatever flowering plants may be in season. We have seen it gay with bulbous plants and forced plants, with Zonal Pelargoniums and Fuchsias, at other seasons with Chrysanthemums again, but one of the prettiest arrangements we call to mind was a group of Tuberous Begonias, double and single, with Lilliums of sorts interspersed, smaller plants, Ferns, and as an edging, whilst above Passiflora Constance Elliott, Tacsonia Van Volxemi, and Cobœa scandens depended gracefully from the roof. Roses, too, special kinds—viz., Maréchal Niel and W. A. Richardson, find a home here, and clothing the back wall are Camellias, Asparagus plumosus, with Lapagerias, which are destined to cover the back portion of the roof. Chrysanthemums have been casually mentioned, and no garden is now considered complete without a collection of these; 500 have been grown last season, and well grown, too, of the best kinds. Some stands from here entered the lists in competition last season, and doubtless another season we shall see and hear more of them.

Immediately fronting the conservatory is the flower garden proper, which at the time of our visit, though so late, was clothed in almost tropical luxuriance. Palms in vases surrounding an ornamental fountain, and foliage plants dotted here and there, and a few Gum Trees fully justify that description. Various styles of bedding are adopted. Tuberous Begonias, however, will in future occupy first place, his lordship having made arrangements already for masses of these in colours. In the accompanying illustration (fig. 37) a path is shown extending from the fountain and crossing through an avenue of Limes, beyond which it enters the newly made grounds by some ornamental steps in a terrace of masonry. This terrace wall is crowned by a balustrade, and harmonises with the stonework in the other terraces. An avenue will be planted of Wellingtonias and Cryptomeria japonica. There are already very fine specimens of these trees in the grounds, and also of Araucarias, Sequoia sempervirens, Cedars, the Weymouth Pine, Picea nobilis, P. Nordmanniana, Cupressus and Thujopsis; fine old Elms, too. Scotch Firs, and the Limes already mentioned in the avenue, are grand pictures. Rhododendrons are quite at home; immense masses in the old grounds are supplemented in the new by the best and newest hybrids. Azaleas too of the Ghent and Pontica type are equally at home; huge plants of these have been removed and planted in new beds in company with Kalmias, Skimmias and Ericas. The display when in bloom can better be imagined than described.

A Rose walk leading up to the summer house, shown in the illustration, is a treat to rosarians. The border is planted with the very best dwarf H.P.'s, and an ornamental wire trellis at the back is covered with Teas and other climbers; part of the trellis, too, is devoted to Clematis, which are very effective. The summer house is a splendid piece of workmanship in octagon form, encircled outside its own walls by a verandah. It commands on the upper side the new extensive tennis lawns, serves as a capital finish to the Rose walk, and forms a happy transition from the old free style in the upper grounds to the "line and angle" style in the new portion. Great credit is due to his lordship's agent, Mr. Gardiner, who has taken a great interest in the new work, and proved himself a thorough landscape gardener in preparing his designs in so practical a manner under conditions not particularly favourable; and of Mr. Williams, the head gardener, it must be said that the work altogether is a testimonial to his ability and care, for out of the hundreds of trees planted there was but one failure through death. This is saying a good deal, bearing in mind that many were bushes from 10 to 15 feet through, and had not been moved probably since first planted many years ago, among them being plain and variegated Hollies, Rhododendrons, Azaleas, and various Conifers. These, of course, were taken from other plantations, and some removed a considerable distance. It may be our pleasure in the no distant future to chronicle large additions to the glass departments; in the meantime we may wish his lordship a full measure of health to carry out these improvements.—BRADWEN.

HORTICULTURAL CLUB.—Sir John Lewellyn, Bart., the recently elected President, took the chair at the usual monthly meeting of the above Club, and a wide subject for discussion was opened by the paper read by Mr. Geo. Bunyard of Maidstone, on "Seeds; Curiosities of Germination, Vitality, and Distribution." A most interesting evening was spent, and some further facts were elicited by the remarks of Rev. W. Wilks, Messrs. D. Morris, G. Paul, A. H. Pearson, P. Crowley, T. W. Girdlestone, Jas. Walker, Cousens, and others, and at the close a hearty vote of thanks was accorded to the reader of the paper. At a Committee meeting held previously we learn that Mr. Harry Veitch of Chelsea was elected Vice-Chairman of the Club. The esteemed Secretary was detained at home by the snow, to the regret of those present.

ARRANGEMENT OF HOT-WATER PIPES.

I AGREE with "Heating Reformer," page 179, where he says that hot-water pipes might often be better arranged and the heating surface more evenly distributed, but I do not consider his plan of placing six pipes at 2 feet apart on the surface of the Vine borders is a good one to follow, as I am quite certain it would be no easy matter to lift the Vine roots and renew a border under such conditions, unless the pipes were taken out, which would be an expensive addition to border making. They would also be in the way during other operations connected with Vine culture, and in many cases would prove a greater evil than the one he attempts to cure. It is quite true that several pipes at the front of the house often dry the border very much, but as a rule there is not a great number of feeding roots close to the stems of the Vines, and the feeders would be put to much greater inconvenience by spreading the pipes on this plan. Again (unless very near to the boiler) I very much doubt if five flow pipes working into one return would give enough circulation. I have never had anything approaching to this, but on the contrary side, in a serious case of insufficient circulation which I once had to deal with, one of our highest authorities on the subject recommended the addition of an extra return where the flows and returns were equal before, and this made matters right at once.

There is also one great objection to self-acting air pipes—viz., they occasionally get blocked at the top by accumulations of spiders' webs, and then give far more trouble than taps ever do. I much prefer the latter, as if by any chance they are forgotten for a few days and air accumulates in the pipes we naturally try the taps at once, as soon as defective circulation commences, and all is soon right again. At any place where there are several valves and air taps, it should be part of one man's duty to regularly inspect them at a stated time every week, or as often as may be found necessary, moving everything to the full extent both ways, and replacing it as found, and stopping all leaky valves, &c., as required. If this rule is strictly enforced much trouble and annoyance with hot-water apparatuses may often be prevented.—W. H. DIVERS, *Ketton Hall Gardens, Stamford.*

THE ROYAL HORTICULTURAL SOCIETY.

MR. MORRIS'S RESIGNATION.

THE brevity of this note will, I hope, prove the sincerity of my intention that the last should have been, on my part at least, the conclusion. I only feel it necessary to distinctly contradict your statement that I informed you Mr. Morris had "resigned." I may possibly in private conversation have used the word "resigned," as it is more convenient than "become incapable," but I have been very careful from the beginning of this controversy to use the technical word "incapable." At the annual meeting of the Society Dr. Hogg asked, "What is the name of the gentleman referred to?" and I answered, "The gentleman's name is Mr. Morris." I did not use, nor did I hear Dr. Hogg use the word "resigned," and you will search my written utterances in vain for the use of this misleading, though convenient, term.

"If a member of Council die or become incapacitated, &c., the Council may fill up the vacancy." You assert the conjunction "or" is disjunctive. Surely, on reflection you will allow me to designate this an audacious argument? At least, your readers may form some idea of the strength of your whole case from this example of the foundation it rests on.—W. WILKS.

[Quite so. Our readers may safely be left to form their conclusions in this matter, and they will no doubt observe that Mr. Wilks makes no allusion to one of his proved inaccuracies last week. In reference to the definition of the word *or*, of course we know that it is ordinarily used as a conjunction, but as used in by-law 68 it is undoubtedly disjunctive, and what grammarians call a disjunctive particle marking an alternative (see "Johnson's Dictionary," original edition, and the "Encyclopedic Dictionary" recently published). Surely the member of Council who dies is in another category to him who becomes incapacitated "from any other cause (than death) whatever," and the nature of whose incapacity is set forth in by-law 69.

We agree with Mr. Wilks that the word "resigned" is a convenient one to employ in a discussion of this nature, and should not think of taking advantage of the mere use of a word introduced for convenience in expression. A great deal more than a mere word is at stake in this case—a great principle is involved, and the non-adherence to the law provided for the governance of our Chartered Society may have important issues which cannot at this moment be fully appreciated. The Secretary evidently did not hear the terms of Dr. Hogg's question at the meeting. His question was framed with the object of reassuring himself whether Mr. Morris's retirement was regarded as an ordinary or as an extraordinary vacancy by the Council. He did not ask the name of the gentleman who had retired, but resigned, and for this reason—namely, that the notification of Mr. Morris' "resignation" (not retirement) had been officially announced and published in the gardening Press.

We are now told we shall have to "search in vain for any written utterances in which the use of the misleading term 'resigned' was used" by the Secretary. O Mr. Wilks! listen to this, which appeared on page 357 in the *Journal of Horticulture*, October 23rd, 1890, and was received officially from the Secretary:—

Royal Horticultural Society.—We are requested by the Secretary of the Royal Horticultural Society to publish the following announce-

ment :—" Mr. Morris is about to resign the post of Hon. Treasurer to the Royal Horticultural Society, which he has held for such a length of time ; indeed, at a meeting of the Council on the 14th inst. he formally tendered his resignation. Mr. Morris is about to sail to the West Indies on a Government mission, and as this will necessitate his absence from England for a period of three or four months he feels that under these circumstances he could not attend to the duties of Treasurer to the R.H.S. to his entire satisfaction. During Mr. Morris's term of office he has been most energetic in bringing the financial affairs of the old Society to a satisfactory state, and that he has succeeded and his services appreciated may be seen from the following resolution, passed by the Council :—" The Council of the R.H.S., in accepting with unfeigned regret Mr. Morris's resignation of the post of Hon. Treasurer, which he has filled with such signal success and advantage to the Society, beg to express to him their grateful sense of the value of his services, of the judgment and discretion with which he has conducted his duties, and of the devotion with which he has in every way forwarded the interests of the Society."

This reads very much like an extract from the minutes of Council. If not, what is it ? Mr. Wilks said at the meeting that " Mr. Morris had resigned and Mr. Crowley had been appointed to fill the vacancy thus caused," and that " Mr. Morris had been nominated for re-election because his services had proved so valuable to the Council." Mr. Morris, therefore, undoubtedly resigned, and his resignation ought, under the circumstances, to have appeared on the balloting papers as an extraordinary vacancy, as is imperative according to by-law 81.

We have been convinced from the first that the vacancy created by Mr. Morris was an extraordinary vacancy, and we wanted Mr. Wilks' precise admission of the fact, which we now possess. This settles the case against the Council, because it is impossible they can show that the clearly defined course provided in the Charter and by-laws was followed at the annual meeting. The balloting lists were indisputably informal, and the action founded thereupon was consequently invalid.]

MELONS AND THEIR CULTURE.

[Read by Mr. W. PALMER, Thames Ditton, at a recent meeting of the Ealing and Chiswick Gardeners' Mutual Improvement Society.]

(Concluded from page 182.)

III. JUDGING MELONS.—This is rather a difficult task at times, although if the judges' faces are anything to go by it is a very pleasant one, especially when they get hold of a really good fruit. I have often watched them from afar at the Crystal Palace and such large shows, where you are allowed to have a bird's-eye view of them. Melon judging has of late raised much controversy, some holding that the Melons should be judged without being cut ; others that they should be cut, as they generally are. I certainly cast my vote in with the latter, since, if they are not cut, where is the man that can judge a Melon by the smell ? I have often tried the experiment, and have as often failed, and as Melons are grown to be eaten, let us encourage the good flavoured, and not give their owners the chance to say, " That Melon ate like a Turnip last night ;" rather let them say, " What a splendid Melon it was you sent in last night, it is the best I ever tasted." This is what we want to encourage, and it is our duty to do so. How often is the saying, " You must not take me by my looks," verified in the Melon, especially when we see one about 2 lbs. in weight beat one of 4 lbs. and over. In this I think great care should be taken that the flavour of the small one should be of sufficient merit to warrant it being placed in front of the large one. When staged in pairs of course one cut is then quite sufficient, and the second one should be judged as equal to the first. I have now arrived at my last part.

IV. DISEASES TO WHICH MELONS ARE SUBJECT AND THEIR PREVENTION.—Foremost amongst these is canker. This is prevented by making a little mound round the stems as recommended at the time of planting ; the soil in time becomes dry, and so assists to keep canker away. This I have proved by considerable experience. I have not lost more than two plants in the last seven years, although growing some forty or fifty plants every year. If any sign of canker should be discovered remove the decayed part, and rub on the place some quicklime two or three times a day. This should also be done on the approach of decay, and withhold the syringe from the parts affected until healed. Black fly is also a very troublesome pest to some ; to those I would strongly recommend a compost even lighter in texture than what I have already advised, as I have never known the fly to attack plants except when the loam used is of a very stiff nature. I had this information given me some years ago now, and since I have followed it I have never been troubled with this pest. If plants should be attacked the only remedy I know of is smoking with tobacco paper or rag. When this has to be done it should never be attempted to kill it in one night, rather smoke lightly for three successive nights, as an overdose is sure to seriously affect the Melons, the foliage being

of such a tender nature. I once saw a deplorable result of careless smoking, the fruit was about three parts grown, and the foliage completely burnt up. Insecticides should never be used if they can be avoided, as the leaves will only stand a very weak solution, not strong enough to kill the insects. Melons also club the same as Cucumbers ; in fact this is the most troublesome thing I have had to deal with, and I gladly invite discussion on it, as although I have tried several good remedies I have failed to thoroughly get rid of it, although I have to a certain extent kept it under by using more lime and soot in preparing the soil, also by watering the little mound round the stem in very fine weather, and thoroughly soaking the whole border. Red spider is a deadly foe to Melons, and the plants should be carefully watched for this pest. It usually commences on the parts near the pipes. The syringe should always be used well on the plants that are near the pipes, and if the enemy should appear well syringe every portion of the plants on a fine morning. This, if done with care, will keep the spider well in check ; but growers should always endeavour not to let it appear, as prevention is far better than cure.

STRAY NOTES.

WHO shall decide when doctors disagree ? A good many readers of the Journal are probably now wanting to settle whether to prune their newly planted Apple trees or to leave them alone, and a large proportion of these would no doubt pay a good deal of deference to the written opinions of the well-known specialists, J. W. and G. B. But they would find that the first says, " Prune," and the other says, " Don't." And, to add to the confusion, though it is most difficult to believe how G. B., with his great experience, can be wrong, it is plain on the face of it that the other is (W)right. In this dilemma I would suggest a compromise—nothing that would require the Editor of the Journal to provide a No. 15 Committee-room, or anything of that sort, but the following simple *modus vivendi*—between the two opinions :—Prune orchard standards, and don't prune pyramids, &c. Different things are required from standards, and surely they therefore require different treatment. We want standards to grow, and not to form fruiting spurs for the first two or three years at all events, whereas we want the others not to grow too much, and to bear as soon as possible. It would be allowed, I think, that pruning will produce more strong young wood than leaving alone would do, which would be more apt to form fruiting spurs. I expect all newly planted fruit trees will require more assistance than usual this summer, in thorough watering at times.

I am glad to see the farm department of the Journal still hammering at liquid manure and sewage, on which (because it was not generally held as such) even Victor Hugo could talk common sense. If sewage was not so generally wasted not only every gardener, but even every labourer with an allotment, ought to have so much that he would want no other fertiliser. The great advantage that liquid manure has over solid is, as I have before pointed out in these notes, that you can apply it just when it will do most good and no harm, and every gardener knows the advantage of that. Every drop that comes from my house, stable, cows and pigs' places, goes on my garden, and a great deal of the solid manure can thus go on the grass, where the liquid cannot well be so evenly distributed. I have also the drainage from several cottages and a malting, and in the spring, when Roses are growing, go cadging still further abroad, buying if need be. If the Surveyor or the Inspector of Nuisances has a trouble about drains, and a temptation to take them to the river, it generally ends, " Oh, drain it away to W. R. R., he'll take it and be glad of it."

If we are to have technical education let our labourers' sons be taught a little of their trade as cultivators—just the elements of the theory of the fertilisation of the soil—and then perhaps I should not see, as I did the other day, a huge ditch full of veritable sewage, poisoning the adjacent cottages, absolutely alongside of the allotment of a labourer, who told me he " did use a little of it last year, and some of his Potatoes went bad."

A great advertiser once said, I think, that however much you laid out in advertisements, it would always bring in a certain percentage as return, if one proviso was adhered to—viz., that the article advertised was really sound and good. Horticultural novelties, unless introduced through a society, undoubtedly stand in need of advertising as much as other new products. Where did I read that some time ago a nurseryman had actually to burn a large stock of Cox's Orange Pippin Apples because the public would not take it up or believe in anything to equal the Ribston Pippin in table properties ? And, indeed, it is strange to notice how a man will generally stick up for his local (and perhaps wrongly named) Apple as the best in England, even more stubbornly than he will for the local breed of cattle and horse. I come across some still who do not seem to know the merits of Cox's Orange ; was this a fault of want of advertising ? And, on the other hand, for the other side of the question, is it perhaps a remembrance of *Raphanus caudatus* which makes us shy of *Stachys tuberosa* ? The certificate of the R.H.S. is the natural guide of the public in such matters as these, and ought, I think, to be more sought for by buyers, and more depended upon as a hall mark than it is.

Every nurseryman would probably be able to tell of varieties of fruit or flowers which are neglected by the public in favour of others of a lower class, though these latter are no hardier or easier to grow. Ah, well! Even human beings find that merit does not necessarily at once bring reputation. But of the lovely hardy flowers which every one who has a garden can grow, I think few things are more neglected than Christmas Roses. Not, of course, that they are unknown, but people grow so few of them—two or three, half a dozen, or a dozen plants. What are these to anyone who delights in grand pure white flowers, which will bloom out of doors in midwinter without any trouble whatever? They should be grown by the hundred, whole beds of them. Why should space be grudged to such fine splendid blooms, which may be cut out of doors from November to March, and are not only beyond all question the queens of the winter garden, but often for a couple of months the only flowers to be seen? What other flower never drops its apparent petals, and can give no uneasiness to the decorator? This is, of course, because the white wings are really the calyx, not the petals, which are green and with the stamens, do fall; but this is unnoticed at a little distance in general decoration in churches or elsewhere, and how valuable this lasting quality is!

They are generally supposed to require glass protection during the actual time of flowering, which perhaps has acted as a check to their cultivation with some. I find that they are the better for it, but will do without it entirely in such dry weather as we have had lately, and altogether probably if the blooms be watched and cut just as they commence to expand. A fault is certainly to be found in the slow growth of the clumps, and consequent difficulty of amateur propagation; but they are not very dear, and no doubt would become cheaper in proportion as the demand increased. The large sort, Maximus or Altifolius, has not with me been much larger in flower, but much more perpetual in bloom. The ordinary sort comes with a flush—a whole bunch of sweet snow-white faces, like a bride's bouquet. Maximus gives two or three blooms at a time from November, when white Chrysanthemums diminish its value, right up to April. I do not know why the varieties of Helleborus niger have been called Christmas Roses, unless it is that they have been waiting hitherto for a rosarian to sing their praises.—W. R. RAILLEM.



ROSE SHOWS IN 1891.

- June 23rd (Tuesday).—Westminster (N.R.S.).
 „ 24th (Wednesday).—Richmond (Surrey) and Royal Aquarium.
 „ 25th (Thursday).—Winchester.
 „ 27th (Saturday).—Eltham and Reigate.
 „ 30th (Tuesday).—Canterbury and Diss.
 July 1st (Wednesday).—Bagshot, *Brighton, Brockham, Croydon, and *Lee.
 „ 2nd (Thursday).—Farningham and Norwich.
 „ 4th (Saturday).—Crystal Palace (N.R.S.).
 „ 7th (Tuesday).—Gloucester.
 „ 8th (Wednesday).—Dursley, Sutton, and Tunbridge Wells.
 „ 9th (Thursday).—Bath and Woodbridge.
 „ 11th (Saturday).—New Brighton.
 „ 14th (Tuesday).—†Wolverhampton.
 „ 15th (Wednesday).—Ealing.
 „ 16th (Thursday).—Hereford (N.R.S.), Helensburgh, and Trentham.
 „ 18th (Saturday).—Manchester.
 „ 21st (Tuesday).—Tibshelf.
 „ 23rd (Thursday).—Worksop.
 Aug. 1st (Saturday).—Ripley (Derby).

* Shows lasting two days. † A three-days Show.

The following Mondays are as yet altogether unrepresented—June 29th, July 6th, 13th, and 20th; also Wednesday, July 22nd; Fridays, June 26th, July 3rd, 10th, 17th, and 24th; and Saturday, July 11th. The next list of Rose show fixtures will appear early in April.—EDWARD MAWLEY, *Rosebank, Berkhamsted, Herts.*

PARIS GREEN AND ITS APPLICATION.

VERY timely is the appearance of an eight-page pamphlet by Miss E. Ormerod on "Paris Green; its Uses and Methods for its Application, as a Means of Destruction of the Orchard Moth Caterpillars." As soon as weather permits the caterpillars of the winter moth will emerge where eggs were deposited on fruit trees, and quickly set about their destructive work. Where the winter moth abounds it is the greatest scourge the fruit grower has to contend with, and if not subdued fruit crops are impossible. Persons who reside in districts that enjoy an immunity from the plague can scarcely form any conception of its ravages, while those who have had to wage war against are not likely to forget the combat.

It has been proved to demonstration at Glewston Court that nothing

will destroy the eggs and at the same time leave the trees uninjured, and the longest frost of the century had no influence in impairing their vitality.

It is a good thing to prevent the deposition of eggs by securing the wingless moths as they creep up the stems of trees in the autumn, by the agency of greased paper bands. But a more effectual method of stamping out the enemy is to prevent the development of moths, by destroying the caterpillars as they appear. Paris green will destroy them undoubtedly, and when properly applied does no injury to the trees. Miss Ormerod gives in her pamphlet all the requisite details for attaining the object in view, as founded on the practice of English and American authorities. She tells how to mix the poison and how to use it effectually yet safely, and refers also to different spraying appliances that have been found suitable for the purpose.

It is satisfactory to learn that in Mr. Lee Campbell's fruit grounds, in which millions of caterpillars were destroyed last year, that few eggs are to be found now; but in orchards where no repressive measures were taken the trees are infested with eggs, and every leaf and blossom will in due time be devoured by caterpillars if nothing is done to prevent it.

Miss Ormerod has laboured with great diligence for a long time, and created an interest in the subject of injurious insects that has led to the acquirement of knowledge respecting them which has been of great service to gardeners and farmers, and is therefore deserving of the thanks of the whole community of cultivators.

The pamphlet is issued at a mere nominal price—a penny, we think—but, as Miss Ormerod says in a postscript, "It will give me great pleasure to offer any information in my power, or to send a copy of my pamphlet to any applicants who may desire it for practical service." We append her address—Torrington House, St. Albans—but would suggest that the least applicants should do will be to enclose either a stamped directed postal wrapper or prepaid envelope for its transit. It is clear, concise, useful, and, we believe, perfectly reliable.

ROYAL HORTICULTURAL SOCIETY.

MARCH 10TH.

THE majority of Fellows and visitors who were present at the Drill Hall, James Street, Westminster, on Tuesday last freely expressed their surprise at the extent and attractions of the display provided. It was generally expected that the snowstorm of the previous day and night would have deterred those who intended exhibiting, but though it must have caused some difference it certainly did not have the anticipated effect. Rarely at this time of year has a more varied and interesting exhibition been secured, and considering the weather conditions it was astonishing. Orchids, Camellias, Daffodils, greenhouse plants, and bulbs were represented by collections and groups from several firms occupied much space, and in the afternoon the papers on Snowdrops, which were read by the Rev. W. Wilks, attracted an appreciative audience.

FRUIT COMMITTEE.—Present: Philip Crowley, Esq., in the chair, and Messrs. R. D. Blackmore, P. Veitch, J. H. Veitch, W. Warren, George Bunyard, J. Willard, T. J. Saltmarsh, A. H. Pearson, G. Wythes, J. Hudson, H. Balderson, F. Q. Lane, C. Penny, and A. Dean.

A box of Peaches received from the Cape of Good Hope by Mr. Jesse Willard, Holly Lodge Gardens, Highgate, was exhibited, and attracted some attention. The fruits were large, of a pale colour, but had evidently been gathered some time before they were ripe, as the flesh was tough and flavourless. They had, however, suffered little in transit. The box was received from Mr. Edward Hutt, who also sent the following letter, dated February 11th:—"I have taken the opportunity of an offer from the Chief Steward of the R.M.S., Roslin Castle, to convey a small box of Peaches to England for me. Should you receive same I trust you will find them in a good sound condition, and flavour up to the mark. I gathered and packed them myself direct from the tree, at what I think a fair state of ripeness, and anticipate a good result. They are a late variety known as the March Peach, of the clingstone type." A vote of thanks was accorded for the exhibit, but the general opinion was that the fruit would have to be in much better condition to command a sale in England. Some fine Vanilla fruits were shown by the Rev. W. Wilks, and from the Chiswick Gardens came good blanched samples of common Chicory, Witloof, and several other forms, together with similarly blanched samples of "the improved very early Dandelion."

Apple *Chelmsford Wonder*.—This seedling Apple was shown by Messrs. Saltmarsh & Son, Chelmsford, for the second time to prove its keeping qualities, and an award of merit was granted unanimously. The fruits are handsome, about 3 inches deep and 3½ inches across, the eye in a deep and plaited basin; the stalk short, thick, and inserted in a deep cavity. The skin yellow with numerous red streaks on the exposed side of some fruits. The flesh is firm and acid, and the cooking qualities were indicated by some prepared fruits placed before the Committee.

FLORAL COMMITTEE.—Present: G. Paul, Esq., in the chair, and Messrs. B. Wynne, R. Dean, G. Bryceson, C. T. Druery, H. M. May, G. Phippen, F. Ross, C. E. Pearson, E. Mawley, C. Jeffries, W. Bain, J. Walker, T. Baines, George Gordon, T. W. Girdlestone, J. Fraser, and H. Turner.

Most conspicuous in the Show was the exhibit of Messrs. W. Paul and Son, Waltham Cross, which comprised a dozen boxes of Camellia blooms about twenty in each box, thus affording an extensive display.

well meriting the silver-gilt Banksian medal awarded. A selection of the best varieties was represented, but we hope to refer to these more fully another week. Roses were also included, the forcing and bedding variety, White Lady, being shown for comparison with Lady Mary Fitzwilliam, and their distinctness was apparent at a glance; the Hybrid Perpetual Rose Denmark was also shown, the blooms being of a bright pink colour, very fragrant and free.

Greenhouse plants from Messrs. H. Low & Co., Clapton, provided a beautiful group, in which the handsome plants of *Acacia Drummondii* were greatly admired. The bright *Boronia heterophylla* and the fragrant *B. megastigma* were in good condition, Heaths, *Chorozemas*, *Brachysemas*, *Cytisus*, and *Cyclamens* completing the collection (silver-gilt Banksian medal).

From Mr. G. Phippen, Reading, came the only exhibit of Hyacinths, Tulips, Crocuses, and similar forced bulbs, which are usually so notable at the March meetings. The plants were arranged in wide pans or shallow pots, and the bright colours of the flowers were most welcome (silver-gilt Banksian medal).

We were well reminded of the approaching Daffodil season by Messrs. Barr & Son of King Street, Covent Garden, who had one of their customary beautiful and interesting groups, comprising many varieties in each of the sections of *Narcissus*, together with the bright blue Scillas, early Irises, brilliant *Anemone fulgens*, Snowdrops, *Bulbocodiums*, and *Megaseas* (silver Banksian medal).

Sir Trevor Lawrence, Bart., M.P., Burford Lodge, Dorling (gardener, Mr. Bain), sent a series of very handsome *Anthurium* spathes of the varieties, hybrids, and species so well grown at Burford Lodge (silver Banksian medal). W. E. Gumbleton, Esq., Belgrove, Queenstown, Ireland, showed some Daffodils, a Tulip, and the pretty *Iris Rosenbachiana*. The Rev. W. Wicks, Shirley Vicarage, Croydon, contributed some good specimen Snowdrops, including *Galanthus Imperati*, *G. Elwesi*, *G. nivalis* and *flore-pleno*, and *G. plicatus*, which served to illustrate the papers subsequently read. James Allen, Esq., Shepton Malet, who exhibited a group of *Galanthus* seedlings, some of which had received names, such as *Alleni*, *Galatea*, *Titania*, and *flore-plenissimus*, also a Daffodil named *Welcome* collected in the Pic du Midi. Messrs. R. Veitch & Son, Exeter, sent a flowering spray of the peculiar *Lotus peliorhynchus*, and Mr. Allen, Gunton Park Gardens, Norwich, showed a large basket of double white and purple Violets, the blooms of great size (vote of thanks).

ORCHID COMMITTEE.—Present: Harry J. Veitch, Esq., in the chair, Dr. M. T. Masters, and Messrs. F. Sander, Lewis Castle, Jas. Douglas, and James O'Brien.

Before the ordinary business of this Committee was commenced Mr. Veitch referred to the death of Mr. Dominy, and commented upon the good services he had rendered in the Orchid world. He also stated that a fortnight after Mr. Dominy's widow died, and last week his second son had also died, all from the same cause—pneumonia. It was moved and seconded that a letter of condolence be sent to the eldest son, Mr. George Dominy, of Southampton, in this peculiarly painful concurrence of fatalities.

An extremely beautiful group of Orchids and fine-foliage plants were shown by Messrs. B. S. Williams & Son, Upper Holloway, for which a silver Flora medal was worthily granted. *Cypripediums*, *Odontoglossums*, *Dendrobiums*, *Cœlogynes*, and *Cymbidium*s were well represented, the three first-named genera by many distinct and handsome forms. Messrs. Sander & Co., St. Albans, showed a collection of Orchids comprising several novelties, the most distinct—*Odontoglossum luteo-purpureum Amesianum*—securing a first-class certificate. *Masdevallia hybrida Kimballiana* is the result of a cross between *M. Veitchi* and *M. Shuttleworthi*, and shows the influence of the two parents in an interesting manner. *Dendrobium nobile Cooksoni*, *Phaius tuberculatus*, *Odontoglossum nævium majus*, several fine *Cattleyas*, and cut flowers of the pure white *Cœlogyne cristata* were also noteworthy (bronze Banksian medal). From Messrs. Low & Co., Clapton, came two plants of *Saccolabium bellinum*, one, having lighter coloured yellowish flowers, being named *aureum*. Mr. Cookson, Wylam-on-Tyne, sent a capital plant of the remarkable hybrid *Phaius Cooksoni*, having two strong racemes, and a plant of *Dendrobium nobile Cooksoni*, raised from a cross between *D. nobile* and *D. Cooksoni*. The former, being the seed plant, was interesting as showing the identical characters of the pollen plant (vote of thanks).

A group of Orchids from Mr. William Whiteley, Westbourne Grove, was awarded a bronze medal, and included *Odontoglossums*, *Dendrobiums*, *Lælia cinnabarina*, and *Cattleya citrina*, all well grown plants. A wonderfully fine specimen of *Cymbidium eburneum* was not duly entered on the Committee's list, and was in consequence nearly overlooked. The plant was a large and healthy one, with fifty-two substantial, sweet, and pure flowers, and the silver Banksian medal awarded was a just recognition of the plant's merit. It was said to be from the Duke of Norfolk's garden.

CERTIFICATED PLANTS.

Odontoglossum luteo-purpureum Amesianum (F. Sander & Co.).—A remarkably distinct variety which, in the form and general character of the flowers, showed its relation to the type named; but the colour was greatly changed, and it is, in fact, distinct from all other *Odontoglossums* in that respect. The flowers are of medium size, the petals and lip fringed on the margin, and of a uniform soft, delicate, pale greenish or citron tint, quite the shade so fashionable a short time since, and often termed "artistic" (first-class certificate).

Dendrobium nobile, Hardy's variety (Mr. W. Holmes, gardener to

G. Hardy, Esq., Pickering Lodge, Timperley).—An especially fine variety, distinguished by the excellent shape of the flowers, in which pure white is contrasted with deep purple tips, and an intensely rich blotch in the lip (award of merit).

Cattleya Trianae Hardyana (G. Hardy, Esq.).—A variety described some years ago, and possessing flowers of exceedingly good form. The petals broad and rounded, blush tinted, the lip very broad, deep crimson with a light margin and a pale yellow throat. A fine type of *C. Trianae* (award of merit).

Amaryllis J. R. Pitcher (B. S. Williams & Son).—This richly coloured *Amaryllis* resulted from a cross between the varieties *Mrs. Garfield* and *Crimson King*; the latter, the seed parent, being one of the ordinary spring flowering type; the former is the first break of the *reticulata* group procured by Messrs. Williams. The one here described is, therefore, particularly interesting on account of its parentage; and though it shows somewhat of the reticulated veining in the substance of the flower the white central line in the leaf has completely disappeared. The flowers are of medium size and good shape, of an intensely deep rich crimson shade and they are borne in heads of two to four each, the plant being strong and free. It will be a very useful addition to the *Hippeastrums* of the well-known Upper Holloway type.

A PATENT GARDEN PUMP.

UNDER the name of Snow's Patent Garden Pump a simple and useful instrument is shown in the Crystal Palace Exhibition of Horticultural Appliances, to which attention was called last week. The

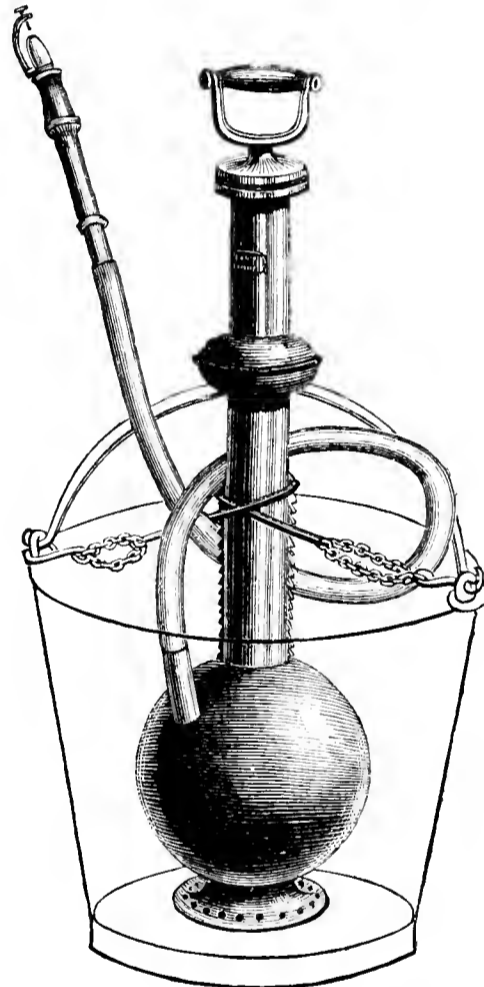

FIG. 38.—SNOW'S SPRAY PUMP.

special features of this little machine are the following:—First, it is adaptable to any ordinary pail; secondly, no packing is required; and, thirdly, while considerable force is obtained by downward pressure, there is no waste of water, as the escape all returns to the pail. The water can be distributed in a stream to a great distance, or the nozzle can be filled with an ingenious "divider," which forms an extremely fine spray. It will be found very useful by amateurs and in small gardens where more elaborate apparatus is not required.

AS OF A DREAM.

(Continued from page 152.)

SAID I to my wife, "The Centenary Show of the Chrysanthemum comes off next week. I should like to run up and look at the flowers. Suppose we both go, and Bob would be delighted to see you in London." "No; we could not both leave home together, as our best cow would calve about that time." "Well, then, if you can't go I will take up the selection of Potatoes that I offered for the Guildhall Show, of what I consider to be the pick of my sorts, to compare against their offsprings and others which I know are to be at Westminster." A card came from Mr. Dean. "Do I understand that you intend to compete for the Messrs. Sutton's prizes?" I answered, "Merely to stage a collection, as size would be sure to rule in the prize exhibits."

For the interim, whilst the travellers are at the tender mercies of

the railway porters' hands, I will tell you how I have been helped by the pigs, and often by the rats, to arrive at the knowledge of quality in a Potato. Formerly, as the American varieties came over to us, I grew them for comparative trials, as they and my own seedlings became vetoed. The strains were and are destroyed by being boiled for the pigs and poultry. On one occasion my man came to me in great dudgeon and said, "He didn't know what elded them red taters, but the pigs were hucking them out of the troughs all over the sty." "Hucking them out, Wooff; do they huck them all out?" "No; only the red 'uns." I had boiled a copper of my condemned seedlings, and along with them about a bushel of the American Rose. The pigs had given the former the preference. "Well, Wooff, this will never do; you had better take the large washing keller, and second-sized rammer, and smash the Potatoes all up together, then the pigs must eat them." Wooff stood 6 feet in his stockings. I often told him he would never wear himself out, and this ram-smashing caused a lot of grumbling on his part on "boiling-down days." At last I told him I would do it myself. I did not like to be tied to the job, so I said to my man one excessively hot day, "Let us try what the curd-crusher will do to help us." The water was strained off through a quarter-inch iron-meshed sieve suspended over a tub, as the tubers were laded from the copper, a sieve full at a time shot into the mouth of the machine. Admirable! The murphies became almost sufficiently mashed for a dining table. No more discriminative "huckings" on the part of the pigs.

I had fifty varieties of my Potatoes stored away for seed in boxes in the barn last winter. The rats could take their choice; Prizetaker was preferred. I was just in time to save a few fragments of them. I keep on the look out, and when the rats come I stick old ploughshares into all the holes there may be but one; there I lay a rat trap. The creatures have as great an aversion to a ploughshare sticking out of their holes as they have to a trap when they can see it; but the latter I cover lightly with fine dry soil, whilst I wear a pair of leather gloves. By thus proceeding it is soon all over with the rats, otherwise they would give their preference to the Potatoes, of best quality first doubtless.

Well, the cow got over her calving, and twenty-four hours having elapsed to give confidence versus uncertainty, November 11th found me early in the morning at the Aquarium staging my Potatoes. It generally takes me some time to please myself in these matters. To attract attention I worked around the plates an intermixture of ripe Honesty and Traveller's Joy; for a change the conceit was not bad. My descriptive cards read, "A selection of Fenn's Seedling Potatoes, embracing quality and good substance, studied especially for garden culture," and I will now add field culture, provided the field soil is delved and dug equally well as the ground in a garden. Excepting four kinds not yet in commerce, which I will name presently, the above will be well known as having been distributed by Messrs. Suttons. When I see the issues which are the outcome of varieties crossed with my sorts, merely to gain size and appearance for the astonishment of the natives, my bliss is lugubrious, because this description of Potato cannot possibly be equal to varieties carefully studied and handed down for quality from our best old English kinds, most of which have long since ceased to be, and cannot be partaken of otherwise than by their descendant pedigree blood, so to speak. Thus we can console ourselves in my family, as we find in these well-constituted sorts, which we partake of, a constant article of diet, where we formerly consumed two loaves of bread daily we now eat scarcely one. We find our Potatoes more sustaining than the modern compounds called wheaten flour, or those ingenious inventions of the bakers called bread; but we should be compelled to return to the old complement of loaves, under the commonality of Potatoes, as they are generally found.

It may be tiresome and useless in me thus to dwell, but as the cultivation of Potatoes must go on, and if you will allow me to do so I will still strive in these pages to assist to shape our courses, to make it better, surer, and easier to live. "Yes, then," you may say, "what next?" There is an exemplar of "what next" now going on in the Messrs. Sutton's trial grounds at Reading. I know you saw the beginning of it. I began "what next" nearly twenty years ago, when Mr. Pringle sent me a wild Potato, *Solanum Fendleri*, from South America. The difficulty of hybridising this wilding has proved insurmountable with me. I thought I had succeeded in crossing it with *S. Maglia* two years ago; in fact I did succeed in causing a few berries to swell until they were about half grown, when they fell off to my great chagrin. This feat must have caused the plant thorough exhaustion, for when I searched to harvest the crop not one of its tiny tubers was to be found. I then gave it up, as the prospect would prove too long and too expensive for me to go on with single-handed. The Messrs. Sutton will doubtless do so, but I trust they will not strike off into tangents for the creation of size. They have energy and knowledge, also one of the best hybridisers in the kingdom to carry out their instructions. The best has been done that can be done with our old sorts of Potatoes. New hopes must now lay in judicious crosses with the wildings and the sorts they own of my strains exhibited by me at the Aquarium.

As Ireland is again pushed to the front in her need for help in regard to this year's Potato crop, I singled out four of the sorts that I felt almost sure would add to reliability in maintenance for her favourite esculent food—Ringleader, first early (suitable for Ireland); Early Border (Sutton's Favourite), second early, to be dug for intermediate market purposes at once the moment the disease spot the leaves; Lady Truscott, second early (suitable for Ireland); Early Regent, second early (suitable for Ireland). This is my only seedling that I ever grew

into "stock" sufficient for Messrs. Suttons to be enabled to catalogue at once for distribution. I had so good an opinion of the variety that I grew it under the provisional name of Eliza Fenn. I consider it to be of the best of my raising, and Lady Truscott almost its equal; both of them very nearly disease-resisting, good all-round Potatoes. Then there are the following:—Rector of Woodstock, not to be beaten for flavour; Harlequin, a natural coloured sport from Rector of Woodstock; Woodstock Kidney, second early, to be dug for intermediate market purposes directly the disease spot appears upon the leaves; Prizetaker, Reading Russet, Reading Ruby, Fiftyfold (suitable for Ireland); Kate Fenn offers to be the earliest of all, not in commerce; Sir Polydore de Keyser, not in commerce; Sir Charles Douglas, a very late variety not in commerce; Newest Bountiful, coloured variety not in commerce. These last four I showed merely to let the Potato public know that I am not napping.

Evening.—"Now, Bob, I have completed my commissions. Tomorrow I shall have nothing on my mind, and we will go and get a good look at the Chrysanthemums, and I will brush up old friends. Good night, my boy." A letter was lying on my breakfast plate next morning with "Immediate" written upon the face of it. "From Alice," I said. "Something gone awry with the assessment lists, perhaps." "My dear Father,—Cow died this morning with milk fever." "Oh, dear, Bob! the cow is dead. I must go home at once to mother, as she will be so distressed, and won't know what to do. Take my members' ticket and this pass, and go in the evening to the Aquarium. Bundle the Potatoes into the case anyhow. Explain to the Messrs. Sutton's people why I am absent, and ask them to kindly take charge of the package to Reading." But, you see, Mr. Editor, how, "The plans of men and mice gang oft a-glee," As of a Dream.—ROBT. FENN.



KITCHEN GARDEN.

SPRING CABBAGE.—There is a very great scarcity of small plants, while the majority of those put out last autumn have cut up badly. Borecoles and Broccoli being even more scarce, there is all the more necessity to take extra pains in forwarding plants raised in heat. It is to be hoped much seed has already been sown, otherwise no time should be lost in the matter. Sow the seed somewhat thinly in pans or boxes, and place these in gentle heat. Before the plants become drawn place them on a shelf near the glass still in gentle heat, and transfer to warm greenhouse shelves or other light positions soon after the first rough leaf has formed. In about another week they will bear being pricked out in boxes, though they will pay well for being potted off, as they will transplant the most readily from pots. Two plants may be sunk deeply into the soil in every 3½-inch pot, and these can be parted when planted out without much injury to the roots. In any case keep the pricked out plants in moderate heat and a light position till well established, hardening off and planting out on rich ground before they become badly root-bound. Cabbages, notably the small quickly growing varieties, including the popular Ellam's Early, succeed admirably in handlights treated exactly the same as Cauliflowers, and this season would amply compensate for the extra trouble taken with them. Those who fortunately have fairly well-filled beds of plants, and some also left in the seed beds, should fill up all blanks at once, or if there are none of the latter one-half of the beds may be broken up to fill up the vacancies in the other. Transplant with trowels, saving a good ball of soil about the roots. A surfacing of soot, or some kind of special manure, stirred in with flat hoes will be the means of forwarding the crops considerably.

SPRING BEDS.—Frames are not too plentiful in most small gardens, and in very many instances cannot be spared for raising a few early vegetables and plants. Much may be done without them. For instance, a capital lot of Carrots, Radishes, Mustard and Cress, and Lettuce, Cauliflower, Brussels Sprouts, early Broccoli, and Celery plants might be grown on a good sized shallow hotbed. Tall stout stakes should be driven into the corners of the bed, and more midway between, these answering the double purpose of keeping some stout boards, 11 inches wide or thereabout, and the soil enclosed by these well together, and will also support the fish netting or mats used for protecting the seed and seedlings from birds, cold winds, and frosts. Any light sandy soil will do, a depth of about 6 inches being ample. The seed of Horn Carrots may be sown thinly over a greater portion of the bed, quick growing Radishes, Cauliflowers, Broccoli, and Brussels Sprouts if sown with it coming off before they would much interfere with the Carrots. Celery germinates more slowly, and may well have a corner to itself, while Mustard and Cress should be sown thickly in patches at one end of the bed. Now is a good time to form one of these beds. They pay well, and the produce would be far ahead of any that could be raised in the open, and not far behind the same kind grown under glass. If it fails, the most probable cause will be overcrowding, too much being attempted on a small bed. It should be added that these "spring beds"

would also do good service if devoted later on to Vegetable Marrows, two or three seeds being sown early in May where the plants are to grow.

VARIOUS.—Advantage ought to have been taken of the dry weather and free working state of the ground to get most of the late Potatoes planted, deferring planting the second early and successional crops till April. If not already done Ashleaves or some other extra early varieties may be planted on a warm border, or where they can be temporarily protected whenever necessary. These will give early if light crops. Horn Carrots and Radishes may also be sown on a warm border, the soil of which is in good working order, but it is not advisable to sow either extensively for another month. It is yet much too early to sow Broccoli, Cauliflower, Borecole, Brussels Sprouts, Chou de Burghley, and Savoys in the open. Only Broccoli (Veitch's Autumn Protecting), Cauliflowers in variety, including the invaluable Autumn Giant, and Brussels Sprouts are wanted thus early, and the requisite number of plants of these should be raised in gentle heat. Sow the seed thinly in pans or boxes, or in beds of fine soil; give plenty of air before the plants become drawn, and prick out when of good size. If extra early Celery is needed the plants of a good white variety ought now to be coming up, or even be fairly well advanced in growth. Keep them in gentle heat till they are large enough to prick out and sow more seed, a pink variety being added this time, in pans or boxes, and place in heat. Thick sowing is a mistake in any case. Most of the seed will germinate in heat, and when all the plants are crowded none develops properly.

PLANT HOUSES.

Chrysanthemums.—Place the plants directly they are rooted into 3-inch pots, and arrange them for a few days where they can be kept close and shaded until they commence forming roots afresh, when they should be gradually hardened and placed in a cool structure where they will be safe from frost. All, or the majority of those required for the production of large blooms, may be allowed to grow on without pinching, but stop those required for bushes as soon as they are established in their pots. Cuttings may still be inserted, and large blooms may be had from plants rooted after this date.

Rhodanthes.—Fill 5-inch pots with any moderately light rich compost. Old Cucumber and Melon soil in which a little leaf soil has been mixed will do very well—one good crock at the base only is needed. Sow the seeds evenly on the surface and cover with about a quarter of an inch of soil. Place the pots in a temperature of 55° until the seeds have germinated, then gradually harden and expose them to cooler and more airy conditions. The object is to insure sturdy growth. When large enough thin the seedlings to about half an inch apart, leave plenty round the rim of the pots. When once the plants commence growing freely place five stakes 9 or 10 inches in length round the sides of the pots, and place round them two or three threads of matting as they grow.

Statice Suworowi.—Sow seed on the surface of fine soil and cover lightly, water gently, and place the pot or pan in heat until the seeds germinate. When the plants are large enough prick them out into other pans or boxes until they are ready for small pots, when they may be placed into them singly. After the seedlings are transplanted into boxes place them in an intermediate temperature and gradually harden them to cool treatment by the time they are ready for small pots. Be careful not to allow them to become root-bound before they are placed into 4-inch pots, which is large enough to flower them in. When well grown in pots this *Statice* is useful for conservatory decoration.

Sowing Seeds.—If not already done sow seeds of Primulas, Gloxinias, Begonias, Balsams, Cockscombs, Celosias, Nicotiana affinis, Acacia lophantha, Grevillea robusta, Cyperus distans, and Cineraria. Small seeds, such as Gloxinias and Begonias, should be sown on the surface and then gently watered, the majority of the others being only just covered. Place the pots or pans in heat, cover with a square of glass, and shade with paper from the sun until germination takes place, when they should be gradually exposed to light. Be careful the soil does not become dry until the seed has germinated, and not afterwards, or the seedlings will soon die.

Cytisus racemosus.—Young plants that were rooted in autumn may be placed singly into 2-inch pots and assigned an intermediate temperature. As soon as they commence growing and rooting take out the point of the shoot to induce them to branch, when bushy little plants will soon be produced. Directly the plants are ready they should be placed into 5-inch pots in a compost of good loam, one-seventh of manure, and sand. Cuttings of young wood taken off with a heel may be inserted in sandy soil, watered, and covered with bellglasses. If placed in heat and shaded from the sun they will root freely and soon be ready for potting singly.

Coronilla glauca.—Cuttings that were inserted in autumn and covered with bellglasses and the pots plunged in cold frames will now be rooted. These should be placed singly into 2-inch pots, using the compost advised for *Cytisus* with the addition of a little leaf mould. Let the plants after potting have a temperature of 45° to 50°. If kept too close and warm they are liable to be attacked by red spider. The tops of the plants must be removed frequently to induce them to make bushy little specimens. Repot the plants as they need it, and after they are well established in their first pots grow them on in cold frames until June, when they may be stood in a sheltered position outside. It is necessary to syringe them freely during warm bright weather, and never allow them to become dry at their roots.

THE BEE-KEEPER.

APIARIAN NOTES.

I HAVE read with much interest the notes of "A Sussex Amateur," and like him I have been wondering whether "A Hallamshire Bee-keeper" has been hibernating. If so, I hope he will be fully refreshed, and be able to give us something seasonable. I am sure his Punic bees are up and about long ago, and his enthusiasm aroused at seeing them at work, as they are doing so with me, and I look upon them as the "busiest" bee yet introduced.

As to the price of honey, I believe that 1s. per lb. would satisfy most bee-keepers, but the last autumn I sold for a friend a large quantity fine Heather honeycomb at 2s. 6d. per lb., and this came from a district where a writer said there was a lower yield of honey than with him in the south of Scotland; with his hundred hives he actually took less from them than many did in the north from half a dozen hives.

The main question at issue is not the prices obtained for honey, but how to maintain a fair price, and if possible raise its value. The first steps to be taken are to make the million to know the proper value of honey, and to give them the assurance that the honey is neither "strained through zinc," nor "pressed with the hands." The cleanly manipulation of honey is the most important matter to create markets for honey, it is the best thing and means to employ to bring consumer and producer together. The idea of pressing honeycomb with the hands and passing it through metal must be abandoned if bees are to pay. Bee-keepers must take the matter more into their own hands than they have done heretofore. When the Caledonian Apiarian Society was formed this was one of the main objects aimed at by its promoters, but the management ultimately fell into the hands of dealers, and the rules were ignored, many privileges of the cottar were forfeited, most of the funds were led into particular channels, and exhibits were unsafe when entrusted to the care of the Society. The extent to which this went on may be judged by the conduct of one or more of the Directors at the Dumfries Show of 1886. The first prize for sections was awarded to the Rev. Frank Taylor of Longtown, Cumberland, but was transferred to those of one of the Directors; and twelve jars of honey belonging to Mr. J. Smith, Dumfries, were exchanged, and in the end stolen. As Judge I was called back to repair this act of unfaithfulness, and put a private mark upon the jars, which I again judged at another show. The same day I received from the rightful owner a letter stating the fact as above. Had steps been taken to put the "saddle upon the right horse" immediately thereafter, it would have prevented the collapse of what promised to be the most useful Society of the kind in Great Britain, because it had at its back gentlemen of means, honour, and experience of bee-husbandry, and had at heart the good of the cottager bee-keeper.

Another item is to the effect that few from the south write upon bee matters to this Journal. I also deplore the backwardness of bee-keepers in this respect, because it is not for want of interest in bee-keeping nor in the unwillingness to write that articles do not appear from their pen, preferring, as many of them do, to write to me direct, and their epistles are often more lengthy than the Editor could find space for, and replies of interest I embody in my weekly articles. Not a week passes but several communications of the kind reach me, the latest being from a Yorkshire bee-keeper and gardener, being but one of many in that county who keep bees. He says:—"I am now out of love with the standard hive, and many others share the same experience." Unfortunately, he has had a difficulty with Carniolians. Trusting to dealers in these he has had, as a beginning, "a drone breeder, and latterly crosses instead of pure-breeding queens. Some of the bees are

minus the yellow bands, but others have from one to three." I suppose, in the latter case, he counts the edge of the segment next the thorax, which is not a band proper. He has "gone in" for the cheap Lanarkshire hive, and has a few of them already made; and I reciprocate his wish "that he is on the right track," and venture to go further, that he will not regret turning from the standard to the hive that is applicable to all places and seasons, and to every mode of manipulation that bees may be subjected to, while combs and bees are safe in them while in transit in a temperature that in other hives bees, combs, and honey would be in an inextricable pulp. As to getting pure queens, I have never been disappointed with the firm of Messrs. George Neighbour & Sons. I know they do their utmost to secure genuine articles.—A LANARKSHIRE BEE-KEEPER.

THE "HALLAMSHIRE" GLASS SECTIONS AND GRANULATION OF HONEY.

IN the issue for February 26th "A Sussex Amateur" wishes to know what has become of me and my sections, and how I account for the honey granulating next to the glass.

In the first place, though apparently very quiet, I have been far from still, and if your correspondent will write to the Secretary of the Bee Publication Co., Limited, 19, Cambridge Street, Sheffield, for a prospectus he will learn something to his advantage as well as the explanation. Regarding the other question, it was both stupid and unfair of the Judge to disqualify his sections because the cells next to the glass showed signs of granulating. No doubt wooden sections would have shown the same peculiarity had they been examined. I have sections worked in 1888 that are still liquid next to the glass, and they have been frozen too. I have Heather sections of 1889 that have granulated as well as others gathered at the same time which have not. It appears to me to be simply one of the arts to obtain sections that will not granulate, just like many sections filled all round, and this again is quite a matter of fancy, and has no logical base to support it. Still, I prefer to see the honey in a clear liquid state next to the glass, and from what I have observed this depends on keeping the super and sections quite warm. The sections must not touch the super in any part, then the honey is ripened down somewhat "extra," as it were; for the sole cause of either honey or sugar "graining" is the presence of air, which keeps the particles apart, and so gives room for the crystals to form. Remove every particle of air, and no sugar will "grain" or candy. I pointed this out in 1883 in the "B. B. J.," and was well laughed at, as all "authorities" swore by vinegar and cream of tartar to prevent syrup granulating.—A HALLAMSHIRE BEE-KEEPER.

THE BEE PUBLICATION CO., LIMITED.—We have received a prospectus of the above Company, which is being promoted in Sheffield by a number of influential gentlemen, amongst whom we notice "A Hallamshire Bee-keeper," primarily to print and publish a new Bee Journal entirely in the interests of bee-keepers, "free from clique interests or bias of any kind." Those of our readers who desire further particulars about the scheme can obtain them from the Secretary, Mr. T. Bonner Chambers, 19, Cambridge Street, Sheffield.



All correspondence should be directed either to "THE EDITOR" or to "THE PUBLISHER." Letters addressed to Dr. Hogg or members of the staff often remain unopened unavoidably. We request that no one will write privately to any of our correspondents, as doing so subjects them to unjustifiable trouble and expense.

Correspondents should not mix up on the same sheet questions relating to Gardening and those on Bee subjects, and should never send more than two or three questions at once. All articles intended for insertion should be written on one side of the paper only. We cannot reply to questions through the post, and we do not undertake to return rejected communications.

Crocuses (*F. G.*).—They are not extensively grown in the London parks, but some may be seen in the Hyde and Regent's Parks, but not next week. By far the best collection is grown at Kew, but the weather has arrested the expansion of the flowers.

Gardeners' Wages (*J. G.*).—Your question, like many more pertaining to legal matters, does not permit of a categorical reply being given. We suspect the advice a lawyer would give would depend mainly on whether the cottage is included in the wages or is independent of them, and this in itself, for anything we know to the contrary, might form matter for dispute. If the question is of material importance you had better consult a solicitor.

Lemon not Fruiting (*XXXI.*).—Your plant would have borne fruit before now if it had been grafted from a fruitful tree when the seedling was two years old. It is, however, old enough for flowering now, and, if healthy, does not make luxuriant shoots, and the wood is well ripened by full exposure to the sun in summer and autumn, flowers ought to be produced another year. An expert gardener could, however, graft the plant if you wish and have the requisite conveniences to ensure its success.

Oleanders Poisonous (*Inquirer*).—The remarks in the work to which you refer pertain to plants growing in groves in their native habitats, and not to those grown in pots in this country. In respect to these we have never known any injury result, except when a person has cut his hand while pruning and the knife was wet with the juice. Though we cannot say there is any positive danger in having a few of the flowers in rooms, we should not prefer flowers from such a suspicious family of plants. That Oleanders are poisonous is beyond doubt. The name of the *Ruscus* is *hypophyllum trifoliatum*. We are obliged by your reminder.

Cork Dust—Sea Sand (*H. E. A.*).—The cork dust will do no harm to the manure, nor good either, except it is to be applied to strong land or soil deficient in humus. It has somewhat the same effect as leaf mould, and this is good for certain soils and purposes. Sea sand is regularly used for propagating and mixing with soil for potting, some persons preferring it to any other kind. It varies, however, and if freshly gathered, we should try it experimentally at first by inserting a few cuttings and potting a common plant or two in some washed and unwashed, then note the results before using it extensively.

Syringing Muscat Grapes (*An Amateur*).—Some professional gardeners have found the syringe of assistance to them in setting Muscat Grapes, but we do not advise amateurs, or gardeners either, who have had no experience in the practice, to adopt it. They may try it, if they wish, on a few bunches, and note the results, but the overwhelming majority of the most accomplished Grape growers set their Muscats without syringing the bunches when flowering. Those who find the plan answer drive the water directly on the bunches about the middle of the forenoon, forcing off the liquid globules, we presume, that sometimes prevent the pollen from reaching the stigmas for the purpose of fertilisation. Our Grape-growing readers are quite at liberty to state their views, either in favour or otherwise, of setting Muscat Grapes with the aid of the syringe. We know that some have succeeded in doing so, while others have failed, and therefore we advise the inexperienced to proceed cautiously and experimentally in the matter. Lady Downe's and Gros Colman usually set well under suitable atmospheric conditions by giving the Vines a few sharp raps or shakes to disperse the pollen at the proper time.

Apple from Tipperary (*W.*).—It is probable that the Apple is Cobham or Pope's Apple, one of the Blenheim Pippin type, which is thus described in the "Fruit Manual":—"Fruit, large; ovate, handsomely and regularly formed. Skin, clear yellow, tinged with greenish patches, and strewed with dark dots; on the side next the sun it is marked with a few faint streaks of crimson. Eye, large and open, like that of the Blenheim Pippin, and set in a wide and plaited basin. Stalk, short, deeply inserted in a round cavity, which is lined with rough russet. Flesh, yellowish, tender, crisp, sugary, and juicy, with a rich and excellent flavour. A very valuable Apple, either for the dessert or culinary purposes; it is in use from November to March. This variety has all the properties of the Blenheim Pippin, and is much superior to it, keeps longer, and has the great advantage of being an early and abundant bearer. I met with this excellent Apple in the neighbourhood of Sittingbourne, in Kent, about the year 1842. The account I received of it was, that the original tree grew in the garden of a cottager of the name of Pope, at Cellar Hill, in the parish of Linstead, near Sittingbourne. It was highly prized by its owner, to whom the crop afforded a little income, and many were the unsuccessful applications of his neighbours for grafts of what became generally known as Pope's Apple. The proprietor of Pope's cottage built a row of other dwellings adjoining, in the gardens of which there were no fruit trees, and, for the sake of uniformity, he cut down Pope's Apple tree, notwithstanding the offer of 20s. a year more rent to spare it. The tree, being condemned, was cut down in 1846, at which period it was between fifty and sixty years old. The name of Cobham was given to it by Kirke, the nurseryman at Brompton."

Spraying—Chou de Burghley, French Beans (*S. J. A.*).—We are obliged by your reference. We make no pretence to retaining the "threads of arguments" in connection with matters of inquiry from correspondents. A letter is answered and done with, and in dealing with from 200 to 500 a day that are delivered at this office there is no other practicable course. We bestow with the greatest readiness all necessary pains in answering letters, but naturally expect inquirers to make their cases as clear as possible, and not to presume that we know what is in their minds when this is not stated. Spraying is much better than syringing for the destruction of caterpillars, fungi, and some

insects, as the fluid that is applied rests on them, or should do, in the form of dew, not draining off as in drenching with a syringe. We have seen the Strawsonizer at the Crystal Palace but not in operation, though we perhaps shall do. Something smaller and cheaper is wanted for the great majority of small gardens, and you will find something on page 213 that may possibly be applicable to your case. Mr. Stott has a cylinder at the end of a hand syringe for holding an insecticide, and it is delivered in the form of spray. You appear to think there is only one remedy for American blight, as you remind us three have been named at different times. We have not the slightest doubt that they will all answer the purpose if properly applied, and our readers can choose that which is the most convenient to them. We are not aware that the French Beans to which you refer are cooked differently from the ordinary Dwarf Kidney Beans that are grown in our gardens, though if you allude to one that is grown on the continent under the name of Princess, the pods may require to be boiled longer, as they are cooked after the beans have attained a good size in them. Possibly there may be other varieties of this type not sold in this country, but if you write to Messrs. Vilmorin, Andrieux & Co., Quai de la Megisserie, Paris, they will advise you on the subject. Chou de Burghley is variable, and, as a rule, the best results are had by sowing the seed about the middle of May. It is very hardy, and should have compact but not hard hearts, and when well cooked is delicious.

Aphides on Roses (S. S.).—We are obliged by your second letter. We never think of "trouble" if we can help either amateurs or gardeners out of difficulties. We are quite aware that there is a glutinous exudation from the buds of some trees, and shall soon see plenty of it, on Chestnuts for instance. Assuming this matter to be attractive to aphides, and that where it exists they abound, it is all the same true that it does not create them. What is termed "honeydew on leaves" is, in nineteen cases out of twenty, caused by insects, though we know very well that exudations from leaves are not uncommon, and are the result of a morbid state of the sap, which may be brought about by a low temperature. This is seen particularly in the case of Vines and Azaleas when the temperature falls considerably, seldom otherwise; but insects are certainly not exuded with it, however quickly they may appear after it, and they could not come in the absence of hibernating parents "waking up," or broods of eggs for hatching. Your plants that have been so troublesome this spring in growing aphides were taken possession of by the enemy last autumn, though you may not have known it, and we are quite satisfied that you did not take repressive measures soon enough this spring. The fact that aphides "carried" on to the clean plants adjoining do not take possession of them, but "wander about like sheep," proves that the other plants are healthy, the sap in a better state and enclosed in a thicker epidermis, which they cannot so well penetrate. You never see them attack the best leaves having the stoutest cuticle, but always the soft and weaker parts. That is what invaders generally do, whether they are insects or soldiers. First-rate Rose-growers never have a horde of aphides in their houses, and we can tell you the reason why. It is because they are first-rate managers. Syringing, as you have been doing under the circumstances, has, no doubt, destroyed a number of the marauders, but has simply knocked many down to creep up again and multiply, as they do extraordinarily. You must fumigate the house two or three times in succession until every trace of the pest has been destroyed. This is the only method of getting rid of the insects now you have allowed them to establish themselves to the extent you describe. We have had no experience with the preparation you mention, and trust it will answer your purpose, and only say that a good deal of the tobacco paper manufactured at the present time is not safe to fumigate with. With the disappearance of the aphids will also disappear the glutinous matter from the leaves and stems. You need not be alarmed about it. Rid the house of insects, and then keep the plants clean. This you may do by syringing them daily with the softsoap solution that has been recommended in these pages again and again by Mr. Bardney. If you have forgotten how to prepare it we will tell you once more if you wish. We advise, however, about the same weight of quassia chips as softsoap to be boiled, strained, and mixed with it. With a weak solution it is useless to syringe only occasionally; it must be followed up daily, and then aphides will give little trouble. Under the most careful treatment insects will appear from time to time, but the first that is seen should be the signal for prompt action, as there will be certain to be many more unseen. Waiting for an increase before fumigating, or otherwise destroying the few that may be visible, is the greatest mistake that can be made, and in the end the most costly. Cleanse your plants thoroughly, working away at them till not an insect is left. Water the plants carefully, syringe as advised regularly, protect them from cold draughts, and they will overcome the check they may have received. You ought to have written sooner.

Names of Fruits.—The names and addresses of senders of fruit to be named must in all cases be enclosed with the specimens, whether letters referring to the fruit are sent by post or not. The names are not necessarily required for publication, initials sufficing for that. Only six specimens can be named at once, and any beyond that number cannot be preserved. (A. C. C.).—The Apple resembles a small and somewhat pale Tyler's Kernel. (E. G. E.).—1, Wyken Pippin; 2, Bramley's Seedling; 3, Norfolk Stone Pippin; 4, D'Arcy Spice. (L. D.).—The Pear is Nouveau Poiteau, a very good specimen of superior quality.

Names of Plants.—We only undertake to name species of plants, not varieties that have originated from seed and termed florists' flowers. Flowering specimens are necessary of flowering plants, and Fern fronds

should bear spores. Specimens should arrive in a fresh state in firm boxes; Slightly damp moss, soft green grass or leaves form the best packing, dry wool the worst. Not more than six specimens can be named at once, and the numbers should be visible without untying the ligatures, it being often difficult to separate them when the paper is damp. (M. H. S.).—*Asclepias eurassavica*. (B. O. B.).—A good variety of *Dendrobium nobile*. We wish all our correspondents would send specimens for naming as well packed in moss as you have done, the flowers were as fresh as if just gathered. (E. E.).—A grand variety of *Dendrobium nobile*, one of the best for shape and size we have seen. The colour also remarkably good. (A. M.).—We do not undertake to name Camellias (see our rules above), and we can only suggest that your flower, which reached us in a rather battered condition, resembles *conspicua*. (J. B.).—1, *Dendrobium nobile*; 2, *Dendrobium crassinode*; 3, *Dendrobium Wardianum*. All very useful Orchids. (S. M. H.).—1, *Selaginella apus*; 2, *Selaginella Kraussiana*. Most of those plants grown in gardens as Lycopodiums are really Selaginellas; the true Lycopodiums are very different in appearance and less useful.

TRADE CATALOGUES RECEIVED.

Cooper, Taber & Co., 90, Southwark Street, London, S.E.—*Agricultural Catalogue, 1891.*
 Thomas S. Ware, Hale Farm Nurseries, Tottenham.—*Catalogues of Hardy Perennials, Alpine Plants, Peonies, Climbing Plants, and Florists' Flowers.*
 Ellwanger & Barry, Rochester, New York.—*Catalogue of Select Roses.*
 Dieksons & Co., 1, Waterloo Place, Edinburgh.—*Catalogue of Farm Seeds.*

COVENT GARDEN MARKET.—MARCH 11TH.

OUR market is now getting very scantily supplied, and signs are not wanting of a complete famine in green stuff, not only in this country, but abroad. Supplies of fruit of all kinds narrowing down.

FRUIT.

	s.	d.	s.	d.		s.	d.	s.	d.		
Apples, ½ sieve	1	6	to	6	0	Lemons, case	15	0	to	20	0
" Nova Scotia and						Melons, each	0	0	0	0	
Canada, per barrel	15	0	26	0	0	Oranges, per 100 ..	4	0	9	0	
Grapes, per lb.	2	0	4	0	0	St. Michael Pines, each..	2	0	6	0	
Kentish Cobs	45	0	5	0	0	Strawberries, per lb. ..	0	0	0	0	

VEGETABLES.

	s.	d.	s.	d.		s.	d.	s.	d.		
Artichokes, dozen ..	0	0	to	0	0	Mushrooms, punnet ..	1	6	to	2	0
Beans, Kidney, per lb. ..	2	3	2	6		Mustard & Cress, punnet	0	2	0	0	
Beet, Red, dozen	1	0	0	0		Onions, bushel	3	0	4	0	
Brussels Sprouts, ½ sieve	3	0	4	0		Parsley, dozen bunches	2	0	3	0	
Cabbage, dozen	3	0	0	0		Parsnips, dozen	1	0	0	0	
Carrots, bunch	0	4	0	0		Potatoes, per cwt.	8	0	4	0	
Carlitowers, dozen ..	3	0	6	0		Rhubarb, bundle	0	2	0	3	
Celery, bundle	1	0	1	3		Salsafy, bundle	1	0	2	0	
Coleworts, doz. bunches	2	0	4	0		Scorzoneria, bundle ..	1	6	0	0	
Cucumbers, doz.	4	0	3	0		Seakale, per bkt.	2	0	2	6	
Endive, dozen	1	0	0	0		Shallots, per lb.	0	3	0	0	
Herbs, bunch	0	2	0	0		Spinach, bushel	5	0	6	0	
Leeks, bunch	0	2	0	0		Tomatoes, per lb.	0	0	0	8	
Lettuce, dozen	3	0	3	6		Turnips, bunch	0	0	0	4	

AVERAGE WHOLESALE PRICES.

CUT FLOWERS.

	s.	d.	s.	d.		s.	d.	s.	d.		
Arm Lilies, 12 blooms ..	2	0	to	4	0	Mimosa (French), per					
Azalea, doz. sprays	0	4	0	9		bunch	1	0	to	1	6
Bouvardias, bunch	1	0	1	6		Narciss (Paper-white),					
Camellia, white, per doz.	2	0	4	0		French, doz. bunches ..	1	6	4	0	
" red	1	0	1	6		Do. Do. English,					
Carnations, 12 blooms ..	1	0	2	6		per bunch	0	9	1	0	
Christmas Roses, dozen	0	0	0	0		Narciss (Various) dozen					
blooms	0	0	0	0		bunches, French	2	0	4	0	
Cineraria, 12 bunches ..	6	0	9	0		Pelargoniums, 12 trusses	1	0	1	6	
Cyclamen, doz. blooms ..	0	3	0	6		" scarlet, 12 bunches	3	0	9	0	
Daffodils, doz. bunches ..	3	0	6	0		Poinsettia, dozen blooms	3	0	6	0	
Eucharis, dozen	3	0	6	0		Primula (double) 12 sprays	0	6	1	0	
Gardenias, each	0	6	1	0		Primroses, dozen bunches	1	0	2	0	
Hyacinths (Roman), doz.						Roses (indoor), dozen ..	0	6	1	6	
sprays	0	6	1	0		" Red (English) per					
Hyacinth, Roman (French)						dozen blooms	4	0	8	0	
doz. bunches	1	0	2	0		" Red, 12 bls. (Fanch.)	2	0	4	0	
Lapageria, 12 blooms ..	2	0	4	0		" Tea, white, dozen ..	1	0	3	0	
Lilac (French) per bunch	4	0	6	0		" Yellow, dozen	3	0	6	0	
Lilium longiflorum, 12						Snowdrops, doz. bunches	1	0	3	0	
blooms	4	0	6	0		Spiraea, per bunch	0	9	1	0	
Lily of the Valley, dozen						Tuberose, 12 blooms ..	1	6	2	0	
sprays	0	6	1	0		Tulips, per dozen	0	9	1	0	
Maidenhair Fern, dozen						Violets (Panne), per beh.	2	0	3	0	
bunches	4	0	9	0		" (dark), per beh. ..	1	0	2	0	
Marguerites, 12 bunches	4	0	8	0		" (English), doz. bunch	1	0	2	0	
Mignonette, 12 bunches..	3	0	6	0		Wallflower, doz. bunches	1	6	2	6	

PLANTS IN POTS.

	s.	d.	s.	d.		s.	d.	s.	d.		
Aralia Sieboldi, dozen ..	6	0	to	12	0	Foliage plants, var., each	2	0	to	10	0
Arbor Vita (golden) doz.	6	0	8	0		Genista, per doz.	8	0	12	0	
Azalea, per plant	2	0	3	6		Hyacinths, doz. pots ..	6	0	9	0	
Cineraria, per doz.	6	0	9	0		Lily of the Valley, per pot	1	0	2	0	
Cyclamen, per doz.	9	0	24	0		Marguerite Daisy, dozen	6	0	12	0	
Dielytra spectabilis, per						Mignonette, per dozen ..	6	0	9	0	
dozen	8	0	12	0		Myrtles, dozen	6	0	12	0	
Dracana terminalis, doz.	24	0	42	0		Palms, in var., each ..	3	6	21	0	
" viridis, dozen	12	0	24	0		Pelargoniums per doz. ..	0	0	0	0	
Erica, various, dozen ..	12	0	18	0		Poinsettia, per doz. ..	0	0	0	0	
Euonymus, var., dozen ..	6	0	18	0		Primula sibirica, per doz.	4	0	6	0	
Evergreens, in var., dozen	6	0	24	0		Solanums, per doz.	9	0	12	0	
Ferns, in variety, dozen..	4	0	18	0		Spiraea, per doz.	1	0	18	0	
Ficus elastica, each	1	6	7	0		Tulips, dozen pots	0				



GREEN CROPS.

Ploughing in green crops has often been recommended as an excellent way of imparting fertility to land, but more complete knowledge of many points affecting this matter was necessary to give certainty to it, and particular attention is now invited to the necessity for some further addition to the soil at the time of seed sowing to ensure perfect fertility.

It is obvious that a green crop used for manure must impart to the soil in which it is grown for that purpose much more fertility than it has taken from it. How is this additional fertility or plant food obtained? Ville, the French chemist, told us long ago that certain plants take their supply of nitrogen from the air and he gave as an example Lucerne, of which an acre takes from 264 to 352 lbs. of nitrogen from the air, so that if the Lucerne were ploughed in there would be a superabundance of nitrogen in the soil for a corn crop. Professor Wagner, Director of the Agricultural Research Station at Darmstadt, shows us that not only Lucerne, but all other leguminous plants, such as Peas, Beans, Tares, Lupins, Clovers and Serradella, obtain their nitrogen from the air and not from the soil. These, therefore, are the plants which may be ploughed in with advantage. On the other hand he proves that all the Cabbage tribe, Turnips, corn of all kinds, Potatoes, Mustard, Buckwheat, and Chicory obtain their nitrogen from the soil, and are incapable of taking it from the air.

One lesson of the highest importance, taught by him, to which we particularly invite our readers' attention, is the superiority of Tares to White Mustard as a manurial green crop. That White Mustard does some good we have proved repeatedly in our own practice, but Professor Wagner places the superiority of Tares to it beyond question. He goes further, and shows the importance of the addition of potash and phosphoric acid to the nitrogen contained in the green crop.

The difficulty in the way of direct action from his teaching lies in the presence or not of potash in the soil. That is a matter for each farmer to ascertain for himself by careful tests. Professor Jamieson at the very outset of the Sussex experiments showed how every farmer had it in his power to analyse the soils of his farm by the manure test. Without such personal attention the wasteful use of manure must continue. With it there may be both economy and certainty. The mention of Professor Jamieson is a reminder that probably the best substitute for the White Mustard is Serradella, the cost of seed per acre being the same, for though Serradella seed is double the price of Mustard, only half the quantity per acre is required. In an annual report of the proceedings of the Sussex Agricultural Improvement Association Professor Jamieson says:—"This plant, which is a leguminous one—like Clover—was suggested for trial by one of our members. Care must be taken to sow it very thinly. In the first year we sowed it too thickly, not knowing its character. It yielded about 2½ tons fresh fodder. In 1888 it was sown much thinner. The plants may be in lines about 8 inches apart, and 4, 6, or even 8 inches may be left between the plants. It does not appear very hopeful at first, and during a great part of the season one may conclude that it cannot come to much, but later on it branches out, presenting a great mass of fine soft edible matter. It yielded 22½ tons fresh fodder, which when air-dry gave fully 5 tons. The same success has been experienced in the colder climate of Scotland, where in 1887 the yield of fresh fodder was 8 tons; and in 1888, although up to the end of August they were only about 6 inches high, yet in the end of September the plot presented the

same 2 to 3 feet high plants, and the same dense mass of fine foliage. The yield was 18½ tons." Such a crop of a plant obtaining its nitrogen from the air, ploughed in for Wheat, would answer quite as well as Tares.

In Professor Wagner's experiments White Mustard and Tares were grown in his special trial pots in the previous autumn, both being buried in the soil while green as manure. Next spring potash and phosphoric acid were given in addition to both Mustard and Tare pots. Oats were then sown, the result being less than half a crop of Oats from the Mustard, a full crop of Oats from the Tares, quite equal to the crop obtained in other pots from a full dressing of potash, phosphoric acid, and nitrate of soda.

The practical outcome of these trials, therefore, is that White Mustard must now be replaced as a green crop for ploughing in as manure by some such leguminous plant as Tares, Clover, Trefoil, Lucerne, Lupins, or Serradella. They prove also that nitrogen, whether derived from such green manure or by the use of nitrate of soda, is a veritable monarch among fertilisers. Without it potash and phosphoric acid were practically worthless; with it they form a perfect manure, causing vigorous growth and a full crop entirely satisfactory in every respect.

WORK ON THE HOME FARM.

We have heard with surprise of heavy arrears of ploughing, and of the backward state of work on many farms. It is true enough that there was a cessation of land work for some two months at midwinter, but September, October, and November were all fine open months, and since the frost we have been favoured by exceptionally fine weather. March opens with plenty of dust upon the roads, and with soil in the best possible condition for the seed drills; yet with all this it is possible arrears of sowing may be heard of at the end of April. Push on, say we, and strive always to be beforehand with all seasonable work. It is the laggards who complain most, who clog the wheels of progress, who were caught by the frost while clamping the root crop last autumn, who failed to turn a fine autumn to full advantage for clearing the land, and who put off the sowing of winter corn till the frost prevented them from sowing it at all. We might go on with a long list of faults and failings, with which we have no sympathy, but to no good purpose we fear. Rather will we advise strenuous efforts at improvement in every detail of farm practice in a season which has opened so auspiciously.

See that lamb castration and docking has prompt attention; keep down foot-rot by weekly examinations of all sheep having the taint of it. Pare off every loose part of the hoofs, wash the feet thoroughly, apply Gell's ointment, and keep the sheep on a dry floor for a few hours subsequently to allow the dressing to be absorbed into the feet. By close and regular attention to the flock in this way the disease may be prevented from anything like serious development. To drive the sheep into a corner of a muddy fold, trim the feet, and turn them loose again, does very little good.

Let down-calving cows have quiet, clean, dry quarters, wholesome food, and clean pure water. Never suffer them to stand about on litter much saturated with water, or out on a wet pasture. Provide a commodious loose box or shed for calving, and should a case of abortion occur keep the cow quite apart from the others, thoroughly disinfect the walls and floor of the shed or cowhouse, and keep the litter used in it out of reach of the other cows. Whether or not abortion is infectious, it is certain that it frequently runs through an entire herd. It may be owing to all the cows having been subjected to similarly adverse influences, but the wise course is to act precisely as though it were infectious. Do not let out the cows on pasture till there is a full bite of grass, which there will not be for some time yet.

METEOROLOGICAL OBSERVATIONS.

CAMDEN SQUARE, LONDON.

Lat. 51° 32' 40" N.; Long. 0° 8' 0" W.; Altitude, 111 feet.

DATE.	9 A.M.					IN THE DAY.				Rain	
	Barometer at 32° and Sea Level.	Hygrometer.		Direction of Wind.	Temp. of soil at 1 foot.	Shade Temperature.		Radiation Temperature.			
		Dry.	Wet.			Max.	Min.	In sun.	On grass.		
1891. March.											
Sunday	1	30.252	45.9	44.2	S.W.	35.9	51.7	32.4	76.8	27.8	—
Monday	2	30.112	50.0	49.0	N.W.	38.4	57.7	45.9	85.9	44.6	—
Tuesday	3	30.257	40.6	36.4	N.W.	40.0	49.2	34.6	85.1	28.0	—
Wednesday	4	30.389	44.6	41.7	W.	39.0	50.9	36.8	65.9	30.2	—
Thursday	5	30.302	49.2	43.3	S.W.	39.9	57.1	44.5	94.4	38.3	—
Friday	6	30.0 9	41.9	34.7	W.	49.8	54.4	38.1	91.3	53.3	—
Saturday	7	29.737	43.2	43.4	S.W.	41.0	50.8	41.8	61.8	31.9	0.451
		30.161	45.5	43.0		39.3	53.5	39.2	80.2	34.2	0.451

REMARKS.

- 1st.—Brilliant early, but frequently cloudy during the day.
 - 2nd.—Fine, with frequent sunshine, but spots of rain about 5 P.M.
 - 3rd.—Brilliant morning, with high wind; cloudy at times in afternoon; spots of rain in evening.
 - 4th.—Cloudy, with spots of rain in morning and evening; an occasional gleam of sun in afternoon.
 - 5th.—Fine and bright throughout.
 - 6th.—Bright morning, generally cloudy in the afternoon.
 - 7th.—Cloudy, with spots of rain in morning; heavy rain from 2 P.M.
- Fine bright week, and considerably warmer; the remarkably long drought broke up with a rain of nearly half an inch from 2 P.M. on March 7th. — G. J. SYMONS.



ON page 171 (the issue of the 26th ult.) "R. M." refers to my article on the subject of planting fruit trees in spring, which appeared a fortnight previously, and also describes the methods he adopted in transplanting some large Pear trees. I hope they will succeed, though they were really planted in winter when the ground was probably about as cold as it could be short of being frozen, and I suspect fresh roots will not be produced a moment sooner than if the removal had been effected a month later, if as soon. There can be no doubt that early autumn, when the ground is still warm, also moist, is the best time for planting all kinds of trees; but I regard spring as preferable to winter for supplementing or completing the projected work, always provided this is done well at a time when the soil is in a free working state. I have satisfied myself by experiments that trees root sooner and grow better transplanted in mild weather just after the sap commences moving than they do when as completely at rest as they can be in midwinter, subject to the very important condition that the roots are kept moist when out of the ground. Sap movement, and especially the descending current, depositing cambium, incites fresh root-action under appropriate soil temperature. The sap terminating in not broken, but smoothly pruned roots, naturally causes an enlargement there—a callus or cushion of tissue—from which new roots issue. In the autumn, as both the descending sap current and the earth heat are considerable, new roots form quickly. In spring the sap is more active and the earth warmer than in the dead of winter, therefore with trees properly planted and managed in spring the rooting process is facilitated accordingly.

If trees are planted in the dead of winter and some of them pruned closely at the same time while the branches of the others are not shortened till the buds commence swelling in spring, these latter will, as a rule, break the more "kindly" and root the more freely in consequence. There may be, and doubtless are, exceptions, according to the individual peculiarities of trees, but so far as my observations extend those exceptions are only of the ordinary kind which prove the rule.

I had some early lessons in spring pruning young trees from a celebrated Peach grower named Seymour. Many gardeners have seen "Seymour's System" of pruning and training illustrated, but comparatively few have seen it in operation, and not one in a hundred, or probably one in a thousand, could start a tree and train it to anything like the perfection that he did. His work more nearly approached mathematical accuracy than any I have seen, and his trees grown on open walls in the Duke of St. Alban's garden in Lincolnshire I have not seen equalled elsewhere either under glass or against garden walls, though many of these were, and are, most creditable to their cultivators.

In these utilitarian days the chief desire is to cover walls and trellises as speedily as possible with branches, regardless of any particular form or style of training, and therefore many Peach and other trees are not shortened after planting, or very slightly. The plan answers very well the purpose in view, but it would not answer in preparing trees to be trained as Seymour trained them. In what may be called the free-and-easy method of covering walls plenty of buds break, and form branches sufficient for the purpose whether pruning is resorted to or not; but in the Seymourian

system just the buds you wish to break must be made to do so, and these in the formation of young trees are near the base of the branches. The buds there are weaker than those at a greater distance from them, and naturally more tardy in starting. Yet these weak buds must be made to start contemporaneously with those above them, and grow as freely. This they cannot be relied on to do when the branches are cut back in the "dead" of winter, for the end buds start first and the others follow, producing later and weaker growths; but if the sap is allowed to flow through the stems and push the terminal bud till the young leaves are visible, and "spring" several of the buds below it, then the branches are cut back to the point desired, basal buds break freely that would otherwise have remained dormant or started weakly. That was Seymour's practice, and his splendid success proved it sound. Let the buds "lift the sap, start the pump," he used to say, "and you will not stop the flow by cutting through the stream; but by concentrating the force on the lower buds they are forced into action." He was right, as I have seen proved in scores of instances over a period of twoscore of years.

The principle in question applies to all kinds of trees, whether trained against walls or grown in the open. If, as is usually the case, the basal buds are desired to start freely they will be the more certain to do so if the young branches of recently planted trees are not shortened till the sap is distinctly moving than they would if the pruning were done when it was in a torpid state, and the sap movement in addition has its influence in summoning the roots into activity. The pruning no doubt checks the flow momentarily, but if the weather be mild does not arrest it materially, as nothing will do that but cold, such as frosty nights and dry biting east winds, and these are not so likely to occur late in the spring as earlier. I am alluding to trees planted in the winter, for those which are planted soon enough in the autumn to commence rooting at once will, if pruned before Christmas, start into growth freely when the right time comes.

It has been said, and the opinion is yet held by some persons whose scientific training entitles them to be listened to with respect, that pruning after the buds burst in spring is weakening in its tendency. First we are told, and this is obvious, that we deprive the tree of the sap in the branches removed; and secondly, there is an alleged great loss by "bleeding," and that the subsequent growths are weaker in consequence. In respect to the former objection let us present the case analogically. We find a spring from which water issues somewhat feebly, and it trickles away through a hundred channels. We prevent this distribution through so many miniature conduits, and hold the water up near its source, and confine it to half a dozen outlets. What is the result? Though we naturally lose the water that trickled away beyond the point of contraction we very soon have a far greater force in each of the six channels than could be possible in each of, say, six dozen. The concentration of the pressure gives force to the flow. Is it not the same in respect to the sap movement in fruit trees? When the roots are much reduced in the process of transplanting they can only supply sap feebly, and the greater the length and number of channels it traverses and the more numerous the buds on which it acts the more is its pressure reduced on each; but shorten the channels and confine the pressure to a comparatively few buds, the greater of necessity must be the pressure on them, and the stronger, also of necessity, must be the growth from each. That is a very simple, but perhaps intelligible, explanation of what I think the practice of most persons proves is a practical fact.

Now let us pass to the weakening through bleeding. Vines are not in question now, but outdoor trees. When the branches are cut back after growth commences there is no doubt a little escape of sap, but as a rule it is infinitesimal, and much more than counterbalanced by the stronger flow that speedily follows through the much reduced number of buds, and the growths from them are increased in vigour accordingly. As an example of this let us

glance at the practice of rosarians. They want, and must have, strong growths for producing grand blooms. They therefore prune closely, concentrating the root force on few buds. In no other way could they win prizes. Moreover, they do not prune till growths are freely pushing from the upper parts of the stems, because they desire the basal buds to remain dormant till the hoped for mild weather comes to permit of free unchecked growth from these buds on which they rely for the coveted blooms. When the pruning is long deferred, or rather not done till growth has advanced considerably, an escape of sap follows after the stems are cut back. This is occasionally so great as to cause some concern. But it soon ceases, the buds push, young shoots gain strength day by day through the roots having been incited into free action by the growths removed, and the grandest of blooms follow. There is never, so far as I have seen, a tenth part of the loss of sap through cutting back the long branches of recently planted fruit trees that occurs after pruning with at least equal severity established Roses, and it is not conceivable that the weakening can be greater where the escape of sap is infinitesimal in one case than where it is considerable in the other. So far from shortening the branches of trees after the buds commence swelling being weakening to newly planted trees it is strengthening in its tendency, and it is the only practical means of restoring the lost balance of force between the mutilated parts of the tree within the ground and the parts above it that need to be correspondingly shortened.

There may be trees that might, perhaps, not be profitably treated in that manner. Some may be so weak that they could not even if cut back produce anything but soft "pipy" growths, and if such trees could be kept alive unpruned and gently moving they would gain more root force, and grow all the stronger after being pruned another year; and similar results may follow bad planting or roughly bundling the roots into ungenial soil. Possibly also in very high and cold positions, where growth is naturally late, non-pruning the first season might be advantageous. I have not in view exceptionally bad trees, bad planting, or bad situations, but good trees sold by good nurserymen, and fairly planted in soil reasonably prepared for their reception; and under these conditions, which ought to generally prevail, I have found pruning after the buds start to answer well, and planting too, when trees come to hand in good condition and are intelligently dealt with by those who receive them. Two years ago some thousands of trees were planted on an estate during the latter half of March and first week in April; not one out of a thousand that was cut back failed to make good growth, but a small proportion were left unpruned as an experiment, and half of these died during the summer, the remainder struggling for existence. But for the pruning which I advised the loss would have been the greatest I have ever seen through mismanagement. The trees were good, with young branches varying from 18 inches to 2 feet in length, and it was noticeable that the stronger the growths of those that were not cut back the more complete was the failure. The very strong unpruned trees died, those less strong lived, but only produced tufts of leaves towards the ends of the branches, and it was only the weakest of the non-pruned trees that pushed most of the buds and made an inch or two of growth.

Those results are exactly what might be expected. The evaporating surface area of the long and strong branches would be four or five times greater than of the weak, and the roots in the former case could not maintain the supply; but in the latter case, where the evaporation was so much less, they could, with a little sap force in reserve for inciting and sustaining growth. Trees, therefore, with very weak branches may be more safely left unpruned the first season than the strong could, and the shortening of the branches of these in reducing evaporation from their surfaces has not only saved the lives of many trees, but resulted in satisfactory growth. Thus Mr. Raillem (page 211) may perceive that conflicting opinions may be to a large extent reconcilable. I doubt

very much if under the precise circumstances of any particular case "J. W." and "G. B." would materially differ in practice. With a full appreciation of the condition of the trees, root and branch, and of the soil and situation "G. B." would shorten many trees the same as "J. W.," who would modify his practice in the case of others, and the present apparently wide divergence would be certain to narrow down considerably.

Localities and seasons have an undoubted influence on trees. For instance, in the humid west the results of non-shortening long branches of trees after planting would not tell against their growth so forcibly as in the arid east. In America, where the atmosphere is very dry, a fruit grower of great experience and repute says with the system of shortening the branches he can "guarantee the growth of 95 per cent. of his newly-planted trees; but by leaving them unshortened he would not like to guarantee 10 per cent."

In respect to spring planting I repeat that, subject to the conditions previously mentioned, it may be done at this season of the year with more certainty of success than in midwinter. I am glad to have the support of Mr. Bunyard on this subject, for he says in a leaflet before me, "Vegetation has received such a check that fruit trees may be planted in safety till the end of March. Mr. Rivers says the same, and few persons can speak with greater authority. They are quite right, and those planted now, or even in April, and pruned, will be better established in the soil in the autumn than trees that are then planted for making good growth the following year. If by accident the roots and branches of trees arrive in a very dry state at this season, it is a good plan to throw them into a pond "neck and crop," and let them remain there for twelve hours, and they will then grow, though otherwise some might have died.

I intended saying something more about "R. M.'s" Pear trees, but the general subject has run away with me, and I must run away from his trees, or the Doctor will be after performing a surgical operation on these too lengthy notes.—J. WRIGHT.

HARDY FLOWER NOTES.

THE glory of the garden of which Mr. Edmunds spoke so eloquently a short time ago has begun, and the lover of hardy flowers is beginning to enjoy the feast of beauty which spring provides with such ungrudging hand. The Snowdrop, most chaste of all our flowers, in clumps in the borders, scattered amidst the grass, or here and there on the rockeries, adorns the garden, hanging her head, as Mrs. Barbauld says:—

"Like pendent flakes of vegetating snow."

Much as some of the other species are to be admired, none of the strangers from other climes need ever seek to oust from its place in our affections our native *Galanthus nivalis*, endeared to all of us by its beauty, its associations, and the atmosphere of poesy with which our bards have surrounded it. That gem of early flowers, *Iris Bakeriana*, has, however, anticipated the Snowdrop this season, blooming in the open as early as the 24th of January. It is now past, but the beautiful *I. reticulata* in variety has succeeded it, while the pretty, if not showy, *I. persica* is also in full flower. All these early Irises should be grown in quantity, and no one could desire anything finer than a mass of *I. Bakeriana* or *reticulata*. A worthy companion to these is *I. Danfordiae*, known also as *I. Bornmülleri*, and there might be also added *I. Histrio*, known also as *I. reticulata histrioides*.

Several of the Hepaticas are now in flower, and in early spring there are few flowers more brilliant than these if allowed to form large masses in the garden. It takes a long time, however, for a single plant to grow into respectable dimensions, and where it can be afforded it is better to purchase clumps. What can be brighter or more pleasing than clumps of the single blue, of the double red, or of the fine large *angulosa*? These "noble Liverworts" of the old writers are still far too scarce. The double blue never seems to become plentiful, although by chance one lights upon a garden where a clump is to be found and where it does well. From one of these places I obtained my few plants, which are doing well, and which in time will, I trust, form good specimens. The double white has been the quest of many, and although there seems no reason why it should not exist I do not believe that such a flower

is in existence. I have searched old gardening books and have made many inquiries, and the evidence is distinctly negative. Yet why should not a double white exist as well as a double red or a double blue? Is there a double *angulosa* anywhere?

The ever-welcome Crocus needs no eloquent pen to tell of its beauty, and now all around me it seems to say that my feeble powers had better leave untouched the theme. In truth, none of the poets can write of the Crocus in sufficiently glowing terms to satisfy the exacting votary of the flower. None comes nearer than Milton when he says—

“Underfoot the Violet,
Crocus and Hyacinth, with rich inlay,
Broidered the ground, more coloured than with stone
Of costliest emblem.”

And what “stone of costliest emblem” can compare with these brilliant clumps of gold, of purple, of white, or of lilac, with stripes of various hues shown by the fine named Crocuses of Dutch origin? Almost peerless among the striped varieties is one fitly named Sir Walter Scott, the “Wizard of the North,” whose romances so entrance the reader, and whose name is fitly associated with one of the finest of our garden Crocuses.

Deeply interesting, too, are the various species, some of which have not yet been used in the production of these florists' varieties. *C. imperati*, one of the prettiest Crocuses in the garden, fawn coloured, and striped with deep purple or black externally, and when open of a fine purple colour. Then we have *C. minimus*, only a little inferior to it in beauty; *C. Fleischeri*, white, striped with deep purple; *C. Sieberi*, purple, with a yellow base, and a number of others now in flower. One is sorely tempted to speak of these, but other things also claim a note just now.

Nestling in a corner of the rockwork is the exquisitely beautiful Cyclamen corm with bright crimson blossoms well raised above its deep yet bright green foliage. It seems to prefer having the corm slightly covered with earth. Few things are brighter; it is, as a lady said the other day, “such a bright little thing.” Not far from it are a number of plants of *Primula Cashmeriana* now coming well into flower. Some ten or so heads are in flower, and there is much beauty in the light green gold-dusted foliage, surmounted by the bright purple flowers. This and *P. rosea* are among the finest of our early spring Primulas. In a cosy spot under a tree are a few plants of an early Primrose, kindly sent me by Miss Jekyll last year. This, named Munstead Early White, is a variety well worthy of propagation. The flowers are large, of good substance, and freely produced, besides being of a good colour. I purpose propagating for associating with this a yellow seedling of my own, which has been in flower all winter, and is now quite covered with bloom. It has large deep yellow flowers, and has been tested for about three years.

The *Chionodoxas* are late with me this year, and are not fully in flower. They seem to be relatively later with me than most other flowers. The *Scillas* are only showing colour. The first of the *Narcissi* flowered on the last day of February. This was *N. minimus*, which flowered with me on 13th January last year. It is hazardous to conjecture what may be the next, but it will probably be *N. scoticus* or *N. minor*. *N. pallidus præcox*, which does well with me, is “out of the running,” as also is *Ard Righ*. I expect the early blooming of this variety in some places is due to early lifting and early replanting.

Saxifraga oppositifolia and *S. o. alba* are very fine at present. The first, which has been established for some years, is now a good-sized plant, and the close carpet of dark green foliage and beautiful purple flowers hanging over a ledge of limestone is particularly beautiful. The earliest of the *Saxifragas* is *S. Burseriana major*, which is a very desirable plant to grow.

I have just received the Journal, and have read, with the pleasure his articles always give, the notes by “D., Deal,” on new or rare herbaceous and alpine plants. The notes on the *Aubrietias* are especially interesting to me, as they are favourite plants of mine. Is what “D., Deal,” calls *A. græca* *Ingrami* synonymous with *A. g. pallida* raised by Mr. Ingram and offered some time ago by a Norwich firm? *A. Leichtlini* is a first class plant. I have had a few rather interesting results with seedlings of this, one of these being what may be called a “plum purple.” *A. rosea* is sufficiently distinct to grow, but let me warn the grower not to be disappointed with it on first coming into flower, as the rosy colour is not pronounced at first. I have some seedlings of *A. rosea* from which I hope to have a little variety. I understand that Max Leichtlin has a good white *Aubrietia* in store for us. I am sure it will have a hearty welcome when it is sent out. Space will not permit of further remarks at present, but permit me to echo the recommendation by “D., Deal,” of *Gypsophila paniculata*. One reason it is so little grown is that it does not transplant readily, and is best grown from seed. I showed a spike from a plant 4½ feet

high at our local show last year, and it created quite a sensation. Another recommendation it has—viz., it is an “everlasting.”—S. ARNOTT, *Rosedene, Kirkbean, N.B.*

WITLOOF.

THE vegetable or salad known as Endive in Paris, and the exact name of which is Witloof, or Headed Common Chicory, is so easily produced that it is a matter for surprise that it is rarely met with in the kitchen gardens of country seats, which are often far from any market, and where, therefore, should be made ample provision for a supply of vegetables and salads during winter.

The Witloof is the forced and blanched shoot of the large rooted or Brussels Chicory, and can be obtained only from that variety, which is characterised by the width of its leaves and the great size of their midribs. When blanched by underground forcing it forms a kind of head, very compact and firm, of an ivory white colour, bearing carriage well, and remaining fresh for several days if well treated. The leaves are either used uncooked as salad, or boiled and seasoned in different ways. In the first case they resemble the *Barbe de Capucin* salad, and in the second they bear some analogy to the coiled curled Endive. But whatever may be the way in which they are used, they furnish an agreeable, sound, slightly bitter vegetable, which is most delicately flavoured.

It may interest some of your readers to know how the Witloof is produced, and I venture therefore to send the following notes. The seed of the large-rooted Chicory, which must be true and genuine, should be sown during June or in the beginning of July on deeply dug ground in rows 6 to 10 inches apart, and when well up the seedlings should be thinned so as to leave twenty to thirty roots to the square metre. When the seed is sown too early a large proportion of the plants are prone to run to seed the first year.

It is not impossible to prick out the young plants, and that operation is even to be commended in market gardening, where it is often important that the ground be cleared as quickly as possible. In that case we can sow the seed in a reserve bed in June, and prick out the seedlings towards the 10th July, after an early crop. The plants are set out about 6 inches in all directions. In October they are fully developed, and the roots are of the size of a common spade handle. Then is the time to take them up, to trim off the leaves about 1½ inch above the neck, and shorten the roots by about 6 inches. At the same time any secondary shoots are to be removed that may appear on the sides or around the principal shoot, which alone should be kept.

Directly this is finished the roots are placed in an upright position, close together, in the trenches prepared for their forcing. These trenches, opened in a sound and well-drained part of the garden, should be 15 inches deep—viz., 15 inches below the surrounding level of the ground. The bottom must be well loosened and pulverised to make easy the planting of the roots, and the intervals between the latter are to be filled up exactly with the soil from the trenches, so that the roots are well kept in place, and the soil covers them well up to the necks, which latter should all be placed on the same level. This being done about 8 inches of rather dry soil is added, if it has been put in a heap under cover in a shed or other place a few weeks in advance.

The trenches, which may be of any length, with a usual width of 4 feet, being thus prepared, one forces the various portions successively according to the wants. This is very easily done by placing on the portion to be forced a layer of 15 to 20 inches of fermenting manure. In twelve to fifteen days the ground is sufficiently warm to produce the Witloof, and the manure may be transferred on the following portion of the trench, increasing its heating power if necessary by the addition of some fresh dung. The heads are usually fully developed only after twenty days, but it only requires to cover the portion which has been heated with some litter or straw mats to keep up the warmth and finish up the blanched heads.

The latter are cut off with a portion of the neck of the root attached, sorted according to size, and packed in the square baskets which everybody has remarked on the Parisian market. Thirty heads are usually reckoned to weigh 1 kilog., and the wholesale price in Paris varies from 80fr. to 100fr. per 100 kilogs.

Attempts have been made to force the Brussels Chicory like the *Barbe de Capucin* by placing the manure direct under the roots, covering the latter only with a small layer of sand or compost; but the result has not realised the expectations of the planters, the heads of the Witloof opening instead of remaining conical and folded. The same roots are sometimes planted again after the heads have been cut off, and by gently forcing them in half darkness they yield a green salad, pretty bitter, but tender, called here “*Chicorée améliorée*.”—EUG. SCHAETTEL, *Paris*.

LILAC FOR FORCING.

How seldom do we see Lilacs recommended for forcing during the winter when flowers are scarce and costly, and yet I venture to say that there are few other hardy shrubs better adapted for this purpose, and certainly none more appreciated by ladies. When they are managed in the proper way Lilacs are readily forced and flowered.

Lilacs are much in demand here for room and table decoration, therefore I have to force a considerable number in order to maintain an unbroken supply during the winter, and as I have been fairly successful I think it might interest some of your readers if I detail my mode of treatment.

I prefer plants on their own root to those grafted on common stocks, although those grafted or budded do not require quite such careful treatment. In March or April the cuttings are taken from plants which have been forced. I select shoots which are just beginning to become a little firm, and which are moderately strong but not unduly vigorous. They are taken off with a heel and placed round the side of a 4-inch pot in very sandy soil, but making this firm about the cuttings. The pots are placed in a propagating case, which is kept rather close till the cuttings are rooted, generally accomplished in about three weeks. After they are well rooted they are gradually brought to the light and hardened, at which time they are transferred into 3-inch pots, any sandy soil being used for them. They are then placed in a cold frame and carefully watered, and when all danger of frost is past they are planted out in a sunny place, where they remain until they are large enough for forcing. That is the time they must have proper treatment in order to bring them into a flowering condition. They are pruned into shapely plants before being forced. I cut round them with a sharp spade at about a foot from their stem, or so that they will drop into a 12-inch pot after the loose soil has been shaken off. This I do in August, and the plants are lifted not later than September or the first week in October. They are potted in loam and a little manure and some sand, making them very firm. They are then taken to a shady place, and kept syringed and watered as often as required. I endeavour to keep the foliage on as long as possible, this assisting root action.

I like to have my first plants in flower on Christmas Day. I generally give the plants three weeks to do this in, which I find long enough, provided the weather is not severe; but should the weather be sharp at the time I allow a week longer. I find the best place wherein to force them is a warm stovehole on the top of the boiler: but where such a place cannot be provided a warm Mushroom house will do, although they will require a longer time. Of course, I am assuming that such varieties as Charles X. are to be forced, which is the best for the purpose, and that the flowers are required to be quite white. In this case, they must be forced in an absolutely dark place, such as those mentioned above. My plants are forced on the top of a boiler, where the temperature ranges from 65° to 75°. They are syringed once every day until the flowers are ready to open, when they are taken to a cooler house.

Some gardeners complain of their plants flagging. I think this is due to their being roughly handled while being lifted and potted, or not being properly prepared. If the plants are cut round once or twice during the summer there will be no fear of their flagging, for they will be a mass of roots, and come up with capital balls of soil attached to them. If they are potted any time from the middle of August to the last week in September, and treated as described, there will be no fear of flagging. It is only those who have seen good specimens well flowered in the dull days of winter who can form any opinion of their beauty and usefulness. When we consider that a plant in a 14-inch pot can be made to produce 100 trusses of lovely and sweet-scented flowers, and as large as any we commonly see in our shrubberies, and this at absolutely less trouble and expense than any other hardy shrub, we may well ask why they are not more commonly grown. Of course it will be observed that I have supposed the coloured varieties to be used for forcing, as they are more free and robust than the white varieties, and that they are required to be white, hence my recommending them to be forced in the dark.—J. A.

THE BLACK CURRANT MITE.

WE have long been familiar with the destructive ravages of this mite, which has rendered the culture of Black Currants impossible in many Liverpool gardens, and it appears to be rapidly increasing. For many years we failed to grow this desirable fruit, although every precaution was taken to select clean young trees from other localities, and to plant on fresh ground, but without success. We had no idea, however, until recently that the pest is

rapidly spreading throughout the country, and is as likely to prove as detrimental in the Currant growing districts as the phylloxera has in the vineyards of France. It has firmly established itself in the eastern counties, and already thousands of trees have been taken up and burned. In the fen lands of Lincolnshire it has spread rapidly, and from what we have seen will soon complete its work of destruction, for already acres of trees have been grubbed up, and the ground planted with Gooseberries, and used for other purposes. It is unfortunate, because land that is wet and heavy is suitable for the Black Currant, while it is too wet for other bush fruits.

Grubbing up the trees and burning them is a wise course to pursue, for loss will be occasioned whatever method may be adopted, and it is useless to retain trees already badly infested. The wholesale destruction of trees will fall most heavily on those that have planted land exclusively with Black Currants; and in localities where the mite exists, although the trees may not be attacked, they would act wisely by being prepared for any emergency that may arise. This insect migrates, as I have proved by experience, and as long as there are infested trees in the locality none can be considered safe, even if they are isolated. Certainly they have a better chance of escape than those growing side by side.

The reason I am alluding to this pest is because there are many who are familiar with the outward appearance but who do not believe in the existence of the mite as the cause. These diseases cannot be too generally made known amongst growers, especially when we find in localities that it is believed to be due to other causes, and these beliefs propagated by those who should know better. In a fruit-growing locality that need not be named it was noticed last season for the first time, and the prevailing opinion was that the mild weather of the early part of the year had caused the fruit buds to swell enormously, and a very beautiful crop had been anticipated, although I was glad to find that some had examined the matter for themselves, and had discovered the existence of the mite, and taken measures to expel it from their plantations by burning all infested trees. When these prominent-looking buds never developed, or only produced the most miserable shoots and bunches, the severe weather or frosts of spring were considered the cause. Those who persist in these theories will eventually learn to their cost that the cause is not due to the weather, but an insect that will persist in its ravages until the growth of the tree is arrested, every bud attacked, and the tree gradually dies.

As far as we can observe there are no means of coping with this pest and save the trees from destruction. The insect lives, and does its work of destruction amongst the scales of the buds, and is thus protected from insecticides and other measures of a like nature that might be adopted for its destruction. Strange though it may seem, trees that are old or have become checked and stunted first become a prey to this pest. Young vigorous trees seem to resist it for a time, but unfortunately only for a time, when they are attacked. It is useless to root up a few trees or cut off affected parts with the hope of getting rid of this mite, and place clean young plants in the same soil, for they in turn will also be attacked; in fact it is almost certain to make its appearance the next season. We followed this course at first, but our efforts proved futile. Then we burned all old trees and waited two years before planting again on fresh ground, but these the second year after planting were attacked again, and badly infested the third. The insects on this plantation and another made afterwards must have migrated from other gardens in the neighbourhood.

Proclaiming certain districts has unquestionably proved advantageous in the case of various diseases amongst cattle. I am inclined to think that some such provision is necessary in stamping out this Black Currant mite. If put into practice it would be the means of protecting those in localities where the mite does not exist, and of stamping it out in those where it has gained a footing. Young trees are sold by thousands from infested districts, and are thus assisting in spreading the disease, if I may so term it, broadcast throughout the country.

There is not much to fear from large growers who have a living to make. They are generally wise enough to take these matters in hand at once, to stamp out the pests and plant the ground with other things that will prove remunerative until fresh plantations can be established; but they have to fear, as well as raisers of young trees, the perversity of small growers. In cottage gardens and others it frequently happens that where there is two or three, or it may be half a dozen trees, they will not destroy them when they know they are infested as long as they continue to bear a few fruits. But this is a general failing, and plants of various kinds, both indoors and out, are frequently allowed to remain long after they are diseased and infested with insects. There is wisdom in clearing out all plants in this condition promptly unless they can

be speedily restored to health or the insects destroyed before they reach others.

The Black Currant mite, as far as my observations went, is on the wing towards the end of July and during August. We tried syringing the trees at that time with petroleum and water, which we thought had the desired effect from the improved appearance of the trees afterwards. But the work of syringing these trees on a large scale perhaps for some years would entail too much labour, and prove too costly for those who are engaged in growing for the market. As long as infested trees remained in the neighbourhood it would be necessary to continue the practice. In gardens where only small quantities are grown it is worth trying, and other experiments in the same direction with other solutions might with advantage be tried.—W. M. BARDNEY.



DISAS.

Of the greenhouse species of this genus, *D. grandiflora* is much the best known, and is rather extensively, though not always, well grown. There are a few forms of it in cultivation. *D. g. superba* is very distinct in colour, and more dwarf in habit than the species. It sometimes happens that *D. grandiflora* proves troublesome to grow in some localities. We have seen plants, apparently well cared for, having a hard struggle for existence; while some, under similar conditions in other collections, flourish.

The temperature best suited for Disas has been the subject of much controversy, and has apparently been well thrashed out. It is, however, apparent that a certain temperature is not all-important, probably not the most important of their wants. It is well known that this Disa will bear a considerable amount of cold without injury, and as long as frost is kept away may be considered safe. This, however, is only a proof of its power to exist, not to flourish. When inured to very low temperature it does not pay for the room it occupies, and well deserves a more generous treatment.

A night temperature of 40° is safer than a lower one during the winter months. Many plants are doomed to a sunless northern aspect for life through the mistaken kindness of the cultivator. We have known instances where failures that have occurred for years have been reversed through removing the plants to a sunny southern aspect from October to the end of April. Much syringing is not desirable, though a moist state both of roots and atmosphere is imperative during the warm portion of the year. To maintain this the plants should be looked over morning and afternoon, and the stages flooded where practicable, the plants being stood on inverted pots in the water. In addition to this, the floors and walls should be kept continually moist, and the plants lightly syringed twice daily. Those who prefer a higher temperature and sunnier aspect for their plants have to employ more water during the summer, also ventilate more and shade more heavily, conditions we should not care to adopt.

Disa racemosa is a species of more recent introduction, and deserves extended culture. It is not so fastidious as the foregoing species, and will bear more ill-treatment without any material injury. We had under our care a few years since some plants, six of which were allowed to become quite dry, and remained so during the winter months. When taken in hand in February, and treated like the others, they grew, and threw up their flower stems equal to the rest. We could not detect the slightest difference between them when in flower. This is mentioned, not to encourage drying or neglect, but to show that should any such thing occur loss is not likely to follow. Had we treated *D. grandiflora* in this manner we should probably have a sorry tale to tell.—W. R. WILLIAMS, Great Marlow.

BEGONIA SEMPERFLORENS CARNEA.

DURING the first three months of the year this Begonia will probably yield more bright flowers for cutting than any other, provided it is grown well and in a suitable temperature. In the conservatory it does not flower profusely unless the temperature of that structure is kept about 55°. It is necessary the plant continue growing if a succession of flower trusses is to be produced. It appears to flower naturally during February and March, but to flower it well earlier it is necessary to keep it a little warmer. Stock is readily raised from cuttings which are better rooted in July than at the present time, but the shoots selected for

cuttings must have an eye at the base or they are no good, as they will only lengthen and not throw up from the base. If once plants of this nature are dried or partially so, and cut back, they never start again. Where it is desired to increase the stock as much as possible from one or more plants cut them back at the present time, and suitable cuttings will be produced from the base. The best method of managing this plant is to place it after flowering in a cool house and keep it rather dry for a time fully exposed to the sun, and then cut it close back.

Growth should not be encouraged before July, when the plants may be turned out, their roots reduced by one-half and repotted again in the same or slightly larger pots. The compost may consist of good loam two parts, the other two being composed of leaf mould and sand with a little manure added. If kept close for a time they will soon break into growth, and cuttings can be taken and rooted. The plants must not be kept too warm or too moist, or else they will grow soft and run up quickly. This must be avoided and a slow sturdy growth only promoted. They need little more than a cool house that is kept moderately close, and where they can be shaded from the strong rays of the sun. Towards the end of September place them where the night temperature is not allowed to fall below 55°, and where the atmosphere is not too moist. In October those needed to flower early may be given a temperature of 60° with a little air daily when favourable, which will induce the plants to flower freely by the end of the year, and be capable of supporting themselves without the aid of stakes.

Cuttings rooted now must be potted from time to time, but not be grown too fast in heat and throughout the summer in cold frames. Cuttings rooted now, or as soon as they can be obtained, will make capital plants in 6 and 7-inch pots for next season. Stop the shoots well until the end of July to induce them to throw up freely from the base.

This Begonia succeeds in baskets suspended from the roof, having *B. Ingrami* or some other suitable variety near the sides to hang over. The best plan is to make up the baskets with fresh soil about the time advised for starting these plants into growth, and then dibble rooted plants of *Ingrami* round the sides, and allow the two to grow together. By this means quantities of cut flowers are produced without taking up stage room, and in addition add to the appearance of the structure.—N. G.

AURICULAS IN SCOTLAND.

THIS winter the plants had a long rest owing to the long continued frost. The severe weather seems to have done them no harm, and there have been scarcely any losses among the various collections in Scotland. A few young plants not very well established have gone, and it is always a curious circumstance that when an old plant goes it is one of the best and scarcest varieties. For instance, this year I have lost a fine plant of the Duke of Argyle; another grower has lost *F. D. Horner*, and another Colonel Taylor. The plants began to move in earnest in the first week of February, and since then the growth has been rapid. At the present time the plants are looking remarkably well, and it is expected that the bloom will be early. My own opinion is that the bloom will not only be early but irregular, though some of my Auricula-growing friends do not agree with me in this. It is, however, the fact that when the foliage expanded it was seen that many of the trusses must have been formed at an earlier period than usual and were well advanced. Most of the plants are in a normal state of growth at this period.

Auriculas at this time and for some time to come should have the grower's eye upon them, and now and then each pot should be in his hands, and if anything is wrong it should be immediately put right. Particular care must be observed in watering, so that the soil may not have an excess of moisture or be too dry. No sensible man will water every pot in his collection at the same time. The surface should now be stirred, taking care not to disturb the roots. Top-dressing is not now so much practised as formerly, but they who follow the old plan should now do it. Regarding top-dressing, one of my correspondents, an extensive grower, writes:—"I use Clay's fertiliser freely both at potting time and in February when I top-dress with fresh soil. I just take the same soil as I use for potting, but add a little Clay's fertiliser. This causes the plants to root freely, in fact the roots become matted, and the leaves are leathery and vigorous. I use it freely, and it never makes the bloom coarse."

On the same plan another correspondent writes:—"I generally give the Alpines a mere snuff when doing them up at this time. I use it very sparingly, and have not overcome the idea that the more complex bloom of the stage varieties would easily be thrown out of balance by such manures. I have given young plants a pinch, and seedlings in boxes. I would say, If you use it at all to your

flowering plants, that you cannot be too sparing." If any grower in England uses Clay's fertiliser for his Auriculas his experience would be interesting. I shall apply it to a few plants and judge of its effects for myself. Alpines are vigorous and healthy, and almost every one will give bloom. One grower in this neighbourhood informs me that so far as he can yet judge of the trusses of his stage varieties, he thinks many of them will have fewer pips than the requirements of competition schedules. This is not the case with my own plants, as my trusses show the usual number of pips.—JOHN MORRIS, *Dundee*.

VEGETABLES—THEIR VARIETIES AND CULTIVATION.

[A condensed report of a paper read by Mr. J. LAMBERT, The Gardens, Onslow Hall, Shrewsbury, at a recent meeting of the Birmingham Gardeners' Association.]

(Continued from page 201.)

Good Onions make a telling dish amongst twelve vegetables, and as yet I have not been able to grow them so large as those we see grown further south, especially by Mr. Wilkins in Dorsetshire. Growers in these districts are enabled to plant out a month earlier than we can in Shropshire. I have tried many ways, and find the best results from sowing in boxes or in pots and transferring the seedlings into small pots or boxes until they can be planted in the open ground.

For this crop it is advisable to trench the ground in autumn, giving a good dressing of manure, and in spring fork it over, mixing in a heavy dressing of soot, treading the ground when dry before transplanting the Onions. Be sure also to make the soil firm around the plants when turned out of pots or boxes and planted, placing a stick with a tie to each to prevent the young plants breaking down. Syringe and keep them moist until they get plenty of roots, and by the end of September good bulbs may be expected.

Seakale is truly a gardeners' friend, this season especially. I do not employ Seakale pots covered with fresh manure for heating. I lift all my roots every year, trimming off spare roots and sorting into two sizes, first and second; I then bury them in the ground, and bring in a supply once a week and force them. From the roots cut away in trimming we select all the largest for growing on, cutting each piece about $3\frac{1}{2}$ inches long, and before planting them we start them into action by tying them in bundles of fifty and placing them in a little heat, causing them to grow and show several crowns or growths, removing all but two when planting out, and this is done with a dibber, so that the new crowns are about 3 inches below the surface, and filling up the hole with some good fine soil, and afterwards disbud to one crown. Seakale must have change of soil, and the land needs two dressings of salt, one at planting time, the other when trenching or digging the ground.

I advise all to secure the new Lily White Seakale, and work up a stock from roots, not relying upon seeds. With me it grows much stronger than the old sort, and realises a better price in the market. Plant out Seakale sets as you would a flat of Cabbages, about 9 inches apart from plant to plant, and the rows 16 or 18 inches apart.

Another good vegetable, and one that will be largely grown when more known, is the new Chinese Artichoke, *Stachys tuberosa*, and the best way to cook it is to fry it in butter. I saw this vegetable first at the Vegetable Conference in London, and I now grow it, and am very pleased with it. It crops abundantly, and from one small tuber from eighty to one hundred are easily obtained. Plant in a warm situation, as you would early Potatoes, in rich soil; and give a plentiful supply of manure water in dry weather. In the autumn lift all the roots, and keep them in damp sand, to be used as wanted. With Potatoes for exhibition purposes I have the same trouble through the soil here being so stiff. On each set as planted we place two good shovels full of good prepared soil, mixed for the purpose, consisting of sifted potting soil from underneath the potting bench, burnt earth, and lime mixed together. This keeps them free from scale until the roots are in the garden soil, then they become scabby and disfigured.

I scarcely need allude to Tomatoes more than to say that for exhibition purposes they must be grown under glass. I find Peach houses excellent places, and grow the plants on the one-stem plan either in pots or planted out. If planted outside against walls very strong plants must be prepared, but there is always an uncertainty as to a crop.

The Cardoon is a favourite dish with a great many. One short row will supply a good table, and if not sown too early they will not run to seed. The midrib is eaten after being blanched with paper or hay bands wrapped around the stalks like Celery.

Grow in trenches as you would Celery or Leeks, sowing the seeds in the trench in May.

Celery and Leeks.—For both make good trenches, filling in with good light soil after digging in a good dressing of rich manure, and mixing in salt for the Celery and soot for the Leeks. When ready for earthing use brown paper in preference to soil, and keep them well watered during dry, hot, summer weather. I have seen no Celery yet grown by gardeners to equal some grown by mechanics or cottagers. The finest I have yet seen was grown in Leicestershire.

Globe Artichokes are much esteemed at a gentleman's table. Judges, as a rule, look for these in twelve varieties of vegetables. Beyond making fresh plantations in good soils, they require but little attention, and each clump should consist of three plants, and clumps 4 feet apart; but as these are often produced from seed, it is difficult to get a good variety. That I grow for exhibition purposes was awarded a certificate at the Vegetable Conference as being the true variety.

Just a few words about Asparagus. To obtain fine heads I should by all means grow them as single plants, in rows, on the French system. I regret that on one occasion I had some dug up for forcing, but they were not acceptable at the house table, as the smaller growth from some thirty-year-old beds is preferred, the flavour being so much superior; but I am not allowed to cut after the end of May. This restriction, together with liberal treatment by good manure, is the cause of their bearing so well at their great age. We also cut back all branches bearing seed pods at the earlier stage, not quite to the ground, and I attach some importance to this.

With regard to the cultivation of a kitchen garden, we are all well aware what an important thing it is to always keep the hoe disturbing the soil amongst young growing seedlings, and this should not be neglected, even if we are obliged to let weeds grow in other parts of the garden through being short of labour. Frequently with amateurs and cottagers, and some gardeners, time is spent in making up trim neat beds for seeds and crops. This is really a waste of time, and frequently a drawback to the crops on such beds. Carrots, Parsnips, Onions, and other vegetables are very often sown in rows not more than 6 to 8 inches apart with a pathway between the raised beds probably 18 inches in width. This 18 inches of space would be much better divided between the rows, much to the benefit of the crop. The rows of Carrots should not be less than a foot apart, Onions at least 10 to 11 inches apart, and quite 15 inches for Parsnips, thus enabling a Dutch hoe to be used, and much better crops will result than when grown much closer together. When growing these crops for exhibition purposes, I recommend sowing on level ground and watering when necessary, and drills can be left here and there for passing up and down for watering them. Brussels Sprouts, to have them fine, should be sown early, and planted early in firm good soil and with plenty of room.

(To be continued.)

LIBONIAS.

WHEN well grown these are useful plants for decoration at this time of year. They may be raised annually from cuttings of young wood taken from the plants after flowering. They strike freely in sandy soil in a temperature of 60° if placed under hand-lights or in the propagating frame. Directly the cuttings are rooted and hardened by exposure in the house in which they have been rooted, place them into 2-inch pots in a compost of loam and leaf mould in equal proportions, with a little sand added. When roots have commenced forming freely place the plants on a shelf, or, better still, plunge the pots where the night temperature ranges about 55°, in which they can remain until the end of May or the beginning of June, then carefully harden and place them in cold frames. When the young plants are 4 inches high pinch the point out to induce them to branch. Shoots that take the lead may be stopped from time to time until the beginning of July, when they can be allowed to grow unchecked. The one thing important is not to allow the young plants to become root-bound until they are placed into the pots (5 or 6-inch) in which they are intended to flower. In the final pottings one-third leaf mould only should be used, and one-seventh of decayed manure may be added. It does not matter materially whether the plants are grown under light shade or not until July, but after the final pinching they can be grown fully exposed to the sun.

In some seasons they succeed planted out, but the fault of this system is, if the season proves a wet and sunless one, they will grow luxuriantly enough, but often fail to flower profusely. We have attained the best results—namely, plants covered with small but good flowers, by keeping them in cold frames throughout the season. The lights are thrown off when the weather is fine and

warm. The growths must be well ripened, or they will not flower well. After plenty of roots are formed artificial manure applied to the surface is beneficial. From cuttings rooted now plants a foot high and as much or more through them can readily be produced in a season.

Where small plants are needed in 3-inch pots the cuttings need not be rooted before the middle of May, and placed when rooted into the pots in which they are to flower, and from the time they are established they can be hardened and grown fully exposed. Mealy bug will infest these plants, and care is needed not to place them where these pests exist. Aphides also attack them, but these are readily destroyed by fumigating.—O. M.



EVENTS OF THE WEEK.—The Royal Society meet to-day (Thursday) at 4.30 P.M., also the Linnean Society at 8 P.M. The Quekett Club meet on Friday, March 20th, at 8 P.M., and the Royal Botanic Society on Saturday, March 21st, at 4 P.M. On the last named date a spring Show will be held at the Crystal Palace, Sydenham, in conjunction with the exhibition of horticultural appliances, and a competition of spraying machines and instruments will take place on that occasion. The Royal Horticultural Society's Fruit, Floral, and Orchid Committees will meet on Tuesday, March 24th, in the Drill Hall, James Street, Westminster when also a paper on "Hardy Bulbs and Plants," by Herr Max Leichtlin, will be read at the afternoon meeting.

— **THE WEATHER IN THE METROPOLITAN DISTRICT** has become rather more seasonable; the snow has rapidly disappeared under the influence of showers continued through several days. The temperature has been higher, but the days generally have been dull, and more sun is needed.

— **THE LATE SNOW STORM.**—The storm which passed over the kingdom last week appears to have been of an extraordinary character especially in the south and west of England. Railway lines appear to have been blocked for a week, and trains buried for several days, animals lost in hundreds, and towns isolated. Much injury has been done in pleasure grounds and plantations. In Mount Edgecumbe Park, Plymouth, the seat of the Earl of Mount Edgecumbe, many magnificent trees were torn up by the roots. In the plantations between Cawsand and Penlee hundreds of trees lie prostrate. At Warleigh Wood at least a thousand trees have been destroyed, the wind making almost a clean sweep of it. Cotchele House, Calstock, another seat of Lord Mount Edgecumbe, also suffered considerable damage, and hundreds of fine trees surrounding the house were either torn up by the roots or snapped off short. The rookery in front of the house was levelled. At Maristowe, the seat of Sir Massey Lopes, the storm did almost irreparable damage. The grounds are described as being a scene of desolation. A beautiful avenue of Lime trees, about sixty in number, are all down, and there is scarcely a tree or shrub which is not either levelled or mutilated.

— **STORM DAMAGE IN SUSSEX.**—On the night of the 9th inst. the tornado swept over Sussex and caused great damage in Sir Francis Wyatt Truscott's garden at Oakleigh. A little more than three years ago Sir Francis erected a wall 15 feet high and 90 yards long on the north side of the kitchen garden, and furnished with a glass coping 2½ feet wide. The wall was shortly afterwards planted with cordon Pears by Mr. F. Dunn, the gardener, the trees being of the best both in character and variety that Messrs. Cheal & Sons could supply. The progress they made was in every way satisfactory, some of the fruit being honoured at the Guildhall Show last autumn and sent to the Queen. The wall was entirely blown down, breaking the trees off close to the ground. The owner of the trees had watched their growth with much interest, and he had the promise in another year or two of having one of the finest cordon Pear walls in the kingdom. The disappointment experienced by Sir Francis cannot, as may be imagined, be otherwise than most acute, and is not less felt by his gardener who had managed the trees so well.

— **HEDGES.**—I hurriedly thank both you and "Forester" for the information respecting hedges, and I believe that the subject if once started would awaken general interest, as the present neglected state of

hedgerows in many districts is a very noticeable blot in the country. Owing to my recent change I cannot place my hands on the copies of Journal you mention, and a reproduction of the articles would be useful to many.—CRATÆGUS.

— **GARDENERS' ROYAL BENEVOLENT INSTITUTION.**—We have much pleasure in announcing that at the annual dinner of this Institution, to be held on the 8th July next at the Hotel Metropole, Whitehall, the Right Hon. Joseph Chamberlain, M.P., who was prevented, through illness, from occupying the position in 1888, has very kindly consented to take the chair.

— **GARDENERS' ORPHAN FUND.**—We learn with pleasure that the Duke of Bedford has generously granted the use of the Wholesale Flower Market, Covent Garden, for the purpose of holding a Floral Fête this season in aid of the Gardeners' Orphan Fund, and a Meeting will be held at the Hummums Hotel, Covent Garden, on Friday, March 20th, at 9 P.M., to take the matter into consideration.

— **AN INTERNATIONAL EXHIBITION OF MICROSCOPY** will be held at Antwerp during the months of August and September of the present year, supported by many of the most noted microscopists in Europe, and in conjunction with it there will be exhibitions of vegetable products and of horticulture. M. Charles de Bosschere is the President of the executive Committee, and M. Charles Van Geert, jun., the general Secretary.

— **THE COUNCIL OF THE PHOTOGRAPHIC SOCIETY OF GREAT BRITAIN**, 50, Great Russell Street, Bloomsbury, request us to announce that an Exhibition of collotype printing (a process in which photography plays the part of the lithographic artist, and a sensitised gelatine film that of the lithographic stone), by various English and foreign firms, will be on view daily till April 14th, between the hours of 2 and 9 P.M., at the above address. Admission on presentation of a visiting card.

— **CRIMSON GALANDE PEACH.**—This is a small-flowered variety, and one of the best Peaches in cultivation taking all points into consideration. Its only fault with us is a slight flatness in the shape of many of the fruits. If liberally treated it matures a large crop of very fine fruit of a good flavour, and with a colour not easily surpassed among Peaches. Your correspondent "R. P. R." therefore probably has the variety true to name. Although it is by no means easy to obtain, at any rate it is not a large-flowered variety.—W. H. DIVERS, *Ketton Hall Gardens, Stamford.*

— **THE SCOTTISH PRIMULA AND AURICULA SOCIETY'S** schedule states that the fifth Exhibition will be held in the City Assembly Rooms, Shore Terrace, Dundee, on Friday, May 8th next. Twenty-five classes are provided, with prizes from 20s. to 2s., and special prizes are also contributed by Mr. William Kilgour of Blair Drummond and Mr. John Morris of Dundee. Auriculas of the various sections have classes, also Alpine Auriculas, Polyanthus, Primroses, Primula species, and Narcissi. The Hon. Secretary is Mr. William Stratton, Annfield, Broughty Ferry.

— **AT** a recent meeting of the **CROYDON GARDENERS' AND AMATEURS' MUTUAL IMPROVEMENT SOCIETY** an interesting paper on the cultivation of the Peach was read by Mr. W. B. Glascock, gardener, Shirley Park. He referred at some length to the writings of Batty Langley, in his "Pomona," published in 1729, and detailed his practice, which is very similar to that adopted by gardeners of the present time. He thought it of great importance that a proper start should be made in the preparation of the soil, which should be good pasture loam; the ground should be trenched in October, and holes made 6 or 8 feet square, on the bottom of which should be placed a quantity of brickbats or slates to act as drainage, and also to prevent the roots from going down to the cold ungenial subsoil. The newly planted trees ought to be well watered and mulched in the spring. In planting care should be taken not to bury the roots too deeply, the same attention to be given in spreading and arranging the roots as that given to the training of the branches and shoots. He described fully the method of pruning, training, and nailing, and advised frequent syringing, especially during dry weather to keep the trees clean and free from insects, and some protection should be applied early in the season to guard the bloom buds from frost. He found ordinary garden netting used double to answer the purpose very well. A good discussion followed, in which several members took part, and questions arose as to the best manures and the best time to apply them, stocks for grafting the best sorts to grow, fertilising, &c. A pleasant and instructive

evening rewarded those who ventured out to Mr. Glascock's paper on a wintry night. He received a hearty vote of thanks for his contribution.

— THE SPALDING CHRYSANTHEMUM SHOW is announced to be held on November 18th and 19th, 1891, and the modest schedule enumerates thirty-three classes for Chrysanthemums, fruit, and vegetables.

— GARDENING APPOINTMENTS.—Mr. William Moorby, foreman at The Gardens, Bankfield, Bingley, for the last twelve years, has been appointed head gardener to G. Knowles, Esq., Moorhead House, Shipley, Yorkshire.

— THE WEATHER IN THE NORTH, March 16th.—For the last nine days pretty sharp frosts of from 9° to 17° have occurred. Cutlers have been able to indulge in "the roaring game" in the middle of March, which luckily does not often offer. On the morning of the 14th sleety showers fell, and rain followed in the afternoon and continues, with a high cold east wind.—B. D., *S. Perthshire*.

— WITH much regret we have to record the death of MR. WILLIAM RICHARDS, who had for many years been connected with the *Gardener's Chronicle* as publisher and business manager. His death, which was not unexpected, for he had long been suffering from pulmonary consumption, occurred on the 11th inst. in his forty-fourth year, and the funeral took place on Monday last at Kensal Green. Some time since Mr. Richards, being in failing health, undertook a journey to New Zealand, which seemed for a time to arrest the progress of the disease from which he suffered. A pamphlet descriptive of his journey was circulated privately soon after his return accompanied by his portrait, which many will value as a memento of their friend.

— WEATHER AT LIVERPOOL.—The weather here during the past few days has been unusually severe, and strong winds have been very prevalent, accompanied by sleet. Had the fine, mild weather which we had at the latter part of February and early part of the present month continued, we should now have had many varieties of Pears in full bloom. As it is the frost we have had lately serves to keep them in check, and hope that when the fruit trees are in bloom we may not have a return of severe weather, which will cause damage to what at the present time points to a most abundant fruit year. The night temperatures with us have been:—March 7th, 34°; 8th, 23°; 9th, 18°; 10th, 26°; 11th, 20°; 12th, 16°; 13th, 19°; 14th, 24°; 15th, 21°.—R. PINNINGTON.

— SOUTH SHIELDS CHRYSANTHEMUM AND WINTER FLOWER SHOW.—The reason the above Show was given up was the bad hall accommodation in Shields. We have now, through the local enterprise of Mr. Farquar M. Laing, a fine hall erected. It is called the Royal Assembly Hall, is supplied with electric light all through, and is 121 feet long by 61 feet wide, while in addition there is a grand saloon 40 feet by 20 feet. It is of very easy access, and will make a splendid exhibition hall. A meeting was held on Friday evening, when an influential Committee was appointed. J. T. Eltringham, Esq., J.P., was elected President, Messrs. Graham and Hope Treasurers, and Messrs. Bernard Cowan and H. Hinde Secretaries. There is a balance left of £17 from the previous Exhibition in 1884. The Committee soon purpose issuing their prize schedule, when over £100 will be offered in prizes. It is intended to continue the Show now annually, as such excellent accommodation has been provided.—B. C.

— CACTUS DAHLIAS.—The Committee of the National Dahlia Society have arranged a class for Dahlias of the true Cactus type in the schedule of prizes for the annual Exhibition at the Crystal Palace on September 4th and 5th. It is felt that so many of the so-called decorative Dahlias do not partake of the Cactus character, and, indeed, are little better than inferior forms of the ordinary show Dahlia. Hence the desire that more prominence should be given to flowers of the D. Juarezii type. The following varieties find a place in the report of the Society as partaking of the true Cactus form, and are alone admissible for competition in the class for Cactus varieties—viz., Amphion, Beauty of Brentwood, Cannell's Favourite, Henry Cannell, Honoria, Marchioness of Bute, Juarezii, Mrs. J. Douglas, Mrs. Hawkins, Panthea, Professor Baldwin, Robert Maher, and Sir Trevor Lawrence. Mr. T. W. Girdlestone, M.A., Hon. Secretary of the National Dahlia Society, offers special prizes for nine bunches of Cactus varieties, six blooms to form a bunch at the early Show of the National Chrysanthemum Society at the Royal Aquarium on September 9th and 10th, when, as at the Crystal Palace, the competition will be confined to the varieties above enumerated.

— By the recent death of MR. JAMES MURRAY GARDEN of Aberdeen, in his forty-seventh year, northern horticulture has lost a strong supporter. For several years he had been President of the Aberdeen Horticultural Society, and has helped greatly to strengthen its position, and to promote a love of gardening in the district.

— BOUQUETS.—MESSRS. WILLS & SEGAR of South Kensington have received the Royal warrant, dated 10th March, appointing them florists and bouquetists to Her Royal Highness the Princess of Wales. This firm has for many years held the Royal warrants as florists to Her Majesty the Queen and His Royal Highness the Prince of Wales.

— THE annual Meeting of the BEDDINGTON, CARSHALTON, AND WALLINGTON HORTICULTURAL SOCIETY was held on Monday night, March 16th, in the Public Hall, Carshalton, A. H. Smee, Esq., in the chair. It was announced that after a good season's work there was a balance in the hands of the Treasurer of £47 12s. 9d., an exceedingly satisfactory result. It was resolved to hold the annual show and fête on August 3rd, in Beddington Park, when the British Fruit Growers' Association will be invited to hold a conference.

— THE first of the series of shows at the ROYAL AQUARIUM, WESTMINSTER, was held on Wednesday and Thursday last week, when a very satisfactory display was provided. Cyclamens, Camellias, and Daffodils were well represented, miscellaneous groups, Azaleas, and bulbs also being included. Messrs. J. Laing & Son, Forest Hill; W. Paul & Son, Waltham Cross; H. Williams & Son; and Barr & Son, King Street, Covent Garden, were the chief exhibitors; the Cyclamens coming from Messrs. May, T. Walker, and the St. George's Nursery Company. The exhibits were effectively arranged by Mr. R. Dean, the Superintendent.

— "A YEAR IN A LANCASHIRE GARDEN."—Messrs. Macmillan and Co. are issuing a second edition of Mr. Henry A. Bright's work, the title of which expresses its character. It is a record of the writer's experience in his garden, of the enjoyment it gave him, of the thoughts it evoked, and of the poetry it called to mind. It is most agreeably written, and not without practical suggestions. It is a book for amateurs rather than professional gardeners, and especially, perhaps, for lady amateurs, and we can recommend it as an appropriate gift book to those of the gentler sex who love their gardens as the author evidently loved his, and about which he writes so pleasantly and well.

— I SEND herewith a spray of PEAR OLIVIER DE SERRES just to show you how our lovely songsters treat us since the storm of Monday night. We have a row of pyramid Pear trees by the side of our main walk in the kitchen garden, and they had a magnificent show for flowers till Tuesday last week, when the tree, of which I send a piece, was quite spoiled for the season by blackbirds and thrushes. It was all right at eleven o'clock on Tuesday; but at two, three hours later, not a whole bud could be found on it. I saw one or two blackbirds and thrushes about, but it did not strike me that they were doing so much harm. The other trees have not suffered so much as the one in question, only a few buds were picked out here and there. I should like to know why this particular tree was attacked more than the others, because it would be as well to protect it another season, as it is most annoying; and shooting the birds often does more harm than good by damaging the tree. I fear much injury must have been done to fruit trees by the birds in other districts as well as here. The bullfinch have been most troublesome during the last day or so to the Gooseberry bushes.—G. CARPENTER.

ROYAL HORTICULTURAL SOCIETY.

MR. WILKS' EXPLANATION.

EITHER you do not yet understand the point at issue, or you are intentionally throwing dust in your readers' eyes; I assume the former. In my last letter (I speak from memory, as you have never once had the courtesy to send me a copy of your Journal, and I have to go up to London if I wish to consult it) I said that very possibly in private conversation I had used the word "resignation," but that "since the beginning of this controversy" I had been very careful to use only the technical, though somewhat objectionable word, "incapable," and that you would not find "resign" in my written utterances. The controversy began in January of this year, and you think to confidently refute me by quoting a note written by the Assistant Secretary in October of last year, which note, as far as I am aware, I never saw before! Further, the note of October, 1890, refers *only* to the office of Treasurer, and not to the *seat on the Council*, which latter, as you are well aware, is the only point in question. There is not one word to forbid the Treasurer or any other officer "resigning" his office, or to qualify or direct

the method of his so doing. These matters apply only and solely to his seat on the Council, which is distinct from his office, and the one can be resigned without affecting the other. As a matter of fact, Mr. Morris never "resigned" his seat on the Council, but became "incapable" of holding it on account of his three-months absence from England (by-law 69), and the Council as plainly directed by Charter and by-laws (by-law 68) appointed Mr. Crowley to the vacant seat, and subsequently made him Treasurer, his office being in strict regularity confirmed at the annual meeting, his seat on the Council requiring no such confirmation, as he was "for all purposes deemed to occupy the position of the person to whose seat he was appointed" (by-law 68).

As I said once before, you will doubtless claim both the first word and the last—it is the editorial idea of fairness—but I must request your readers not to consider that my future silence to your ungenerous attacks upon one who is devoting all his spare time ungrudgingly to the service of the Society, and not altogether unsuccessfully—that my future silence is very far from admitting the truth or the justice of your future remarks.—W. WILKS.

P.S.—I have just been told by a friend who has seen your paper that you assert that at the annual meeting I said that Mr. Morris had "resigned." This is the exact opposite of the truth. I used no such word, as I had already been put on my guard, and, as one gentleman puts it, "Dr. Hogg made the whole room ring with the word 'incapable.'" This was the word I used, but had I made the mistake of using a wrong word it would not have altered the fact that Mr. Morris did not resign his seat on the Council. The by-laws require a certain form—Form E—to be filled up by any resigner, and this was not even thought of, much less complied with. You are at perfect liberty to say "Mr. Morris resigned his treasurer'ship." I know not whether he did or did not, and it makes no matter of difference; but I do know that he did not resign his seat on the Council, which makes all the difference in the world, and is *the* point in discussion.—W. W.

[The above letter simplifies matters; but, as is generally accepted, the stronger the case the less the necessity for irrelevant allusions. We should be sorry to suggest that Mr. Wilks has any other desire than to do the best he can for the Royal Horticultural Society, and we are glad to believe that there are many of its supporters similarly animated. In reference to the official letter, the authorship of which Mr. Wilks disclaims, it was in our opinion a very proper letter under the circumstances, and no one has the least reason to be ashamed of it.

But to the gist of the matter at issue. We are now told distinctly that "Mr. Morris did not resign his seat on the Council." Very well; then has he not been on it all along, just as we have contended? If Mr. Morris "never resigned" his seat, why was his name placed on the balloting list as one of the new members for election on the Council?

If Mr. Morris became incapable for holding the office of Treasurer and vacated it to Mr. Crowley, then by the Charter Mr. Crowley filled it "until the annual meeting next following such nomination or appointment." But there could be no legal confirmation of the appointment by the annual meeting before Mr. Crowley was first made a member of Council; yet Mr. Crowley's name has never appeared on any list of members of Council submitted to the Fellows for adoption.

As Mr. Morris did not resign his office of member of Council, the appointment of Mr. Crowley, according to Mr. Wilks' (erroneous) view of the case, made the number of members of Council *sixteen*, instead of fifteen, the legal number.

This brings us to the point from which we started, confirming our statement that the balloting papers were informal, and consequently the action founded thereon was invalid.

The Charter says distinctly, and the point is a fundamental one, that three members shall retire annually, and three "other" Fellows be elected. If Mr. Morris is other than himself the conditions might be said to have been complied with, but if he is only one individuality they cannot, because only two new members were appointed in the place of the three removed.

Mr. Crowley's name ought to have been in the Council list instead of that of Mr. Morris, which had no business there because he had not resigned; and it is imperative that the Treasurer be chosen from the Council for the purpose of his being established in the position he is proposed to fill, by the Fellows at the annual meeting.

The Council have certain powers, including the filling of vacancies that may occur in their body until the next annual meeting and no longer—a fact which Mr. Wilks ignores—but they have no power to override the rights of the Fellows as set forth in the Charter. Mr. Wilks is a laborious Secretary, but has not had time to thoroughly digest the rules under which the affairs of the Society must be conducted.

We are sorry Mr. Wilks should be so ready to prefer a charge of discourtesy against us because we did not send copies of the *Journal of Horticulture* to Shirley as well as to the Society's offices, which he attends so unremittingly, and hasten to forward the whole of the copies to him in which his communications appear.

Our remarks in reference to what transpired at the meeting, we may say (though the matter is of small moment), were citations from the published report.

We have one other observation to make. It would almost seem as if Mr. Wilks must feel as if he were "attacking" someone "ungenerously" when conducting a controversy, or it is difficult to perceive how he could attribute such a motive to others. His allegation is absolutely without the slightest vestige of foundation, and not a few of our mutual friends regret the tone of some of his remarks.

If Mr. Wilks can prove us wrong we will suggest a way in which he may do so, and when he has done this we will admit the strength of his case. If he fail to do what ought to be so easy (as it is documentary) we shall then know, and our readers will know, that we had full justification for our public criticism of an essentially public subject; and if what we ask for is forthcoming we shall have the satisfaction of feeling if we lose our case that we have not spoiled it by indulging in personal reflections, for the simple reason that they have never occurred to us throughout the discussion.

Here is the "test," which is in the form of a brief recapitulation:—

Will Mr. Wilks be kind enough to point out where Mr. Crowley's name has ever appeared in the form provided for that purpose and submitted to the Fellows for election as a member of Council? It appears in the balloting paper as being recommended for the office of Treasurer, but to qualify anyone for acting as Treasurer he must first be a member of Council, for the Charter enjoins that the Fellows shall elect "from among the members of Council for the year next ensuing the President, Treasurer, and Secretary of the Society." As we have already stated, Mr. Crowley's temporary appointment on the Council has never been confirmed by the annual meeting because it has never been put in the proper form for the requisite confirmation.]

THINNING FRUIT BUDS.

"B.'s" remarks on "Removing Flower Buds of Peaches" (page 181) are indeed "a caution." In the first place "the principle on which they are based is sound." Secondly, "There is some danger of mischief following a too rigid adherence to rule in carrying out this practice." Thinning the flower buds results in "the production of large blooms." What does that imply? Does it mean larger petals, stouter stamens bearing plumper anthers, with a bolder, longer style?

Your correspondent appeals to "growers with an intelligent grasp of the subject," stating that thinning flower buds is a result of negligent culture. Thinning the wood certainly favours the "production of normally healthy and perfect flowers," and this more than anything else occasions the need of removing flower buds, for the simple reason that the growths are more thickly studded with bloom buds than those that have been crowded. Yet "B." would have all left; at least, no mention is made of thinning, and the result would be that perhaps more fruits would set in the wrong place than in the right, whereas by removing all the flower buds on the under side or back of the trellis the fruit would be had set on the upper, or where it was best situated for receiving light.

Then it is stated that the "proper time to relieve the tree after the buds have been formed would be at the earliest stage possible." Some, in fact few, growers have escaped the mortification occasioned by seeing half of the best buds falling when they should be swelling. Yet "B." would have us thin the bloom buds of Peaches in the earliest possible stage—that is, as soon as the trees are leafless. This shows the importance of practice, for the thinned tree mentioned in the second paragraph in having plumper buds are more likely to cast them than the tree that has been crowded with growth. This, however, is a phase of the subject not taken into consideration by "B." therefore we pass on to removing the flower buds "when they are well forward." Yes, that is the time, and no other, for none else is safe. In this respect Peaches and Nectarines differ from other fruit trees—viz., the danger of flower buds of trees under glass being cast in the resting season practically precludes removing a superfluity until they commence developing. All the same, "B." is short of the mark in saying "the mere opening of the buds into flower and the production of pollen is not a matter of much importance." In practice it is vital. Give the trees too much heat when swelling and developing the buds and they will rush into growth, the flowers being shed. Why? Fumigate whilst in blossom, and the set is nil. Let them be too vigorous in growth and they neither set or stone the fruit. Why? The petals have to do something more than attract insects; the production of pollen is an all-important agent in fertilisation, and no "fertilisation of the ovule" can be effected without it. True, great benefit may not result from thinning flower buds before they expand, but it often marks the difference between having all the "eggs" in the right basket and having them in the wrong, or in none. Only the fruit, we are told, places a strain on the powers of the tree, but how does it happen that so many fruit trees produce plentiful flowers but few fruits? Where in that case has been the strain? No greater service can be rendered to trees overburdened with flowers than the removal of three-fourths, and in many cases nine-tenths of all the fruit buds, then there may be a chance of thinning the embryo fruits. The cultivator must make his selection of the finest buds or blossoms, and reserve the most perfect embryo fruits, removing all others. If that be done with care and judgment it insures an even crop of the highest quality fruits.

In the fourth paragraph the subject is made one of bud formation more than blossom removing. Crowded trees set thin crops of fruit, "not because there are no flowers," but because they are "abortive, or deficient in energy." That being so, what is so suicidal as thinning the growths during the next season? Clearly parts are cut away that might have set fruits; but that is not the point. Thinning the bloom buds "B." admits might be of some benefit here, but it is impossible to discriminate before the buds open. That is, no doubt, meant to settle the bud-removing principle altogether, for there is danger of removing "perfectly equipped floral organs" as well as defective flower buds. There is no occasion to trouble in the case of trees overburdened with growth, for they often have not a fourth of the flower buds trees have grown under conditions essential to the production of

s out, short-jointed, thoroughly solidified wood, and forming of double or triple buds at every joint. Thinning in such cases is useless. Taking out the wood is bad policy, because it sets more sap at liberty, and this, instead of favouring, prevents the meagre blossom setting. "B." says the flowers do not set because they are abortive or defective. That I question, for if root-pruning be practised to an extent corresponding to the growths cut away in the rest season the flowers set freely, the fruit stoning and perfecting. The question is not one of bud, but of wood formation. That influences the setting and the stoning of the fruit far more than any bud transformation, and the flowers in "B.'s" example do not set because the strength is concentrated on growth. Cutting away the growths during the rest season stimulates the roots; strong growth is pushed, and the fruit is cast. By lifting or root-pruning the buds and flowers are invigorated, because the stored sap is directed to the fruit buds to sustain the losses of evaporation, and give stability to the wood. "B.'s" panacea, cutting out useless growths after the fruit is gathered, may or may not have the desired effect. It certainly must effect a higher bud development, a greater store of assim-

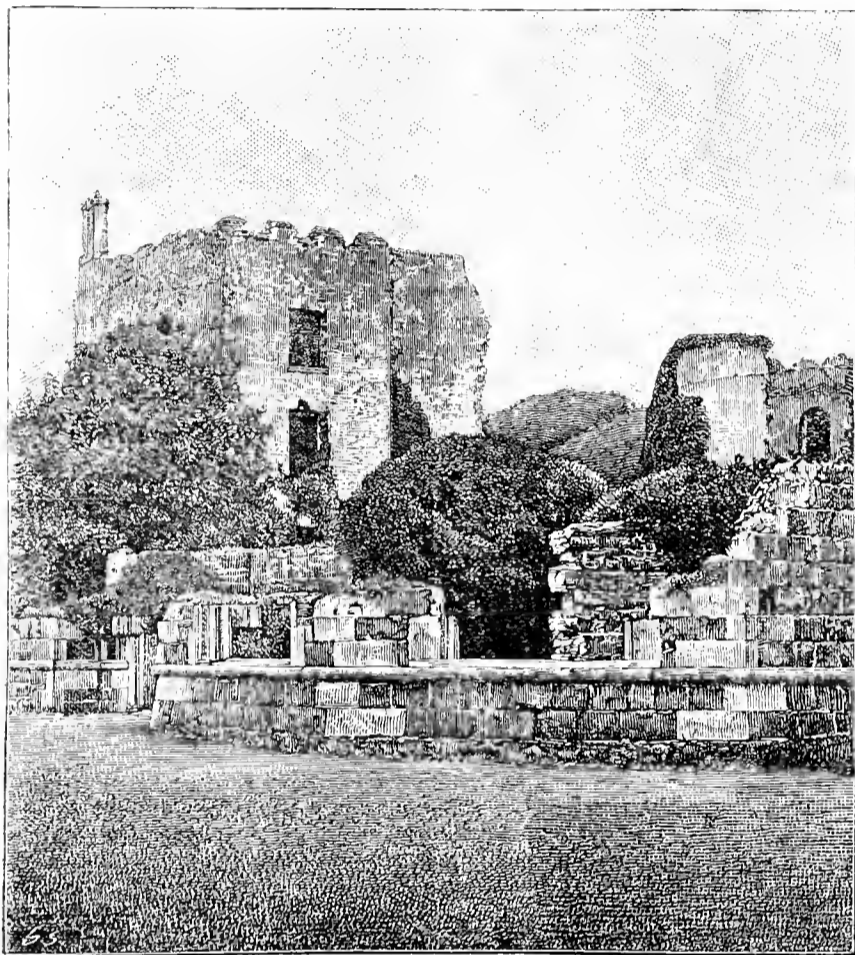

FIG. 39.—THE OLD SHANES CASTLE RUINS.

lated matter; but it may not affect the setting and satisfactory stoning of the next year's crop.

Then your correspondent assumes there cannot be any taxing of the energies of the tree in producing flowers when a good method of cultivation has been followed. This ignores the principle which he states at the commencement of his "caution" to be sound. The large flower is not as effective as the small one. It makes no difference whether the fruit be in the wrong place or the right. Twice or treble the blossoms more than are wanted make no difference in the set, the stoning is not affected, the fruit has no advantage. It is a dangerous practice to adopt in the case of carelessly managed trees, and with those on a good method a hazardous scheme. Yet "B." has given the "practice a trial," and found "no difference." That settles the matter, for the practice being bad or useless, there can be nothing of value in the principle. He has not seen "anything extraordinary at shows." What does he expect? All the energy of the removed blossoms transformed into size in the fruits left for the crop! Evidently he sees no difference between a good set and no crop, between fruit in the best place for receiving light and that shaded; non-setting is due to imperfect bud formation, and the principle as well as the practice is altogether wrong. Must we believe that disbudding Vines is a farce, removing duplicate bunches of Grapes before they flower a delusion? Is it folly to thin bud crowded blossom buds of Pear? Do Apple trees set most fruit when smothered with blossom? Are Cherries and Plums invariably weighed down with clusters of fruit as the result of profuse flowering? Will Melons set best when there is a superfluity of staminate over the pistillate flower, or Cucumbers have the cleanest and straightest fruits when staminate flowers predominate? Are Figs cast because of thinning before flowering? Do Strawberries swell their early fruits best in consequence of leaving a number to expand that never come to anything? Indeed, thinning flower buds, according to "B.," is worse than useless, inasmuch as it makes no difference in the fruit that he can discern.—G. ABBEY.

A GARDENING TOUR IN IRELAND.

PROMINENT in the programme of my tour last autumn was a visit to Shanes Castle, concerning which I had heard much of a favourable character, and so the second day of my sojourn in the Green Isle found me on the road to that historic establishment. Antrim is the nearest convenient station on the line from Belfast to the north, and is said to be two and a half miles from Shanes, but they were the longest miles I have ever travelled, and after struggling manfully with the task for over an hour, my friend and I were constrained to confess grave doubts respecting the accuracy of the information received on high authority. At the station we had failed to convince a car driver that it would be greatly to his interest to convey us to our destination, though the terms we offered were those a cabman in England would have gladly accepted for the distance named, and having exhausted our eloquence on the subject with no result, we came to the conclusion that either Irish carmen must be in a very flourishing financial condition or our geography was at fault. Subsequent experience taught us that both opinions were not without foundation. However, the day was fine, and the road a pleasant one, so that the time was by no means lost. Passing through the spacious main street of Antrim, which is wide enough for a continental boulevard, the first point of special interest faces this thoroughfare, and constitutes the entrance to Antrim Castle, the residence of Viscount Masserene, picturesquely situated near Lough Neagh, and surrounded by extensive well wooded grounds. Beyond that the road assumes a quiet rural character, and the park gates of the Shanes Castle estate are at last reached, and we thought our journey was ended. This was another slight illusion, for it seemed nearly as far from the gates to gardens as the former were from the station. The carriage drive from the first gate is in fact of considerable length, and bordered as it is on one side by fine plantations of handsome Conifers and deciduous trees, and on the other by shrubberies, affording at intervals peeps of the widely extending Lough, it constitutes a picturesque and noble road, a fitting approach to such an estate.

SHANES CASTLE.

A glimpse by the way of the old castle ruins (fig. 39) reminds us that historically Shanes Castle is full of interest, and to deal with it in detail would be to practically relate the history of the North of Ireland during some centuries. The name of O'Neill is a very ancient one in the annals of Ireland, dating from remote ages. Members of the family were at one time kings of Ireland and afterwards of Ulster, and in much later times they held leading positions in that part of the country. In the fourteenth century the head of the Ulster family died leaving two sons, from the elder of whom the Tyrone branch descended, and from the younger, that now represented by the present Lord O'Neill. No certain evidence exists as to when the family first occupied the Shanes estate, but it is said that a record exists in a certain old document (the Annals of the Four Masters) which chronicles the fact that one Con O'Neill died there at the end of the fifteenth century. We have thus something like four centuries to look back over, during which Shanes Castle has been occupied by one great family, and to wander amidst the ponderous ruins of the old castle cannot but occasion reflection in the most unromantic minds as to the scenes there enacted. The old building must have been a very extensive and substantial structure, and it was an almost national loss when it was destroyed by fire in 1816, in consequence it is thought of jackdaws' nests in the chimneys having become ignited. The ruins themselves are, however, a most picturesque feature in the grounds; and a fine terrace facing Lough Neagh is preserved, together with a battery of twenty-one guns, a spacious conservatory there being occupied with old Camellias and other large plants. The present castle is about a quarter of a mile from the old one, a handsome structure, well situated on slightly raised ground, and commanding views of the park and lake.

THE PARK AND ROCKERY.

The park itself is finely diversified, and covers 2300 acres within the walls, bounded on one side by the road from Antrim to Randalstown, and on the other by the Lough and Antrim Bay. A charming feature of the park is afforded by the drives which pass through open glades and densely wooded portions, along shady dells of luxuriant vegetation, and over artistic bridges, constituting a succession of scenery of a most pleasing character. This is heightened by the river Main which runs into the Lough from Randalstown right across the estate, and furnishing a fitting abode for hundreds of aquatic plants that flourish there amazingly. Then nearer the Castle we find another feature of much interest in the rock garden, not one of the conventional kind, but a piece of thoroughly natural beauty. It was an old and disused quarry, a waste portion of the

garden, and its development into so great an attraction is due to the Dowager Lady O'Neill, who designed and laid it out in its present form. It occupies a sheltered position near the Lough, but is protected on the land side by a high irregular rocky cutting which forms a capital situation for many climbing plants. Then there are massive rocky projections, bold mounds, old tree stems, with nooks and recesses for the more delicate treasures, and in every way it is evident the endeavour has been to render the rock garden natural, beautiful, and interesting. *Tropæolum speciosum* was luxuriating in the cool moisture and wreathing rocks, stems, and arches, with its brilliant flowers. Clematises were similarly plentiful, and the *Wistaria* is also found useful for covering large spaces. The arches upon which these climbers are allowed to extend with unrestricted freedom are exceedingly picturesque, and the paths which pass beneath them are well managed, winding here and there, dipping down and rising again, so that nothing approaching dull formality is seen. Masses of Ferns, especially of *Osmundas*,

74 feet in circumference of the branches. A fine *Araucaria imbricata*, about the same height and 80 feet in circumference, is also a prominent object, Irish Yews, various small Conifers, and bold shrubberies, with flower beds and garden, forming the features of this part of the establishment. So far we have only dealt with the ornamental side of Shanes Castle, but there is a practical and useful aspect, to which a few words must now be devoted. The kitchen garden comprises 6 acres of land, surrounded by high substantial walls, with one across the centre, and thus affording a wonderful extent of wall surface. Beyond this there is a paddock garden of 2 acres planted with fruit trees, and also walled in, so that altogether the total length of wall is surpassed by few gardens in the United Kingdom. Full advantage has been taken of this, both in the past and the present, with the result that very little space is unoccupied with fruit trees, and the greater portion is covered with trees in fine bearing condition. Pears, Plums, Cherries, Apricots, and Figs are included, the first in many varieties;

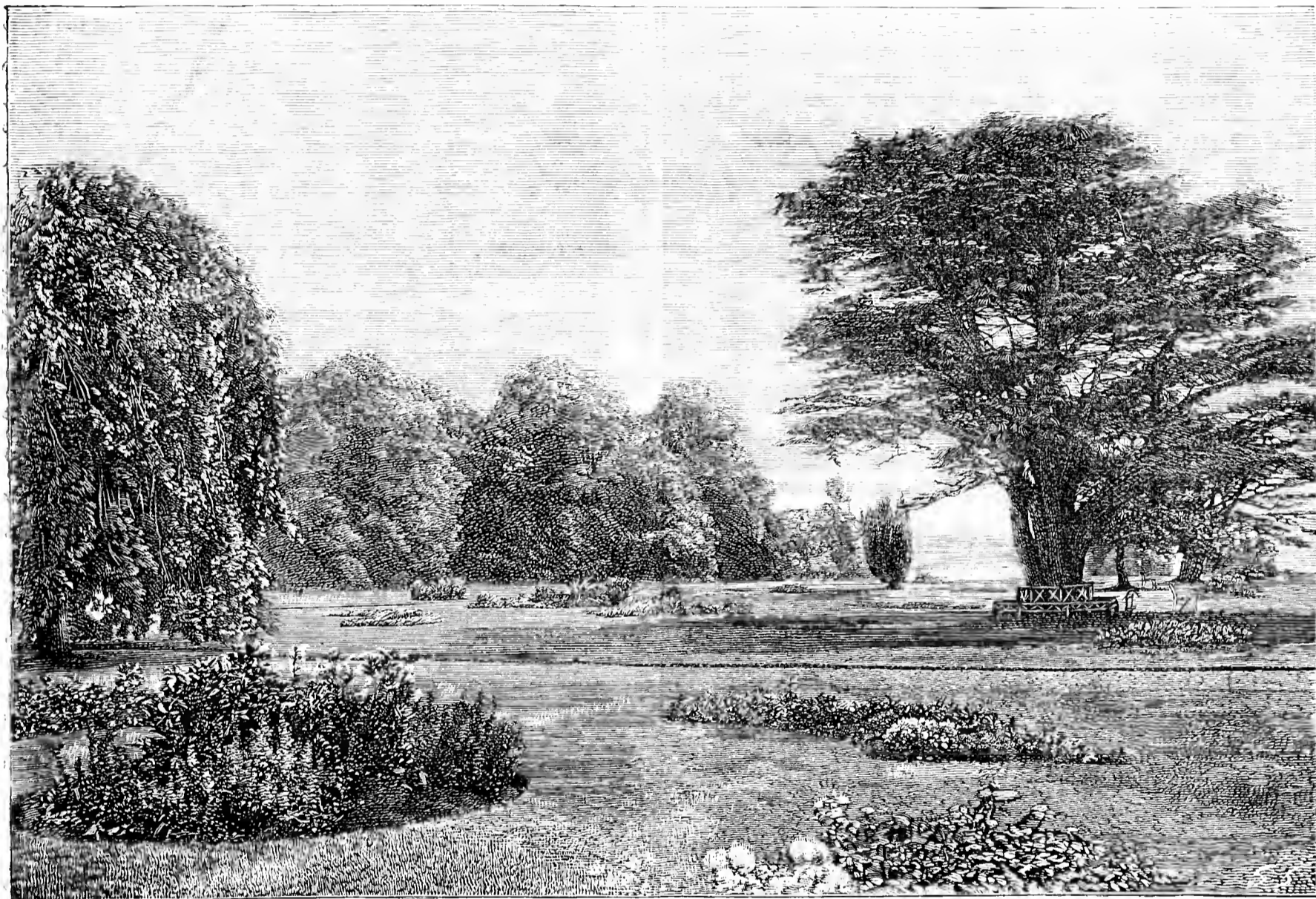

FIG. 40.—SHANES CASTLE GARDENS.

were very noticeable; *Gaultheria Shallon*, in its vigour, reminded me of that at Cragside, Northumberland; the brightly berried *Pernettyas*, *Rhododendrons*, *Cotoneasters*, *Ivies*, *Anemone japonica*, with water plants, and *Willows*, constitute what may be termed the foundation, hosts of other choice plants being employed in every convenient position. Seen in all the freshness of a bright summer morning there was much to admire in this garden, which is certainly worthy of the reputation it has gained.

THE GARDENS.

The flower and kitchen gardens now demand attention, for both in extent and keeping they present much that merits notice. Of the flower garden and lawn in the immediate neighbourhood of the Castle there are twelve acres all kept in short grass, neat and prim as required. From one point there, with a distant view of the Lough, the photograph was taken, which is reproduced in the woodcut (fig. 40), and gives an idea of the character of this part of the garden. Handsome old *Cedars* are noticeable, with well proportioned *Wellingtonias*, two of which are 36 feet high each, and

and of *Plums*, also, the collection is a good one, and numbers of the trees are of great age, quite sixty or seventy years. This is a peculiarly interesting point, for some of the best trees in the garden at the present time have been bearing for at least half a century, and a moderate estimate of the returns from these during that time would be surprising. They afford good proof that they have been well treated both at root and branch, and it is seldom that so many large old trees are found in one garden as profitable as those at Shanes Castle. It is unnecessary to enumerate the varieties grown, for they comprise the best of those with which we are most familiar here, and where any renewals are needed care is taken to plant trees of varieties that have succeeded best, for very careful observations have been made respecting the behaviour of all those grown. As one example, it has been found that Shipley's *Apricot* is more reliable and useful than *Moorpark*, giving more regular crops and finer fruits. With regard to many of the *Pears* and *Plums*, similar differences have been noted and taken advantage of.

Small fruits are well grown both in open quarters and against

walls, Red and Black Currants, Gooseberries, and Raspberries being planted in blocks where they can be readily netted and protected from birds, and the Currants trained to walls are mostly allotted north aspects for late supply. The collection of Apples included several local varieties of good appearance and quality, one bright early Apple known in the district as "Kells" being remarkably prolific, and a fine market variety which I have failed to identify with anything known in England. Then there are the glass houses, vineries, Peach, Melon, Tomato, and plant houses well stocked, and their occupants showing they receive the best attention. Of vegetables a long succession is maintained, and throughout every department the untiring energy and well proved skill of the gardener, Mr. Charles Warwick, are manifest, his successes evidently being often achieved in the face of numerous difficulties, and therefore the more creditable. His kind attention rendered my visit most agreeable, and I hope at some time to return his courtesy on this side of the Irish Channel.

LOUGH NEAGH.

Before quitting Shanes Castle I should like to say a word or two about the great Lough Neagh, which has been repeatedly mentioned in my notes, and is really of considerable interest. It is the largest lake in the United Kingdom, being twenty miles long by fifteen broad, and has a superficial area of nearly 100,000 acres. It is very shallow, the average depth not exceeding 50 feet, and the bottom is 3 or 4 feet above sea level. From the old castle terrace a capital view is obtained of this inland sea-like expanse, the extreme limit of which in Armagh is invisible from the shore level. Usually it has a very placid surface, but in stormy weather it assumes a very different appearance, and floods the low-lying ground by which it is surrounded. Legends abound in regard to this Lough, but that generally accepted by the country people is to the effect that a well once existed there, which was required to be always kept covered, and a woman having once hurried away to attend to her child omitted to comply with this condition, and then, as Caxton says, "Ye well sprynged so fastly yd drowned ye woman and her childe, and made all ye contre a lake and fyssh pond. For to prove this it is a grete argument that when the weder is clear fysshers of yd water see in ye grounde under ye water round towers and hyghe shapen steeples and churches of yd land." Thus Moore also says,

"On Lough Neagh's banks as the fisherman strays,
When the clear soft eve's declining,
He sees the round towers of other days
In the wave beneath him shining."

One product of Lough Neagh, however, I tested with some satisfaction—namely, the pollen or pollan, which is perhaps admissible here on account of its botanical name, though it is really a fish of the genus *Coregonus*, about the size of a herring, but possessing a pleasing combination of the flavour of whitebait and sprats if well cooked. This fish is plentiful, and at one time provided an important occupation for the villagers in the neighbourhood. It is also interesting as being a near relative of the white fish of North American lakes and bays, which constituted the only food of the members in one of the Arctic relieving expeditions for several weeks. My experience of the pollan was not, however, so prolonged as that, and was gained under much more pleasant circumstances.—LEWIS CASTLE.

GREEN FLY ON PEACH TREES.

It is a well known fact that Peach trees under glass are not much troubled with green fly after the early stages of growth have been passed, but in many cases this destructive pest appears just after the fruit is set, causing the young leaves to curl and the shoots to receive a severe check unless the insects are destroyed at once, an effectual method of doing so being to fumigate with tobacco paper or syringe the trees with tobacco water; but as prevention is better than cure I wish to point out how, according to my experience, green fly may be kept at bay. Assuming that the roots of the trees are in a healthy state, and the borders in good condition in regard to moisture, I believe in the case of Peach trees under glass, to which these remarks principally apply, the attacks of these insects are brought about in the first place by keeping the atmosphere of the house too hot and dry during the flowering period—not enough so perhaps to prevent the fruits setting in a satisfactory manner, but still too hot and dry for the benefit of the trees, which require more airy and less arid conditions.

The most effectual method of treatment is to ventilate more freely than is often done, and to set the flowers with a syringe, lightly dewing the trees during the middle of bright days. If there is one method of setting Peaches more sure in its action than

another I would award the honour to setting with a syringe; still I am aware that there are gardeners who do not believe in its efficacy, or are too timid to try it. To such I would suggest drawing a rabbit's tail over the flowers in the usual way when the pollen is ripe, and then, instead of waiting till the petals of the flowers have fallen before commencing to syringe, to do so lightly once a day as soon as the pollen has disappeared from the stamens, and leave a little ventilation on the house for a few hours after. With this treatment, other cultural details being well carried out, we should see and hear less of green fly on Peach trees.—H. DUNKIN.

ROYAL HORTICULTURAL SOCIETY.

MARCH 10TH.

SCIENTIFIC COMMITTEE.—Present: Mr. D. Morris, in the chair; Dr. Masters, Mr. McLachlan, Professor Church, Dr. Müller, Dr. Scott, Dr. Oliver, Rev. W. Wilks, and Mr. Blandford.

Branches Injured by Cold.—Dr. Masters showed branches of Peach and Rose trees with injuries similar to those shown at the last meeting. These had not been in contact with wire, showing that that is not the only cause of the injuries. Professor Church suggested that the appearance pointed to the rubbing of branches on each other.

Fog Investigation.—Mr. Morris stated that he, as the recipient named in the Royal Society's grant, had sent in a short report, and had made formal application for a further grant of £50. This course was agreed to. Dr. Oliver announced that the Interim report promised would be produced at the next meeting of the Committee.

Growths on Yucca flaccida.—Dr. Scott said that he had received very good material from Mr. Burbidge of Dublin, and promised an investigation into them.

Mildew on Vines.—The Council referred to the Scientific Committee a letter from Mr. Tait of Oporto, in which he states that he has discovered a remedy for mildew on Vines, which has been successfully used in Portugal, and which he is anxious to have tried at Chiswick. They wished to know if the Scientific Committee were prepared to appoint someone to conduct an investigation.

The Committee were of opinion that the main constituents of the remedy should be known first, so that no investigation should take place unless they were new and not previously tried. Dr. Masters said that that particular form of mildew did not occur at Chiswick, but it could be tried on Tomatoes. Professor Church pointed out that the composition being patented there would be no difficulty in ascertaining its constituents, and the Committee then resolved to communicate with Mr. Tait about the composition, on the understanding that if new it would be experimented with.

Death of Wellingtonia.—A letter was read from the Duke of Wellington, asking for information as to the cause of death of a Wellingtonia, roots of which were forwarded. There was no obvious cause of death in these, and it was resolved to write for further information as to the history of the tree, character of soil, &c.

Rhododendron Falconeri.—A plant was shown from Mr. James Bateman of Worthing, described in a letter as "a dismal specimen of *Rhododendron Falconeri*, which with many other things perished miserably in the late winter. The first to attract attention was a fine specimen of the wild Olive tree, which had been raised from a cutting taken from the one that marks the site of the ghastly well of Cawnpore. It was nearly 20 feet high, and had flowered last summer for the first time; moreover, it retained its freshness after the winter was more than half over, when my gardener accidentally discovered that it had lost all its bark on the lower part of the stem, and was in fact a corpse. The next to succumb was a New Zealand *Olearia Hastii*, which perished in exactly the same manner. It was then the turn of a large *Fuchsia*, of which the bark under precisely similar conditions was stripped off the stem. After the *Fuchsia* a brigade of Sikkim and Bhotan *Rhododendrons* was destroyed. And now as to the cause. Before winter set in we had a delicious Indian summer in portions of October and November, and to such an extent that our thrushes and blackbirds took to singing, and, I believe, to nesting. The exceptional warmth no doubt set the sap rising, and in this state it was caught, as in a trap, by the sudden change of temperature." Dr. Müller said he had seen the same thing in plantations of *Rhododendrons* near Bagshot. Mr. Wilks said the outer bark of *R. Falconeri* scaled off normally as in a Plane tree. From examination he doubted if the plant were quite dead. He himself had had a very large plant of *Erica mediterranea* which was throwing its spikelets; on examination the stems were found split open longitudinally, and appeared as if full of cotton wool. This was due to frost. Dr. Masters, after examining the leaves of the plant sent, concluded that the plant would not have lived if left in the ground. The Committee decided that its condition was probably due to the action of frost.

Egyptian Mealy Bug.—Mr. McLachlan showed twigs covered with this insect, and in addition to statements made on previous occasions (December 10th, 1889, &c.), said that Mr. Douglas first described it as *Crossotoma aegyptiacum*, but had since concluded that it was probably no other than a true *Icerya*. The Egyptian Government are taking steps to introduce the Australian and New Zealand ladybirds, which had been so successful in America. As the Egyptian species is not the same as the Australian and American pest, and as the climate is so different, the success of the experiment is doubtful.

Peach Yellows.—Dr. Masters produced twigs and leaves of Peach trees from the Cape of Good Hope suffering from this disease. It was common in America, and was supposed to be bacterial. This had not been determined, and the specimens were referred to Professor Marshall Ward.

Diseased Root of Dracæna.—A root of *Dracæna*, probably swarming with *Tylenchus*, was referred for examination to Dr. Masters.

Snowdrop Mildew.—The Rev. C. Wolley Dod sent decayed bulbs of Snowdrop. He wrote:—"These are Snowdrop bulbs of which the leaves last year showed slight symptoms of the Snowdrop mildew. Often there is no trace left of the bulb in the following spring. I lost all my best Snowdrops from it, and have as yet found no remedy. These were dressed with solution of sulphate of copper last year when in leaf." Dr. Masters said he had successfully prevented the disease by treating the bulbs themselves with sulphate of copper before planting.

Effect of Fog.—Dr. Masters showed panes of glass from glass houses at Gunnersbury and Feltham with a dense black deposit due to fog. Mr. Morris stated that 18 square yards of glass at Kew produced, when scraped, 41 grammes of solid matter. This could not be removed by mere drenching with water, and the whole of the glass in the Royal Gardens would require scrubbing to cleanse it. Dr. Oliver said that an analysis of the deposit showed that 20 per cent. consisted of tarry and oily matters. Dr. Masters also showed Rose leaves which had fallen off under glass in consequence of the fog. No details had been sent.

Abnormal Mushroom.—A Mushroom with a very large gouty stem was shown. There was no history to it. The stem was much split longitudinally.

Magnolia conspicua.—Dr. Masters showed a photograph taken last year of an unusually fine plant in bloom at Gunnersbury House.

ROYAL BOTANIC SOCIETY.

MARCH 18TH.

THE first Spring Show of the season was held in the corridor and conservatory as usual, and a bright diversified display was secured. Competition was confined to few exhibitors, but the miscellaneous contributions amply compensated for that deficiency.

Premier prizes for Hyacinths and Tulips in the nurserymen's classes were accorded to Messrs. H. Williams & Son for good specimens. In the open classes Mr. Douglas, Great Gearies Gardens, Ilford, was successful with Hyacinths, Tulips and Narcissi, all of good quality. Other prizetakers were Messrs. Eason, Scott and Morle. With Crocuses, Messrs. Scott, Douglas, and Morle were the prizetakers in that order.

Azaleas were shown by Messrs. Eason, Scott, and Nunn, but were not of remarkable merit, though they furnished some bright colours. Deutzias came from Messrs. Douglas, Eason and Nunn in the usual style. Messrs. Paul & Son, Cheshunt, were first with a choice collection of hardy herbaceous plants, Hepaticas and Megaseas predominating.

Messrs. Paul & Son, Cheshunt, were awarded premier honours for six Roses in pots. They also had a large group of well-flowered Roses. The same firm was first for Amaryllises, Mr. Douglas being second.

Messrs. B. S. Williams & Son, Upper Holloway, contributed an extensive collection of Hyacinths, Tulips, Lilies of the Valley, Daffodi's, Lilacs, and Clivias. This group occupied nearly half the length of the corridor, and formed a very handsome exhibit. Messrs. Wm. Paul & Son, Waltham Cross, also had a dozen boxes of Camellia blooms, such as we have repeatedly noticed this season.

Messrs. Cutbush & Son, Highgate, had a beautiful bright collection of Epacris, Heaths, and a fine Mignonette named Snowdrift. Messrs. H. Williams & Sons, Finchley, staged large groups of Azaleas, Tulips, and Hyacinths in many varieties. Messrs. Laing & Son, Forest Hill, had a miscellaneous and tasteful group of fine-foliage plants, Orchids, Clivias, and other plants. Messrs. J. James & Son, Farnham Royal, Slough, showed some capital Cinerarias in good varieties. Mr. G. Phippen, Reading, had a large exhibit of Hyacinths, Tulips, Lilies of the Valley, Scillas, and other bulbs. Messrs. J. Odell, Hillingden, and the St. George's Nursery Company, had collections of Cyclamens; and Messrs. H. Low & Co., Enfield, had a charming group of Orchids, comprising Dendrobiums, Phalaenopses, Cypripediums, Angraecums, and Ferns. Mr. T. S. Ware, Tottenham, exhibited a collection of Daffodil flowers in glasses, and he was also first with twelve pots of bulbous plants.

Messrs. B. S. Williams & Son had a group of Orchids and new plants. G. F. Wilson, Esq., Heatherbank, Weybridge, sent a plant of the richly coloured Primrose named Oakwood Blue, lifted from the rockwork March 16th, 1891, the first flower having expanded on February 12th.

Messrs. G. Bunyard & Co., Maidstone, contributed over sixty dishes of well-preserved Apples, the specimens fine, fresh, and bright; and Mr. B. Philip, gardener to F. A. Beavan, Esq., Ludgrove, New Barnet, sent a beautiful collection of Orchid flowers.

MICE AND APHIDES.—Looking into a conservatory last week well filled with flowers of the season, including numerous Cinerarias, my attention was attracted by one head of blossom shaking slightly, and on seeking the cause, a tiny mouse was discovered running up the stem. Its tail was long, and it had a small pointed snout, which it was using diligently as it went over the surface of the stem and the under side of the leaves joining it. Could this be the common shrew mouse; and is it known by naturalists as a creature that would be likely to feed upon aphides, which so commonly infest Cinerarias?—E. P., *Woburn Sands*.

A GARDEN WEBBER.

A USEFUL little instrument, which is calculated to save much time and perform its work in a more efficient manner than can be done by hand, is that shown by the Stott Company at the Crystal Palace as "A Webber," and of which we are enabled to give an illustration in fig. 41. The base of the instrument is hollow, and contains a kind of moveable shuttle, upon which is wound the thread or cotton to be used. The thread is passed up a long tube, and emerges from the part as represented in the woodcut. For rapidly covering fruit bushes with a fine web or network of threads as a means of protection from birds this

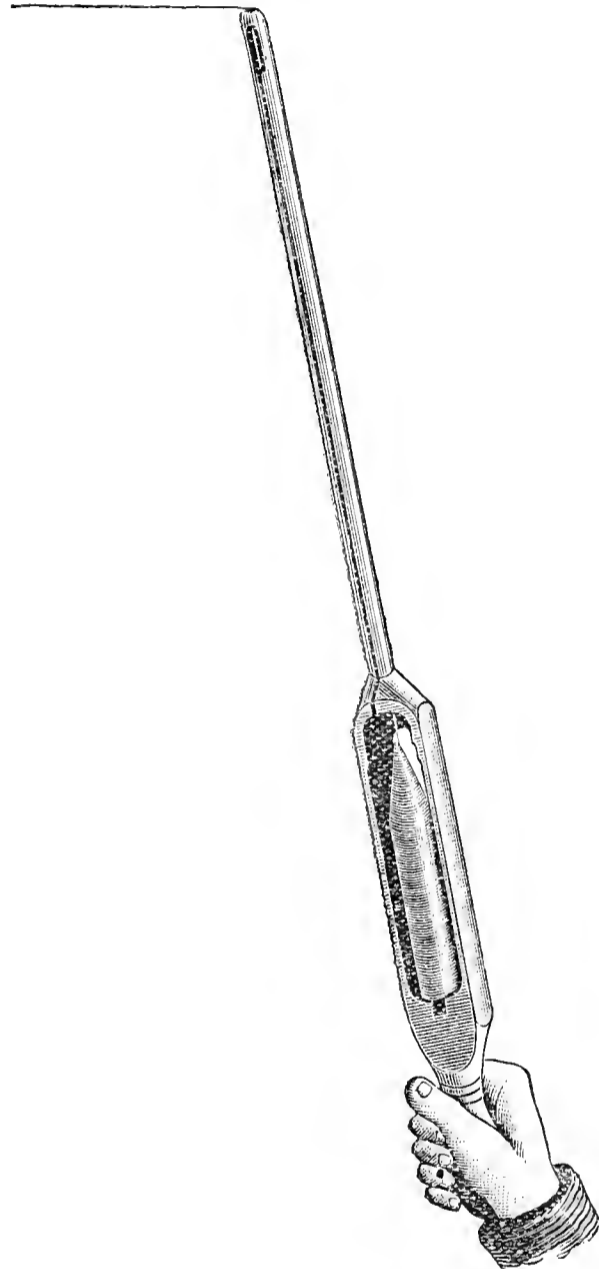

FIG. 41.—A GARDEN WEBBER.

Webber is well constructed, as it is light, easily passed backwards and forwards over a bush, and the thread runs out continuously until the shuttle is exhausted.



HARDY FRUIT GARDEN.

PEACHES AND NECTARINES.—*Nailing*.—This had to be left much later than usual this season owing to the severe winter, but none of our trees are injured by the frost as the fine bright autumn ripened the wood thoroughly. The trees were also roughly examined in November, fastening all the wood as close to the wall as possible, which has assisted them in withstanding the frost. Nailing has still an advantage over wires in this way for Peaches in cold districts, as it is impossible to have the shoots so close to the wall when they are tied to wires, and those who are intending to substitute wires for nails and shreds should not be too hasty in coming to a decision. Last spring a severe frost when our blossoms were fully expanded all except those close to the wall. Luckily the trees were full of bloom, and enough escaped to give a heavy crop, but had the trees been trained to wires we should have lost all.

Protecting the Flowers.—These will now be developing fast, and must be made secure from frost as soon as they commence opening, or the whole crop may be lost in one night. A glass coping at the top of the wall about 18 inches wide, and fixed on iron brackets at an angle of 45° or thereabouts, is the best form of protection if provision is also made for fixing canvas or frigi-domo in front of the trees while they are in flower. This material must be drawn up on warm days and let down at night by means of rings working on iron rods, and should hang almost perpendicularly from the front of the coping. If glass cannot be had deal boards may be fastened in the same form as above, and if taken down early will answer well, but in cold springs they sometimes have to remain too long after growth commences, and the upper part of the trees is much weakened in consequence. For this reason, and because of its better appearance, we much prefer glass, but some of our readers may not be able to obtain either boards or glass, and many gardeners who grow good crops of Peaches merely hang old Strawberry nets at a double thickness on the wall in front of the trees. These have one advantage over canvas, in not requiring to be removed in the daytime, and are within the reach of most people who grow Peaches. Branches of Spruce Fir may be stuck behind the thick branches so as to protect the flowers if nothing else can be obtained.

Ants.—A sharp look-out should be kept for these insects while the trees are in flower, as they sometimes do much damage by eating the pistil in order to get at the nectar inside the flower. A few of them will spoil a large quantity in one day. They should be trapped with saucers of treacle, bones with a small quantity of meat on, dead birds cut open and laid in their runs (the two last will require dipping occasionally in boiling water) or boiling water, carbolic acid or petroleum poured in their runs will kill them; they also do considerable mischief by distributing aphides over the trees when the young leaves are forming.

STRAWBERRIES—The foliage of these has been very much cut in many places this season by the frost and now looks untidy. Tender sorts, such as Sir C. Napier, have, in some instances, suffered severely, and some are killed. The brown leaves should now be pulled away wherever it is necessary to keep the plantations neat and tidy; but in market gardens and similar places they may be left on, as their presence is no detriment to the welfare of the plants.

Manuring.—Plantations in poor soil and those that are exhausted will be much benefited now by an application of well-decomposed farmyard manure, after the beds have been cleaned. Spread this evenly among the plants and break it down fine, so that the rains may wash it down to the roots. Do not dig amongst Strawberry plants, as so many of the roots are close to the surface and are easily destroyed.

Young Beds.—The best month for planting is August. But space should now be selected before the kitchen garden cropping is completed, and arrangements made so that the ground may be at liberty by the first week in August. Early Potatoes, Cauliflowers, autumn-sown Onions. Lettuces may be planted on the plots in the meantime, the ground to be heavily manured, and deeply dug or trenched after these crops are cleared off.

RASPBERRIES—If not already tied these ought to be finished as soon as possible. Instead of bundling four or five canes together around a stake, as many do, it is better to put stout larch stakes in at 20 feet apart in the rows, and strain three lengths of galvanised wire to them at various heights, the canes to be tied to these wires about 6 inches apart. Another plan may be followed where the rows are thick enough and not less than 6 feet apart, by placing a line of stout stakes 10 feet apart on each side of the row at 2 feet from the bottom, a stout wire to be fixed to the top of these stakes, and the fruiting canes fastened to this at their points, half of them being pulled over to each side of the row. This system is best where there is room and convenience for it, as the young shoots can thus grow up freely in the centre of the row during summer and have plenty of light and air without interfering in any way with the ripening fruit.

Manuring.—Raspberries are much benefited by a good dressing of farmyard manure in spring, which must be applied in a similar way as above recommended for Strawberries. Both fruits usually have the majority of their feeding roots near the surface, and for this reason should never be dug. All suckers must, however, be taken out from the spaces between the rows, and may be replanted if required, care being taken to cut off their tops at once to within 2 inches of the surface.

Apples and Pears for Grafting.—These may now have their branches sawn off to within a few inches of the place where the grafts will be inserted, leaving as many small branches as possible, so as to draw the sap and assist the growth of the scions. The quantity of scions required should be at once cut off (if not already done) and laid in by the heels in a moist and shady place until required for insertion, as it is necessary to success that the growth of the stocks be in advance of the scions.

FRUIT FORCING.

VINES.—*Grapes Ripening.*—After the Grapes commence colouring ventilate as freely as possible, and gradually reduce the atmospheric moisture. The temperature should be well maintained in the daytime, 70° to 75°, with 10° to 15° rise from sun heat, allowing the temperature to fall through the night to 65° or even 60°.

Vines in Flower.—Maintain a steady circulation of warm rather dry air where Vines are in bloom, maintaining a temperature of 70° to 75° for Muscats, and 5° less for Black Hamburgs, allowing an advance of 10° to 15° from sun heat. All shy-setting varieties must be artificially

impregnated, brushing the bunches over carefully with a camel-hair brush, applying pollen from the free-setting varieties to the stigmas of the shy-setting sorts. We find it a good plan to dust over the bunches lightly of the latter first, and then apply the pollen with another brush, proceeding very gently in both cases.

Disbudding.—Let the bunches appear on the points of the shoots before attempting this, and then it must not be done in a hurry, nor a large reduction made at a time, but proceed gradually and rationally, so as to give as little check as possible. Retain no more growths than will have full exposure to light, as crowding the foliage prevents the due elaboration of the sap and the storing of assimilated matter in the fruit and adjacent wood.

Stopping.—It is a safe plan to allow the shoots with fruit to extend three or four leaves beyond the bunches before taking out their points. The laterals below the bunches may be rubbed off, or they should be pinched at the first joint, but those above the fruit may be allowed to extend until the available space is fairly furnished, then pinch them, and keep them within bounds afterwards by pinching to each joint of growth as made.

Thinning.—This, as regards both bunches and berries, is an important operation. Remove all surplus bunches before they flower, particularly duplicates, as it is hardly likely one bunch will set well and the other indifferently on the same shoot. Free-setting varieties may have the berries thinned as soon as they are out of flower, but Muscats and other shy setters must not be thinned until it is seen which berries have been properly fertilised. Instructions for thinning are difficult to give, as the berries vary considerably in size in different varieties, and even different individuals of the same variety. Each berry should have room to swell without becoming wedged, and yet leave sufficient berries to ensure the bunch retaining its form when cut.

PEACHES AND NECTARINES.—*Second Early House.*—Disbud carefully and gradually, removing the strongest and ill-placed shoots, and have all the leading shoots tied down, taking care not to overcrowd them. Proceed by degrees in thinning the fruit; where thickly set pay extra attention to it, removing it very gradually, taking off those on the under side of the trellis or otherwise badly placed, but leave those that are well exposed to light and air until they indicate by free swelling the need of further reduction, then remove the smallest. Syringe the trees early during fine days, and ventilate early in favourable weather. The temperature may range from 55° to 60° at night, and 60° to 65° by day, ventilating at the latter temperature and closing the house when the heat is decreasing, allowing an advance of 5° to 10° from sun heat. Avoid cold draughts of air, but admit it freely in favourable weather, so as to ensure sturdy growth, well-developed foliage, and thoroughly solidified wood.

Houses Started Early in February.—The trees being now in flower, or nearly, should be examined, and if there are more blossoms or flower-buds than are needed all those on the under side of the shoots should be removed by drawing the hand the reverse way of the growths, and even then there may be three-quarters more than will be required for the crop; therefore they may be still further thinned where most crowded, especially on the weaker shoots. Maintain the night temperature at 50° to 55° and 55° by day, with a little ventilation, as a close atmosphere is fatal to a good set. Ventilate freely above 55° and allow an advance to 65° with sun heat. Fertilise the flowers in the early part of fine days, either by shaking the trellis or drawing a camel's hair brush over the flowers when the pollen is ripe. If bees visit the flowers they will effectually distribute the pollen. Syringing the trees must cease whilst they are in flower, but the floor should be sprinkled in the morning and afternoon of fine days. Avoid cold currents of air, but admit a little constantly, as a close stagnant atmosphere causes moisture to be deposited on the delicate organs of fructification, impairing their vital power.

Houses to Afford Ripe Fruit in Late July and August.—These being planted with the midseason varieties such as Royal George, Stirling Castle (perhaps the most certain cropper and best finishing of all Peaches under all circumstances), Grosse Mignonne, Crimson Galande, Belle Beauce, Noblesse, Dymond, and Barrington, will afford fruit at the time named, but if with early or late varieties the season will be enhanced two or three weeks earlier or later. Close the houses, syringe the trees two or three times a day until the buds show colour, when it must cease. Do not keep the trees, however, constantly dripping with moisture, but damp sufficiently early to allow them to become fairly dry before night, and on dull days only damp the paths. The inside borders must be brought into a thoroughly moist state by repeated watering if necessary, and with the borders properly drained liquid manure may be given weakly trees or those having a superabundance of blossom buds. Where this is the case it is a good plan to rub off the bloom buds on the under side of the trellis, which will enable those left to form finer flowers, and a sturdy blossom develops a much better embryo fruit than a weakly. Maintain a temperature of 50° by day, 40° to 45° at night, advancing to 65° with sun and full ventilation.

Late Peach Houses—If the lights are off there need not be any hurry in replacing them before the middle of March, as that will be early enough to have the trees in full flower by the middle of April, and then they have the benefit of the sun heat. Many late houses are unheated, which is a great mistake, as the flowers, even in April, are not safe from severe spring frosts, and the fruit does not ripen well if the late summer be cold and sunless. A gentle heat during the flowering period does much towards a good set, and in autumn artificial heat ripens the fruit and wood, plumping the buds wonderfully. Houses

with fixed lights should be ventilated freely, and the borders must not be allowed to become dry, giving thorough waterings to ensure the moistening of the soil.

Wall Cases.—Where these are employed, whether over Peach or other description of fruit trees, the chief consideration is retarding the blossoming. Peach and Nectarine trees, also Plums and Cherries, need not have the lights put on until the middle of March; but Apricots should have the lights put on when their flower buds begin to show white, and after they are placed on ventilate freely, as nothing is so fatal to Apricot blossom as a close moist atmosphere. Those that have not had the roof lights removed may need supplies of water so as to bring the soil into a thoroughly moist state, and may have the border mulched with a couple of inches thickness of rather short somewhat fresh manure. Ventilating freely to retard the flowering to as late a period as possible.

CUCUMBERS.—Evaporation is correspondingly increased by increased solar heat, necessitating a greater supply of atmospheric moisture. Damp the house so as to maintain a genial atmosphere, syringing the plants lightly during bright afternoons. A night temperature of 65° is sufficient, allowing 5° advance when the external air is mild, 60° being the minimum in the morning when the weather is severe. Liquid manure may be applied once or twice a week. Do not allow the fruits to hang too long, or they may weaken the plants—besides, they keep fresh for several days with their stalks inserted in saucers of water. Thin the fruits well, especially on plants just coming into bearing, stopping the shoots one joint beyond the fruit, removing superfluous growths and bad leaves as they appear, as well as staminate flowers, also a superfluity of pistillate flowers.

Pits and Frames.—Bright and cold nights suit Cucumbers if the temperature is kept at a safe degree by linings and protective material over the lights at night so as to maintain steady progressive growth. Expel moisture by admitting air, taking care to avoid cold draughts, closing early so as to retain the sun heat. When the atmosphere is close as is occasioned in dull weather, resulting in an excess of moisture, not unfrequently causing the loss of the plants, and air cannot be admitted, much may be done by sprinkling quicklime or dry soot around them, these substances having a strong affinity for moisture. Continue to prepare material for making fresh beds and for linings, and sow as successional plants are required.

MELONS.—Turn out the first plants before they become root-bound, watering a little time previously so that the roots may part freely from the sides of the pot. Pot later sown plants when they show the second leaves, employing warm soil. The plants from seed sown early in February will soon be ready for planting out. Make up the beds for them, and make also a successional sowing. Those who are growing Melons in frames should make a successional sowing every fortnight or three weeks until May, making fresh beds at similar intervals to receive the plants, so as to maintain an uninterrupted supply of fruit. Maintain a night temperature of 65° to 70°, 5° less if the weather be cold, 70° to 75° by day, admitting a little air at 75°, allowing the temperature to rise to 85° with increased ventilation, closing at 80° or 85°, sprinkling at the time every available surface, and if the temperature rise to 85° or 90° so much the better. Keep the bottom heat at from 75° to 80°. Be careful to avoid cold currents of air, placing some small meshed netting over the openings to break its force when it is sharp.

PLANT HOUSES.

Gardenias.—Repot young plants that have been wintered in 3-inch pots. They will succeed in equal proportions of loam and leaf mould, with sand added. If moderate bottom heat can be given to start them all the better; if not, they will start freely into growth in any warm moist atmosphere. Plants that have flowered may be cut back and started in brisk heat. If scale exists syringe with petroleum and water; they will bear a stronger application after pruning than would be advisable during the season of growth. After they have commenced growth pot in the compost advised above, but reduce the leaf mould to one-third, and add one-seventh of decayed manure. Do not allow plants that are swelling their buds to suffer by an insufficient supply of water. On the other hand, be careful not to give too much.

Ixoras.—Prune any plants that need it, and start them in a night temperature of 65°. Thrips are destructive enemies to these plants, and if any are present syringe thoroughly with diluted tobacco water. Syringe once or twice daily with tepid water according to the weather, and repot the plants as soon as the roots are fairly active. Employ compost of good peat and sand. Ixoras that were pinched in August may be allowed to grow without stopping unless some shoots are taking the lead. All young plants may be potted, a portion being pinched, the remainder being allowed to come into flower without.

Anthurium Andreanum.—Any that have grown too large may be cut back close to the base, when they will soon break again into growth and flower freely throughout next winter. Some which have grown with one stem often make good bushes after cutting them back. The portion removed may be cut into lengths with a growth bud attached to each, and inserted singly in small pots in sand and sphagnum moss. If plunged in brisk bottom heat in the propagating frame they will soon root and grow. These, if potted, will make capital plants for flowering for the embellishment of the stove in 6-inch pots during the winter. For furnishing purposes this Anthurium is valuable in small pots.

Alocasias.—Various Alocasias that need repotting may be turned out and the old soil carefully worked from amongst their roots. If necessary, wash it out with tepid water and repot in a compost of peat in lumps, sphagnum moss, charcoal, and sand. The root portion of the plants may be removed and the latter potted well down to their crowns. If placed afterwards where they can be shaded from the sun and in a moist close atmosphere, they soon establish themselves, and commence producing their large and beautiful leaves. Small plants may be used with effect in groups during the summer in rooms and similar positions for a time.

Acalyphas.—All good tops should be re-rooted and as many cuttings as possible where quantities are needed for decoration. Those rooted now and grown on until they are placed into 5 and 6-inch pots will be invaluable for conservatory decoration during the summer. They root quickly in brisk heat in the propagating frame or under handlights, and will grow freely in almost any rich soil. After they are rooted expose them fully to the sun on a shelf close to the glass. Only by this treatment can sturdy growth be obtained and the beautiful colour of their foliage developed. Never allow them to become dry, or they soon lose their lower foliage. If aphides attack them fumigate at once. When large bushes are needed insert four or five cuttings together in a pot and grow them on without pinching, and the plants will be well furnished to the base with large bold foliage.

Francisceas.—These are not grown to the extent they deserve, but with a number of plants a succession of bloom can be had throughout the winter and spring months. Plants that have flowered may be well pruned or their shoots shortened as far as may be deemed necessary to put the plants into shape. Place them afterwards in brisk heat, water liberally, and syringe freely. When they have started into growth repot in a compost of peat and sand. The young shoots should be pinched from time to time when four or five leaves have been made until August, when they should be allowed to grow. This depends, however, upon the time they are wanted in bloom. The later they are required the longer they should be kept growing. Francisceas can readily be retarded aftergrowth by placing them in a temperature of 50°. Cuttings root freely by inserting young wood in sandy soil and placing them in the propagating frame or covering them with bellglasses. If brisk bottom heat can be given it will prove an advantage. Plants in 5-inch pots are useful for furnishing, and in a small state they do well in leaf mould and sand.

THE BEE-KEEPER.

APIARIAN NOTES.

I CONTEND that if societies are to be of any use to cottager bee-keepers they must abandon their support to dealers and take the true bee-keeper under their protection. It is a much easier matter to teach the handling of bees and the methods for securing a little surplus than to show them that the profit and much of the pleasure of bee-keeping lies entirely in the proper manipulation of the produce of the hive, but from the proof we have given, and which lies before me, the tutors are themselves pupils of the lowest standard.

I had an opportunity this past autumn of examining many samples of large consignments of honey from different places, and I regret to say that at least 70 per cent. of it was very inferior, scarcely a sample but what showed a watery line of great depth upon the top, and fermentation at work. One sample of Heather honey from Aberdeenshire was so thin that it gurgled when being carried as if it had been water.

A customer called upon me lately for honey which I could not supply, but I procured some for him at his request. On the top of every jar there would be two ounces liquid, and the whole mass in a state of active fermentation. The covers of the jars were all lifted up through it. So long as such inferior honey is sent into the market there will be little demand for even genuine stuff. Societies, if they had less self-interest, could remedy all this as well as the very objectionable way shopkeepers expose honey in windows.

But perhaps the proprietors of gardens and gardeners keeping bees more extensively than they have done in the past will be a means of creating a greater demand for honey by disposing of it through a channel more likely to spread its usefulness than has been formerly. Bees are a happy community, and when their

affairs are allowed to proceed properly, and due attention paid to their wants and management, the reward will be prosperity.

If "A Surrey Amateur" uses his influence in a right direction he may be the means of doing much good amongst the bee-keepers of his neighbourhood, and be the means of enlightening many readers of this Journal

THE FORWARD STATE OF HIVES.

Last week I mentioned the advanced state of hives. The past fine days have shown them to be even further advanced than I thought, and further than in any year since I commenced bee-keeping. This advanced state calls for due attention to feeding that none may suffer for want of it, for if they do all hopes of profit for the year may be abandoned, so I trust the hint will be taken.—A LANARKSHIRE BEE-KEEPER.

FIXING FOUNDATION IN SECTIONS.

So numerous are the methods of fixing foundation that I am afraid it is hopeless to produce anything new in that line. I have tried various plans, but was formerly most successful with the simple means of a hot poker. This, however, wasted more foundation than was desirable, which was the result of the poker sometimes being too hot. To obviate this I hit upon the following plan, which is the best I have yet seen. I am quite prepared

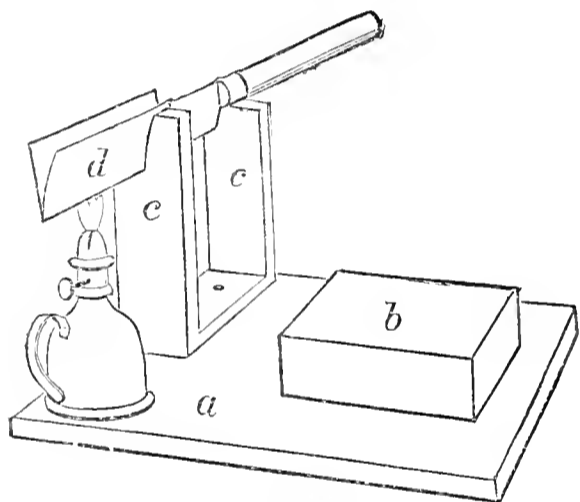

FIG. 42.

to find that some of our old hands has used the same sort of thing fifty years ago. However, it is so simple, clean, and expeditious, and can be made by any handy man in half an hour, that I give it now for what it is worth.

The accompanying sketch will show at a glance what is wanted. A is a piece of deal, upon which is fixed a block B, which must be 1 inch thick, and made to slip the sections on while the foundation is being fixed, leaving sufficient room for an ordinary table knife to pass down between the block and the section. Now fix three pieces of wood as shown at C C, and into a triangular cut place a piece of tin, doubled, as shown at D. Into this is placed an ordinary table knife, and underneath is a small lamp, the flame of which keeps the knife always at one heat, sufficient to melt the edge of the foundation. Having placed the section on the block, the edge of the foundation almost close to it, hold it in position with the left hand, and with the right draw the warm knife quickly along its edge, and immediately pass it up to the section, to which it will adhere at once, and is ready to be placed in supers. There is remarkable little waste of foundation, and none that are properly done will break down when the bees take to them.—A SUSSEX AMATEUR.

TRADE CATALOGUES RECEIVED.

Dobie & Mason, 66, Deansgate, Manchester.—*List of Farm Seeds.*

A. M. C. Jongkindt Coninek, Tottenham Nurseries, Dedemsvaart, Netherlands.—*List of Trees and Hardy Plants.*

Little & Ballantyne, Carlisle.—*List of Farm Seeds, 1891.*

James Carter & Co., 237 and 238, High Holborn, London.—*Lawns, Lawn Tennis, and Cricket Grounds.*

Agricultural and Horticultural Association, Limited, Creek Road, Deptford, S.E.—*Prospectus and Catalogue of Artificial Manures.*



•• All correspondence should be directed either to "THE EDITOR" or to "THE PUBLISHER." Letters addressed to Dr. Hogg or members of the staff often remain unopened unavoidably. We request that no one will write privately to any of our correspondents, as doing so subjects them to unjustifiable trouble and expense.

Correspondents should not mix up on the same sheet questions relating to Gardening and those on Bee subjects, and should never send more than two or three questions at once. All articles intended for insertion should be written on one side of the paper only. We cannot reply to questions through the post, and we do not undertake to return rejected communications.

Wednesday's Letters (*J. V. B. and others*).—Letters arriving on Wednesday cannot be satisfactorily answered in the current issue.

Seedling Carnation (*A. E.*).—It is a good pure white variety, very sweet and decidedly useful, as you have been "cutting flowers from the same plant for three months." We do not remember one exactly like it, but there are several of a similar type.

Double Cinerarias (*S. K.*).—The blooms are very good indeed, and worth sending anywhere; but we do not intend you to understand that they are better than some of the best varieties in commerce, or that you can by any means rely on a certificate for the variety being granted in London.

Dwarf Pea (*F. S.*).—William Hurst is a good dwarf Pea. It grows a foot high, a little more or less, according to soil and season, pods freely, and the peas are of excellent quality. We do not know which is the best Pea for drying for winter use, but those of our readers who may have tried different varieties for that purpose are at liberty to state their experience.

Cardoons (*T. H.*).—They are grown practically in the same way as Celery, but the rows need to be farther apart, because more soil is needed for earthing. In very wet soils they are best sown or planted on the surface, the site being well enriched. The seed may either be sown in April where the plants are to grow, thinning them to a foot apart, or raised elsewhere, grown sturdily, and transplanted; but they must not be raised too early or drawn in their early stages, or most of them may form flower stems and be of little or no use.

Aerial Roots on Vine Rods (*A Young Gardener*).—The cause is a close moist atmosphere, or keeping the rods damp by syringing. It is accelerated by the roots being in a cold, wet, or otherwise unsuitable medium. The season has been unfavourable to air-giving, and that, to a certain extent, accounts for roots being pushed from the rods. Nothing can be particularly wrong with the border, as the Vines are showing good bunches. We do not think you have any cause for anxiety, as the Vines will improve as the season advances, and the air-roots will dry up as they have a better ventilated atmosphere and the roots become active in the border.

Climber for Greenhouse and Palm House (*Idem*).—Unless the walls have plenty of light they will be of little use for flowering plants. For greenhouse, *Lapageria rosea* and *L. alba*, *Rhynchospermum jasminoides* and *Plumbago capensis*. If shaded *Camellia* do best. For Palm house, *Bougainvillea glabra*, *Clerodendron Balfourianum*, and *Stephanotis floribunda*. If shaded nothing surpasses in beauty *Cissus discolor*.

Mildew on Peach Trees (*Bucks*).—Your trees are seriously attacked by mildew, and the sooner you apply a fungicide the better. Perhaps sulphide of potassium might answer, and it is sold by nurserymen and dealers in horticultural requisites with instructions for use. The following preparation is extensively used in France:—1½ lb. of quicklime, 3 lbs. of sulphate of copper, and 20 gallons of cold water. Dissolve the sulphate of copper in cold water for two hours in one vessel. In another pour a little water by degrees on the lime, mixing it well till it becomes a milky liquid; then pour the latter into the former, stir them well, and add to the 20 gallons of water already provided. It should be applied at intervals of three weeks, and always used fresh. Mr. A. Bishop, Westley Hall Gardens, Bury St. Edwards, prepares what he has found a specific against mildew on Peaches, and we think he will send you some if you write to him on the subject.

Planting Vines and Figs (*Vine*).—Figs would grow quite strongly enough in the narrow border next the back wall, but the trees would only bear sparsely after the roof became covered with foliage. A tenth part of mortar rubbish mixed with the loam would be suitable for Figs. Vines there planted would produce two or three good crops, then gradually become weaker, and eventually of little value. Splendid crops of Tomatoes might be grown against the wall during the present and

two or three following seasons. We do not see what you would gain by planting some of the Vines on the north side of the pipes, nor do we think there is anything material to lose. It is a matter of fancy. We should not shorten the canes now, but let the buds push, then gradually remove them downwards to a free growth, starting anywhere on a level with the lower part of the front sash. As a rule, the shorter the cane is the better the first season's growth from a bold bud. When the Vines are growing freely and have formed large leaves the disbudded stems may be cut back, as then there will be no bleeding. We should treat the canes of both the permanent and supernumeraries alike this spring, but differently at the winter's pruning, and we should not plant till the buds had pushed to the extent of an inch or so on the upper parts of the canes.

French Beans (S. J. A.).—The Flageolet Beans of the French are grown and used in the same way as the ordinary Dwarf Kidney Beans that are grown in British gardens, the favourite variety in France being the White Flageolet; the Negro Long-pod, which is a favourite in England, being called the Black Flageolet in France. The ripe seeds of the former may be used in winter as Haricots, but for summer use the pods are sliced when young, not cooked when the seeds are much advanced in growth; but they, also our Kidney Beans, are edible podded, but curiously, though you eat them, say they are not. The Mange-tout Beans are what you appear to require, and if you order some Mont d'Or Butter Beans and grow them the same as Scarlet Runners you will have what you require; they are sold by English seedsmen. There is a dwarf variety grown in France. The white Prédome Butter Bean is much grown in France and the Princess in Belgium. They are both tall growers, like the Mont d'Or and Scarlet Runners. Butter Beans are devoid of the horny membrane which forms in the Kidney Beans that are usually grown in this country, and in consequence of which the pods have to be eaten when young; but the seeds in the Mange-tout or Butter Beans may attain to a good size, and these with the pods are quite tender when well cooked. They are illustrated in Vilmorin's "Vegetable Garden," to which you allude. The pods of Kidney Beans, gathered when quite crisp and dry, may be preserved by placing them in close layers in jars, just covering the pods with alternating layers of salt. They require to be soaked for a long time before use in winter. Not the slightest apology was needed for your asking further questions on Beans, and you can ask more if you wish to do so, and require such specific information as you may indicate. We will give it if we can, and if not will tell you so; but please understand we cannot discuss the other subject which appears to be in your mind. It would take up our time and space needlessly, and could not be of the slightest benefit to anyone. We are responsible for all that appears in this column.

Sulphate of Ammonia for Vines, Tomatoes, Chrysanthemums, and Roses (Oxon).—Sulphate of ammonia is suitable for all soils requiring supplies of nitrogen except those derived from chalk or limestone formations. When applied to soils that contain 10 per cent. of carbonate of lime the ammonia from the sulphate escapes into the atmosphere. Nitrate of soda is the nitrogenous manure to be used for all chalky soils. Sulphate of ammonia is particularly valuable for loamy or clayey soils. It may be applied as a surface dressing at the rate of 1½ cwt. per acre, or 1 lb. per rod, which is equal to half an ounce per square yard, but horticulturists use it at the rate of 1 oz. per square yard, and wash it in. The dressings are most efficacious when applied along with insoluble phosphates such as ground bones or coprolites, but for speedy effect steamed bonemeal is preferable, 3 lbs. to 5 lbs. per rod being given along with the ammonia sulphate, for no sulphate or nitrate can produce full effects when phosphoric acid, potash, and other nutrient substances are not present in sufficient quantity. Sulphate of ammonia is more readily fixed than nitrates. It should be applied to Vines not later than when they are starting into growth, but may be used later when in liquid form at the rate of 2 ozs. to a 4-gallon watering pot, and once a week is sufficiently often to apply it to pot plants. It is, however, most economically applied as a surface dressing, the ammonia being easily absorbed by clayey and organic matter contained in soils. For pot plants a tablespoonful to 4 gallons of water is a proper quantity, the plants being well rooted, but it must not be applied oftener than once a week, and not used as a surface dressing in quantity, as that is liable to injure the surface roots.

Names of Fruits.—The names and addresses of senders of fruit to be named must in all cases be enclosed with the specimens, whether letters referring to the fruit are sent by post or not. The names are not necessarily required for publication, initials sufficing for that. Only six specimens can be named at once, and any beyond that number cannot be preserved. (G. M. S.).—The best opinion that we can form from a close examination of the frozen specimens is that the variety of Apple is Alfriston, some of the fruits being more highly coloured than usual. The tree is an excellent grower, and makes a fine standard. (B. E.).—1, Mère de Menage; 2, Northern Greening; 3, Court Pendû Plat.

Names of Plants.—We only undertake to name species of plants, not varieties that have originated from seed and termed florists' flowers. Flowering specimens are necessary of flowering plants, and Fern fronds should bear spores. Specimens should arrive in a fresh state in firm boxes. Slightly damp moss, soft green grass or leaves form the best packing, dry wool the worst. Not more than six specimens can be named at once, and the numbers should be visible without untying the ligatures, it being often difficult to separate them when the paper is damp.

(A. L.).—It is a seed pod of *Eccremocarpus scaber*. (W. S. B.).—1, A strong variety of *Adiantum cuneatum*; 2, *Acrostichum osmundaceum*; 3, *Blechnum brasiliense*. (J. B.).—1, *Saxifraga Burseriana*; 2, *Saxifraga oppositifolia*; 3, *Chionodoxa Luciliae*; 4, *Galanthus plicatus*. (M. M.).—1, *Dendrobium lituiflorum*; 2, *Dendrobium primulinum*; 3, *Masdevallia tovarensis*.

COVENT GARDEN MARKET.—MARCH 18TH.

MARKET quiet, with prices unaltered.

FRUIT.			
	s.	d.	s. d.
Apples, ½ sieve	1	6	to 6 0
" Nova Scotia and	15	0	26 0
" Canada, per barrel	2	0	4 0
Grapes, per lb.	45	0	50 0
Kentish Cobs			
Lemons, case	15	0	to 20 0
Melons, each	0	0	0 0
Oranges, per 100	4	0	9 0
St. Michael Pines, each	3	0	8 0
Strawberries, per lb.	8	0	13 0

VEGETABLES.			
	s.	d.	s. d.
Artichokes, dozen	0	0	to 0 0
Beans, Kidney, per lb.	2	3	2 6
Beet, Red, dozen	1	0	0 0
Brussels Sprouts, ½ sieve	3	0	4 0
Cabbage, dozen	3	0	0 0
Carrots, bunch	0	4	0 0
Cauliflowers, dozen	3	0	6 0
Celery, bundle	1	0	1 3
Coleworts, doz. bunches	2	0	4 0
Cucumbers, doz.	4	0	8 0
Endive, dozen	1	0	0 0
Herbs, bunch	0	2	0 0
Leeks, bunch	0	2	0 0
Lettuce, dozen	3	0	3 6
Mushrooms, punnet	1	6	to 2 0
Mustard & Cress, punnet	0	2	0 0
Onions, bushel	3	0	4 0
Parsley, dozen bunches	2	0	5 0
Parsnips, dozen	1	0	0 0
Potatoes, per cwt.	3	0	4 0
Rhubarb, bundle	0	2	0 0
Salsafy, bundle	1	0	1 0
Scorzoneria, bundle	1	6	0 0
Seakale, per bkt.	2	0	2 6
Shallots, per lb.	0	3	0 0
Spinach, bushel	5	0	6 0
Tomatoes, per lb.	0	0	0 8
Turuips, bunch	0	0	0 4

AVERAGE WHOLESALE PRICES.

CUT FLOWERS.			
	s.	d.	s. d.
Arum Lilies, 12 blooms	2	0	to 4 0
Azalea doz. sprays	0	6	0 9
Bouvardias, bunch	1	0	1 6
Camellia, white, per doz.	2	0	4 0
" red	1	0	1 6
Carnations, 12 blooms	1	0	2 6
Christmas Roses, dozen	0	0	0 0
Cineraria, 12 bunches	6	0	9 0
Cyclamen, doz. blooms	0	3	0 6
Daffodils, doz. bunches	2	0	6 0
Eucharis, dozen	3	0	6 0
Gardenias, per doz.	4	0	9 0
Hyacinths (Roman), doz.	0	6	1 0
Hyacinth, Roman (French)	1	0	2 0
Lapageria, 12 blooms	2	0	4 0
Lilac (French) per bunch	4	0	6 0
Lilium longiflorum, 12	4	0	6 0
Lily of the Valley, dozen	0	6	1 0
sprays	0	6	1 0
Maidenhair Fern, dozen	4	0	9 0
bunches	4	0	8 0
Marguerites, 12 bunches	3	0	6 0
Mignonette, 12 bunches	3	0	6 0
Mimosa (French), per	1	0	to 1 6
bunch	1	0	to 1 6
Narciss (Paper-white),	1	6	4 0
French, doz. bunches	0	9	1 0
Do. Do. English,	0	9	1 0
per bunch	0	9	1 0
Narciss (Various) dozen	2	0	4 0
bunches, French	1	0	1 6
Pelargoniums, 12 trusses	6	0	9 0
" scarlet, 12 bunches	0	0	0 0
Poinsettia, dozen	0	6	1 0
Primula (double) 12 sprays	1	0	2 0
Primroses, dozen bunches	0	6	1 6
Roses (indoor), dozen	4	0	8 0
" Red (English) per	2	0	4 0
dozen blooms	1	0	3 0
" Red, 12 bls. (Each)	3	0	6 0
" Tea, white, dozen	1	0	3 0
" Yellow, dozen	1	0	3 0
Snowdrops, doz. bunches	0	6	0 9
Spiraea, per bunch	1	6	2 0
Tuberose, 12 blooms	0	9	1 6
Tulips, per dozen	2	0	3 0
Violets (Pamel), per beh.	1	0	2 0
" (dark), per beh.	1	0	2 0
" (English), doz. bunch	1	6	2 6

PLANTS IN POTS.

	s.	d.	s. d.
Aralia Sieboldi, dozen	6	0	to 18 0
Arbor Vita (golden) doz.	6	0	8 0
Azalea, per plant	2	0	3 6
Cineraria, per doz.	6	0	9 0
Cyclamen, per doz.	9	0	21 0
Dielytra spectabilis, per	8	0	12 0
dozen	24	0	42 0
Dracena terminalis, doz.	12	0	24 0
" viridis, dozen	12	0	18 0
Erica, various, dozen	6	0	18 0
Euonymus, var., dozen	6	0	18 0
Evergreens, in var., dozen	6	0	24 0
Ferns, in variety, dozen	4	0	18 0
Ficus elastica, each	1	6	7 0
Foliage plants, var., each	2	0	to 19 0
Genista, per doz.	8	0	12 0
Hyacinths, doz. pots	6	0	9 0
Lily of the Valley, per pot	1	0	2 0
Marguerite Daisy, dozen	6	0	12 0
Mignonette, per dozen	6	0	9 0
Myrtles, dozen	6	0	12 0
Palms, in var., each	2	6	21 0
Pelargoniums, per doz.	0	0	0 0
Poinsettia, per doz.	0	0	0 0
Primula sikkensis, per doz.	4	0	6 0
Solanums, per doz.	9	0	12 0
Spiraea, per doz.	8	0	12 0
Tulips, dozen pots	6	0	8 0

Bedding plants (in variety) in boxes, from 1s. to 5s.



MANGOLDS.

In about three weeks after the publication of this article the Mangold seed should be sown. Please make a special note of this, young home farmers, and do not wait for the sowing till the first week in May, as you find so many do; but sow early in the second week of April in order that April showers may induce speedy seed germination, and the young plant be well established before hot, dry weather sets in.

Aim at obtaining a full crop of sound, heavy roots of an average weight of, say, 15 lbs. If they should approach 20 lbs. in weight so much the better; but a pound or two of difference is immaterial, only we do not like the roots to be much under our average; nor do we care to incur an extravagant outlay to produce huge specimens of 30 or 40 lbs. weight. What marvellous uniformity of size and perfection of form do some of the great seed firms show us in their seed list illustrations! Well, they are justified in pushing business; but we should think none the less of them for a little less puff, and for giving us farmers credit for the possession of a grain or two of common sense.

To every farmer who had his Mangold land well cleaned and thrown up in ridges last autumn we say, Well done! You are the men for whose benefit we are now writing, because your land is not only ready for the manure and early sowing, but the hoeing subsequently will consist simply in keeping under annual weeds.

Now about manure, for that is of vital importance in the culture of this root crop. Season after season have we explained that the chief advantage derived from the use of farmyard manure is, that by the roots of the young plant becoming established in the moist humus, it is comparatively unaffected by drought. That is our only reason for using dung, and by early sowing one may very well avoid using it at all. In time to be of general use this season comes the report of the field experiments of the Bath and West of England Agricultural Society. These experiments were made at twenty-five stations in nine counties, to ascertain what manures answer best for Mangolds, and the results are so clear and important that we give the table of the manures used, the cost, the average produce of the plots, and other important particulars. This year experiments with corn will be made to test the value of the residue left in the soil.

PLOTS WITH FARMYARD MANURE.

Plot.	Manure and cost per acre.	Average produce.			Average increase.			Cost per ton of increase.
		tons.	cwt.	lbs.	tons.	cwt.	lbs.	
A	20 loads dung, £4 10s.	23	10	31	7	15	95	11s. 6d.
B	10 loads dung, 2 cwt. nitrate of soda, 4 cwt. mineral superphosphate, £3 16s. 6d.	26	7	62	10	13	14	10s. 2d.
C	10 loads dung, 2 cwt. nitrate of soda, £3 3s. 6d.	25	6	95	9	12	47	6s. 7d.
D	10 loads dung, 2 cwt. nitrate of soda, 4 cwt. salt, £3 8s. 6d.	26	13	34	11	3	93	6s. 1d.
E	20 loads dung, 4 cwt. superphosphate, £5 3s.	24	9	96	8	15	43	11s. 9d.

PLOTS WITHOUT FARMYARD MANURE.

G	4 cwt. nitrate of soda, £1 17s.	24	14	40	8	19	104	4s. 1d.
H	4 cwt. nitrate soda, 4 cwt. superphosphate, 1 cwt. salt, £2 15s.	29	0	83	13	6	40	4s. 2d.
I	2 cwt. nitrate soda, 4 cwt. superphosphate, 4 cwt. salt, £1 13s. 6d.	27	0	37	11	5	101	3s. 3d.
K	3 cwt. sulphate of ammonia, 4 cwt. superphosphate, £2 10s. 6d.	24	6	71	8	12	23	5s. 10d.
L	4 cwt. nitrate of soda, 4 cwt. superphosphate, £2 10s.	26	11	105	10	17	57	4s. 7d.
F & M	Unmanured	15	14	48				

The produce of the unmanured plot is given as a basis for calculating the increase of the other plots.

From these results we see the decided inferiority of farmyard manure, which even at the price charged—4s. 6d. per load—is by far the most costly manure used, and if full account were taken of every item that went to the manufacture of it the cost would mount up to a much higher sum. Plot A, with its twenty loads of dung, is below all the other plots in gross produce, and above all in cost, with the exception of plot E, to which the addition of 4 cwt. of superphosphate to the same quantity of dung did not give an adequate return.

The lessons of greatest importance to farmers here are the decided superiority of nitrate of soda and the value of common salt for Mangolds. The best of all the mixtures was that of plot H. Compare it with plot I, to which the same kinds of manure were given, but only half the quantity of nitrate of soda, and we have 2 tons less weight of crops, so that it is obvious that the additional cost of the extra 2 cwt. of nitrate of soda for H is quite

worth while. Note also how marked is the superiority of nitrate of soda to sulphate of ammonia, as shown in K and L. Also compare plot G with plot H, and mark how important the addition of the mineral superphosphate and salt is to the nitrate of soda. The formula for plot H, therefore, may be very safely followed this season, and we advise our readers to procure the manure at once, have it mixed at the farm a day or two before using it, sow the mixture broadcast over the ridged land, and it will answer equally well whether the ridges are split for sowing on the ridge or harrowed down for sowing on the flat.

WORK ON THE HOME FARM.

A high wind from the south-west and fine weather was something of a curiosity for the first week of March. It enabled us to sow most of the spring corn, and to roll all the Wheat, so that the ploughs could be put upon the land after the sheep folds for any later sowings of Oats and Barley. Where dung is to be used for root crops it should be got upon the land at once and ploughed in, or placed in the furrows and covered with the double-breasted plough as quickly as possible. A few acres of white Turnips and Rape sown in April are very useful for sheep folding in the dog days, and both these crops follow on winter folded land well. No other manure than that left by the sheep is required, and the land is certain to break up well for a fine deep seed bed.

For heavy land Rape is an excellent crop for summer folding, and if sown early it proves exceedingly useful for the lambs after weaning. They thrive well upon it, and run none of the risk which is so unavoidable when they are taken from the ewes to pasture only. If the land is poor (and pray remember Rape requires rich soil as much as any crop) plough in thirty loads of dung per acre, drill 3 cwt. mineral superphosphate with the seed, sow 3 lbs. of Rape seed per acre in rows 18 inches apart, and when the plants are showing strong growth, top-dress with 1½ cwt. nitrate of soda, harrow it in across the rows, single the plants 10 inches apart in the rows, and then horse hoe. Hand hoe as becomes necessary, and another turn of the horse hoe may also be necessary. But under such liberal treatment growth will be so rapid that the foliage will soon meet, and the crop will attain full growth quickly. To those who have hitherto just sown Rape thickly and left it unthinned, and without any subsequent cultivation, we say, Try the more elaborate method, and you will never return to the thick plant system, for the bulk of crop to be had under high cultivation well repays one. Only pray do not forget that the lambs must not be kept altogether in the folds, but only for a few hours daily, and be taken out regularly upon grass.

For a succession to the Rape, sow in April Pomeranian White Globe and Tankard Turnips—say about the last week of that month, as they then come into use in August and September, precisely when feed is so frequently scarce. How valuable would such a crop have proved to many a man last year, when his bare pasture was practically useless, and he had either to sell stock at a loss or to hire feed for them a distance from his farm.

OUR LETTER BOX.

Mortar for Pigeons (A. E. C.).—This is necessary to keep them in health. In the loft or wired-in run, where they will have constant access to it, keep a box with the following mixture in it:—Coarse gravel, roughly pounded old mortar, and dry loamy earth in about equal quantities. They will enjoy this, and leave your wall alone perhaps.

METEOROLOGICAL OBSERVATIONS.

CAMDEN SQUARE, LONDON.

Lat. 51° 32' 40" N.; Long. 0° 8' 0" W.; Altitude, 111 feet.

DATE.	9 A.M.					IN THE DAY.				Rain
	Barometer at 32° at Sea and Level.	Hygrometer.		Direction of Wind.	Temp. of soil at 1 foot.	Shade Temperature.		Radiation Temperature.		
		Dry.	Wet.			Max.	Min.	In sun.	On grass	
1891.										
March.										
Sunday	29.53	39.4	33.6	N.N.	41.3	40.6	28.1	44.6	33.2	0.043
Monday	29.81	35.2	34.2	N.E.	40.2	39.3	33.0	43.9	28.9	0.548
Tuesday	29.412	31.1	31.0	N.E.	38.9	37.1	28.4	70.0	31.9*	0.291
Wednesday	29.304	35.0	34.4	N.	38.0	40.4	31.1	94.7	31.7*	0.010
Thursday	29.736	40.0	29.9	N.N.	37.2	44.0	23.7	89.1	18.6	—
Friday	29.731	37.7	31.3	N.E.	36.9	47.4	30.2	75.9	23.6	—
Saturday	29.824	38.9	37.8	N.	37.7	45.5	35.6	57.8	34.9	0.020
	29.634	35.5	34.0		38.6	42.0	31.3	70.1	30.4	1.010

* Covered by snow.

REMARKS.

8 h.—Damp and showery all day; a little snow between 4 and 5 P.M.; fair evening.
 9th.—Overcast all day; a few flakes of snow began to fall about 4 P.M., and a blizzard commenced about 5.30 P.M., lasting well into the night. Average depth of snow on the ground at 9 P.M., 2 inches.
 10th.—Snow, sleet, and soft hail till 10 A.M., then fine, with once or twice a gleam of sun; a few flakes of snow at 1.30 P.M., and snow again from 5 P.M. to 3 A.M. on 11th. Average depth of snow on the ground at 9 A.M., 5 inches.
 11th.—An occasional flake of snow till 8 A.M.; bright sun from 10 A.M. to noon, then generally cloudy, with occasional flakes of snow. Halo at 9 A.M.
 12th.—Bright and fine throughout.
 13th.—Bright and fine; halo at 9 A.M.; spots of rain in evening.
 14th.—Overcast, with spots of rain in morning; occasional drizzle in afternoon and evening.
 A cold week, rendered specially noteworthy by the blizzard on the night of the 9th, which has not been equalled in London since January 18th, 1881.—G. J. SYMONS.



LOUDON says:—"The arrangement and laying out of a kitchen garden embraces a variety of considerations, some relative to local circumstances, as situation, exposure, and soil, and others depending on the skill of the artist, as form, laying out of the area, and water. Both require the utmost deliberation; for next to a badly designed ill-placed house, a misplaced, ill-arranged, and unproductive kitchen garden is the greatest evil of a country residence." I have never laid out a brand new kitchen garden of any great size, but I have renovated and remodelled four large kitchen gardens in different parts of the country, made new walks in some of them, levelled and relaid old walks with Box edging in others. Old useless trees have been grubbed out, and where the soil was thin I generally dug it out to the depth of 3 feet and made it up with good earth, drained, trenched, and manured the ground according to its requirements. Young fruit trees were planted in all of them, both in open quarters and borders, by the sides of walks, and at the bottom of walls, and in some of these gardens I have had the pleasure of seeing them grow and make fine fruitful specimens. In making a new garden we must be guided to a great extent by circumstances. The size must be determined by the requirements of the family, the nature of the soil, situation, and climate. Poor light soil will not produce the same quantity of vegetables on a given space that good rich land will, therefore the latter will yield more and better vegetables than almost double the space of the former.

The situation and climate must be taken into consideration. Low damp sites should be avoided if possible. The garden must be open to the south, and well sheltered from the north, east, and west winds, by plantations at some little distance, and enclosed on all sides by walls from 13 to 14 feet high, according to its size, for growing choice fruits. A slip of ground may be left outside the walls so that they can be utilised for training fruit trees on both sides. If the walls are built of stone they ought to be faced with bricks inside and out, and arrangements made when building for placing a temporary coping of wood, to project 6 inches from the top of them for protecting the trees from frost when in bloom, and the fruits from rain in the autumn. This coping can be placed so that it may be easily removed, and stored away when it is not required. If the walls are wired it will be a great saving to them, as it will obviate the necessity of driving nails into them when training the trees.

In laying out a kitchen garden make it, if possible, in the form of a parallelogram, and a little longer north and south than east and west, in order to shorten the north aspect of the wall, which is of little service in some localities for growing choice fruits. It is a rare occurrence, even on a small scale of a few acres, to find a piece of ground all one level, and the soil of one uniform depth. Therefore it is necessary before building the walls that the ground be levelled to suit the situation, no matter whether it is a dead level or an inclined plane, or a series of inclined planes; the cheapest and best way is to keep the levels as near to the natural inclination of the ground as possible, so as to make the garden harmonise with the adjacent ground when it is finished. After the levels of the walls have been fixed the walks can be levelled. These should be made first, but not finished with gravel. If necessary, a drain should be put in the

centre of each walk with cesspools and gratings at suitable distances apart, to carry off the surface water during heavy rain-falls, and, if found needful, drains from any of the quarters of the garden may be led into them.

When the walks have been made, the different quarters of the garden should be trenched and the surface levelled to suit the walks. In places where the ground is too high the surface soil should be removed when trenching, and the subsoil taken out to the depth of $2\frac{1}{2}$ feet or more below the level of the Box edging according to the nature of the soil, and the good earth put back on the top; and in places where the ground is too low the surface soil should be taken off in the same way and the low places filled to the bottom level with the subsoil taken from the high places, and the good earth put back on the top of this. The soil in the wall borders need not be more than 2 feet deep, which should slope gently from the foot of the wall to the walk in front of it. It is a well-known fact that Peach and other fruit trees produce better crops and finer fruits when grown in borders of this depth than in those that are deeper. The roots in shallow borders have more heat and air by being near the surface, and in consequence the trees ripen their wood better than those planted in deep borders in which the roots penetrate away from the influence of the sun.

The forcing and plant houses, lean-to and span-roofed pits and frames, and indeed all the garden offices, should be arranged so as to occupy the north end of the garden with a straight gravel walk in front of them. This arrangement, if carried out, will allow the main portion of the garden to be laid out in regular quarters, which look better, and are easier worked and cropped, than ground which is broken up with houses placed here and there. Besides that, the garden will look better, and it will not be shaded, and will have the full benefit of all sunshine, and a free current of air throughout.

The walks should be gravel, and in moderate sized gardens not less than 6 feet wide, and run parallel to the walls. I think Box edging preferable to all others for a kitchen garden if kept in proper order. The ground along the sides of the walk (where the Box is to be laid) must be made firm, smooth, and level before it is nitched out to receive the Box edging. The nitch should be cut with a gentle slope towards the inside of the walk, against which the Box is laid, and the roots covered with earth as the work proceeds, and tramped firmly with the feet before finishing it off and removing the earth not needed to support it.

The inside wall borders may be from 20 to 24 feet wide and the outer borders in the slip from 12 to 14 feet, according to the size of the garden, with a walk in the centre of the garden and one or more cross walks according to circumstances. A good supply of water is absolutely necessary in all kitchen gardens. In places where it is practicable to have it by gravitation pipes should be laid round the walks and hydrants placed at suitable distances, so that the fruit trees can be syringed and cleaned when required with little trouble, and other crops watered in dry seasons.—A. PETTIGREW, *Cardiff*.

[In another column will be found the plan of a kitchen garden, for which Mr. Hugh Pettigrew, foreman in Cardiff Castle Gardens, was awarded the prize offered by the Cardiff Gardeners' Mutual Improvement Association. The prize consisted of a set of drawing instruments, given by Messrs. Stephen Treseder and Alfred Kettlewell. Mr. Pettigrew, sen., in sending the plan for our inspection sent also the above notes of his own experience, possibly thinking those of his promising young son a little lacking in practical details. Be this as it may, we have pleasure in publishing both contributions, and they will be suggestive to persons who are either contemplating the formation of new or the renovation of old gardens. The plan, as will be seen, is a good one. The original is 25 by 17 inches, drawn to a scale of 20 feet to an inch; it is admirably executed, and if the father can excel the son in writing we doubt very much if, with all his talent, he could have surpassed

him in the production of the plan, which we have had reduced by photography. As the work of a young man not long out of his 'teens' (if he is out) it merits the highest commendation, and Mr. Hugh Pettigrew's success in good competition shows how useful accurate drawing may be to young gardeners]

SIXTY YEARS OF HORTICULTURAL PROGRESS.

1760-1820.

THE long reign of George III., embracing as it does forty years of the eighteenth century and twenty of the nineteenth, marks a very memorable period in the annals of our horticulture, a period of steady if not of rapid advance. Gardeners there were who could survey it all, men who, as sturdy young fellows, turned over the soil in 1760 with the spade of the period, attired in a costume which was far from conducive to freedom of action, and who lived on to 1820, when it was their delight to sit in leafy harbour, pipe in hand, and recount their memories of the past. When speaking of the early history of English horticulture we had to notice the fact that in the reigns of William III. and Anne his successor the progress of gardening was sadly checked by the wars in which Britain was almost constantly engaged; for the effect of these was the interruption of our national intercourse with the continent, also the country was drained of its resources and the people's attention diverted from peaceable pursuits. To some extent, indeed, the American and European wars into which Britain was led during the reign of George III. had a similar influence, especially at the time when immense additions were made to our national debt, and when most of the continental countries were hostile to our little island. But happily the love of gardening was beginning to spread amongst the people, and what had been for centuries the pursuit of only a few found many followers amongst all ranks except the poorest, the press helping this on by the cheapening of old books and the publication of new ones, while a more refined taste was developed, causing an admiration of choice flowers for which our rougher forefathers would have cared nothing. To show the contrast, however, between horticulture as practised when George III. mounted the throne and in 1891 we cannot take a more impressive fact than this, that conservatories were almost unknown in 1760. To gardens large and small there were often attached plant houses or greenhouses, but in most cases they were structures of a substantial sort, and some of them without glass roofs, and not very large windows. They were principally used for protecting tender plants and evergreen shrubs during the winter months. In the summer season their contents were removed to the open air, and the houses turned to other purposes. Sometimes they were converted into parlours or sitting rooms. Often the only warmth they had in winter was from an adjoining room, or they might be heated by an open fireplace, occasionally by a small stove, in which hot embers were placed. Cowper the poet describes in a letter his journeys late at night to the stove of his little greenhouse, making up the fire, so that it might keep in as long as possible. A few houses, and those mostly about London, were kept constantly warm by pipes and flues, contrived to circulate smoke or heated air. Of course there were forcing houses for the early production of vegetables, occasionally fruit, seldom flowers, but the heat in these was obtained, as a rule, by sinking the houses to the depth of some feet, and then surrounding the outside with dung or other manure. The idea of greenhouses and conservatories in which exotics might be nurtured all the year round, and which might be agreeable resorts, had hardly as yet developed itself in the mind of lovers of horticulture, but it was budding soon after George III. became king.

The modes of forming quickset hedges have lately been discussed in this Journal. It is well to remember that until the eighteenth century there were very few hedgerows in England for the protection of either gardens or fields. Had there been such generally during the times of the wars of the preceding century they would have considerably interfered with the rapid marches across country frequently made by troops. Arable and pasture lands resembled stretches of common, intersected only by ditches, and gardens where they were enclosed were shut in by walls of brick or flint, or by hedges formed of branches of trees stuck into the earth, which had to be frequently renewed. When quickset hedges were found to be more advantageous these were at first made promiscuously of slips taken from the woods, such as Sloe, Hazel, Crab, Elm, Dogwood, Willow, and of course Hawthorn; preference, however, began to be given to the last, and hence it got the name of "quick bush," because it was so often taken to form the basis of a quick or living hedge. Doubtless it was partly through the influence of the Society of Arts, which was founded in 1753, and which put prominently forward as one of its objects the encourage-

ment of tree and shrub planting, that hedges increased rapidly in numbers shortly after. In some parts of Kent we may even yet see a relic of a fashion of making hedges which had its admirers in Georgian times. They would now and then plant round a garden or shrubbery a double hedge; the outer one was Yew, Holly, or some other evergreen; the inner one usually Hawthorn. A narrow space was left between the two hedges, just sufficient to allow one person to pass along. Occasionally low hedges, kept well clipped, were introduced into the garden, round a grass plot for example, a gap being left here and there.

Our worthy great grandfathers, it may be noticed, rather ridiculed the style of gardening so characteristic of the Stuarts and the reign of Anne; unconscious that their own methods would furnish amusement to a later generation. A favourite plan of the Georgian gardeners was to place along the walks at irregular or regular intervals flower pots containing plants which had been housed during the winter. This might be well enough in broad daylight, but at the dusk of evening, when people, lovers especially, were taking quiet strolls, such articles were traps for a sudden and unpleasant downfall upon the path. The early English and the later Dutch or Flemish style might be formal, but there was at least a variety. They had then alleys, platoons (*i.e.*, square clumps), stars, circles, and single or double lines. The "magician" Brown, with his ponds, belts, and isolated trees or shrubs disregarded Nature entirely, and yet failed to produce anything pleasingly artificial. It is singular, too, that we find about the middle of last century just the controversy that we have been hearing lately as to the merits of the literal and the ideal in painting, and also in gardening. Price was a man who came prominently to the front in this discussion, and he, with his friends, who joined in the ridicule of Brown's formality and absurdities, went a trifle too far upon the opposite course while advocating the arrangement of gardens, beds, and shrubberies, so as to approach Nature as nearly as possible. It was argued by Price that pictures should be studied by gardeners. Artists, said he, observe form and colour, they select and combine, then fix upon the canvas what is most beautiful; we, when laying out gardens, must imitate them so far as we can. Subsequently his views met with hearty support from Richard Payne Knight, brother to the great horticulturist, who wrote a poem showing how gardens and pleasure grounds might be "unstiffened," though he did not, as his opponents declared, praise "Docks and Thistles, litter and disorder," because they might be pretty or romantic in a picture.

The first year of George III. must be always memorable for the fact that it is the date assigned for the origin of Kew Gardens, when that botanic establishment, now so important in the world, began to be spoken of as a garden acquired by the Dowager Princess of Wales, mother to the King. Previously the estate had belonged to Dr. Molyneux, a savant of the reign of George II., but who did not live to carry out his schemes at Kew. Under royalty a commencement was made by the erection of two conservatories of novel construction, and arrangements were made for the reception of plants from all countries.—J. R. S. C.

(To be continued.)

SYRINGING MUSCAT GRAPES.

As this important subject is brought to the front by an amateur correspondent who receives sound advice in your Editorial answer, accompanied by the intimation that readers are at liberty to state their views, I beg to offer a few remarks. Whenever Muscat Grapes fail to set satisfactorily, I am convinced that in the majority of cases the reason is either that the roots are in an unsatisfactory condition or that a sufficiently high temperature is not maintained at flowering time, or from both causes combined. If the roots and borders are in good condition and a temperature ranging from 70° to 75° at night and 5° higher in the daytime is kept up, the bunches will set well, either with syringing or without, provided the shoots carrying the bunches receive a sharp tap at midday when the temperature of the house is warm and dry, with a slight circulation of air. It is important also that on bright days the air should be increased early and the fire checked, so that strong sunshine and overheated pipes do not occur at the same time, but even on bright days a little heat should be kept in the pipes constantly. With this treatment the pollen will be dry and easily dispersed, either by syringing, shaking, or by passing the rabbit's tail over the bunches. I have on several occasions tried all three methods on different bunches in the same house, the set in each case being enough to form fine full bunches, but those on which shaking only was practised required far more thinning than the others. The greatest difficulty is generally experienced with the points of very large bunches. This can be obviated by tying the points up to the light, but then we find that the back of the bunches do not set so well; so now, in the case of large bunches, we tie the leaves back to

give all the light possible on both sides of the bunch, and draw the hand lightly down the points, the set in most cases then being excellent. But this difficulty is not experienced with smaller bunches.

Another matter that must not be overlooked is to examine the border just before the Vines flower, by thrusting a pointed stick or iron into it to the depth of a foot or 18 inches; if when withdrawn the soil adhering to it is damp and pasty, no water is required; if slightly dry, so that it crumbles when touched, give a thorough supply of water at about 80°. When the Vines are growing in narrow borders known to be filled with roots, give water before the soil gets into the state above described.—H. DUNKIN.

EARLY POTATOES PROFITABLE.

It has long been my opinion that too few of the short-topped quick-maturing varieties of Potatoes are grown in private gardens. Bushels, or even sacks as in our case, instead of about a peck or two ought in most instances to be planted annually, and this I assert after having tried what can be done both with and without much and from them. Doubtless the extent of ground devoted to early Potatoes is largely governed by the quantity of seed tubers in store, but they can be bought, and all the while so few are grown there will never be many saved for planting purposes. Once an extra effort is made, and larger breadths of Ashleaves for instance are planted, there will at lifting time be plenty for the kitchen and abundance for storing.

Many gardeners appear to be under the impression that early Potatoes are fit for use only when first lifted, whereas both Veitch's Improved and Myatt's Ashleaves keep admirably, surpassing in quality many varieties grown, especially for storing. I will go even further, and assert that if well moulded over and left in the open ground till the spring they will cook surprisingly well then. None of the later varieties lend themselves so readily to different forms of double cropping. Thus if either Mona's Pride, Old Ashleaf, Sharpe's Victor, Early Eclipse, and Veitch's Improved Ashleaf were planted extensively on a south border, the rows being 20 inches apart and the sets about 8 inches asunder, a quick, early, and by no means light crop could be cleared off the ground in time for it to be again cropped with either Strawberries, winter salading, late Peas, and Kidney Beans, somewhat later borders being also cropped with early Potatoes; the latter could be followed with either more salading, autumn Cauliflowers, and Broccoli. We are not content with a few dozen short rows of Ashleaves, but large breadths in the more open quarters are also cropped with Veitch's and Myatt's Ashleaves, these coming off in time for more Strawberries, Broccoli, Cauliflowers, Savoys, and Chou de Burghley to be planted; and Spinach, Turnips, and Onions to be sown. Nor do we stop at this. A considerable number of Brussels Sprouts are grown, or say not less than 1000 plants; but we cannot afford to devote the ground entirely to them for one season. At the same time they must be placed out early, and will not do well grown among Potatoes with vigorous haulm. The difficulty is overcome by arranging rows of Ashleaves 3 feet apart and planting between these, the Potatoes being lifted before the Sprouts require much room. The same plan is adopted with autumn Cauliflowers and Veitch's Autumn Broccoli, but it does not answer well with later Broccoli, these requiring firmer ground.

There is one serious drawback to these early Potatoes—viz., their great susceptibility to disease, but in two seasons out of three they mature and can be lifted before there is much disease about, and a bad failure rarely happens with us. We cheerfully run any risks there may be in the matter, and in good time shall plant quite as many if not more than usual of the best early sorts or those I have repeatedly named, well knowing that without them we could not keep up the requisite steady supply of vegetables of all kinds, and yet have plenty of Potatoes.—M. H.

A WALK IN MY GARDEN.

MARCH, 1891.

I DARE not say a tour in my garden, for then my poor prosaic utterances would be sharply contrasted with the charming and poetical book of Alphonse Karr's; although I often wonder what his garden was like, it requires but genius to invest any place with interest. There are many parts of Hampshire and Sussex quite as charming in their pastoral and woodland beauty as Selborne, but they have no Gilbert White—just as it is said there were heroes before Agamemnon, but they had no Homer to sing their praises. It has often struck me when looking at Alphand's book on the parks and gardens of Paris how much the ingenuity of painter and engraver can do towards making a pretty picture out of very little. And so it may be that Alphonse Karr's garden, although in the sunny south, has been invested by his genius

with an importance it would never have invested itself with in the eyes of one who had not known its historian. Be this as it may, mine is a very commonplace garden. It can boast of no order; flowers, fruit, shrubs, vegetables are all mixed together. I have never thought it well to try and lay it out afresh. I have made some few alterations, and have a lot of good and pretty things in it from the beginning to the end of the year, things which are not seen in any gardens about me, except where I have distributed them; and I can never go out into it without finding something to interest me, while the varying character of each year gives one something fresh to say even of the same things.

We have passed through a most extraordinary season. The long cold bitter weather of December and January was succeeded by the driest February on record. During the whole of the month we had not a single drop of rain; the days were beautifully clear and bright (read this, ye poor fog-poisoned Londoners!) while the nights were cold with white frosts, and there was no wind—and I believe these two causes account for the first thing which strikes one, the almost total absence of slugs and snails—the frost may have killed some, but I believe the hunger of the blackbirds and thrushes has had more to do with it.

I am reminded of this as I walk up the drive to the hall door. On the border, which is about 50 yards long, I made, after some attempts to grow other things, a rockery, and the plants have succeeded in it very well, some especially so; but I suppose, owing to its position and the shelter that the stones gave to the creatures, I have never been able to preserve the flowers of *Scilla sibirica* from the depredations of snails and slugs, but this year I found clumps of them where I had imagined they had disappeared. It seems to be an especially favourite morsel to them. On this rockery, too, are in full flower at this time quantities of *Cyclamen Atkinsi* and *vernum*. Not only have the planted corms succeeded, but seedlings have come up all over it, and this is, I think, a fair indication that the place suits them. They are baked in the summer, as this is the hottest spot in the garden. The drainage is good, and the roots of the trees in the shrubbery run under the rockery and give these plants what they desire. I had previously tried them in other places, but they did not succeed. This border has also now a good clump or two of the Winter Acenite, although its flowers are pretty well over; and, indeed, bright as they are, and prettily set in their fringed foliage, they are but short-lived. Here, too, are, of course, tufts of *Snowdrops*, both the old garden favourite and the newer and larger *Galanthus Elwesi*. I am not quite sure whether, after all, the old native variety is not quite as pretty as any of its foreign congeners. Here, too, patches of *Anemone blanda* are in flower, including a patch from roots sent to me from Smyrna, the flowers being much paler than those ordinarily seen. I do not know whether they will retain this character, but I have seen it somewhere noticed that this Asia Minor variety is paler.

On my other rockeries, small in extent, it is true, there are many things of interest in flower. Those delightful little clumps of the species of *Crocus* make them bright; *cæsius*, *pusillus*, *Aucherii*, *ochroleucus*, and *Imperati* being the most conspicuous. Then there is a delightful clump of *Saxifraga Burseriana* completely covered with its pure snow-white flowers, and nestling down quite to the ground, while the early period at which it flowers makes it especially valuable. Here, too, on the rockery, close to my study window, fully exposed to the sun, is *Saxifraga oppositifolia*, and its variety *alba* are creeping over and covering the ground. This is another plant which for a long time baffled me. I tried it over and over again, and always failed. As a last resource I put it on this rockery, and now it has grown and flowered very well. I made no special preparation for it, and I can only suppose that the situation had most to do with it; at any rate, it is now in great beauty.

Hepaticas seem to have done very well, and it seems as if the hard winter suited them. They were plants I could not manage, although I recollect as a boy that they grew like weeds in many gardens with which I was acquainted, and were abundant in cottagers' gardens. My plants are now doing well, *H. angulosa* both on the rockery and on the borders, while I have now nice clumps of the double red and single blue. I see, too, a flower or two of *Anemone pulsatilla* and *A. fulgens* showing themselves on a border edged by *Scilla sibirica*. I have some plants showing flower of a variety from Smyrna. I cannot say that I see any difference between it and the ordinary type; it is said to be more robust, but one can hardly tell that from imported bulbs. What they will be next year if let alone by the slugs is the point to decide. By-the-by, I find some people comparing them with *Chionodoxa Luciliae*, and giving the preference to the former. Now the comparison is a feeble one, to say the least. The two plants are quite dissimilar in colour. The *Scilla* is of a deep steely blue; the *Chionodoxa* bright cerulean blue and white. Then, again, the former is earlier, it is in flower sooner, while the *Chionodoxa* is only just beginning to show its buds above ground.

The border in front of my greenhouse, about 30 feet long, is now beginning to give us an intimation of what it will shortly be. It is about 4 feet wide, and over it are now in most admirable confusion flowering bulbs of *Galanthus Elwesi*; *Scilla bifolia*, the Smyrna variety, which is, I think, earlier than the ordinary one; this will not be in flower with me for a week. The *Narcissi* are rapidly making their way; the *Crocuses*, blue and white, are in flower; but I am looking for the long border, a foot wide, of the lovely *Chionodoxa*, which I look upon as one of the flowers of my small garden.

Outside my study window in the border is now a lovely plant of the

white *Daphne Mezereum*, every twig or branch of it one sheet of white flowers scattering its fragrance around. The ordinary form is very pretty, but not to be compared to this beautiful white variety. The long borders round the lawn are now all aglow with edging of the yellow crowns, beloved of bees, who are busy rolling themselves in its pollen-filled cups humming away in their intense delight.

None of these things have suffered from the long and severe frosts, but rather, especially the *Saxifragas*, seem to have enjoyed it. There are other things of which one thinks with a kind of shudder. Will they ever come above ground? That *Choisya ternatea* looks rather seedy, that *Agapanthus* is dead gone, although it has survived the winter. Will the *Montbretias* or the *Bravoas* survive it? One cannot tell, but I think I have shown that in a small garden one can, even at this early period of the year, find much to enjoy.—D., Deal.



LÆLIA ANCEPS.

AFTER the completion of growth this *Lælia* and its varieties will bear a lower temperature than they should be subjected to after they have flowered. We do not care to have them in a lower temperature at any time than 50°, and only in this for a short time. Frequently these *Lælias* are kept in too low a temperature throughout the winter, and they consequently start into growth much later in the season. A winter temperature of 55° to 60° is required according to external conditions. During sharp frosts we prefer to find the thermometer at 50° in the early morning rather than 60°. The temperature of the house may fall about 5° from 10 P.M. to 6 A.M., but the lower it is the more carefully must water be supplied. A low temperature and too much water mean ruin to the plants, or at the least result in a sickly yellow spotted appearance.

WATERING.

From the time these *Lælias* complete their growth, that is when the pseudo-bulbs are well ripened and the roots cease to extend, they need little water until they start again into growth, but they must be kept fresh and plump, and on no account should the pseudo-bulbs shrivel. Where the plants stand on a bed of ashes or other moisture-holding material they will not need water frequently. Open stages with pipes beneath are not suitable, the roots are unduly dried, and water is required too often to be good for them. Young roots starting freely from the base of the last made pseudo-bulbs and the supply of water may be gradually increased until the plants are growing luxuriantly, when it should be supplied liberally; in fact, they should never become dry until growth is completed, when the supply can be gradually decreased. Syringing amongst the pots twice daily, and more frequently damping the structure, combined with a slightly higher temperature at night and a considerable rise during the day by sun heat, will soon induce the plants to form roots and grow.

POTS, PANS, AND BLOCKS.

Lælias succeed well under all three conditions, but those grown on blocks require more attention in watering and syringing. Plants on blocks must be gently syringed once daily, and when they are growing fairly it should be done twice, except on dull wet days. If a little sphagnum has been used about the plants on blocks it helps to retain moisture about them. Let it be removed and replaced annually, just after the roots are observed to have started into growth.

Ordinary pots and plain pans are the best for these Orchids. Pans with large apertures of various shapes soon become objectionable, not so much from the pan itself turning green, for this takes place no sooner than those of ordinary make, but the crocks used for drainage turn green. *Lælia anceps* does as well in pans or pots suspended from the roof as when standing on the stage; in fact, we are inclined to believe the plants succeed better, provided they are not suspended too near the glass.

TREATMENT OF UNHEALTHY PLANTS.

It is useless to leave these plants in pots or pans with a large amount of material about them when weak and in an unhealthy condition. Very frequently imported plants are brought into this condition by placing too much moss and peat about them at the commencement, and then giving too much water. Unhealthy plants must be turned out and every particle of soil taken from amongst the few roots they may possess. They should be carefully pre-

served and the stems secured to a short but rather thick block of wood. Do not adopt the ordinary method of placing them on blocks if they are afterwards to be grown in pots or pans. If short blocks are used and the plants secured near the top or all round the top portion of the block they can easily, when well established, be placed into pots at any season of the year. No moss should be used about them, but syringe them frequently, and in a short time fresh healthy roots will be produced. Another plan is to secure them in pots filled to within half an inch of the rim with crocks and then suspend them until they are well rooted, when a little peat may be added. This is the best method of starting imported plants.

POTTING AND TOP-DRESSING.

Where the roots have commenced activity attend to potting and top-dressing. Those to be top-dressed should have all the surface-decayed moss removed, and some in a living condition supplied, peat in lumps, and charcoal, to which the roots cling freely. It is not advisable to use too much moss. Potting can rarely be done without breaking the pots or pans, and it is better to sacrifice these than to tear the roots in pieces or damage them for the sake of saving a few pots. Considerable care is needed, as no two plants will need exactly the same treatment. Where the material is good the surface is removed, the pot broken down to within a few inches of the base, allowing all to fall away to which no roots cling. The plants, crocks, and portion of the old pot is lifted into the larger one that has previously had a few crocks placed at the base, sufficient, however, to raise the plant to the desired height. The plant must be held carefully in position with the left hand, and the space filled round the portions of old pot to within 1½ inch of the rim. The surface layer may consist of charcoal in lumps. The remainder may be filled with fibrous peat with a few pieces of charcoal, using a little moss in patches near the surface. In other cases where the soil is much decomposed pick it carefully from amongst the roots, and if necessary wash out any small particles that may have collected about the charcoal and crocks. When well rooted, do not disturb the roots that are attached to the crocks and sides of the pots. When it is necessary to take the plants out entirely, the fresh pans should be recrocked the same as is necessary for imported plants until they are thoroughly established, when more soil may be added. This can be accomplished by using crocks and charcoal freely instead of peat, which can be removed at any time when more soil becomes necessary.—ORCHID GROWER.

BOMBAY GARDENS.

(Continued from page 192.)

HAVING shortly reviewed the different circumstances under which gardening is practised in Bombay, I shall try in the following lines to give a general outline of the most frequent aspects of Bombay gardens. Large gardens are but few, though it is not altogether rare that the compound is extensive, and by a comparatively small expenditure could be made sufficiently attractive to form a picturesque addition to the garden without exactly requiring the constant and, I regret to say, expensive maintenance necessary for a well-kept garden. I allude here chiefly to such compounds where large rocks or boulders present difficulties for building or levelling, or where *Toddy Palms* are retained on account of the profit they yield to the owner, or where the soil is not sufficiently deep to allow of cultivation. Though it is not uncommon that such compounds are naturally picturesque, there is still a large scope left here for the assistance of Nature by the work of the landscape gardener. Most gardens consist simply of a lawn surrounded by a drive leading to the bungalow, and shrubberies concealing the fences of the garden. This simple plan is often carried out with great taste, but in far too many instances the distribution of trees and shrubs is too absurd to please the eye, in which respect I shall only mention the very common practice of hiding the porch of the bungalow with a very dense screen of shrubs or even trees, a practice that may have certain advantages as securing privacy, but, on the other hand, has so many disadvantages that are quite sufficient to condemn it. In the first instance the circulation of air through the house is prevented, a very important consideration for the healthiness of the house; secondly, the view of the garden from the house is hidden, and part of the object of the garden consequently useless; and thirdly, the architectural features of the house, if of consequence, are entirely obscured from view. Privacy can be much more effectually secured by a moveable screen. Other gardens, happily now-a-days but few, are laid out in the native style with squares, diamonds, &c., and numerous pathways crossing each other at acute angles. This style, no doubt, can be made to look effective when planted and maintained with great care and attention; but I must admit that it has not been my fortune to come across a single instance of this kind of garden in Bombay in which the choice of plants corresponds with the style. Another style in very bad taste, where statuary, fountains, parapets, and other accessories of the garden are the principal features, is fortunately very rarely met with in Bombay, though objection may in many instances be taken to the various kinds of fountains, which, on the other hand, when tastefully

designed and appropriately embellished with plants are often very effective.

The lawn is now found in most gardens in Bombay, and as it is easily kept up and is delightfully green throughout the whole of the year, there are very few objects that serve better to give a charming relief to trees and plants. A few trees, a clump of shrubs, an ornamental Grass, a Palm or two when considerably placed, greatly add to the beauty of the lawn, and many good examples of this kind are found in Bombay gardens. A few flower beds in the lawn are desirable, when round or oval, plain in shape, but too often the beauty of the lawn is spoiled by the too great number of flower beds. Shrubberies are commonly separated from the roads either by a bit of lawn, which is undoubtedly the most effective, by a narrow grass border, or by a mixed border of flowering or foliage plants, edged with suitable plants. The above description refers to the commoner kinds of front garden only; besides this generally at least a small part of the compound is utilised as garden, either planted with fruit trees, or laid out in so many different fashions, that it is impossible to give a general description of them. Flower beds, clumps of hardy Ferns or various arrangements of plants in pots and tubs, often are prominent features in those parts of the garden. It is also here the fernery will generally be found. The Bombay ferneries are a peculiarity which deserves a few words. The fact is that the climate is so congenial for the growth of Ferns, that nothing more than a slight protection from the sun is generally wanted to make them succeed, though naturally an increased moisture of the atmosphere is beneficial and desirable. A simple shed constructed of rafters and roofed with a loose wove of coir matting answers all purposes, especially if the sides are covered with a light trellis-work covered with creepers. Though simple in construction, comparatively inexpensive, and cheap to maintain, such sheds can be made extremely picturesque, and their interior, when tastefully laid out, occasionally with the assistance of bits of rockery, old roots of trees, tanks or fountains, often bids fair to rival or even surpass the best conservatories at home. It is not a bad plan, as is sometimes seen, to leave the north side fernery open; it greatly adds to the attractions of the garden, and is perfectly safe as long as the cold north wind is in some way, as by a not too distant shrubbery, prevented from having direct access to the plants.

It is difficult to make only a limited selection among the great number of plants common to Bombay gardens of those that specially deserve to be pointed out as chiefly contributing to the peculiar charms of our gardens. I shall, however, seek to draw the line so as not to tire you by the enumeration of too many botanical names. The most striking of all plants in Bombay are perhaps our magnificent creepers. It is difficult to conceive an idea of a more gorgeous mass of colour than that displayed by the Bougainvilleas when in full bloom, and how many individual objections there may be to the particular colour of the commoner kind, nobody can seriously deny its imposing effect, and all will agree in admiring the brick-coloured variety. Not so evident on account of its shorter period of flowering, but perhaps more brilliant and graceful, is the vivid orange-coloured *Bignonia venusta*. Less striking but graceful and charming the *Antigonon*, with its masses of rose-coloured flowers. In the *Thunbergia grandiflora* and *T. laurifolia* the handsome large pale blue flowers are beautifully set off by dense and elegant foliage. The rare white-flowered variety is specially charming. The large white-flowered *Beaumontia* must be seen in flower to enable anybody to conceive its great beauty. Among the many *Ipomæas* or Morning Glory none is more striking than the splendid dark blue flowered *I. Leari*, though it is in certain respects surpassed by the rather straggling pale rose-coloured *I. carnea*, and cannot vie in beauty with the splendid dark crimson flowered *I. Horsfalliae*, which is still very rare in Bombay. A creeper which has flowered for the first time in Bombay this year, *Oclontadenia speciosa* (wrongly called *Bignonia regalis* in Bull's catalogue) bids fair to rank next to *Bignonia venusta* in beauty. It bears large clusters of *Allamanda*-shaped pale salmon-coloured flowers, and appears to be of a free-flowering habit. Nowhere, perhaps, is a greater profusion of flowers met with than in the handsome Rangoon Creeper, *Quisqualis indica*, a common inhabitant of our gardens. Less effective but still attractive are the different kinds of crimson and scarlet-flowered *Combretums* (*Poivreia*), the lovely sky blue *Jacquemontia*, the sweet scented May Creeper (*Vallis Heyni*), the Snow Creeper (*Derris scandens*), the Bridal Wreath (*Porana volubilis*), all with masses of white flowers, the well-known *Stephanotis*, the several Passion Flowers, among which the scarlet *Passiflora vitifolia* ought to be more commonly grown, the quaint but handsome mauve *Petræa volubilis*, and numerous other creepers. It must, however, be regretted that one of the commonest creepers of our jungles, the brilliant *Gloriosa superba*, is but rarely met with in gardens—a fact that may perhaps be chiefly attributed to the small attention paid to caterpillars by the *mallees*, as no plant is more liable to the ravages of these formidable enemies of our gardens. Other creepers are equally effective by the grandeur or elegance of their foliage, and none more striking or common than the magnificent *Pothos aurea* with beautifully golden variegated leaves, increasing in size towards the end of the shoots, or the beautiful *Monstera deliciosa*, with its large curiously lobed and pierced leaves, none more graceful than the charming *Vitis discolor*, with the dark purple silver-blotched leaves, or the beautiful metallic bluish-green *Selaginella laevigata*, which, however, only succeeds in perfect shelter and shade. The *Ficus stipulata*, which is a good substitute for our English Ivy, though having much smaller leaves, is occasionally met with, but nothing is in fact more suitable for covering the far too often unsightly compound walls. The graceful Cane Palm,

Calamus rotang—and the glossy-leaved Apple-scented *Artabotrys odoratissima* must also be mentioned as a favourite creeper, while the Elephant Creeper is chiefly remarkable for its rapid growth.

(To be continued.)

NARCISSUS BACKHOUSEI.

MANY beautiful hybrid types are now known amongst the Daffodils, and have either been obtained artificially or found in a wild state and introduced in this country. A fine form, named after Mr. W. Backhouse of Darlington, and appears to have resulted from a cross between *N. Pseudo-Narcissus* and *N. incomparabilis*, is that of which a flower is represented in the woodcut (fig. 43). Concerning this, Mr. Baker has given the following description:—

“Stature and leaves of *Pseudo-Narcissus*: Flower solitary, horizontal; tube obovate, about half inch long and broad; segments spreading

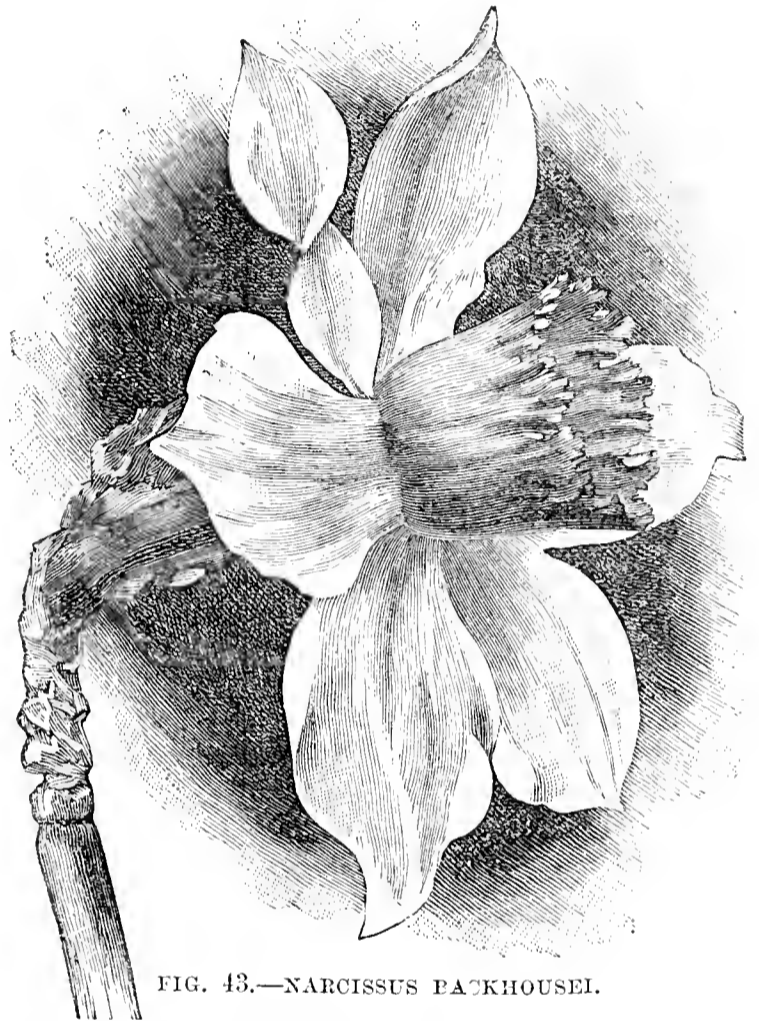

FIG. 43.—NARCISSUS BACKHOUSEI.

horizontally, oblong, imbricated, sulphur-yellow, 1-1½ inch long; corona lemon-yellow, a little shorter than the segments, with a deeply lobed plicate erect throat.”

The delicate colouring of the corona renders this Daffodil a favourite with cultivators.

SEEDS, THEIR GERMINATION, VITALITY, AND DISTRIBUTION.

[Read at Horticultural Club by Mr. GEORGE BUNYARD.]

FROM the child who in the budding spring sows his Mustard and Cress, to the gardener and amateur botanist, the growth and progress of seeds is most interesting, and the more one has to do with them the greater appear the differences in their aspect, size, and form. I propose first to give a few particulars on their germination.

It is well known how the larger forms start into growth. In Beans and Lupines they first swell out, then the outer skin bursts, and from the germ a root emerges and takes a downward course, while the fleshy part of the seed is lifted to the surface of the ground by a stout stem connected to the root, when the two halves separate and form what botanists call cotyledons, from between which the first leaves arise (fed by the fleshy cotyledons). In Peas the seed remains in the ground, and a stem rises and unfolds its green leaves very quickly. In both cases the cotyledons wither after they have performed their office of nourishing the first leaves. Wheat and other grains also remain in the soil. In the case of Palms such as the Phoenix (or Dates) the seeds often remain upon the surface attached to the plant for a year or more, and in Walnuts and nuts they remain below the surface. In smaller seeds such as Lettuce the root strikes down and the cotyledons carry up the outside skin as a covering, and in Onions it is curious to observe that the thin rush-like growth carries up the black angular husk in a twisted form and retains it for some time. In Turnips, Cabbages, and other Brassicas the cotyledons rise in a few days and at once spread themselves open on the surface. In some tropical plants most curious arrangements are observed; for example, in the double Cocoa-nut of

the Seychelles, which has been slowly germinating at Kew for two years, progress so far consisting of seed leaves each $2\frac{1}{2}$ feet long by 2 feet broad, a noble start for a tree which grows 100 feet high and does not produce flowers till thirty years old. The fruits are ten years ripening. It is to be regretted that the natives have so recklessly cut down the trees that, unless means be taken to prevent it, they may become extinct. I now hear this has been done.

In the Brazil Nut, which has a very hard outside shell, the triangular nuts are arranged round a central column, with a small hole at the stalk end. It is literally the survival of the fittest, for although all may start to grow only one can exist. The lucky one fills the space and kills the others, and feeds upon them until it can form a root for itself outside the shell, which operation possibly the restriction of the hole expedites by forming a barrier to the growth and thickening of the stem. There are many other curious forms of germination, and pretty experiments are made of growing Chestnuts and acorns in clear bottles of water, where the whole process can be watched. If you have ever placed Cress seed in your mouth you will find a gelatinous coating soon forms over its surface, which I take to be the first symptoms of growth. This is well illustrated by taking seeds of *Collomia coccinea* and placing them in water under the microscope, when small spiral threads freely rise from its surface, which unfold in the water. Sometimes Melon seeds will grow in the fruit, and peas in the pods in wet weather. *Mezereum* berries will also germinate on the tree in damp spots.

The period of germination is various. A few days will start some kinds, while others take a year or more. When *Primula japonica* was first introduced from Japan the seeds were a puzzle. In some cases a crop was obtained at once, in others a few came up and the rest twelve months after, and this is very common among many Alpine plants, being apparently a provision of Nature to protect the species from extinction. Hollies, Cherries, Roses, Plums, and Thorns do not germinate the first year, but require to be bedded in the soil a year, and they appear the second and even the third and fourth year according to the depth of sowing. Seeds of weeds lie dormant in a remarkable manner. For example, a wood may be grubbed up, and the year after will be covered with plants, some of which have possibly not been observed in that spot for years. An old man once told me that he grew some Turnips, let them seed, and then trenched the ground. Twenty years after he trenched the ground again, and the Turnips came up thickly. I have read that St. George's Hill, Byfleet, was covered with Scotch Firs, which in places were removed in order to plant shrubs, and in every such case the ground came full of Birch seedlings, whereas no one had ever seen Birch there previously. Evidently the remains of a former forest was disturbed. The cuttings of railways often reveal old beds of seeds, and vegetation appears new to the locality. The dredgings of wells also will produce plants which are strangers.

Various are the times at which Melons and Cucumbers cease to grow, I have known some ten years old grow better than seed of the previous summer. *Ecremocarpos* will often take a year to start. *Perilla* sown in February may not grow, but the same seed in April will germinate freely, as if certain sun power was required to promote vitality. Seeds which are oily keep their vitality best; and, in fact, if it were not for this fact many choice strains of vegetables would be lost to commerce after two or three consecutive bad frosts and harvests. The case of Egyptian corn is to the point. It is stated in the "Histoire des Plantes" that Wheat from an Egyptian sarcophagus started freely, but these cases are dubious.

Weber's experiments demonstrate that germination is quickest under dark coloured glass, and Pauchon found that black Beans germinate more quickly than white. Plants under the electric light at night grow much faster than without it, but electric force retards growth and germination in seeds. Trials at Baden-Baden show that when seeds are thoroughly ripened and dried they can endure 248° of heat without injury, but that after this desiccation they lose vitality when moisture is added in excess, and this is traceable to the same cause (rupture of cells) which kills plants in a severe frost. In the tropics the native seeds keep for a long time because they are thoroughly ripened and their tissues firmly set by the solar heat. European seeds soon lose vitality there; in fact tropical seeds keep as many years in Europe as European ones do months in the tropics. Ripeness is essential to vitality, as in a bad harvest year Peas, Beans, &c., often fail to grow—and one year, a very hot one, we grew a great crop of Kidney Beans, which from some cause only grew about 50 per cent. *Poinciana regia* seeds sown from the same pod have germinated at once, and others took a year. Oranges, Lemons, &c., are said to germinate best in their pulp.

Haricot Beans from Tournefort's herbarium germinated after the lapse of 100 years. Pouchet states that Heliotrope, Lucerne, and Clover seeds taken from a Gallo-Roman tomb germinated after the lapse of 1500 years (?). Lindley is stated to have raised the Raspberry from seeds taken from a Celtic burial ground 1700 years old. On the other hand, many seeds lose vitality quickly, such as Hollyhock, Polyanthus, Marigolds, Myosotis, Digitalis, &c. The Coffee berry is said to lose its germinating power in a few days in its native land. When *Linum grandiflorum* was new it was found slow to germinate, and experts recommended soaking it in milk or warm water. In like manner late crops or catch crops (where the first have failed) may be forwarded by soaking them and drenching the trenches before sowing the seeds.

I now pass to seeds assisted in germination by various agencies. Some seeds are very hard, as the Canna or Indian Shot, also some tree seeds of the Leguminosæ. I imagine many of these are aided in germination by passing through the gizzards of birds which, to some extent, remove the

outer cuticle. The Sacred Lily of the Nile (*Nelumbium*) was a long time before it could be grown from seed, and I am told by Mr. John Lee that for two years they remained dormant in a close stove till some were filed and notched, when they started into growth. Many tree seeds are drawn by worms beneath the soil and terminate there. You must have seen the frequent wormcasts beneath the Sycamore and the Ash trees on lawns; these seeds have wings which help to distribute them through the winds, and those of the Ash and Maple are also conspicuous. Linnaeus ascribes the introduction to Europe of *Conyza cœrulea* from Canada to the action of the Atlantic winds. It is now a troublesome weed in the north of France; and it is said that the soil of Spain after an Atlantic hurricane is often strewn with seeds from America. The wind is said to lift up an edible Lichen from the mountains of Central Asia, which at first is only the size of a pin's head, but on reaching vapoury clouds grows to the size of a Walnut, and often fall in desert spots to the great joy of the inhabitants. Possibly the Manna of old may be referred to a storm of this kind.

Among the most active agencies are those of birds, which devour fruit, and cast out the seeds in the hedgerows where they roost; quite a collection may be found in the hedges near fruit grounds, and many good kinds have thus originated as well as by the fruits being stored by mice. The Diamond Plum of Kent and the Farleigh Damson are examples. It is related that the Dutch in former times destroyed the Nutmegs in several of the East Indian Isles in order to create a monopoly in Bahama. This clever trade speculation was frustrated by the pigeons coming in flocks to devour them in Bahama, and, flying home with their crops full, they soon replenished the islands, as only the mace served for food, the kernel resisting their gizzards. I fancy in this case the pigeons must have been very large, or the Nutmegs rather small, but Mr. D. Morris states that they cast up the Nutmegs. In Java a species of civet disseminates the Coffee plant in the same way. Pouchet, to whom I am indebted for several interesting facts, states that the Indian Poke plant (*Phytolacca*) was introduced as a garden plant to Bordeaux for the purpose of colouring wine, whence the soft-billed birds scattered it throughout Southern Europe up to the Pyrenees.

In Ceylon the magpie is protected, as it is the sole agent in propagating the Cinnamon tree. Birds often carry to Iceland from Greenland and Northern Europe numerous plants native in the latter countries; again, seeds of grasses and weeds are widely distributed by the soil which balls on birds' feet in wet and frosty weather. It is also well known that many seeds pass through animals uninjured, and thus they in a wild state scatter many species far and wide. I have seen enumerated by Darwin, but cannot now recall them, a vast number of species raised from a ball on a partridge's foot. I need here only allude to tropical seeds brought even to Norway by the Gulf stream, and by those distributed by floating on rivers and streams. The Cocoa-nuts of the Seychelles before alluded to, protected by their massive coverings, travel 400 leagues to the coast of Malabar, lending colour to a local legend that they are formed and grown in the depth of the ocean, "the *Cocœ de Mer*." Himalayan plants are thus transported and bloom in the Delta of the Ganges. Other seeds attach themselves to the coats of animals. Wool imported from South America has also been the means of introducing several Mexican plants to Montpellier in France. The wind is a great agent in scattering such noxious weeds as Thistles, Colts-foot, and Dandelions. In fact, I think the law ought to compel the owners of railway banks and waste spaces to burn the weed-flying seeds. I have a spot in my native town in view where there are enough Thistles to stock the country.

The seeds of the Water Lily are enclosed in a transparent sac, and when the seed pod is ripe it bursts, they float on the surface, and scatter themselves in all directions. As illustrating the distributive agency of birds and mice any ancient building or garden wall will give numerous examples of trees and plants sown by birds, as Gooseberries, Currants, Raspberries, Blackberries, and nuts, and frequently Yews and Pines. At the ancient seat of the Frewen family in Sussex there used to be a Scotch Pine at the top of the topiary garden wall on the left side of a doorway, which had by capillary attraction forced its roots down between the door frame and the brickwork, so that it had an aerial root of 7 feet long, displacing the door frame. In old orchards it is commonly the case to find Elder, Gooseberries, and Currants growing in decayed trunks. A friend sent me a cutting of an Irish paper with such an example, and said we could not beat three kinds of fruit on one stem even in the "Garden of Eng'land."

At Gordon Castle the late Mr. Webster notes that a large Ash had a hole some height above the ground, and when the tree was taken down eight Hollies, a Gean, two Whitethorns, and an Elder had rooted, and found a home in the aperture. Church towers and buttresses often show quite an herbarium on their older portions, and sometimes these get so large that they have to be removed. This I am told was the case at Oswestry, where, after hewing off the branches, it started again from the roots, which had possibly become established in the rubble which our forefathers were wont to build in their towers. An Italian author, "Sebastian," states that 261 distinct plants may be found growing upon the ruins of the Coliseum at Rome. Mistletoe is well known to be attached by birds, which plant it on the boughs in their endeavour to get rid of the viscous matter which sticks to their beaks when eating the seeds. The mistle thrush on being disturbed (like the fieldfare) makes for the tallest trees, thus we more often find Mistletoe upon the Italian Poplar than any other.

I have alluded to the atmosphere as a means of distribution. We

are scarcely aware of the millions of germs of Fungi, Lichens, and Fern spores which fill the air at all times, but only germinate on finding a suitable home. For example, in a chalk district where Ferns are rare I once saw a well which was clothed a few feet down with innumerable small seedlings of the Hart's Tongue Fern, and from my knowledge of the locality none grew near for miles, at least in a wild state. We are all sensible of a dusty smell in entering a fernery or greenhouse. This arises from the presence of spores in the air, and is in consequence more noticeable in the summer months. These spores travel unnoticed, and soon cover any damp spots with their lovely, if miniature and sometimes microscopic, vegetable forms.

As showing how aspect affects vegetation, the stone walls which abound in Devonshire will be covered on the sunny side with *Asplenium ruta-muraria* (Wall Rue) and *Adiantum-nigrum* (Spleenwort), while the shady side is beautified by the *Scelopendrium* and Lady Fern. The germination of the spores of Ferns is very interesting. At first a small, filmy green spot appears (called a prothallus), from which in due time at the edge a future Fern starts on its humble life. It is said that lime is absolutely essential to the growth of certain seeds, and that in its absence they fail to grow, while others are killed by it. The application of certain manures will sometimes give extraordinary stimulus to hidden seeds, as when wood ashes are put on grass Trefoil and Clover appear as if by magic; possibly they need alkaline properties to make them germinate. In reference to the presence of seeds in the soil, Mr. Maries recently stated that *Primula obconica* was obtained by chance in some earth he collected beneath *Primula* stems in Japan, which he brought home and exposed in a greenhouse.

I must now conclude this paper, and if I have in any way excited interest in this matter my hearers are assured that I have barely touched the fringe of my subject, and that in this (as in all the open books of Nature), further search and inquiry will lead all humbly to acknowledge that, "He doeth all things well," and carry them back to the book of Genesis, where it is recorded that the Creator's fiat went forth for the virgin earth to bring forth the "herb bearing seed and the fruit tree yielding fruit," and the same regular cycle of growth, maturity, and reproduction obtains till the present day.

A very interesting discussion followed. Mr. Cousens exhibited a curious flat-clawed seed pod like a crab, about 5 inches across, with seed vessels in the centre, which had been taken from Australian wool. Mr. D. Morris referred to the successful shipment of Gambier he had just accomplished, and considered that the electric light at night had assisted the plants to retain their foliage. He also gave the *modus operandi* in forming new plantations of Pimento. The landowner clears a space of the larger trees and allows the scrub to grow up unchecked, and in about two or three years there is cover for the birds, which, after eating the fruit, pass the seeds through their bodies, and they soon take root, and the owner then thins them out at the proper distance, when a plantation is established in about five years; some process of fermentation being necessary for starting of the seed. It was generally agreed that the supposed growth of mummy Wheat had been fully exploded, and M. Vilmorin's experiments were considered to have finally settled the question. It was also stated that the *Opuntia* had been distributed all over St. Helena in the town refuse by which the land was manured. It was also noted that the Foxglove (*Digitalis*) invariably came up where forests had been fired; but it was an open question whether the potash in the ashes or the letting in of light and air brought this about. It was stated that in some old hill pastures Charlock came up freely where it had never been seen before, and this obtains on the chalk hills of Kent.

THE ARRANGEMENT OF HOT-WATER PIPES.

THE best mode of arranging hot-water pipes in fruit and other houses has been discussed many times in gardening journals. In the *Gardener* for 1879 a lengthy discussion was carried on, but, like many subsequent controversies on this subject, without any definite conclusions being arrived at. Those interested in the matter, and who have access to this publication, may do well to peruse the articles it contains on "Heating by Hot Water."

The only points where "Heating Reformer" (*Journal of Horticulture*, present volume, page 179) differs from those writers are the arrangement of pipes over the Vine borders at intervals of 2 feet, and the employment of only one return pipe for every five flows. The objection which Mr. Divers (page 210) raises to this system is full of sound judgment. I doubt whether many gardeners would consent to the pipes being arranged over the borders in this manner. Surely "Heating Reformer" could find some better place for his pipes than the surface of the border, which requires so much attention. We believe that the primitive arrangement which "Heating Reformer" condemns is likely to prove a less evil than the system he advocates. If a vinery is fitted with two rows of pipes at or near the front, and the same quantity from the middle to the back of the house according to the way the house is arranged, there need be no attacks from red spider if the house is properly attended to.

I have no experience of five flows being provided for each return pipe—nor want; but I was employed some years ago as a journeyman where three flows were worked for a time with only one return. This answered in a vinery near the boiler, but proved a failure in an early Peach house at the other end of the same range. In this house

circulation was almost at a standstill in the early part of the year, when an uniform temperature was required. The substitution of a return pipe for each flow proved a remedy. It is not likely that five instead of the three flows to each return pipe would have mended matters. The use of three flows to each return pipe does not answer in a stove or other equally warm plant house at any great distance from the boiler. The importance of carrying mains outside the structures to be heated is a matter that cannot be too strongly impressed upon gardeners.

Respecting the desirability of having both flow and return pipes fitted with valves, I may say that I am now suffering from the inconvenience caused by valves being fitted to the flow pipes only. Where the house happens to be near the boiler the temperature is at no time entirely under the control of the gardener, a state of things that is by no means pleasant.—W. R. WILLIAMS, *Great Marlow*.

I CAN assure Mr. Divers there need be no difficulty whatever in renewing Vine borders with the pipes arranged in a manner as described by me on page 179. Had he called here in the month of October three years since he would have seen work going on in such a manner that he must have confessed there was no difficulty in getting fork, spade, or shovel through the 2 feet space between the pipes. We find no difficulty either in tipping a wheelbarrowful of soil between the pipes in making up the border, and one could not wish to do more than that, it not being usual to have carts inside ordinary vineries. As we do not expect to have to renew the borders again for another ten years at least I do not think it would be wise to have the hot-water pipes arranged in a mass along the front, or indeed in any other part of the vinery, merely for the sake of an imaginary difficulty. Surely this is but a weak argument to advance against the distributing plan of hot-water pipe arrangement. So much for the matter of convenience in renewing the borders.

Mr. Divers says there is "not a great number of feeding roots close to the stems of the Vines." Does he not think this is owing to the faulty method of clustering the pipes near to the front of the house, and consequently near to the stems of the Vines, as they are generally situated at the front of the house? because he says that "several pipes at the front of the house often dry the border very much." Now I have always been taught that "borders which are dried very much" are not likely to be well furnished with feeding roots, owing, of course, to the lack of moisture. My experience leads me to say that there is a goodly number of feeding roots close to the stems of the Vines. This fact of the roots being more evenly spread over the border—that is, close to the stems of the Vines as well as farther away from them, may be attributable to the plan I advise and practise of spreading the heat in a more equal manner over the border, thus avoiding drying the border very much by clustering of the pipes in one particular place. Surely, Mr. Divers, you are assisting my argument considerably as to the utility of the plan in arranging the hot-water pipes as far as the welfare of the Vines is concerned, and that I take to be of more consequence than the mere convenience of renewing the border, say once in a dozen years. Even then it is but a small affair in willing hands.

With regard to the thorough manner in which the water will circulate through five flow pipes into one return, Mr. Divers may rest assured that the plan is perfect. If he has the wish to put it to a test he can have the opportunity by calling here at any time. The Editor will, I have no doubt, give him the route, and vouch for the welcome he would find, as he knows quite well that I have not the slightest qualm about giving a practical lesson in heating a vinery on the "spreading out" system.

Regarding the case of insufficient circulation which is quoted, and which Mr. Divers had to deal with, I cannot of course say anything, not knowing the circumstances, but should say that the plan previously was a faulty one. I have not yet known an instance where the return pipes exceed the flow pipes in number, and have not a word to say against the plan if it answers.

Perhaps I might venture to suggest that "some of the finest fruit in the kingdom," which is grown in houses heated in the manner I describe as being "most objectionable," is ripened later in the year than I name—June. In that case the evil of clustering the pipes together along the front of the house is not nearly so great, because much less heat from the pipes is required to maintain the necessary temperatures for Grapes, which are ripened later in the year—say during August and September for instance, the reason for which is obvious.—HEATING REFORMER.

AUCHENRAITH.

To realise fully how great is the pleasure which a garden affords one must not go to a big show place with its acres of glass houses and gardeners by the dozen, but rather turn to one of those snug enclosures which surround the homes of the middle class, whose owner has sufficient means and leisure to obtain what he wishes, with ability to manage his own garden. More than this, he must have that taste for gardening which is inborn, together with an intimate knowledge of horticulture and a sufficient acquaintance with arboriculture to insure a judicious selection and tasteful arrangement of his trees and shrubs. Above all he must really love his garden, and be on terms of close intimacy with every plant in it; for the true enjoyment of a garden comes not from the mere possession of wealth and the power it gives to purchase treasures rich and rare from the teeming stores of Flora and Pomona. Each denizen of it must have its history, must speak to its owner in a language which

he alone understands, recalling to memory many a dear friend, many a pleasant incident of the chequered past.

These are the gardens one specially likes to visit; but to enjoy them fully the owner must be present, for his has been the mind to conceive, the hand to evolve the fair scene, and who can do the honours of his garden or call attention to its treasures so well as himself? When I called at Auchenraith with my old friend, Mr. J. Wright, it was our good fortune to find its genial owner, Mr. William Marshall, at home, and to see his garden with this true friend of gardeners. A staunch and well-tried friend indeed is he. He has long been known as a very active Fellow of the Royal Horticultural Society, who has served on the Council, and to whom was mainly due the success of the great provincial exhibitions held at Bath and other places several years ago. At the present time he is Chairman of the Floral Committee, and is also Chairman of the Gardeners' Orphan Fund. Moreover, it was through his exertions mainly that the United Horticultural Benefit and Provident Society was established on such a safe and sound basis, and a handsome illuminated address from the members embodying that fact and recognising his services has a position in his library.

Standing close by one of the main roads of Bexley, Auchenraith, like most suburban houses of its class, has its carriage drive and plat of turf at the entrance; but, unlike most of them, this space has been turned to account and made really attractive. A sloping bank of shrubs makes a screen by the public road that is altogether devoid of heaviness or formality. Numerous shapely specimens of Holly at each end show by their healthy gloss and free growth how well they are adapted to the locality. At the foot of the slope on the turf that queen of British aquatics *Nymphaea alba* is well established in a pool of water, which Mr. Marshall would like to enlarge to gain space for other water plants, but he cannot well do so without giving undue preponderance to the pool, which is now in admirable proportion with its surroundings. Most interesting of all was a bed of miniature specimens of *Coniferae*, each plant a gem of exquisite symmetry and perfect health.

That is the way, the only way, in which Conifers should be used in such a position. As winter denizens of bed or border they impart such an air of warmth, fulness, and beauty, as nothing else can do. But they must be regarded only as transitory, never as permanent occupants there. The common mistake is made in planting them in front of and very near the windows. Nor can one wonder at this, for most of them are so elegant and symmetrical when quite young, that for a few years nothing can look better there. But they invariably become too large for the position, towering aloft, and with wide spreading branches they dwarf their surroundings and darken the rooms, becoming a sort of white elephant which the puzzled owner neither cares to keep nor get rid of. Sometimes a compromise is effected by trimming the stem of branches sufficiently high up to admit plenty of light into the rooms, the effect of such trimming on most Conifers being to render them most unsightly objects. The only thing to do is to harden one's heart, cut them down, and replace them with something that is not likely to become a nuisance.

But I am lingering unduly at the door of hospitable Auchenraith, and must note our regret on entering the garden to be confronted by evidence of the baneful effects of the long hard winter. A Passion Flower that had covered one side of the house, a pair of fine specimen Bays, Pampas Grass, and double Gorse were all killed. The size to which all of them had grown was the best evidence of the rarity of such severe weather in Kent, and the only thing to do is to plant others, and take what comfort that can be had from the beaming countenance of the nurserymen to whom Jack Frost has brought such good fortune. The *Passiflora* had been wisely replaced by the more hardy *Wistaria*, equally remarkable for rapidity of growth, and I would suggest *Clematis montana* as a suitable associate. It is quite hardy, attains a large size quickly, and is perfectly lovely in spring with its dense clusters of pure white flowers, forming a charming contrast to the pale blue racemes of the *Wistaria*.

The garden contains a fine collection of choice hardy plants, new and old, with all which Mr. Marshall is evidently well acquainted. He is justly proud of his *Delphiniums*. His collection of *Daffodils* have special quarters assigned them, and his alpine plants had become so crowded that he was enlarging his rockery with some fine pieces of Kentish ragstone brought from Maidstone, much more attention being given to the provision of snug quarters for the plants than to an effective arrangement of the stones; but if Mr. Marshall is so successful in the treatment of the plants as to cause them to overrun the bounds assigned them, the result can be no other than satisfactory, for it is the plants, and not the rocks, that will be the chief attraction.

He is evidently a lover of Ferns, much of the space under glass being given to them, and many of them being exceptionally fine specimens.

Beyond the garden there are pleasantly secluded wooded walks, just a bit of wild woodland that is an agreeable surprise in such a position. In one corner of it is an irregular hollow, which is probably a disused gravel pit, where the common yellow Broom and a growth of Blackberries were predominant. A few touches only are requisite to make this hollow a most attractive feature:—Some of the Brambles cleared away, the Broom retained, and wrought into a tasteful combination with *Rhododendrons*, *Mountain Ash*, *White Broom*, *Gorse*, *Holly*, *White Birch*, and *Pampas Grass*. Evidence of the possibility of this was afforded by the flourishing appearance of a group of *Rhododendrons* at another part of the wood. If this suggestion is acted upon I shall in some measure have repaid Mr. Marshall for the very kind and courteous reception which he gave us.—EDWARD LUCKHURST.



THE WEATHER IN THE SOUTH has been changeable and the wind cold with low night temperatures, but the days have been clearer though snow has fallen in small quantities. The ground is still cold, but has dried rapidly since the departure of last week's snow.

— THE WEATHER IN THE NORTH, MARCH 16TH TO 23RD.— A week of fine weather generally; high east winds, with showers in the beginning, afterwards bright coldish days; frosts of from 2° to 5° on three nights, and one or two beautiful sunsets. This morning it has begun to rain with a falling barometer.—B. D., *S. Perthshire*.

— GARDENING APPOINTMENT.—Mr. Constantine Hibbert has been appointed head gardener to Madame Adelina Patti Nicolini at Craig-y-nos Castle, near Swansea, Mr. Jones, the late gardener, having been appointed steward to Col. Wynne Finch on one of his Carnarvonshire estates. Mr. Hibbert was foreman to Mr. Jones previously.

— THE SCHEDULE OF THE EXHIBITION AT THE ROYAL AQUARIUM FOR 1891 comprises particulars of the classes and prizes at the spring Exhibitions on April 29th and 30th. The summer Show on May 20th and 21st. The Rose Show on June 24th and 25th; and the fruit Show on October 14th, 15th, and 16th.

— CINERARIAS.—Are *Cinerarias* generally deteriorating in quality, in size, colour, and markings? My own, and my near neighbours' strains, all from different first-class houses, are this year markedly inferior to the strains from the same respective houses in past years. Along with the inferiority in bloom, there is a lankiness of growth which is by no means a merit, and makes one wonder where those dwarf forms, with small leaves covering the pot almost, are gone to.—A NOTTS GARDENER.

— THE schedule of the THAMES DITTON HORTICULTURAL AND INDUSTRIAL SOCIETY for 1891 which is now issued contains, in addition to prizes confined to the district, valuable prizes open to all comers. These are presented by Messrs. Sutton & Sons, Reading; the Native Guano Company; Messrs. J. Peed & Sons, Roupell Park Nurseries; Lewis & Williams, Thames Ditton; Carter, Page & Co., London; and Barr & Son, Long Ditton Nurseries. The Hon. Secretary is Mr. W. Palmer, Thames Ditton House, Thames Ditton, Surrey.

— PRIMROSES AND POLYANTHUSES.—The strains of both Primroses and Polyanthuses are now very superior to the older forms, and are very effective in beds or borders during the spring months. In order to have extra strong plants fit for the beds and borders next autumn the seed should be sown in pans or boxes of fine loamy soil, and placed in gentle heat. A strong heat, such as that in Cucumber beds or forcing houses, will not do, a partially exhausted hotbed or even a close frame being much preferable. When the seedlings are large enough prick them out on somewhat shady borders, or say between fruit bushes alongside kitchen garden walks. From there they may be transplanted to their flowering quarters next autumn.—J.

— BOTHWELL BANK AND PRESIDENT STRAWBERRIES.—Is Bothwell Bank Strawberry President under another name? I have grown it for several years, but cannot distinguish it from President in either foliage, appearance of fruit, or flavour; it also ripens at the same time. It would be interesting to know if it is a seedling of Mr. Chisolm's (the gardener at Bothwell Bank) own raising or merely a find like some Strawberries that could be named. In my own practice I have had several seedlings that I could not distinguish from President, but President was the seed parent. If a seedling is not distinct from and better than any other of its class, I should not give it a distinct name. Waterloo is a good late Strawberry, but its mulberry colour is against it to take well with us as a market fruit. Frogmore Late Pine and its allies are too late for us to be profitable. Other fruits are getting plentiful by the middle of August, after which the palate is cloyed with Strawberries. Can a Strawberry be had to ripen at the same time as Waterloo with the flavour and colour of President?—G. MCDUGALL.

— GARDENERS' ORPHAN FUND.—Efforts are being made to hold a floral fête in the Crystal Palace in July next in aid of the Gardeners' Orphan Fund, instead of in Covent Garden Market in May.

— WE are desired to state that on the occasion of the retirement of Mr. F. C. GOODCHILD from the position of Secretary of the Nursery and Seed Trade Association, Limited, the members presented him with a dining-room suite in token of their appreciation of his services.

— IN response to the invitation of several members of County Councils, the BRITISH FRUIT GROWERS' ASSOCIATION has made arrangements for delivering the following course of six lectures in any part of Great Britain:—First, The Principles of Vegetable Life; second, Soil Constitution, and Management; third, The Culture of Apples and Pears; fourth, The Culture of Stone Fruits; fifth, The Culture of Small and Bush Fruits; sixth, Gathering, Packing, Marketing, and Preserving Fruits.

— WARE AND DISTRICT HORTICULTURAL MUTUAL IMPROVEMENT SOCIETY.—A meeting was held by this Society on the 17th inst., when Mr. G. Gordon gave a very interesting and instructive lecture on "Wall Fruits." There was a good attendance, and Mr. Stanley Gray occupied the chair. The lecture was illustrated by diagrams showing the various plans for walls, modes of training, and appliances for protecting the trees. The subject was treated exhaustively, and at the close questions were asked by some of the members, to which Mr. Gordon replied. A hearty vote of thanks was unanimously accorded to Mr. Gordon for his admirable lecture, and a similar compliment to the Chairman brought a successful meeting to a close. At a meeting held previously it was resolved, on the motion of Mr. Alexander, "To admit boys between the ages of ten and fourteen free to all the meetings, such admission to be conditional upon their being introduced by an adult member."

— PRESTON AND FULWOOD HORTICULTURAL SOCIETY.—The thirteenth annual spring Show of the above Society was held in the Public Hall on Wednesday and Thursday the 18th and 19th inst., and it is a noteworthy fact that each year reveals unmistakeable evidence of additional support by the attendance of the leading ladies and gentlemen of the district at the opening ceremony, which was performed by the President, W. E. M. Tomlinson, Esq., M.P. Mr. Atherton, the Hon. Secretary, and the other officers, deserve the highest praise for the success which has once more attended their efforts in trying to establish in Preston an annual display of spring flowers. The number of entries this year exceeded those at any previous show, and the exhibits generally were of the highest order. Hyacinths and Tulips have been seen better and in larger quantities, but the excellence in other classes made up for any deficit. The magnificent display of Orchids set up by Mr. Beddoes, gardener to E. G. Wrigley, Esq., Howick House, Preston, was the greatest and most attractive feature of the whole Show, and this fact was very kindly alluded to by Mr. Tomlinson in his opening address. A second prize group of Orchids was also the subject of much comment. These were grown and exhibited by Mr. Charles Parker of Oxford Street. The Orchids were arranged on a groundwork of Virginian cork, with Ferns and Selaginellas tastefully interspersed amongst them; the whole having a novel and pleasing effect. The miscellaneous groups were well arranged, and comprised some grand specimen plants, both in flower and foliage, beside the hundreds of smaller, though rich and choice examples. The principal prizewinners were J. B. Dixon, Esq.; Messrs. Beddoes; Frisby, Worden Hall; Mr. Williams, The Priory, Penwortham; Mr. Lamb, Dilworth House, Longridge. In the nurserymen's class Messrs. E. Payne, Spelman, and Morley & Co. were the principal exhibitors. Mr. Payne's group of plants was an especial attraction. Some well-flowered Azaleas were noticed in two classes.

— ROYAL METEOROLOGICAL SOCIETY.—The usual monthly meeting of this Society was held on Wednesday evening, the 18th instant, at the Institution of Civil Engineers, 25, Great George Street, Westminster, S.W., Dr. C. T. Williams, Vice-President, in the chair. Mr. H. Brevitt, Mr. J. Lovel, and Mr. L. G. Oliver were elected Fellows of the Society. Mr. G. J. Symons, F.R.S., read a paper on the "History of Rain Gauges." It appears that Sir Christopher Wren, in 1663, designed not only the first rain gauge, but also the first recording gauge, although the instrument was not constructed till 1670. The earliest known records of rainfall were made at the following places:—Paris, 1668; Townley, in Lancashire, 1677; Zurich, 1708; and Londonderry, 1711. Mr. Symons gave a very full account of the various patterns of rain gauges, and in most instances

pointed out the merits or defects of each. Mr. A. W. Clayden, M.A., showed on the screen a number of interesting transparencies of photographs of clouds, lightning flashes, and other meteorological phenomena. The meeting was adjourned at 8.30, in order to allow the Fellows to inspect the exhibition of rain gauges, evaporation gauges, and new instruments, which had been arranged in the rooms of the Institution.

— THE SHROPSHIRE FLORAL AND HORTICULTURAL SOCIETY.—The spring Show of this Society was held on the 19th inst. in the Music Hall, Shrewsbury. Numerous exhibits of an exceptionally interesting character filled all the available space, and it seemed to be the general opinion that the Show was a distinct improvement upon those of previous years. The energetic Secretaries, Messrs. Adnitt and Naunton, greatly contributed to the success. In the open classes the competition was strong, Colonel Wingfield, Mrs. Jason, and J. R. Greatorex, Esq., securing the chief prizes, whilst gentlemen in the district contributed materially to the Show with good exhibits of Azaleas, Cyclamens, Cinerarias, Rhododendrons, and Callas. Some really good exhibits in the amateurs' classes came from the following exhibitors:—Messrs. Burr, Loylor, Wyley, Patchet, and others. Passing to the non-competitors' and trade growers' exhibits, Messrs. Pritchard & Sons, Shrewsbury, contributed a very fine exhibit some 40 yards by 6 feet wide, also two fine wreaths and sprays. The collection was honoured with a special certificate. Mr. E. Murell also received a similar award for a fine bank of plants. Messrs. Jones & Sons contributed effectively; and last, but not least, Messrs. Dickson, Limited, Chester, had a remarkably fine display of Narcissus and other bulbs, making altogether a very fine exhibition.—C. R.

— THE name MAXIMOWICZ is familiar to horticulturists, and the following particulars, condensed from a long notice in *Nature*, respecting this great naturalist will possess some interest:—Carl Johann Maximowicz, who died at St. Petersburg on February 16th, after a few days' illness, was born at Tula in 1827. He went early to St. Petersburg, where he was brought up at the St. Annenschule, a renowned German Lutheran College. In 1844 he left the Russian capital for the University of Dorpat. After completing his studies, he was appointed director's assistant at the botanical garden of Dorpat, a post he held until 1852, when he was made Conservator of the Imperial Botanical Garden at St. Petersburg. The following year he set out on a voyage around the world on board the frigate *Diana*, his chief task being to make acquisitions of living plants for the botanical garden at St. Petersburg. The *Diana* visited Rio de Janeiro, Valparaiso, and Honolulu. But when war was declared by the Western Powers against Russia, she was compelled to call at the nearest Russian harbour, De Castries, on the coast of Manchuria, at that time the youngest, and scarcely an organised, Russian colony. Maximowicz had to leave the frigate, and decided at once to go up the River Amur, and to explore its banks and the adjoining country, which was then little known. Though furnished with only limited means, he carried out his task under great difficulties and severe privations in a very successful manner. He returned to St. Petersburg by way of Siberia in 1857. In 1859 and 1860 he travelled in Manchuria; in 1861 he visited the island of Yesso; 1862, Nipon; 1863, Kiu-siu. He returned to Europe by the sea route in 1864. It was then that he first visited England. He was at that time in a bad state of health, in consequence of an obstinate fever he caught in Japan, and from the effects of which he suffered from time to time throughout his life. In 1869 he was appointed Botanikus Primarius at the Imperial Botanical Garden at St. Petersburg. After 1866 he published many contributions to the flora of Eastern Asia in the *Mémoires* and the *Bulletins* of the Academy, the most important being a monograph of the Rhododendrons of Eastern Asia, the "Diagnoses breves Plantarum Novarum Japoniæ et Mandshuriæ, Dec. i.-xx.;" the "Diagnoses Plantarum Novarum Asiaticarum, i.-vii.," &c. It was in the latter that he began to work out the large and exceedingly important collections made by Prjevalsky, Potanin, &c., in Central Asia.

— APPLE MÈRE DE MÉNAGE.—I do not think this Apple is planted nearly as much as its merits deserve, owing perhaps to the idea that it is a shy cropper. An instance of this mistake occurred here last season. A traveller called upon me, and in conversation I said we proposed planting fifty trees of the above-named variety. He rejoined, "I should do nothing of the sort." I asked, "Why?" "Because it does not bear freely enough," was his answer. "Wait till you see," said I. And when I took him to a ten-year-old tree, with its branches laden with very highly coloured fruit, he could hardly believe it was Mère de Ménage. This variety is invariably a sure cropper here in our strong

soil, in which it grows vigorously, and when the roots are kept near the surface it does not canker. The extension system of pruning is what is required to produce fruit, what I call a pyramid without restriction. By allowing the young shoots to remain 18 inches long, with merely the point removed to induce some of the back eyes to grow as well as those near the point to form fruit spurs, a large tree is quickly obtained. Due regard should be paid to allowing ample space between the branches for the admission of sunlight and air, otherwise this freedom in extended growth is a mistake in the pruning operation. We used the last of the fruit of this variety on March 2nd, which were in capital condition for culinary purposes. As a market Apple Mère de Ménage should take a high position. Its bright and taking colour, either in September or February, is equally good. Indeed, I cannot say too much in its favour as a free bearing and good keeping sort.—E. M.

— THE area under the administration of the BENGAL FOREST DEPARTMENT, according to its last Report, during 1889-90 consisted of 5195 square miles of reserved forest, 2239 square miles of protected forests, and 4034 square miles of unclassed State forest and waste lands, aggregating 11,468 square miles, which is 5½ per cent. of the total area of the province—viz., 193,198 square miles. The forests are, however, confined to the districts bordering on the sea, the sub-Himalayan tracts and the plateau of Central India, so far as it stretches into Chota Nagpore and Orissa. An area of 207 square miles was added to the reserves during the past year, and 25 square miles of protected forests in the Sunderbunds were farmed out for reclamation. The title of Government to existing reserves is being completed by a compliance with the requirements of the Act, and the inquiries incidental to these proceedings will also secure the record and protection of private easements. The special measures taken for the protection of forests from fires have been increasingly successful, 95 per cent. of the areas thus dealt with having escaped, in spite of the dryness of the season, against 72.9 per cent. in the previous year.



THE CHRYSANTHEMUM ANALYSIS.

THE analysis of varieties shown during the last year as compiled by "E. M., *Berkhamstead*," proves that cultivators are paying far greater attention to the true incurved than to many others which are not what I call true in character. Take for instance such sorts as Beverley, Venus, White Venus, Prince of Wales, or even Mr. Bunn, not one of these can be compared with the more popular varieties of to-day, as, for instance, Miss M. A. Haggas, which has been singled out for distinction as heading the list in the incurved section. A true incurved bloom should have the points of its petals meet quite close in the centre, should not stand upright as in the case of Beverley, which neither belongs to this section nor to the reflexed type. The number of times (seventy-one) which Empress of India and Lord Alcester were staged in 1890 stamp these two as especial favourites. The latter in my opinion is at the present time the finest of all varieties in the incurved section; more show blooms can be cut from the same number of plants than from any other sort in cultivation. In the incurved section some one variety appears to have a "run" at certain times, what is termed amongst growers a "Jeanne d'Arc year." For instance, this season was a Princess Beatrice year; certainly a good number to be found in first-rate condition. It cannot be classed as one of the best and certainly not one of the easiest to grow, but Lord Alcester appears to be influenced by neither weather nor popularity, keeping steadily on its way, as the saying goes. The once popular trio, the Rundle family, are very low down in the list. Competitors find that the blooms nowadays require not only form and quality, but size also. Take, for instance, Lady Slade, which is extremely neat in the formation of the florets, but it lacks what is perhaps the most important point of all in an incurved bloom—depth; without this little success may be expected. One variety which was much belauded before it was known on this side of the Atlantic, but has turned out perhaps the worst failure of recent years, I refer to Ada Spaulding. Such experiences as this will surely place growers on their guard before they devote time, money, and space to what has at present been useless as an incurved variety for the exhibition table.

Your correspondent draws attention to Mr. Bunn being so indifferently represented, and I am not surprised when it is considered that it is very early flowering, and in consequence must be grown on the terminal bud to have it late enough for the shows, and then the blooms possess no depth. I might say this is a regrettable fact, inasmuch as it is quite distinct in point of colour, and as good yellows are scarce, in this section particularly, we miss it from the stands. But the fault is,

as I have previously stated, its quality does not come up to the recognised standard of excellence.

I do not know why your correspondent should use the word "unfortunately" in his remarks in the manner in which the new incurved varieties are obtained, by the sporting of their parents. For my part I fail to see why a Chrysanthemum in any section is not as good as being the result of a sport as a seedling. The only reason that can be put forward in favour of seedlings is that they give a wider range in character, such as habit of growth, formation of the bloom generally, and the florets. But even this is not nearly so noticeable in an incurved variety as in other sections, because the form of incurved blooms admits of so little variation. As long as a variety is distinct in colour I fail to see why it is not as good as a seedling. If we secure an extended list of colours surely this is progress. There is a wide difference in that respect between Miss M. A. Haggas and its parent to please the most prejudiced person against sports. I know certain persons appear to have a strong objection to obtaining new varieties of Chrysanthemums from sports, why, I do not know. To my mind it makes little difference how they come as long as they are really distinct.

In the list of Japanese varieties the retrogression of the older sorts is even more striking. Take, for instance, two varieties, M. Ardene and Bouquet Fait; the former was staged but once in 1890, and the latter not at all. I remember the furore caused by these when first placed before the public. The former I saw at Southampton in 1879, and I have an idea that Bouquet Fait was there too. I thought these were lovely flowers, especially the latter in point of colour. It really is not that they have deteriorated so much, it is the wonderful progress made by others, mainly the result of seedlings raised in Japan, America, France, and elsewhere.

I do think, though, that two varieties, M^{me}. C. Audiguier and Belle Paule, have "gone back" in quality. The last three years a good bloom of either sort has been a rare occurrence. The former at its best is truly magnificent, but I do not deplore so much the loss of others besides these two named, on account of their ungainliness in habit. It is varieties of the style of growth of Avalanche that we want to take the place of those named. The finest blooms that have ever been seen of the first of these came from plants 12 feet high. Now with recent introductions extremely fine blooms can be had from plants which grow 3 and 4 feet high. This surely is an advance in the section under notice. Varieties of the Elaine type are being discarded, they are thought too close in the arrangement of the florets; the moderately loose petalled sorts, such as Sunflower for instance, which are not "sprawly" in form, nor yet too close.

In spite of the opposition there is to Etoile de Lyon, this variety in conjunction with Sunflower takes premier honours in the list, and is only beaten by two others in the number of times staged last season. Opinions differ so much as to what constitutes quality in a Japanese Chrysanthemum that if Etoile de Lyon is objected to on account of the great breadth of its florets, and I believe it is, how comes it then that Empress of India, for instance, in the incurved section is so highly thought of, this having the broadest florets of any in that section? What applies in one case ought to in another. My opinion is that it is more a matter of taste than ought else as to what constitutes refinement, elegance, and beauty in a Japanese Chrysanthemum. The wonderful advance made in the Japanese section during the time named by your correspondent is probably due to the fact of this family being so much more easily increased by seedlings than any other section.—E. MOLYNEUX.

EARLINESS OF RHUBARB.

AS this is a matter of some importance to many growers, and knowing that not a few readers of the *Journal of Horticulture* are specially interested, I will give you my experience of one or two early varieties as set forth by their own showing on being pulled for the first time in 1891. This day, March 23rd, I begin with my old and favourite Hawkes' Champagne; it measures 6½ inches from the colour at the base to the bottom of the leaf, with a circumference measurement in the centre of the stem of 3 inches; Yaxley Vicar's Rhubarb, 6 inches of stem (same measurement all through the varieties), with a circumference of 3½ inches; Tobolsk, 5 inches of stem, with a circumference of 2 inches; Chiswick Red, 4 inches of stem, with a circumference of 3 inches; Kershaw's Paragon only just lifting the straw; and Johnstone's St. Martin only slightly moving. As far as I am concerned this settles it with me as to which is the earliest Rhubarb, and as to quality none of the others can be mentioned in the same breath with Hawkes' Champagne. I am told that Chiswick Red beats, for earliness, Hawkes' Champagne in many places, notably about London. I do not dispute this, and must therefore conclude that there is Hawkes' and Hawkes'. Now I know that mine is the true variety, because I had it direct from Mr. Gilbert of Burghley, through whose kindness and generosity I had a good supply. Chiswick Red I know also to be true, because through the kind influence of the *Journal of Horticulture* I had the true variety from Mr. Barron of the R.H.S. himself. Yaxley Vicar's Rhubarb is very like in character to Chiswick Red, but it is slightly (not much) earlier, and this is also true, because it came to me directly from Yaxley. Tobolsk is characteristically true, and I have to thank "Handy Andy," near Limerick, for it. (Shy man, why will he not let his brother know who he is?). But whatever its merits may be in Ireland it is not worth growing as a quantity-producing Rhubarb in comparison with other varieties. After all, I wish it to be distinctly understood that I do not

consider my experiments final. I only record my present experiences, and if further experience disproves the present, I will honestly and promptly write and say so.—N. H. POWNALL, *Lenton Hall Gardens, Nottingham.*

PLAN OF A KITCHEN GARDEN.

WE have referred on several occasions to the good work performed by the Cardiff Gardeners' Mutual Improvement Association, and have reprinted some of the papers read at its meetings. We have now to notice the result of a competition of quite a different character. It was announced in the programme for the season that Messrs. Stephen Treseder and Alfred Kettlewell offered a prize consisting of a set of drawing instruments value 26s. for a plan under the following conditions:—"Plan of a kitchen garden drawn to scale, including plan of fruit and plant houses, fruit room, seed room, offices, sheds, stokehole, &c., with essay describing soil, situation, the arranging and planting of basket and fruit trees, not to exceed four acres." Mr. Hugh Pettigrew was the successful competitor under the *nom de plume* of "Be'lis," and the plan which secured the prize is represented in a reduced form in fig. 44.

The description furnished with the plan is as follows:—The accompanying is a plan of a kitchen garden, including plant and forcing houses, frame ground, manure yard, stokehole, bothy, office, seed room, stable, cart and dog-cart houses, sheds of different kinds, underground rain-water tanks, &c. The whole not to occupy more than 4 acres.

The broad lines (1) denote walks; the narrow surrounding lines (2) brick walls. The stokehole, which is strongly arched under the walks, has its position shown by black dots, and the underground tanks are also shown in the same way.

One of the square manholes on the surface of stokehole shown in the plan is for admitting coke and the other for drawing up ashes, both being covered with iron gratings.

The tanks are 9 feet deep, and arched over 2 feet below the surface of the ground, made thoroughly watertight, and the rain water from all the houses is led into them.

The office and stable, at each end of the sheds, are raised up square, and the walls castellated, and a large cistern placed on the top of them to supply all the houses with water by gravitation.

The water is pumped up from the tanks underground by manual labour or otherwise.

The spaces in front of the sheds are intended to represent the position of rockeries. The walks of the garden are edged with Box. The soil, if possible, should be a rich loam, from 2 to 3 feet deep, and sloping gently to the south. If necessary, it should be well drained.

The marks thus + in the kitchen garden show the positions of the pyramidal and wall fruit trees.

The south wall behind the plant houses to be planted with the best varieties of Pears, to be trained in fan shape. The south wall outside to be planted with Peaches, Nectarines, and Apricots in equal proportion. The inner walls above the tanks—Figs. Outside wall parallel with sheds—Apricots. North wall, with Cherries and Red and White Currants. The two east aspects of walls—Pears.

The two west aspects, one with Plums, and the other with Pears. Outside borders can be planted with bush fruit, Raspberries, Gooseberries, Red, White, and Black Currants according to requirements. Borders of cross walks running east and west to be planted with a choice collection of pyramidal Pears, except the border at south end of the garden, which is Plums. The borders by the sides of walks running north and south, pyramid Apples, all on the free stock.

The slip of ground outside the walls, if enclosed by a hedge (3) next to the walk, may be of Privet or Holly, according to circumstances.

HORTICULTURE IN AMERICA.

[A paper by Mr. JAMES H. LAING, F.R.H.S., read at the Birmingham Gardeners' Association, March 9th, 1891.]

IT was suggested a short time since that an account of my experiences and impressions of horticultural matters in those parts of the United States of America I had the opportunity of visiting in the months of August and September last would prove interesting. I have much pleasure, therefore, in jotting them down as they occur to me, which I trust will receive indulgent consideration.

Anyone boarding one of the huge steamers which cross the Atlantic Ocean for the first time naturally feels a certain amount of reluctance,

not to say anxiety, especially if he has not acquired the use of his sea legs. But when we leave the tender at the Bar off Liverpool, and ascend the companion ladder of such a magnificent steamship as the Etruria of the Cunard Line, considered to be one of the fastest vessels, we feel more tranquil, and soon endeavour to be at home and make acquaintances with our fellow passengers for the week's journey. Fortunately my good friends, Mr. W. A. Manda (Short Hills) and Mr. and Mrs. Thos. Young, who were returning home from a European tour, were aboard; hence it is needless to add that, with such genial companions, the time passed away most pleasantly, and, moreover, being specially favoured with an excellent passage, we all arrived in good health and spirits at New York.

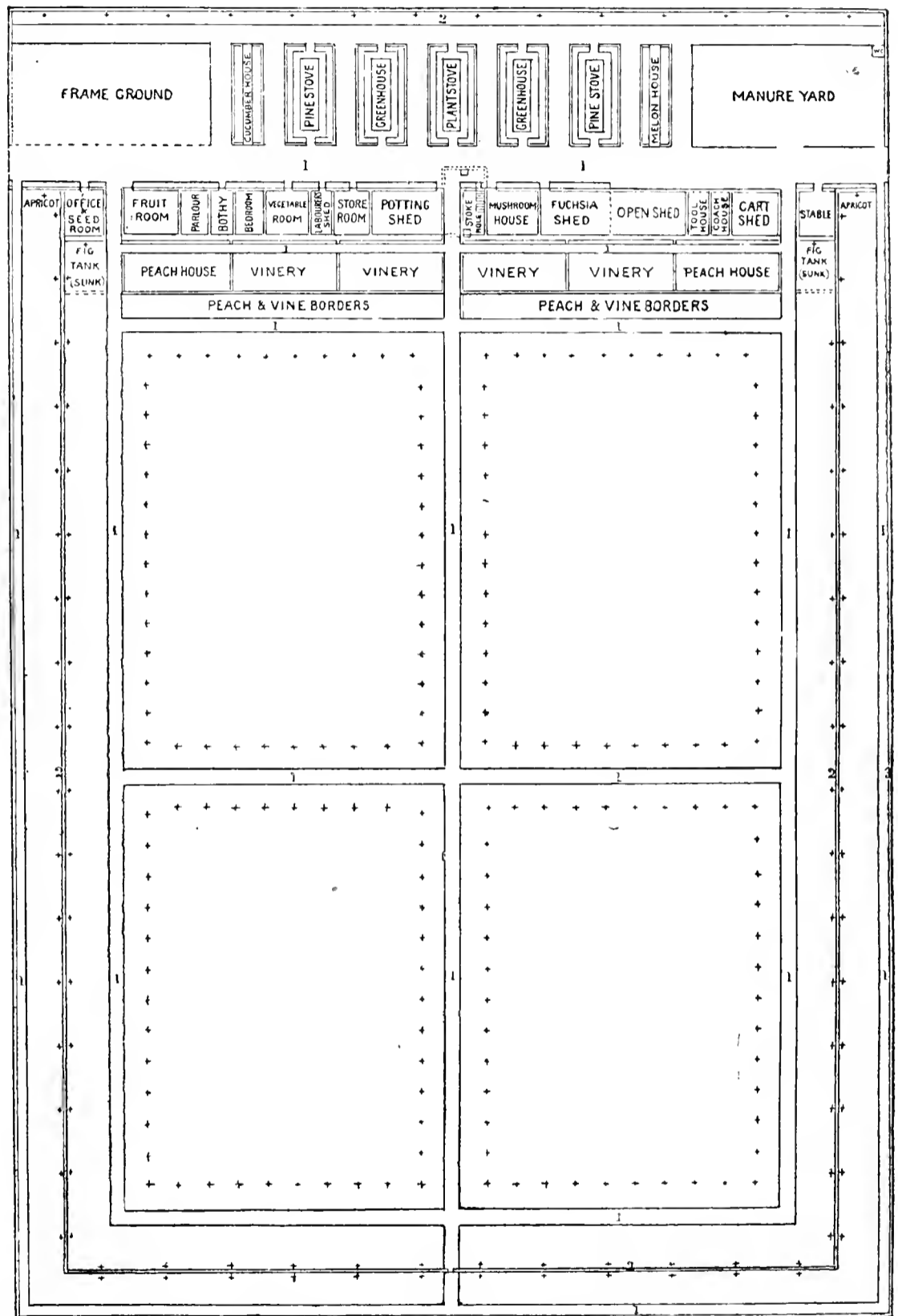

FIG. 44.—PLAN OF A KITCHEN GARDEN.

The Etruria, well known for the rapid run and saving of several thousand pounds sterling in the shape of importers' duty fees, by clearing her cargo through the Custom House a few minutes before the McKinley tariff came into force, took us splendidly across in six days.

I cannot imagine a better and grander sight than the first impressions produced by the harbour of New York, which, rightly considered, I should think, to be one of the finest and most picturesque in the world. The outer Bar is at Sandy Hook, eighteen miles from the Battery, and is crossed by two ship-channels, either of which admits vessels of the deepest draught. From the deck of the steamer the American coast is usually first sighted at the line of the Navesink Highlands, or off Fire Island Light, and the Bar is crossed soon after. The steamer then enters the Bay, and sails through the narrows between the villa-crowned shores of Staten and Long I-lands, which, on Saturday evenings during the

season, are full of attractions, including firework displays and illuminations. Coney Island and Manhattan Beach on these shores are the rendezvous of the pleasure-seeking New Yorkers. To the left are seen the massive battlements of Fort Wadsworth and Fort Tompkins; whilst, returning to Long Island again, are Fort Hamilton and Old Fort Lafayette, the latter more famous as a political prison than a fortress. Passing amid these fortifications, and not deterred by a formidable looking man-of-war flying the stars and stripes, the panorama of the City and harbour rapidly unfolds itself. Turning to the left we see Bedlows Island, the sight of Bartholdi's colossal statue of Liberty enlightening the world. Though not a handsome statue, it is placed in a prominent position, and presents a noble appearance. It cost, it is said, £250,000, and is made of copper and iron. Its height from base to torch, which is lighted by electric light, is 151 feet. Next we behold Ellis Island, a landing stage for immigrants, with a fort, which is still further towards the Jersey shore, and to its right Governor Island, with Castle William and Old Fort Columbus. Directly ahead the City opens with Brooklyn and its wonderful suspension bridge on the right, and Jersey City on the left.

We landed at the Cunard dock, and passing through that trying ordeal of having your clean linen tarnished by the hands of a Custom House official, I consigned my baggage to what they call an express man, which, by-the-by, is an excellent system of checking that I cannot praise too much, doing away as it does with the porter sharks, such as we have in our ports, and though, perhaps, not a cheap method, it materially assists the burdened traveller of responsibility. In company with several friends we wended our way "up-town," through the squalid, irregularly paved streets to my hotel, the Astor House in Broadway. Here I found my baggage all right. The surroundings gave us an idea of comfort, and the vastness of the mercantile capabilities, also importance of the emporium of the New World. As you ascend Broadway the City becomes more imposing. Many magnificent blocks of mercantile and other buildings, *i.e.*, the splendid new Post Office, the Tribune Building, with its clock-tower 185 feet high, *The World* Newspaper, National Academy of Design, and many other superb structures.

Noticeable "up-town" (as the Yankee says) is the systematic planning of the streets. The plan of the upper part of the town includes avenues running north to the boundary of the island, and streets running across at right angles from river to river. The avenues are numbered from the eastwards. The streets are named and numbered consecutively north to 225th Street; those in the east and west from 5th Avenue. Twenty-one blocks (buildings), including streets, average an English mile long. The city is compactly built to Central Park. The well-known Wall Street, the monetary centre of the country and resort of bankers and brokers, runs to East River. Noteworthy buildings herein are the United States Sub-Treasury, United States Custom House, the handsome Drexel Building, and the Stock Exchange in Broad Street. A novelty to anyone for the first time is the elevated railway running overhead, and now considered a great convenience. A uniform fare is charged of 2½d., similar to charges on the trams, and much in the same way as on the new Stockwell Railway in our metropolis.

New York has many open spaces and squares. Central Park, one of the finest parks in the world, embraces a rectangular area of 854 acres. The original surface was exceedingly rough and unattractive, consisting chiefly of rock and marsh, but by engineering skill and good taste in laying out the ground it has been converted into a most attractive resort. There are five lakes occupying 43½ acres, numerous bridges, arches, and other architectural monuments, together with many statues. The Mall is a wide esplanade nearly a quarter of a mile long, and bordered by double rows of stately Elm trees. I noticed some excellent carved masonry. Central Lake is the prettiest piece of water in the park. The Ramble, covering 36 acres of sloping hills, and having many pleasant shady parts, lies to the north. The Zoological Gardens, or menagerie, also the Metropolitan Museum of Art, are most interesting. One of the most striking objects in the park is the Egyptian obelisk (Cleopatra's Needle), one of the most ancient of the world's monuments. It was presented by the late Khedive and brought to New York at the expense of W. H. Vanderbilt, Esq., of railway fame. Great credit is due to the superintendent of the park for the admirable way in which he manages everything, the bedding-out arrangements being capital; but I was unable to make any jottings respecting its horticultural features, my time being so limited that day.

I took the earliest opportunity of calling upon the well-known house of Peter Henderson & Co. I had the good fortune to meet the courteous Mr. Charles Henderson, to whom I am indebted for many acts of kindness. The immense seed warehouses, plant houses, and trial grounds at the Jersey City Heights were well worth inspection. Grown indoors in pots, on a very large scale, are Roses, on their own roots, for post trade. All the best sorts are in stock, but none sell better than American Beauty, a seedling found in the gardens of Mr. Bancroft, the historian at Washington, who possessed a fine collection of Roses, though I am told it is after all too much like Madame Ferdinand Jamain. Messrs. Henderson's Roses for the cut flower trade are planted a foot apart in raised benches, 4 or 6 inches deep. The following sorts have proved to be the best to force:—Catherine Mermet, Perle des Jardins, Niphotos, Sunset, Mr. F. Bennett, Magna Charta, and American Beauty. Good cut blooms of these in the height of the season, with stems 2 or 3 feet long, the usual style in the U.S.A., fetch as much as 4s. 2d. and 6s. 3d. apiece. I noticed many long, span-roofed houses full of Pelargoniums,

Fuchsias, Caladiums, Carnations, Chrysanthemums, and a multitude of other plants—softwooded chiefly—in the best of health. I also observed Mrs. Alpheus Hardy Chrysanthemum growing well in the cool houses. The benches and borders were planted with it, each having five or six stems, the flowers not being disbudded. Louis Boehmer, the stock of which has been purchased, was also growing well, but a little more vigorously. The weather at the time of my visit was exceedingly hot nevertheless, with the assistance of the hose, used largely in America—the watering-pot being considered too much waste of time, and hence is only employed here in the propagating house—it is wonderful with what vigour plants thrive. Cannas were quite a feature outside, the glorious weather suiting them admirably.

Before leaving New York I was invited by Mr. Henderson and his excellent manager Mr. A. Forbes, to inspect their exhibition of Gladioli and summer flowers, held for four days in their splendidly fitted-up seed store. All the seed counters and benches were covered with white cloth, on which, neatly arranged with admirable effect, were large good spikes of all the finest and best Gladioli in cultivation, put in Hyacinth glasses and bottles, backed with Palms and green foliage plants. Miscellaneous flowers included many choice herbaceous cut flowers, Cannas, Crinums, Mammoth Verbenas, and Lilliums. I was very much impressed with the splendid exhibit also of cut blooms of Nymphaeas. The varieties represented were chiefly odorata, rosea and rubra, Chromatella, Devoniensis, the beautiful zanzibarensis, and a very fine white seedling appropriately named alba candidissima.

The United States Nurseries were next on my programme. Mr. W. A. Manda, the energetic managing partner, was unfortunately from home, but I found a good substitute in his representative, an Englishman. The nurseries are situated in a favourable spot, near the very pretty village of Short Hills, on the Delaware and Lackawana Railway. Here herbaceous plants received special attention, and a choice and extensive collection had been formed. I saw several good Phloxes and Dahlias. Chrysanthemums, largely grown, looked healthy. It was through this firm that the famous Chrysanthemum Mrs. Alpheus Hardy was sent out, a fabulous sum being paid for the stock. A speciality is Orchids, and especially Cypripediums, of which nearly 400 species and varieties are well grown and managed by Mr. Jos. Manda.

I was lucky enough to find Mr. T. H. Spaulding at home in his pretty country seat at Castle Wood, Llewellyn Park, he having had the goodness to stay to meet me, though, doubtless, his time was precious and required elsewhere, being the proprietor of large steel works in New York. However, with his usual indomitable perseverance, he manages to grow Chrysanthemums in large quantities, and to be able to raise and distribute new varieties of considerable merit. I must name one of his last year's varieties, Ada Spaulding, as a sort he specially prizes, and though it did not attain high commendations in our country last autumn, yet it should be given another season's trial. Other varieties sent out have been, notably, Beauty of Castlewood, Brynwood, Brilliant, Antoinette Martin, Crystal Queen, Cyclone, Elcavor Oakley, E. G. Hill, G. P. Rawson, Harvest Queen, Pink Pearl, Marie Ward, Miss Esmeralda, Mrs. Chas. Pratt, and that excellent Anemone Mrs. Judge Benedict. I noticed that Mr. Spaulding's standard plants of Chrysanthemums were exceedingly healthy and growing well. Driving through the picturesque surroundings of Orange, Mr. Spaulding pointed out to me the residences of several wealthy members of American society, dotted here and there over the lovely well-timbered undulating ground. Amongst them is that of the eminent electrician, Mr. Thomas A. Edison. William Barr, Esq., of the well-known dry goods store in Broadway, has an elegant residence, and being a great lover of plants and flowers we naturally expected to find things in order, but Mr. John Farrell surprised me with the excellency of his cultivation, and the neatness displayed in and out of doors. Chrysanthemums were a great feature. Mr. W. Barr, a connoisseur, secures nearly all the first prizes every season for single specimen and pyramid plants. These are grown much in the same style as in this country, except as regards tying, this artificiality being a deal less rigidly carried out, and disbudding not done so heavily. The plants I saw standing in the walks of the kitchen garden were chiefly in 6, 7, and 8-inch pots, and gave promise of producing good autumnal results. Several plants of standards were grafted with two or more varieties on each plant.

Mr. John N. May, the genial Rose grower of Summit, has a splendidly managed nursery. Roses are there grown inside to perfection. A large number of glass houses were devoted entirely to their culture. A friend and I spent a most enjoyable afternoon at this born rosarian's establishment. I noted the following sorts as grown extremely well there: Mrs. John Laing (now considered to be the most popular Rose grown), Ulrich Brunner, Géant des Batailles, Général Jacqueminot, Earl of Dufferin, Heinrich Schultheis, Duchess of Albany (Hybrid Tea), La France, Mdle. Gabriel Luizet, Catherine Mermet, The Bride, T. W. Girdlestone, Niphotos, Ma Capucine, Lamarque, Gloire de Dijon, and several others. I append Mr. May's method of cultivating Roses. "The general practice I adopt is to replant fine, healthy, new stock every year—or at most every two years. Originally the prevailing idea was that Roses must have a deep rich border ranging from 12 to 24 inches deep, to produce good Roses. Now the finest are produced on benches, &c., with 2½ to 4 inches of soil. For the successful cultivation of the Rose under glass there are a few simple rules to follow. First, to procure a suitable soil, which should be, if possible, fresh sod from an old pasture—that having plenty of grass root-fibre in it is generally the best. If very heavy the addition of a liberal proportion of sharp sand will improve it, but if of a very light sandy nature the addition of some of a clay

character will be beneficial for most Roses. When earthing together in the spring mix with it one part good clean cow manure to six, eight, or ten of soil according to the quality of the soil. Turn it over two or three times, and it is ready to put in the Rose house. To keep plants in such a shallow bench, as above mentioned, in constant bearing, they must of course have liberal treatment.

"After they are planted, say in July, and get fairly started into growth, they need a mulching of the best manure they can have. This induces surface-root action, which roots should never be disturbed, and in the course of eight or ten weeks the plants will have absorbed the above coat of mulching. I give a light dressing of pure, fine-ground bone, covering the same with another thin coat of manure. This process is repeated as often as required, and where the plants are growing very strong careful application of other stimulants, such as liquid manure and nitrate of soda is of great benefit to them, provided of course due care is used in its application. To apply strong stimulants injudiciously means ruin to flowers and the plants. Of course it is essential to have vigorous and healthy plants, and keep the house perfectly clean. Watering and general care of the plants need a remark or two. The only sure guide is a careful study of the soil one has to deal with, and use water in proportion to its requirements. A medium course should be taken—not to permit the Rose in full growth to become dry, or flooded with water." Mr. May has also an extra fine strain of Mignonette, and grows a large house full of it in solid beds raised about 18 inches above the level of the walk.

Mr. C. L. Allen invited me to visit his place at Floral Park (Long Island), and I was glad I did, for the treat I had well repaid the journey. Meeting my host at the depot (railway station), with his horse and buggy, we drove to his son's establishment (Mr. C. H. Allen), who is becoming quite a renowned Gladioli grower. Who can picture a finer and more gorgeous sight than a large field of thirty acres or more planted with Gladioli in full flower, which in the American warm climate attain very fine growths? The excellency of their huge spikes, frequently 6 feet long, was particularly remarkable. Messrs. Allen informed me the corms were planted and dibbled in by a planting machine in May in drills and in well manured ground, and certainly the result showed they had merited the good treatment. Towards the end of September, when these are nearly ripened off, the whole would be ploughed up and dried, and then stored, or else despatched to their numerous customers. The varieties grown are too numerous to describe here, but all the best are grown, and the inferior ones discarded. Raising seedlings have the attention of this good firm, and, as far as I could tell, with fruitful results, many excellently formed spikes and flowers of all colours having been already produced. When you look at the quantity grown it seems hardly possible to sell so many, but Mr. Allen smilingly says, "We have an immense demand." *Eulalia japonica* and *zebrina* are grown in quantity, as also are *Dahlias*, *Montbretias*, and *Tuberoses*. Splendid Balsams of an excellent strain were worthy of remark.

(To be continued.)

CRYSTAL PALACE SPRING SHOW.

MARCH 21ST.

THE concluding day of the Horticultural Appliance Exhibition was rendered much more interesting than it had previously been to a good attendance of visitors by the display of bulbs and forced plants, which, though shown in large numbers, were bright, varied, and attractive. The exhibits were arranged in the transept occupying the space in front of the theatre, the majority being placed on table, the larger groups in competition having positions on the floor at the end.

Hyacinths, Tulips, and Narcissuses were fairly well shown in several classes; thus for thirty-six Hyacinths, the same of Tulips, and twenty-four Narcissuses Messrs. H. Williams & Sons, Fortis Green, Finchley, won the premier honours with specimens of the usual varieties staged at exhibitions. Mr. W. B. Morle, Regent Street, was second in the two first-named classes, but there was considerable difference in the quality of the first and second plants, even though the former were not quite up to the usual standard. With twelve Hyacinths, twelve Tulips, and twelve Narcissuses in the amateurs' classes, Mr. Shoesmith took the lead with medium-sized even examples, but some other exhibits in these classes were not of much merit. Cinerarias were rather poor, except in one or two cases, Mr. J. Ford, gardener to Sir C. Pigott, Bart., Slough, having the best in one class, and Mr. Shoesmith in another. Cyclamens were, however, of more noticeable quality, Messrs. Phillips, Odell, Carter, Nunn, Slough, and the St. George's Nursery Company taking the prizes in two classes. Messrs. Paul & Son, Cheshunt, were first for twelve *Amaryllises* with well-grown plants, having strong heads of flowers of several fine seedlings and named varieties. Azaleas were not at the best, the twenty-four well-grown plants which gained Mr. R. Wells of Sydenham the first prize not having half their flowers expanded. Mr. Nunn was second with thin, sparsely flowered plants. For a group of flowering and foliage plants Mr. James of Norwood was placed first with capital plants and good Orchids, but very unsatisfactorily arranged. Messrs. Laing & Sons were second with a better arrangement, wanting more colour.

The non-competing exhibits were numerous and more remarkable for variety and quality than the others. Prominent amongst them was a grand group from Messrs. B. S. Williams & Son, Upper Holloway, comprising some hundreds of specimen Hyacinths, Tulips, and Lilies of the Valley. Messrs. Paul & Son, Cheshunt, had some excellent early

Roses in pots. Messrs. Barr & Son, King Street, Covent Garden, contributed a comprehensive collection of Daffodils and hardy flowers. Mr. T. S. Ware, Tottenham, also had an interesting group of similar flowers.

An extremely beautiful group of Orchids and greenhouse flowering plants most tastefully arranged came from Messrs. Low & Co., Clapton, and formed a pleasant surprise on such a winterly morning. The *Phalenopses*, *Dendrobiums*, and *Cœlogynes*, were very noticeable, as also were the *Acacias*, *Epacrises*, and *Deutzias*. Messrs. Cutbush & Son, Highgate, were represented by a collection of capital *Epacrises* and *Ericas* all in admirable condition, and Messrs. W. Paul & Son had an imposing display of some hundreds of fine *Camellia* flowers in boxes, from the great collection at Waltham Cross.

In the morning there was also a trial of spraying machines and insecticide distributors, which created much interest, and though the competitors were few the proceedings were watched by a large crowd for a considerable time.

ROYAL HORTICULTURAL SOCIETY.

MARCH 24TH.

GROUPS of flowering plants filled the greater portion of the Drill Hall at Tuesday's meeting, and furnished a satisfactory display of seasonable attractions, the nurserymen's exhibits constituting the principal part of the show, as the first prizes provided for amateurs did not induce very encouraging results. In the afternoon the subject at the general meeting was a paper on "Bulbs," which brought a fairly good audience.

FRUIT COMMITTEE.—Present: Phillip Crowley, Esq., in the chair, and Dr. Robert Hogg, with Messrs. J. Lee, T. F. Rivers, G. Bunyard, R. D. Blackmore, Harrison Weir, J. Willard, C. Ross, J. H. Veitch, J. Cheal, G. W. Cummins, G. Reynolds, W. Bates, A. Dean, G. Wythes, J. Hudson, H. Balderson, F. Q. Lane, and C. Penny.

The duties of the Committee were by no means of an onerous character, they were soon performed, and the members had ample opportunity for inspecting the floral exhibits. Messrs. Bourne & Son, Beckington, Frome, sent a seedling dessert Apple, which was said to keep good until the end of April, and that it is a free bearer. No information with respect to its origin was supplied, and the small greenish yellow fruits were not found to be in good condition, due it was supposed to their having been gathered too early. The Committee accordingly made no award for it. The only other exhibit was a dish of fine Mushrooms from Mr. William Whiteley, Westbourne Grove, for which a vote of thanks was accorded.

FLORAL COMMITTEE.—Present: W. Marshall, Esq., in the chair, and Messrs. B. Wynne, H. Herbst, R. Dean, W. C. Leach, G. Bryceson, W. Watson, J. Walker, C. A. Pearson, Henry Cannell, W. Bain, T. Baines, C. Noble, H. Turner, G. Paul, C. T. Druery, C. Jefferies, J. Fraser, and the Rev. H. H. D'Ombraim.

An extensive and handsome group of Hyacinths, Tulips, Narcissuses, Azaleas, and *Clivias* secured for Messrs. B. S. Williams & Son, Upper Holloway, the premier award of the day in the shape of a silver-gilt Flora medal. The collection comprised a large number of varieties in most of the genera, named *Clivias* being especially fine, while the pure white double Azalea *Deutsche Perle* was represented by well grown dwarf, bushy plants.

Forced shrubs in flower are not too frequently seen at the meetings or other shows, and therefore the group of deciduous Azaleas and *Spiræas* from Messrs. J. Veitch & Sons, Chelsea, was especially welcome. Of *Azalea mollis* there were several beautiful varieties, and two distinct double forms were awarded first-class certificates, and are described at the end of this report. The graceful *Spiræa confusa*, which is admirably adapted for quick forcing, was much admired, and few are aware what a useful plant this is for early decoration; the fresh light green foliage, the neat heads of white flowers, and compact habit rendering it a favourite where it has been tried. *Xanthoceras sorbifolia* with pinnate leaves and racemes of white flowers was also shown; and in another part of the hall a group of select *Amaryllises* or *Hippeastrums*, two of which were selected by the Committee for awards of merit, also came from the Chelsea firm, which was adjudged a silver Banksian medal for the exhibits.

Some new Roses from Messrs. Wm. Paul & Son, Waltham Cross, were examined closely and critically, and passed the ordeal satisfactorily. For Denmark, a pink H.P., an award of merit was granted; but the following were also generally approved—namely, *Lady Henry Grosvenor*, a blush Hybrid Tea; *Duchess of Albany*, a very dark and rich Rose of the *La France* type; and *White Lady*, shown for comparison with *Lady Mary Fitzwilliam*, and distinct. Hardy plants and Daffodils from Mr. T. S. Ware of Tottenham and Messrs. Barr & Son, Covent Garden; Ferns from Mr. H. B. May; Cinerarias from Messrs. James & Son, Farnham Royal, Slough; and choice alpine with other hardy plants from Messrs. Paul & Son, Cheshunt, secured silver Banksian medals. Messrs. H. Cannell & Sons sent a box of Zonal *Pelargonium* flowers in splendid varieties; and from the Royal Gardens, Kew, came a basket of hardy plants that had been flowered under glass.

In the classes for groups of bulbous plants and Cinerarias there were only two entries, both from Mr. Shoesmith, Shirley Lodge Gardens, Croydon. For the group of bulbs he was awarded the second prize, and for the Cinerarias the first prize, with a bronze medal, the plants being similar to those staged at the Crystal Palace a few days before.

ORCHID COMMITTEE.—Present: Dr. M. T. Masters and Messrs. H. M. Pollett, H. Ballantine, C. Pilcher, G. Hill, J. Douglas, Lewis Castle, G. Courtauld, and James O'Brien.

Dendrobium hybrids from Sir Trevor Lawrence, Bart., M.P., Burford

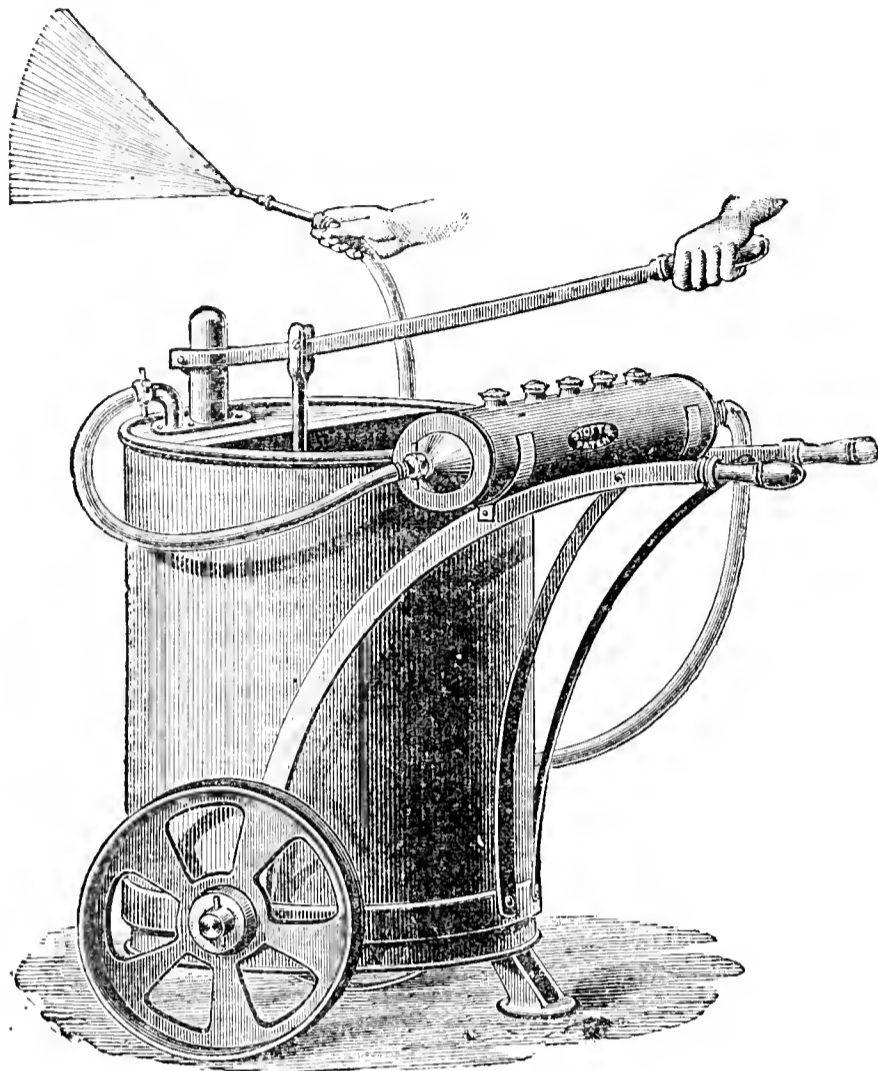

FIG. 45.

Lodge, Dorking, were very interesting, and two were selected for awards of merit, together with two curious *Cirrhopetalum*s and a *Bulbophyllum* for botanical certificates. T. Statter, Esq., Stand Hall, Manchester (gardener, Mr. R. Johnson), had several *Dendrobium nobile* varieties, flowers of *Laelia crispata* and *Lycaste Skinneri alba gigantea* with five large pure flowers, for which a cultural commendation was awarded. M. Linden, of Brussels, sent several Orchids and other plants that gained special awards; M. G. Cooke, Esq., Kingston Hill, showed a collection of Orchid flowers, and interesting groups of Orchids came from F. Wigan, Esq., Clare Lawn, East Sheen (gardener, Mr. Young); and from Mr. W. Whiteley, Westbourne Grove. C. J. Lucas, Esq., Warnham Court, Horsham, exhibited an extremely well-grown *Dendrobium Bymerianum* with twenty-four flowers (cultural commendation), and Mr. Wythes, Syon Gardens, had a plant of *Dendrobium thyrsoiflorum* with eight long racemes (cultural commendation).

CERTIFICATED PLANTS.

Amaryllis Olivia (J. Veitch & Sons).—A beautiful variety, with

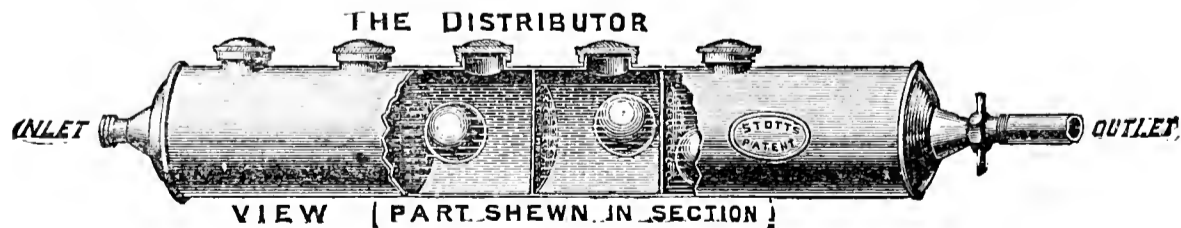

FIG. 46.

well formed flowers; white, delicately streaked with red (award of merit).

Amaryllis Vandyke (J. Veitch & Sons).—A grandly coloured effective variety, the flowers of excellent shape, the colour a rich deep solid scarlet (award of merit).

Azalea mollis fl. pl. Meene (J. Veitch & Sons).—A novelty, said to be of the mollis type, but more nearly resembling some of the older species. Whatever its origin it will be a useful plant, the flowers being perfectly double, white, fragrant, and very freely produced (award of merit).

Azalea mollis fl. pl. Norma (J. Veitch & Sons).—Another of the same type, but of a rich reddish orange salmon but very distinct and showy (award of merit).

Rose Danmark (W. Paul & Son).—A free growing H.P. Rose, with compact, full, well-formed blooms, the petals shorter and harder than *Læ France*, forming a flatter flower, of similar colour, and very sweet (award of merit).

Clivia Prince of Orange (B. S. Williams & Son).—Remarkable for the perfect shape of the flowers, the petals broad and even, and the colour rich orange (award of merit).

Sarifraga Boydi (Paul & Son).—One of the tufted section, with silvery leaves and small bright yellow flowers. Apparently well adapted for pots (first-class certificate).

Bertolonia Madame Leon Say (Linden).—A charmingly delicate variety, the leaves large and veined with silver on a dark green ground, a faint pink tint showing near the margin (first class certificate).

Bertolonia Adolphe de Rothschild (Linden).—Quite distinct from the preceding, the bright rosy veins being on a dark green ground, but affording an effective contrast with that. Both are beautiful, and it is a pity these plants are so seldom seen well grown (first class certificate).

Dendrobium melanodiscus, var. pallens (Sir Trevor Lawrence).—*D. melanodiscus* originated from a cross between *D. Ainsworthi* and *D. Findleyanum*, and, as is usual, several different forms have been obtained from the same cross. The variety named *pallens* is one of the most delicately tinted *Dendrobium*s yet raised, the sepals and petals being white tipped with pale purple; the lip large and open, with a faint yellow tint in the centre. It has a most graceful appearance, is free, and of good habit (award of merit).

Dendrobium melanodiscus, var. Rainbow (Sir Trevor Lawrence).—A bold variety, with large flowers: the sepals and petals tipped with purplish mauve, the lip having a heavy rich magenta central blotch. A handsome companion for *pallens* (award of merit).

Camellia Beauty of Waltham (W. Paul & Son).—One of the most symmetrical *Camellias* yet obtained, the flowers also being of a soft rosy blush tint. It is constant in character and free (first-class certificate).

Arum palestinum (Mr. Gold, High Ashurst Gardens, Dorking).—A peculiarly striking Aroid, the spathe and spadix velvety black, about 6 inches long on a stalk 12 inches high. The leaves are from 8 inches to 12 inches high, with blades 5 or 6 inches long.

Cirrhopetalum Mastersianum, *C. picturatum*, and *Bulbophyllum mandibulare* (Sir Trevor Lawrence).— Botanical certificates were awarded for these curiosities, the first-named being rather attractive, with light brownish flowers of the usual form. The *Bulbophyllum* has strange greenish flowers, and a papillose purplish lip.



FIG. 47.

SPRAYING APPLIANCES.

DISTRIBUTING insecticides in the form of a mist-like spray is being found by experience to be economical and effectual. Several forms of distributors have been devised, and most or all of them are good for the purpose for which they are devised, some being suitable for extensive plantations of fruit, others for smaller gardens and also greenhouses. A competition of "sprayers," the first of its kind, was conducted at the Crystal Palace last Saturday, but the Judges declined to award a medal they had at disposal for any one of them, because of the impossibility of instituting a fair comparison between, say, a hand syringe and powerful pump; they, therefore, recommended that certificates be awarded to the articles on their merits. For instance, one was granted for Snow's small spray pump, which we figured a fortnight ago, and to Hemingway's pump for large orchards; one to Vermorel's knapsack apparatus which can be used in crowded plantations; one to the "Stott" engine and distributor; also one to the hand syringe of the same company. The first of these is represented in fig 45, the second in fig. 46, and third in fig. 47. The distributor is moveable and placed on the engine, the insecticide being contained in cells and forced with the water through the hose. In the syringe a chamber at the end contains the composition, and the nozzle is formed to distribute it in the form of spray to insect-infested plants.

BATH BULB SHOW.

MARCH 18TH AND 19TH.

AS might reasonably have been expected, there was scarcely so good a Show of bulbous rooted and other flowering plants brought together in the Assembly Rooms as usual, but though the tables were somewhat thinly filled at places no fault could be found with the quality of the exhibits generally. The weather also militated greatly against the attendance of visitors, and there will be a serious deficit for the

promoters to face. These bulb shows, though never extensive, are among the brightest of the whole series of five exhibitions annually held at Bath, and it is rather discreditable to the citizens that they are often badly supported.

Hyacinths were shown in fairly large numbers, but the Exeter contingent was missed somewhat. The first prize for eighteen bulbs, in not less than twelve distinct varieties, was easily won by Messrs. G. Cooling & Sons, Bath, who staged a remarkably good lot, all having massive spikes with large bells, and well timed for the Show. These consisted of Leopold II., Mont Blanc, Macaulay, Baroness Von Thuyll, Fabiola, Lord Palmerston, Mr. Pimsoil, Cavaignac, Grand Maître, Koh-i-Noor, Obelisque, and Princess Amelia. Dr. S. P. Budd was a fairly good second; and Mr. J. Ayres, gardener to S. W. Gibson, Esq., third. Messrs. Cooling & Sons were also well first with twelve pots in six varieties, having King of the Blues, Macaulay, La Grandesse, Obelisque, Grand Maître, and Leopold II. in excellent condition. Mr. J. Ayres was second in this class and first in the next with a good lot, the spikes being massive and well formed; and Dr. Budd a close second. For six varieties Dr. Budd was first; and Mr. A. Hawkins, gardener to Mrs. Jolly, second. Tulips were scarcely so good as in former years, and with twelve pots of these Dr. Budd was first, and Messrs. Cooling & Sons second. The premier lot included excellent pots of Rouge Luisant, Duchess of Parma, Tournesol, Joost Van Vondel, Raphael, Yellow Tournesol, Grand Duc de Russie, and Groosmaster Van Malta. In Messrs. Cooling's collection Little Dorrit, a charming single yellow, attracted much attention. Dr. Budd, Mr. Ayres and Mr. E. Hall were most successful in the other Tulip classes. Mr. S. Kerslake, gardener to the Rev. E. Handley, was the only exhibitor of twelve varieties of Daffodils, and took the first prize for remarkably good pots of Golden Spur, Sir Watkin, P. R. Barr, W. Goldring, Golden Plover, Henry Irving, Horsfieldi, Ard Righ, Maxima, Bicolor Empress, Countess of Annesley, and Golden Empress. The same exhibitor had another first prize for a grand collection of Daffodils and Narcissi arranged effectively in a group, and was also first for six pots of Polyanthus Narcissi, these consisting of Sir I. Newton, Grand Monarque, Bazelman Major, and Her Majesty. Mr. J. Ayres was second, while to Mr. A. Hawkins was awarded a first for three well-flowered pots of Amaryllis.

Two classes were provided for Orchids, and these attracted quite an imposing display of these popular flowers. The best six varieties were shown by Mr. S. Kerslake, who had Cattleya Mendelli, C. Trianae Lecana, C. Schroederæ, C. Loddigesii, C. Trianae gigantea, and a fine well-flowered specimen of Dendrobium nobile. R. B. Cater, Esq., was a good second, his best being Dendrobium Wardianum very well flowered, Cattleya Trianae delicata, and C. Trianae. With three varieties Messrs. Cooling and Sons were first, these consisting of a very freely flowered pale form of Dendrobium nobile, D. thysiflorum, and a strong well-flowered Cattleya Trianae. Mr. A. Hawkins was a very creditable second. Mr. S. Kerslake was first for a single plant, winning with a well-flowered specimen of C. Trianae, R. B. Cater, Esq., being a good second with Dendrobium Wardianum finely flowered. Pot Roses also made a good display. For six specimens Mr. S. Kerslake was first, though he had the best of the luck, the second prize plants shown by Dr. Budd being fresher and in some other respects better than those placed before them. In the first prize exhibit were freely flowered healthy specimens of Reine Marie Henriette, La France, Marie Baumann, Magna Charta, Marquise de Castellane, and Général Jacqueminot. Indian Azaleas were very well shown by Mr. W. McDonald Bennett, gardener to G. W. Mackillop, Esq., gaining two first prizes for perfect pyramids. Messrs. W. C. Drummond and Mr. Bennett were the principal prizewinners with fine-foliaged plants and Ferns, and the greater part of the prizes for table plants, Cinerarias, Primulas, Cyclamen, Mignonette, and Lilies of the Valley were taken by Messrs. J. Ayres, Bennett, W. C. Drummond, and J. Garraway, the exhibits being creditable in each instance. The first prize for a group of plants arranged for effect was well won by Mr. R. B. Cater, who had a capital display, this including eighteen remarkably well-flowered plants of Dendrobium Wardianum, and several plants each of such other Orchids as Dendrobium Pierardi, D. nobile, Cattleya Mendelli, C. Trianae, Lycaste Skinneri, Odontoglossum triumphans, O. Rossi major, and Cœlogyne cristata, also several good Cívias, Azaleas, Palms, and Ferns. The second prize went to Mr. Bennett for a much more formal arrangement, but which comprised excellent flowering plants, forced and otherwise. Mr. W. C. Drummond was third. A first prize was awarded to Mr. T. J. Tate, gardener to W. Pumphrey, Esq., for a group of smaller dimensions, and this also was a highly creditable display. Mr. Tate was a good first for a circular basket of mixed plants, and Mr. E. Hall second.

There were only a few classes provided for cut flowers, and the competition was not so keen as usual. A box of twelve varieties of Roses, shown by Dr. Budd, was particularly noteworthy. These consisted of Catherine Mermet, Caroline Kuster, Duchess of Bedford, The Bride, Heinrich Schultheis, Maréchal Niel, Rubens, Duchess of Edinburgh, and Lady M. Fitzwilliam. Messrs. Perkins & Sons, Coventry, had a first prize for a grand hand bouquet; Mr. C. Winstone, Clifton, being a good second. The same positions were occupied with these exhibitors in the classes for buttonhole bouquets and ladies' sprays. Mr. Winstone was first for a vase, and Mr. E. T. Hill second.

Fruit was not largely shown, but there were several excellent dishes of Apples, the first prize for a single dish going to Mr. J. Rogers, gardener to P. C. Hardwick, Esq., for a grand dish of Streaman Pippin, which, briefly described, may be said to be a glorified Blenheim Pippin, and evidently is a distinct and valuable late variety. Mr. D. Young

was second with Annie Elizabeth in good condition. A capital collection of well kept Apples was shown by Mr. W. Ward, gardener to W. Leaney, Esq. In the class for a single dish of Pears Mr. R. Hooper Taylor staged good fruit of Beurré Rance and was first; Mr. F. Mead being second with small fruit of Josephine de Malines. Messrs. W. Every, J. Garraway, and E. Hill were the principal prizewinners in the classes for vegetables.

Miscellaneous exhibits, notably the grand group of Orchids and fine-foliaged plants, from Mr. J. Cypher, Cheltenham, and Messrs. Cooling and Sons' display added greatly to the general effect, and came in for a good share of attention. Mr. Cypher filled a table against a back wall, 14 yards by 4 feet, and among the many Orchids shown those worthy of special mention were Cattleyas citrina, Lawrenceæ, Mendelli, and Trianae in variety; Dendrobium Wardianum, luteolum, Cambridgeanum, aggregatum, nobile Cooksoni, nobile Cypheri, Ainsworthi, Domini, Fendleyanum, Jamesianum, and Farmeri; Calanthe oculata gigantea; Odontoglossum Cervantesi decorum, Rossi majus, Alexandræ, Pescatorei, triumphans, and Sanderianum; Epidendrum xanthinum, Dendrochilum glumaceum, Oncidium ampliatum, and Cyripediums Harrisianum, Sedeni, candidum, and cœnanthum superbum. Messrs. Cooling had a lot of good Orchids, also beautiful groups of Indian and forced Azaleas, Japanese Maples, Carnations including the bright scarlet Duke of Fife, Staphyleas, and various other showy plants.

TRIAL OF SPRAYING ENGINES.

CRYSTAL PALACE, MARCH 21ST, 1891.

FOUR distinct machines were entered for competition, but owing to their being of such diverse form and size the Judges felt unable to award a medal for any of them, because in its way each appeared of equal value for the purpose for which it is peculiarly adapted, they therefore beg to present this report. In future trials (which they think desirable), they respectfully suggest that the schedule be divided as follows, when the machines can compete on equal terms.

A. Prizes for machines capable of spraying fruit trees with Paris green or other insecticides in large orchards and plantations, to a height of 20 to 30 feet, not requiring more than three men to work them by manual labour only.

B. Prizes for machines to spray dwarf fruit trees, wall trees, and plants in large conservatories, to be worked by not more than two men.

C. Prizes for hand machines capable of being managed by one boy or man, suitable for amateurs and private gardens.

Ease of working, economy of water and solutions, evenness of delivery, fineness as well as power of spray, and simplicity of construction to be fully considered by the adjudicators.

The "Stott" Patent distributor was first tried, and found to work satisfactorily when attached to the Crystal Palace Company's main, the materials used in spraying being well diffused and under perfect control, but for the purpose of the competition the Judges consider the Patent "Stott" Distributor, combined with a Farringdon Hop-washing machine, to be a most valuable sprayer for Hops or fruit trees. It is worked with ease, requiring one man to pump and one to deliver and manage the hose, and the Patent Stott nozzles (double and single) give a remarkably fine and well diffused spray. This machine appears simple in construction, is durably made, and delivers a continuous stream, while the price, £6 14s. complete, is a reasonable one. The Judges were not quite satisfied that the distributor would deliver Paris green at a uniform strength, but with Stott's "Killright" its action was all that could be desired, and they recommend a first-class certificate for the combination.

The Judges were struck by the utility and handy "Stott" syringe and distributor, and they recommend a first-class certificate for this also as being likely to prove of great value for amateurs for garden and glass house use. The spray produced was of the most dense description, and they believe it will prove of service for those who wish to destroy insects on plants within arm's length. This is priced at 19s. 6d. for ladies' size, and 21s. for a full-sized machine—the Stott Distributor Co. (Ld.), Manchester.

Vermorel's French knapsack spraying pump was next tried. This is a copper vessel made to sling on the operator's back, and the power is generated by a handle under the right arm, the liquid being delivered by hose on the left side under control of the left hand. It is delivered in a continuous cloud of vapour-like spray, while simple nozzles and arrangements prevent clogging at the outlet, and for tall trees the delivery hose can be lengthened and erected by a light cane or stick. Vermorel's machine is specially valuable for its portability, and can be used by one man. Being constructed of copper, it is light and strong, and is well adapted for passing round and spraying Cob-nuts, bush trees, and young standard trees, or rows of trees in nurseries, while taller ones could be sprayed with the help of a boy. The price is 35s. complete, and it delivers Paris green or other insecticides readily. Its weight when full is 40 lbs., and it will then work for two hours without recharging, effecting economy in the liquid used and delivering a fine spray covering all parts of the foliage. The Judges recommend a first-class certificate for this machine.—Agents, Messrs. Chas. Clark & Co., 20, Great St. Helens, London, E.C.

Hemingway's American spraying machine was next examined. These exhibited stood on three legs, but can be fixed on a water-barrel, paraffin cask, or to be fed from a pail. It is remarkably easy in action and simple in construction, delivering a dense spray in a con-

siderable volume as high as 20 feet. The nozzles used are simple in character and unlikely to get out of order, while two and three can be used on one delivery, the latter combination throwing such a stream of well-diffused spray that a large tree could be covered in one minute. The Judges consider this machine most valuable when furnished with two outlets, as one can be turned into the vessel and used to keep the contents in motion for effecting a complete mixture, and thus preventing injury to foliage by its being applied of unequal strength. The flow of spray is continuous and powerful, and the machine is equally valuable as a sprayer for Hops, tall or dwarf fruit trees, and also as a fire-engine. The recent machines are made in gun metal, and appear strong and durable. The price, with one suction and two delivery hoses, pipes, and nozzles complete is £4 2s. 6d., a similar machine with one delivery being £3 10s. The Judges recommend this a first-class certificate.—Messrs. Hemingway & Co., 60, Mark Lane, London, E.C.

Snow's patent garden pump is a compact machine which can be easily worked by a boy; it can be fastened in an ordinary pail, and works most easily, delivering a continuous stream of water, which can be charged with insecticides if desired, and this stream is broken up into a fine vapoury spray by contact with a cleverly designed jet called "Snow's patent helmet sprayer," which can be adjusted readily to suit the plant or tree acted on. The inventor has also introduced a capital plan of shutting off the outflow, thus economising the solutions used, and permitting movement from tree to tree without waste. The Judges consider this a very useful invention, specially fitted for syringing or spraying wall trees, Roses, and fruits of moderate height, as well as for garden use generally, the price being 40s. complete, and they recommend it for a first-class certificate.—Messrs. Osman and Co., 132, Commercial Street, London, E.

A. F. BARRON }
GEORGE BUNYARD } Judges.
J. WRIGHT }

P.S.—All the awards were unanimous.



FRUIT FORCING.

VINES.—*Watering, Feeding, and Mulching.*—From the time the Vines are started until the fruit ripens they must not lack moisture at the roots. It is extremely difficult to state how often the borders must be watered, through these being so variable in soil and dimensions, in depth, and in their formation. A narrow border will need watering twice as often as one double the width; and a border of loose material will require water much more frequently than one formed of firm retentive soil, consequently the cultivator must be guided by the state of the Vines in relation to their rooting area. The proper plan is to examine the border, and when water is needed give a thorough supply. Surface dressings of the approved advertised artificials, and supplies of liquid manure may be given. The borders having been dressed at the usual season—namely, whilst the Vines are at rest, a dressing after the Grapes are set, repeated about the completion of the stoning process will help considerably; the material as regards inside borders being at once washed in, or a good soaking at those times with liquid manure, and when the fruit commences to colour will assure the berries swelling to a good size. In the case of Vines restricted to narrow borders higher feeding will be necessary, affording liquid manure whenever there is need of moisture. Supply a mulching a couple of inches thick of rather lumpy manure, the best being stable manure freed of the straw.

Late Vines.—Syringe those that have commenced growth two or three times a day, endeavouring to secure an even break by closing with a moist atmosphere of 75°. Employ fire heat as may be necessary to secure a minimum of 55°. Vigorous young Vines do not start regularly, therefore to prevent a rush of sap to the upper part of the canes they should be brought into a horizontal position until all the buds have started.

Young Vines.—Vines planted last year, and cut back to the bottom of the rafter or trellis at the winter pruning, must be encouraged by gentle fire heat, so as to allow time for their making and perfecting a good growth. The laterals must have their points pinched out at the first leaf up to a height of 6 feet of the current growth on the canes, which will cause the buds in the axils of the principal leaves of the canes to form fruit buds and become plump for next season's fruiting, but above that height may be allowed to grow.

Vines for Early Fruiting in Pots.—Cut-backs of last year's raising should receive their final potting; 12-inch pots are a proper size. They should be clean and efficiently drained, potting firmly in turfy loam, with about a tenth of old mortar rubbish and a twentieth of steamed bonemeal thoroughly incorporated. Bottom heat is not necessary, but if they have been plunged in it, and if it had recourse to for accelerating root action it should not exceed 80° to 85°, and they must not remain in that so long that the roots enter the plunging material.

Keep the house rather close, and if the weather be bright shade for a few days. It is essential that the canes be trained near the glass to insure the solidification of their growth. Pinch the laterals at the first joint and subsequent growths treat similarly, stopping the lead at 6 to 8 feet according to the length of cane desired.

Planting Young Vines.—This will require to be done when the young growths have extended an inch or two, which, when the Vines have been kept cool, occurs early in April. Where provision has been made for inside and outside borders the Vines should be planted in the former, confining the roots to it until they have well occupied the available space, in fact a 4 to 6 feet width of border is sufficient in the first instance. The Vines, if cut-backs of last year, may be shaken out and placed in position either before or after they have grown to the extent of a couple of inches, the roots being disentangled and spread out evenly in the border, covering them about 3 inches deep, and watering moderately to settle the soil about them. Vines of the present year's raising will not require to be planted out for some time yet. They are preferably raised in squares of turf, and may be planted when the roots are protruding through the sides, or if in pots they should be turned out before they become root-bound. They will require to have a temperature at planting out suitable to Vines in growth—namely, 65° at night and 70° to 75° by day, with an advance of 10° to 15° with sun, but Vines of last year should be allowed to start unaided, syringing them two or three times a day according to the weather.

THE FLOWER GARDEN.

Dahlias.—Spring-struck plants with a single stem usually succeed better than do old roots, or divisions of the same furnished with several strong shoots; and propagating by cuttings is also the readiest method of increasing the stock of desirable varieties. The old roots being introduced into gentle heat soon produce a considerable number of young shoots, and these should either be taken off with a heel when about 4 inches high, or else longer shoots may be cut to a joint, though this must be done before the stems become hollow. Dibble the cuttings singly into thumb pots filled with sandy loamy compost, and plunge in a moderately brisk bottom heat. They require to be watered rather sparingly, and not be kept very close till rooted, otherwise they will damp badly. Being shifted into 5-inch or rather larger pots, they will make strong plants by bedding-out time. If no attempt is made to raise fresh stock from cuttings, the old roots ought to be kept dry and cool for five or six weeks longer, or they will be too forward. Dahlia seed sown in pans and placed in gentle heat germinates quickly, and the seedlings being duly pricked out or potted off a number of strong plants will be available for bedding out in June. Seedlings, however, seldom equal named varieties.

Salvia patens.—This rich blue Salvia is almost indispensable for mixed beds and the back rows of ribbon borders, and those who have strong roots of it stored away in boxes ought to introduce these into moderate heat at once. They will most probably push up a number of cuttings, which should be early taken off and rooted in close frames or in Cucumber or other hotbeds. When long enough a cutting may be taken from each well-rooted young plant, the latter being soon after placed singly into 3½-inch pots.

Verbenas.—These are among the most effective bedding plants, and being less often met with than in former years, are more to be valued accordingly. Hard, insect-infested cuttings are of little worth; these, even if they can be rooted, rarely attaining a serviceable size. If the pots of autumn-rooted cuttings are given a shift, and are kept in moderate and not too dry heat, they will grow strongly and yield abundance of sappy quickly rooting cuttings. Cuttings inserted in a layer of soil over a gentle hotbed as late as the first week in May would develop into capital plants by the time they are required. Beds of seedling Verbenas in mixture are very attractive. The seed being sown in pans of fine light soil, and these set on a fairly brisk hotbed, duly watered, covered with squares of glass, shaded, and otherwise well attended to, ought to germinate in the course of about three weeks, though it is sometimes much longer in doing so. Prick out the seedlings into pans or boxes of rich loamy soil, stop once, and transplant direct to where they are to flower. The old *Verbena venosa* can also be raised from seed, but the stock is best obtained by means of root cuttings. Supposing the long fleshy roots have been wintered under or in a shed, being surrounded by sufficient soil to keep them fresh, they may now be cut up into short lengths with one or two joints to each, and then be dibbled thickly, thinnest end uppermost, into boxes of fine sandy soil. Placed in gentle heat every cutting will grow, and the plants being given more room in other boxes will be quite strong by bedding-out time.

Sweet Peas.—Where there is a great demand for cut flowers some of the beautiful varieties of Sweet Peas ought to be raised under glass and planted out. This, in addition to forwarding them considerably, is also the surest method of obtaining plants from all the seeds. Not many of the latter go to a packet, in the case of the new named varieties at all events, and good care should therefore be taken of them. Sow five or six seeds in 3½-inch pots and place in gentle heat to germinate. When the plants are 3 inches high harden off and plant out on rich deeply dug soil before they become badly root-bound. A few pots might also be sown with the commoner varieties, white-flowered Peas being especially useful. Now is also a good time to sow rows or clumps of mixed varieties, a row of all white being grown in many gardens. If mice are troublesome coat the seed with red lead prior to sowing, and the young plants in all cases should be early staked and have plenty of soot dusted about them to keep off slugs.

Mignonette.—Much that has been just advised concerning Sweet Peas also applies to *Mignonette*. Of the latter there are many distinct varieties, a well grown collection proving very attractive. To have an early display, sow seed thinly in small pots, placing in gentle heat to germinate, eventually reducing the plants to about three in each pot, and planting out on good ground early in May.

Poppies.—The larger varieties are very gorgeous, but the Shirley and Iceland Poppies are by far the most popular. Autumn-raised plants of the former left on the open borders have mostly disappeared, but if a number of plants are raised in small pots and early planted out a good display may yet be had in June. The seed being very small and plentiful, cultivators are apt to sow it too thickly, and as nearly every seed germinates thinning out must be early and freely resorted to. If placed in gentle heat to germinate, the pots must soon be transferred to greenhouse shelves or light frames. Thin to about three plants in a pot, and plant out on a sheltered border before the pots become badly crowded with roots. More seed to be sown in a bed or in patches where the plants are to flower towards the end of March, and this will form a good succession to the plants raised under glass. The charming Iceland Poppies (*Papaver nudicaule*) if sown in the open any time during the spring will not flower this season, but would do so early next summer. By raising seedlings thinly in small pots and gentle heat, these being transplanted to a warm border as soon as well rooted, the majority will give a late summer display. Once a stock is obtained there will always be plenty of seedlings coming up about the place, and they are among the most beautiful border plants. Old clumps divide fairly well.

KITCHEN GARDEN.

PEAS.—Any Peas raised in pots, troughs, turves, or boxes, for transplanting to the open ground ought not to be kept long in such close quarters, or they will become root-bound and stunted in growth. Take advantage of the first favourable opportunity for planting them on well prepared ground, the preference being given to a sunny position, sheltered walls not being indispensable for this crop. An exception, however, may well be made in favour of the early dwarf varieties, notably American Wonder, Chelsea Gem, and William Hurst. Some of these might be planted in rough frames and pits, a gentle bottom heat and rough protection giving these a good start. If more are planted on a slightly raised ridge of soil at the foot of a south wall these would afford two or three gatherings in close succession to the frame-grown crops.

SUCCESSIONAL PEAS.—The weather and state of the ground during February were favourable to seed sowing. Directly the earliest Peas show through the ground more seed ought to be sown, or there may be a break in the supply. Those who have to deal with cold, heavy soils, if they are experienced in the matter, rarely venture to sow the wrinkled seeded varieties before the first or second week in March, as they are liable to decay. In order, therefore, to obviate any risks there may be in the succession it is advisable to make another sowing of William I., and with this one or more second early varieties, some of the best of which are Telephone, Telegraph, Duke of Albany, Paragon, Stratagem, Wordsley Wonder, and Sutton's Early Marrowfat. With any of these might also be sown either Criterion, Huntingdonian, Satisfaction, President Garfield, Anticipation, Dr. McLean, Marvel, Princess Royal, or any other well-tried third early variety, and in this manner the succession will be unbroken. Peas ought to have the benefit of freely manured, trenched or deeply dug ground, preference being given to an open position. Dispose the rows fully as far apart as the known height of the varieties, and sow the seed thinly in wide drills. If mice are troublesome coat the seeds with red lead.

BROAD BEANS.—If seeds were sown in the open or on a warm border at the same time as the earliest Peas the plants will soon be through the ground, and more seed ought at once to be sown. Beck's Dwarf Green Gem is one of the best varieties for both early and successional crops; the small size, colour, and quality of the young Beans suiting the wealthier classes better than anything tried against it. It is of dwarf branching and very productive. Sow thinly in single rows 2 feet apart, if preferred, more seed of a selected early and long pod, and also a good broad podded variety, this ensuring the requisite succession. These may be sown in single drills 2 feet apart, or be dibbled in on double lines, with 3 feet spaces between.

SPINACH.—Where the breadths of autumn-sown Spinach have survived the winter, and this crop has done so in most districts, it is advisable to distribute soot, guano, or some artificial manure between the rows, and lightly stir it in with the flat hoe. This being done in showery weather, there will soon be a marked improvement in the vigour of the plants, and the supplies of succulent leaves be well sustained till the earliest February sown crops are available. Each time Peas are sown Spinach also should accompany them, the latter being sown in shallow drills midway between the rows of the former. The ordinary summer or round seeded Spinach answers fairly well, but compares badly with the Victoria and Monstrous Viroflay. Only one of the two last-mentioned need be grown, and the seed should be sown somewhat thinly, in order to give the plants an opportunity of developing their fine leaves.

PARSNIPS.—If large roots of these are required, then ought the seed to be sown somewhat early and on ground deeply dug, animal manure, if any is used, being buried 2 feet below the surface. This is necessary in order to guard against the possibility of the tap roots coming into contact with it before the desired length is attained, forking inevitably resulting if this precaution is not taken. For ordinary purposes

medium-sized to comparatively small roots are to be preferred, these also keeping best. The seed may be sown any time during March or even in April, and if the site selected was well manured for a preceding crop, digging and pulverising is all the preparation needed. Shallow drills may be drawn 15 inches apart, and the seed sown either thinly or in small patches 12 inches apart.

TURNIPS.—White varieties failed to withstand the long spell of frosty weather, and there is every prospect of a scarcity of Turnips generally in many places. Seeing that there is always a steady demand for them, something will have to be done to raise young ones as quickly as possible. The Extra Early Milan "bulbs" very quickly, and is amenable to gentle forcing. If a glazed frame cannot be spared, and there are no light borders in unheated fruit houses available for raising a few bunches of early Turnips, temporary frames with thatched hurdles or mats for covering them during cold nights may be used instead. A slight hotbed surmounted by 8 inches of rather strong loamy soil is all the further preparation needed. Sow the seed thinly broadcast, and cover with sifted soil. Give abundance of air. Thin out early, leaving the plants 5 inches apart each way, and commence to draw for use when the earliest roots are rather larger than Turnip-rooted Radishes. Those left if kept well supplied with water will continue to swell at the roots, a surprising number of really good Turnips being had from a frame. When the seed is sown on warm borders progress is slow, premature flowering more often than not resulting. It is advisable, however, to sow a pinch of seed at once on the chance of getting a few roots fit for soups if for nothing else. A south-east border suits early Turnips, and they would pay well for some kind of temporary protection.

FORWARDING PERMANENTLY PLANTED ASPARAGUS.—Asparagus permanently planted in raised beds may be forwarded considerably without sustaining any serious injury thereby. It is next to useless, however, to make the attempt with a short length of bed, but a grand supply of shoots would be obtained from a length of about 12 yards. Span-roofed frames would be well adapted for covering the beds, but failing these enclose the beds with stout 11-inch boards nailed to short thick stakes, these to support either glazed lights or else cross pieces and mats. The 2 feet or rather wider pathways on each side of the bed about being forced to be next dug out to a depth of 2 feet, a little of the best soil being spread over the bed, and the rest wheeled away to a convenient yet not conspicuous spot, as it will be wanted again. Fill the trenches with nearly fresh strongly heating stable manure, making this rather firm and banking it up to the sides of the frames. The lights or mats being covered with more of the same no heat will be lost, and it will not be long before a gentle warmth pervades the beds and starts the Asparagus. Cutting ought to commence in about three weeks, and may be continued till unforced shoots are plentiful. If green Asparagus is preferred to blanched shoots light should be admitted after active growth commences, covering up again early every evening. The bed adjoining that being forced will also be slightly forwarded, and if this is covered with a few inches of litter this will protect the early shoots from frost till they are long enough to cut. Directly Asparagus is plentiful cease cutting from the covered bed, remove the frames and the manure from the trenches, and return the soil. Beds thus treated may be forced every second season.

THE BEE-KEEPER.

APIARIAN NOTES.

PREVENTING SWARMING.

In previous articles I have explained that swarming under certain circumstances cannot be prevented, be the race of bees what it may, but at the same time gave the most likely methods to lessen the propensity and increase the yield of honey. I have shown that Carniolians are not greater swarmers than other varieties when managed properly and in accordance with their nature, and I can say with confidence that my experience has been longer and perhaps greater than any other British bee-keeper. Fortunately I am in possession of the pure breed. American bee-keepers appear, however, to be pleased with yellow banded bees as a pure type of Carniolians, but from what I have seen of them they are more like Syrian bees. Carniolian bees are not striped. It is impossible to comprehend the reason why intelligent people so readily believe the ridiculous statements that bees can be prevented swarming by simply making the hive larger. They cannot. The following from "My Bee Book," by the Rev. W. C. C., is substantially the truth on preventing swarming.

"It is not to be done by monster hives, or by ventilation, or by adding supers. If the bees swarm they will. They are 'a stiff-necked generation' and know their own business, at least they think

so, better than we men can teach them. Our objects, however, are slightly different—theirs to propagate and preserve their species, ours to secure the maximum amount of honey in any given locality. I have known a swarm sent forth from a *Ruche à Vair libre*, a French hive, which I worked in New Zealand. The combs and bees were entirely exposed to the external air, which was not then particularly warm; but a swarm was ready to go, so off they went." It is a question whether bees can think, but they certainly act in every respect as to swarming as is stated in the quotation, and bee-keepers will have less disappointments if they use the precautions I have advised than if they listen to any argument that swarming can be prevented by giving room in time either above or below the bees.

UNITING ALIEN QUEENS.

This is another subject that I have fully commented upon, and have shown how to avoid risk in losing valuable queens, and will not at present enlarge upon the different methods, confining myself entirely to the method wherein there is no risk whatever, which is most wanted, as correspondence shows that many bee-keepers lose their valuable imported queens, especially in those cases where "direct introduction" has been followed. Except in the cases of queenless hives, queen introduction was not studied till after the introduction of the Italian Alp bee. Herman in 1860 sent out his little treatise on these superior insects, which Mr. A. Neighbour had translated into English. He advised, for safety to the alien queen, to strengthen the little nucleus with worker brood "ready to creep out of the cells" after the fashion in which we used to strengthen weak after swarms with the brood, that we found in driven hives for nearly thirty years previous, or what had been the custom of the bee-keepers from time immemorial. When an inexperienced bee-keeper procures a valuable queen, select a frame of the most advanced brood, or better two, or even three, place these in a nucleus box, then liberate the queen and the bees accompanying her amongst the combs, cover all cosily, close the entrance, but leave enough opening for ventilation, place the hive inside, and in a warm position, so as to prevent chill as much as possible. The success of this depends greatly upon the advanced stage of the brood; if the bees are ready to creep out of the cells there will be a cluster of them surrounding the queen in a few hours, and, if there is no unsealed brood, the most of it will hatch out. After a day or two the brood may be supplemented by additional ripe brood combs, and so on until the hive is of the required strength, when it should be placed outside for a short time during the heat of the day, so as to give the oldest bees a chance to air themselves, which, all things being favourable, occurs about the fifth day after hatching. After the bees are returned to their hive they may be taken in again, but as the bees by this time will be numerous the hive must be kept away from artificial heat. The housing again at this stage is simply to avoid robbers until the bees are old enough to act in their defence. If this plan is judiciously carried out there will be less heard of queens being lost, and the plan is worth trying by a beginner. I have been often successful with it myself.

RENEWING COMBS.

This, too, is an old practice. I do not know when it originated, but I know that it has been practised in Scotland for long, as well as that of renewing queens. I know at least for a century, and perhaps two, the Scotch renewed their combs and queens annually; nothing older than a year with either was kept, and the union of stocks by sprinkling with peameal is perhaps of as early a date. I remember its being done upwards of fifty years ago.

A CAUTION.

The usual time combs were renewed, or rather removed for renewal, on the twenty-first day after the first swarm has issued, on the supposition that all but a few drones would then be hatched, and no brood would be in the hive. Under certain circumstances this is sometimes correct, but it just as often happens that it is

not. At times owing to the weather the swarm may be delayed for some days, and the royal cells may be approaching maturity, which will be hatched, and after swarms pass off within a week after the first swarm, when mating may follow any day. I have often seen hives at the end of three weeks from the first swarm leaving with ten days' eggs and larvæ of the new queen.

So in the event of certain hive's combs being condemned be careful valuable brood be not destroyed. It is better to wait till there is a surplus of combs of the current year, which may take the place of condemned ones, but be also very careful that foul brood is nowhere present. If so let every hive hang by itself, and raise combs from sugar good for the purpose, and best for wintering bees.

COMB MAKING.

Since I made experiments upon the quantity of sugar required to produce a pound of wax, and exposed the absurdity that 20 lbs. of honey was necessary to produce a pound of wax, the information has spread to the continents of Europe and America, and has appeared in books treating upon the subject of bees, honey, and wax.—A LANARKSHIRE BEE-KEEPER.

COVENT GARDEN MARKET.—MARCH 25TH.

BUSINESS very dull, and market well supplied with all classes of hothouse goods.

FRUIT.

	s.	d.	s.	d.		s.	d.	s.	d.		
Apples, ½ sieve	1	6	to	6	0	Lemons, case	15	0	to	20	0
" Nova Scotia and						Melons, each	0	0		0	0
" Canada, per barrel	15	0		26	0	Oranges, per 100	4	0		9	0
Grapes, per lb.	2	0		4	0	St. Michael Pines, each..	3	0		8	0
Kentish Cobs	40	0		45	0	Strawberries, per lb. ..	6	0		12	0

VEGETABLES.

	s.	d.	s.	d.		s.	d.	s.	d.		
Artichokes, dozen	0	0	to	0	0	Mushrooms, punnet ..	1	6	to	2	0
Beans, Kidney, per lb. ..	2	3		2	6	Mustard & Cress, punnet	0	2		0	0
Beet, Red, dozen	1	0		0	0	Onions, bushel	8	0		4	0
Brussels Sprouts, ½ sieve	3	0		4	0	Parsley, dozen bunches	2	0		8	0
Cabbage, dozen	3	0		0	0	Parsnips, dozen	1	0		0	0
Carrots, bunch	0	4		0	0	Potatoes, per cwt.	8	0		4	0
Cauliflowers, dozen	3	0		6	0	Rhubarb, bundle	0	2		0	8
Celery, bundle	1	0		1	3	Salsafy, bundle	1	0		1	0
Cleworths, doz. bunches	2	0		4	0	Scorzoneria, bundle	1	6		0	0
Cucumbers, doz.	4	0		8	0	Seakale, per bkt.	2	0		2	6
Endive, dozen	1	0		0	0	Shallots, per lb.	0	3		0	0
Herbs, bunch	0	2		0	0	Spinach, bushel	5	0		6	0
Leeks, bunch	0	2		0	0	Tomatoes, per lb.	0	0		0	8
Lettuce, dozen	3	0		3	6	Turnips, bunch	0	0		0	4

AVERAGE WHOLESALE PRICES.

CUT FLOWERS.

PRICES will vary more this week on account of Easter decorations.

	s.	d.	s.	d.		s.	d.	s.	d.		
Arum Lilies, 12 blooms ..	3	0	to	8	0	Mimosa (French), per					
Azalea doz. sprays	0	6		0	9	" bunch	1	0	to	1	6
Bouvardias, bunch	1	0		1	6	Narciss (Paper-white),					
Camellia, white, per doz.	2	0		4	0	" French, doz. bunches ..	3	0		5	0
" red	1	0		1	6	Do. Do. English,					
Carnations, 12 blooms ..	1	0		2	6	" per bunch	0	9		1	0
Christmas Roses, dozen					0	Narciss (Various) dozen					
" blooms	0	0		0	0	" bunches, French	2	0		4	0
Cineraria, 12 bunches ..	6	0		9	0	Pelargoniums, 12 trusses	1	0		1	6
Cyclamen, doz. blooms ..	0	3		0	6	" scarlet, 12 bunches	6	0		9	0
Daffodils, doz. bunches ..	2	0		6	0	Poinsettia, dozen	0	0		0	0
Eucharis, dozen	3	0		6	0	Primula (double) 12 sprays	0	6		1	0
Gardenias, per doz.	3	0		6	0	Primroses, dozen bunches	1	0		2	0
Hyacinths (Roman), doz.						Roses (indoor), dozen ..	0	6		1	6
" sprays	0	6		1	0	" Red (English) per					
Hyacinth, Roman (French)						" dozen blooms	4	0		8	0
" doz. bunches	3	0		6	0	" Red, 12 bls. (Fench.)	2	0		4	0
Lapageria, 12 blooms ..	2	0		4	0	" Tea, white, dozen ..	1	0		3	0
Lilac (French) per bunch	4	0		6	0	" Yellow, dozen	3	0		6	0
Lilium longiflorum, 12						Snowdrops, doz. bunches	1	0		3	0
" blooms	4	0		6	0	Spiraea, per bunch	0	6		0	9
Lily of the Valley, dozen						Tuberose, 12 blooms ..	1	6		2	0
" sprays	0	6		1	0	Tulips, per dozen	0	9		1	6
Maidenhair Fern, dozen						Violets (Parme), per beh.	2	6		4	0
" bunches	4	0		9	0	" (dark), per beh. ..	1	6		3	0
Marguerites, 12 bunches	4	0		6	0	" (English), doz. bunch	1	0		2	0
Mignonette, 12 bunches ..	3	0		6	0	Wallflower, doz. bunches	1	6		2	6

PLANTS IN POTS.

	s.	d.	s.	d.		s.	d.	s.	d.		
Aralia Sieboldi, dozen ..	6	0	to	18	0	Foliage plants, var., each	2	0	to	10	0
Arbor Vitæ (golden) doz.	6	0		8	0	Genista, per doz.	8	0		12	0
Azalea, per plant	2	0		3	6	Hyacinths, doz. pots ..	6	0		9	0
Cineraria, per doz.	6	0		9	0	Lily of the Valley, per pot	1	0		2	0
Cyclamen, per doz.	9	0		24	0	Marguerite Daisy, dozen	6	0		12	0
Dielytra spectabilis, per						Mignonette, per dozen ..	6	0		9	0
" dozen	8	0		12	0	Myrtles, dozen	6	0		12	0
Dracæna terminalis, doz.	24	0		42	0	Palms, in var., each ..	2	6		21	0
" viridis, dozen	12	0		24	0	Pelargoniums, per doz. ..	0	0		0	0
Erica, various, dozen ..	12	0		18	0	Poinsettia, per doz. ..	0	0		0	0
Euonymus, var., dozen ..	6	0		18	0	Primula sibirica, per doz.	4	0		6	0
Evergreens, in var., dozen	6	0		24	0	Solanums, per doz.	9	0		12	0
Ferns, in variety, dozen ..	4	0		18	0	Spiraea, per doz.	8	0		12	0
Ficus elastica, each	1	6		7	0	Tulips, dozen pots	6	0		8	0

Bedding plants (in variety) in boxes, from 1s. to 8s.



TO CORRESPONDENTS

All correspondence should be directed either to "THE EDITOR" or to "THE PUBLISHER." Letters addressed to Dr. Hogg or members of the staff often remain unopened unavoidably. We request that no one will write privately to any of our correspondents, as doing so subjects them to unjustifiable trouble and expense.

Correspondents should not mix up on the same sheet questions relating to Gardening and those on Bee subjects, and should never send more than two or three questions at once. All articles intended for insertion should be written on one side of the paper only. We cannot reply to questions through the post, and we do not undertake to return rejected communications.

Bulbs Failing (*G. F. B.*).—We have sometimes known the growth of bulbs to be injured when passing through the soil by the rupturing of the tissues by frost, the ice crushing them so to say; but as you say the injury to yours only occurs in patches, that can scarcely be the cause in this case, if all the bulbs are in the same stage of growth. To one practice that is common in connection with planting Hyacinths and Tulips you make no reference—namely, mulching the beds. If this was done in your case it is quite possible that there may have been something of a poisonous nature to vegetation in the material, and it is as likely to be in patches as not, if not more likely. If you have not mulched the beds, we still think something has found its way to them that has caused the evil in question, and that the mould you find is the consequence of sap stagnation and decay. The bulbs are very good.

Mildew on Tomatoes (*F. W.*).—We do not think there is any cause for alarm—that is to say, if the plants you have sent are fairly representative of the collection. The attack of mildew is very slight, and is not at all uncommon on the lower leaves, from which the sap is diverted by the stronger growth above. You have done right in removing the imperfect leaves, also in adopting preventive methods against further fungoid attacks. We suspect your plants will improve with the weather, and should have all the sun and air possible consistently with free unchecked growth; sharp currents, or a check or chill from any cause, predisposing the plants to attacks of mildew.

Wireworm in Flower Beds (*J. V.*).—Cut some Carrots into pieces transversely about 1½ inch long, thrust a pointed stick into each so as to get a good hold, insert these about 6 inches apart 2 to 3 inches deep all over the flower bed, covering with light soil. Examine these every morning, withdrawing the pieces of Carrot by taking hold of the stick, and the wireworm will be found eating into the Carrot, from which remove and destroy, replacing the baits in the soil as before. Renew the baits when necessary, and by continuing this for a few weeks the wireworm will be much reduced if not exterminated. If Carrots cannot be had for baits, Potatoes with the eyes cut out may be used instead, cutting them in halves or fair sized pieces.

Duke of Buccleuch Grape (*H. A. P.*).—We do not know the precise parentage of this fine Grape, but the raiser, Mr. W. Thomson, Clovenfords, can perhaps give the information. We are pleased to hear you find it so satisfactory, and we cannot imagine how anyone could arrive at a different conclusion who succeed in growing the noble duke well. As a rule the best results follow either the young rod or long spur system of management, and we have only seen a few exceptions. If you send 3½d. in stamps to the publisher, and ask him to send you the number dated March 8th, 1888, we think he can find you a copy containing the notes to which you refer.

Pruning Outdoor Fig Trees (*B.*).—These only require to have the branches or shoots thinned, as they bear best on the extension system. Old bare branches should be cut out to make room for young and fruitful growth; the extremity branches of trees on walls may be cut back to successional wood, conveniently placed for supplanting them, the remainder of the branches being thinned so as to leave them not less than a foot apart, with bearing shoots equally disposed over the tree. This is best done in spring before growth takes place, but during growth the shoots must not be crowded, and if thinning be properly attended in summer little pruning will be needed in winter. The extension growths and those not required should be cut out immediately the fruit is gathered. This will assist the growths left to ripen, and on the ripening of the wood in a great measure depends the future crop of fruit.

Yellow Sweet Sultan Unsatisfactory (*Kent*).—This is very liable to damp off, particularly in heavy soils, being attacked by a fungus which destroys its tissues near the surface of the soil similar to the disease attacking Humeas and Calceolarias. Slugs are also very partial to the plants, eating them quickly if not prevented. We have found the plants grow best in loam of medium texture overlying gravel. Where the soil is not naturally porous and deficient in lime we have found mixing sand and other opening material with the soil advantageous, mixing a 3-inch layer of old mortar rubbish with the top spit of soil, and using some fine light soil on the surface for sowing the seeds

in. Charcoal refuse we have found excellent for mixing with the soil and placing over the seeds when sown. The Yellow Sultan does not like a heavy wet tenacious soil.

Winter Moth (*Sussex*).—It is as yet too soon to spray for the destruction of the larvæ of this pest. Miss Ormerod states in the recently issued pamphlet, "Paris Green, its Uses, and Methods of Application, as a Means of Destruction of Orchard Moth Caterpillars," that "The amount recommended in Canada for spraying for codlin moths or young "looper" caterpillar is not more than from 2 to 4 ozs. in 40 gallons of water, or ½ to ¼ oz. in a pail of water (4 gallons), to be applied as a fine spray by means of a force pump. The foliage must not be drenched, but the spray should only be allowed to fall upon the trees until it begins to drop from the leaves. For general use on mature foliage:—½ lb. of Paris green, 50 gallons of water. First mix the Paris green separately with a small quantity of water, then add to it the whole supply. All water containing Paris green must be constantly 'stirred' to keep it in suspension, or it will sink to the bottom." The Committee of the Evesham fruit district recommend "Paris green paste in the proportion of 1 oz. to 8 or 10 gallons of water for Plums, and 1 oz. to 20 of water for Apples." Care must be used in sprayed trees with Paris green, taking the greatest precautions against accident to man or beast.

French Beans (*S. J. A.*).—We can only suggest that you write to Sir Henry Thompson for the explanation you appear to desire of a sentence you have twice quoted from his work. We will put our view of the case in language which cannot be misunderstood. French Beans are Flageolets, and Flageolets French Beans. The Negro Long-podded is a typical form of the Dwarf Kidney (or French) Bean, grown in this country, and it is called in France the Black Flageolet. Mixing the sliced tender pods of these with the older yet succulent Mange-touts containing tender beans is a question of taste, and probably the addition of the latter would render the dish more nutritious. On that question you may safely follow Sir H. Thompson. There are no doubt many varieties of Flageolets grown in France that are not generally grown in Britain, and *vice versa*. It is the same in respect to Peas, and only shows that national tastes differ. We do not advise you to grow the Mont d'Or Butter Beans instead of Scarlet Runners, but to grow both. You will then ascertain which you like the best, and can also try the mixing process. The former is tender podded, the latter, after its early stage, tough podded, because of the absence of the horny membrane in one and its presence in the other. We grow both. They are quite distinct, some persons giving preference to one, some to the other.

Trees and Shrubs for a Wet Position (*Fen*).—For the low-lying ground, formerly a pond, and filled up with stiffish soil, about a quarter of an acre in extent, and which will always be rather moist, backed now by trees on all sides except that fronting the house, which stands on a much higher level, the planting of the old pond must depend something on the trees already round it, and whether it would be desirable to make that harmonise with the other trees, or to assume a distinct character of its own. In the latter case a quick and pleasing effect would be produced by using Willows and Poplars for light foliage, either without or in combination with some sombre-leaved Pines, and with an undergrowth of evergreens and other plants if desirable. Thus in such a place first there might be planted three good plants of the Babylonian or Weeping Willow, one of the White and two of the Duke of Bedford Willow, or Salix Russelliana; and mixed with these one plant of Populus alba, P. tremula, P. fastigiata, and P. balsamifera. Then the whole undergrowth might be a mass of Laurels, Privet, and Box, or walks might be made through it, and the following arranged in groups, so as to be very attractive, the last-named sorts being kept most to the outsides:—Evergreen Oaks, a few Hollies, common Laurels, Portugal Laurels, Boxes of sorts, Aucuba japonica, Daphne laureola, Arbutus unedo, Atriplex halimus; Rhododendrons if a little peat can be given them, and there is little or no calcareous matter in the soil; Hypericum calycinum, or St. John's Wort, and Laurustinus, keeping the latter chiefly at the outside. Second, If the Willows and Poplars should be too light you may mingle with them a few Pines, as Spruce Firs (Abies excelsa), Picea pectinata, and Pinus austriaca and rigida; but if these are encouraged to feather to the ground nothing else must be planted near them. Third, The Spruce Fir and Pinus austriaca and rigida would flourish pretty well in such a place, and would soon form a thicket of themselves; but if the place were desired to look well from the house, and to be a place of resort as well, then if such sombre trees were planted from 30 to 40 feet apart walks could be carried through the space, and the above evergreens thrown into groups in the open spaces, to which might be added such deciduous plants as Privet, Dogwood, &c. Fourth, If the surroundings admit of it, and as economy is your object, we would plant with Willows and Poplars, say from 30 to 40 feet apart, including a few Spruce, and then use Laurels for undergrowth, with a belt of Laurustinus for the outside.

Names of Plants.—We only undertake to name species of plants not varieties that have originated from seed and termed florists' flowers. Flowering specimens are necessary of flowering plants, and Fern fronds should bear spores. Specimens should arrive in a fresh state in firm boxes. Slightly damp moss, soft green grass or leaves form the best packing, dry wool the worst. Not more than six specimens can be named at once, and the numbers should be visible without untying the ligatures, it being often difficult to separate them when the paper is damp. (*W. S.*).—Apparently a strong plant of Pteris tremula (*H. R.*).—1, Aspidium coriaceum. 2, Lomaria ternata. (*J. C.*).—Lycaste Harrisonia.



THE LAMBING SEASON.

EARLY lambs have had the advantage of fine dry weather this season, and it is the late lambs of the present month that have had to encounter much snow and cold cutting wind from the north-east, and losses have been considerable. Losses we wish strongly to impress upon our readers, which, with very few exceptions, might have been avoided had only ordinary precautions been taken to afford such young and tender animals a reasonable amount of shelter.

There are many farmers who "lamb down" only two or three score ewes, and for so small a number it is not thought worth while making a special fold. The shelter to be had from hedges, buildings, or trees is thought sufficient, if any thought is given to the matter at all, and with favourable weather all may go well. But then the weather is precisely the factor upon which we can place no dependance, and there is a great deal too much of "winter sitting in the lap of spring" in our climate for any risk of the sort to be run with impunity. For example, in a certain flock under our notice, the lambing began in the first week of the present month in fine and exceptionally mild weather; but with the second week came the inevitable cold nor'-easters, with frequent snowstorms, and we were told of the loss of a fine strong lamb, which was followed by that of four others by the end of the week. It then occurred to the farmer that the flock was too much exposed in an outlying meadow, with nothing but the hedge for shelter, and they were taken into the home croft where the wind was less keen, but not a thatched hurdle, crib, or even a lamb cloth was to be seen on the farm.

This happened in a certain locality where all the holdings are small, and where every farmer has his small ewe flock, yet not one of them had a lambing fold, and I was not surprised to hear on the 14th inst. of the loss of twelve ewes in another flock. Those ewes had been allowed to fall into low condition last autumn, when feed was so scarce upon pastures. They were still more reduced during the long hard winter which followed the autumn drought so closely, so that they had insufficient sustenance during the whole period of gestation. Then came the exposure to the recent bitter weather, either during the lambing or very soon after it. Can we wonder that some of the sorely tried animals succumbed to it? Rather are we surprised that the losses are not heavier. When an animal is exposed to wet and cold much of its food goes to sustain vital heat and not to the nourishment of its body, and the strain upon ewes from such exposure tells both upon them and upon the lambs. They are reduced in strength just when they require to be kept in fair condition, and suffer accordingly, sometimes becoming so weak that a few days of cold weather at lambing time kills them outright.

Now one's scheme of management should rather aim at prevention than cure in this matter. We should so feed and shelter the ewes that there is but little, if any, risk of loss from exhaustion. Better practice in this should follow our recognition of the cause and remedy of exhaustion. It comes in most cases from an enfeebled condition. The ewes do not have enough food after the summer grass is eaten off; every foot of pasture is nibbled over again and again till it is quite bare. If snow falls thickly a little hay is given once a day, but there is no regular process of feeding, and yet extra food is required for nourishment at that time. Can we wonder, then, that ewes die of exhaustion after the severe strain of the lambing upon their half-starved bodies, or that cases of abortion are frequent? Then, too, how weak and

small the lambs are, for they have been badly nourished before birth, and fare very little better afterwards. The whole thing is a miserable fiasco, a caricature of farming which can have no satisfactory result. Profitable farming does not follow, has no connection with such faulty practice; better be without lard or flock than to turn them to such poor account.

Food and shelter are the two indispensables with which, and sound healthy ewes, there ought not, and indeed is not, much risk of loss; the risk is very much in proportion to an insufficiency of either. But the food must be wholesome and the shelter thorough. There must be no frozen Turnip diet, no muddy folds; the ewes must be kept on sound firm land, and have sound nourishing food. Strange indeed is it that such obvious truths are so frequently ignored. We call attention to them now while failures are in evidence, and hope that some effort at better practice may be the result. We must leave nothing to chance, but must always make provision for a scarcity of food and for hard weather. It may be well in another paper to show once more how this can best be done.

WORK ON THE HOME FARM.

Farm work in the south and west has been practically brought to a standstill upon the land by the sudden outburst of winter weather, and the chief business has been the extra care required by the live stock. The greatest difficulty with sheep has been among flocks in valleys or low-lying land where the snow drifted much. On the uplands there was comparatively very little difficulty, the chief one being the carting of food to the folds, which has been no light matter, as many of the roads were snowed up. The early lambs have had such a good time that they are fine sturdy animals, well able to encounter a change to colder weather. But late lambs have been confined to the large enclosure, which we always make alongside the lambing fold. This is surrounded by a straw wall made by placing parallel lines of hurdles about 18 inches apart, and cramming the space between them with straw or rough litter, the lambs are thus screened from cold winds and are kept sufficiently snug and warm. Silage, roots, and a few crushed Oats and bran keep the ewes going nicely, and they are only let out of the fold in suitable weather. Hoggets have been kept in the folds upon Swedes, with a change to pasture for a few hours daily. The Swedes now being used were placed in small circular heaps, and covered in the field in readiness for this folding. We did this because the roots were an early crop sown last year soon after the Mangolds, and so have avoided the loss of roots, which has been so serious on many farms this winter. This hint is worthy of attention now, for the time for root sowing will soon be here again, and we hold entirely with getting in most of the Swedes early. Late sown Swedes left-out have lost all green tops, but the small roots are otherwise uninjured.

Strongly do we advise all home farmers to rear as many calves as possible, and they ought to be able to do so, because there is always plenty of milk to spare for the purpose where so many cows are kept for a home dairy supply. Store beasts are both low in condition and high in price now, and anything like a profit upon their purchase seems impossible. We saw some sold at an auction sale in Leicestershire last week, at so high a price that the local term of "silly dear" was in the mouths of most of the company. If we would have store beasts profitable they must be well bred and home bred too.

METEOROLOGICAL OBSERVATIONS.

CAMDEN SQUARE, LONDON.

Lat. 51° 32' 40" N.; Long. 0° 8' 0" W.; Altitude, 111 feet.

DATE.	9 A.M.					IN THE DAY.				Rain.
	Barometer at 32° and Sea Level.	Hygrometer.		Direction of Wind.	Temp. of soil at 1 foot.	Shade Temperature.		Radiation Temperature.		
		Dry.	Wet.			Max.	Min.	In sun.	On grass.	
1891. March.	Inches.	deg.	deg.		deg.	deg.	deg.	deg.	deg.	In.
Sunday	29.654	38.0	34.8	S.E.	33.5	41.6	31.3	63.1	25.8	0.223
Monday	29.573	39.3	39.6	S.E.	33.6	47.4	26.1	74.9	39.7	0.051
Tuesday	29.573	41.1	40.8	N.E.	38.9	47.1	37.4	53.8	30.4	0.069
Wednesday	29.563	42.4	42.0	N.E.	39.9	43.1	41.1	58.8	36.9	—
Thursday	29.879	49.4	37.3	N.	39.7	41.3	34.2	92.1	29.5	—
Friday	29.491	37.9	35.4	W.	39.1	46.9	33.2	19.6	23.1	0.010
Saturday	29.838	37.7	35.2	N.	36.9	43.6	31.8	88.3	26.7	0.039
	29.701	39.5	37.9		39.1	45.6	34.9	74.4	29.7	0.333

REMARKS.

15th.—Sunshine early, cloudy morning, drizzle in afternoon, rain from 6 to 11 P.M.
16th.—A little sun early, frequent showers from 8 A.M. to 2 P.M., some sunshine in afternoon.
17th.—Overcast, with constant drizzle and showers.
18th.—Overcast throughout. The last remnants of snow drifts nearly gone.
19th.—Fine with frequent sun, but a few flakes of snow at 4.30 P.M.
20th.—Alternate sunshine and spots of rain, and a heavy shower at 4.15 P.M.
21st.—Generally cloudy with occasional flakes of snow in morning, a heavy shower of soft hail at 6 P.M., then fine and bright.
Temperature not so low as in the previous week, but still below the average.—
—G. J. SYMONS.



DDOUBLE Violets give a better return for the small amount of labour required to have them in good condition than do any other winter flowering plants, and flowers can be had from the same plants during fully six months, commencing early in October. A succession may even be had during such a winter as that through which we have passed. All that is required to ensure the object is to grow a few dozen plants beyond those needed for the frames and establish them in boxes or pots to be placed on a shelf close to the glass in a vinery or Peach house, or anywhere from which frost is excluded without the necessity of having to cover the glass for that purpose. The advantage of growing these extra plants was fully proved during December and January last, when for many days the frost was so severe that the lights could not safely be removed from the frames, even to gather the flowers.

Much depends upon the soil at hand whether success will be achieved easily or not. In sandy loam Violets grow freely with little trouble, while in some kinds the plants will barely exist. The soil here is heavy, retentive, and consequently cold during the spring months. The leaves of the plants when growing in this soil without any other material being added, are extremely pale in colour, and very small. They are always infested with red spider consequent on the want of vigour. Under adverse circumstances like these Violet culture is a difficult matter, still success may be assured if the right method is adopted, and which I will explain. The end of April is a suitable time to commence preparing the stock for next year. Plants now flowering will by the time named be ready to be divided; the strongest grown roots may be pulled into pieces of one crown each, weaker roots may have two or three crowns together if the stock is to be increased.

The runners growing from the base of the old roots make excellent plants for next season's supply of flowers, and are preferable, but they cannot always be had in sufficient numbers, therefore we are obliged to divide the old roots. Our plants are grown on an east border, allowing sufficient space between the rows and the plants for cleaning purposes, and removing the runners as fast as they appear. This is important, as then the energy of the plant is wholly concentrated in the crown of each, with a greater prospect of a full supply of flowers. If the soil be of a sandy character, and has been manured for the previous crop, nothing more will be needed for the Violets. It is not desirable that the plants should make a superabundance of foliage at any period of their growth. If the soil is heavy dig it deeply in the autumn, and when planting commences chop out a trench with a spade, fill with leaf soil, in which the Violets can be planted 10 inches apart, in rows 1 foot asunder for the convenience in stirring the soil during the summer, a great help to the growth of the plants. We spread a thin coat of leaf soil over the surface of the soil after planting, which prevents it cracking during dry weather, retains the moisture in the soil, and thus minimises the attack of red spider on the foliage. In sandy soil none of this extra trouble is needed, the plants may be dibbled in 1 foot apart all ways, and beyond an occasional stirring of the soil with the hoe during the summer nothing more is required. Should the weather be hot and dry at the time of planting some shade given to the plants will be a distinct gain. Nothing is better than evergreen boughs thrust into the soil between the rows. The plants will derive much benefit from a thorough soak-

ing of water to the roots occasionally if the weather be long continued hot and dry. This completes what I term the summer culture.

The next consideration is their winter quarters. We flower the bulk of our plants in a cold frame on a warm sunny border in the kitchen garden, although exposed to easterly winds. The plants succeed much better when growing close to the glass, yet I do not think it is either necessary or desirable to fill the frame with manure or any other such material with the object of raising the plants, and as I do not believe in bottom heat as some growers do, and for reasons which I will state. At the bottom of the frame I place a layer of faggots, for a twofold object—viz., raising the plants near to the glass and permitting of thorough drainage, as I find the roots are waterlogged if the development of the blooms is retarded.

On the wood a thin layer of stable litter is placed to prevent the fine soil running down among the faggots. Over the straw a layer of last year's leaves is placed; into this the roots of the Violets find their way, they being especially partial to decayed leaves. The soil we use is mainly composed of roadside refuse, with which is mixed a quantity of grit that assists in keeping the whole porous. To this we liberally add decayed leaves, with the addition of a small quantity of manure from a spent Mushroom bed—say, one part of leaves and manure to two parts of the soil; this compost is about 9 inches thick. The plants are then lifted with a good ball of soil and roots attached, and planted in the frame, allowing just sufficient space between them, so that the leaves of one plant do not quite touch those of its neighbour. In our case it is not necessary to give more space than this, because we do not allow the plants to make much growth afterwards until the following April; therefore they never become crowded, and it would be a waste of space to allow more room. The soil is pressed firmly about the roots, planting being done with a trowel, first levelling the soil all over the frame, allowing, of course, the usual slope to the front, so that all the plants are of equal distance from the glass. When the plants are placed in the frame the leaves are quite at the top of the sides of the frame. In a short time the soil settles down, so that by the time the lights are placed on the plants are within 2 inches of the glass. They receive a good soaking of water, which settles the soil about them. Any time about the middle of September is a suitable period to place the plants in the frames.

Now comes the period when my objection to bottom heat needs to be explained. Instead of placing on the lights as some persons recommend to induce the plants to make an early growth to establish them in their new quarters, this is not done until there is danger of frost injuring the foliage. By this method of treatment roots are being freely made but not much top growth. The plants receive all the showers which fall, except of course if rain continue for several days, but even then the lights are tilted at the back to keep the plants cool. Bottom heat under these conditions would tend to unduly excite the plants, causing exactly what we wish to avoid—an early growth of leaves. By following the treatment described we commence gathering flowers in a week or so after the plants are in the frame, and continue without intermission until the middle of April, the quantity being governed by the number of plants and the frame accommodation. An ordinary frame of two lights about 6 feet by 8 feet will accommodate about six dozen plants. This will give some idea of the number of plants to prepare during the summer. When the plants are placed in the frame all runners are removed, but any made afterwards are allowed to remain, as these young growths produce many fine blooms during February and March. If left on the plants earlier they would crowd the frame unduly, and might cause the foliage to suffer during a long spell of damp weather.

Although a few degrees of frost will not injure Violets when the lights are on, it is not wise to allow the leaves to be frozen.

The outside of the frame should be lined with long manure or leaves. The glass should be covered with mats or any materials commonly employed, these being removed if only for an hour or two during the day when it is not freezing. Our plants only received water at the roots twice after the lights were placed on them in the autumn, so little do they require during the winter. During March and April when the sun has more power and drying winds are prevalent they will need more to keep the roots moist, or red spider will attack the leaves. To make sure of a supply of bloom when the outside temperature does not permit even the covering to be taken from the lights, we grow a few Violets in boxes, arranging these on a shelf in the vinery or Peach house. Ordinary cutting boxes will answer very well. The Violets are placed in them at the same time as the others are planted in the frame, using the same sort of soil. The boxes should stand out of doors for a time, but upon the approach of frost they are moved to the vinery, which at that time is kept cool, and capital blooms are obtained at a trifling cost. The Violets in the boxes require more water than those in the frame on account of their having so much less soil in the boxes.

When Violets make an early growth after being planted in April or May, as they do if advantage is taken of showery weather, we gather blooms in August and all through September, and as we generally have more plants than we require for the frames and boxes these are allowed to remain in the ground all the winter. These promise a good crop of flowers. A slight protection was given to them during the winter, which prevented their being killed by the severe frost, but many were severely checked.

We grow only two varieties, De Parme and Marie Louise; they are now so mixed that it is difficult to distinguish them, but as long as they are double blue Violets of dark colour it matters little to us. Neapolitan is too pale, and Comte de Brazza shows too much of the green centre.—PRACTICAL.

[We have seen no finer Violets than some that were sent to us by our correspondent during the winter.]

WATERING VINE BORDERS.

IN reference to Vine borders it is oft repeated advice that these cannot be too freely watered when the Vines are in full growth or commencing. This I fancy is an erroneous opinion, and has led to as many failures with Grapes as any other cause. Small borders, and especially when these are formed with a non-adhesive soil, will certainly take with benefit to the Vines a much larger amount of water than is necessary for borders of a larger size, or where the soil is retentive. Overwatering Vine borders I believe is often responsible for shanking and deficiency of colour in black Grapes. This is especially the case with the Black Hamburgh, which is generally understood to be one of the easiest of Grapes to cultivate, although to bring this grand old Grape to the highest state of perfection requires considerable cultural skill. Ordinary Black Hamburghs may be often seen, but superior examples of culture are not very frequent. During the early stages of growth, or just when the Vines are about being started, the borders are often kept in such a sodden condition that the rods fail to break satisfactorily. At this stage if the borders are in a fairly moistened condition it is quite sufficient, or even up to the time the new growths are 6 inches in length. When such is the case the small rootlets form more abundantly than they could when the border is sodden.

Many other plants which had been shortened back previous to making fresh growth would be kept rather dry, and why not the Vine? Take the Fuchsia for example; when this has been pruned back the plants are kept occasionally syringed until fresh growth has fairly started, as it is pretty well known that to keep them heavily watered would defeat the end in view.

Overwatering pot Vines when just started often causes the dormant roots to decay. To be successful with these requires very close watching in watering, and until fresh rootlets commence forming keeping the soil fairly moist is sufficient. On more than one occasion when I have started pot Vines it has been upwards of a month before water was applied, or even necessary, but the pots were plunged in leaves. Afterwards I had occasion

to water these Vines three times a day before the crop was finished, so abundant were the roots.

Some time since a well known writer stated that something must be radically wrong with the treatment of the Vines when they require attention in watering three times a day. I wonder he did not extend his observations to Strawberries in pots, as one is on a par with the other. My idea of watering a pot Vine is the same as with other plants—i.e., apply water when needed, and I am of the same opinion with Vines in borders. Those under my charge have less water applied to the roots than is generally considered necessary, but then the nature of the soil has to be taken into consideration, which is of a cold adhesive nature. It does not matter what correctives are added, it does not lose its true character. This is where many are led away; they apply water abundantly, irrespective of the soil they have to deal with, thinking that they cannot apply too much. When the soil is of a very open description water may be more copiously applied, but not otherwise.

A light mulching will counteract the evil of having to apply too much water, but here caution is necessary, and this may prove very disadvantageous to the finish of the crop, and especially with outside borders in a dull and wet season. When it is found necessary to apply a mulching this should be open and not likely to obstruct the warmth to the border. Giving heavy coatings of raw manure is a mistake, and when we read of borders inside receiving so many inches in depth of cow manure, we cannot but feel concerned for the future prospects of the Vines, or even of the man in charge. Besides excluding warmth such material closes the pores of the soil and prevents the free admission of air. The size, construction, and nature of the material used in the formation of the border have to be taken into consideration when to apply mulching, and we may also add the character of the season.

Except in the heat of summer outside borders seldom need mulching. At this time a depth of about 1 inch or 2 inches of well burned and screened garden refuse, sweet leaf soil, with a portion of well worked horse droppings, form an admirable covering. The manure is not absolutely necessary, but where surface roots are abundant it gives assistance as a stimulant. The above material besides acting as a mulch attracts the heat of the sun, and must be of the greatest importance to a cold soil. During the early stages of growth the soil should be allowed to become rather dry before applying water, the border thereby being kept in a more healthy condition, besides encouraging active feeders. As the growth advances and the stoning stage has safely passed, then more moisture may be applied with advantage for finishing the crop.

Borders that are too freely watered for the health of the Vines soon lose their fertility, and in two or three years become a cold, inert mass. Most undoubtedly there are thousands of Vines which do not receive nearly sufficient water, and especially on light or gravelly soils, which may be proved by the crops finishing more satisfactorily in a wet season. I am aware that restricted borders crammed with healthy roots require abundant waterings, but even too much might easily be applied to these when the Vines are about being started, and previous to free root action. I have three restricted borders to deal with, and in each the Vines carry good crops of well finished bunches, but these require more attention in watering than do the larger borders.—A. YOUNG.

HERBACEOUS PLANTS FOR EXHIBITION.

THE increasing demand for herbaceous plants renders any remarks respecting those best suited for exhibiting of service to readers, the more so, perhaps, by reason of the fast approach of what may generally be regarded for many as the best planting season which the year affords, and if anything is conducive to success it is planting at the proper season. From inquiries which come to hand from time to time I am well aware that many of those who grow hardy plants would like to exhibit them also, the chief drawback being when any particular show day arrives some are past and others not sufficiently forward to ensure the required number. The exhibits of hardy plants which are seen at local or provincial shows are too frequently badly arranged, and the material employed too sparse to afford anything like a good idea of what hardy flowers should be. In many instances either annuals or biennials, or both, have to do duty for the herbaceous plants, not from any desire to be in opposition to the requirements of the schedules, but merely from want of information on the subject, and *bona fide* errors, if I may be allowed the term—that is, errors which are the outcome of ignorance, are overlooked by lenient judges and committee alike. But while I have nothing to urge against extending leniency in particular cases, I cannot but think the step an unwise one which allows the continuation of the error without any attempt to rectify it. When I came into this

district some years ago I was requested to act as joint secretary to the local horticultural society, to which I gave consent, and among other things in a midsummer show classes were set apart for hardy herbaceous cut flowers, which on the show day in every single instance was made up of annuals, biennials, and perennials, clearly the outcome of ignorance, as I afterwards discovered, when I told the successful and unsuccessful exhibitors that, properly judged, all of them would have been disqualified. This evidently astonished them, simply because, as they observed, "that's how we have always exhibited them." It resulted in my imparting some information on the subject, and the following year when the schedule was revised I added a rider to the exclusion of annuals and biennials in these particular classes. Special prizes consisting of collections of hardy herbaceous plants were offered, the selection being optional to the winners of the prizes. As a result the competition is keen, creditable groups are now arranged of "herbaceous perennials," and the exhibitors have arrived at some understanding of what is meant by the words "hardy herbaceous plant." So much, then, may easily be done by any horticultural society, and instead of allowing the error to remain year by year, some attempt should be made to remedy it by educating aright all whom it may concern.

To grow hardy plants for cut flowers suitable for exhibition purposes little will be needed beyond the selection of a good piece of open ground of fair depth. This must be deeply trenched and thoroughly manured, or according as its existing state demands, when nothing more will be needed but the plants, placing them in their respective positions, and taking into consideration that these will be permanent occupants the original planting should receive due attention. The only other assistance which I can render is that of giving a selection for several months in the year when exhibitions including such flowers are held, commencing with the month of May. During this month many fine plants more suitable for growing as specimens in pots or pans, perhaps that for exhibiting in a cut state will be available; the more conspicuous of these will be *Trillium grandiflorum*, the many forms of *Primula Sieboldi*; also *Primulas rosea*, *denticulata*, and *Cashmeriana*, when required early in the month, but where wintered in frames these will flower in February and March. *Marsh Marigolds* or *Calthas*; *Gentiana acaulis*; *Doronicums*, several forms; *Iris nudicaule*, *Iris pumila*, *Pæonia tenuifolia*; *Megaseas*, in variety; *Wood Anemones*, several kinds; *Phlox amœna*, *Phlox Nelsoni* and *setacea* varieties; *Dielytra spectabilis*, *Arnebia echioides*, *Geum miniatum*, and many others equally good, and sure to please when well grown.

For the month of June there is a rich and varied assortment of plants specially suited for exhibiting in a cut state, foremost in the mind being herbaceous *Pæonies*, a host in themselves in the remarkable range of colour, their massive double flowers and ample leafage. A selection of these should be in every garden. *Pyrethrums*, again, single and double in endless varying shades, contribute in a remarkable degree to furnish quantities of flowers, furnished, if you will, with a couple of feet of stem that will, if employed, carry with it a large share of their natural grace and beauty. Then why rob the plants of so great a gift by using, as is too often the case, miserably short stems, not more than 6 or 8 inches long, which crowd the flowers into an unsightly bunch. Then, again, we have the lovely Orchid-like forms of *Iris germanica*, under which head also figure the allied groups of *squalens*, *amœna*, *variegata*, and so forth, thus constituting a most valuable assemblage of chaste and lovely flowers that for delicacy of marking and transparency of form surpass even the choicest of Orchids. Nor are these the only ones that this wonderful genus brings us during this month, for quite early in June our gardens may be aglow with the rich and varied shades of blue, cream, white, yellow, and bronze to be found in the Spanish section; while the latter half of the month will be enriched by the fantastic marblings or splashings of the English section, the latter also embracing pure white, as well as blue and purple selfs. The same month will also provide *Columbines* in plenty, *Hemerocallis flav.*, *H. Dumortieri*, *Anthericums*, double white *Rockets*, *Lychnis viscaria rubra* pl., some early *Liliums*, as *pyrenaicum*, *pomponicum*, and *Szovitzianum*, as well as the *Delphiniums*.

The month of July has also a goodly share of *Delphiniums*, and includes many *Lilies*, more particularly *croceum davuricum* varieties; *Thunbergianum superbum*, *pardalinum*, *longiflorum*, and *candidum*; *Heleniums* of several kinds; *Gaillardias* in plenty, very handsome things too; *Galegas*, *Geraniums*, *Cenotheras*, *Thalictrums*, tall species, such as *flavum*, *lucidum*, *rugosum*, and *majus*; *Stenactis speciosa*, the tall *Hemerocallis*, such as *fulva*, *Kwanso*, and *disticha*; *Iris Kæmpferi*, most lovely of all the *Iris* family; *Alstroemerias* in several varieties, very good and showy; with *Chrysanthemums leucanthemum*, *maxmum*, and *latifolium*.

For the month of August there will still be plenty, and the

more profuse of last month will yet yield a quantity of flowers. To these may be added *Lilium auratum*, *Tiger Lilies*, *Hyacinthus candicans*, single and double *Sunflowers*, *Gladiolus*, *Spiræas venusta*, *digitata*, and *palmata*; herbaceous *Lobelias*, tall *Campanulas*, *Achilleas*, *Rudbeckia purpurea*, and others.

There is in fact a wonderful variety of plants available for the above purpose, and when once a collection is obtained and planted the adding of others of exceptional merit as opportunity affords will not be a very serious undertaking. Many of those I have enumerated may be obtained freely and abundantly from seeds, while plants of good size and at reasonable rates may be obtained from those who make hardy plants a speciality.—J. H. E.

VEGETABLES—THEIR VARIETIES AND CULTIVATION.

[A condensed report of a paper read by Mr. J. LAMBERT, The Gardens, Onslow Hall Shrewsbury, at a recent meeting of the Birmingham Gardeners' Association.]

(Continued from page 224.)

I AM asked by some friends to give a list of varieties I recommend, but this is rather a difficult matter with so many seed firms introducing new varieties, and all supply reliable seeds. I am a little old-fashioned in my preference for some varieties, still I try many of the new introductions, which sometimes are only new in name, and turn out to be an old acquaintance. I think your wish is that I should tell you what sorts I grow; but it must be borne in mind that the same variety does not always succeed well in every garden. I will take Peas first; and in this part of the country for early crops the best results are from seed sown indoors and planted out after being very carefully hardened off. In the southern and more favoured districts sowings are often made just before Christmas. The varieties I grow are *Chelsea Gem*, *Veitch's Selected Extra Early*, *William Hurst*, and *William L.*, all good early ones. *American Wonder* is another good early sort, but with me not quite so early as *Chelsea Gem*. Then follow *Early Sunrise*, *Champion of England*, *Huntingdonian*, *Telephone*, *Duke of Albany*, *Webb's Stourbridge Marrow*, *Veitch's Perfection*, and *Ne Plus Ultra* for general crops, and all are good useful sorts. For exhibition purposes, *Telephone*, *Duke of Albany*, *Webb's Stourbridge Marrow*, *Sutton's Matchless Marrow*, and *Carter's Stratagem* are amongst the best. *Veitch's Prodigy* may be also relied upon as an exhibition Pea. In runner Beans, *Neal's Ne Plus Ultra* is, I think, the best for all purposes, as it is an excellent cropper, with thick fleshy juicy tender pods. I do not believe in the giant varieties, and to have an early crop sow in pots or boxes early for planting out as soon as can be done with safety. I find *Canadian Wonder* and *Ne Plus Ultra* very serviceable varieties of *Dwarf Kidney Beans*.

Amongst Broad Beans I use *Beck's Dwarf Green Gem* for autumn sowing, or in pots for transplanting in spring, as it is a favourite here for the small size of the beans, and for its mild flavour. The *Seville Longpod*, *Carter's Leviathan*, and others of the *Longpod* class, are subject to being much broken down by wind, and I find this advantage arise from their being blown down, that they throw out branches up the stem, and give a succession of beans through the summer. I last summer grew a new variety, sent out by Messrs. Veitch & Sons, their *Improved Longpod*, not quite so long in the pod as the *Seville* or *Leviathan*; but it is of stout growth, standing erect, a good cropper, and the beans are of a deep green colour.

I do not grow the round sorts of Beets. *Nutting's Red* and *Pragnell's Exhibition* are my favourites. *Dobbin's Beet* is of good colour, but grows too coarse here.

Broccoli and Cauliflowers.—Of the latter I grow *Early London* for house use, and *Veitch's Autumn Giant* for the servants. I sow the seed in boxes the end of January or February, and pot off or prick off into boxes until ready for planting out for the early crops; and I continue a succession of small sowings, so that I never fail to have a supply of plants. In the autumn we see to protecting the heads from frost; and if they are lifted and planted in a Peach house they are safe, and give a supply for some time. Then we have the autumn *Brocolis*, viz., *Sutton's Michaelmas White*, *Webb's Mammoth*, and *Veitch's Self-protecting Autumn*, all good sorts that will carry you on until *Snow's Winter White* comes in, for this, when you can have it true, is the best of all yet. *Penzance*, *Veitch's Spring White*, *Sutton's Perfection*, and *Veitch's Main Crop* are all good. The old *Sulphur* or *Portsmouth Broccoli* and *Veitch's Model I* find to be two of the hardest sorts here, and the only two varieties I have left to me after the severe winter. The kinds I have mentioned will keep up a good supply through the season. The *Old Purple Sprouting* should be grown by all, although some object to its colour.

To-day (February 23rd) I examined our spring beds of Cabbage

of which 900 plants were planted out, and I have not lost more than a dozen plants; but all the old stumps of last year's growth are killed. I sow in August, and recommend planting out 12 inches apart, cutting out every other one in the spring, leaving the remainder 2 feet apart each way for completing their growth. The varieties I prefer are Ellam's Early Dwarf, for early spring, Heartwell Early Marrow, and Enfield Market. The Carrots I grow are French Forcing, Early Nantes, Sutton's Gem, and Veitch's Matchless.

Celery seed for very early use I sow in pots or boxes early in February, and prick off and transplant when the weather is warm enough. Major Clarke's Red, Wright's White, and Sandringham Dwarf White for late work are the kinds we grow. The varieties of Leeks I grow are The Lyons, Dobbie's Selected, Sutton Prize-taker, and Webb's Colossal. In Onions, James's Keeping grown on hard ground so as to get smaller bulbs keeps the best of all; and I also grow The Reading and Banbury Improved. For exhibition purposes I suppose we should have Excelsior, the parent of most of our large exhibition Onions, and still an excellent variety, then there are Cocoa-nut, Ailsa Craig, and others. To those who grow Parsnips for exhibiting, I recommend Dobbie's strain, as it is an excellent one. For general crop Hollow Crown or Student.

With regard to Potatoes, my advice is grow varieties that best suit the soil of your gardens and are best for flavour and table use. With Turnips Early Milan and Snowball for earliest crops, and Chirk Castle and Orange Jelly for the winter. We sow once a fortnight through the summer, and cool, shady ground suits them best in hot weather.

Spinach.—I recommend the new Victoria Improved Round, as it does not run to seed so soon as the ordinary varieties; the leaves are larger and more fleshy, and stand the winter well, and is an improvement on the old Prickly Spinach. I sowed the two varieties, the Victoria and Prickly, side by side, and from the Victoria I have had a good supply through the winter.

There are other vegetables I ought to briefly notice; but the time you are allowed here will not admit of more than a cursory glance at all the varieties of vegetables I have even mentioned. My object has been, not to endeavour to instruct old practical gardeners, but to help young gardeners if I can, and I hope my object may be accomplished.

HARDY FLOWER NOTES.

IN such a season as the present the opening of the first flower of the year may well be received with a pæan of pleasure, and this pleasure is greatly enhanced when this harbinger of the season is one which is new to its possessor, and whose opening blossoms have been waited for, and looked for, through dreary days of gloom and of frost; although to tell the truth we have but little to complain of in this nook of Scotia, having had much less snow and frost than has been experienced in the south of England. But we must not wander into a digression and dissertation upon the weather, but return to the first flower of the year, keeping out of sight, of course, the bespattered and bedraggled Primroses and Polyanthus which, with an ambition worthy of a better fate, ventured to show their blossoms, and in consequence experienced the wrath of winter. This first flower of the year was Iris Bakeriana, which flowered with me on January 24th, and charmed me with its delicate beauty—a beauty which it shares in common with many of its congeners. A fellow immigrant from other climes, *I. Bornmülleri* or *Danfordiæ* (and the latter name has the priority in point of date of title) should have been in flower also; but, alas! some unkindly grub had devoured the bulb of our "one ewe lamb" of that species, and we are minus the bulb and the money it cost. Thus are the roses of hardy plant growing accompanied by the thorns of losses. *I. Bakeriana* has, however, recompensed me for any disappointment at the loss of the other, and proves to be one of the good things which are constantly being introduced to this "sceptered isle."

My specimen was planted on rockwork in September of last year, and stood the winter without any protection. It had been in bud from the beginning of the year, and opened on the disappearance of the frost; the flower being afterwards covered with a small handframe, which admitted an ample supply of air, but which protects it from heavy rains. This Iris is variable, and in a number of plants some variation of interest will likely be found. My solitary plant had its flower raised to only $3\frac{1}{2}$ inches above the ground, while the cylindrical ribbed leaves were an inch longer, but will, like those of *I. reticulata*, probably extend. The flowers, like those of most of the Irises, are difficult to describe. When in bud they are of a fawn colour, spotted with what may be called deep purple. After opening, the standards are of a fine violet,

afterwards becoming lighter, the falls being creamy white, with deep blue, almost black blotches, one at the point being particularly large and fine. Taking the flower all in all, it is a great acquisition, and although a pigmy in size, is worthy of bearing the name of that Titan among botanists, Mr. J. G. Baker. I understand *I. Bakeriana* was first sent from Asia Minor by Rev. S. F. Gates, and has been largely introduced through Herr Max Leichtlin.

With the exception of this exquisite Iris, and the few pitiful unfortunates I have alluded to, our record of plants in flower to the end of January was a blank, and presents a sad contrast to that of last year. In 1890, at that time we were comparing notes of early Snowdrops, and this year there was not one open in my garden. Whatever may be the case when *Galanthus coreyrensis* finds its way into its precincts I know not, but it is at present at a prohibitive price, and apparently *G. Elwesi* will be the first, closely followed by one I have as *G. nivalis præcox*, a name which Mr. Baker in his handbook of the *Amaryllidæ* apparently considers as synonymous with *coreyrensis*. I am afraid there is some confusion here, but what I have as *præcox* is certainly considerably in advance of the common *nivalis*. One I received last year under the name of *G. n. umbricus*, and said to be very early, just showed through the ground at the end of January, but it has always to be remembered that dried bulbs are very erratic, and sometimes come earlier or later than their normal period. *G. n. umbricus* seems to have quite a distinct rosy colour when it is just above the soil. Has any other one who has grown this variety noted this?

I was glad to see the cheery yellow flowers of the little *Eranthis hyemalis* once more. In the dry season of 1889 all my roots of this little Winter Aconite were destroyed by the drought, which was very severe on my light soil, which has sand and gravel beneath. Crocuses are all very late this year, even such early species as *C. Imperati* and *C. Sieberi*.

Anemone blanda and its white variety are pushing through the soil, and with favourable weather will not be long of flowering. The Poppy Anemones (*A. coronaria*), which were so fine and so useful last winter, have not proved so valuable this one, as there was no sun to bring them forward even under a frame.—
S. ARNOTT.



DENDROBIUMS.

[A paper read at a recent meeting of the Liverpool Horticultural Association by Mr. JNO. GLOVER, gardener to Sir Andrew Barclay Walker, Bart., Gateacre Grange.]

DENDROBIUMS form an extensive and magnificent genus of Orchids, and include the most useful as well as the most ornamental Orchids in cultivation; they are also very accommodating, for they may be grown successfully under various conditions. They vary much in character, partly consisting of plants with tall-jointed stems bearing lateral or terminal racemes of flowers and partly of pseudo-bulbous species, which have terminal racemes. Some of the species produce large flowers of delicate colour and fragrant. Many flower freely; some are evergreen, retaining their leaves all the year round; others are deciduous, and flower on the ripened leafless stems. As, however, the genus comprises 300 species, it includes many plants of but little interest to the amateur, though worth growing in a botanical collection. They are found all over India, and in Australia, China, and Japan. Many last three or four weeks in flower, others only a few days. Some last well in a cut state, and are valuable for decoration, and may be used either for glasses or to be made up in bouquets, wreaths, crosses, or as coat flowers. They flower mostly in spring, but where numbers of plants and varieties are grown they may be had in succession from December to August by introducing them into heat from their resting quarters at intervals as required, and retarding some as long as possible in a cool temperature. *Dendrobium nobile* has been kept outside under a north wall, and was shown well in August at Sefton Park. Many thousands of *Dendrobiums* have been imported successfully of late years, thanks to our enterprising nurserymen, and at such low prices that it is scarcely possible to find a garden of any pretensions without *Dendrobiums*.

To flower these plants satisfactorily they must have a season of growth and of rest, and of the two I think the latter the more important if they do not have sufficient rest they will not flower

well. It is necessary that they should make strong stems or pseudo-bulbs, and it is equally essential that these growths be well ripened.

Some of the *Dendrobiums* are best grown in pots with rough fibrous peat and good drainage, half filling the pots with crocks, and placing the roughest part of the peat carefully over them, then filling the pot level with the top with peat and charcoal, placing the plant on the top. Place two or three sticks firmly into the compost to secure the stems by tying them top and bottom to keep the plant in position, then finish by covering the roots with peat and sphagnum alternately, pressing it firmly, and elevating it 2 to 3 inches above the pot, giving a gentle watering on the surface through a rose, then pressing it to make an even surface. This applies to the erect or strong growing species. Pots and crocks must be clean and dry, the base of the stems not being covered. The pots must be in proportion to the size of the plants. It is not good practice to give too much root room. Some plants require potting once a year, while others might stand two or three years. Large specimens may be top-dressed. If a plant becomes sickly or soddened in the pot by overpotting, the best way is to turn it out and wash the roots with tepid water, then repot into a smaller pot, giving very little water until new roots appear at the base of the plant. Ordinary garden pots are the best when well drained. Perforated or ornamental pots often harbour cockroaches, woodlice, crickets, snails; and when the roots are eaten continually the plant cannot thrive. Newly imported plants should not be potted as soon as received, but be carefully examined and cleaned by sponging and cutting away any decayed portion. When cleaned lay them out in a shaded position in the Orchid house or hang them up without anything about the roots for two or three weeks, when they may be placed into pots nearly full of crocks broken about an inch square for large plants. Smaller plants in pots must have crocks of less size than named; when they begin growing and show some roots they may be top-dressed with peat and moss, but they must have very little water up to this time. As they become established they may be treated more liberally with water until they have finished growing.

February and March are good times for potting established plants when they are commencing growth; those that do not require potting may be top-dressed with fibrous peat and moss, the old compost being removed without injuring the roots.

Some *Dendrobiums* are more suitable for baskets, others for blocks of wood, *Dendrobium Devonianum*, *primulinum*, *Falconeri*, and others with long pendulous stems being the best adapted for baskets, as they show to more advantage when in flower, besides being their natural habit of growth as they are found growing on branches of trees. The best material for use in baskets is sphagnum, small crocks, and charcoal. The basket must be in proportion to the size of the plant. It cannot be too large, for if made of wood it will only last a few years, when the plant may be placed into a larger one, teak being preferable. Have a layer of moss at the bottom, then some small crocks and charcoal, filling up with moss and small crocks mixed; place the plant level with the top of the basket, fix a stick or two in the compost to hold the plant firm, cover the roots with a layer of moss, and water through a rose, finishing by pressing the wet moss firmly. Dwarf *Dendrobiums*, like *aggregatum*, require a little living moss attached to the block to retain moisture. A few will grow on bare blocks, but they require more frequent watering, for they are then depending entirely on the atmosphere of the house for moisture. The plants must be secured to the blocks firmly with copper wire, but when the roots have attached the plant to the wood the wire may be withdrawn.

There are different modes of increasing *Dendrobiums*. Most are easily propagated by dividing the plants just before they commence growing. February is a good time for many of them, each divided portion having roots attached to it, and being potted into as small a size pot as convenient, then place them in a shaded position in the East Indian house. A few *Dendrobiums* may be increased by bending the old pseudo-bulbs round the basket or pot in which they are growing, and pegging them down on the surface of moss. This will induce them to break from the joints and produce new shoots and roots, they can then be cut off the parent plant and potted in the usual way. They can also be increased by cutting the old pseudo-bulbs and laying them down on a damp surface in the house on a gravel bed or sphagnum in a shaded position with plenty of moisture.

They may also be raised from seed, and we have many that have been raised in this way, and shall have many more, for this mode is becoming general in large places where they have a good collection to hybridise. It is a slow way of raising plants, taking

four or five years to grow them to the flowering size, but is well worth attention. Sow the seed as soon as it is ripe on the surface of the moss on any of the Orchid pots where they will not be disturbed, and where the surface is in a rough state. Do not cover the seed, but supply water when it is sown through a fine-rose can. The seed takes from six to nine months to germinate. When the small plants are fit to handle they should be placed round the inside of small pots in chopped sphagnum, sand, and very small crocks mixed. After they have been a year or so in these pots they may be placed singly in small pots, and repotted as the plant increases in size.

(To be continued.)

DENDROBIUM MELANODISCUS VARIETIES.

A BEAUTIFUL series of hybrid *Dendrobiums* from Barford Lodge formed one of the attractions at the R.H.S. meeting last week, and those who seem to fancy that the possibilities of satisfactorily extending the hybridisation of Orchids are exhausted



FIG. 48.—DENDROBIUM MELANODISCUS VAR. PALLENS.

must have been agreeably disappointed. From a cross between *Dendrobium Ainsworthi* and *D. Findlayanum* a distinctly intermediate form was obtained some time ago, and named *D. melanodiscus*. From the same cross other seedlings have since flowered, and though agreeing generally in their principal characters they yet present so many minor divergences of form and colour that they have fittingly received special titles. Two of these, named respectively *pallens* and *Rainbow*, were adjudged awards of merit at the meeting in question, and mark as it were the two extremes of variation. *D. melanodiscus pallens* (fig. 48) has well-formed and exceedingly delicately tinted flowers, in this respect unsurpassed in the whole genus. The sepals and petals are white tipped with a clear and bright but faint purple tinge; the lip is large and open with a pale yellow tint in the centre fading into the white margin. The variety *Rainbow* is of a bolder character and deeper colouring, presenting a remarkable contrast with *pallens* as resulting from the same cross. The sepals and petals are tipped with purplish mauve, and the lip has a heavy central well-defined intensely rich magenta blotch. Both are of good habit, graceful, free, and likely to become even more useful than either of their parents.—C.

SOWING LAWN GRASS SEEDS.

THOSE persons who purpose making a new lawn by sowing grass seeds instead of laying it down with turf will need to prepare the ground for the seeds. Any time after the 1st of April is suitable, but more depends upon the state of the soil and the

weather than upon carrying out the work at any particular date. If the seed be sown earlier than April there is a risk of sharp frost checking the free growth of the plants while they are tender. Where turf of good quality, free from coarse weeds, such as Plantain especially or Daisy roots, it is of course preferable to seed for immediate effect; but where suitable turf is not obtainable it is better to sow seed than to be troubled with weeding the lawns annually before a good sward can be secured. In some localities great prejudice exists against forming a lawn by sowing seeds, which also extends to breaking up pasture land as a means of improving the quality of the grass.

Success in obtaining a good sward in a short time depends entirely upon the manner in which the ground is prepared, the time the seed is sown, and how the grass is attended to afterwards. Given suitable weather, warm and showery, the seed will germinate quickly, and the lawn look quite green in five weeks, and in as many months quite a thick carpet of grass can be had.

We will assume the ground was well broken up in the autumn, the surface soil will be well pulverised now by the frosts experienced this winter. Even in the growth of grass it is surprising what a difference is perceptible where the soil has been deeply stirred, and those who are desirous of obtaining a close velvety lawn in a short time would do well to dig the ground at least 15 inches deep. The level which the future lawn is to assume must be made now, as after the seed is sown it is too late to make any alterations. The surface must be raked fine, and then rolled to secure a firm bed for the seed. On the day the seed is to be sown the surface should be raked again, and sown at the rate of 60 lbs. to the acre, or a little less than half a pound to the rod.

Sowing can be done in two ways—first up and down the piece, afterwards crossing the site. In this manner plenty of seed will be scattered to produce an even sward. A still day should be chosen for sowing this fine seed. Again rake the surface as evenly as possible, and repeat the rolling to finally settle the soil and the seed. Some leave the surface smooth from the roller, but it all depends upon the kind of soil which has to be dealt with. If it be of a heavy retentive nature it would not be wise to allow the surface to remain smooth, because it would be too hard baked if the rolling was followed quickly by rain, thus preventing the seeds pushing through, and encouraging the surface to crack. In this case it is better to again lightly rake the soil, so as to leave the surface loose, but not sufficiently to disturb the seed. Where the soil is sandy the roller will leave the best possible finish, as in this case the surface is not likely to become crusted. Make provision in some way to scare off small birds, and it is surprising what a quantity they will pull up, just when the seeds begin to germinate, if left unprotected. To scare them procure two pieces of glass about 6 inches square, suspend them to the end of separate stakes thrust into the ground in a slanting direction towards each other, but so that they do not touch each other. The glass is tied to the end of the stakes with string 1 foot long, and in such a manner that upon the least movement the pieces of glass chink together. This will keep the birds away until the seed germinates, which will not take more than ten days, or a fortnight at the most, if the weather be warm and showery. The green linnet and chaffinch are the worst birds to contend with.

As soon as weeds can be discerned remove all Docks, Dandelions, and others of coarse growth; choose damp weather for this work, as the weeds come up more readily. When the grass is sufficiently high mow it lightly with a scythe, repeating this operation directly the grass is long enough to be cut. Repeated cutting off the tops of the grass induces it to fill out more readily at the base, and to form a thick sward. Repeat mowing as occasion requires. A light iron roller may be run over the grass often enough to make the surface firm; in fact, it cannot be rolled nor mown too much.—S.

FLOWER CULTURE FOR PROFIT.

CELOGYNE CRISTATA.

WHITE flowers generally realise the best prices. Probably some of the delicately coloured Cattleyas, Lælias, and other Orchids do fetch higher sums than the Cœlogynes; but, all things considered, it is doubtful if any pay better in the long run. At the present time we are sending flowers of the Orchid under notice to a shop in London, and after expenses are paid receive 3s. per dozen. This may not appear a particular good price, but it must be remembered that they are sold at a wholesale rate, and also that a fairly strong or good average pan of bulbs is capable of annually producing twenty spikes and upwards, each bearing from four to six flowers, which means a return of from 20s. to 30s. per year. As a matter of fact one good crop of flowers is worth more in the market than the plants producing them would fetch at an ordinary plant sale. Those, therefore, who have a good stock should take

good care of it. They cannot be increased rapidly from a few small pieces, but are not particularly dear to buy. Undoubtedly the Chatsworth form is superior to the ordinary variety, but its value is more apparent than real as far as growers of flowers for market purposes are concerned. There is also a difference observable in the common type, those with long oval pseudo-bulbs flowering the most surely and strongly; at least such appears to be the case with those we have.

A few years ago we succeeded very indifferently with the Cœlogynes. They made fairly good growth, but either failed to form flower spikes, or else the latter damped off while yet in the sheaths. Private places varying so much in the arrangements of plant houses and everything else, it takes some time to find out where various choice plants succeed best, and those unacquainted with the facts of each case can therefore only advise generally. We shifted our Cœlogynes from one place to another till at last the right spot was found, and there they will be kept as long as I have charge of them. They are not natives of the hottest part of India, and what as a rule suits Cattleyas also agrees fairly well with them. Where, however, they succeed best is on a side bench in a fernery. Here they have plenty of light, but no bright sunshine reaches them, while the temperatures are never high and seldom very low. During the winter the night temperatures vary from 45° to 55°, according to the external weather, and in the daytime there is usually a rise to 60°, or rather less. During the spring and summer months more heat suits the Ferns, as well as the Orchids grown with them, and an ordinary stove temperature is therefore maintained, plenty of moisture being maintained in the atmosphere.

I am aware that many succeed in growing Cœlogynes well under very different treatment, the plants being kept in a strong heat while active growth is going on, and then rested in a warm greenhouse, being reintroduced into a plant stove to flower. Ours do not require to be rested. They certainly get the most heat and moisture both at the roots and atmospherically while active growth is proceeding, but they do not require to be moved, and are never really dry at the roots. Under this treatment scarcely a strong pseudo-bulb has failed to flower on all but one pan.

There are a few other details that ought to be referred to. We find the plants succeed better in pans than pots, and the less often they are pulled to pieces with the view of increasing the stock the better, those kept for several years in the same pans being by far the most floriferous. The pans ought to be freely drained, and the plants potted rather high in a mixture consisting of equal parts of the best brown fibrous peat and chopped sphagnum, a few small potsherds and lumps of charcoal being added. We make no attempt to keep the surface of the soil clothed with live sphagnum, and fail to see the necessity for so doing. It is possible to pay too much attention to the live moss coverings, as it does not always follow that what suits this will also benefit the more precious roots underneath. Should the soil become sour it is advisable, in extreme cases, to separate and wash what roots may be alive cleanly from it, and repot in fresh compost. Sometimes the roots become very bare, and in anticipation of this we, every April, go over all of the pans, and top-dress wherever this is needed. Occasionally extra large pans are to be met with; having long stiings of pseudo-bulbs hanging down their sides, but though these frequently flower freely, the growths would be stronger and finer spikes be produced if the stems had some compost to root into. It is these large overgrown specimens that would pay best for splitting up and repotting, and I would travel a considerable distance on the chance of being able to buy one or more of them. Insect pests do not seem to greatly trouble Cœlogynes, and woodlice prefer the roots of most other Orchids.

We gather the flowers singly, always allowing thirteen to the dozen, and pack them closely, flatly, and in a single layer in shallow boxes lined with cotton wool faced over with tissue paper. They are covered with another strip of thin paper and on this sufficient cotton wool is placed to fix the flowers tightly when the lid is shut down. Thus packed they will travel well, and any distance, either by post or rail. Here let me once more add how unwise it is to nail down the lids of flower boxes so very strongly, any number of wire nails being driven in. They cannot be opened without breaking the lids, and not infrequently the contents are also damaged by the rough treatment necessary.—M. H.

REGULATING THE GROWTH OF PEACH TREES.

ATTENDING to the wants of Peach trees in disbudding, stopping, and tying, is one of the pleasant operations of gardening, and affords ample scope for the exercise of observation. Those who concentrate their attention upon this work quickly find that with care young trees may be moulded into well-balanced specimens.

fruiting with uniformity over the whole surface. To secure such trees great care must be taken to prevent a few strong shoots growing vigorously at the expense of weaker ones, and by so doing merit the definition of "robbers;" but they are something more, for they not only rob the weaker portions of the tree, but also by their excessive vigour fail to set fruits themselves. Such shoots, if allowed to grow unchecked, become still stronger, destroying the balance of the tree, and in time causing many of the fruitful branches to die.

According to my ideas on this subject extension pure and simple is rarely, if ever, carried out with Peach trees, but the method of training generally acknowledged as the extension system is to regulate the excessive vigour in some shoots by judicious stopping, and by checking the flow of sap in that direction, to force it with greater power into the weaker ones, and by thus equalising the sap, render unnecessary the wasteful process of cutting away a large portion of young trees at pruning time when there is still plenty of vacant space to be covered. If this has to be done it is a strong proof that the energies of the trees have not been properly directed. Well-balanced shapely trees can only be secured by strict attention throughout the growing season, beginning with the operation of disbudding, when the strongest shoots only should have the young growths removed freely at the first disbudding and the weaker ones left untouched for a week longer. The larger amount of leafage being thus left on the weak shoots will have the effect of drawing the sap with greater force in that direction; then by gradually removing the shoots not required to form fruiting wood, those left will receive, to a certain extent, the benefit of the greater force of sap which has been diverted from the stronger shoots. This is the first stage towards the production of well-balanced trees.

The next step is to keep a sharp look-out among the young shoots left, and wherever they show a tendency to grow much stronger than the average size of the shoots, pinch out the points at four, five, or six leaves, according as they are more or less strong. This will cause them to throw out several laterals. If only one is required, select the weakest; but on the upper part of young trees where there is room for extension, train in as many as room can be found for when disposed about 3 inches apart. After treating them in this way it is seldom that leading shoots give much trouble by their strong-growing tendencies. Sometimes it happens that where branches have been lost in established trees these strong shoots prove of great service in filling up vacancies. Where such is the case, do not stop them till they have grown to the required length, and train in all the laterals which are produced along the shoot at intervals of 3 inches. When, after the first pinching, a strong shoot still persists in growing too strongly, I find the best plan is to cut it back to within a couple of buds of the base and then train up the lateral. With trees under glass this late growth has plenty of time to ripen, but I do not advise its adoption with outdoor trees. If these remarks are acted upon, and other points of culture well carried out, no one should have much difficulty in overcoming the tendency to produce gross unfruitful shoots which young trees exhibit, or of securing good crops of fruit annually.—
H. DUNKIN.

FLOWERS FOR CUTTING.

HARDY PERENNIALS.

(Concluded from page 200.)

THE genus *Anemone* provides a rich harvest of beautiful flowers, and *A. japonica alba* is well known as one of the most chaste, but all the forms of *A. japonica* should be grown. *A. vitifolia* is a good white in much the same way, but I imagine it is rather tender, as it has disappeared from our collection. The above group flourishes amazingly in a strong unctuous loam; in fact, they assume the qualities of common weeds, and a good number of years ago when gathering in from all likely quarters the best herbaceous plants I then knew, I had this feature of *Anemone japonica* very forcibly presented. Years before I had seen it flourishing by the square yard in an old garden, and I took an opportunity to apply for some of what must have been a large surplus supply of roots; but I was met with the astounding news that any surplus there might have been had disappeared with the original stock, which had been voted so great a nuisance that annihilation had been chosen as a remedy. In light soils, however, there is not much fear of any such drastic measures requiring to be put in operation, as it does not make much growth in these. The western cultivated forms are very charming, and many of them are dazzling in the brilliancy of their colours. The single forms are easily produced from seeds, which if sown out of doors in March produce plants which often begin to flower the same autumn. Strong soils suit these better than

those of a light and dry nature. In the fields on the continent, where they grow in a semi-wild condition, the soil is very wet and strong. They are strictly perennial in nature, as the plants come up year after year, and the roots continue to increase in size. *A. fulgens* is a very brilliant form, and one double variety of this is very fine. Unfortunately one does not always get the best. A good friend when at Cannes, delighted with the beauty of the double forms, kindly sent a box of roots. They were without name, but produced some lovely flowers of various shades and forms.

Ranunculuses generally accompany the above. I sometimes grow a few, but as a rule have to net in order to keep pheasants at bay. They are best purchased annually, costing, as they do, only a few shillings per hundred. Any time from November till February does for planting. They are all good plants for cutting. Of the border forms I know none of outstanding merit for cut flowers, though we occasionally employ the double kinds. The allied genus *Trollius* produces flowers, which renders them well worth growing. *T. europæus* and *T. asiaticus* give a fairly good supply.

Poppies supply the decorator with several distinct forms. Poppies are best propagated from seeds, and besides the double forms of the annual sorts, which are suitably accommodated in cultivated shrubberies, the following are quite indispensable for culture in mixed borders:—*Papaver orientale*, a species which may be cut with long stems and employed to give character to mixed arrangements in large vases. This is best cut just before the petals unfold. They last much longer when so managed. *P. bracteatum* is also very good for the same purpose as the above. The Iceland Poppies, *P. alpinum* and its white, cream, and orange varieties, are now so well known that they hardly require recommending. It may, however, be noted that strong young seedlings yield much the best flowers. They are easily raised either in heat in spring or sown later out of doors. These I think are always best when used to furnish cylindrical or tumbler-shaped glasses—a dozen to a score of blooms set up loosely among the foliage and buds of the Welsh Poppy (*Meconopsis cambrica*). This produces very pretty yellow flowers, which droop on the stems. The buds are very useful. When once established in a garden with a light soil the stock is kept up by self-sown seedlings. Old plants of this form very effective border plants. *Oenothera Fraseri* and *O. Youngi* are two species of some value.

Among *Mimulus* some really good plants are to be found. Some varieties were sent me with spotted flowers a few years ago, which are as pretty as *Gloxinias*. On trying them in flat dishes I was delighted to find in them some of the best of flowers for this purpose. The flowers stand exceedingly well. They are also occasionally used on the dining table. I have also some hose-in-hose varieties which are exceedingly good. They are easily increased by division, and should be replanted every year, as the soil becomes so quickly exhausted by this flower.

Tritomas hold a front rank position among autumn flowers. They are especially good for church decoration, but are also most useful for rooms. *T. Uvaria* is the most useful for the above; but the exceedingly pretty dwarf coral coloured species, *T. corallina* and *T. Macowani*, should also be grown.

Scabiosa caucasica is extremely good cut with long stems, and a few put in large vases to lighten the general effect. *S. lutea* should also be grown. The first-named, at least, is most readily increased by seeds.

Spiræa provides several species which are of the greatest value. *S. aruncus* is a strong-growing kind, with large branching spikes of white bloom; this is very good. *S. palmata* and *S. venusta* have coloured flowers arranged in cymose form. The first-named is good for forcing purposes. *S. Ulmaria flore-pleno* is a really good thing. *S. astilboides* is a newish form, worth growing; and of allied kinds, *Hoteia japonica* is so well known as a forcing subject as to require no further note. *Astilbe rivularis*, a strong-growing species, with large panicles of whitish flowers, is one of the best of decorative plants for furnishing the larger sized vases or glasses. *Tradescantias* are of the greatest value on account of the distinctly artistic habit of the whole plant. Any or all of the forms of *T. virginica* are well worth cultivating. These plants prefer a damp rooting medium, but they do fairly well anywhere under good culture.

Hemerocallis in all the species may be grown. The common Day Lily (*H. flava*) is one of our sweetest flowers, and few can surpass it in beauty. *H. Kwanso* is very distinct-looking; the foliage is fairly good for decorative purposes. *Helenium pumilum* is indispensable for all kinds of decorative purposes. Where there is room in shrubberies a collection of *Helianthus* should find a place. This is a very useful family, but requires some discretion in planting. *Chrysocoma lynosyris* is most distinct, and of much value as a flower which lends character to mixed arrangements in

the smaller glasses. *Rudbeckia Newmani* is fairly well known, and is an indispensable autumn flower.

Aquilegia gives the decorator a choice of beautiful forms. These are of easy culture, and most readily propagated from seed. *A. chrysantha*, *A. coerulea*, *A. glandulosa*, and *A. californica* are the best forms. The latter is especially useful.

Alstroemerias are a useful family. The best outdoor sorts are *A. aurea* and *A. psittacina*. Though an old and cheap plant the latter is one of the best autumn plants for cut flowers.

Montbretias are rapidly coming to the front, some beautiful shades of yellow and orange being found in the newer kinds, but these are still expensive. For general use *M. crocosmæfolia* is very good; and few flowers are more charming than *M. Gerbe d'Or*, or, as it is sometimes called, Golden Sheaf. These succeed best in a rather heavy soil.

Doronicum caucasicum is a spring-flowering species which is very useful at that period. *D. Harpur Crewe* is also very good.—B.



EVENTS OF THE WEEK.—The Linnean Society meets to-night (Thursday) at 8 P.M.; the Quekett Club on Friday, April 3rd, at 8 P.M.; and the Society of Arts on Wednesday, April 8th, at 8 P.M. There is nothing of a specially horticultural character for the week, with the exception of the customary sales at the auction rooms.

— THE WEATHER IN THE SOUTH has, during the past week, been distinguished cold and boisterous winds, with occasional showers of snow, hail, and rain. Bright sunny intervals have, however, been also experienced, with slight frosts at night. Fruit tree flower buds are showing in fair abundance, and are at present considered in safe condition.

— THE WEATHER IN SCOTLAND, MARCH 23RD TO 30TH.—The only frost of the week was that of last night, 5°. There has been a prevalence of cold northerly winds: the days, at first dull and showery, have been brighter for three days, on the whole a seasonably disagreeable week.—B. D., *S. Perthshire*.

— WE are desired to state that Sir James Whitehead, Bart., has promised to preside at the Conference of the BRITISH FRUIT GROWERS' ASSOCIATION to be held in Beddington Park on August 3rd next, in conjunction with the Exhibition of the Beddington, Carshalton, and Wallington Horticultural Society's Exhibition.

— AT the meeting of the CROYDON GARDENERS' AND AMATEURS' MUTUAL IMPROVEMENT SOCIETY last week Mr. Hutchings Eves read a most interesting paper on the Hanging Gardens of Babylon. There was a large attendance of members, who freely expressed their appreciation of the manner in which the subject had been treated.

— DESTROYING MICE.—"R. T., *Portugal*," at page 208, asked for information to trap these vermin. He might try sinking a few glazed pipes, level at the top with the surface of the ground and bait them. Plans similar to this proved effectual many years ago in trapping mice in some parts of England that were overrun with mice.—W. T.

— THE WINTER MOTH.—No time should be lost by fruit growers in spraying fruit trees, as the caterpillars are commencing to hatch out. I began spraying with Paris green on March 25th, and found several small caterpillars on Apple trees the next day. There is only a short period between the disappearance of the winter moth and the appearance of their larvæ. The last moth I saw was on the 21st March, and caterpillars were visible five days later.—S. T. WRIGHT.

— THE schedule of the KINGSTON AND SURBITON CHRYSANTHEMUM SOCIETY is just to hand, and announces the dates of the next Show as Tuesday and Wednesday, November 10th and 11th. Classes of the usual character are provided, with substantial prizes for Chrysanthemum groups, specimen plants, and cut blooms; other plants, flowers, and fruit also having numerous classes devoted to them. The sixth champion challenge vase, value twenty-five guineas, is offered for forty-eight cut blooms, twenty-four incurved and twenty-four Japanese, distinct varieties. The Hon. Secretary is Mr. G. Woodgate, Warren House Gardens, Kingston Hill.

— AN OLD PUPIL OF MR. PETTIGREW'S writes:—"I was pleased to hear of the success of his son. During my service at Cardiff Mr. Pettigrew held classes for instruction in drawing, and the knowledge I gained in attending those classes has been of great assistance to me, and I am extremely indebted to Mr. Pettigrew for his teaching."

— ANEMONE HEPATICA.—This Anemone, which is more often called *Hepatica triloba*, is flowering exceptionally well this year. In no position do the various forms flower so freely or give a better effect than in a sunny spot on the rockery, as they seem more at home than in the herbaceous borders. The double red variety *rubra* is very showy, and the blooms last long in good condition. No matter where *Hepaticas* are planted, provided, of course, the position is suitable; they should not be often disturbed, as success depends in a great measure upon their being well established.—E. M.

— IF I were asked to name four of the best early hardy flowering plants I should select the following, which are showy and easily grown. First is the COMMON MEZEREON, *DAPHNE MEZEREUM*, not only for its cheerful colour and the freedom with which it flowers, but also for its delicious perfume. Scores of plants are to be seen in the cottage gardens, proving that the simplicity of culture which it requires fits it for any garden large or small. Numerous seedlings spring up round about one which has stood in a certain place a few years. It appears to succeed almost as well in common garden soil as it does in a mixture of peat and leaves. The cruel way in which some of the cottagers hack this plant about and call it pruning, almost makes one wonder how the it struggles on. Growing in masses of three or five together a fine display is made in the front of the shrubbery, its bright coloured flowers being conspicuous a long way off.

— RHODODENDRON DAHURICUM is the next on my list. The plants are arranged in the centre of a large bed, hardy Azaleas and *Pernettya mucronata* growing underneath the Rhododendrons. The position of the bed is one fully exposed to the south and south-westerly winds which sweep across that part of the garden furiously at times. The plants have been covered with its bright rose coloured blossoms. This Rhododendron should not be dotted about singly in the beds or borders, a much better effect is produced by massing the plants. Like all other American plants it is necessary to provide a peat soil for their growth; any extra trouble taken in preparing the site is time well spent, the growth and freedom in flowering making up afterwards for the outlay.

— ERICA CARNEA is planted as an edging to Rhododendron, Azalea, and *Kalmia* beds, in which position it flourishes and quickly covers the soil, making a mass of greenery as well as producing abundance of flowers during the end of February and throughout March. The time to replant and increase this Heath is during April after the season is past, the smallest piece with a root attached, if planted during showery weather, and kept shaded for a time with Laurel branches should dry weather set in after planting. In clumps on the rockery this hardy Heath is showy and well deserving a place where out of door flowers are appreciated.

— THE fourth plant I wish to call attention to is GALANTHUS ELWESI (*Elwes's Snowdrop*) which this year came into flower at the same time as *G. nivalis* (the common Snowdrop). The variety *Elwesi* so quickly forms a large clump and flowers so freely as to be deserving of extended cultivation in the herbaceous borders or on the rockery. Three bulbs planted in the last named position five years ago have now sixty-six blooms upon the clumps resulting from those three bulbs, which shows a quick rate of increase. When the foliage is fully developed it is also showy. The deep glaucous tint, combined with the robust habit of growth, renders this Snowdrop deserving of extended culture.—M.

— A SOUTHERNER who has recently returned from the neighbourhood of Hull has been impressed with the condition of vegetation there. He called on Mr. G. Cottam of Cottingham, and nothing appeared to be hurt amongst the large collection of border flowers that he grows in his nursery. Sturdy Wallflowers were as fresh as if the winter had been mild, winter greens of various kinds have not been much hurt, and large breadths of *Ellam's Cabbage* are nearly ready for cutting. Clumps of the finest of yellow foliaged hardy plants, *Valeriana Phu aurea*, had grown to the extent of about 4 inches, and shone like gold in the distance. They were brighter than any Golden Feather, and did not suffer in contrast with lines of yellow Crocuses. Mr. Cottam had a fine display of flowers in his houses, and his specimen *Pelargoniums*

were steadily moving onwards, presumably to win fresh honours at the York Show, where only the best have a chance of being honoured by the judges.

— MANY will regret to hear of the sudden death of Mr. JOHN GREY, gardener to the Right Hon. Lord Willoughby d'Eresby at Normanton Park, near Stamford. He had only been ill a few days, and died while sitting in his chair on March 26th, after serving for thirty-six years as head gardener to Lord Willoughby and his predecessor. He always took great pride in the fine terrace garden, which was very pretty when filled with spring flowers, and was laid to rest only a short distance from it in Normanton churchyard on March 28th, aged sixty-eight years.—W. H. DIVERS.

— A GARDENERS' MUTUAL IMPROVEMENT SOCIETY has been formed in SUNDERLAND, and the first general meeting was held on Thursday evening, March 26th, in the Fawcett Street Café, when the election of officers took place. Mr. T. W. Bolam, Superintendent of Sunderland Cemetery, was unanimously elected Chairman for the ensuing year. The above Society is the first of its kind that has been formed in Sunderland; upwards of forty members have already been enrolled, which speaks well for a start.

— GARDENING APPOINTMENTS.—W. G. Close, Esq., late of Condover Hall, Shrewsbury, has taken Loxley Park, Uttoxeter, and his gardener, Mr. Mackenzie, has gone there with him. Mr. Wm. Smith, late in charge of Loxley, still retains the management of the estate for C. Sneyd-Kynnersley, Esq., and also the Highfields Gardens for Mrs. Sneyd-Kynnersley. Mr. Thomas Lucas, who had been foreman to Mr. Waite, Glenhurst Gardens, Esher, during the last three years, has been appointed gardener to C. W. Manse Lewis, Esq., Stradey Castle, Llanelly, Carmarthenshire. Mr. John Gilbert of Burghley, late foreman for Mr. Allis of Old Warden Park, Biggleswade, has been appointed head gardener to the Right Hon. Lord Willoughby d'Eresby at Normanton Park, near Stamford.

— GRASSENDALE AND AIGBURTH FLOWER SHOW.—The first spring Show of Hyacinths, Tulips, Azaleas, and hardy, forced, and other plants was held on Monday last at the Grassendale Parish Room. The room presented a very pleasing appearance, being filled with choice plants exhibited by ladies and gentlemen residing within the Garston Local Board district. There were fourteen competitors and 145 exhibits, the sum of £25 being given in prizes. Mr. Fletcher Rogers, in opening the Show, congratulated the Committee upon the excellent collection of plants, and expressed a hope that it would be the commencement of a long series of similar shows. The exhibits which were inspected during the day by a large and fashionable body of visitors, included some remarkably fine specimens of Orchids from Mr. W. C. Atkinson, gardener to Joseph Maidley, Esq., and Mr. J. Bounds, gardener to A. L. Jones, Esq.. There was also a large number of Callas, Hyacinths, cut Roses, Narcissus, Azaleas, Ferns, Primulas, and other stove and greenhouse plants, making in all an interesting Show, though only on a small scale. The arrangements of the Show were entrusted to a Committee, of which Mr. R. J. Bowers is Sec., Mr. Evans Treasurer, and Mr. J. Kelly Chairman. In addition to the above prizewinners the following were most successful:—Mr. J. Kelly, gardener to R. Singlehurst, Esq., and Mr. J. Agnew, gardener to Mrs. Watts. It must be stated that the promoter of the Show was A. L. Jones, Esq., who found ready help from a number of other gentlemen. The Show was held as an experiment, and owing to its undoubted success is certain to be an annual event.

— PHYLLANTHUS NIVOSUS.—A very pretty member of a large genus of Euphorbiaceous plants. It is a warm house plant of shrubby habit, and has ovate leaves that are much mottled with white, in fact the tips of the shoots are sometimes entirely white, thus giving the plant a very striking appearance. *Phyllanthus nivosus* is propagated by means of cuttings, which root quite readily when placed in a propagating frame, providing they are not too soft. The young plants require a little judicious pinching from time to time in order to keep them in shape, and will grow freely in light loam that has been moderately enriched with some old manure. Though introduced nearly twenty years ago this *Phyllanthus* does not seem to have become very common, but as the use of a greater variety of foliage plants becomes revived this charming example will doubtless find a place.

— DICHORISANDRA UNDATA.—A comparatively old plant, and could be made a very useful one if employed in the same way as small Rex Begonias are frequently used in window boxes and ferneries. *D. undata* is a dwarf-growing species from the South Sea Islands, and though this locality usually gives us the idea of intense heat yet an

extreme temperature is not absolutely essential in this case, as a satisfactory result may be obtained in a temperature of 60° to 65° with a moist atmosphere and moderate shading. *D. undata* produces broadly ovate leaves that are about 3 to 4 inches in length and of stout texture, the colour of the upper side being chiefly dark green, though marked with longitudinal bands of a lighter shade, while that of the under surface is purplish. The leaves are also curiously waved or undulated. This little plant may also be propagated by cuttings, which may be rooted as readily as those of some of the small-growing *Marantas*.

— CAMPYLOBOTRYS REFULGENS.—Another of the available plants for small work, and is here referred to under the old name because it will probably be more easily recognised by that title than under its newer designation of *Hoffmannia*. This plant will attain a height of from 1 to 2 feet, but is not specially desirable in this size, for it is much more useful in small pots. The leaves are from 2 to 4 inches in length, and dark green flushed with red on the upper side, while beneath they are reddish purple. *C. refulgens* is rather an old-fashioned plant also, but as many readers will doubtless remember is a very attractive one when well grown.—W. H. TAPLIN (in *American Florist*).

— BLACK CURRANT MITE.—Mr. Bardney has sent you a timely letter on this subject, page 222. It is now about fifteen years since I noticed its ravages in the neighbourhood of Manchester, but I did not know what it was, only that wherever I saw bushes with these thick buds they were of little value for fruit production. This matter is but imperfectly understood, and it is not many years since I observed infected Black Currant bushes going out of a nursery. As fruit growing is such an important matter if it is possible to stamp out this insect it is worthy of the best attention. It is useless to think of keeping a quarter or border of Black Currant bushes in good condition if there is one infected plant amongst them. This I have proved by having all the buds infected rubbed off in the spring, I have tried on a few bushes, which has helped to keep the insect in check, and to secure some fruit rather than throw them clean out. Fresh bushes obtained from a nursery three years ago are still quite clean though only about 50 yards distant from those infected.—R. M.

— BLACK CURRANT MITE.—The remarks by Mr. Wm. Bardney, pages 222 and 223, I have perused with much interest, as I have been acquainted with the disease since 1838, and have observed the same pest in the buds of the Hazel. One thing is not mentioned by Mr. Bardney. In all cases where the mite infested the buds there were also at same time an insect resembling aphides and of a reddish colour with a quantity of whitish mealy looking material about them and on the roots resembling those infesting *Auricula* roots. If the pest is to be exterminated every bud must be burned. I tried a number of experiments upon the mites, surrounding them with petroleum, and in no case would they cross it. Mr. Bardney mentions they assume the winged state. Is this the case? In the summer of 1869 I sent to the Editors of this Journal specimens of these buds, and they were submitted to Professor Westwood, whose account will be found in the "Florist and Pomologist" for November for that year. The Professor does not mention the winged state, but states they have at first four and then six legs, and classes them as true acaridæ. There are highly magnified drawings of the insect accompanying the article. I have picked the buds when the thermometer stood at zero, but that low temperature did not appear to affect them in the slightest, as I frequently saw the little creatures hatching from the eggs, and was amused to see how they could creep upon a smooth surface of glass back downwards with feet placed at the anterior of a long body.—W. T.

— AT a recent meeting of the WOOLTON GARDENERS' MUTUAL IMPROVEMENT SOCIETY, held in the Mechanics' Institute, the Rev. G. H. Spooner presided, and the essays read were those for which prizes were offered by the Chairman. These had been awarded to Mr. A. Kime for an essay on "Hardy Fruit Growing Suitable for Cottage Gardens," and to Mr. A. Griffiths for "Hardy Border Plants Suitable for Cottage Gardens." The papers contained much useful information to cottagers, and a discussion followed, the Rev. Chairman remarking that he had been especially pleased that such excellent papers had been written by under gardeners. He stated he would offer two prizes of 10s. each to be competed for by under gardeners (members of the Society), the subjects to be chosen by the Committee. The Committee submitted a statement as to the opening of the Society's proceedings for next season, and it was decided that it should take the form of a horticultural conversazione and exhibition of appliances and specimens connected with gardening, these to consist of literature, pictures, novelties, varie-

ties and monstrosities of plant life, dried flowers, Ferns, skeleton leaves, horticultural appliances, models of greenhouses, plans, designs, elevations of gardens and garden structures, collection of hardy fruits, vegetables, and autumn flowers, insects beneficial and injurious to plant life, apiarian exhibits with sections. Lectures with limelight and other illustrations are included. The opening will take place early in October. A vote of thanks to the Chairman closed the proceedings. With regard to this Society it is pleasing to note how harmoniously the members work together, and it would be difficult to find a Society of the same strength doing a greater amount of work during the season.

— THE WAKEFIELD PAXTON SOCIETY.—There was a very large meeting of the members of this Society recently to hear Mr. G. W. Parkin, an old and esteemed member of the Society, on a topic of the utmost importance to gardeners and agriculturists generally. For several years past Mr. Parkin has conferred great benefits upon his fellow Paxtonians by his investigations in regard to the life of the very numerous insect pests which infest vegetable products, and the operations of which frequently come under review in the cultural papers read at the meetings of the Society. Mr. Parkin's address on "Plants Injured by Insects," was rendered doubly valuable and instructive from the fact that it was illustrated by a very large number of photographic lantern slides prepared from actual specimens. Amongst the many pests referred to were aphides, leaf miners, pith moths, wood borers, gall makers, and the white woolly Currant insect, *Pulvinaria ribesiae*, a gardener's enemy discovered by Mr. Parkin during the season 1889, and fully described in Miss Omerod's report for 1890. In concluding a graphic description of the habits and characters of a number of these troublesome creatures, it was pointed out how helpful the knowledge of the life history of an insect was in attempting to check its ravages. After an interesting discussion, a hearty vote of thanks was accorded to the lecturer, and to his son, Mr. Harold Parkin, for manipulating the lantern, on the motion of the President (Major Taylor, J.P.), seconded by the Vice-Chairman (Mr. Goodyear). Alderman Milnes performed the duties of Chairman.

— LIVERPOOL HORTICULTURAL ASSOCIATION.—Last Saturday evening the concluding meeting of the season was held in one of the Committee rooms of the Free Library, William Brown Street, Liverpool. There was a fair attendance of members, and the paper provided was a prize essay on the cultivation of *Calceolarias*, *Cinerarias*, and *Primulas*. The prize was offered to young gardeners, and the successful essayist was Mr. A. Kime, of Woolton. Previous to the reading of the paper, the Chairman of the Association, Mr. T. White, expressed his regret that so few of the young gardeners had availed themselves of the opportunity of competing for the prizes. He counselled in eloquent terms the reading of some of the best books on all good subjects, and trusted that in the future they would see many more competing for the prizes and certificates offered. Mr. Kime then proceeded to read his paper, which contained much sound advice, dealing with the subject in a very able manner, treating on seed sowing, after cultivation and diseases. Previous to the discussion the Chairman presented Mr. Kime with the certificate of the Association and a copy of Mr. A. H. Bright's book, "A Year in a Lancashire Garden," which he said had given him much pleasure, and it would doubtless give Mr. Kime pleasure also. Mr. A. R. Cox, in opening the discussion, said that the best *Calceolarias* he had ever grown was where leaf mould largely predominated in the compost, and said the compost he would recommend was two parts leaf mould, one part good loam, dried cowdung, and silver sand. This compost was rather lighter than that recommended by Mr. Kime. Mr. Agnew spoke of the beneficial results from syringing *Cinerarias* late in the afternoon as a means of keeping them free from insects. Mr. Barker spoke on the germination of *Primula* seeds. Mr. Stoney paid a tribute to Mr. Kime's ability as a writer, and stated that only a week previous he had been successful in gaining a prize at Woolton. The question of fumigating was next touched upon, and several of those present were unanimous as to the superiority of Campbell's fumigating insecticide over tobacco paper. Mr. Bridge, Mr. Bennett, Mr. Thomson also spoke. Mr. Pinnington proposed a vote of thanks to the Chairman, and expressed a hope to see him as vigorous and able to preside at many future meetings.

ROYAL HORTICULTURAL SOCIETY.

MARCH 24TH.

SCIENTIFIC COMMITTEE.—Present: Mr. Dyer, in the chair; Mr. McLachlan, Dr. Bonavia, Dr. Oliver, Rev. Mr. Wilks, Professor Church, Mr. Blandford, Mr. Wilson, Mr. Pascoe, Dr. Scott, and Rev. G. Henslow (Hon. Sec.).

Rhododendrons, &c., Killed.—With reference to the opinion expressed

at the last meeting that *R. Falconeri* and other plants described by Mr. T. Bateman of Worthing had been killed by frost, he writes to say that he thinks it was more probably heat, and not frost, which was the primary cause, though frost proved to be "an accessory after the fact." The exceptionally high temperature in November had apparently stimulated them into growth, and so rendered them more susceptible to the subsequent extreme cold. Mr. Bateman also mentions that he has been compelled to abandon the out of door culture of Himalayan *Rhododendrons*, not because of the winter's cold, but because they pushed their buds too readily in March, only to be cut back by late frosts. He adds that while other species were severely injured, *R. fulgens*, *R. Thomsoni*, *R. Campbelli*, *R. lanatum*, *R. campylocarpum*, *R. Roylei*, and *R. album* did not suffer in the slightest degree. Lastly, he refers to *Olearia Haasti*, described as killed, but having had one branch layered, this remained perfectly unaffected. Mr. Wilks observed that this could readily be accounted for by its having probably been covered with snow.

Observations were made by Mr. Dyer upon the fact that shrubs at Kew—*e.g.*, species of *Cistus*, though apparently having withstood the frost, and were perfectly healthy, and pushed forth buds, yet suddenly died. Mr. Wilks said he had no doubt that the stems would be found to have been killed at the base, as the cold was always more intense for a short distance above the surface of the ground than higher up. The shrubs, therefore, had sufficient vitality above to push their buds, but of course soon perished. He remarked that Holly bushes are often denuded of leaves to a height of 2 or more feet from the ground.

Fog Report.—Dr. Oliver presented a "Preliminary Report on the Effects of Urban Fog upon Cultivated Plants." It was decided by the Committee to forward copies to the gardening and leading daily papers with the hope that readers may be inclined to communicate their experiences, so that as much information as possible may be acquired. The following are the chief lines of inquiry:—1, Urban fog and country mist. 2, Extent of the London fog area. 3, The fogs of the winter, 1890-91. 4, Constitution of fogs. 5, Physiological and microscopic work. 6, Possible remedial measures. With reference to the statement that "An increase of temperature, other things being equal, aggravates the poisonous action of the sulphurous acid in the air, a difference of a few degrees of temperature being apparent," Dr. Müller observed that one cause of this would be probably due to the fact that sulphurous acid is converted into sulphuric by an elevation of temperature. With reference to temperatures, Mr. Dyer remarked on the importance of keeping the temperature of houses as low as possible at night compatible with the limits of resistance peculiar to the plants themselves, allowing for some kinds which are peculiarly sensitive; as a rule, gardeners are apt to keep the temperature higher than is desirable, for it tended to render the air too humid and possibly injurious, whereas a cooler temperature rendered the air dryer, and the plants were less susceptible to cold. Mr. Henslow observed that the late Dr. Lindley was continually advocating the same procedure. The thanks of the Committee were tendered to Dr. Oliver for the trouble he has undertaken in preparing the report.

GREEN FLY ON PEACH TREES—SETTING AND STONING OF FRUIT.

IN answer to your correspondent, Mr. H. Dunkin, on the above subject (page 230), I cannot see how the means he suggests will prevent the appearance of aphides on Peach trees, for, as every gardener knows, this troublesome insect does most certainly make its appearance about the flowering period or shortly afterwards. How this comes about is not easily explained, for we often notice it after the house has undergone the most scrupulous cleansing, and with the best of management. I think for most trees beginning new growth green fly seems to have a particular liking, for it nearly always appears both under glass and outside at this period. No doubt this pest is induced by the conditions pointed out by your correspondent; but the best method is to pursue the middle course, keeping the structure neither too dry on the one hand nor too moist on the other, using common sense in ventilating according to the atmospherical conditions, and then, I presume, with due precaution, green fly will make but little headway. In my own practice I make it a rule to always fumigate a Peach house once or twice immediately before the flowers expand whether I observe fly or not, and by keeping a sharp look-out after the trees are in active growth for the first appearance of the pest, and fumigating slightly at once, we seldom have much injury done by these invaders, only do not wait until a colony is established.

With regard to preventing the appearance of aphides by syringing the trees when in flower, I must certainly say I fail to see the point. I can understand that by keeping up congenial conditions by damping and syringing dry corners and surfaces green fly is more likely to be kept down; but syringing Peach trees in full bloom I do not approve of, especially on dull days, which may possibly continue during the whole period of flowering. That good crops of Peaches have been obtained by this method I am well aware; but I maintain it is a system that cannot be applied indiscriminately, for much depends upon a variety of conditions. Of course, it matters little by what means the pollen is conveyed from the anthers to the stigma; the principal thing is to get it there, only it always seems to me the best method of conveying the fine grains of pollen is by a genial, buoyant atmosphere than by partly converting the pollen into a pasty matter by wetting it with a syringe. No doubt, sound healthy trees of the Royal George and Belle-garde type among Peaches, and *Violette Hâtive* and *Elruge Necta-*

lines, will set under almost any system of management; but when we come to the majority of the large-flowering varieties more care is necessary, for the fructifying organs are of a different stamp, with a more slender pistil, the stamens wider apart, and the pollen not nearly so freely produced, and I consider a few hours spent during the time the trees are in bloom in fertilising with a camel's-hair brush amply repaid; at any rate, by so doing one has the satisfaction of having adopted every available means to ensure a crop, however it may turn out. At the same time a moist condition of the air may be produced by the orthodox system of management, equivalent to syringing the trees while in flower. To syringe a house and leave ventilation on seems a singular process, for it is like trying to defeat the object you wish to attain, for a very large proportion of the moisture must escape.—J. J. C.

As I am not troubled with the above mentioned pest on the Peach trees, and have never any difficulty in obtaining a good set of fruit, perhaps a few remarks will be acceptable. In my opinion trees are often checked from chills either from too free ventilation on cold days or syringing with water below the temperature of the house, and undoubtedly as Mr. H. Dunkin remarks on page 230, houses are sometimes kept too hot and dry when trees are in flower. After a check in growth, from whatever cause, green fly will soon appear, but provided trees are in good condition and properly treated I do not think there need be much dread of the aphid or of an inferior set of fruit. Previous to expanding the lower and side flower buds ought to be rubbed off by degrees, and a hive of bees placed in the house, as bees are the best distributors of pollen that I can find. The house is kept at a temperature by night 55° to 57°, by day 57° to 60°, running up by sun heat to 65° to 70° according to weather. Should frost or very cold weather set in the temperatures are not kept so high. All the upper flowers must not be allowed to set, but thin them by degrees, and keep the young growths thinned at intervals also. After the fruit is well set they ought also to be thinned, leaving only a few more than the number required to ripen. As a rule there are far too many fruits left till after stoning; this is to allow for so many falling off, whereas if just sufficient was left for the trees to bear the dread of their falling would cease.

The next critical period is the ripening, and Peach trees are often allowed to suffer from dryness, the result being that numbers of buds fall the following season. When fruit is gathered some of the old wood may be thinned, but not so severely as to check the trees; they may also receive their final watering for the season. Except surface watering, I only supply water at the following times, and I find it sufficient—namely, previous to blooming, previous to stoning, previous to colouring, and immediately the fruit is gathered. The syringe is used freely except when the trees are in flower and when fruit is ripening. Soon after all leaves are fallen the trees may be tied in, cutting out what little wood is not required; if disbudding has been done sufficiently little pruning is required. The borders being cleaned and dressed, the trees may almost be left to take care of themselves till the season for flowering is again at hand.—SAMUEL SCOTT, *Rathmore, Belfast.*

THE ARRANGEMENT OF HOT-WATER PIPES.

UNFORTUNATELY I have lost the first article by Mr. Hammond on the subject of heating by hot water as quoted by Mr. Williams from *The Gardener*, but have examined the subsequent controversy, which I consider alludes more to the principle of heating on scientific rules rather than to the subject of my article (page 179)—the best manner of arranging the hot-water pipes in fruit houses, with a view to a better equalisation of the heat.

Will Mr. Williams say in what respect Mr. Divers' objection is full of sound judgment? Objections may be raised to any plan, but substantiating such objections with an improved method would carry much more weight. It is sometimes easier to find fault than it is to find the remedies. Again, Mr. Williams says, "We believe that the primitive arrangement which 'Heating Reformer' condemns is likely to prove a less evil than the system he advocates, but he fails to give the grounds of his 'belief.'" With regard to the efficiency of the working of five flows into one return, how can Mr. Williams condemn the plan seeing that he has had no experience? My opinion is if he saw the plan in operation with me he would want to imitate it.

I have timed the circulation of the water round a vinery 27 feet long through five flows into one return since I last wrote, and find it took one and a half minute to make the pipes quite hot equally throughout from the time the valve was turned on the flow pipe to admit of the circulation. In opposition to Mr. Williams's case, where he states that three flows to one return do not answer at a distance from the boiler, we have a late vinery 30 feet long, the end of which is 100 feet from the boiler. This vinery is fitted with three flows and one return. From the time the valve was turned on but six minutes elapsed before the pipes were quite hot equally over the house. This fact proves much more than a mere verbal objection that it is not the principle of arranging the pipes which is at fault, but instances where it is not properly carried out, hence the objection to the general plan. Experience on the spot will prove in ten minutes far more than an hour's writing. I may say that we have a span-roofed plant house fitted on each side with a single flow and return pipe. This house is at no great distance from the boiler, but much difficulty is experienced in maintaining the temperature above freezing point during severe weather. This is where there is an equal number of return and flow pipes. The non-success of the heating of this house is attributable to the faulty arrangement of the pipes.—HEATING REFORMER.

ARUM PALÆSTINUM.

It is not often we have occasion to give a representation of an Arum, but that here depicted (fig. 49) is so distinct and peculiar that it merits special notice. The plant was shown by Mr. Gold, High Ashurst Gardens, Dorking, and is remarkable for the possession of a velvety black spathe and spadix, 6 inches long each, and borne on a stem about a foot in length. The leaves are about the same height, the blades 6 inches long, lobed, and the same in breadth



FIG. 49.—ARUM PALÆSTINUM.

across the base. The spathe is tapering in form, purplish towards the base, deepening into black at the upper part.

Arum palæstinum was discovered by M. Boissier near Jerusalem, and from there Messrs. Veitch & Sons of Chelsea introduced it to cultivators in this country.

ON THE EFFECTS OF URBAN FOG UPON CULTIVATED PLANTS.

[Preliminary report by Dr. F. W. OLIVER, presented to the Scientific Committee of the Royal Horticultural Society, March 24th, 1891.]

THE investigation, as to which I am now drawing up an interim report, has been undertaken by the Royal Horticultural Society's Scientific Committee, supported by a grant from the Royal Society to meet the cost of apparatus, &c. The question of the effects of urban fog on plant life has come prominently before our town and suburban cultivators, and the damage from this cause, which may formerly have been regarded as exceptional, is now admitted to be chronic and constitutes an ever-increasing source of dismay to all interested in horticulture. The action of the Scientific Committee in taking up this question is but the reflection of a general feeling amongst cultivators that something

ought to be done. A winter never passes now without one or more prolonged spells of fog, contaminated with the products of coal combustion. For weeks at a time, during the winter, the London suburbs are enshrouded in semi-darkness whilst the air is tainted with foreign and offensive matter. Coincidentally, there occurs a dropping of buds, a destruction of flowers, and, what is more serious, a wholesale annihilation of the foliage of most tender, softwooded stove plants. The leaves of certain genera of Orchids and of hardwooded plants turn yellow when these visitations are prolonged. It seemed to the Scientific Committee desirable that steps should be taken to ascertain to what constituents of fogs the various classes of injury, enumerated above, are due; what part is played by the various acids present; whether the tarry products exert any specific action; and how far the conditions of semi-darkness participate in the destruction. It was also considered desirable to make special investigation into the exact nature and amount of the impurities present in urban fog, and to observe the varying effects on vegetation of fogs differing in quality. The Committee, though hardly sanguine that any knowledge that might be obtained by such an investigation would lead to any effective abolition of the evil, was of opinion that such an inquiry was desirable in view of the great interest of the question. In any case, such knowledge was necessary before special cultural precautions could be recommended as likely to mitigate the evil to an appreciable extent. A full understanding of the disease must precede any steps for its amelioration. Whilst the Scientific Committee was arranging for the carrying out of a systematic inquiry in the London area, the Manchester Field Naturalists' Society was taking steps in a similar direction. The Manchester Committee proposed to make systematic analyses of fogs at many stations and at various elevations, with a view to finding out everything appertaining to the genesis and composition of their city fogs, with especial reference to their injurious effects on animal and vegetable organisms. Further reference will be found in the body of this report to the Manchester investigation.

Since October last, the London inquiry has been in active operation. Circumstances have led the Committee to look to me for the execution of this research hitherto, and I now summarise shortly the general lines along which the inquiry has proceeded. Throughout I have had the constant advice and help of my colleagues on the Committee, and my task, without their many suggestions, would have been a more difficult one than it has actually been. It is not proposed to enter here into the accumulations of facts bearing on the question that I have been able to collect by observation, correspondence, and experiment, but to indicate only the lines of inquiry in the hope of obtaining criticisms likely to be of value in the further prosecution of the work. It will not be possible or desirable to prepare any detailed report till another year has elapsed. My observations so far deal almost entirely with plants cultivated under glass. It will be convenient for the purposes of this report to take the several lines of inquiry, and to deal with them in successive paragraphs.

I. *Urban Fog and Country Mist.*—In an inquiry into the action of so complex a product as urban fog it was of the greatest importance to obtain reliable data as to the effect on vegetation, if any, of pure country mists, uncontaminated by smoke. It was impossible for me personally to make the observations needful to establish the injurious or other action of mist upon plants; but, by the courtesy of correspondents in country districts, quite away from areas of smoke genesis, it would appear, so far as observations are as yet to hand, that little or no injury to stove or conservatory plants arises from this cause. Indeed, pure mists would seem to be beneficial to certain classes of cultivated plants. In those instances in which any injury obtained it was, in most cases, referable to some other cause. The establishing of this point is of great importance, since foggy weather is so frequently attendant upon spells of frost, and it has been frequently suggested that the increased stove heat needful to maintain the requisite temperature would have a harmful action. Indeed, I was quite prepared to find this to be the case at the outset of the inquiry. My own observations during cold weather in London without fog, and the evidence to hand from a distance as to frost with and without mists, point to the fact that, with proper precautions, no appreciable damage is done to plants.

In general, the same remarks apply to small towns away from manufacturing areas. With the increase in the size of the towns, the conditions more nearly approximate to those of London. The fog leaves the well-known deposit of filth on glass houses and evergreen foliage; and if such districts escape the more serious effects observable in or near the larger smoke-producing areas, it is due to the relatively small concentration of the impurities in those fogs. It seems to me desirable to obtain accurate analyses of fogs from some country town of say 50,000 inhabitants, in which manufactures are not carried on, for comparison with similar analyses from the metropolis.

II. *Extent of the London Fog Area.*—I have been at great pains to ascertain how far the London fog cloud extends around the metropolis. In this I have had the most cordial co-operation of our nurserymen and cultivators, who have supplied me with detailed information as to the times of occurrence of fogs, and as to the nature and extent of the injuries sustained. In many cases I have availed myself of the opportunity to visit their collections, and form an estimate of the damage done, valuable for purposes of comparison. The extent of the fogs is greatest in a westerly and south-westerly direction, and has been traced as far as thirty-five miles away westward, and twenty-five miles south-west, under special atmospheric conditions. Exceptionally the London fogs are met with at even fifty miles distance on this side. With the wind in an easterly or north-easterly direction these outlying districts receive visitations of fog with the accompaniments of sooty

deposits and sulphurous smell. No doubt the concentration is not so considerable nor the duration so long as nearer London, but it is sufficient to at once affect the buds and flowers of such sensitive Orchids as *Lælia anceps*, *Cattleya Trianae*, *Calanthe*, &c. The effect of the fog on foliage at these distances is fortunately small, though in certain instances it is sufficient to destroy the seedlings of *Cucurbitas*, *Tomatoes*, &c., which are extremely sensitive. As one follows the effects of fog down the Thames valley, from the most outlying stations affected, to London, the observed effects increase in severity, till they are indistinguishable from those noted at stations actually within the metropolis. At Kew, for instance, the destruction has been most disheartening, it having come to flowers, flower buds, and foliage alike. Effects of similar nature, but less in total magnitude, are reported from spots five miles further west. Southwards, the North Downs afford a valuable barrier, which in many cases would seem to filter off the more deleterious constituents of the fog. Indeed, the configuration of the country and the nature of the subsoil have an important influence in determining the immunity of a given locality from damage. Eastwards I have information as to damage from so great a distance as Maidstone, over thirty miles. All my correspondents emphasise the non-hurtful nature of the sea fogs prevalent in this quarter. To the north and north-east the fogs effects do not extend to such extreme distances, and the conditions for winter cultivation are consequently more favourable for cultivation on that side of the metropolis. Mr. E. Mawley of Berkhamstead has furnished me with some interesting meteorological details regarding fogs extending to this locality (twenty-six miles N.W.).

The tabulation of the information bearing on the subject of this paragraph will form a valuable appendix to my detailed report.

III. *The Fogs of the Winter 1890 91.*—It is needless to say that the past winter has been one singularly favourable for the purposes of an investigation of this character. The season opened with a severe fog of short duration during the second week of October, which left its traces on vegetation in the London area. This was the only serious instance of a fog on which observations of hardy plants could be made, as the conditions were not complicated by the presence of frost. I am indebted to C. T. Drucry for an interesting account of its effects, unprecedented in his experience, upon his collection of hardy Ferns at Forest Gate. Though there were minor fogs during November it was during the long periods before and after Christmas, and again in February, that all the worst effects were exhibited by vegetation under glass. These two spells differed considerably in their nature. The Christmas fogs were accompanied by exceptionally severe frosts, were on the whole much darker overhead, and contained a larger amount of noxious matter. In addition to this the duration of daylight was considerably shorter than in February. On the other hand, though in February the fogs were exceedingly opaque, the general average of light reduction was not so great as at Christmas. The vertical extent of the fogs in February was such that on many occasions the sun was able to partially disperse them for a short period at noon.

Both fogs had a marked effect on flowers, but on the whole at Christmas, to instance only one genus of plants, *Cypripedium*, the effects were much more marked. *Cypripedium* is perhaps as little affected by fogs as any genus of Orchids I have met with. Yet, in a large collection, continuously under my observation, it was patent that the damage done was markedly less in February than at Christmas. In the collections of plants under observation the damage to foliage was also greater during the former; this both as regards the dropping of leaves, which I have reason to believe to be greatly brought about by the reduction of light for a lengthened period, and also in the formation of actual corrosions of portions of the leaf surface.

It must be remembered, in estimating the relative damage caused by these two fogs, that the earlier one destroyed a greater part of the foliage of very many softwooded plants, so that there was less surface exposed for attack at the second occasion. Nevertheless, so favourable were the circumstances during the latter part of January and the first week in February, that rapid growth had in many cases taken place. If we narrow the comparison to the damage (corrosions) sustained by young, and relatively unprotected leaves during the two periods, without doubt that at Christmas was immeasurably greater than in February. These remarks are based on observations on collections continuously under my eye, and situate in the worst districts. Full details are not yet to hand from correspondents at outlying stations, so that it is possible I may have to modify these observations when I come to take a general survey. Thus at Kew, the ill effects noted after the February fogs were quite as bad as at Christmas, whilst further east the reverse was the case. Other considerations confirm the view, that in February the fog-nucleus was several miles further west than at Christmas. I have in my notes full details of the damage obtaining from these fogs from many sources, but with these horticulturists are, in general, only too familiar, and they may well be reserved for the report on the whole question.

IV. *Constitution of Fog.*—On a purely chemical question, such as that of the constitution of fog, I am scarcely entitled to speak. However, since at the outset of this inquiry it was deemed advisable to obtain as much information on the matter as possible, with especial reference to those components deleterious to vegetation, I will state briefly what has been done.

The Meteorological Council very readily put at our disposal the pump and apparatus originally constructed for Dr. W. J. Russell's investigation. The whole apparatus was thoroughly revised and set up under the

direction of Dr. Russell. Since the middle of December frequent washings of fog have been obtained with it. Those are now undergoing analysis. In addition, samples of many fogs have been aspirated through a solution of permanganate of potash—the volume of fog necessary to decolorise the pink solution being registered by a meter constructed on the wet system.

The permanganate is extremely susceptible to sulphurous acid, probably the chief agent of damage present in the London atmosphere. A comparison of the volumes of air necessary to completely bleach a known amount of permanganate in foggy and in fine weather is striking. Whilst during a severe fog as little as 1 or 2 cubic feet is sufficient, in fine clear weather 30 or 40 cubic feet may be aspirated without causing an appreciable decoloration. Even a rough method such as this would become an instrument of some precision in the hands of a chemist, and would furnish results of the greatest value in comparing the damage to vegetation inflicted by separate fogs.

During the winter collections of snow from equal areas were made at frequent intervals, and the amount of matter precipitated upon it from day to day estimated. At the close of the February fogs the opportunity was taken to make scrapings from 20 square yards of the glass roofs of plant houses at Kew and at Chelsea. The glass at both localities had been washed just before the commencement of the spell of fog. Each yielded an almost identical amount of deposit—i.e., 31 grains per square yard, or 6 tons per square mile.

Dr. G. H. Bailey, of the Owen's College, Manchester, was good enough to analyse the samples, and furnishes the following as the result of a preliminary examination of that from Chelsea:—"It consisted of about 40 per cent. of mineral matter, 36 per cent. of carbon, and 15 per cent. of hydro-carbons. It was interesting to note that there was present also 2 to 3 per cent. of metallic iron in minute particles. The sulphuric acid present amounted to nearly 5 per cent., and the hydrochloric acid to $1\frac{1}{2}$ per cent. The presence of such large quantities of volatile oils explained the oleaginous character of the deposits which formed from London smoke, and it had been noticed that, especially in the districts of Manchester, where dwelling houses were much crowded together (e.g., Hulme), the deposit has a similar character."

The deposits on both outdoor and greenhouse foliage have been from time to time collected, as well as the daily accumulation on a single pane of glass during foggy weather. The examination of these deposits is not yet concluded. The work this winter on this portion of the inquiry can only be regarded as preliminary in its nature. I will state here briefly what lines might be followed in future. Continuous observations from day to day, and sometimes from hour to hour, during dull weather, recording the fluctuating amounts of the hurtful components present in the atmosphere are much required. These should be obtained simultaneously at a number of selected stations—for the purpose of this investigation situate, preferably, near establishments where plants are under cultivation. A knowledge of the varying amounts of these components would be of the greatest value in making a comparison between the nature of the damage incurred by vegetation in different localities and at different times.

It is obvious that had we possessed this winter stations for fog analysis at, for example, Kew, Chiswick, and South Kensington, we should be in a better position to explain the differing effects of the Christmas and February fogs respectively at the last named and their very similar action at the first named. Dr. G. H. Bailey has been devoting himself to a chemical investigation of this character in Manchester. He has now perfected apparatus by means of which systematic records of the kind indicated can be obtained. The apparatus in question is being fitted up at numerous stations in Manchester, and fully justifies his anticipations as a simple method which does not require manual labour, as is the case with the Meteorological Council's pump. My proposal is that the balance of our grant be used in establishing a number of stations in London and its suburbs on precisely the same lines as those being employed in Manchester, the two inquiries, so far as the chemical investigation of fog is concerned, running *pari passu*. Dr. Bailey, with whom I have been in constant intercourse, is willing to co operate in this undertaking, the experiments and analyses in question being made under his direction and control. This joint scheme has, I think, the additional recommendation of being likely to produce total results of greater value and at a less expenditure of energy than if the investigations at Manchester and London be conducted independently. Dr. Bailey and his colleagues have just issued a preliminary report on the atmosphere of Manchester.

(To be continued.)

WINTER SUNSHINE.

As everybody is aware, February, 1891, was remarkable for its excessive dryness and for the absence of anything approaching stormy weather. Many will also be disposed to remember it as a month in which we had more than our ordinary share of fog, particularly during the second half, when fog seemed to be very general over the eastern and south-eastern parts of England. It will be a surprise, therefore, to learn that, in spite of the exceptionally foggy character of the month, the amount of bright sunshine which was registered, over England especially, was altogether abnormally large. And what is still more surprising is that the second half, which included the days when the fogs were reported as most dense and widespread, was very much more sunny than the first half. According to the statistics published weekly by the Meteorological Office, the average duration of bright sunshine in

the twelve forecasting districts for the month of February is 89 hours in the Channel Islands, 72 hours in the south of Ireland, 46 hours in the extreme north of Scotland, and in the other nine districts it varies between 60 and 69 hours. In the period now under review, however, the recorders registered 167 hours in the Channel Islands; 126 hours in England, S.W.; 108 hours in England, S.; 102 hours in England, E., and Midland Counties; 97 hours in England, N.W.; 90 hours in Scotland, E.; 88 hours in England, N.E.; 80 hours in Ireland, S.; 73 hours in Ireland, N.; 59 hours in Scotland, W.; and 54 hours in Scotland, N. With the exception, therefore, of the West of Scotland, where there was a deficiency of one hour, every district showed a considerable excess of sunshine, England and Wales taken as a whole having 104 hours against an average of 65 hours, the increase being 60 per cent., the south-western counties showing an excess of 83 per cent.; while the Channel Islands had 88 per cent. more than the average. The records for the individual stations in the several districts are even more interesting. Out of forty-one stations the following twenty had at least 100 hours of bright sunshine for the month:—Jersey, 167; Hastings, 135; Plymouth, 134; Torquay, 128; Falmouth, 126; Pembroke, 125; Cirencester, 124; Southampton, 123; Cullompton, 120; Llandudno, 120; Eastbourne, 118; Stowell, 118; Churchstoke, 115; Aberdeen, 113; Hillington, 104; Cambridge, 103; Newton Reigny, 102; Marchmont, 101; Geldeston, 100; Rothamsted, 100.

This wonderful outburst of sunshine was not confined to the south coast stations. Llandudno had a better record than Eastbourne, Aberdeen came very near, while Newton Reigny and Marchmont, both northern stations, fall into the list of high totals. The average daily excess ranged from more than 1 hour at Geldeston to nearly 3 hours at Jersey. The only station in the kingdom which had a deficiency of sunshine was Glasgow, the total duration being 34 hours, or 12 less than the normal. Fort Augustus had 40 hours, but the average is not known for this station; London comes next with 42 hours, and, small as was the total, it was 5 hours above the average. Ireland did not have a large excess; Dublin, with 91 hours, was 22 hours to the good, and Armagh, with 73 hours, was 12 hours above the average; but elsewhere the normal was exceeded by from 2 to 10 hours only. The figures quoted for the month as a whole are quite exceptional for so early a period in the year; but about three-fourths of the total sunshine was registered in the last fourteen days. Indeed, in the first week the amount recorded fell below the average in eight out of the twelve districts, and in the following week four districts were still deficient; and this fact accounts for the excess of the last fortnight at Hastings, Pembroke, and other places being actually larger than that for the entire month. During the fourteen days, 15—28, there were several stations other than those included above which had from 50 to 80 hours of sunshine. At Dublin, Durham, Geldeston, and Oxford the excess was as much as 2 hours per day above the average; Llandudno and Hastings were favoured with an extra 4 hours per day, and Jersey rather more than 5 hours. For London the Meteorological Office gives 18.9 hours in the first half, and 23 hours in the second half of the month; total, 41.9. The Royal Observatory had respectively 24.2 hours and 46.5 hours; total, 70.7. The influence of the fog on the western districts is seen in the difference for the last fortnight, when the south-eastern quarter had rather more than twice as much sunshine. The Greenwich record is an excess of 29 hours on the average for the month, or a little over 1 hour per day. This is very good under the circumstances, but Londoners cannot help envying the more fortunate districts beyond the limits of metropolitan fogs; even distant Aberdeen, although entitled to less sunshine owing to latitude, having nearly three times as much brightness as western London.—(Nature.)



ROSE PROPAGATION IN AMERICA.

THE budding and other systems of propagation so successful with European florists on account of their cool summers and attendant atmospheric moisture cannot with profit be pursued here; the consequence is that all other methods are abandoned in favour of propagation by cuttings, which is the great system of propagation in which all American cultivators excel the growers of other countries.

The cuttings are inserted in sand in a heated frame or propagating house. When the beds are duly prepared, the first act of importance is the proper selection of the cuttings; if these are not in the proper condition no amount of other attention will make marketable plants of them. The young shoots of the Rose is what is to be used, but avoid a soft pithy growth as much as you would an old or hardened one. When a Rose bud is developed enough to cut, the shoot on which it grows is in a proper condition to make desirable cutting wood as well as all other wood of a similar development. Each leaf of the shoot with its bud at the axil, and 2 or 3 inches of a stem, makes what is known to the trade as a one-eyed cutting. They are simply made by making one rather slanting cut between the joints, or about a quarter of an inch above the eye. About one-third of the leaf is cut off, mainly to admit of more cuttings being put in the cutting

beds or benches. If by any reason the leaf is taken off, a Rose cutting in this condition will never make a satisfactory plant, or if from any cause the leaf drops off while the cutting is in process of rooting, very few, if any, will make satisfactory plants.

Some years ago, especially so in the old country, a popular error existed that a joint should be retained on the extreme end of the cutting; this would necessitate two joints on the cutting, one on the top and one on the bottom, which is a great waste of cutting wood, a serious objection where new kinds are being propagated and cutting wood scarce, as with the two-joint system it takes as much wood to make one cutting as would make two with the one-eye system. The joint at the end of the cutting has nothing to do with its rooting; of course it will root with the joint on the end, but it will root just as well without the joint being there at all.

The best plan is to cut them all of a uniform size regardless of the eyes. With some varieties good sized cuttings can be made with one eye, while with other close-jointed varieties two or more joints will be necessary to get a cutting of fair size. After the proper selection of cuttings they are inserted in clean pure sand. No vegetable matter of any kind, or soil of any description, is allowed among the sand. Clean gritty sharp sand is best. With close attention as to sprinkling and keeping up a proper degree of atmospheric moisture, Roses will, under these circumstances, root in about twenty or twenty-five days, when they should be potted in 2-inch pots, using a compost of fibrous loam with a little sand added. Shading will be necessary for some time after potting, and the same close attention as to moisture and sprinkling should be maintained as when in the cutting bed. Use fresh sand for each batch of cuttings, and keep the temperature of the sand at from 60° to 65°, with the temperature of the house a few degrees less.—JAS. MORTON, (in *American Florist*).

PRUNING ROSES.

THE time of pruning Roses affords a good opportunity of seeing how they have stood the severe weather of the past winter. The frosts have played sad havoc in many collections, and it would be interesting to have the experience of different correspondents, with the names of varieties that have suffered most. Although much damage has been done in some parts, it will be found in others that the injury is not so serious as expected; for, although many plants appear to be killed, it will be found on examination that they are alive at the base, especially where they have been well mulched, and will shoot from the ground line. This was my own experience. I had expected to find many dead, especially amongst the Teas, and some that were only planted from pots of new varieties in the autumn, but I only found one killed (Niphotos) in the whole collection. Although many of the Teas were cut down to the level of the mulching, the Hybrid Perpetuals appear to have stood the winter very well. I give the names of a few of those that have suffered most here:—Star of Waltham, Mrs. H. Turner, Marie Verdier, Lord Macaulay, Le Havre, La France, Duc de Roban, and Ulrich Brunner; Teas, Niphotos, Climbing Niphotos, Sunset, Ye Primrose Dame, Safrano, and Madame Falcot. Moss Roses seem to have stood very well, whilst amongst climbers the only ones that appear to be much hurt are the Climbing Niphotos, Cloth of Gold, Solfaterre, and Narcisse. Although some of these are classed as weak varieties, others will be found amongst those that have stood the best in other parts of the country, and extra care will be required when pruning.—R. C. WILLIAMS, *Crosswood Park, Aberystwyth*.

HORTICULTURE IN AMERICA.

[A paper by Mr. JAMES H. LAING, F.R.H.S., read at the Birmingham Gardeners' Association, March 9th, 1891.]

(Continued from page 249.)

LEAVING Mr. Allen I visited Messrs. Hallock & Son, Queens, who take nearly the front rank in the States for floriculture, having produced many floral gems. Gladioli appear to be a leading speciality here, and the many excellent varieties seen was a proof of the firm having a grand strain. Snow White, sent out by them, I saw in fine condition, certainly much superior to what we have seen in England. What impressed me most were seedling Gladioli in bloom, showing a great advance in size, form, and colour of the flowers; the spikes were also more erect and stout, and flowers more brilliantly coloured than are usually seen. Cannas were a great feature, all the latest and best sorts being grown; they formed a splendid sight when seen last August. This elegant flowering plant is easily cultivated, and only requires a good rich soil, and if planted out in May or June they will flower profusely until cut down by frost—late in the autumn. American gardens especially would be shorn of much of their beauty without them, the climate suiting them admirably. Carnations receive great attention, large collections of the best sorts being grown; also a large house or two were filled with plants for cut-flower work in the winter. These are planted early in September in raised benches, covered with 4 inches of soil made moderately rich with well-decayed manure. Many think solid benches preferable, as the flowering season continues longer. The chief varieties cultivated were: Alexander, Andalusia, Anna Webb, Buttercup, E. G. Hill, Geneva, Grace Wilder, Harrison's, Hinze's White, Lady Emma, Lambton, Lizzie McGowan, Louise Posch, Mrs. Fisher, Portia, Silver Spray, and Tidal Wave—sorts not grown and hardly known in England. The Americans say that English varieties, with few exceptions, will not grow with them, and we can say the same.

I next called upon that very energetic and enterprising florist, Mr. John Lewis Child. Situated in an excellent position in the richest and most fertile part of Long Island, which may be called the garden spot of New York State, Mr. Child has selected his home well. He was busy superintending the building of a new and large seed warehouse, and other alterations, and at once gave me an audience. He has a great many softwooded and other kinds of plants, all grown to meet the demands of a large mail trade. Chrysanthemum Mrs. John Lewis Child (John Laing & Sons are the European agents for it) was strongly recommended as a noteworthy variety. Cacti, Sansevieras, and Stapelias are grown in quantity too. Cannas Childsi, Ehemanni, and several others were flowering splendidly. I also called on Mr. John H. Taylor of Bayside, where I saw housefuls of Roses in admirable order, which fully justified his excellent repute as one of the best cultivators.

Leaving New York for Boston, U.S.A., I joined the magnificent steamer "Puritan," a real floating palace, of which our American friends may well be proud. It is 403 feet in length, 52 feet in breadth, and 21 feet in depth of hull, steered by steam, and lighted throughout by electricity. The party which I accompanied on board the "Puritan" numbered 193, including the New York and Philadelphia delegations, and young Mr. Hugh Dickson from Ireland, in addition to a large number from adjacent cities. A surprise was in store for us, for we were invited to dine with the New York Florist Club. The dinner was held in the large dining saloon, which was brilliantly lighted by electricity and magnificently decorated. In the centre of each table was a large plateau of choice flowers, while the many sideboards on each side of the saloon contained beautiful plaques and plateaus of Carnations, Roses, &c.; the air was heavy with their perfume, and that, together with the hearty goodwill of our hosts and their bounteous spread, made an occasion that will long be remembered as most pleasant, especially by the "Londoner." Passing up the East River to the Fall River we go under the Brooklyn Bridge. This is the largest suspension bridge in the world. Its height is 135 feet, length 5989 feet, width 85 feet, which includes a promenade for foot passengers, two railway lines on which are run passenger carriages, propelled by a stationary engine from the Brooklyn side, and two roadways for vehicles. It was thirteen years constructing, and cost about three millions sterling. From it you have fine views of the river, bay, and the two cities of New York and Boston.

The Long Island route of the Fall River is attractive beyond description. The natural beauties must be seen to be appreciated. From the head of Mount Hope Bay at one end of the route until the Battery is passed and the North River pier reached at the other, a constant succession of scenic perfections alternate. All the deck arrangements of the boat were such that these natural beauties could be fully witnessed by passengers. We all arrived in Boston in capital spirits. We were met at the depôt by a contingent of the Boston Florist Club, headed by the noble Mr. W. J. Stewart, the Secretary. I could not help remarking *en route* the fine plants of Ampelopsis Veitchi (or Boston Ivy) as the Bostonians call it. I quote a few words on the matter:—"One needs to see the great walls covered with its bright leaves, which overlap each other like the tiles on a roof; to see the turrets wrapped in its green folds, and the windows wreathed in its shining foliage, to be able to appreciate its beauty. Unfortunately the Ivy of England can but poorly battle with the extremes of the American rude winters, but the Japan Ivy, with the same power of clinging to the surface as its Old World cousin, by dropping its foliage when severe winter frosts set in, passes safely through our colder winters. Not suddenly, on the first approach of frost, do the leaves fall, but the dying foliage puts on fresh hues and glorious tints every day. One can scarcely realize the charm which this little climber gives to the home, and how it relieves the monotony of bare walls."

Boston is a fine old city. The older portions of the streets are narrow and irregular, though something has been done toward straightening and widening them since the fire in 1872. Those in the new section built on the made land of Back Bay are wide, well paved, regularly laid out, and present a handsome appearance. The boot and shoe markets here are considered to be the largest in the world. Boston is the aristocratic city in the U.S.A. It is a splendid idea of the well-managed Society of American Florists to hold its annual meetings and conferences or convention in the chief provincial towns, thus adding strength and notoriety to its body. It was a happy choice, the selection of Boston, and I doubt if the experience and pleasure we had there will ever be surpassed, though, perhaps the Canadians of Toronto, where the convention goes in 1891, may try to equal it. Try and imagine nearly a thousand florists and their wives from all parts of the States and Canada (Mrs. and Miss Berger, of the well-known house of H. H. Berger and Co., San Francisco; Mr. Howyt from Florida, and many others attended), collecting once a year at these social and instructive gatherings! What a friendly intercourse and impetus it must give to the Yankee horticultural world!

The Horticultural Hall, Tremont Street, and the home of the Massachusetts Horticultural Society, incorporated in 1829, is a fine building. The front is of dignified and monumental character, and is embellished with costly statues of Ceres, Flora, and Pomona. After ascending the broad flight of stairs you reach the hall, where the weekly exhibitions are held. On the same floor are the offices of the Secretary and Treasurer, also the valuable library of the Society.

The large hall, used in addition to the lower hall at the annual and other important exhibitions, occupies the upper floor. The Convention opened on Tuesday, August 19th, 1890, the Hon. Wm. H. Haile, the

Lieut.-Governor of Massachusetts, the Hon. Thos. N. Hart, Mayor of Boston, and other influential citizens, and all the leading members of American trade being present. The President for the year (Mr. J. M. Jordan) made a good address, and he said, amongst other things, "Much is expected of this Society in its organised efforts, not only to instruct its members in their daily avocations, but to educate the masses in horticulture by widening and deepening an interest in our profession, by increasing our membership, active and honorary, until we enrol all the leading men of the country who are interested in the various callings of horticulture; all men engaged in scientific research tending to advance the profession; the formation of kindred associations; encouraging exhibitions of plants and flowers by bringing into closer relations the retail dealer with the grower and wholesale dealer—unless the retail dealer can make a success of his business the grower cannot hope to do so. There should be established some measure of qualification of young men entering into the employment of florists to learn the business, and with proper influence we could have graduated at many of our institutions of learning young men suitable for apprentices in our profession; and this opens up another subject, in keeping with the former, looking to the same end, and that is suitable books to be used in our schools, teaching the fundamental lessons in horticulture. No school of recognised ability to graduate a pupil should leave out of its curriculum books of that kind, and even our common schools should teach the rudiments of horticulture." Mr. Robt. Craig, the eminent Philadelphia florist, responded in a very able manner, and thanked the Bostonians for their cordial welcome. He also said that they were proud to be in Boston for many reasons—namely, because it was a historic city, possessing institutions of learning, magnificent libraries, and on account of the noted men and women it had produced. Some of the greatest poets, philosophers, and statesmen lived and laboured in Boston. They should also remember that Boston is the centre—the acknowledged centre—of horticulture in that country. It is also the home of the greatest, the most successful, and one of the oldest horticultural societies in America. Several other speeches by the officers of the Society concluded the opening ceremony.

We next proceeded to view the Floral Exhibition in the Music Hall. This was a fine though badly lighted hall in the daytime. Its dimensions were 130 feet long, 78 feet wide, and 65 feet high, with large balconies. The Show opened at noon; certainly an excellent affair. The Committee had arranged everything most artistically, on the pattern of a Ghent Exhibition, though more space was required, the exhibits being so numerous. Entering the Show the first thing that attracted the visitor on the tastefully arranged platform was a huge and magnificent specimen of *Croton Queen Victoria*, grandly coloured and grown, equal if not surpassing any I have seen in England. At each end of the stage two fine specimens of *Allamanda Hendersoni*, flowered to perfection, were placed. Handsome groups of foliage plants fronted the platform, and down the sides of the halls, interspersed with flowering plants, I noticed fine examples of *Dracena indivisa variegata*, *Cycas circinalis*, *Davallia fijiensis*, and *Ficus Parcelli* by Mr. Fred Harris, gardener to W. H. Hummewell, Esq., which gained a first prize. This exhibitor also showed *Phœnicophorum seychellarum* and *Cocos Bonetti* in grand form, securing another premier award. A few excellently flowered *Anthuriums* were exhibited by a Mr. Pratt. Geo. A. Nickerson, Esq., had an extra fine plant of *Phoenix rupicola*. Mr. Mac. William's superb *Heliconia aurea striata* and two *Peristeria elata*, well flowered, were worthy of note. The Botanic Gardens of Cambridge, Mass., exhibited an array of Cacti and several other curiosities and interesting plants. The remarkable flowered *Hydrangeas* of Mr. Gardener, and his large plant of *Agapanthus umbellatus*, with twenty-eight flower scapes, were a sight. A feature in the Show, and one of novelty to a Britisher for the first time, was the effectual display made of Pond Lilies and aquatics, floating and neatly arranged in tubs of water; *Nymphaeas dentata*, *odorata*, *cœrulea*, *candidissima*, *Devoniana*, *alba*, *stellata*, and *zanzibarensis*. *Pistia stratiotes* and the Egyptian Lotus were principally the kinds exhibited.

Orchids were well shown from the famous collection of F. L. Ames, Esq. Mr. Robertson certainly is a first-class cultivator, his various exhibits bearing the result of skilful management, and he worthily deserved the post of honour for the following:—*Oncidium Kramerii*, *Odontoglossums vexillarium superbum*, *albo-sanguineum*, and *grande* with seven spikes; *Cypripediums Morganæ* with two spikes of three flowers each; *macropterum*, *œnanthum superbum*, *grande*, *Curtisi*, with five very large dark flowers; a fine specimen of *Cattleya Eldorado*, with twelve flowers; also *Cattleyas Gaskelliana* and *Warszewiczii imperialis*, with two spikes, bearing five immense blooms.

Mr. Ames took first prize for the best single Orchid in bloom—namely, *Lælia elegans Littleana*, and a superb plant it was, nearly 4 feet high, with a spike of eight brilliant blossoms. *Lælia crispa superba*, bearing five spikes and carrying forty-five flowers, was also a remarkable exhibit. At the lower end of the hall, just under the balcony, the Boston florists had prepared novel exhibits, showing their taste in decorating dinner tables and mantelshelves. Four compartments were partitioned off by draperies, and each was partly furnished with dining-room furniture and tables all set for guests. Amid the glass, silver, china, tall and graceful Palms rising from beds of moss, with rare cut flowers, were tastefully arranged; and in a corner of each room was a mirror, mantelshelf, and fireplace, which were decorated with effect. Mr. David Allan's first prize mantelshelf was elegant in every respect. Up each side of the mantel *Croton*s, *Cocos Weddelliana*, and variegated *Alocasias* were arranged, and in the fireplace umbels of the white *Agapanthus* were stuck amongst *Adiantum trapeziforme*; the mantelshelf was

banked with *A. farleyense* trimmed with Orchid blooms, and draped with long sprays of red *Lapagerias* gracefully hung. The decoration was surmounted by a *Croton Queen Victoria*, relieved on each side by a plant of *Pandanus Veitchii*. Splendid pitchers of *Mastersii* and other *Nepenthes* trimmed the lamps, and yards of *Asparagus* fronds were freely used. The Orchids used were *Odontoglossum vexillarium*, *O. Alexandræ*, and *O. Sanderiana*; *Grammatophyllum Ellisi*, *Cypripedium Curtisii*, *C. Lawrenceanum*, *C. Harrisianum*, *C. Stonci* and *Crossianum*. These table decorations were naturally greatly admired by the large concourse of visitors. Every day the table decorations were varied and replenished with fresh flowers, hence it is always an attractive sight to the end of the Show, a plan that should be adopted. I think in our shows of several days' duration, though perhaps it depends on the monetary prizes. Trade exhibits were numerous and generally good. Mr. J. C. Vaughan, the well-known Chicago seedsman, exhibited a pretty *Polyantha* Rose named *Clothilde Souper*. Boileus, garden sundries, and requisites were there in great numbers and varieties. Conferences of great interest were continued during the four days of the Convention.

Well-written papers and essays were read, discussed, and attentively listened to by a good audience. Discussions were carried on with spirit,



FIG. 50.—SPIRÆA CONFUSA.

the question box used being kept going. The paper of that enthusiastic amateur florist Mr. Gurney Hill (Indiana), on the review of plants of recent introduction, was terse and commendable. Mr. John Thorpe, the father of S. A. F., and a nurseryman who figured conspicuously some years ago in England, was a tower of strength in many respects.

(To be continued.)

SPIRÆA CONFUSA.

So much interest was caused by Messrs. J. Veitch & Sons' group of *Spiræa confusa* at the recent meeting of the Royal Horticultural Society that the accompanying woodcut (fig. 50) will be welcome to several correspondents who desire information concerning the plant. It is especially useful for early forcing, because the plants can be lifted from the open ground, and after suitable preparation they are placed in heat, and flower in a short time. The habit of this *Spiræa* is compact yet graceful, the slender branches being clothed with fresh green leaves, and terminate in neat heads of pure white flowers, which are produced very freely and last for a considerable time.

Spiræa confusa is as easily grown as any other form of the genus. A good loamy soil suits it, and after forcing the plants should be encouraged to make a free growth, which must be well matured out of doors in a sunny position, as they will thus gradually acquire an earlier habit of flowering. If planted out they should be lifted early in the year, potted, and introduced to moderate heat, as if placed in a strong heat they are not so satisfactory.

CULTURE OF THE CAULIFLOWER.

THE Cauliflower, with the Broccoli, are said to have been introduced into England and the Continent of Europe from Cyprus, where it has been cultivated for centuries, and also from the coasts of the Mediterranean. Unprotected the Cauliflower would rarely withstand the severity of our winters, except, perhaps, in the favoured climates of Cornwall and South Devon. Like all the Brassica family, many excellent varieties of the Cauliflower have been introduced into commerce in recent years by the great seedsmen of this country, France, and Germany. Those finding most favour in this country are Veitch's Extra Early, Sutton's First Crop, Early London, Carter's Extra Early Autumn Giant, Walcheren, and Veitch's Autumn Giant, the last named being the hardiest as well as the latest of all Cauliflowers. Plants raised from seeds sown at the same time as the five previously mentioned varieties make a good succession to the Walcheren. The heads are large, firm, compact, and white, and well protected by the overlapping leaves from injury by frost.

SOIL.—A deep sandy loam, enriched with well decomposed stable manure, trenched into it at least two spades deep, will be congenial to the requirements of the Cauliflower, and tend to the production of the best possible results under judicious treatment and the influence of genial weather. This will allow of the bottom spit, if good, being turned up to the action of the weather, thereby subjecting substances in the soil, previously inert, to a fresh decomposing action, and rendering them available for the food of the plants. In the process of trenching the manure should be well mixed with the soil, and should not be nearer to the surface than 9 inches. Early and late plantings must be made in well-drained ground; for the general planting it does not matter if it is but imperfectly drained—that is, not drained at all, as in that case the plants will stand a better chance of being uniformly damp at the roots during the summer and early autumn months, and, therefore, less liable to have their growth checked, which would result in the production of precocious and imperfectly formed heads.

SOWING.—Seeds of Extra Early and First Crop should be sown in a gentle heat under glass towards the end of January or early in February, and out of doors at the foot of a south wall or fence as early in the latter month as the condition of the soil and weather will permit its being done. A pinch of seed of the varieties named above should be sown at the same time to yield a succession of Cauliflowers up to the autumn-raised plants, the end of June and throughout the months of July, August, and September, when the supply will be continued by plants of Early London, Extra Early Autumn Giant, Walcheren, and Veitch's Autumn Giant, raised from seed sown in April. The last sowing will produce heads the following May and June, being made from the 20th to 25th of August in the south and west of England and Ireland; and from ten to fifteen days earlier in the northern parts of these islands. Sow the seed in beds about 4 feet wide, with a foot alley between, these being divided and subdivided according to circumstances, and covered lightly with pulverised soil from the alley, raked level, and then covered with a piece of small-meshed garden netting, supported by short forked sticks, as a protection from the birds. As soon as the young plants are a couple of inches high they must be pricked out in a suitable situation in rows 6 inches apart, and at the same distance in the rows, setting the plants down to the bottom leaves in the soil and rendering the soil moderately firm about the roots; giving water (in the absence of rain at the time) to settle the soil. As soon as these plants have become well established they should be finally transplanted with balls in drills 3 inches deep, 2 feet apart, and at the same distance from plant to plant in the row. A space of 6 inches less every way will be ample for Extra Early and First Crop, these being compact, dwarf-growing varieties. The only difference in the pricking out the young plants resulting from the August sowing, is that they must be placed underneath handlights, or in cold pits or frames having a sunny aspect, instead of in the open. If the soil in which the plants are set during the summer should be of stiff nature, the application of water at the roots, except to settle the soil about them when planted, will not be necessary; but, on the other hand, if it is light, frequent applications of water at the roots will be necessary should the summer be a hot and dry one. As soon as the plants have taken well to the soil they may have a little of the latter drawn up to them on either side.

AUTUMN AND WINTER TREATMENT OF AUGUST-RAISED PLANTS.—The plants in handlights, pits, and frames should be protected from frost by lights and shutters, and fern or litter in case of severe frost. They must, however, have abundance of air given them on every favourable opportunity, removing the lights and shutters in the morning in the absence of frost or snow, and replacing them in the evening whenever frost is anticipated. A dusting of lime and soot mixed can be occasionally made between the ends and sides of the frames and pits and the plants to prevent the inroads of slugs among the plants during the winter. A little wood ashes and soot should be strewn over the soil before pricking out the young plants in it. This will protect their roots from the attacks of insects.

TRANSPLANTING CAULIFLOWERS IN SPRING.—As early in February as the weather will permit lift the plants with a garden trowel, with little balls of earth attached to the roots, and transplant them carefully into drills in the manner described above. This done stick a Spruce bough or Laurel branch well into the ground at the north side of the individual plants for a few weeks. These will save them from injury by frosts and cutting winds until the roots of the plants have

pushed into the fresh soil, when they may be removed. Another planting should be made early in March, treating the plants as indicated. Where branches and boughs of the description mentioned are not at command it will be advisable to defer the first planting for a few weeks. In the north of England and Scotland it will not be safe to put the plants out before the second and third week in March.

TAKING AND RETARDING THE CROP.—The heads of Cauliflowers may be cut when they are about 3 to 4 inches in diameter, and from that till they attain their full size, but before they lose their compactness. The heads should never, except in special cases, be cut before they have reached these dimensions. The "flower" should not be exposed to sunlight, as that would spoil its whiteness. When the heads are turning in too quickly three or four of the leaves can be bent over them as a means of keeping them back. The operation may also be had recourse to when frost is anticipated in autumn and early winter. This will save the heads from being injured by a few degrees of frost. If the breadths of plants are looked over when frost is anticipated, and all developed heads cut with a few inches of stalk attached, and are then stood on the ends closely together on the floor of a shed or cool house out of the reach of frost or damp, they will keep good for a fortnight or three weeks from the time of cutting. —H. W. WARD.



HARDY FRUIT GARDEN.

GRAFTING.—Attend to this as soon as the sap has risen sufficiently to cause the wood buds to commence unfolding, and the bark to leave the wood freely. Enough moisture must be forthcoming at once to prevent the scions drying, and in order to make this point more secure the growth of the stock must be in advance of the scions. The latter are, therefore, usually taken off several weeks before growth commences, and laid in where they are cool and moist; the stocks are also roughly headed back about the same time. It is not advisable to graft trees that are not vigorous and healthy; grafting will not remedy this, and it is better to grub them out and plant others in another place; but strong healthy Apple or Pear trees of poor varieties may be grafted with good varieties, and will quickly make large bearing trees again if well attended to. It is not usual to graft large trees of stone fruits, such as Plums or Cherries; they do not heal their wounds so readily as Apples or Pears, and are liable to death from "gumming" and other causes if cut hard back; they are, therefore, usually propagated by budding in the summer season.

VARIOUS METHODS.—For large standard trees and those the branches of which when cut back exceed half an inch in diameter, the plan known as "rind grafting" is the simplest and surest mode. The stocks having been sawn off as previously advised, they will only require cutting back about an inch farther so as to secure perfectly fresh wood to work on. Sawing must be carefully done that the branches may not be split or the bark injured, and all cuts should afterwards be pared smoothly with a knife. The next thing is to slit the bark from 2 to 3 inches down the branch, commencing at the top where it was sawn off, it is then slightly raised on each side of the slit by the handle of a budding knife or a grafting bone. All is now ready for the scion, which must be about 6 inches long, and cut with a flat face at the lower end of the same length as the slit in the stock, but not deep enough to expose the pith. This has now to be inserted in the stock, pushing it gently downwards from the top underneath the bark, care being taken that no soil adheres to it when it is inserted under the bark of the stock. When the branches are 2 inches or more in diameter two or three scions are generally inserted in each, and in large standard trees from twelve to twenty branches may be worked, giving those the preference near the crown of the tree, and inserting the grafts with an upward tendency, or much trouble will be needed afterwards to induce them to grow upright. As soon as the scions are on each branch another person should bind them in firmly with raffia or some similar material, and cover with clay or grafting wax to keep out the air until the inner bark of the stock and scion are securely united. If clay is used it cannot be too adhesive, and must be well worked over with a spade, mixing in a quantity of soft hay cut into chaff and some horse manure, in order to prevent it cracking. When the clay is not very good cow manure may also be added, but we never use it, as our clay is naturally soft and greasy. Prepare sufficient of this mixture before the work is commenced, and enough ought to be placed on to completely exclude the air from the wounded parts and keep them moist, at the same time it must be borne in mind that two buds at least of the scion must be left outside the clay.

Have a pail of water at hand when applying the clay in order to leave a clean smooth surface when finished, and in places much exposed to dry cutting winds it is a good plan to tie a handful of damp moss over the clay and to damp it occasionally. Some use grafting wax—a composition of pitch, beeswax, tallow, &c.—instead of clay. We have found the French cold grafting wax, known as "Mastic L'homme Lefort," to be capital where only a few grafts have to be covered, as it

can be used without heating, and is easily applied; but in exposed places cover with damp moss to prevent the wounds drying too much before a union takes place. For smaller stocks where the stock and scion are nearly equal in size either saddle or whip grafting is a better system than the above. In saddle grafting the stock is cut wedge shaped, and the scion cut to fit it as nearly as possible—in short, the scion sits on the stock as a man would on a saddle. It is then tied and clayed or waxed over, as in rind grafting. In whip grafting the stock is cut off, sloping at the top as in pruning; a slice is then taken off the side from 1 to 2 inches in length, removing just enough bark to make a flat surface, but not cutting into the pith; then insert the knife across this smooth surface near the lower edge of the cut where the remainder of the stock was taken off, giving the knife a downward direction, cutting about half way through, and opening the crack a little before the knife is drawn out. Cut the scion with a smooth face in the same way, and a tongue to fit into the transverse cut on the face of the stock, and the whole is then to be bound together and clayed over as in the other methods.

Whichever plan is employed bear three things in mind. First, the sap of the stock must be flowing freely, and the scion employed must be in a more dormant state. Secondly, the inner bark of the stock and scion must touch each other at least on one side. Thirdly, air must be excluded from the wounds, and they must be kept from drying influences. Success is then almost a certainty.

After Treatment.—Some of the smaller branches may be left on the trees to draw up the sap until the grafts are growing freely, when they can gradually be reduced in number, and eventually cleared off altogether. If very dry weather comes on the clay will require dressing by rubbing a little water on to it to stop the cracks and prevent air from penetrating. If much difficulty is experienced in this way it is well to tie a band of moss over the clay and damp it occasionally.

MORELLO CHERRIES.—Pruning and nailing these should now be finished as soon as possible. In many instances the trees will be much too thick, and require a good thinning. Bear in mind that this fruit bears on the wood of the previous year's growth, and enough of this must be left to ensure a good crop, taking out all weak branches and old wood that can be spared, always leaving plenty of young wood near the centre of the trees.

BARRENNESS.—In some soils where lime is almost absent the Cherry drops its fruit at stoning time, and fails to perfect a good crop. This is more noticeable with the Bigarreau class than with Morellos, and the latter will sometimes thrive where the former altogether refuse to fruit. In such cases a good supply of lime or old mortar rubbish should be forked into the soil among the roots as soon as nailing is finished; and if 1 lb. fine ground bones can be given to the square yard it will assist them considerably. We have improved matters very much in such cases by removing the top soil as far down as the roots, substituting fresh calcareous loam, which need not be turfy, although this will do no harm if the grass roots are dead.

FIGS.—In cold districts where these have to be protected from frost remove the material, and train the shoots into their proper position. Figs on walls require more room between the young shoots than any other fruit trees. The young growths should never be less than 6 inches apart. Do not shorten any of the shoots unless there is a danger of the tree becoming bare in any part, as the fruit is always borne near the point of last year's growth. All young wood may, therefore, be nailed in at full length if there is room, and bare branches cut back as far as possible. Any small Figs remaining of last year's second crop should be rubbed off, as most of them eventually fall off; and if any remain and ripen they never form such good fruit as those of the current year. Where the climate is warm enough Figs bear best if allowed to extend their shoots, bush-shaped, above the top of the wall, and grow on from year to year. The wood made under full exposure in this manner is shorter jointed and much more fruitful. But this plan is only recommended in extreme cases, as the appearance of it in many places would be altogether against its adoption. We have found that shy variety, Brunswick, fruit freely in this way, when better looking plants have failed. Brown Turkey and White Marseilles are two of the best and most reliable varieties. Brunswick is much larger, and is also of excellent quality in a good warm season.

FRUIT FORCING.

PEACHES AND NECTARINES.—*Earliest Forc'd Trees.*—The trees must not be hurried during the stoning process, but continue the temperature at 70° to 75° by day with sun heat, and about 65° in dull weather, avoiding sudden fluctuations. Tie the shoots to the trellis as they advance, and regulate the growths for future bearing so as not to have them too crowded, as by giving the shoots plenty of room the fruit is better exposed to the sun and air, and the wood for another year is better ripened. Shoots more than 14 inches long that are not extensions may have their points pinched out. When the stoning process is over, which may be ascertained by testing a few fruits with a knife, the fruits will require regulating for the swelling period. Vigorous trees may be allowed to carry a few more than those that are weakly, but on no account unnecessarily tax the trees with more fruit than can be brought to maturity without prejudicing future crops. Supply weakly trees with liquid manure, and inside borders in any case must be kept properly watered, mulching the surface with partially decayed manure. This will secure more uniform moisture, and the fruit will swell to a good size. The temperature may be increased to 65° or 70° at night, and in the day to 70° or 75°, maintaining 85° or 90° through the day by sun heat; ventilate from 75°, and close

early with plenty of atmospheric moisture. The very early varieties Alexander or Waterloo, and Early Beatrice, will soon give indications of ripening, when syringing must cease, and the leaves that shade or overhang the fruit must be drawn aside, and the fruit if necessary raised on laths placed across the wires of the trellis, so that its apex will be placed directly to the light. Syringing must be continued for the other varieties until the fruit is ripening.

Trees Started at the New Year.—The weather has retarded the swelling of the fruits, but as it becomes more genial they progress rapidly, and stoning is commencing. Avoid sudden checks by injudicious ventilation, cold air in the day causing excessive evaporation, and too high a temperature at night are fatal.

Trees Started Early in February.—Although these have not advanced rapidly in swelling, they being a full fortnight later than usual, the bright weather has given firmer texture and better colour to the leaves, the set of fruit being satisfactory, and the swelling progressive. Syringing as soon as the fruit is fairly set on all the trees assists them to shed the remains of the flowers. Heavy syringing must be avoided; an occasional effective and judicious syringing is all that is needed until the foliage attains to nearly its full size in the first leaves. Maintain a night temperature of 55° or 60° in mild weather, ventilating from 65°, permitting an advance from sun heat to 70° or 75°, but with free or full ventilation.

Disbudding.—Attend to this early, but it must be done carefully, commencing as soon as the shoots can be displaced with the finger, and be followed up day by day until only the shoots required for future bearing or the extension of the trees are retained. Leave one shoot at the base of the branches or last year's shoots now fruiting, and another on a level with, or above, the fruit; the latter not being required for extension must be stopped at a few joints of growth. In the case of trees not fully grown it will be necessary to leave shoots about 15 inches distance apart, calculating from the base of last year's growth, to form the bearing shoots of next year, the terminals being trained in their full length as space permits. The leading growths must not be less than 12 to 15 inches apart. Closer training is practised, with the result of weak, overcrowded growths, not nearly so satisfactory in fruit as growths fully exposed to light and air.

Thinning the Fruits.—Directly the fruit is fairly set and the properly fertilised fruits can be detected by their taking the lead in swelling, commence thinning. Remove the smallest first and those on the under or at the back of the trellis, beginning with the weakest parts of the tree, for on the weakest shoots the fruit sets most thickly, thinning proportionately more than on stronger wood, which will tend to the equalisation of the vigour of the tree. The fruit ought not ultimately to be left closer than one to every square foot of trellis covered with growth, but small varieties, and Nectarines, being a smaller fruit, may have one to every 9 inches square (81 square inches) of trellis covered by the trees. The first thinning must commence not later than when the fruit is the size of horse beans, the second when the size of marbles, when very few more should be left than is required for the crop; looking over again when the fruit is the size of walnuts, and very few indeed over the intended crop should then be left, though there must always be a margin for casualties.

Syringing.—Syringe all trees not in flower, but having the leaves advanced in formation, twice a day when the weather is bright, so as to keep them free of red spider. Attend to the afternoon syringing at closing time, so as to have the foliage nearly or quite dry before night. Vigorous trees with sappy growths and large leaves require less syringing than trees with sturdy well-formed growth and stout textured leaves, the strong growth perspiring considerably at night, moisture often hanging on the leaves in the morning whilst the foliage of the adjoining sturdy growing tree is dry. If the trees have water hanging from the points or edges of the leaves in the morning, omit the afternoon syringing, and on dull days damp available surfaces instead of syringing the trees.

Tying-in the Shoots.—When the growths are sufficiently advanced (and before they extend across the wires of the trellis so as to be in danger of breakage in bringing them into the proper position) tie them carefully to the trellis, not bringing the shoots down too sharply; yet it is necessary where symmetrical training is considered, together with an equal distribution of growth and its disposal to air and light, to that every part of the tree may have its due share. In securing the shoots to the trellis take care to leave sufficient space in the ties, for too tight tying and abrasions of the bark are prolific causes of "gumming," and too tight tying otherwise causes an indent which renders the shoot liable to breakage at that point.

Trees Started Early in March.—These are now flowering well, and we ceased syringing when the anthers showed clear of the petals, a genial condition of the atmosphere being secured by damping the paths in the morning and early afternoon. Provide a little ventilation constantly at the top of the house, and lose no opportunity of ventilating freely. The night temperature should be 50° in mild weather, falling 5° to 10° through the night and severe weather, 50° to 55° by day, and 65° from sun heat with a free circulation of air. Aid fertilisation of the blossoms by shaking the trellis, brushing them gently with a soft brush or bunch of feathers, always in the early part of a fine day. Let there be no mistake as to the moisture of the inside border, giving a thorough supply of water when required.

PLANT HOUSES.

Epaerises.—As these cease flowering, cut them down at once and place them where a temperature of 50° can be maintained. Syringe

them twice daily during fine weather to start them into growth, and stand the plants on ashes or other moisture-holding material. After growth is started pot all that need more root room in a compost of good peat and sand. Do not disturb the old ball more than is necessary to remove the drainage. Press the soil firmly into the pots and water carefully afterwards. Keep the plants close for ten days or a fortnight, then ventilate daily to induce stout growths.

Erica hyemalis.—Home-grown plants, or those that flowered early and were cut back at once, have started into growth. If they need more root space repot at once in the same soil advised for *Epacris*. Continue growing them where abundance of air can be admitted, as nothing is gained by forcing them in heat, for they only grow weakly. *Ericas* only recently cut back may be kept close until they commence growing, when air may be gradually admitted and daily increased.

Hardwooded Heaths.—Ventilate the structure in which these are grown as freely as possible, and repot any plants that need more root room. Good peat and sand should form the compost, and care is needed not to bury the collar of the plants. Leave also plenty of room in the pots for water; frequently there is insufficient space, and two or three applications are needed to soak the whole ball thoroughly. Drain the pots carefully. Young stock that it is necessary to grow on as quickly as possible may have the flower buds removed directly they show. This saves time, and the plants soon start into growth. Plants of *E. Cavendishiana* have an upward tendency; the points of these may be removed or the shoots that are taking the lead drawn, if possible, towards the rim of the pots. Complete the tying of specimen plants, and use no more stakes than are absolutely necessary. Any plants necessary to be retarded for late flowering may now be removed to a cool airy structure, where frost can be excluded, with a northern aspect. Syringe freely amongst newly potted plants, and protect them until established in the new soil from bright sunshine by shading them lightly for a few hours. Maintain a fair supply of moisture in the house during bright sunshine and drying winds; it is better to allow the temperature to rise considerably than unduly dry the plants.

Solanums.—Remove the points from seedlings as they advance, and pot them if they need more root room. The same may be said of those rooted in the autumn. Old plants that were cut back some time ago and have broken into growth may be turned out of their pots, the roots reduced and placed in a smaller size. Pot these in a compost of fibry loam, one-seventh of manure and sand. Keep the plants for the present in a temperature of 50°.

Lilium eximium.—Place this *Lilium* in a perfectly cool house where frost only can be excluded, and if stood on a bed of ashes and ventilated liberally strong growths will be made. This is one of the finest *Liliums* that can be grown in 4 and 5-inch pots. When about 6 inches high apply a little artificial manure to the surface of the soil. Watch for aphides, and destroy them directly they appear. *Lilium Harrisii* that has flowered may have the flower stems shortened a little and hardened in a cool house until May, when they may be stood outside, and if watered will flower again in the autumn.

Scabious.—Plants that have been wintered in cold frames in small pots may now be placed into 6-inch, give air freely when the weather is fine, they soon draw up weakly if kept close. Have a central stake to each plant, and in due course they will yield abundance of flowers for cutting.

THE BEE-KEEPER.

APIARIAN NOTES.

IS POLLEN NECESSARY FOR COMB-BUILDING?

SOME authors assert that bees cannot secrete wax without the aid of pollen. At the end of November, 1890, I undertook the charge of a few bees, not more in bulk than my two hands, which had to be resuscitated with warm syrup, so nearly dead were they. I placed a feeder over them filled with syrup, but several days passed before the bees could secrete wax and have comb built for storage. By-and-by, as a little comb was built, the syrup disappeared, but no pollen was carried in. I managed by careful feeding to supply them with about 20 lbs. of sugar by the middle of December. The bees have survived, are strong, and have still between 8 and 10 lbs. of syrup in the combs, which, if melted, would produce three-quarters of a pound of wax. There were a few eggs in the combs on the 13th of January, and a few pellets of pollen were carried in on the 15th, and on the 12th of March I saw a few young bees on the wing, cold as the air was, but under a bright sunshine. I have other similar cases, but the one mentioned is in no way different, and need not occupy space in explanation. There is no nitrogen in wax, but an excess of hydrogen compared with honey, and is probably extracted from the water contained in the syrup, or from what the bees carry in when secreting comb—a

process not fully understood yet, but in which I believe the acid contained in the sac connected with the sting plays an important part. As time rolls on and science progresses errors will disappear, and their authors will be ashamed to own them.

HONEY PRESSER.

In a village where the Lanarkshire honey presser was invented a coterie of bee-keepers met, some who knew me and some not, who had read the false statement concerning its invention. Amongst those met was an old bee-keeper nearly a hundred years old, who said he remembered seeing the first presser of this nature in the possession of the inventor about fifty years ago. A deputation waited upon me on the 11th of March to hear from me the facts of the case; being undeceived they went away rejoicing. On the same day a bee-keeper from the East of Scotland visited me, who saw my presser ten years ago, made one from it, but having the screw horizontal, and it is believed that it was from this one that Raitt copied the horizontal screw, but I have no proof further than his instructions were copied from mine.

THE WEATHER.

On the 7th March a second fall of fully 2 inches snow fell, which had not all disappeared on the 13th. The cold was intense and the flowers that February brought forth are destroyed. The temperature on the mornings of the 8th, 9th, 10th, 11th, 12th, and 13th was 18°, 8°, 10°, 14°, 14°, and 10° respectively, and on only two days has the day temperature been above 32°. However sudden the cold came on and intense it has been, bees seem nothing the worse, proving the value of keeping them at one uniform temperature, and under protection of material which change of temperature affects but little, if any; and the narrow entrance I allow prevents an undue pressure of cold air amongst the bees, and the ventilating floor performs the other necessary work effectually.

I am glad to learn that "A Hallamshire Bee-keeper" is still to the fore, and beg to ask if he is aware if any bees that had the vinegar and cream of tartar in honey escaped abdominal distension?—A LANARKSHIRE BEE-KEEPER.

TRADE CATALOGUES RECEIVED.

James Veitch & Sons, 544, King's Road, Chelsea.—*Catalogue of Herbaceous Plants and Hardy Florists' Flowers.*

J. Sallier, Fils, Neuilly-sur-Seine.—*Catalogue of Plants.*

W. Clibran & Son, Oldfield Nursery, Altrincham.—*General Catalogue of Stove, Greenhouse, and other Plants.*

Vilmorin-Andrieux et Cie., 4, Quai de la Mégisserie, Paris.—*Catalogue of Tree and Shrub Seeds.*



TO CORRESPONDENTS

•• All correspondence should be directed either to "THE EDITOR" or to "THE PUBLISHER." Letters addressed to Dr. Hogg or members of the staff often remain unopened unavoidably. We request that no one will write privately to any of our correspondents, as doing so subjects them to unjustifiable trouble and expense.

Correspondents should not mix up on the same sheet questions relating to Gardening and those on Bee subjects, and should never send more than two or three questions at once. All articles intended for insertion should be written on one side of the paper only. We cannot reply to questions through the post, and we do not undertake to return rejected communications.

Unsatisfactory Peach Trees—Ants (*J. H. K. and Amateur*).—Your letters arrived a post too late for being answered this week.

Primulas (*B. S. Williams & Co.*).—The flowers having been placed in a dry box, and remained in the post a day or two, arrived curled up and withered. They were practically dead, but the richness of the colours was even then apparent, which shows that they are "fixed."

Valeriana Phu aurea (*B. M.*).—You have been rightly informed. This plant is quite hardy, and produces yellow leaves and stems in

spring, which change to green in the course of a month or two. It is effective at this period of the year, and is well worth growing where it colours well. You will find it referred to in a note on another page. It used to be, and perhaps is now, extensively grown for beds and borders at Lambton Castle.

Spraying—Peaches (S. J. A.).—There is something in what you say; but as a suitable mixture cannot be distributed so strong as to be injurious when first used, undue weakening can be prevented by timely replenishments. We think the appliance you name will answer your purpose very well. If you refer to the article on Mr. Burton's Peach houses at Bexley—it can be had by your sending 3½d. to the publisher with a request that he send you the number of July 17th, 1890. If you obtain the number and it is not what you want, we will see if we can give you another reference, if you can furnish us with a "clue" to guide us in the search.

Plants for Corridor Roof (W. J. B.).—We have never been able to know what is meant by a "few" sorts, and as you neither state the height nor length of the corridor you have to furnish, all we can do is to name such plants as we have seen occupying the upper parts of corridors satisfactorily, from which frost is excluded. They are not all strictly evergreen, and if you exclude all which cast some of their leaves in winter, you will be deprived of some of the most beautiful and appropriate plants for the purpose in question. *Lapageria rosea* and *alba*, *Clematis indivisa*, *Tacsonias exoniensis* Von Volxemi and *insignis*, *Passifloras Impératrice Eugénie*, *cœrulea racemosa*, and *Constance Elliott*; *Lonicera sempervirens*, *Solanum jasminoides*, *Rhodochiton volubile*, and *Jasminum grandiflorum*. For training up pillars and furnishing the roofs of such structures as are suitable for them, *Habrothamnus fasciculatus*, *coccinea*, and *aurantiacus*. Also *Plumbago capensis*, *Abutilons*, and free growing *Fuchsias* are grown, the latter, as may be seen at Chatsworth, Kew, and other places, being very beautiful thus displayed. We should also plant *Maréchal Niel* and other climbing *Roses* if there is room for them.

Apple Reinette Grise (H. L.).—Several varieties of Apples have lately been sent from France into the London markets under the name of *Reinette*. The above, however, is the name of the one which you have purchased, and it is thus described in the "Fruit Manual":—"Fruit, medium sized, 2½ inches broad and 2½ inches high; roundish ovate, broadest at the base, and generally with five obscure angles on the sides, forming more or less prominent ridges round the crown. Skin, dull yellowish green in the shade, and with a patch of thin, dull, brownish red on the side next the sun, which is so entirely covered with brown russet that little colour is visible; the shaded side is marked with large linear patches of rough brown russet. Eye, closed, with broad, flat, sharp-pointed segments, which are reflexed at the tips, and set in a deep and round basin. Stamens, median; tube-funnel-shaped. Stalk, half an inch long, set in a deep and angular cavity. Flesh, yellow, firm, crisp, juicy, rich, and sweet, with a brisk and excellent flavour. Cells, obovate; axile. A very fine dessert Apple of first-rate quality; in use from November to May. The tree is a healthy and vigorous grower, and an excellent bearer. One of the finest old French Apples; but considered inferior to the *Reinette Franche*."

Primula sikkimensis (J. B.).—The note to which you refer appeared about five years ago, and the following is the substance:—Of all the Himalayan Primroses yet introduced to English gardens there are none to our thinking that exceed or perhaps even equal the present species when properly managed; for even this Primrose has its peculiarities, which must be suited as far as possible to the means at hand. A very prevalent belief amongst hardy plant growers is that many of this class of Primrose are either annual or biennial, or, at least, are best treated as such; and, so far as our experience goes with *capitata*, *elliptica*, *Stuartii*, &c., it is the only means of procuring an unfailling crop of flowers annually. The plants rarely flower before the second year, and to keep up a supply it is necessary to make an annual sowing, so that the seedlings of this year will be depended on for the supply of flowers next year, and so on. *P. sikkimensis* ripens seed freely in our climate, and these sown when gathered soon germinate, and may be pricked out in boxes or rich beds in a shady situation and well watered through the summer months. In autumn, when the leaves have died down, they can be shifted to their flowering quarters, lifting a good ball of soil with each plant. The bed in which they are to flower should be deep, rich peaty, and well shaded, and the result will abundantly repay all the trouble taken with the seedlings. The flowers being extremely handsome, emitting a delicious fragrance, which always succeeds in attracting one to them. The leaves all proceed from the root, from 8 inches to a foot long, obovate and oblong, and without meal on either side; nerves reticulated, prominent on the under side, dark green above, doubly and sharply serrated margins. The flower stem grows about a foot high, carrying an umbel of from ten to twenty or more large sulphury yellow sweetly scented flowers; involucre of from five to seven narrow sessile leaflets, half the length of the pedicels. "It inhabits wet boggy places at elevations of from 12,000 to 17,000 feet elevation at Lachen and Lachong," covering acres with a yellow carpet in May and June. It was first introduced by Sir J. D. Hooker about 1850. It flowers with us May and June, but may be forced earlier, and makes an excellent pot plant. It is perennial, but the best flowers are produced the second year after sowing.

Names of Plants.—We only undertake to name species of plants not varieties that have originated from seed and termed florists' flowers. Flowering specimens are necessary of flowering plants, and Fern fronds should bear spores. Specimens should arrive in a fresh state in firm boxes.

Slightly damp moss, soft green grass or leaves form the best packing, dry wool the worst. Not more than six specimens can be named at once, and the numbers should be visible without untying the ligatures, it being often difficult to separate them when the paper is damp. (*A Constant Subscriber*).—The white *Camellia* is apparently a single form of *C. japonica* of no special merit; the pink scellling is an improvement. (*J. S.*)—1, *Chionodoxa Luciliae*; 2, *Scilla siberica*; 3, *Choisya ternata*. (*M. N.*)—1, *Dendrobium litiuiliflorum*; 2, *Dendrobium Fimbleyanum*; 3, *Cypripedium hirsutissimum*; 4, *Odontoglossum Sanderianum*. (*J. U.*)—The specimen appears to be a small branchlet of *Acacia cultriformis*, and it would succeed very well in the position you describe. No "apology" is needed on the part of a thirty-four-years subscriber for making inquiry of any kind, and giving a reply is no "trouble" to us. (*W. C.*)—1, *Acacia armata*; 2, *Lonicera sempervirens*; 3, *Chionodoxa Luciliae*; 2, *Daphne mezereum*.

COVENT GARDEN MARKET.—APRIL 1ST.

BUSINESS very dull, and market well supplied with all classes of hothouse goods.

FRUIT.

	s.	d.	s.	d.		s.	d.	s.	d.
Apples, ½ sieve	1	6	to	6	Lemons, case	15	0	to	20
" Nova Scotia and					Melons, each	0	0		0
" Canada, per barrel	15	0		26	Oranges, per 100 ..	4	0		9
Grapes, per lb.	2	0		4	St. Michael Pines, each..	3	0		8
Kentish Cobs	40	0		45	Strawberries, per lb. ..	6	0		12

VEGETABLES.

	s.	d.	s.	d.		s.	d.	s.	d.
Artichokes, dozen	0	0	to	0	Mushrooms, punnet ..	1	6	to	2
Beans, Kidney, per lb. ..	2	3		2	Mustard & Cress, punnet	0	2		0
Beet, Red, dozen	1	0		0	Onions, bushel	3	0		4
Brussels Sprouts, ½ sieve	3	0		4	Parsley, dozen bunches	2	0		8
Cabbage, dozen	3	0		0	Parsnips, dozen	1	0		0
Carrots, bunch	0	4		0	Potatoes, per cwt. ..	3	0		4
Cauliflowers, dozen ..	3	0		6	Rhubarb, bundle	0	2		0
Celery, bundle	1	0		1	Salsafy, bundle	1	0		1
Coleworts, doz. bunches	2	0		4	Scorzonera, bundle ..	1	6		0
Cucumbers, doz.	4	0		8	Seakale, per bkt. ..	2	0		2
Endive, dozen	1	0		0	Shallots, per lb. ..	0	3		0
Herbs, bunch	0	2		0	Spinaach, bushel ..	5	0		6
Leeks, bunch	0	2		0	Tomatoes, per lb. ..	0	0		0
Lettuce, dozen	3	0		3	Turnips, bunch	0	0		0

AVERAGE WHOLESALE PRICES.

CUT FLOWERS.

	s.	d.	s.	d.		s.	d.	s.	d.
Arum Lilies, 12 blooms ..	3	0	to	6	Mimosa (French), per				
Azalea doz. sprays	0	6		0	bunch	1	0	to	1
Bouvardias, bunch	1	0		1	Narciss (Paper-white),				
Camellia, white, per doz.	2	0		4	French, doz. bunches ..	4	0		6
" red	1	0		1	Do. Do. English,				
Carnations, 12 blooms ..	1	0		2	per bunch	0	9		1
Christmas Roses, dozen	0	0		0	Narciss (Various) dozen				
blooms	0	0		0	bunches, French ..	2	0		4
Cineraria, 12 bunches ..	6	0		9	Pelargoniums, 12 trusses	0	9		1
Cyclamen, doz. blooms ..	0	3		0	" scarlet, 12 bnchs	6	0		9
Daffodils, doz. bunches ..	2	0		6	Poinsettia, dozen	0	0		0
Eucharis, dozen	3	0		6	Primula (double) 12 sprays	0	6		1
Gardenias, per doz. ..	3	0		6	Primroses, dozen bunches	0	9		1
Hyacinths (Roman), doz.	0	6		1	Roses (indoor), dozen ..	0	6		1
sprays	0	6		1	" Red (English) per				
Hyacinth, Roman (French)	3	0		6	dozen blooms ..	4	0		6
doz. bunches	3	0		6	" Red, 12 bls. (Frch.)	2	0		4
Lapageria, 12 blooms ..	2	0		4	" Tea, white, dozen ..	1	0		3
Lilac (French) per bunch	4	0		6	" Yellow, dozen ..	3	0		6
Lilium longiflorum, 12	4	0		6	Snowdrops, doz. bunches	1	0		3
blooms	4	0		6	Spiraea, per bunch ..	0	6		0
Lily of the Valley, dozen	0	6		1	Tuberose, 12 blooms ..	1	6		2
sprays	0	6		1	Tulips, per dozen	0	9		1
Maidenhair Fern, dozen	4	0		9	Violets (Pamel), per bch.	2	6		4
bunches	4	0		9	" (dark), per bch. ..	1	6		3
Marguerites, 12 bunches	4	0		8	" (English), doz. bch	1	0		2
Mignonette, 12 bunches ..	3	0		6	Wallflower, doz. bunches	1	6		2

PLANTS IN POTS.

	s.	d.	s.	d.		s.	d.	s.	d.
Aralia Sieboldi, dozen ..	6	0	to	18	Foliage plants, var., each	2	0	to	10
Arbor Vitæ (golden) doz.	6	0		8	Genista, per doz.	8	0		12
Azalea, per plant	2	0		3	Hyacinths, doz. pots ..	6	0		9
Cineraria, per doz.	6	0		9	Lily of the Valley, per pot	1	0		2
Cyclamen, per doz.	9	0		24	Marguerite Daisy, dozen	8	0		12
Dielytra spectabilis, per					Mignonette, per dozen ..	6	0		9
dozen	8	0		12	Myrtles, dozen	6	0		12
Dracæna terminalis, doz.	24	0		42	Palms, in var., each ..	2	6		21
" viridis, dozen	12	0		24	Pelargoniums, per doz. ..	0	0		0
Erica, various, dozen ..	12	0		18	Poinsettia, per doz. ..	0	0		0
Enonymus, var., dozen ..	6	0		18	Primula siceusis, per doz.	4	0		6
Evergreen, in var., do en	6	0		24	Solanums, per doz. ..	9	0		12
Ferns, in variety, dozen ..	4	0		18	Spiraea, per doz.	8	0		12
Ficus elastica, each ..	1	6		7	Tulips, dozen pots	6	0		8

Bedding plants (in variety) in boxes, from 1s. to 3s.



THE LAMBING SEASON.

SHELTER.

THAT there is a heavy loss of lambs just now on many farms we are convinced, and we know also that most of the losses are

caused either by exposure or improper food, or both. Our readers were warned a few weeks ago against using rotten Turnips for ewes and lambs. When we did so the thought occurred that the warning was almost superfluous, because every sensible farmer must be aware of the risk of serious injury to the flock from such food. But we have now proof that the warning was not uncalled for in the numerous reports that have reached us of losses from this very cause. Strange indeed is the crass ignorance that brings the flock into such jeopardy, or which persists in the exposure of lambs only a few hours old to cold cutting winds, and snow and hail. A worthy farmer well known to us has been losing several lambs daily for the last three weeks chiefly from exposure, and yet he appears unable to see the necessity for a special provision of shelter for them. He says it is bad luck, and actually hints at the prevalence of some mysterious disease among his lambs. Well might he be asked what has luck to do with it?

Pleasant indeed is it to visit a flock that is under really intelligent and skilful management, for there we at once find how much importance is attached to shelter. If the flock is a large one there is probably a lambing yard with an open shed running right round it, not a costly building at all, but just a roof projecting from the wall or closely boarded fence, high enough for the shepherd to walk under to attend to the sheep, and only wide enough for partitions to be made of single thatched hurdles, set securely in the ground just as they would be in a fold, and with thatched hurdles in front. In this simple and inexpensive manner cribs are contrived sufficiently large to contain one ewe and its lamb at first. They are only confined to the crib till the lambs are seen to be healthy and strong, are suckled well by the ewe, and the ewe is settled nicely to its lambs, eats freely, and has recovered from any straining or protracted labour. They are then turned into the yard to make way for other ewes about to lamb, or which have just lambed. It is obvious that by this method every ewe is under close supervision; so, too, are the lambs, and if any special treatment is required it is done quietly and effectually.

If the ewe has had much straining and labour in delivery, it is carefully washed with warm water, and is syringed gently once or twice with carbolic oil. If the udder is hard, and the lamb is unable to draw down its milk, the udder is rubbed with equal parts of olive oil and spirits of nitre, which soon softens it, and then it is milked sufficiently to relieve it before putting the lamb to it again. Occasionally the ewe will not suckle its lamb, and will butt it upon every attempt of the lamb to suck. It then has to be fastened securely by the head, and made to take its lamb, and it usually becomes quiet after a day or two. Cases of protracted labour are much assisted by administering ergot of rye, but we very seldom have recourse to it.

The cribs afford complete shelter, and as ewes and lambs leave the cribs they are still sheltered in the yard from cold wind, only leaving it when "winds blow soft and fair," and we may add in a general way that the lambs are never exposed to cold and wet during the first month. Where there is no lambing yard it is not difficult to provide a snug enough fold with cribs and two or three sufficiently large enclosures. It matters not how or with what materials this is made, but shelter the lambs must have, and nothing must be left to chance.

Be it understood that we are treating of the management of quite young lambs, but the treatment applies to all of them whether the lambing be late or early. This season, though the weather was so favourable for the early lambs, every possible precaution was taken to afford them shelter, they were able to leave it much sooner than usual owing to the exceptional dryness of the weather in February, and were such sturdy animals when a month old that not one has been lost from the colder March weather. Writing about the great snowstorm which began on March 9th, Professor Wrightson says the famous Downton College flock was folded on a large round hill 56 acres in extent,

entirely exposed to the tempest, and both sheep and lambs bore it wonderfully well. But it may be taken as certain that the ewes and lambs were in the very pink of condition, and they were early lambs too, so well nourished as to bear with impunity an amount of exposure that would have been fatal to younger or weaker animals. Every farmer should time his lambing in accordance with his prospective provision of feed. In Suffolk we began in January, in the Midlands it is usually two months later; but though the solar heat is then becoming more powerful daily the nights continue cold, the weather is frequently stormy, and a few hours' exposure to cold and wet is fatal to quite young lambs. The food question must be held over for our next paper.

WORK ON THE HOME FARM.

"The roots are very extensively injured, the hay is of poor quality, and any early growth of grass or artificial 'keep' is now out of the question; the water meadows are also unusually bare for the middle of March. It may not perhaps be far wrong to say that it will cost the farmers an additional 10s. a head to keep their sale pens to the July fairs, with the untoward prospect of their not realising so much as last year by another 10s. a head; mutton being now quoted at about 1s. per 8 lbs. less than last spring." Thus writes a worthy Hants farmer, knocking off £1 per head in the prospective value of lambs with a stroke of his pen, without having regard to the fact of the low price of mutton just now arising from a crowded market. Feed is scarce generally, hoggets are consequently being sold before they are ready; the inevitable reaction will come, and lambs may very safely be held for a rising and not a falling market.

It is quite true that very much of last season's hay is of poor quality, in lamentable contrast to the excellence of silage. We were watching some store beasts being foddered with silage out on a Leicestershire pasture recently, and we were pleased at the eager manner in which it was eaten. It was carted out to them from a silo, and was very dark in colour, but the flavour was excellent. It is the only example of silage in its locality, and has attracted some attention, but the silo has been an obstacle there to any extension of ensilage. Glad were we to explain to some inquirers the process of stack ensilage, its certainty and economy.

As usual the grass land intended for hay and silage had its dressing of chemical manure at the end of February, but so little rain followed that the spreader was attached to the water-cart, and sewage applied through it sufficiently to dissolve and wash in the chemical manure. The sewage was very much diluted, but the effect of this watering is now visible in the growth and colour of the herbage. Yes, growth positively; and we can assure our readers that the bare brown pastures which now meet the eye are more justly attributable to poverty of soil than drought or cold. It is true enough the season is backward, but it is also true that pasture generally is not cultivated in anything like the true sense of the term. On really fertile pasture there is already a nice bite for the lambs; on neglected pasture there is nothing worthy of being termed feed. Every home farmer should be able just now to show the tenant farmers some rich pasture full of growth, and then pasture cultivation would soon become general.

METEOROLOGICAL OBSERVATIONS.

CAMDEN SQUARE, LONDON.

Lat. 51° 32' 40" N.; Long. 0° 8' 0" W.; Altitude, 111 feet.

DATE.	9 A.M.					IN THE DAY.				Rain	
	Barometer at 29.5 and Sea Level.	Hygrometer.		Direction of Wind.	Temp. of soil at 1 foot.	Shade Temperature.		Radiation Temperature.			
		Dry.	Wet.			Max.	Min.	In sun.	On grass.		
1891. March.	Inches.	deg.	deg.		deg.	deg.	deg.	deg.	deg.	In.	
Sunday	22	30.045	35.6	33.4	N.W.	33.2	45.3	25.2	83.2	18.0	0.010
Monday	23	31.690	35.1	32.5	S.E.	37.9	43.4	31.4	64.1	26.9	—
Tuesday	24	29.900	43.1	40.4	S.W.	37.7	51.8	33.1	82.6	26.9	—
Wednesday	25	29.718	40.7	46.0	N.W.	39.0	56.9	43.1	101.1	37.5	0.072
Thursday	26	29.638	42.4	37.6	W.	40.4	49.2	37.6	95.6	32.1	0.049
Friday	27	29.807	39.6	35.3	W.	39.9	45.7	32.3	84.4	26.7	0.040
Saturday	28	29.713	41.0	38.7	N.W.	39.2	51.6	33.8	87.4	23.4	—
		29.845	41.4	37.7		38.9	49.1	34.1	85.5	28.1	0.171

REMARKS.

- 22nd.—Cloudy early, bright day.
 23rd.—Slight snow from early morning till 10.30 A.M., then dull with occasional flakes of snow. Generally bright after 1.30 P.M.
 24th.—Bright till 11.45 A.M., then cloudy, with spots of rain for a couple of hours, and bright again after.
 25th.—Bright mild morning, showery afternoon.
 26th.—Bright mild morning, shower of soft hail at 0.40 P.M., and again with rain and thunder at 2 P.M.; shower at 4 P.M. Bright evening and night.
 27th.—Brilliant early, frequent sprinkles of rain and soft hail after 11 A.M., and a heavy shower of soft hail, whitening the ground between 4 and 5 P.M. Brilliant night.
 28th.—Generally overcast in morning, frequent sunshine in afternoon.

A week with much bright weather, but rather cold winds and frequent showers of rain, snow, and soft hail. Temperature slightly above that of the preceding week, but about 2° below the average.—G. J. SYMONS.

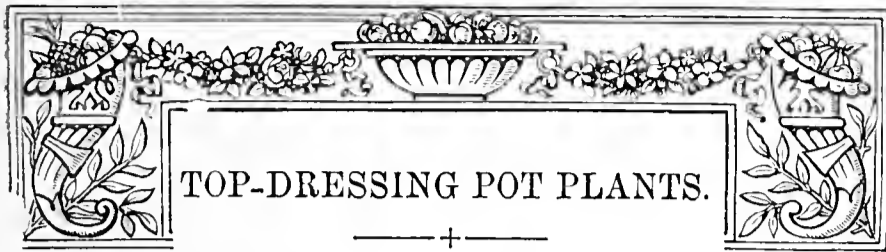

TOP-DRESSING POT PLANTS.

THE time of year has now arrived when the inmates of glass structures should receive a thorough overhauling, and by repotting some and top-dressing others endeavour as far as possible to bring back to health and vigour any plants that have become debilitated, and also to keep in a satisfactory condition throughout the coming season those which are in a thriving state. To accomplish these desirable objects many methods are practised in various gardens. This diversity is accounted for to a great extent by the different objects for which the plants are grown. In one case monster plants are wanted for exhibition purposes, in another large numbers of vigorous plants of suitable sizes for decorative purposes, an essential point being that they must be grown in comparatively small pots, and the primary aim in yet another case is to produce plenty of flowers for cutting purposes. Now I am of opinion that we do not value so highly as we should do repeated top-dressings as a means of producing great results. I do not by any means advocate a practice of top-dressing instead of repotting in the case of plants intended to be grown into large specimens, as there can be but little doubt that to accomplish this in the best way the plants must be repotted as soon as roots are plentiful, but when these plants or others are in pots of as large a size as is desirable they may be kept in perfect health and vigour with far less repotting than is often given them. Nowhere is this better seen than in Covent Garden, where plants remarkable for their vigour and floriferousness are established in relatively small pots.

When turning many kinds of stove and greenhouse plants out of their pots, if the drainage is found in perfect condition and the balls of soil thickly matted, healthy fibrous roots must not be ruthlessly cut away in order to make room for a little fresh soil, or they receive a severe check from which it takes months to recover, and in some cases twelve months after the roots have scarcely pushed into the new soil. If such plants had been left undisturbed beyond the removal of 2 or 3 inches of the surface soil a little sweet and somewhat porous compost being placed on the top, there is at once an incentive for the hungry roots below to permeate the fresh soil on the surface as thickly as they have already done that below, and it would indeed be a phenomenal experience to find good cultivators who were not firmly convinced of the great value of surface roots. Yet in many instances plants are better supplied with roots at the bottom than at the top of the pots. Obviously they do not ramble so freely among the drainage because of the great amount of nourishment to be found there, but rather because the mechanical conditions are more favourable. This I think should teach us that our potting composts need to be made still more porous than they are at present. Make the drainage perfect in the first place, the compost porous by a moderate use of charcoal, broken crocks or old mortar rubbish, the other ingredients being suitable for each particular plant, and roots will rapidly be produced. When the roots are there the plants can by the aid of manures be easily supplied with the elements necessary to keep them in a vigorous and healthy state with much less repotting than is often given.

Take, for instance, the case of *Eucharis grandiflora*. Probably more plants of this popular flower are spoilt through too frequent

potting and the overwatering which generally follows than from all other causes together. Many plants have been totally ruined by mistaken endeavours to improve them. Again, such vigorous and free flowering stove plants as *Allamanda Hendersoni* and *Stephanotis floribunda*, when they cover a large amount of space on the roof of a stove, may, with the aid of rich top-dressings and liberal supplies of liquid manure, be kept in a highly satisfactory state for two or three years without being repotted. This, indeed, is the practice of many successful cultivators.

I remember a fine *Allamanda* in a garden some years ago which covered a greater amount of space than any one specimen of its kind that I have met with since. This to my knowledge was not repotted for two years, but was twice during the growing season surfaced with cowdung mixed with a little soil, and also received two or three times weekly a thorough soaking with liquid manure brought fresh from the stables. With this treatment the plant was far more satisfactory than another *Allamanda* of the same variety planted out in an adjoining compartment of the stove. *Pandanus Veitchi* and the old but still useful *P. variegata*, when they have been grown to a suitable size colour splendidly if left undisturbed. When the pots are crammed with roots and but little soil visible, if a few lumps of turfy loam or peat are pressed in, young roots are quickly emitted and form a network around the fresh soil.

Perhaps there are no plants which are usually required to remain so long in the same sized pots as Palms. They are much used for standing in vases which are comparatively small, considering the size of the plants required to produce a good effect in the positions they are to occupy. It is fortunate, therefore, that these noble plants may be kept for many years in pots that are of a moderate size; but constant attention and high feeding are necessary to retain that deep green colour in the fronds which is so attractive, and so sure an indication of good health. The surface soil should be picked out with a pointed stick once or twice a year, and a little turfy loam and leaf soil or peat pressed firmly on the roots; this should be supplemented by a sprinkling of guano and Clay's fertiliser mixed together in equal portions, and applied at least four times a year. After a time some Palms, by making roots very fast at the bottom, force the plants above the rim of the pot, and consequently make them too high for the vases; in such cases 2 or 3 inches should be cut clean off the base, the plants placed in the same pots again, and have fresh soil given them on the surface. If kept in a close moist house for a time they quickly recover from the effect of this operation and become more attractive than before.

Roses, too, are often potted more frequently than is either necessary or desirable. Pots ranging in size from 6 to 10 inches are the most convenient for forcing purposes, and when once well established in these sizes Roses will not require repotting for three or four years, sometimes longer; but draining and potting must be well done in the first place. In potting plants of any kind that are to remain undisturbed for several years I prefer moss to any other material for placing over the drainage; this is very lasting, and moreover the roots of all plants seem to like it, and quickly fill the moss with healthy feeders, and by the time the moss decays the roots themselves effectually prevent the soil clogging the drainage. Great care must also at all times be exercised to prevent the ingress of worms, or the most perfect drainage is speedily rendered ineffective. When once we have a pot filled with healthy roots, it is not a very difficult matter to supply them with the elements necessary to keep them in health and vigour without constantly disturbing and often destroying their roots to give them fresh food, and I think I am not very wide of the mark in asserting that more plants are rendered weak and unsatisfactory by having too much soil and not enough roots than by the opposite extreme.—D.

DAHLIA ANALYSIS, 1883-1890.

THE Exhibition held by the National Dahlia Society at the Crystal Palace in September last proved a very successful and interesting one, and but for a frost, which did much damage in many parts of the country shortly before the Show, it would no

doubt have been much larger than it was. Notwithstanding this frost, which for the time of year was a remarkably severe one, at only two previous exhibitions has there been staged such a large number of Show Dahlias. The Fancies, considering how few classes are now specially devoted to them in the schedule, were well represented. In those set apart for Pompon, Cactus,

SHOW DAHLIAS.

Position in Present Analysis.	Average Number of Times Shown in the Eight Years.	Number of Times Shown in 1890.	Name.	Date of Introduction.	Raiser's or Introducer's Name.	Colour.
1	42.8	43	Mrs. Gladstone	1884	Hurst	Pa'e blush.
2	27.3	31	Harry Keith	1886	Keynes	Rosy purple.
3	22.0	24	William Rawlings	1881	Rawlings	Crimson purple.
4	20.9	10	James Cocker	1871	Keynes	Purple.
5	20.1	14	Hon. Mrs. P. Wyndham	1881	Keynes	Pale yellow and rose.
6	19.7	20	Henry Walton	1873	Keynes	Pale yellow and scarlet.
7	19.5	26	R. T. Rawlings	1886	Rawlings	Clear yellow.
8	19.0	24	Mrs. W. Slack	1886	Keynes	Blush-white, and purple.
9	18.7	22	Colonist	1887	Keynes	Chocolate and fawn.
10	18.0	18	Maud Fellowes	1889	Fellowes	Pale pink, shaded purple.
11	17.1	14	Goldfinder	1881	Fellowes	Yellow and red.
12	17.0	24	Mrs. Langtry	1885	Keynes	Cream and crimson.
13	16.4	9	Ethel Britton	1880	Keynes	White and purple.
14	16.3	19	J. T. West	1887	Rawlings	Yellow and purple.
15	16.1	15	Mrs. Harris	1873	Harris	White and lilac.
15	16.1	14	Prince of Denmark	1881	Fellowes	Dark maroon.
16	15.8	19	T. J. Saltmarsh	1885	Rawlings	Yellow and chestnut.
17	15.7	20	Willie Garratt	1887	Garratt	Bright cardinal.
18	15.4	14	Prince Bismarck	1879	Fellowes	Puce.
19	14.4	6	Shirley Hibberd	1881	Rawlings	Dark crimson.
20	13.3	13	James Vick	1881	Keynes	Purplish maroon.
21	12.7	8	Joseph Ashby	1879	Turner	Shaded orange.
22	12.1	14	Harrison Weir	1883	Rawlings	Yellow.
23	11.3	6	Flag of Truce	1868	Wheeler	White and lilac.
24	11.2	7	Clara	1879	Rawlings	Rosy peach.
24	11.2	6	Vice-President	1868	Keynes	Orange.
25	10.7	11	Burgundy	1877	Turner	Dark puce.
26	10.3	16	Hope	1883	Keynes	Light rosy lilac.
27	10.1	5	John N. Keynes	1871	Keynes	Yellow.
27	10.1	13	Miss Cannell	1881	Eckford	Cream and crimson.
28	10.0	10	Imperial	1883	Keynes	Purple, shaded lilac.
28	10.0	4	Mrs. Dodds	1881	Keynes	Blush and lilac.
29	9.4	5	George Rawlings	1882	Rawlings	Dark maroon.
30	8.9	5	Mrs. Shirley Hibberd	1877	Rawlings	Cream and pink.
31	8.7	9	Crimson King	1887	Keynes	Deep crimson scarlet.
31	8.7	12	John Standish	1872	Turner	Crimson.
31	8.7	3	Mr. Harris	1881	Rawlings	Crimson scarlet.
31	8.7	7	Mrs. F. Foreman	1884	Keynes	Lilac.
31	8.7	9	Mrs. John Laing	1883	Keynes	French white.
32	8.5	8	Earl of Ravensworth	1883	Harkness	Lilac.
32	8.5	8	Ne'lie Cramond	1888	Keynes	Purple, shaded cerise.
33	8.2	5	John Bennett	1875	Rawlings	Yellow and scarlet.
34	8.0	3	Mrs. G. R. Jefferd	1884	Keynes	Deep yellow.
34	8.0	5	Purple Prince	1888	Turner	Rosy purple.
34	8.0	7	Thomas Hobbs	1886	Keynes	Purplish rose.
35	7.9	4	James Stephen	1882	Keynes	Orange scarlet.
36	7.7	7	John Henshaw	1883	Rawlings	Ruby crimson.
37	7.6	3	John W. Lord	1877	Keynes	Orange buff.
38	7.4	4	Constancy	1878	Harris	Yellow and lake.
39	7.1	7	Royal Queen	1875	Eckford	Cream and crimson.
39	7.1	8	Sunbeam	1881	Fellowes	Buff.
40	6.9	6	Joseph Green	1881	Keynes	Crimson.
41	6.8	3	Champion Rollo	1881	Keynes	Orange.
41	6.8	1	John Wyatt	1877	Keynes	Crimson scarlet.
42	6.7	2	Queen of the Belgians	1887	Rawlings	Cream and pink.
42	6.7	5	Walter H. Williams	1881	Keynes	Bright scarlet.
43	6.5	7	Herbert Turner	1873	Turner	French white.
44	6.3	6	Eclipse	1887	Keynes	Orange scarlet.
44	6.3	5	Mrs. G. Rawlings	1887	Rawlings	Blush and purple.
45	6.2	9	Mrs. Kendal	1885	Rawlings	White and purple.
46	6.0	7	Julia Wyatt	1869	Keynes	Creamy white.
46	6.0	5	Ovid	1874	Turner	Purple.
47	5.8	2	Rev. J. Goodday	1879	Rawlings	Maroon, shaded purple.
48	5.7	4	Mr. Glasscock	1886	Rawlings	Purple.
49	5.4	1	Mrs. Douglas	1885	Rawlings	Scarlet.
50	5.3	3	Bendigo	1887	Turner	Purplish crimson.

and Single Dahlias there were nearly twice as many flowers shown as at the Centenary Exhibition of 1889, the advance being most marked in the case of the Cactus and Single varieties.

The following short statement will show the number of Show and Fancy Dahlias staged in competition at the last eight exhibitions held at the Crystal Palace.

	1883.	1884.	1885.	1886.	1887.	1888.	1889.	1890.
Shows	692	754	837	840	1106	1158	922	934
Fancies ...	269	425	355	387	350	315	274	283
	961	1179	1192	1227	1456	1473	1196	1217

The averages upon which the positions of the different varieties in the two tables depend have been calculated as follows:—For those Dahlias sent out prior to 1883 the average is for the whole eight years, for the 1883 sorts seven years, for those of 1884 six years, for those of 1885 five years, for the 1886 kinds four years, for those of 1887 three years, and for those sent out in 1888 two years. The still newer kinds find places according to the number of times they were staged at the last exhibition only.

Mrs. Gladstone, for the fifth year in succession, holds the premier position on the list of Show Dahlias, and still continues to stand far ahead of all other varieties in this section. At the last four exhibitions it was staged on an average forty-eight times. Taking the same four years the next highest record is that of William Rawlings, with an average of only twenty-eight times. At the last exhibition the following established sorts were particularly well represented:—Mrs. W. Slack, Mrs. Langtry, Hope, Miss Cannell, and John Standish. On the other hand, James Cocker, Hon. Mrs. P. Wyndham, Goldfinder, Ethel Britton, Shirley Hibberd, Vice-President, Joseph Ashby, Flag of Truce, and many other well known kinds, were much less frequently shown than usual.

As many as eight of the Show varieties sent out during the Jubilee year find places in the present analysis. Of these, Colonist stands as high as No. 9 on the list, J. T. West at No. 14, and Willie Garratt at No. 17. The others, however, do not take by any means prominent positions, and have rather lost than gained ground since the last analysis. Crimson King has certainly risen from No. 32 to No. 31; but Queen of the Belgians, on the other hand, has fallen from No. 29 to No. 42, Eclipse from No. 42 to No. 44, Mrs. G. Rawlings from No. 40 to No. 44, and Bendigo from No. 42 to No. 50. Nellie Cramond and Purple Prince, the

sole representatives of 1883, have also lost places. On the other hand, Maud Fellowes, the only 1889 variety on the list, has done splendidly, having been staged no fewer than eighteen times, and rising from the very bottom of the last analysis to No. 10 in the present one.

The changes that have taken place in this section during the last eight years are worth recording, as they will give at all events some idea of the remarkable progress that has been made during this period. Comparing the analysis of 1883 with that for 1890 I find that as many as sixteen varieties out of the forty-nine which appeared in the former fail to find places in the analysis for last year—viz., Alexander Cramond, George Smith, Emily Edwards, Pioneer, Annie Neville, Duke of Connaught, Criterion, Lord Chelmsford, Thomas Godwin, George Dickson, J. B. Service, Artiste, H. W. Ward, Modesty, Revival, and Rosy Morn; while in the present list there are no fewer than thirty-three sorts which are not included at all in the analysis for 1883. Of these need only be mentioned such fine acquisitions as Mrs. Gladstone, Harry Keith, R. T. Rawlings, Mrs. W. Slack, Colonist, Maud Fellowes, and Mrs. Langtry, all of which stand now among the first twelve on the list.

Turning now to the list of Fancy Dahlias, it will be noticed that Mrs. Saunders takes at last a decided lead in this section. Gaiety, its rival of former years, having fallen to the third place in the analysis. Other Fancies unusually well shown last year were Duchess of Albany, Flora Wyatt, Mrs. N. Halls, George Barnes, and Pelican. Of those indifferently represented may be mentioned Gaiety, Chorister, Hugh Austin, Fanny Sturt, John Forbes, and Henry Glasscock.

Although so many Show Dahlias were raised in 1887 there is, strange to say, not a single Fancy variety sent out in that year which obtains a place on the list. Dorothy, distributed in 1888, has not improved on the promising position it took up in the previous analysis, indeed has now fallen to No. 21. Of the two 1889 varieties Fancies Matthew Campbell rises at once to No. 11, while Major Barttlelot will be found at No. 21. T. W. Girdlestone, although only sent out last year, already manages to secure a place in the analysis.

The changes on the list of Fancies since the 1883 analysis appeared are as follows. During the eight years Oracle, Jessie McIntosh, Parrot, Annie Pritchard, and Florence Stark have all disappeared from the list, while Duchess of Albany, Henry

FANCY DAHLIAS.

Position in Present Analysis.	Average Number of Times Shown in the Eight Years.	Number of Times Shown in 1890.	Name.	Date of Introduction.	Raiser's or Introducer's Name.	Colour.
1	18.4	21	Mrs. Saunders	1872	Turner	Yellow and white.
2	15.7	16	Rev. J. B. M. Camm	1873	Keynes	Yellow and red.
3	15.6	7	Gaiety	1879	Keynes	Yellow, red, and white.
4	11.7	9	Chorister	1881	Keynes	Fawn and crimson.
5	11.3	15	Duchess of Albany	1884	Turner	Orange and crimson.
6	10.7	12	Flora Wyatt	1871	Keynes	Orange and red.
7	10.5	6	Henry Eckford	1886	Rawlings	Yellow and red.
8	10.3	12	Mrs. N. Halls	1881	Rawlings	Scarlet and white.
9	10.0	13	Peacock	1877	Turner	Maroon and white.
10	9.8	11	George Barnes	1878	Keynes	Lilac and crimson.
11	9.0	9	Matthew Campbell	1889	Keynes	Buff and crimson.
12	8.9	2	Hugh Austin	1881	Keynes	Orange and red.
13	8.8	6	Professor Fawcett	1881	Keynes	Lilac and brown.
14	8.4	2	Fanny Sturt	1868	Pope	Red and white.
15	8.1	5	John Forbes	1882	Keynes	Maroon.
16	8.0	9	Rebecca	1883	Keynes	Lilac and crimson.
17	7.6	3	Henry Glasscock	1875	Keynes	Buff and crimson.
18	7.4	6	General Gordon	1885	Keynes	Yellow and scarlet.
19	6.8	5	James O'Brien	1881	Keynes	Yellow and crimson.
20	6.4	4	Egyptian Prince	1873	Keynes	Orange and red.
21	6.0	5	Dorothy	1888	Keynes	Fawn and maroon.
21	6.0	6	Major Barttlelot	1889	Keynes	Orange and maroon.
21	6.0	2	Miss Browning	1880	Keynes	Yellow and white.
22	5.6	1	Miss Lily Large	1876	Keynes	Yellow and crimson.
23	5.5	7	Pelican	1886	Keynes	White and purple.
24	5.4	5	Frank Pearce	1886	Rawlings	Rose, striped crimson.
24	5.4	1	Hercules	1877	Keynes	Yellow and crimson.
25	5.0	3	Eric Fisher	1886	Keynes	Buff and scarlet.
25	5.0	5	T. W. Girdlestone	1890	Keynes	Lilac and maroon.

Eckford, Matthew Campbell, Rebecca, General Gordon, Dorothy, Major Bartlett, Pelican, Frank Pearce, Eric Fisher and T. W. Girdlestone are not to be found on the analysis for 1883. Of these Duchess of Albany, Henry Eckford, and Matthew Campbell now occupy positions amongst the first twelve.

In the following short lists the varieties are arranged according to the total number of times they were staged in competition at the last two Exhibitions of the National Dahlia Society.

Pompon.—E. F. Junker, White Aster (Guiding Star), Darkness, Favourite, Gem, Rosalie, Isabel, Golden Gem, Lady Blanche, Grace, Little Duchess, Whisper, Cupid, Dora, and Leila.

Cactus and Decorative.—Mrs. Hawkins, Empress of India, Panthea, Amphion, Juarezii, Constance, Charming Bride, Cochineal, Henry Patrick, William Darvil, Zulu, and Honoria.

Single.—Amos Perry, Miss Henshaw, Duchess of Westminster, Mrs. J. Coninck, W. C. Harvey, Cetewayo, Duchess of Albany, Formosa, Hugo, Marion Hood, Miss Ramsbottom, Miss Roberts, Sunningdale White, and White Queen.

During the past fourteen years I have kept an account of the date when my Dahlias were killed by frost. From these records it appears that the average date for the destruction of the Dahlia in the neighbourhood of London is the 3rd of November. In 1888 all my Dahlias were killed as early as October 3rd, but in 1878 not until November 29th. These are the extreme dates for the period. The mean of all the temperatures by which they were destroyed is 20°, or 12° of frost. The least cold to which they succumbed, as indicated by a thermometer on the surface of a lawn adjoining the Dahlia beds, was 8° of frost. Last autumn they fell victims to 16° of frost on the 28th of October, which is nearly a week earlier than the average date of their destruction.—E. M., *Berkhamsted*.

CURRENT NOTES.

VIOLETS.

THESE are welcome at all times, and most welcome from November to April. The cultural details given by "Practical" on page 257 are so sound that little in that way can be added. The finest Czar Violets I have ever seen were grown in 1870 under the conditions mentioned, and planted in an unheated brick frame facing south. The winter of 1870-71 was a severe one, but all the protection these Violets had was that given by shutters—made of inch boards, and battened—placed on the lights. During the month of February these Violets were a mass of bloom. I have heard it suggested that one cause of failure of Violets to flower is that they have been planted too far from the glass. The Violets in question were fully 2 feet from the glass at the back of the frame. I have since been equally as successful with Marie Louise and Comtesse de Brazza in frames with hot-water pipes round the sides.

Violets are most impatient of bottom heat, and it is difficult to conceive by what process of reasoning would-be cultivators arrive at the conclusion that they ought to have it. By bottom "heat" I mean a temperature considerably higher than the average of the atmosphere for the time being. The greatest failure I have ever seen was in an instance where they were planted on gigantic hotbeds.

CŒLOGYNE CRISTATA.

This lovely Orchid does not absolutely require sphagnum for its growth, and to trouble about it growing as upon *Odontoglossum* is quite unnecessary. An occasional watering with very weak liquid manure during vigorous growth is very beneficial to this and many other strong growing Orchids.

SPIRÆA ARUNCUS.

A magnificent plant when well grown. It is not generally known that if lifted in fair sized clumps and potted it forces and flowers quite as easily as *Spiræa japonica*, and is more effective either as a single specimen or amongst groups of plants.

WATERING PEACH TREES.

Mr. Scott writes very practically on "setting" Peaches, and his times of watering are doubtless quite correct for the trees and borders under his charge; but probably he would not recommend that no trees receive a more frequent watering. So much depends upon the mechanical nature of the border and subsoil that probably there are many Peach borders that would require two or three more good waterings than he enumerates.

THE ARRANGEMENT OF HOT-WATER PIPES.

I am glad to see a "Heating Reformer" amongst us. I was wondering the other day how it is that we still require coke and

coal for our boilers in practically—for the quantity of piping to be heated—as great quantities as ever. Every boiler of new design sent out is claimed to save so much per cent. of fuel. In other words it is claimed for them that they require so much per cent. less fuel than their predecessors, and I think we have long, ere now, arrived at the point when, if the claims have any foundation in fact, there should be a very marked difference in the consumption of fuel for the year. Can any readers of the Journal testify to any such marked saving by a change of boiler alone? If not, can "Heating Reformer" tell us why not?

That the heating power or surface in a house should be distributed as evenly as the requirements of the house will permit few will deny; but I think that the permanent welfare of its occupants and the general working facilities must have careful consideration, as well as the equable distribution of heat. I think "Heating Reformer" has not made out his case that a network of hot-water pipes over Vine borders or Peach borders is a less evil than the same number of pipes placed in two sections at greater intervals. The onus of proof lays upon "Heating Reformer," and not upon either Mr. Williams or Mr. Divers. Since "Heating Reformer's" first article appeared I have altered the pipes in a span-roofed house. There were four rows on one side and three on the other; triple flows and one return on one side, and double flows and one return on the other. One of the triple flows I have cut out, so that now both sides are heated in exactly the same way. Further, the flows on each side of the house were next the centre path; the single return on either side were nearer the wall. It will thus be seen that by this arrangement the greatest amount of heating surface was originally placed where there was the greatest volume of air to be heated. This was exactly in accordance with a most beautiful theory propounded by a writer some fifteen or twenty years ago, which was to the effect that the greatest heating power ought to be placed where there is the greatest volume of air. It is astonishing how perverse and unwilling some people are to be taught, but I have altered those pipes notwithstanding.

HORTICULTURE IN AMERICA.

Mr. J. H. Laing's paper contains many useful hints that we "Britishers" will do well to make note of and act upon, and it is as pleasing in style as useful and instructive in substance.

DRAWING FOR YOUNG GARDENERS.

The Journal is second to none for aiding and advancing the knowledge or education of young gardeners. Can any of its readers give any practical hints on drawing and colours? A knowledge of both is useful to most people, and if a gardener or nurseryman has not a correct knowledge of colours how can he (unaided) describe them so that he may be correctly understood by two or more different people?—HUGH DALE.

NOTES ON HERBACEOUS PLANTS AND ALPINES.

(Continued from page 191.)

Euryanqium Sumbul.—This is a plant but little known. I have never seen it in collections where herbaceous plants are honoured, and yet it is worthy of a place, although perhaps it may not be quite hardy, requiring some protection in winter. It belongs to a family remarkable for its very decided odours. To it belong *Assafoetida* and the Giant Fennel, while this is distinguished for its remarkably pungent smell of Musk, stems, root, and all being thus scented. A native of Turkestan, and is used by the fair dames of that region for toilet purposes. It is a somewhat stately plant, and is well adapted for placing in isolated spots well sheltered from high winds. It seems to grow in any ordinary garden soil.

Eritrichium nanum.—One of the cruxes of all growers of alpine plants. It has been imported over and over again, but I know of no one who grows it successfully. The late Mr. James Backhouse told me that he had spent £100 on it, and yet had failed; indeed, few growers of herbaceous plants ever put it into their catalogues. I have had it, but gave it up long ago. It is doubtless a little gem, but we must leave it to its native mountains, and not attempt it in our lower positions.

Gentiana bavarica.—In these smaller but most lovely alpine Gentians we are again met with difficulties in culture, and although they are not so great as in the preceding plant they are quite sufficient to test the skill of the growers. I know a few places in which it is successfully grown in the open, but our climatic conditions are against the cultivation of some of these beauties. This is shown by the fact that this and its allied and very similar species, *G. verna*, can be grown to any extent under glass where they are sheltered from the vicissitudes of the weather; but the alterna-

tions of wet and dry, heat and cold, which make our English winters, are too much for them. I have always dreamed of a sunken pit covered with glass and laid out simply as a rockery for these smaller gems, where they could be safe from these changes, and where the lights could be taken off in the summer. Alas! it is but a dream, and at my time of life must be abandoned.

Lewisia rediviva.—Another of these trying plants. It is most interesting and very pretty, but I confess to having been beaten by it, and have to abandon any attempt to cultivate it. It dies, but with me belies its name, for I never see the "rediviva" part of it.

Ramondia pyrenaica alba.—A most lovely variety of the ordinary *Ramondia*, a plant closely allied to the Primroses, and growing on the sunless sides of rocks in the Pyrenees. It is a plant of easy culture provided the conditions of its native habitats are attended to. My friend Mr. Hammond of St. Albans Court had rocks placed perpendicularly and holes bored on their face on the north side. Here they flourished admirably. I have grown it very successfully on a rockery facing the north, with a high stone at its back to shelter it from the sun. The variety *alba* was introduced by M. Otto Frœbel of Zurich, and is a most charming flower. It is probable that other growers have also found it, for that there are different strains of it is, I believe, certain, for when I was showing it to my friend Mr. Ewbank, he asked me, Was it the variety with black stamens? This was the first time that I knew there was anything in particular on this point. I had noticed it very beautifully shown by Messrs. Paul & Son at Manchester last year, but I never examined the colour of the stamens. It is a very beautiful plant, and I believe the white variety comes true from seed.

Rudbeckia maxima.—A fine stately perennial, growing some 6 or 7 feet high, with bright yellow flowers of large size with a black disk, giving it a very striking appearance. It is suitable for a shrubbery or the back row of an herbaceous border.

Silene acaulis.—This charming little alpine plant has been found by many somewhat difficult to grow. It has a long tap root which requires some considerable depth to penetrate into. Nothing indeed is more remarkable in some of these alpine plants than the great depth to which the roots extend. A plan which was suggested to me of planting this charming little *Silene* in a drain pipe, and so giving it plenty of room to send down its roots, seems to have succeeded. The plant looks well notwithstanding the severe ordeal it has had to go through during the past winter.

Shortia galacifolia.—I am not as yet the fortunate possessor of this charming little plant of recent introduction in a living state, although discovered more than 100 years ago in North Carolina. It is one of those dwarf white flowered plants which are most uncommon amongst alpinists. The flowers are pure white, about an inch in diameter, with somewhat of a drooping bell shape. I do not know whether it will be a difficult plant to grow, but if not it will be a great acquisition to our rockeries.

Saxifraga oppositifolia superba.—This is one of the fine varieties of this charming alpine, which has been introduced by Messrs. James Backhouse & Son. All who know the great beauty of the ordinary variety will welcome these larger flowered varieties. I had tried it on various parts of my garden, and could not get it to grow; but I at last planted it in a sunny spot on another rockery, and there it has flowered and grown well, as has also the pretty white variety.

Saxifraga Burseriana major.—A large flowered variety of one of the very earliest and best of our dwarf Saxifrages. The flowers are an inch across, and completely cover the foliage; it shows itself long before Snowdrops or Crocuses are in flower, and seems to bear well all the varieties of weather we are subjected to when it is in flower.

Saxifraga Boydi.—This may be fitly described as a yellow Saxifraga in the style of *Burseriana*, and forms a fitting companion to it. I do not know whether it is so early, but is evidently an early flowering species. At present it is scarce, as it was awarded a first class certificate when exhibited by Messrs. Paul & Son this month.

Tecophylax cyanocrocus.—One of the most beautiful of recently introduced bulbs; it is very early flowering, but as I have as yet only ventured it in pots I cannot speak as to its earliness out of doors. The colour of the flowers varies considerably from an intense deep blue like *Gentiana verna*, to a lighter tint almost like *Chionodoxa Luciliae*; the individual blooms last a long time.

Tiarella cordifolia.—A very old, but rarely seen, herbaceous plant, and rare only in the sense that it is seldom seen; it has creeping roots, blooms abundantly, the flowers white and feathery, making a very pretty object on the rockery.—D., Deal.



CYPRIPEDIUM MAYNARDI.

SOME have fancied that *Cypripedium* hybrids are becoming too numerous, but so long as good novelties are forthcoming they will assuredly be welcomed by Orchid lovers, and there are many more to come that will gain high favour. That represented in the illustration (fig. 51), *C. Maynardi*, was raised in Messrs. Sander & Co.'s nursery, St. Albans, by the hybridist whose name it bears, and was adjudged an award of merit by the Orchid Committee of the Royal Horticultural Society on December 9th, 1890.

It is a beautiful hybrid between *C. purpuratum* and *C. Spicerianum*, the flowers taking the general form of the latter parent, but evidently influenced by other in a material degree. The dorsal sepal is rounded in outline, but the lower part is reflexed and white, with a deep crimson central vein, and a few lighter ones; the base green. The petals are short, greenish at the base, dotted with purple, purplish towards the tip, edged white, the margin undu-

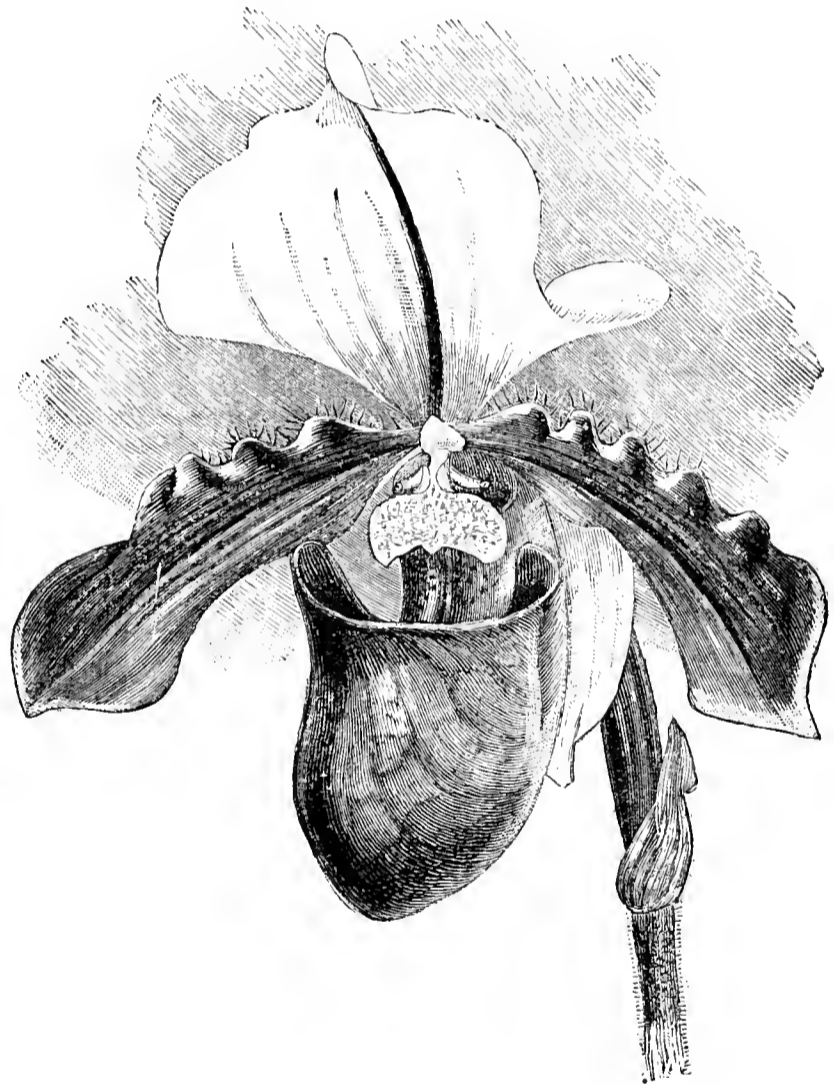

FIG. 51.—CYPRIPEDIUM MAYNARDI.

lated. The lip is dark purplish, with a purple staminode. The leaves are about 1½ inch broad and 5 to 6 inches long, faintly marbled with dark green on a lighter ground.

MIGNONETTE.

MIGNONETTE raised from seed sown in August in cold frames and kept in them as long as the weather allows is often ruined in winter quarters. If the atmosphere is close and confined, and an attempt is made to maintain a temperature of 45°, the plants grow weakly and produce only puny heads of bloom. If wintered properly they should make very little growth, but that should be stout and strong growth. Mignonette winters best on a shelf close to the glass, or nearly so, in a cool-house where frost only is excluded—that is, where the temperature does not fall below 35°, rarely at night exceeding 40°, and where liberal ventilation is given during mild weather. To have well-grown pots of Mignonette it is important to thin the plants liberally and early while they are in frames. Each plant from the first is then of the sturdiest nature,

and capable of supporting itself. It is a mistake to allow them to grow thickly together until they are 1 or 2 inches high. Few plants are needed in 5-inch pots—one at every inch distance round the rim with four or five in the centre will be ample; in fact, more than are really required. But this is a guide for the first thinning, as odd plants may fail. If the plants finally stand 2 inches apart when housed for the winter they will be thick enough. A few plants in each pot with large heads of bloom are much more effective and more highly prized than a crowded mass of weakly plants that fail to produce one good spike of bloom. We invariably place four or five short sticks round the sides of the pots, and one thin thread of matting near the base to keep the plants from falling about if removal becomes necessary. The pots sometimes become green, but we prefer leaving them in this condition to moving the plants about in order to wash them.

Mignonette that has passed the winter well and looks promising now needs attention. If slightly crowded remove some of the weakest plants, and much can be done in giving those that have taken the lead every chance by the removal of those which are weak. However well they may be attended to, some will not advance so freely, and rather than allow them to spoil the sample we advise them to be pulled out, for few good plants at the present time can be made to furnish the pots. After thinning all that are useless place another thread of bass round the stakes for support. Remove the point from any plants that are taking the lead, or any that may be needed to branch more. The few good plants remaining in each pot, supposing there are only three or four, may be tied down over the surface. When the point has been removed lateral growths are produced quickly, and under good culture they grow strongly. Sufficient lateral growths will be produced to furnish fine bold spikes, and some of the best pots of Mignonette I have ever seen were the result of three or four plants being bent down on the principle described.

The position of the plants from the present time and their subsequent treatment is important if success is to be accomplished. They must not be returned again to the shelf. For a time all would go well, but as the sun gains more power shelves are then too drying for Mignonette. Frequently the plants become woody, and assume a sickly yellow appearance, and when once they are brought into this condition all attempts to restore them to a healthy robust condition will prove fatal. From the present time the plants should stand on a bed of ashes, or some other moisture-holding material with a cool base. The pots must stand sufficiently far apart that light and air can have free access to every plant. When large spikes are produced the plants must have dark green large foliage down to the rim of the pots. To accomplish this they must be grown without a check, so that their shoots resemble stout heads of Watercress. The nearer the glass the plants can be kept the better; but this is not so important as suitable atmospheric conditions and careful applications of water. No artificial heat need be used except to keep out frost, and abundant ventilation should be given whenever the weather is favourable. During mild weather too much air cannot be admitted, but during cold cutting winds keep the ventilators closed.

It is necessary never to allow the plants to become dry at their roots; if once the soil becomes dry the growth of the plants is rendered woody, and small spikes and yellow foliage then only need be expected. On the other hand, they must not be overwatered; one evil is as great as the other. Care and judgment only are needed in the accomplishment of this task. As the plants commence growth soot water in a clear state may be given once or twice a week with advantage. This acts quickly, and imparts to the foliage a fine dark hue. A little artificial manure may be applied to the surface of the soil now and at intervals of three weeks until the spikes appear. Too much at one application will do more harm than good; very little should be given each time. Mignonette in pots dislikes either strong doses of artificial or liquid manures. Except soot water we never apply the latter. We have found artificials to be more suitable, and to keep the roots working on the surface abundantly.—WM. BARDNEY.

FLOWERS FOR CUTTING.

HALF-HARDY ANNUALS.

WHERE many of these are grown it pays to set apart several sashes of frames, and to sow the seeds in prepared beds of soil. The first or second week in April suits well as a rule, for there is then a genial temperature, which brings on the young seedling at a sufficiently rapid rate to have them ready for transplanting into the open quarters by the middle of May or the third week of that month. First of all a perfectly hard base must be prepared on which the 3-inch bed of soil is to lie. The benefit of this will be found in the greater number of roots which can be lifted in

good condition. A light open compost is best, for on this the seeds are sprinkled thinly, and a slight covering of soil is thrown over all. If the soil is in fit condition no water will be required, but the sashes must be shut down close and covered with mats until the seeds have germinated. A dripping day is chosen in which to plant the seedlings out. Where only a few plants are required ordinary cutting boxes should be used. Keep these in a warm house until the seedlings are well through the soil, and then remove them to cold frames closed for a few days, in due time transplanting in the manner advised above. Extra strong plants are secured by transplanting into frames, and lifting the plants with roots.

No flower of this section obtains a greater popularity than the Aster in its various sections. It may be added with truth that no flower is more deserving. At the same time for cut flower purposes only a limited number are suitable. Taking all points into consideration the reflexed Victoria is the best that can be grown. I endeavour to purchase seeds in separate colours, not as collections. The white is the most useful, though, perhaps, the best white Aster of all is the Emperor form. The quilled section is also deserving of culture. The flowers can be cut with long stems, having buds and half-opened flowers attached, and in this condition they are capital for vase furnishing. But better still than the quilled Asters for the latter purpose are the single varieties. Unfortunately we have either to send to the Continent for these or to invest in the penny packets sold at small shops, when a fair proportion of singles may be expected.

Phlox Drummondii grandiflora deserves culture for the purpose under review. The flowers are most suitable for flat glasses. Zinnias, especially the singles, are useful, and a few of these should be cultivated for the smaller glasses or vases. Salpiglossis are capital, though not much known; it is one of the best for cutting, and is perhaps always best employed by itself. It requires no other setting than its own foliage and buds. Scabious also is not very well known, and of this the dwarf form should be eschewed, as it is worthless compared with the tall-growing varieties. Scabious flowers may either be mixed with others or arranged by themselves.

Marigolds, French and African, although generally despised, perhaps on account of their odour, are both fine autumn flowers. The double varieties are good, but the singles in both are very much better. There are indeed few more telling than the single striped French when arranged with other flowers. The African Orange is a shade by itself. I have never found it necessary to sow seed from single flowers of either of these, as there is always a percentage of single; and when sufficient room is allowed each plant a large quantity of flower is procurable from a few specimens. Sunflowers have suffered from the æsthetic craze. Nevertheless, they must be occasionally used. In addition to the ordinary single and double forms, the new dwarf Miniature, which I have grown for the past few years, is on its merits one of the best plants for cut flowers. Flowers, buds and foliage are alike good.

Dianthus Heddegi and D. chinensis are very suitable for furnishing small glasses, either by themselves or in mixture with other flowers. Nicotiana affinis, if for no other purpose, ought to be cultivated for the production of a few flowers for cutting. It does capitally treated as a half-hardy annual, a good plant, producing an abundance of pretty sweet-scented blossoms.—N. B.

GREEN FLY ON PEACH TREES—SETTING FRUITS WITH THE SYRINGE.

I AM not in the least surprised that your correspondent "J. J. C." (page 266) should take exception to my advice to syringe Peach trees when in full bloom, for the double purpose of fertilising the blossoms and keeping green fly away, because I am aware that any attempt to depart from the "beaten track" is usually met by strong opposition, and not unfrequently by prejudice. Let it not be supposed by this that I wish to claim as anything new the practice of setting Peaches and Nectarines with the syringe, as I know it has been successfully practised for years, but the benefit the trees derive by adopting this method of fertilisation has not been sufficiently acknowledged. As my opponent so emphatically declares that he fails to see the point, and then goes on to say that syringing Peach trees in full bloom he does not approve of, I feel tempted to ask if he has ever tried the plan; because these objections are sometimes mere conjectures rather than facts borne out by practice. I do not dispute the fact that trees well managed in other respects will not suffer much from the attacks of green fly if the house is fumigated with tobacco paper just before the trees come into flower and again as soon as the flowering is over; but there is plenty of room for improving upon this plan when a broad view is taken of the subject. For instance, when a perfect set of fruit can be obtained by syringing when in flower and the fumigating dispensed with, a great saving is effected, as the quantity of tobacco paper used in extensive gardens is an item of some importance. It sometimes happens that on a few shoots close to

the hot-water pipes aphides will make their appearance while every other portion of the trees are perfectly free; in such cases it is a great waste to fumigate the whole house, when a little tobacco water will in a few minutes set matters right.

I will ask readers to note that "J. J. C." objects to syringing Peach trees when in full bloom, because it is a practice "that cannot be applied indiscriminately," while at the same time he advocates fumigating in every case just before the flowers expand, and if necessary when the trees are in active growth. Do not these operations require discrimination? I should consider it much more easy for an unthinking operator to ruin the prospect of securing a good crop of fruit by fumigating too strongly than by syringing in wet or very dull weather. Of course all these matters require due consideration. I did not advise trees in full bloom to be syringed in wet weather. During a succession of wet days I would substitute the rabbit's tail for the syringe, and should such weather last during the whole time the trees are in flower green fly will not give much trouble. It is when frosty nights are followed by bright days that this pest spreads so rapidly when the trees are in bloom, and during such weather no doubt much may be done to keep things right by damping the floors lightly and setting with the brush; but according to my experience to syringe the trees lightly during the middle of the day is a much better plan; it insures a perfect set, much time at a busy season is saved, as well as tobacco paper, and the trees are kept fresh and healthy.

I find it necessary to quote another portion of your correspondent's letter in order to show the fallacy of his theory. It runs thus:—"It matters little by what means the pollen is conveyed to the stigma; the principal thing is to get it there, only it seems to me the best method of conveying the fine grains of pollen is by a genial, buoyant atmosphere, than by partly conveying the pollen into a pasty matter by wetting it with a syringe." Many times I have thought that matter over in years gone by, and the idea of setting flowers by wetting the pollen then seemed strange to me; but a little practice with the syringe soon convinced me how well it did its work. Syringing undoubtedly dispersed the ripe pollen to the pistil, and this quickly becomes dry again during bright weather; but it is by no means clear that fertilisation does not take place while the pollen is damp, but of course it must become dry by the aid of a buoyant atmosphere before syringing is performed, otherwise that operation would not disperse the pollen.

The idea that large flowering varieties of Peaches and Nectarines will not answer under the syringing system is altogether wrong, as Sea Eagle Peach, which has very large flowers, and Pine Apple and Lord Napier Nectarines, set quite as well as the small-flowering varieties—in fact, nearly every flower seems to set so as to allow plenty of fruits to select from on the upper side of the shoots.

And now for a short answer to my opponent's "parting shot," where he says, "to syringe a house and leave ventilation on seems a singular process, for it is like trying to defeat the object you wish to attain, for a very large portion of the moisture must escape." Now, it is evident that "J. J. C." either read my remarks very lightly, or altogether ignored the stage of growth the trees had reached when this practice was advised. If he had read carefully he would have clearly seen I advised this to be done while they were still in flower. Surely "J. J. C." is not such a novice in Peach culture that he would close the house in the middle of the day, and excite the trees at such a critical stage of their growth, when a circulation of air is so important for their well-being; that indeed would be a singular process.—H. DUNKIN.



EVENTS OF THE WEEK.—The Royal Society meets to-day (Thursday) at 4.30 P.M., the Royal Botanic Society on Saturday at 4 P.M. The Royal Horticultural Society's Committees meet at noon on Tuesday, and the Society of Arts at 8 P.M. on Wednesday. At the R.H.S. meeting the subject for the afternoon lecture is "Laehenalias," by Mr. F. W. Moore; prizes are also offered to amateurs for collections of Daffodils.

— THE METROPOLITAN WEATHER still continues very unsettled, but somewhat more seasonable, frequent showers falling on Saturday and Sunday. Monday was very bright and comparatively warm, but was followed by cold winds and a leaden sky on Tuesday.

— It is stated in the *Illustration Horticole* that the late GUSTAVE DIPPE, the continental seedsman, has left a sum of money equivalent to about £15,000 for the benefit of the working gardeners and apprentices of Quedlinburg, with a similar amount for other artisans in that town. To the gardeners of Halterstadt £2400 has been left, and to the gardeners of Neundorf £2000, together with similar amounts to men of other trades in those towns. It is seldom an opportunity occurs of recording such princely beneficence in the world of horticulture.

— HIRBERD MEMORIAL FUND.—The Committee beg leave to announce that this fund, instituted for the purpose of securing a portrait of the late Mr. Hibberd, to be placed in the Lindley Library, and with the object of securing a fund for the benefit of Mr. Hibberd's orphan daughter, will be closed on April 30th, 1891, and they particularly request that all subscriptions may be paid to the Treasurer on or before that day. The amount received or promised up to this date is about £240, a sum which it is hoped may be considerably augmented before the closure of the fund, especially by the receipt of numerous small sums from the many who hold Mr. Hibberd's name in respect. Subscriptions should be sent to the Treasurer of the Fund, Dr. Masters, at the Royal Horticultural Society, 117, Victoria Street, Westminster.

— THE death is announced of MR. GEORGE CHILD, at one time a well-known London seedsman of the firm Beek, Henderson, & Child. Mr. Child died at Balham on March 28th in his seventy-fourth year. The firm with which he was connected was some years ago combined with that of Messrs. Waite & Co.

— MR. J. TROTTER, Hertford, sends us a DOUBLE-SPATHED RICHARDIA, which is the largest and finest we have seen. The larger of the two spathes is 9 inches long to the tip, and 6 inches broad; the smaller, enclosed within the other, is nearly circular about 4 inches in diameter.

— I SEND herewith three buttonholes of COMTE BRAZZA'S WHITE NEAPOLITAN VIOLET, a beautiful variety which has the name in some places of being miffy, and is not nearly so much grown as it ought to be. With us it is the strongest growing Violet we have.—JOSEPH OLIVER, *Eslington Park Gardens*. [The flowers received were large, full, fine, and very sweet, the best we have yet seen of this variety.]

— DR. WILLIAM SOMERVILLE, having been appointed to the Chair of Agriculture and Forestry recently founded in the Durham College of Science, Newcastle-upon-Tyne, will begin his duties early in the summer. The College has acquired fifteen acres of land at Gosforth for the purposes of an experimental station, and it is hoped that smaller stations will be established in other parts of the district. It is the desire of the College that the members of the staff of its Agricultural Department should assist in the establishment of a system of agricultural education throughout the adjoining counties, partly by a system of "extension lectures" and partly by conducting special classes for teachers.

— THE schedule of the BRIGHTON AND SUSSEX HORTICULTURAL ASSOCIATION for the current year has just come to hand, and from it we learn that the Rose Show will take place on July 1st and 2nd, and the Autumn Show on September 9th and 10th, both being held in the Royal Pavilion. At the Rose Show the prizes range from £5 to 5s. in the open and amateurs' classes. At the Autumn Exhibition the chief class is for eight stove and greenhouse plants, with £10, £6, and £4 as the prizes; but fairly liberal amounts are offered in most of the eighty classes enumerated.

— WARE AND DISTRICT HORTICULTURAL MUTUAL IMPROVEMENT SOCIETY.—A meeting of this Society was held on Tuesday evening, the 31st ult., when there was a good attendance, and eight new members were elected. The paper for the evening was an able essay on "Vegetables" by Mr. A. King. A discussion followed, in which several of the members took part. A capital collection of stove and greenhouse plants was shown by Mr. R. Smith, of Tresdales. The date of the next autumn Show was fixed for November the 12th and 13th. The usual votes of thanks brought a successful meeting to a close.

— APPLE MÈRE DE MÉNAGE.—I quite agree with your correspondent "E. M." (page 245) as to the merits of the above Apple. In this district it does remarkably well, never failing to carry heavy crops of handsome fruit, but of course not equal in colour to some of the fine specimens I have seen from Herefordshire and further south. Last autumn I was asked by an amateur residing near here if I would pay him a visit, as he had some very fine Apples, and would like to know the name of them. I did so, and on entering his snug little garden I found two well trained trees of the above variety. They were laden with fine handsome fruit, much larger and better coloured than any I had seen before in this neighbourhood. They had been planted nine years. The soil was a light sandy loam, and they were well supplied with liquid manure. Several other plans near here I could mention where it crops well. Dumelow's Seedling is another variety that bears heavy crops in this district.—H. FORDER, *Castle Gardens, Ruthin, North Wales*.

— WE are informed that the ROYAL HORTICULTURAL SOCIETY'S GREAT TEMPLE SHOW will be held on Thursday and Friday, May 28th and 29th (instead of the date previously announced) and it will be opened at 1 o'clock on Thursday, May 28th, by Her Royal Highness the Princess Christian. The band of Her Majesty's Scots Guards will be in attendance each day. Fellows will be admitted free on either day on showing their tickets; the public on Thursday on payment of 3s., on Friday 1s. The gates will open on Thursday, 1 P.M. to 8 P.M.; on Friday 10 A.M. to 6.30 P.M.

— THE WEATHER during the past month has been unusually severe, very sharp frost with cold, cutting strong north and north-east winds, and frequent snowstorms. Rain or snow fell upon most days, whilst the night of 9th resembled the 18th of January, 1881. The greatest amount of rainfall registered in any twenty-four hours being 0.63 on the morning of the 8th. Total amount for the month being 2.03 against 2.67 of 1890.—E. WALLIS, *The Gardens, Hamels Park, Buntingford.*

— THE TOTAL RAINFALL AT CUCKFIELD, SUSSEX, FOR MARCH was 1.94 inch, being 0.14 inch below the average. The heaviest fall was 0.29 inch on the 7th and 15th. Rain fell on fifteen days. The highest temperature was 57° on the 1st and 2nd, the lowest 19° on the 12th. Mean maximum in the shade, 45.1°; mean minimum, 32.2°; mean temperature, 38.6°. Partial shade reading just the average. The temperature only rose to 50° on eight days, and fell below freezing on fifteen nights. Vegetation made but little progress since the first week. Not a Lent Lily is out yet, and but very few Primroses are to be found in the woods.—R. I.

— THE WEATHER AT RIPLEY, YORKS, FOR THREE MONTHS, ending March 31st, 1891.—At the end of this, the first quarter of 1891 vegetation is in a very backward state; the only real growing weather there occurred in February. At this time we were afraid of fruit trees coming into flower too early, but happily before they got too far advanced they received a check, beyond which they have scarcely moved up to the present. January was a very cold month, the mean temperature being 31.7°. February was much warmer, the mean being 37.1°. March cold, with the wind in northerly and easterly directions upon twenty-one days, mean temperature 38°. Rainfall very light; total for three months 2.80 inches, which fell upon forty-four days. Mean reading of barometer for three months ending March 31st, 30.19°; mean maximum temperature, 43.40°; mean minimum temperature, 27.90°; mean temperature, 35.60°; highest maximum temperature, 58°, on February 15th; lowest minimum temperature, 2° below zero January 18th; at or below 32° on sixty-three days. April so far (6th) is attempting to make up the deficiency of rain; last two days rained almost incessantly, 1.72 inch registered.—J. TUNNINGTON, *Ripley Castle Gardens, Yorks.*

— BIRMINGHAM GARDENERS' ASSOCIATION.—At the last meeting Messrs. Hewitt & Co., The Nurseries, Solihull, exhibited cut blooms of *Mageolia Soulangeana Alexandrina*, as well as of the old *Soulangeana*, and the former is a decided improvement, the petals being more rounded, and of greater substance and better form, and much brighter in colour on the outside of the petals. The blooms were cut from plants in pots and now in flower, and to show its usefulness as an easily forced plant. There were also from the same firm *Primula rosea* in pots, well flowered; also of *Primula verticillata* (the Abyssinian Cowslip). Mr. John Child, an old Dahlia grower, read an instructive paper on the culture of the Dahlia.

— THE ROYAL CALEDONIAN HORTICULTURAL SOCIETY'S spring Show, held on April 1st and 2nd in the Waverley Market, Edinburgh, was comparatively poor. The weather in Scotland during March had been of the most wintry character, and on April 1st there were 8° of frost. Of bulbous plants Hyacinths formed the best display, Tulips and Daffodils being but poorly represented. A few good Orchids were staged, a fine plant of *Dendrobium Hilli* being conspicuous. Mr. John Patterson showed a few well trained specimens of *Azalea indica* varieties, stove and greenhouse plants, and Heaths, being first in the several classes devoted to these. Scarcely any fruit was shown, Mr. McIndoe, Hutton Hall, Mr. Smith, Oxenford, and Mr. Potter, Seacliffe, being the chief prizetakers. The fruit comprised a few Pine Apples, Grapes, Strawberries, Pears, and some good Apples. Very few vegetables were shown. Among nurserymen Messrs. R. B. Laird & Sons, West Coates, had exhibits of Rhododendrons, Azaleas, Hyacinths. Messrs. Methven & Sons also had a table of decorative plants, as did

Messrs. Dickson & Co., Waterloo Place, Messrs. Ireland & Thomson, and Messrs. J. Dickson & Sons. From Messrs. Ryder & Sons, Sale, came some Japanese Primroses, and Mr. Cowan, Valleyfield, had a collection of cut Daffodils.

— BLACK CURRANT MITE.—Mr. Bardney writes:—"Thanks for the two notes on page 265. I did notice the white mealy appearance about the roots, but concluded that this had nothing to do with the mite. It is just possible the conclusion at which I arrived was too hasty, and if an opportunity offers I intend to investigate the matter farther. I have not observed the reddish-coloured aphides about the buds; but a grower in Lincolnshire, who sent me samples, spoke of these insects. I could not be certain that these insects assume the winged state, but from the various stages in which I saw them I am almost certain such is the case. I am sorry to say at the time my investigations were carried on with a very poor glass. A good instrument I think indispensable in all gardens, and one that should be provided by all employers."

— FUNGOID DISEASES OF THE GRAPE.—We have received from the Government Printing Office, Washington, U.S.A., a "Bulletin" on this subject by Mr. B. T. Gallaway, Chief of the Division of Vegetable Pathology. The prevalent fungoid diseases of the Vine are concisely described, and the most approved remedies indicated. For general use the *Bordeaux mixture* is recommended, made by dissolving 6 lbs. of copper sulphate (in powder) and 4 lbs. of fresh lime in 22 gallons of water. The copper is first dissolved in a small quantity of water till it is blue, then the blue solution is poured into a barrel, and the requisite quantity of water added and lime stirred in. Some Grape growers find a solution of half the above strength destroy the mildew, and it would be prudent to first try this before having recourse to the stronger preparation. An *ammoniacal solution* has also been found effective. It is made by thoroughly mixing 6 ozs. of pulverised ammonia carbonate and 1 oz. of copper carbonate in sufficient water for the purpose, keeping it in an air-tight vessel; and when wanted for use dissolving in, or at the rate of, 10 gallons of water.

— "MEEHAN'S MONTHLY."—This is the title of a new American magazine to be conducted by the eminent botanist and horticulturist whose name it bears, Mr. Thomas Meehan. It will consist of sixteen pages, with a coloured plate by L. Prang & Co., of Boston, of a wild flower from some portion of the United States; with a chapter on wild flowers, and others on the more intelligent features of general gardening. Mr. Meehan states that the correspondence resulting from the discontinuance of the "Flowers and Ferns of the United States" and the "Gardeners' Monthly," of both of which he was the Editor, shows that there is yet a field not occupied by the several excellent horticultural magazines which his may acceptably fill, and he goes on to say:—"Thousands who have no gardens are in love with wild flowers; while the knowledge gained through our extensive horticultural operations must be of service to those who love gardening, but have not the time to experiment as we can." The new magazine will commence in July, and the price is 2 dols. a year.

— BOLTON HORTICULTURAL AND CHRYSANTHEMUM SOCIETY.—The monthly meeting of this Society was held on Thursday last at the Operative Spinners Hall, Mr. Chas. Jones presiding, and a good company assembled to hear a paper by Mr. Herd Fernclough, who is a very successful Grape grower and exhibitor, on the Grape Vine. The essayist remarked at the outset that for this part of England all borders should be inside, and should be flagged with cemented joints or conereted, and with at least 6 inches of broken brick as drainage, to be covered by a layer of fresh cut turf laid on grass downwards, good fibrous loam being indispensable in the formation of the Vine border, and advocated that this should not be cut so thin as in many instances—not less than 3 inches—be also preferred to use it fresh cut to its being laid up for a time. The turf should not be cut to pieces but laid on in layers, intersecting each layer with inch bones, charcoal, broken bricks, and if possible to add a little paring from horses' hoofs. The border must be made up in sections of about 4 feet at a time. He strongly condemned the use of farmyard or stable manure in the formation of Vine borders as having a tendency to promote over-luxuriant and soft growth, and goose-quilled roots in place of good solid short-jointed shoots, and fibrous roots so necessary to success. Proceeding to give details of after management, such careful ventilating, stopping, thinning the bunches, and watering, and in conclusion appealed to young men to be ever watchful in all details, and whatever success has been obtained by others would ultimately be accomplished by them. A lively discussion followed, Messrs. Corbet, Callow, Tatton Wainwright,

Sewel, Smith, and others taking part, in which the quality of Alicante and Gros Colman Grape were the main features, opinions being about equally divided. A vote of thanks to the essayist brought a very interesting evening to a close.—JAS. HICKS, *The Gardens, Ravenswood, Bolton.*

— AT MESSRS. B. S. WILLIAMS & SON'S VICTORIA AND PARADISE NURSERIES, Upper Holloway, there has been for some weeks a remarkably varied and beautiful floral display. Bulbs comprising Hyacinths and Tulips, and Narcissuses, in all their best varieties, are arranged in the Heath house, where they form two handsome banks with the path down the centre of the house. *Clivias*, which have long been a speciality at Holloway, constitute an imposing exhibition in one house, while the brilliant *Amaryllises* are in grand condition in an adjoining structure. Of Orchids Messrs. Williams have a remarkable number in flower, especially amongst the *Odontoglossums*, and they seem to have almost entirely escaped the ill effects of the fogs. In fact the plants in all the houses look as healthy as could be wished, and we do not remember ever seeing this interesting nursery in better condition.

— CHISWICK GARDENERS' ASSOCIATION.—MRS. LEE'S PRIZES.—For the past four years Mrs. Lee of Chiswick has kindly and generously provided a substantial sum of money to be bestowed as prizes for essays by the members of the above Association. Last year some of the prizes were withheld by the Judges, but as Mrs. Lee gave her usual contribution this year the amount at disposal was greater than usual, and more prizes consequently awarded. In the first section the subject "Horticulture; Its Influence Among the Masses" was chosen by the Committee, and the competitors had to write their essays under supervision. The two prizes were won by Mr. J. Smith (first) and Mr. J. Barry (second), both of the R.H.S. gardens. In the second section competitors chose their own subjects, and the prizes were adjudged as follows:—First, Mr. A. Wright, The Gardens, Devonhurst, Chiswick; subject, "Prolonging the Supply of Hardy Fruits." Second, Mr. T. Waugh, R.H.S. Gardens, "Apples." Third, Mr. T. Bones, The Gardens, Tower House, Chiswick, "Hardy Fruit Culture." Extra third, Mr. E. Booker, Dorset Lodge, "The Orchard House." Fourth, Mr. J. B. Wood, Duke's Avenue, "Chrysanthemums." Extra fourth, Mr. H. Westgate, Tower House, "Carnations." Third section, for juniors.—First, Mr. T. Waugh, "Small Fruits." Second, Mr. R. Orchard, Tower House, "Begonias." Third, M. W. Robertson, The Gardens, Dover House, Roehampton, "Cinerarias." Fourth, M. J. Rick, Devonhurst, "Amaryllis." The juniors were privileged to compete with their seniors, and one of them, Mr. Waugh, did so effectively. Mr. G. Gordon and Mr. J. Wright were the Judges, and the papers were much better than those of previous years. Mr. Gordon, Chairman of the Association, distributed the prizes at the annual dinner of the members, over which he ably presided on Friday evening last. It was a very pleasant gathering of intelligent gardeners old and young, and a few of their friends.

— WOOLTON GARDENERS' MUTUAL IMPROVEMENT SOCIETY.—The Committee of the above Society, of which the President is Holbrook Gaskell, Esq., J.P., propose to hold, at the Parochial Hall, Woolton, early in October, a Horticultural Conversation and Exhibition of Appliances and Specimens connected with Gardening. The Exhibition will be non-competitive, but Certificates of "Merit," "Culture," and "Commendation" will be awarded to such exhibits as the Judges may deem worthy. The proceeds will be devoted to the Library Fund of the Society, and the Committee trust they may be supported in arranging an interesting and instructive Exhibition which will prove of considerable educational value to all lovers of horticulture. A complete schedule will be sent out, with rules and regulations, in August. Offers of assistance and suggestions are invited to be sent to R. G. Waterman, Hon. Treasurer, Church Road, Woolton; J. Rothwell, Hon. Sec., Allerton Road, Liverpool. The proposed schedule is as follows:—Section 1, Modern and Ancient Garden Pictures, Plates, and Photographs. 2, Modern and Ancient Garden Literature. 3, Fossils; Dried Flowers, Ferns, and Grasses; Skeleton Leaves, Fruit, &c. 4, Novelties, Rarities, and Monstrosities of Plant Life. 5, Horticultural Appliances requisite for the Garden. 6, Models of Greenhouses, Heating Apparatus, &c. 7, Plans, Designs, and Elevations of Gardens and Garden Structures. 8, Microscopes, with Botanical Sections. 9, Collections of Hardy Fruits, Plants, Vegetables, and Autumn Flowers. 10, Insects beneficial and injurious to Plant Life. 11, Apiarian Exhibits, with Sections of Honey and Food Plants. Short lectures will be delivered at intervals, with lime-light and other illustrations.

— THE SALE OF ORCHIDS and other indoor plants of the late M. de Cannart d'Hamale will be held at Malines, Belgium, on Tuesday, April 14th, and the two following days.

— WE learn that M. FRANCOIS WIOT, a well-known Belgian horticulturist, died at Liège on April 4th last, in the sixty-ninth year of his age. M. Wiot was a Chevalier of the "Ordre de Leopold."

— IN the sale of the FERNSIDE ORCHIDS on Tuesday and Wednesday last some high prices were obtained for the best varieties of *Odontoglossums*, ranging from 10 to 100 guineas. At the last-named price *O. crispum leopardinum* was sold after a smart competition, and it was understood that its destination was Brussels. In some instances ten times the original price was realised; ordinary varieties, however, sold at low rates.

— SCILLA SIBIRICA.—As a rockery plant this early spring-flowering bulb is most valuable. When planted in clumps of about ten bulbs each a capital display is made; they increase rapidly and form bold clumps in a few years. The extremely dark shade of blue which this *Scilla* possesses is not by any means common. The only defect in *Scillas* is the tendency which the flowers have of drooping so much that they cannot be seen to the fullest advantage.—E. M.

— LIVERPOOL HORTICULTURAL ASSOCIATION.—The eighth spring Show of the above Association was held on Tuesday last in St. George's Hall, and surpassed all previous efforts. Orchids were of the greatest importance both in quantity and quality. The principal first prizewinners were Mr. B. Cromwell, gardener to T. S. Timmis, Esq., and Mr. J. Wilson, gardener to J. E. Reynolds, Esq., Sandfield Park, West Derby, who had a magnificent *Dendrobium Ainsworthi*. Mr. Cromwell's were also grand. Azaleas were handsome, foremost in the winning class being Mr. B. Cromwell; Mr. J. Wilson, gardener to H. Cunningham, Esq.; and Mr. C. Osborne, gardener to H. J. Robinson, Esq., Aymestry Court, Woolton. Primulas and Cinerarias were fairly well shown, also Tulips and Hyacinths. Stove and greenhouse plants were represented by fine plants from Mr. Cromwell. Messrs. R. P. Ker & Sons, Aigburth Nursery; Messrs. B. S. Williams & Son, Upper Holloway; Messrs. T. Davies & Co., Wavertree; and Dicksons, Limited, Chester, all contributed excellent stands of miscellaneous plants, which added greatly to the Show. Altogether the Show was of the greatest merit, but cannot be dealt with fully this week.

— INFORMATION FOR EMIGRANTS.—The April circulars and the new editions of the penny and other handbooks, with maps, issued recently from the Emigrants' Information Office, 31, Broadway, Westminster, S.W., show the present prospects of emigration to the colonies. A summary is hung up in every Post Office in England, Ireland, and Scotland, so that intending emigrants have no difficulty in obtaining information. A circular before us states:—"The Canadian Government now offers for the first time bonuses of 15 dollars to the head of a family, and half that amount to his wife and grown-up children, if he settles on land in the North-West or in British Columbia. In Australasia there is still a demand for female servants, farm hands, dairymen, general labourers, and men who understand pruning fruit trees and nursery work. Such men and women will under certain conditions get free or reduced passages to Queensland and Western Australia. Farmers and fruit growers will find openings in the Australian colonies, and may obtain reduced passages to Western Australia, and in certain cases free passages to Natal. Emigration is strongly discouraged to South America at the present time."

— SWANSEA AND DISTRICT CHRYSANTHEMUM SOCIETY.—Owing to the success of last year's Exhibition the Committee have decided on holding another on November 4th and 5th, 1891, offering £130 in prizes, besides a number of specials which are offered by nurserymen and seedsmen. A good balance is in hand from last year, and several new subscribers have signified their intention of supporting the Society. Several influential gentlemen have become members of the Committee, and Messrs. T. Kneath and W. Roberts were re-elected Hon. Secs., with Mr. W. J. Ireland, Singleton, Chairman. The principal classes in the new schedule are—£20, in three prizes, for forty-eight blooms, thirty-six varieties; £10, for thirty-six blooms, twenty-four varieties (open to growers in Wales and Monmouth only); and two classes for twenty-four blooms, distinct, offering £7 in each class. The Hon. Treasurer, B. Evans, Esq., will offer a hall-marked silver cup "for the best six plants of white Chrysanthemums, distinct varieties." Prizes for groups, specimen plants, and for amateurs, are also offered on the same liberal scale.

A RUN THROUGH NORMANDY.

MANY British visitors to Paris who have a wholesome dread of the *mal de mer* invariably select the Dover and Calais route for the shortness of its sea passage, and to business men the time saved on the journey is also an important consideration. By journeying this way, however, in the daytime there is little in the scenery to please the traveller until the immediate neighbourhood of Paris is reached, and a most imperfect idea is formed of the landscape attractions of

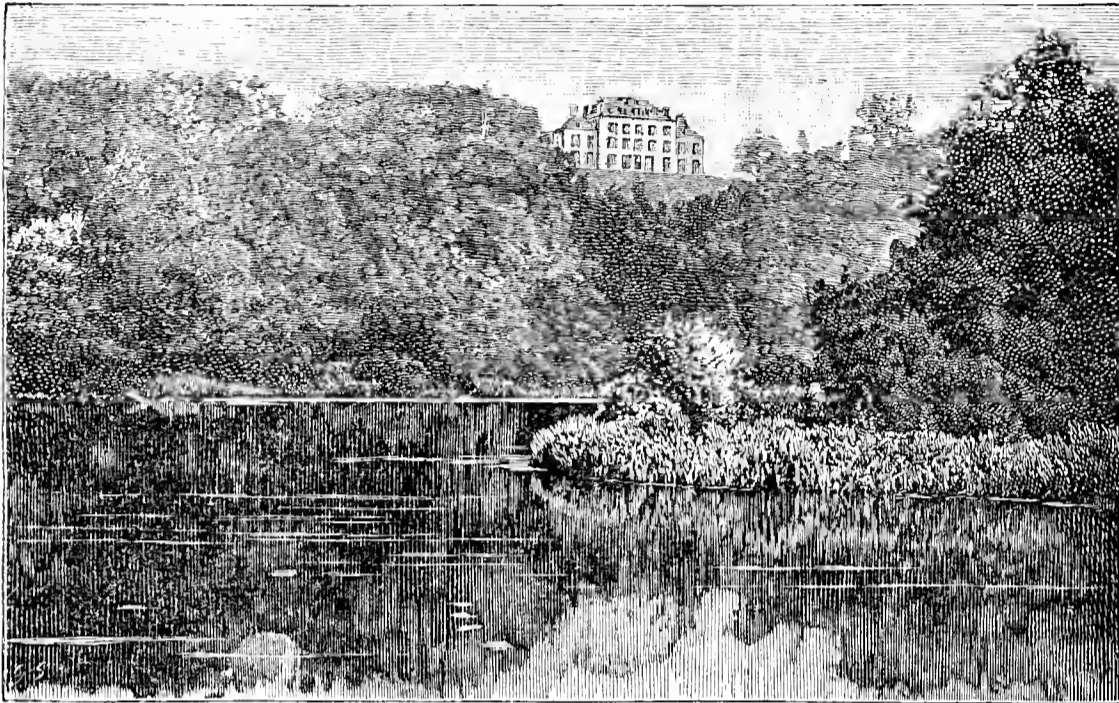

FIG. 52.—THE CHÂTEAU DE GOUVILLE, NORMANDY.

France. The route via Newhaven and Dieppe gives a five or six hours' sea passage and three or four hours longer total journey; but considerable compensation for this expenditure of time is derived from the character of the country passed through on the French side of the Channel, and beyond that it is materially cheaper, and few travellers either for business or pleasure in these days can afford to disregard this. Even in February on a bright sunny day the beauties of picturesque Normandy are very apparent, and sufficient could be seen in my journey from Paris to Rouen to create a very earnest desire to revisit so delightful a district in the summer or autumn months. Friends who have spent a week or two in a walking tour speak most enthusiastically of the pleasure they derived from their "invasion" of Normandy, and my experience, brief as it was, fully confirms their eulogies. We are accustomed to regard our own charming county of Kent as one of the most varied in our island, and the familiar designation "the Garden of England" fairly indicates the popular appreciation in which it is held. Normandy is, as it were, a repetition of Kent on the opposite side of the Channel, but with its characters more strongly developed and every feature more clearly defined; there is, perhaps, less of the smoothness and rolling undulation, with more of the bold and the picturesque. That, at least, was the impression produced upon my mind in journeying both by rail and road, while to it is added the quaintness and the interest of an ancient nation so closely associated historically with our own. No Briton who retains a memory of an early smattering of history can visit Normandy without experiencing much more than an ordinary interest in a foreign county, and this will be still further increased by observation of the points of resemblance still existing between the peoples. The intercourse following the Norman Conquest existed so long that there could not be otherwise than an approximation in customs and habits with the greatest tendency of course to the national character most strongly marked at the time. There can be little doubt that much of the foundation of the English national character—independent boldness and hardihood—is derived from the Normans; and one other point also cannot fail to strike a visitor to Normandy, and that is there is more of the home life of our own country districts than in these portions of France with which the average tourist is more familiar.

THE ROUEN DISTRICT AND ORCHARDS.

However, the object of these notes is not to provide an elementary dissertation upon Norman history, but to refer to something more strictly within the province of the *Journal of Horticulture*, a celebrated garden and its surroundings. Favoured with an

invitation from the Comte de Germiny to visit his garden and collections of plants at the Château de Gouville, one beautiful morning found me at Rouen station as the completion of the first stage of my journey thither. Time did not admit of much delay, and after a hurried glance at the quaint attractions of Rouen, which has been compared to "a Manchester without smoke," but seems to me more like "a purified Sheffield" as regards the hilly character of its scenery, I was soon on the road to Gouville. The best vehicle obtainable was an antiquated structure to which was

yoked a horse of substantial dimensions and seeming strength, but which was subsequently found to be afflicted with an indisposition to active exercise quite in proportion to his size. "Monsieur le Cocher" too professed to have an intimate acquaintance with the road that an hour's experience proved to be purely imaginary; but owing to these two rather unpropitious circumstances I enjoyed a prolonged journey through a delightful country on a clear sunny spring-like day such as we in England seldom have in February. From the station the road ascends a steep hill until an elevation is reached commanding a fine view of Rouen and the Seine, which there assumes the character of an imposing stream very different from its Parisian aspect. Thence we proceed through an agricultural district—well-farmed lands, with neat hedges, and every appearance of active supervision attended by prosperity. Through the Apple orchards too our steadfast steed leisurely conveys us, and we have vistas of trees of all kinds from hoary lichen-clad veterans of the West of England or Irish type down to vigorous trees in their prime, but all look in good bearing condition, and it is said the crops from some of these old trees are enormous in favourable seasons. It is noticeable, however, that little planting seems to have been done for years, and there will

come a time when the old orchards are exhausted and an important industry will be ruined. At present the supplies are good, and cultivators appear content, except that they do not obtain so good a market in England as was at one time the case before American Apples were imported so largely. Now, however, the manufacture of cider receives increased attention, and a profitable demand has arisen for well prepared samples of this useful product. I have never had an overpowering inclination for cider in England, and very seldom have the samples tested caused me much satisfaction—frequently, in fact, quite the reverse. The Normandy cider, however, which I had the privilege of tasting, was a beverage of a very different character, and I should think in moderation it is as wholesome as it is agreeable.

Another characteristic of the district which is sure to arrest attention when the trees are leafless, is the abundance of Mistletoe growing in dense clusters on large and small trees at all heights. We are told every Christmas when the crates of this important parasite appear in such numbers in the London markets, that a considerable proportion of it comes from Normandy, and it has always been difficult to understand where such extensive continuous supplies could be procured. A few days wandering about Rouen and some other large towns in that part of France would reveal the secret, for the supply must be almost inexhaustible. I endeavoured to ascertain whether any systematic attempts are made in propagating the Mistletoe, but could obtain very little definite information. In some places it is evident that cultivation has been and still is carried out, for the bunches appear at a regular height on a series of trees, but in the majority of cases it is thought the birds are the only means by which it is propagated, and it is only the English demand that saves it from extermination as a pest. Whether it be regarded as a "weed," or as a "cultivated plant," young people need have no fear that a peculiarly English custom will fall into abeyance from a deficiency of material, for Normandy can supply their requirements for years to come.

Quitting the orchard region the road our guide thought proper to take led us along steep hillsides down into deep tree-clad valleys, and through quaint old towns like pictures from a distant age. Once or twice man, horse, and vehicle were condemned in unsparing terms, but after all the man was freely forgiven, for he must have an eye to landscape effects, or he would never have selected such a road. From several parts the scenery was exquisite, and when the trees are clothed in the green tints of spring or the varied hues of early autumn, one could easily imagine how greatly its beauty would be augmented. The bold hills, the abundant trees, and the fertile valleys with their bright little streams form the features of

this district in constant succession, and we would willingly linger still more on the way. But February days are short, and we must hurry on—that is, we get out and walk while our interesting quadruped follows meditatively; and after various directions, misdirections, and mutual misunderstandings, the ascent was at last commenced that leads to the heights of Gouville. There the Comte de Germiny and his gardener were awaiting our long-delayed arrival. The coachman was severely reprimanded, some much-needed refreshment lightened our spirits, and an inspection was shortly commenced of

THE CHÂTEAU DE GOUVILLE GARDENS.

The Château (fig. 52) is situated at an elevation of several hundred feet, overlooking a spacious valley with park-like, densely wooded expanses beyond on the opposite hillsides, while at the base is a lake of considerable dimensions, the apparent source of the stream which runs through the long valley in the direction of Rouen. The gleam from the water imparted a welcome brightness to the landscape, lighting up the depths of the valley and contributing an important item to the picture. The view from the open lawn slopes in front of the Château is, in fact, most varied and beautiful, quite English in its chief characteristics, and everything is in accord, the building itself being a substantial, handsome structure, evidently built for convenience as well as for ornament. The shrubberies and tree plantation around are all in due proportion, heavily massed for effect, and not thinly scattered with a meagre hand. Unfortunately the winter has left disastrous marks upon many valued shrubs, and much reduction, with replanting in some cases, will be necessary to restore the wonted condition. The Gouville estates cover a large extent of land, and are exceedingly well managed, one speciality beyond the arboricultural department being pisciculture, which is one of the Comte de Germiny's hobbies, and he has made a systematic study of the subject, as evidenced by the experiments undertaken on a large scale in different parts of the valley. We cannot stay, however, to refer to these now, for the garden and the Orchids are the principal objects of the present visit, and we therefore hasten to the range of glass houses to inspect the treasures they contain.

On this side of the Channel we are familiar with gentlemen's gardens where plants are extensively cultivated under glass, but on the Continent they are much less numerous, and as a general rule the best examples of plant cultivation are to be found in nurseries. Well-grown large private collections are the exception, not the rule as here; and the Gouville plants must take high rank amongst the exceptions both as to culture, number, and value. Throughout the whole establishment it is evident that the first requirement is the healthy condition of the plants. It has not been the object, as is so frequently the case in such places, merely to form a botanical collection of as many species or varieties as possible. Selection has been made of the more distinct, attractive, and interesting; and the endeavour has been to obtain these in their best condition as fully developed specimens. In pursuit of this object a large share of success has been achieved, and some of the results will now be briefly noted.

There are three large blocks or series of houses, two of these being occupied with Orchids and other plants; the third range (fig. 53) comprising the fruit houses. The structures are of various sizes and shapes, several of iron framework with curvilinear roofs which seem to be the favourite form on the Continent; others are neat compact spans of the usual plant-growing type, but all alike are light and elegant, and two or three are exceptionally spacious and well constructed. Passing through some smaller houses filled with capital specimen Cinerarias and Cyclamens of excellent varieties, one of the principal structures is reached devoted to Orchids arranged in a most artistic manner. It is a lofty wide span-roofed house with stages at the side, but the centre is covered with Selaginellas, Ferns, and Bromeliaceous plants, amongst which are placed the larger specimen Orchids; some are raised on pedestals, and many others are suspended in baskets from the roof. Associated with the Orchids are some fine Nepenthes and Anthuriums, and it can be readily imagined that with abundance of Orchid flowers expanded the effect produced is extremely beautiful. Besides, the conditions are exactly those required; the Fern rockeries, streamlets, fountains, and undergrowth of Selaginellas maintain a uniform healthy moisture which is constantly reaching the foliage and roots.

The plants as a result are thriving vigorously and flower just as freely. Very conspicuous were *Dendrobium nobile majus* with sixty flowers and *D. Lucechianum* with forty, both excellent types. A distinct *D. Freemani* and many other *Dendrobiums* were also flowering. *Cœlogyne cristata alba*, *Lycaste Skinneri alba* with eleven large flowers, the elegant *Saccolabium illustre*, the remarkable *Vanda Cathcarti*, *Angraecum sesquipedale*, and with *Aerides Phalenopsis*, and scores of other handsome plants contributed liberally to the floral display. In the central bed an unusually fine specimen *Vanda Batemani*, 8 feet, was a perfect giant amongst its relatives, and was evidently thoroughly at home in a basket, standing amongst the moist Ferns and rearing its stem nearly to the glass. Scarcely less noticeable, too, suspended from the roof was *Vanda suavis*, the roots of which had descended in a dense thicket, some 6 or 7 feet to the bed beneath. A stately Bromeliaceous plant, *Chevallieria Veitchi*, was also noticeable in the central bed, and had a fine spike of its richly coloured scarlet bracts. This plant had been in flower for over a year—a sufficient indication of its usefulness, and it is surprising that so many valuable decorative plants in this family are neglected in England. Another Bromeliad of quite a different type but not less beautiful is *Schlumbergeria Lindeni*, which celebrates in its generic title the name of the Comte de Germiny's son-in-law, M. Schlumberger, a resident in the district, and fully as enthusiastic a lover of horticulture as the Comte himself. This plant has finely tessellated leaves, 2 or 3 feet long and about 4 inches broad, the transparent green lines on a bright green ground colour having a charming effect.

The tropical Bromeliads succeed well under the same conditions as the Orchids from the hottest regions. The *Anturiums* thrive in the same house, two specimens of *A. Veitchi* having thirty or forty well developed leaves each; *Anthurium Andreanum*, too, is a special feature both in the large house and in a warm porch, and this handsome plant first flowered at Gouville. They are grown very strongly, and it is frequently necessary to behead them, the stems producing roots quickly, and from thirty to forty fine spathes are produced on each large specimen every year. Upon the shelves are abundance of smaller plants, with *Phalenopsis* in capital condition, an example of *P. amabilis* having eleven grand leaves, each 5 inches in diameter. In an adjoining house of this range there was a brilliant display of *Ada aurantiaca*, and in contrast with these *Odontoglossums Pescatorei* and *crispum*, *Cypripedium villosum* and *insigne* are profusely flowered, at a time too when flowers are always scarce. *Cœlogynes*, *Sobralias*, *Odontoglossums*, *Cymbidiums*, *Masdevallias*, and *Lælias* fill neighbouring houses, many large specimens of choice varieties being represented.

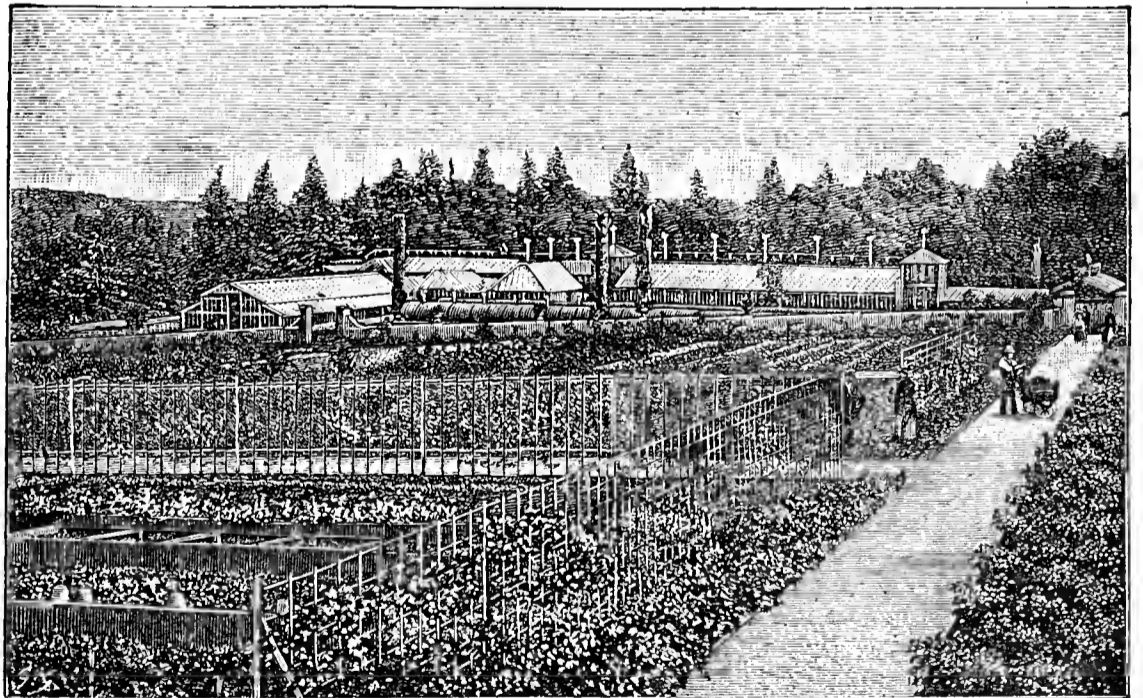

FIG. 53.—GOUVILLE GARDENS.

Clivias, *Camellias*, large specimen *Azaleas*, *Acacias*, and various hardwooded plants have much space devoted to them, and unlike specimens of the ordinary exhibition character these are not so rigidly trained as to destroy their natural habits; and they are, moreover, in the freshest and most healthy condition imaginable. In still other Orchid houses there is a wonderful collection of *Cattleyas*, especially rich in varieties of *C. Triaræ*, *C. Mendeli*, and *C. Mossiæ*—a trio of most useful types. *Odontoglossums*, including *O. vexillarium*, are remarkably well grown, and the hot continental

summers are greatly against success with these plants; very seldom indeed do we see them in satisfactory condition. At Gouville, however, they are as strong and healthy as could be wished, and close attention to their requirements and to ensure freedom from insect pests is the only secret of the success. Various small houses are devoted to *Caladiums*, *Bertolonias*, *Anthuriums*, and propagating purposes, not the least important of which is the raising of seedling hybrid Orchids, of which numbers have been obtained, and from very interesting crosses.

To the fruit garden, which comprises a large collection of trained trees, the vineries the Peach and Strawberry houses, some notes will be devoted on another occasion, when I hope to supplement them by some further observations on the fruit culture of Normandy. My thanks are due to the Comte de Germiny for the kindly reception he accorded me, and for the generous invitation to visit Gouville at a more favourable time of year. To his skilful gardener, M. Vincent, I am also indebted for courteous attention during an extremely pleasant though brief visit.—LEWIS CASTLE.

UNFORCED DWARF RHUBARB.

I HAVE read with much interest (in the *Journal of Horticulture*, March 26th), a short paper on the earliness of Rhubarb, by my obliging correspondent, Mr. N. H. Pownall, of Lenton Hall Gardens, to whom, in August, 1889, I supplied five buds of my Yaxley Rhubarb, with cultural directions. I am glad to infer that the kind stands well in the opinion of so expert a Rhubarb grower, who has written, as I apprehend, only of natural Rhubarb unforced in any way.

Mr. Pownall states that this year he began to pull the Yaxley Rhubarb on 23rd March, and gives the dimensions of the stems, which for so young a plant prove a thoroughly skilful treatment. Since I first noted down facts relating to my Rhubarb I have no record of its being so late in producing as it has been this year. Last year, 1890, it was indeed late. The first supply that was then brought to my table was on Feb. 22nd; but this year the first I had pulled was in March, the usual time for its being ready being as I stated (*Journal of Horticulture*, July 5th, 1888, page 10), on St. Valentine's day. To gardeners who know how greatly all out-of-door plants are influenced by the weather, and who remember the slight rainfall (black or white) in last December, January, and February (February being nearly rainless), the unusual lateness of the plant this year will be no surprise, for my first gathering in 1891, which was of 3 lbs. weight, was on Thursday, March 5th. Since then I have had it continuously, taking as much as 12 lbs. at one time. My Rhubarb is grown in a bed perfectly open and exposed to all weathers, and perhaps on this account has come into bearing some eighteen days earlier than Mr. Pownall's supply.

I have only to add that I shall be happy to show anyone the Yaxley Rhubarb as it grows any week day by appointment, and as I am a busy man preferably between 9—10 A.M. We are but one and a half mile distant from Mellis station.—W. H. SEWELL, *Yaxley Vicarage, Suffolk*.

ON THE EFFECTS OF URBAN FOG UPON CULTIVATED PLANTS.

[Preliminary report by Dr. F. W. OLIVER, presented to the Scientific Committee of the Royal Horticultural Society, March 24th, 1891.]

(Concluded from page 269.)

V. *Physiological and Microscopic Work*.—The opportunity has been taken to have careful drawings prepared, exhibiting typical cases of damage attributable to fog. I have now a considerable collection of examples from the Royal Gardens, Kew, and elsewhere.

Large supplies of injured plant organs have been forthcoming and have been submitted to chemical analysis. These include the leaves of soft and hardwooded plants and of Orchids, also the leaves of *Cattleyas* and *Dendrobiums*, and the flowers of *Cattleya Trianae*. The results of these analyses will be valuable for publication when similar analyses of the uninjured parts have been obtained.

The histological characters of injured tissues, as exhibited by the microscope, have been carefully studied and drawings and notes made. Many of the facts thus obtained are still obscure and require experimental elucidation. In the case especially of Orchid flowers the distribution of the stomates would seem to have a definite bearing on the distribution of the fog injuries. In both *Phalænopsis Schilleriana* and *Cattleya Trianae*, for example, the sepals are much sooner and more easily injured than the upper petals and labellum. Microscopic examination shows that whilst stomates are frequent on the sepals of both plants, the petals have relatively few, comparing equal areas of surface. The labellum of *Cattleya* in many cases was found to be destitute of stomates. This part is usually the last to show actual injury. The action of the stomates here is probably to afford increased access of sulphurous acid to the part, which then directly attacks the soft, unprotected cells within.

The effects of a slow current of fog and of sulphurous acid of various dilutions upon living protoplasm have been very carefully followed under the microscope. The procedure in both cases was identical. A slow current was drawn by aspiration through a specially devised chamber on the stage of the microscope. The transparent root hairs of *Limnium*, with their actively rotating protoplasm, and portions of

the leaf of *Vallisneria* were chiefly used. The effect of dense fog resembles very nearly that of dilute sulphurous acid. The rotating protoplasm is found gradually to swell up and invade the vacuole, its defined margin becomes less and less distinct. Finally, the protoplasm becoming granular, and breaks down entirely, the rotation during the process gradually slowing, ultimately ceasing. The whole process with fog occupies several hours. This line of research will be continued during the summer with sulphurous acid and other substances.

A considerable series of experiments has been made in the closed chamber, which was constructed for this, as also to serve as a fog-proof chamber for cultural purposes. As a fog-proof chamber it has not been used so far. At an early period I found that certain defects which could not be remedied forthwith disqualified it for this purpose. Since then it has served as a closed experimental case, in which plants were exposed to sulphurous acid gas of varying strength. It was possible also to draw off a current of the special atmosphere, to which the plants in it were exposed, and study its action upon living protoplasm under the microscope. A comparison could thus be effected between the macroscopic and microscopic phenomena simultaneously. The amount of sulphurous acid present was under control, and frequent estimates of its amount was made by aspirating air from the chamber through permanganate, the volume required to decolourise being recorded. These experiments are not yet concluded, but it can be definitely said that increase of temperature, other things being equal, aggravates the poisonous action of the sulphurous acid, a difference of a few degrees of temperature being apparent.

During the summer these experiments will be continued. An attempt will also be made to estimate the influence of varying amounts of sulphurous acid gas and other poisons upon the plant functions—transpiration, assimilation, and respiration.

VI. *Possible Remedial Measures*.—It is too soon to speak of these with confidence until a more complete knowledge of all the conditions of damage to vegetation from this source have been obtained. Many of the results obtained in the physiological inquiry are still obscure, and it will be necessary to carry out series of experiments before some of these are elucidated. Since October I have had opportunity of inspecting many collections of stove and greenhouse plants, and growers have most freely communicated to me any methods which they employ to combat the fog. The placing of canvas, &c., over the plant houses in foggy weather has in some instances mitigated the damage, the fog being in this way to some extent filtered. The regulation of the temperature has an important bearing. Some cultivators keep the temperature during a fog as low as can be done, having regard to the safety of the collections in the houses. Others raise the temperature in the hope of, to some extent, excluding the fog. There can be no doubt that a high temperature augments the damage, whilst a lower one, to some extent, hinders it.

Sulphurous acid acts more violently and immediately in a hot than in a cool atmosphere. Again, in a long, dark fog, heat unnecessarily stimulates the plants when (from the prevailing darkness) their transpiring capacity is limited. Everything should be done to tax the vegetative organs of a plant to the least possible extent when any of the vital functions are interfered with, as in dull, foggy weather. In this connection it is important to supply water to the roots with a sparing hand. Heat and moisture at the roots stimulate absorption, whilst the leaves are unable to throw off an excess of moisture, as they can in sunny weather. I know that in many establishments these precautions are taken, and I believe with relatively beneficial results. The evidence on which this opinion is founded is derived (1) from observation of the behaviour of plants under different conditions of cultivation during foggy weather, (2) from actual experiments in which the special conditions were under control.

The action of a continuous drip of moisture on foliage in a closed experimental chamber, containing small quantities of sulphurous acid gas, is to mitigate the immediate damage so far as the leaves, thus continuously moistened, are concerned.

The degree of humidity in a house, where sulphurous acid is present, is a matter well worthy of attention, and one which I have under observation. The problem is a complex one, and I hope to be able to communicate my results later.

In a dry atmosphere the sulphurous acid, for the most part, acts as such directly on the living protoplasm. In a humid one it is more rapidly oxidised into sulphuric acid, which has an entirely different action, I apprehend, on vegetation, histologically distinct from the first mentioned. It would, however, be improper for me to draw any general conclusions from observations as yet incomplete.

Another measure, which may be ultimately shown to be practicable, is that of absorbing the most poisonous substances in the fog by using some substance as an absorbent, itself innocuous to vegetation.

A more practical method is to keep the fog out of the plant house, rather than to try and neutralise its action after it has entered. So long as cultivators grow plants susceptible to the impurities of fog in houses with open glazings in winter time, of course this is impossible. It is to be hoped some metropolitan grower will pluckily face the situation and construct a range for winter use, which can be made at will absolutely fog proof with close glazing, triple doors, and padded ventilators. The horticultural engineer could easily manage this. Filtered air could be supplied, as it is to the House of Commons, by pumping through several inches of cotton wool or by some other method; whilst the illumination could be supplemented by a judicious use of the electric light. Hervé-Mangin showed, so long ago as 1861, that a plant could manufacture organic matter by the aid of artificial

light, and the results of Siemens' more recent experiments are familiar.

An ingenious person has suggested to me an alternative method for excluding fog without interfering with ventilation, by an arrangement of tricklers, such as one sees on ice factories in summer for cooling. In this way a greenhouse might be completely enveloped in a thin mantle of dilute hydrogen peroxide, permanganate of potash, or other absorbent, which could be collected in gutters and pumped up again and again. A considerable objection to this plan would be the liability of the absorbent to freeze in cold weather, fog and frost being very frequently concomitant.

In conclusion, I have to thank my colleagues on the Committee for their constant help and sympathy. To my Assistant, Mr. F. E. Weiss, B.Sc., I am indebted for his continuous devotion to the research; without his aid the investigation could not have progressed as it has. For the making of the chemical analyses of injured tissues, &c., as well as for advice on many questions of a chemical nature, I must thank my former pupil, Mr. J.T. Leon, B.Sc., now lecturer in chemistry at St. Mary's Hospital.—
F. W. OLIVER.

WATERING VINE BORDERS.

THE substance of Mr. Young's article on page 258 of the issue for April 2nd is similar in every respect to what I wrote on page 311, October 9th, 1890. I should not have alluded to this but for the fact that Mr. Young either reads carelessly or possesses a very convenient memory. I referred on page 311 to a note of his about watering Madresfield Court Vines in pots three times a day. Mr. Young also alludes to the same matter and says, "Some time since a well-known writer stated that something must be radically wrong with the treatment of the Vines when they require attention in watering three times a day. I wonder he did not extend his observations to Strawberries in pots, as one is on a par with the other." Now, Mr. Young, I did allude to Strawberries in pots, and with the Editor's permission I will reproduce what I wrote on page 311, for it cannot be too forcibly impressed upon cultivators of either fruit or plants. The following is what I wrote, "It cannot be good either for the Vine or the lasting properties of the border to be continually pouring water into it. The same applies to Vines grown in pots, and we cannot help thinking that something is radically wrong when two or three applications are needed daily. Our experience with plant growing in pots tends in the opposite direction. The longer the soil about the roots of the plants can be kept in an intermediate state for moisture without recourse to the waterpot the better. Even that water-loving plant the Strawberry, when grown in pots can have too much water; the fewer the applications, provided the soil remains moist, the better is the flavour and the finer the fruits. This we demonstrated during the season of 1889, when some hundreds were plunged to the rim to prevent evaporation, while equal numbers were grown without to test the value of the two systems."

I have again and again in the pages of this Journal written on the subject of watering Strawberries, Vines in pots, and plants in general, and always tried to impress the importance of not overwatering, and at the same time of giving as few applications as possible consistent with keeping the soil moist. Various methods have been pointed out by which this end can be accomplished.—WM. BARDNEY.

MISS ORMEROD'S WORKS.*

WE have received for review the second edition of the "Manual on Injurious Insects, and Methods of Prevention" of this accomplished entomologist and indefatigable worker; also the fourteenth annual "Report of Observations of Injurious Insects" during the past year; and we have further on our table "Observations on Some Injurious Insects of South Africa." Of the first, we may say it has almost overgrown its description as a manual or small handbook. It is really a substantial volume of 410 pages, admirably printed, copiously illustrated, and crowded with interesting and instructive matter from beginning to end. It is a standard work, valuable for reference, and should have a place on the bookshelves of gardeners and farmers.

The Report extends to 144 pages, and contains a number of illustrations of various insects, and other enemies to plant and animal life. Special attention

appears to have been given to orchard moths, and we find the most complete and precise account of the destructive Winter Moth (*Chimatobia*), and methods of preventing and destroying it, that has hitherto been published. Records of experiments with all known remedies, both in this country and America, are given in a concise form; and more can be learned about Paris green, London purple, and other remedies than can be found elsewhere. The subject of cecidomyid worms, as these minute nematoid worms are found to be the cause of disease in cereal and leguminous crops; and to a species, *Aphelenchus fragariae*, hitherto undescribed, has been traced the destructive malformation in Strawberry plants that is too prevalent with some cultivators, entailing on them serious loss. We are privileged to use the accompanying illustration of Dr. J. Ritzema Bos, Professor at the State Agricultural College, Wageningen, Netherlands, which represents a plant that was sent to him by Miss Ormerod, in consequence of the cecidomyid she discovered in it differing from the typical kind, *Tylenchus devas-*

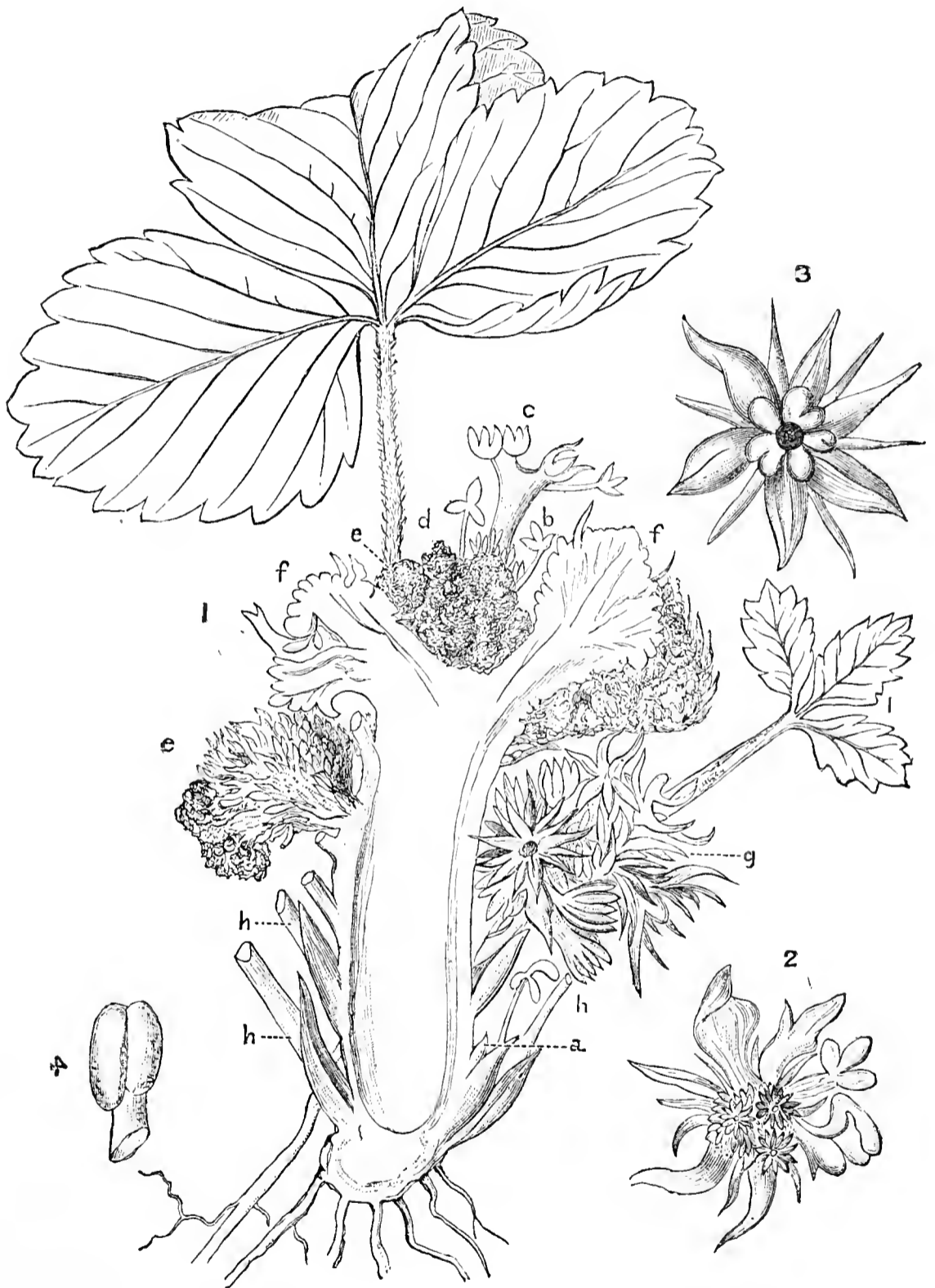

FIG. 54.—"CAULIFLOWER DISEASE" IN STRAWBERRY PLANT DISEASED BY INFESTATION OF APHELENCHUS FRAGARIAE, Ritz. Bos.

DESCRIPTION OF FIGURES.—1. Strawberry plant infested by *Aphelenchus fragariae*: (a) Sealy buds developed in the axil of normally developed leaves—h; (b) A very swollen stem, with (c) Rudimentary flower buds always remaining closed; (d) Accumulation of rudimentary buds at the base of the branch b; (e) Cauliflower-like accumulation of strongly branched and broadened inflorescent parts, with imperfectly developed flowers and sheathing leaves; (f) Section of similar Cauliflower growth; (g) Accumulated blossoms, partly rudimentary, partly abnormally developed, such as are shown separately in 2 and 3; (h) Portion of leafstalks of normally developed leaves; (i) Stunted leaves of fairly normal shape.
2. Monstrously developed blossom; outer leaves of the calyx narrow; inner calyx leaves more developed, some very thick and twisted, others branched, and a few trifid like ordinary leaves; the blossom appears to have split into three divisions, but the petals, stamens, and pistil of these parts have remained rudimentary and indistinguishable from each other.
3. Monstrously developed blossom; outer leaves of the calyx narrow; inner leaves of calyx well-developed, but a few of them twisted; petals of corolla stunted, and some of them twisted, and no sign of pistil or stamens.
4. Abnormally developed stamen.

* London: Simpkin, Marshall, Hamilton, Kent & Co., Limited.

trix, that infests other crops, arresting growth, and causing peculiar malformations. On examination of the nematodes in the Kentish plant, the Professor discovered that they belonged to the genus *Aphelenchus*, but distinct in species, and therefore he bestowed on it the name it bears.

The "Cauliflower disease" of the Strawberry is familiar to many gardeners, and Mr. Thomas May, a Kentish Strawberry grower, states in the Report that it ruined nearly half the plants in a 14-acre field. The cause of the disease now being discovered, perhaps in due time methods for preventing the attack may be discovered also, as in the case of the allied enemy attacking Oats and Beans, mixtures of sulphate of potash, sulphate of ammonia, and steamed bonemeal having proved serviceable.

Eelworms, highly magnified, as taken from Onion, Wheat, and Hyacinth plants, are admirably represented in the frontispiece to the Report, which is worthy of careful examination with the reference matter on page 48 of the work. The life size of the nematodes is a little more than the twenty-fifth part of an inch in length.

The work on South African insects consists of 115 pages, and is freely illustrated. It will be of service to colonists, and of interest to all students of insect life.

Miss Ormerod has evidently spared neither pains, labour, nor research in the preparation of her works, which bear the stamp of persevering industry, and they may be said to be as useful as they are attractively produced.



MARÉCHAL NIEL ROSE UNDER GLASS.

THE Maréchal Niel Rose in my greenhouse covers a space of about 11 feet by 15. It has on it about 600 shoots, and every single one has a bud or truss of buds at the end. I send you a specimen or two. They are not so fine as usual, but with such a crop one could hardly expect it. It is, I think, only by the system of pruning described in the Journal (cutting all away down to the horizontal branches at the base as soon as flowering is over) that such a crop can be obtained year after year.—W. R. RAILLEM.

[And then only by good management, which, judging by the specimens, has in this case undoubtedly been afforded.]

A MONSTER MARÉCHAL NIEL.

AT the present time a wonderful Maréchal Niel is flowering in the Vicarage Street Nursery, Warminster. It was planted April 16th, 1888, and made the first year after planting four shoots 25 feet long, giving over 200 Roses before being planted twelve months. Next year it produced shoots 30 feet long, giving over 2000 Roses for the year 1890. Now it is covering a roof space of 450 feet, and carrying over 3000 buds and blooms, and can be seen flowering within the next fortnight.—VISITOR.

ROSE SHOWS IN 1891.

- June 23rd (Tuesday).—Westminster (N.R.S.).
- „ 24th (Wednesday).—Richmond (Surrey) and Royal Aquarium.
- „ 27th (Saturday).—Eltham and Reigate.
- „ 30th (Tuesday).—Canterbury, Diss, and Winchester.
- July 1st (Wednesday).—Bagshot, *Brighton, Brockham, Croydon, and *Lee.
- „ 2nd (Thursday).—Farningham and Norwich.
- „ 4th (Saturday).—Crystal Palace (N.R.S.).
- „ 7th (Tuesday).—Gloucester.
- „ 8th (Wednesday).—Dursley, Hitchin, Sutton, and Tunbridge Wells.
- „ 9th (Thursday).—Bath and Woodbridge.
- „ 11th (Saturday).—New Brighton.
- „ 14th (Tuesday).—†Wolverhampton.
- „ 15th (Wednesday).—Ealing.
- „ 16th (Thursday).—Hereford (N.R.S.), Helensburgh, and Trentham.
- „ 18th (Saturday).—Manchester.
- „ 21st (Tuesday).—Tibshelf.
- „ 23rd (Thursday).—Worksop.
- Aug. 1st (Saturday).—Ripley (Derby).

* Shows lasting two days. † A three-days Show.

The next list of Rose Show fixtures will appear early in May.—EDWARD MAWLEY, *Rosebank, Berkhamsted, Herts.*

BEGONIA VERNON SYN. B. SEMPERFLORENS ATRO-PURPUREA.

EVERYONE knows how welcome was the *Begonia semperflorens rosea* when it appeared some ten years ago as a chance seedling found in a patch of the white flowering type, not to speak of the distinct coloured hybrids which, in various countries, have been obtained with it. From this race has originated a new and brilliant variety, for which horticulture is indebted to one of the good French practitioners, M. Vernon.

The *Begonia semperflorens atro-purpurea*, or *B. Vernon*, is—we may

state it without fear of exaggeration—one of the finest acquisitions of recent years. The *Revue Horticole* (1890, page 482) has given a description of it and shown its great decorative value. Of erect branching habit, the new variety resembles the parents, but has deep red flowers, and the leaves are bronzed and tinged with purple.

No doubt some of your readers visiting Paris last year and taking a walk through the fine Luxembourg Park will have noticed a bed of this brilliant variety which attracted much attention. The plants were raised by the skilful head gardener, M. Jolibois, who had been lucky enough to procure some seeds the first season. The plant excited so much admiration that M. Jolibois intends to grow several thousands of the variety in a bed near the Palais du Senat in the Luxembourg Park this year.

Of exceedingly easy culture, *Begonia Vernon* requires no more care and attention than its congeners with white and rosy flowers. The seed should be sown either in the autumn, in September, or in the spring, from February to May. The first method is usually resorted to only when it is desired to obtain strong plants capable of flowering very early in the year, but the plants require more attention than those raised at the spring sowing. They ought to be raised in a heated frame or house in pans or boxes. The soil should be light and sandy, and the seeds, which are exceedingly small, covered very lightly, or, still better, simply laid upon the soil, which is to be kept moist and shaded. It is a good plan to mix them with sand or charcoal dust before sowing. The seedlings are pricked out in pans or pots and placed in moderate heat, air being admitted in increasing volume with their growth, and the plants are prepared for planting out towards the end of May, or when the weather is favourable.

On the approach of the first autumn frost, if it is desired to enjoy the flowers for some time longer, the plants may be taken up and potted, standing them in a conservatory, where they will continue in beauty during several months.

In the above notes we only point out a few of the merits of this welcome novelty, which may easily be had in flower from the beginning to the end of the year. Messrs. Vilmorin-Andrieux & Co. are distributing the seed.—GEORGES LEGROS, *Paris.*

[A visitor to Paris during the past summer admired the bed referred to, and spoke in terms of high approval of this *Begonia*; a coloured plate in the *Revue Horticole* also well displays its purple tinted leaves and rich red flowers. In habit and floriferousness the plant exactly resembles *B. semperflorens rosea*, and gives promise of being a distinct acquisition.]

HORTICULTURE IN AMERICA.

[A paper by Mr. JAMES H. LAING, F.R.H.S., read at the Birmingham Gardeners' Association, March 9th, 1891.]

(Continued from page 271.)

PASSING on to the pleasure part of the Convention, we went on the second day by special train, in accordance with an invitation given by Mrs. Francis B. Hayes (recently deceased) to visit her estate in historic Lexington. Mr. Jas. Comeley, the head gardener, deserves credit for the perfection in which he keeps the beautiful grounds, and some magnificent specimen Conifers and timber were seen in the park, many of them of Japanese origin, which do not stand the English climate through the insufficiency of the sun to ripen them. The Araucarias and many of our best Conifers have to be protected against the severe American winter; in fact, are generally grown in tubs and wintered indoors. The next day we were guests of H. H. Hunnewell, Esq., at his beautiful seat in Wellesley, is considered to be the finest in the States. The glass houses were well stocked with Orchids, Begonias, and Fuchsias. Fruit houses were in good order—Vines, Peaches, Plums, and Figs, reminding us of a well-kept English establishment. The Italian garden, occupying a steep, high embankment, sloping sharp down from the pinetum to the Waban Lake, is well planted and arranged. The clipped shrubs, included are the Hemlock and Norway Spruce, White Pine, Retinospora, Junipers, and Irish Yews. The trees include Larch, American Beeches, Limes, and Norway Maples. The collection of Conifers, planted from the entrance gate to the mansion, were specially fine, and the Abies, Piccas, Arbor Vitæ, &c., in excellent condition. Japanese Maples were very fine, and Mr. Hunnewell's Rhododendrons must be well worth seeing during their flowering season. Many of these have, however, to be lifted before the hard wintry weather comes on, and are stowed away in cellars for the purpose till the following April, when they are planted out again. Mr. Fred. Harris, the head gardener, manages the estate well. The next day we numbered nearly 1000 persons as the guests of the Gardeners' and Florists' Club, and enjoyed a delightful sail in Boston Harbour and along the Massachusetts coast in the steamer "New York," followed by a banquet in the large skating rink at Nantucket Beach, and much speech-making. This closed the memorable Convention, and with my heartfelt thanks to the Boston Gardeners' and Florists' Club, and the many friends who showed me such kindnesses, I journeyed onwards.

Before I finish with Boston I should refer to the Arnold Arboretum, which covers about 164 acres. Here the Harvard College maintains a collection of all the trees, shrubs, and herbaceous plants that will thrive in the open air in this latitude. This comes under the department of Professor Charles S. Sargent, one of the highest authorities on arboriculture, and one of its best friends. The grounds are under the immediate charge of Mr. Jackson Dawson, who fills the position most creditably, and is fast making the Arboretum more renowned. The

Botanic Garden, Cambridge, although only about 8 acres in extent, is of great interest. The conservatories were chiefly devoted to collection of botanically interesting plants, and the same may be said of the grounds, which were tastefully arranged and well kept by Mr. Cameron. The collection of succulent plants is very fine. Messrs. Temple and Beard, Cambridge and Bedford Park Nurseries, were also worthy a visit, herbaceous plants, shrubs, and Conifers being grown in large quantities. *Pyrus Malus Parkmanni*, *Clematis Stanleyi*, Magnolias, and many plants I had not time to note, were grown successfully by this firm.

What a pleasure it is to enter the comfortable and well arranged carriage of an American railway! There is so much freedom that the time seems to pass quickly, whereas in Europe long railway journeys are always tedious. A modern train in America is a travelling palace, and costs from £30,000 to £40,000 to build. It includes bath rooms, sleeping rooms, restaurants, and reception rooms; and supplies ladies' maids, stenographers, type-writers, and barbers. It makes forty miles between stations, running hour after hour without stopping. Philadelphia is a splendid city, bounded by the River Delaware and another. It is well laid out, and has several fine buildings. An old acquaintance, Mr. Charles Evans (of Rose fame) kindly showed me over the magnificent Town Hall. My first call was at that true type of a business man, Mr. Wm. Dreer, at his store in Chestnut. I visited his establishment at Riverton, and was charmed with the neatness and system, and never saw Palms and Ferns of all kinds growing so vigorously. Luckily I found genial Mr. Robert Craig, one of the most popular florists in America, at home, and throwing his duties to one side on my arrival, he at once guided me round. Palms are grown here in large quantities, as also all the best marketable Ferns. Quantities of *Pandanus Veitchii*, *Crotons*, *Dracenas*, *Ficus elastica variegata*, *Asparagus plumosus*, *Smilax* (employed so largely in sprays in the States for decorations), and a host of other plants are grown. Roses and Carnations were grown largely for cut flower work. Raising new Chrysanthemums from seed is now a hobby with Mr. Craig, and I noticed numbers of promising seedlings. *Mrs. Alpheus Hardy* was planted out in the benches in a house, and only one stem being allowed to come. I have seen this variety planted out by several different florists, and it appears to grow well and vigorous.

Mr. Craig drove me through Fairmount Park, which is the largest city park in the world, covering 3000 acres, and its roadways thirty-two and a half miles. I was particularly struck with its natural beauty, its position having been well chosen, and it is well timbered. It was here in 1876 that the Centennial Exhibition was held. The horticultural building is a charming structure, now used as a conservatory for tropical and other plants, and around it is a large area of ground kept in admirable order by the Superintendent. Several large oval beds of splendidly coloured *Crotons* of the broad-leaved varieties, *Cannas*, and other well arranged beds of *Cacti*, edged with *Alternanthera* and *Echeverias*, looked well; so also did the *parterre* bedding. Mr. Charles Miller, Superintendent, is to be congratulated upon the taste displayed. I also visited Gerard College, the Hon. John Burton, and Mr. E. Lonsdale, each of whom had some floral attractions. I also called on Mr. Dan Farson, Secretary of the prosperous Pennsylvania Horticultural Society, who showed me around the fine city of Philadelphia. The Society has a splendid horticultural hall in the centre of the town, every convenience and accommodation being offered to render success certain.

After calling on Mr. Becker, years ago in the employ of my firm, a florist of considerable ability in the cultivation of Roses for winter cut flowers, I visited Mr. C. F. Evans, well-known as the purchaser of *Roses Her Majesty*, *W. F. Bennett*, *Meteor*, and last and one of the best *Mrs. John Laing*, who drove me out to his large and well kept establishment, where I received every hospitality from the host and hostess. Mr. Evans has mastered the cultivation of the *Roses* to a nicety. His ranges of house were in first-class order, and the *Rose* in fine health. I never saw H.P.'s doing better. My friend is a great advocate for steam heating, explained by the late Mr. Peter Henderson as follows:—"Two years ago, to satisfy myself of the relative merits of hot water and steam heating for greenhouse purposes, I erected a *Rose house* 350 by 20 feet. This I heated by steam alongside another *Rose house* of exactly the same dimensions heated by hot water. These have given me an opportunity for a comparative test, and I find the result in favour of steam; first, that it saves 25 per cent. in fuel; second, that our firemen say that steam boilers require less labour; and third, that the steam pipes, by the use of valves, are more easily controlled than the hot-water pipes, but above all it must be certain, on a large scale at least, heating by steam must be cheaper than hot water. From our experience with steam, I believe that, whenever greenhouses are erected to the extent of 5000 square feet of glass surface, steam should be used in preference to hot water; if for small areas it may be that hot water would be best. As far as the health of plants is concerned there is nothing to choose, for although a steam pipe with a low pressure radiates at from 212° and over, and a hot-water pipe at about an average of 160°, yet at 6 inches from either pipe the temperature is almost identical and radiation is rapid; anyone doubting this can easily test it by the thermometer. Leaving out the question of the cost of boilers, which ought to be the same for the amount of work to be done, we find that a 1½-inch pipe, when heated by steam, does almost exactly the same amount of work as a 4-inch hot-water pipe; at present prices the former costs 6 cents per foot, while the latter costs 20 cents. Thus, the piping costs three times more for hot water than for steam, but so far there has been comparatively little difference in estimates between the two, owing probably to the steam heating of greenhouses being in so

few hands." I made several other calls at the leading florists, missing with regret, however, through pressure of time, an eminent, and I might say, the leading Chrysanthemum grower and raiser, Mr. W. K. Harris. To this gentleman's exertions and skill we owe many excellent American varieties.

(To be continued.)



FRUIT FORCING.

PINES.—*Early Started Fruiting Plants.*—Those started into fruit early in the year are fast approaching the flowering period, and will be benefited by an occasional sprinkling at the time the house is closed; but when the flower opens the dewing must not be practised. The foliage being as yet tender, it will be desirable in the case of houses with large panes of glass to afford a slight shading for an hour or two in the hottest part of the day for a few weeks until the foliage becomes inured to the sun's influence. When the flowering is over the fruit will advance rapidly if the roots are in good condition, and plentiful supplies of weak liquid manure will be requisite. Attend to ventilating early in the morning, commencing when the temperature is at 80°, and closing at 85° with sun heat. Keep the atmosphere moist when the house is closed, the bottom heat steady at 80° to 90°, the night temperature 70°, and 75° by day artificially. As soon as the suckers appear remove all except one to each plant.

VINES.—*Early Forced Vines.*—Early Grapes may be had in creditable examples from Vines in pots, but better results are often had by planting the Vines out in beds, with hot-water pipes in a chamber or covered with rubble, as in growing Cucumbers or Melons. The Vines, however, require a greater depth of soil. This is sometimes made an excuse for dispensing with bottom heat, but it ought not to have countenance in the case of Vines grown in pots, or planted out for starting in October or early November for affording ripe Grapes in March or early April. Nothing favours early forcing operations so much as gentle heat at the roots. The borders or beds must be 3 to 4 feet wide, about 2 feet deep, unless there be a chamber, so as to admit 6 to 9 inches of rubble over the hot-water pipes, and 15 to 18 inches depth of soil. Vines being raised from eyes, or cut-backs, will need to be forwarded in another structure until the Grapes are cut. These being ripe in March or early April will be off by the end of April or early in May. The Vines that have fruited are cleared out, fresh soil is placed in the beds, and the Vines, after the soil becomes warmed through, are planted at 27 to 30 inches apart. If they have made much progress, but are not root-bound, they may be turned out, firming the soil about them, and supplying water freely. If in small pots they should be disentangled and the roots spread out, but weakly Vines are of no use for work of this nature. Turfy loam, with an admixture of one-sixth of old mortar rubbish, forms a suitable compost, adding a quart of steamed bone meal to every bushel of soil, or a similar quantity of some approved fertiliser. Manure can readily be given as a mulch or in liquid form. Train the canes near the glass, just keeping their principal leaves clear of it, then the wood will be short-jointed and thoroughly solidified. Pinch the laterals at the first joint, and to one of subsequent growth. Almost any amount of vigour can be had by encouraging the laterals; but this is not desirable, for the main object is to have as much matter elaborated and stored in the cane as possible, concentrating the forces on the principal leaves, so as to insure the perfect formation of the buds in their axils, then the crop of the following year will be assured. The principal leaves must not on any account be prejudiced by laterals. Stop the canes at 6 to 8 feet of growth, and if disposed to push laterals strongly at the joints immediately below the stopping, pinch them closely, allowing the laterals lower down the cane to extend a little, so as to appropriate the surplus sap and cause that part of the cane to thicken equally with the upper part. Under good treatment the Vines will make canes like walking-sticks, with eyes like nuts, and will be as much under control as Vines in pots; they may be matured so as to be ready for starting by late October or early November. In this method the root action is considerably extended as compared with Vines in pots. The Vines are taken up after fruiting, as with early fruited Vines in pots, treating them as annuals. Cut-backs are much the best for treating in this way. The varieties of Grape Vines suitable for this method of culture are *Black Hamburgh*, *Foster's Seedling*, *Buckland Sweetwater*, and *White Frontignan*. *Madresfield Court* is excellent for forcing, and where *Muscat* flavour is wanted *Black Muscat*, commonly known as *Muscat Hamburgh*, should be grown. It forces admirably, and ripens along with the varieties named. Though liable to have stoneless berries, the quality of fruit is unsurpassed by any other Grape.

Grapes Ripening.—The berries swell considerably after colouring commences, and to ensure the full swelling of the fruit a genial condition of the atmosphere must be maintained. A parching atmosphere is neither good for the health of the Vines nor insures the perfection of the Grapes in size, colour, or quality. Water the inside border with tepid

liquid manure and cover the surface with an inch of rather short, spent, but not soapy manure, or other substances. Early Grapes in a full crop severely tax the energies of the Vines, and through aiming high, perfection in colour is not always attained. This spoils the fruit for home as well as market purposes. Red Hamburgs may be sweet, but they are defective, because the Vines have not stored sufficient chlorophyll for conversion at the time of ripening the fruit into the essential purple black which gives Grapes a superior appearance and a more appetising as well as a higher quality. This is due to overcropping or a deficiency of foliage duly exposed to light, and no means can avert defective finish that is not otherwise induced concurrently with the growth. Something may, however, be done towards aiding the Vines to prevent exhaustion, so as to prejudice next year's crop whilst assisting in the ripening of the current crop of Grapes. This is best effected by a liberal and constant supply of warm dry air combined with a moderately low night temperature, but the temperature must be well maintained at 70° to 75° by day from fire heat, and 80° to 85° with sun heat, the temperature falling to between 60° and 65° at night. Red spider is usually found on forced Vines, particularly when hard forcing is practised. Painting the hot-water pipes with a mixture of sulphur and skim milk is a good remedy, but it must be done with care or the sulphur fumes act injuriously on the skin of the berries and spoil their appearance. Sponging the leaves with a solution of softsoap, not more than 2 ozs. to the gallon of water, is a safe but tedious method of freeing Vine foliage from red spider. Taken in time it is questionable if it have any equal for safeness and efficiency.

Succession Houses.—Attend to thinning the bunches and berries, not allowing work of the kind to get into arrear. Stop and remove laterals, especially where there is not room for extension, as to allow them to extend considerably, or so as to necessitate a large reduction of foliage at one time, results in a check, very often inducing shanking at a later period. See that the borders have plenty of water, and weakly Vines will be benefited by tepid liquid manure. Vines swelling their fruit should have a moist atmosphere (but not stagnant), damping the borders two or three times a day, and if liquid manure be used occasionally at the last damping it will improve the Vines and act as a check to red spider. Care, however, must be taken not to use the liquid too strong. Stable drainings must be diluted with five or six times its bulk of water, and 1 ounce of the ammonia manures to a 4-gallon pot of water is ample, that quantity, in either case, being sprinkled over 30 square yards of surface. Do not syringe the Vines after the Grapes are set.

Late Vines.—Disbud and tie out these as they require it. Close the houses early in the afternoon with sun heat, and plenty of atmospheric moisture by frequently damping available surfaces. These Vines where started early in March are making rapid progress, and must receive every encouragement; but avoid hurrying their growth by a close atmosphere, judiciously ventilating, particularly early in the day, so as to secure well formed, thick, leathery leaves.

Young Vines.—Last year's planted canes will now be breaking naturally, and when the buds have grown about half an inch a little fire heat will prove beneficial, especially on cold days. Remove all the buds except one at each break, retaining the strongest, and gradually remove those not required, leaving the shoots for bearing or forming the side growths not closer than 15 to 18 inches on each side of the cane. If fruit is taken crop lightly. One or at most two bunches is as much as Vines in the first year of fruiting ought to be allowed to bear, but supernumeraries may be weighted with as much fruit as there is a prospect of their bringing to maturity.

MELONS.—In the early houses Melons are not as forward as they are expected to be at this time, but those in the earliest house are swelling their fruits and require to have supports placed for them. Half-inch white fir or pine boards 6 or 7 inches square, with a hole through each corner, and suspended by four pieces of string or copper wire from the trellis in a slanting direction to prevent water lodging, may be used for the purpose. Pieces of slates with holes drilled in the corners are preferable to wooden supports, but nets are still better. Remove all surplus fruits and all flowers from such plants, also superfluous growths, stopping and tying as necessary. Afford efficient supplies of water, giving liquid manure as necessary for the maintenance of a free yet not luxuriant growth. A good atmospheric moisture being maintained by damping early in the morning and afternoon, syringe the plants lightly about 3 P.M. on bright afternoons. Later plants showing fruit should, unless abundant and the plants vigorous, have the first blossoms removed, it being important that the female flowers be nearly of one stage of growth. Secure a somewhat higher temperature and drier atmosphere during the setting, only affording as much moisture as will prevent flagging. Stop the shoots at one joint beyond the fruit, but employ the knife as little as possible during the setting period.

In pits and frames a good bottom heat must be maintained, observing the conditions previously given during setting. When the fruits are set and swelling they should be placed on a piece of slate. If canker appear at the collar rub quicklime well into the affected part, repeating this as necessary.

CUCUMBERS.—Plants that have been bearing through the winter will need to be renovated at the roots, removing with a hand-fork as much of the exhausted soil as is possible without much injury to the roots, and fill with rich lumpy compost pressed down firmly. Stopping, training, and cutting out the old growths must be followed up, and abundant waterings given as necessary. Assist plants in full bearing with copious supplies of weak liquid manure, and earth the roots occa-

sionally, using warmed compost. Damp the floor about 8 A.M. and 3 P.M., the foliage being syringed lightly on fine afternoons, and keep the evaporation troughs charged with guano water or liquid manure. There ought not to be any delay in having the blinds ready where that form of shading is employed, so that they may be employed for an hour or two at midday when the sun is brightest. Shading is most needed after a period of dull weather to prevent flagging. Worms may be expelled by lime water.

STRAWBERRIES IN POTS.—The season of forced Strawberries will soon be at its height, and the labour entailed at its maximum. East winds are usually very prevalent in spring time, and watering must have great attention. Examine the plants at least three times a day in bright weather, and whenever a plant needs water give a thorough supply. The shelves at this time of year should be at a greater distance from the glass than earlier in the season, so as to allow a free circulation of air between the leaves of the plants and the glass, the flowers not being exposed to violent atmospheric changes by the admission of air after a period of dull weather. Plants that are to give very fine fruits should not only be those showing the largest flowers, but those must be thinned to about a dozen or so on each plant before they expand. Bring them forward in a gentle heat in the first stages of swelling, affording an abundance of atmospheric moisture so long as the fruit remains green; but when it becomes whitish green increase the temperature gradually to 80°, 85°, and 90° on sunny days, keeping through the night at 65° to 70°, with 5° more on dull days or from artificial heat, continuing this until the fruit becomes red all over, when the temperature should be lowered to a minimum of 60°, in which they will increase considerably in size after they are apparently ripe, and to secure high flavour a free circulation of warm rather dry air must be maintained, watering at the roots only to keep the foliage fresh.

THE FLOWER GARDEN.

Carnations and Picotees.—Old plants of these in beds or singly have been so badly injured by frosts that the greater part of them are either dead or not worth saving. Young seedlings and layered plants have fared much better, these suffering more from the weight of snow than from the severity of the frosts. The month of March has not improved matters, and during such cold wintry weather it would have been most unwise to either transplant any wintered safely in the open or to turn out any fortunately kept in cold frames. The sooner, however, this is done the better, keeping the plants in small pots under glass having a most weakening effect upon them. Make good the blanks if need be by transplanting, two poor beds, say, being converted into one good one; also carefully move any from boxes and turn out those in pots, giving all a fresh loamy soil, sharp sand being freely added, and shelter from cold easterly winds.

Sowing Carnation Seed.—Now is a good time to sow seed of border Carnations and Picotees, and strong plants will flower grandly in the borders next year. If the seed is sown thinly in pots, pans, or boxes of fine loamy soil, and placed either in very gentle heat or in cold frames or handlights, it will germinate surely and strongly. Cover with squares of glass, shade heavily till the seedlings appear, and keep uniformly moist from the first. Prick out the seedlings when about 3 inches high in other pans or boxes, and finally plant out where they are to flower before they spoil each other by crowding. The new race of border Carnations offered in most seed catalogues under the name of Double Margaret or Marguerite are well worthy of a trial. By sowing now in gentle heat, placing the seedlings singly into 2½-inch pots, and finally planting out before they are badly rootbound, strong heads of flower will be produced during next August, the flowering period lasting well into the winter. There is only a small per-centage of single flowers from a packet of seed, but even these are pretty, while the rest are very double, well varied in colour, and sweetly scented. Seed of this novelty sown recently in gentle heat came up as quickly and evenly as Phlox Drummondii.

Anemone coronaria.—Anemones generally are serviceable and beautiful, and none more so than *A. coronaria*. The flowering season of the latter lasts from March to June inclusive, beds of plants yielding a profusion of flowers in various bright colours. If the seed is sown now a good display ought to result next spring. No particular soil is absolutely necessary for these very hardy and beautiful occupants of the flower garden, but they succeed best in a rather rich loamy root run, and a bed might well, therefore, be specially prepared for them. Make this as fine as possible near the surface, draw shallow drills 6 inches apart, and sow the seed thinly. The latter operation can be most readily carried out by well mixing sand or fine soil with woolly seeds, and the latter should be covered with fine soil. Keep the seedlings free of weeds, and when they are 2 inches or rather less in height transplant a portion of them elsewhere. Showery weather ought to be chosen for this delicate work, small patches being taken up here and there with a trowel and replanted without further disturbing them. The plan of sowing the seed directly it is ripe also answers well, only in this case the seedlings are longer before the bulk of them flower. It is advisable to raise a bed of seedlings every year, but the old roots if undisturbed and manured from the surface every summer will long continue serviceable.

Hardy Annuals.—From the beginning till the middle of April is a good time to sow seed of hardy annuals. If sown much earlier there is every likelihood of many of the seedlings coming to grief, and if the sowing is deferred till May a spell of dry weather may hinder germination, hot weather also setting in before the plants have become well

established. The seed being sown now on well prepared ground thinly according to their respective heights and covered with fine soil, it will probably germinate quickly, and if the seedlings are freely thinned they will make rapid progress and develop into strong branching plants. They will repay for liberal treatment, crowded starved plants flowering for a short time only. Sweet Peas and Sunflowers will make but a poor display on a hot dry soil, and it is advisable to manure and deeply dig patches of ground or lines of the same specially for these. Poppies will succeed nearly anywhere, but the seed being very small and plentiful is usually sown much too thickly. Plants kept well clear of each other will longest remain floriferous, but even these are a mass of seed pods long before the autumn is reached. Dwarf Tropæolums if kept just clear of each other are even gayer and more beautiful than the best Zonal Pelargoniums, but when they are allowed to run into each other the effect is soon marred. They succeed well on somewhat dry poor ground. Single or well isolated plants of Mignonette again are much preferable to patches. The list of other hardy annuals that ought now to be sown includes Alyssum, Bartonia, Calendrinia, Calendula, Candytuft, Cornflower, Chrysanthemum, Clarkia, Collinsia, Convolvulus minor, Coreopsis, Eschscholtzia, Gilia, Godetia, Gypsophila, Ornamental Grasses, Hawkweed, Helichrysum, Hibiscus, Larkspur, Leptosiphon, Limnanthes, Linaria, Linum, Love-lies-bleeding, Lupine, Malope, Nemophila, Enothera, Sanvitalia, Saponaria, Silene, Sweet Sultan, Tropæolum, Venus's Looking Glass, Viscaria, and Xeranthemum.

Half-hardy Annuals.—It is next to useless to commit seed of Asters, Stocks, Zinnias, Marigolds, Dianthus, and Phlox Drummondii to the open ground. Even if some of it did germinate the display from the plants must inevitably be late and unsatisfactory, and the better plan in every way is to raise the plants in gentle heat and have them strong and ready for the open ground late in May or the first week in June. Either mild hotbeds or the gentle heat of newly started vineries and other houses answers well for raising these annuals, the seed being sown either on a bed of fine light soil or in boxes and pans filled with the same. Avoid thick sowing, cover lightly, shade heavily, and never let the soil become at all dry. Mice are very fond of Aster seed, and if any of them are about the precaution of just damping the seed and then rolling it in powdered red lead must be taken prior to sowing, or otherwise the greater portion of it may be eaten or carried away in one night. When the seedlings are of good size and have been well exposed to the light, prick them off into beds, boxes, or pans of fairly rich compost, as none of them will bear starving before being planted out in their flowering quarters. Japanese Maize, Ricinuses, Amaranthuses, Perilla nankinensis, and the miniature Sunflower may also be somewhat similarly raised and treated the two first named, however, being kept singly in pots.

PLANT HOUSES.

Azaleas.—As these cease flowering examine them over, and if thrips are present wash the foliage with a solution of tobacco water before placing the plants in vineries and Peach houses to make their growth. When an inch of growth is made root action will have commenced, and the plants may be potted if they need it. Employ peat and clean coarse sand, pot firmly, and water carefully afterwards. If good peat cannot be obtained pot the plants in loam one-third, two-thirds good leaf soil passed through a half-inch sieve and sand. Peat remains longer in a good healthy condition, but where it cannot be had Azaleas will do well in the compost named. Remove all Azaleas required for late flowering to some structure with a northern aspect. At this season of the year they come forward rapidly in houses that are exposed to the sun.

Camellias.—Camellias that have flowered may be thoroughly washed with petroleum and water if scale is noticed. Grow them in a close moist atmosphere, and syringe freely two or three times daily. While growing the Camellia delights in heat and moisture and slight shade from the sun in the hottest part of the day. Plants in tubs or large pots may be top-dressed with good loam and manure, and occasional applications of soot water may also be given. Those in smaller pots that need more root space can be potted at once in a compost of fibry loam, one-seventh of manure and sand. Give water carefully after potting, but do not allow these plants to suffer by an insufficient supply.

Salvia gesneriflora.—For flowering at this period of the year few plants surpass this bright scarlet Salvia. Large spikes of bright flowers are freely produced which last much longer than many others. It is useful for furnishing purposes in 6 to 10-inch pots. Cuttings for the latter should be rooted at once, those for the former not until the end of May. With this Salvia pinching is not needed; it branches freely, and if staked upright will form a perfect pyramid with flowers from the top to the base. If very large plants are needed 5 or 6 feet high prune those now in 6-inch pots after flowering, and place them into 12-inch pots. The treatment given to Chrysanthemums as regards potting will suit it admirably. The cooler it can be kept during the winter the better. If bushes are preferred to pyramids pinching is necessary, and the plants must be induced to form several instead of one lead.

Zonal Pelargoniums.—Insert the cuttings required for winter flowering, placing them singly in small pots, and arrange where the temperature is about 60°. Partially reduce the roots and repot those that have been cut back. Place young plants now in 4-inch into 6-inch, and allow them to come into flower. Plants just rooted may be pinched and placed in 5-inch pots; if they can be given a temperature of 55° to 60° for a time they will soon be established.

Ivy-leaved Varieties.—Insert plenty of these for autumn and winter flowering. The flowers of these are most useful for cutting. Those now in 5-inch pots may be placed into 8-inch size, and if arranged in a light sunny position where they can be trained under the roof will flower profusely.

Hydrangeas.—Plants of *H. paniculata* should not be overforced. Allow them to come forward when a circulation of air can be maintained daily to insure sturdy growth. Start others in heat and then transfer them to the greenhouse. Place all of the hortensis section that are showing flower on a moisture-holding base where the temperature is about 50°. Give clear soot water occasionally. Introduce stool plants that have been in cold frames into Peach houses or vineries so that they will complete their growth early.

Rhodanthes.—Seedlings raised in heat and hardened may be transferred to cold frames. It will be necessary to ventilate these carefully at first and mat up the frames at night. More seed may be sown at once.

Fuchsias.—Repot plants that are in 60's, and supply each with an upright stake. Keep them growing in a temperature of 50° to 55°. Pot singly those that have just been rooted, and insert more cuttings. The earliest old plants may be placed in their largest pots and the shoots allowed to extend without further pinching.



APIARIAN NOTES.

THE WEATHER.

I HAVE observed the winter of 1838 mentioned in this Journal as having been severe. I remember it well. There were three months of continuous frost, which had not wholly disappeared by the month of May. Seed time was late, but the harvest was not, and was a good one. The frost must have been severe, as it was protracted. I remember when in the old steamer, the *Vale of Leven*, which sailed from the Broomielaw to Dumbarton, the Clyde was frozen over as far down as the Castle. The paddle-wheels of the steamer frequently threw pieces of ice about an inch thick upon deck, with which the boys aboard amused themselves by curling them ahead of the little craft. But I do not remember a March so cold and winterly as the one just passed away, and April so far is little better. The effects of the severe cold are everywhere apparent, as I am informed, as I have not been able to go about since March 12th. Many plants that I considered hardy are destroyed, and Crocuses come irregularly, and fall over with unopened petals. Beds of Arabis were promising on the last day of February, but wherever the snow laid upon them there is not a vestige of green or flower, unless at sheltered edges where it melted quickly. In short there is scarcely a trace of the flowers left. Seed time is still in the future; and although "hope deferred maketh the heart sick," still all we can do is to hope on, that a change may come quickly. It will be most welcome.

CELLS CONTAINING MANY EGGS.

"C. R." wishes to know the indications of cells containing ten or twelve eggs, the queen of which was hatched in 1889. The presence of so many eggs in the cells, I am inclined to think, indicates that the queen is more youthful than is imagined—very likely raised last autumn. These surplus eggs will be all destroyed. I have never observed bees carrying eggs from one cell to another, although the late Mr. Pettigrew asserted it, but he never proved the matter. Bees in every case prepare the cells beforehand for the reception of the eggs, and in no case will a queen deposit an egg in an unprepared cell, neither will the bees prepare more cells than are absolutely necessary in conformity with their strength or numbers, and when supplied with all the necessaries of life and for breeding purposes during September they reach their goal in a more satisfactory manner to the bee-keeper than in any case where artificial means are employed. The observant bee-keeper will soon learn the folly of some practices advocated, among which "brood spreading" is happily now condemned by its former advocates. I seldom look upon ignorance as a fault—it is a misfortune to

many; but it is a great fault to ignore it, and as it were attempt to step upon the topmost rung of the ladder before the first one has been approached. I am very glad to see, however, that the latest ideas of some of our contemporaries are very much in accordance with the instructions that were given in these pages years ago. Those who care to read the latest and compare them with earliest numbers will have no difficulty in tracing how the lower rungs have been bridged over.

A multiplicity of eggs in the cells sometimes has a different meaning than the fertility of the queen or a paucity of bees. About 1862, when I abandoned surmise to prove by actual experiment some questions concerning foul brood, one of which was whether heat or cold was most favourable towards developing the disease, I proved that heat developed the disease more rapidly than much lower temperatures, which is contrary to much of the present day's teaching. One of my hives experimented with had many cells completely filled with eggs, and the hive was not a weak one either. About this time it was observed in Germany, and by Mr. Woodbury, that in hives affected with foul brood the queens seemed more prolific than in normally healthy hives. I communicated my experience of this hive to this Journal, but Mr. Woodbury's reply did not satisfy me. I turned my attention specially to it, which illustrated many phenomena, such as inverted brood, two larvæ in one cell, &c. I believed at the time that the rapid development of so many eggs was due to the presence of the germs of foul brood in their first stage in the food the queen was fed with, and although I never proclaimed that I was the first to discover this, I certainly say that I was the first to combat the idea that foul brood may be perpetuated for years by the same queen. After this extraordinary instance I never knew a single case where the queen survived many months. They die early, showing symptoms of a dropsical nature. From the experiments it is quite evident that infected honey has exciting causes upon the queen, and perhaps, too, upon the worker. I shall be much obliged if "C. R." will watch the progress of this hive and report later on, but do not interfere much with it.

WINTERING BEES.

"Kent" asks some questions regarding the wintering of bees. They are perhaps more criticisms than queries. The articles in journals he refers to regarding wintering bees contain simply what we have taught for long. There is nothing new in them, and it is even questionable if the writers have experience to warrant the production of such articles.

For the edification of both "Kent" and the editors referred to by him I may say that single-cased hives covered thoroughly with non-conducting material had a roof raised above the crown covering to allow the escape of moisture. The covering of dried grass was kept hard to the crown of the hive that, together with a narrow doorway to prevent an excessive rush of cold air, and the ventilating floor, entraps the carbonic acid gas until it falls insensibly through the bottom during cold weather. These arrangements prevent that bane to wintering bees—damp, and cannot be improved upon. I may further tell him that the so much space above bees and the waterproof ceiling are both detrimental to bees in a high degree. Will correspondents kindly frame their questions distinctly, and not mix them with ordinary correspondence?—A LANARKSHIRE BEE-KEEPER.

TRADE CATALOGUES RECEIVED.

Charles Frazer's Exors, Norwich.—*Illustrated Catalogue of Garden Structures.*

Charles Turner, Royal Nurseries, Slough.—*General Spring Catalogue of Plants.*

G. Humphries, Kington Lang'ey, Chippenham.—*Catalogue of Dahlias.*

H. J. Jones, Hither Green, L. wisham.—*List of New and Choice Plants and Seeds.*



•• All correspondence should be directed either to "THE EDITOR" or to "THE PUBLISHER." Letters addressed to Dr. Hogg or members of the staff often remain unopened unavoidably. We request that no one will write privately to any of our correspondents, as doing so subjects them to unjustifiable trouble and expense.

Correspondents should not mix up on the same sheet questions relating to Gardening and those on Bee subjects, and should never send more than two or three questions at once. All articles intended for insertion should be written on one side of the paper only. We cannot reply to questions through the post, and we do not undertake to return rejected communications.

Books (E. M.).—Probably some of the manuals of Mr. Charles Whitehead would be of service to you, and we think they are published by Effingham Wilson. (E. M.).—Mr. Barron's work on Vine culture is published at this office, price 5s. 3d. post free.

The Ancient Society of York Florists (J. L.).—We are pleased to hear that the Lord Mayor of your City takes much interest in the Society and the York Gala. The presentation of a bouquet on behalf of the Society at the reception last Thursday was a graceful act, and your note on the subject would have been readily inserted had it reached us a day sooner. It came to hand after our "Notes and Gleanings" pages were made up for press.

Sowing Seeds—Mulching (B.).—We prefer sowing in drills, whether seedlings are raised in frame or the open ground, for transplanting. The distance of the drills from each other is determined by the size or "spread" of the plants when they are ready for removal, and the depth of the small channels depends on the size of the seeds. Sow thinly, and in any case if seedlings come up thickly thin them quickly; crowding plants in their early stages has ruined countless thousands. Fresh horse droppings applied as a mulch to Roses and shrubs outdoors are not injurious, and may, indeed, be very beneficial.

Vines not Showing Bunches (Inquirer).—It is much easier to ask a categorical question than to give a categorical reply in certain cases, and yours is one of them. Without some knowledge of the weight of the crop last year, the time it was cut, the condition of the leaves in respect to crowding or otherwise—freedom from insects or otherwise, and how long the leaves were retained—no one could give an answer worth printing. Your gardener ought to be able to supply the necessary information, and if at the same time you can send us a fair sample (1) of last summer's wood, and (2) of the barren growths, we will give the matter our best attention. The varieties of Grapes you name are as well suited for early forcing as are no doubt any others in your collection.

Growing Mushrooms (A Welshman).—If the manure, including all the stained straw from a one-horse stable, is allowed to accumulate without being drenched by heavy rains, nor yet so dried that it will not ferment when thrown into a heap, it may be made up into a small bed, say 4 feet wide, twice that in length, and about 15 inches deep in a stable or shed for growing Mushrooms. But this is by no means the best period of the year for commencing, for assuming that Mushrooms are produced hot weather will probably have arrived, and maggots then invariably infest the crops if the beds are not in a very cool shed, cellar, or on the north side of a wall. Try your luck, and if you fail try again, commencing to collect manure towards the end of July or the beginning of December as may be the most convenient. See pp. 104 and 105, sixth edition, "Mushrooms for the Million."

Nitrate of Soda for Onions (W. W.).—If you were to point in some steamed bone flour at the rate of about 3 ozs. to each square yard now, and when the plants are fairly growing top-dress with nitrate of soda at the rate of about 1 oz. to the square yard, it would be better than mixing nitrate of soda with the soil. You can of course apply it in solution at the strength of from a quarter to half an ounce to a gallon of water if the soil is not otherwise quite wet enough by heavy rains. It may, perhaps, be well to remember that nitrate of soda lowers the temperature of water, and making the soil cold is not the most favourable to the growth of crops. The remedy, or preventive, is obvious—a little warm water. A mixture of leaf soil and wood ashes placed round the roots when planting would be helpful. The soil should be firm for bulbing, and mulched in hot weather. No one can tell you "how often" to give liquid manure, as action in this respect must be guided by the state of the soil.

Vine Buds and Insects (R. A. G.).—Your specimens prove to belong to the order of flies; it is a species of *Conops*. The mature insects haunt flowers for their nectar, the larvæ or grubs are parasitic on other insects. We cannot, therefore, think these are samples of the actual aggressors. The appearance, indeed, would show that some kind of

weevil had been at work. It is most likely a visitation of the little dusky species called *Otiorynchus picipes*, which is fond of the buds of the Vine and wall fruit trees generally. The habit of these weevils is to attack by night, and during the day they conceal themselves in the earth or under pieces of loose bark, or cluster together on walls in holes where the mortar has dropped out. Another species of *Otiorynchus* also infests the Vine, and a different weevil also, *Rhynchites betuleti*, but the latter, also an enemy of the foliage, seldom appears till May.

Ants in a Vinery (Amateur).—These often too familiar pests do considerable mischief in gardens and indoors. They are best extirpated by poison, and the arsenical solution given below is efficacious. It is, however, extremely dangerous, and must be used with the utmost caution, as it is fatal to animal life. Place 1 oz. of ordinary arsenic in an old iron pot with a quart of water, and boil gently until it is reduced to a pint, a little more rather than a little less, and to this liquid add half a pound of Demerara sugar, which will form a syrup. A little of this should be placed in saucers in the runs, around the nests or haunts of the ants. We repeat, this mixture must be used with the greatest possible care, not entrusting it to careless persons, or placing it where it is likely to be partaken of by any animal than that to be destroyed. To rid soil in pots or other places of ants dissolve a piece of camphor the size of a cob nut in 2 quarts of hot water, and when cool enough apply it, and the ants will be destroyed without prejudice to the roots or other parts of plants.

Vine and Cucumber Leaves (A. H. H.).—The leaves are very thin in tissue, which in a measure is due to the weather that has prevailed lately, rendering forcing extremely difficult. The want of air is the chief cause of mischief, and the remedy for thin tissue is to ventilate early and carefully. There is not, so far as we can discover, any organic growth in the Cucumber leaves due to fungi. The dark spots on the leaves of the Vines also are not organic disease, though there may be some fungus making its way through the leaf tissues. The leaves are scorched, as often happens in bright weather following a prolonged dull and cold period. The preventive is not to hurry the plants being forced so quickly in the severe or dull weather, and admit a little air each day, so as to secure a change. That, with moisture corresponding to the conditions, would secure better textured foliage, whereby they would be less injuriously affected by a return of bright weather. We can only recommend that air be admitted carefully and early, avoiding cold draughts, and if possible shade for an hour or two from bright sun for a few days, or until the foliage becomes inured to the changed conditions. The foliage sent is practically beyond recovery. Encourage lateral growths on the Vines, but prevent overcrowding, and fresh growth being secured on the Cucumbers the older leaves can be dispensed with. Similar remarks apply to the Tomato plants.

Communications (Timid Inquirer).—Those intended for publication, also letters containing information for that purpose, should be addressed to the Editor always, and not to any person individually. All suitable communications are inserted as soon as practicable. The majority arrive on Tuesday and Wednesday mornings, and only a few of these can appear in the current issue, and must perforce wait till the following week, when all that are of immediate interest are inserted for which room can be found. Many of the articles that have to wait a few weeks, as some very long ones have, are just as much appreciated by us as are those which have precedence in publication. We are glad to receive notes from gardeners in various districts, and to revise those which are suitable for publication. If you think it possible that an editor can be prevailed upon to reveal the name of a correspondent against his wish you had better put your wits to work and try a few methods. We know very well that some persons who write under initials or *noms de plume* do not in the least mind who knows their identity, but even then an editor would not disclose them to satisfy anyone's curiosity. The Editor of this Journal has preferred to appear in court and defend a criminal action rather than disclose the name of a correspondent, and it was then not obtained. You need not give yourself another moment's concern on this subject. Some writers have very good reasons for obscuring their identity, and we usually know what they are.

Peach Trees Unsatisfactory (J. H. R.).—The wood taken from the second house and marked No. 1 is badly attacked with gum, indeed one of the worst cases we have seen. Almost every bud is destroyed, and in some places the gum encircles the shoot. The parts above those must necessarily perish, and the most remarkable thing about it is the trees were lifted in December, 1889. This we are afraid has not been done in a very efficient manner, for the wood is green and unripe, and that showing the gum is long-jointed and very soft. The gum is caused by a fungus named *Coryneum Beijerincki*, which pushes its mycelium in the tissues of the affected tree, causing the death of young shoots speedily and injuring all through the formation of gum and swelling of the affected part. Trees affected like the one from which the specimen (No. 1) is taken should have all the growths similarly attacked cut away to firm ripe wood and the shoots burned. The shoots during the summer should be trained thinly, gross growths being repressed and laterals closely pinched. Air should be freely admitted, and syringing must only be practised as may be necessary to preserve the trees in health. Excessive waterings or applications of liquid manure must be avoided, the soil to be kept no more than healthfully moist. Ammoniacal and nitrogenous manures ought not to be used, but a dressing of superphosphate of lime and muriate of potash would be beneficial, say 5 lbs. of the former and 2 lbs. of the latter mixed, per square rod (30½ square

yards), or 4 ozs. per square yard. Apply as a surface dressing, watering will wash it in. This will strengthen their bark tissues, and thus better enable the trees to resist disease. In the autumn the trees should be carefully lifted and replanted in firm soil. This should be done directly the leaves give indications of falling. The wood of No. 2 is weak, green, and soft, but not so long-jointed as the gummied; the white upon it, we presume, is whitewash. Is the house naturally damp? The conditions of the wood suggests that it is, or that too much moisture has been afforded. The soil may not contain sufficient calcareous matter.

Names of Fruits.—The names and addresses of senders of fruit to be named must in all cases be enclosed with the specimens, whether letters referring to the fruit are sent by post or not. The names are not necessarily required for publication, initials sufficing for that. Only six specimens can be named at once, and any beyond that number cannot be preserved. (*G. L.*)—1, Braddick's Nonpareil; 2, Moss' Incomparable; 3, Norfolk Beefing. The Pear is Beurré Rance.

Names of Plants.—We only undertake to name species of plants not varieties that have originated from seed and termed florists' flowers. Flowering specimens are necessary of flowering plants, and Fern fronds should bear spores. Specimens should arrive in a fresh state in firm boxes. Slightly damp moss, soft green grass or leaves form the best packing, dry wool the worst. Not more than six specimens can be named at once, and the numbers should be visible without untying the ligatures, it being often difficult to separate them when the paper is damp. (*F. F. C.*)—1, *Habrothamnus Newelli*; 2, *Davallia elegans*; 3, *Davallia Tyermani*; 4, insufficient; 5, *Nephrolepis tuberosa*. (*B. R.*)—1, *Odontoglossum triumphans*; 2, *Odontoglossum CErstedti*; 3, *Odontoglossum mulus*.

COVENT GARDEN MARKET.—APRIL 8TH.

A BETTER trade doing at lower prices with heavy supplies of indoor goods.

FRUIT.

	s.	d.	s.	d.		s.	d.	s.	d.
Apples, ½ sieve	1	6	0	6	Lemons, case	15	0	to	20
" Nova Scotia and					Melons, each	0	0	0	0
Canada, per barrel	15	0	26	0	Oranges, per 100 .. .	4	0	8	0
Grapes, per lb.	2	0	4	0	St. Michael Pines, each..	3	0	8	0
Kentish Cobs	40	0	45	0	Strawberries, per lb. ..	6	0	1	0

VEGETABLES.

	s.	d.	s.	d.		s.	d.	s.	d.
Artichokes, dozen .. .	0	0	to	0	Mushrooms, punnet .. .	1	6	to	2
Beans, Kidney, per lb. .	1	0	0	0	Mustard & Cress, punnet	0	2	0	0
Beet, Red, dozen .. .	1	0	0	0	Onions, bushel	8	0	4	0
Brussels Sprouts, ½ sieve	3	0	4	0	Parsley, dozen bunches	2	0	8	0
Cabbage, dozen	3	0	0	0	Parsnips, dozen	1	0	0	0
Carrots, bunch	0	4	0	0	Potatoes, per cwt. .. .	3	0	4	0
Cauliflowers, dozen .. .	3	0	6	0	Rhubarb, bundle	0	2	0	3
Celery, bundle	1	0	1	3	Salsafy, bundle	1	0	1	0
Coleworts, doz. bunches	2	0	4	0	Scorzoner, bundle .. .	1	6	0	0
Cucumbers, doz.	3	0	5	0	Seakale, per bkt. .. .	2	0	2	6
Endive, dozen	1	0	0	0	Shallots, per lb.	0	3	0	0
Herbs, bunch	0	2	0	0	Spinach, bushel	5	0	6	0
Leeks, bunch	0	2	0	0	Tomatoes, per lb. .. .	0	0	0	6
Lettuce, dozen	3	0	3	6	Turnips, bunch	0	0	0	4

AVERAGE WHOLESALE PRICES.

CUT FLOWERS.

	s.	d.	s.	d.		s.	d.	s.	d.
Arum Lilies, 12 blooms ..	2	0	to	5	Mimosa (French), per				
Azalea doz. sprays .. .	0	6	0	9	bunch	1	0	to	1
Bouvardias, bunch .. .	1	0	1	6	Narciss (Paper-white),				
Camellia, white, per doz.	2	0	4	0	French, doz. bunches ..	4	0	6	0
" red	1	0	1	6	Narciss (Various) dozen				
Carnations, 12 blooms ..	1	0	2	6	bunches, French .. .	2	0	4	0
Chitmas Roses, dozen					Pelargoniums, 12 trusses	0	9	1	0
blooms	0	0	0	0	" scarlet, 12 bnchs	6	0	9	0
Cineraria, 12 bunches ..	6	0	9	0	Poinsettia, dozen .. .	0	0	0	0
Cyclamen, doz. blooms ..	0	3	0	6	Primula (double) 12 sprays	0	6	1	0
Daffodils, doz. bunches ..	2	0	6	0	Primroses, dozen bunches	0	9	1	0
Eucharis, dozen	3	0	6	0	Roses (indoor), dozen ..	0	6	1	6
Gardenias, per doz. .. .	2	0	4	0	" Red (English) per				
Hyacinths doz. sprays ..	3	0	4	0	dozen blooms .. .	4	0	6	0
Hyacinth (French) dozen					" Red, 12 bls. (Fench.)	2	0	4	0
bunches	12	0	15	0	" Tea, white, dozen ..	1	0	3	0
Lapageria, 12 blooms ..	2	0	4	0	" Yellow, dozen .. .	3	0	6	0
Lilac (French) per bunch	4	0	6	0	Snowdrops, doz. bunches	1	0	3	0
Lilium longiflorum, 12					Spiraea, per bunch .. .	0	6	0	9
blooms	4	0	6	0	Tuberose, 12 blooms ..	1	6	2	0
Lily of the Valley, dozen					Tulips, per dozen .. .	0	9	1	6
sprays	0	6	1	0	Violets (Pamel), per beh.	2	6	4	0
Maidenhair Fern, dozen					" (dark), per beh. ..	1	6	3	0
bunches	4	0	9	0	" (English), doz. bunch	0	9	1	3
Marguerites, 12 bunches	4	0	8	0	Wallflower, doz. bunches	1	6	2	6
Mignonette, 12 bunches..	3	0	6	0					

PLANTS IN POTS.

	s.	d.	s.	d.		s.	d.	s.	d.
Aralia Sieboldi, dozen ..	6	0	to	18	Genista, per doz. .. .	8	0	to	12
Arbor Vitae (golden) doz.	6	0	8	0	Hyacinths, doz. pots ..	6	0	9	0
Azalea, per pl nt .. .	2	0	3	6	Lily of the Valley, per pot	1	0	2	0
Cineraria, per doz. .. .	6	0	9	0	Marguerite Daisy, dozen	6	0	13	0
Cyclamens, per doz. .. .	9	0	24	0	Mignonette, per dozen ..	6	0	9	0
Dielytra spectabilis, per					Myrtles, dozen	6	0	12	0
dozen	8	0	12	0	Palms, in var., each .. .	2	6	21	0
Dracana terminalis, doz.	24	0	42	0	Pelargoniums, per doz. ..	12	0	18	0
" viridis, dozen .. .	12	0	24	0	Pelargoniums, scarlet, per				
Erica, various, dozen ..	12	0	18	0	dozen	6	0	9	0
Euonymus, var., dozen ..	6	0	18	0	Primula sinensis, per doz.	4	0	6	0
Evergreens, in var., dozen	6	0	24	0	Solanums, per doz. .. .	9	0	12	0
Ferns, in variety, dozen..	4	0	18	0	Spiraea, per doz. .. .	8	0	12	0
Fiens elastica, each .. .	1	6	7	0	Tulips, do en pots .. .	6	0	8	0
Foliage plants, var., each	2	0	11	0					

Bedding plants (in variety) in boxes, from 1s. to 3s.



THE LAMBING SEASON.
FOOD.

IN no detail of farming work is a purpose and plan more important than in the feeding of ewes and lambs. Two methods, and only two, are worthy of thought, for the sheep that are left to rough it and live hard are to be regarded as uncared for in anything like a systematic manner, and with them, and those in whose hands the unfortunate animals are, we desire to have nothing whatever to do.

To the earnest home farmer rather do we turn, for he, at any rate, is sensible of a trust and responsibility; of property entrusted to his care for which he must do the utmost he can to improve and make it really profitable. To him we put the important question, What object have you in view in feeding the flock now? If your aim and desire is early maturity, you have done what you could in the selection of ewes, and also in the purchase of tups last autumn of a breed in which this desirable property is well developed. You did not suffer the ewes to become greatly reduced in condition last season, only allowing them to be on low diet for about a fortnight after the lambs were weaned, since when they have been so fed as to keep them in fair condition without any approach to fatness. The lambs afford the best evidence of this wise treatment now in their robust health, compact vigorous bodies, and free growth. There is nothing stunted or feeble about them; they have been well nourished, and are still well fed through the ewes. If they fell early they are now taking other food freely, and it is possible to hasten maturity by from five to seven months, or, in other words, at from eight to ten months old they may be as mature as low-bred sheep are at fifteen months.

This is one method, which to be as profitable as possible must include much care and positive economy in the selection and use of food. For the first food there is nothing in our opinion equal to the fine mixture of Mackinder's lamb food, to be followed later on with the coarser mixture. This food consists of an admirable blending of nutritious farinacious food, so nourishing that only a very small quantity is requisite to promote quick growth. Various kinds of cake, corn, and meal enter into the composition of this food, and it forms really a mixed dietary of the very best kind; but (and pray mark this) it is not the chief article of food—that consists of green food and roots. Mangolds, Swedes, Kale, Rye are all used in turn, but all used with due discretion.

In due course the lambs will be found at the ewe troughs, gradually taking to the chopped silage, and feeding as freely upon the coarser food as do the ewes. Evidence of what they do consume is clearly afforded when they run forward on Swedes. First of all the tops only are eaten before the folds are moved forward, then the roots are more and more demolished till there is often the lesser half left for the ewes. After the roots they go from one green crop to another; grass, Rye, Trifolium, Tares, Sainfoin, Clover, Rape, and mixed seeds all coming into use in turn; and if the wether lambs are intended to come out early for the butcher there will be a proportionate increase in the quantity of dry food.

Meanwhile a watchful eye is kept upon the ewes, and they have either the coarse lamb food or a mixture of crushed Oats and Beans with an addition of Peas and Maize if it is cheap enough. When the lambs are twelve or fourteen weeks old they tell seriously upon the ewes, and then is the critical time when the dams so frequently fall into low condition. A full dietary, changed occasionally, must be had, and they are not kept so much upon soft green food as to induce violent scouring. The common practice of

using much cotton or linseed cake for the ewes is also objectionable, because it is such an easy matter to use both sorts of cake to excess. When a feeding cake is used we decidedly prefer the compound Waterloo round cake as being more wholesome and so easily digested that it is less likely to be used wastefully.

The quantity of dry food used for the lambs depends on no fixed rule, but upon weather and condition. The basis of all feeding is free growth fully sustained; anything beyond that has its special object, which is generally an early and profitable maturity. To be so breeding and feeding must be alike judicious, and due care taken not to spend a guinea in the production of a pound's worth of mutton. It is owing to the persistent use of lamb tups that the Hampshire Down breeders have been so successful in the development of early maturity. What we want especially to see more of is really good all-round practice in flock management. Equal care must be given to breeding, feeding, and sheltering if we would obtain the best possible results. There is no such thing as luck in this work—the term is most objectionable; and we repeat our remark at the beginning of this paper, in no detail of farming work is a purpose and plan more important, and in none is there a greater degree of certainty of success when our purpose is wise, our plan mature.

WORK ON THE HOME FARM.

The ploughs have been kept following the Turnip folds closely, and the last of the spring corn will soon be sown. For this work the weather continues most favourable, and clean fine seed beds are to be seen everywhere. The Wheat plant is backward, and is thin on the Essex clays. In the midlands it is a full strong plant; so, too, are winter Beans, and the "seeds" and Clover are excellent. We have certainly had this season remarkable proof of the value of late sown Turnips, for such roots being small and firm were not hurt by the frost, and we have seen many market carts on the Essex roads going Londonwards laden with sound white Turnips with the green tops left on. On such roots ewes and lambs have been folded with safety and all has been well, but much harm has been done by folding upon decaying roots. Every lambing season do we meet with reckless work among sheep. Since writing our last note we have seen a flock of Kent ewes that had been turned out in a park all the winter without any trough food. The pasture was poor enough, and the ewes have been withdrawn from it for the lambing in such wretched plight that some of them are already dead, and judging from appearances other losses must follow. The lambs too, though exceptionally late must be weakly, and the whole thing is a wretched example of mismanagement.

Care must be taken not to overwork mares in foal. A little light work does good rather than harm, but as the foaling time approaches we gradually withdraw them from work, and turn them into a commodious lodge with a small yard quite away from other stock, and where they can be quiet. We like to have a look round at all the homestead stock the last thing at night, and then know whether any are likely to require attention in the night. It is an arduous time just now, what with lambing, calving, and similar increase among all live stock. Bed or sleep has often to be done without, and one is well rewarded for such extra work if only all goes well, and the young stock comes healthy and strong. Very pleasant is it to witness the daily increase of numbers. The mere sight is an incentive to exertion, and there is much good work for the future being done at every home farm. Farm pupils must not be mere spectators, but must take a full share of the work if they would become masters of it. By so doing they will gain experience and confidence as they can in no other way, and they will subsequently be able to take the control of a farm with an invaluable fund of practical experience.

METEOROLOGICAL OBSERVATIONS.

CAMDEN SQUARE, LONDON.
Lat. 51° 32' 40" N.; Long. 0° 8' 0" W.; Altitude, 111 feet.

DATE.	9 A.M.					IN THE DAY.				Rain
	Barome- ter at 32° and Sea Level.	Hygrome- ter.		Direction of Wind.	Temp. of soil at 1 foot.	Shade Tem- perature.		Radiation Temperature.		
		Dry.	Wet.			Max.	Min.	In sun.	On grass	
1891.	Inches.	deg.	deg.	deg.	deg.	deg.	deg.	deg.	deg.	In.
March and April.										
Sunday	29.752	44.6	40.9	W.	39.3	52.6	36.1	93.1	29.9	—
Monday	29.765	38.4	31.7	N.W.	39.8	46.9	30.9	94.2	23.3	—
Tuesday	31.031	38.2	35.0	N.E.	39.1	50.1	28.6	99.6	21.5	—
Wednesday ..	29.951	35.0	33.4	W.	39.1	48.8	28.1	75.0	21.9	—
Thursday	29.802	42.8	37.4	S.E.	38.9	47.4	35.1	64.1	27.2	—
Friday	29.637	40.6	38.3	N.E.	39.4	50.8	37.2	69.3	32.7	0.054
Saturday	29.717	45.9	44.9	N.W.	40.2	53.0	40.2	63.4	35.0	0.458
	29.808	40.9	37.4		39.4	49.9	33.7	80.2	27.4	0.512

REMARKS.

29th.—Slight shower at 10 A.M. otherwise generally bright.
30th.—Brilliant till 4 P.M.; a slight shower of snow at 4.40, and brilliant again before 5 P.M.
31st.—Brilliant morning, cloudy at times in afternoon.
1st.—Sun shining through slight fog in morning; overcast afternoon.
2nd.—Cloudy throughout. Solar halo 9.30 to 10 A.M. 3rd.—Overcast all day.
4th.—Dull and drizzly, with frequent showers and heavy rain from 6 to 9 P.M.
Temperature still low for the season.—G. J. SYMONS.

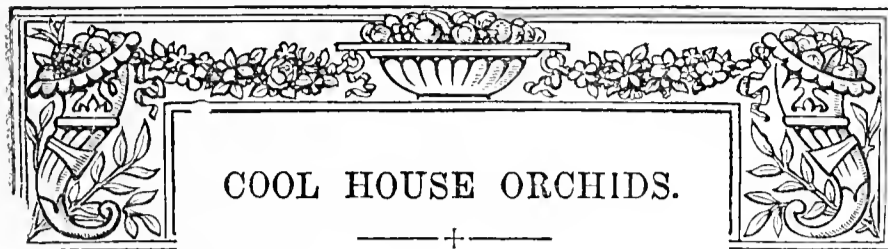

ORCHIDS generally are still steadily advancing in popular favour, but if any one group is to be regarded as the "Orchids of the future," it is that comprised within the title heading these remarks. What are ordinarily termed cool house Orchids consist principally of *Odontoglossums* and *Masdevallias*, with the representatives of a few other genera, but it is with *Odontoglossums* we are specially concerned on the present occasion, and to them attention will be chiefly directed. Nearly everyone concerned in any way with plants has learned something of their value, has become familiarised with their varied beauties at the exhibitions and in the florists' shops, or has seen that the flowers are adaptable to many important uses. It is unnecessary, therefore, to dwell upon the attractions of such Orchids—the crystalline texture and purity of the exquisite *Odontoglossums crispum* or *Pescatorei*; the rich gold brown and chocolate markings of others; the brilliant orange scarlet of *Epidendrum vitellinum* or *Ada aurantiaca*; and the glowing crimson and magenta tints displayed in the *Masdevallias* of the *Harryana* type. Suffice it that a floral effect can be produced in a house of so-called "cool Orchids" that is unsurpassed even amongst the most stately members of the same family from tropical regions requiring accommodation in stoves and similar structures.

One important point in the favour of these plants which has special reference to the *Odontoglossums*, is the durability of the flowers not only on the plants but when cut and applied to the various purposes of modern floral decoration. This alone would secure them a large share of substantial admiration, but they have still another character that cannot be overlooked—namely, they are amongst the cheapest of Orchids as regards varieties suitable for all ordinary purposes. Yet they afford a curious example of an astonishing range of value, as while plants can be purchased for a few shillings, forms of exceptional character realise 100 guineas and upwards, and the first named was obtained only a few days ago at a public auction sale. It has in fact occasionally been an additional source of harmless gratification to amateurs and others who have flowered plants for the first time to discover amongst them some valuable rarity, one perhaps in 10,000 imported plants.

Beyond all these recommendations the majority of *Odontoglossums* and cool house plants generally are of easy culture—that is, they can with ordinary care be kept in good health, and they will flower frequently. It is a question, however, whether this ready submission to the cultivator has not proved a source of danger, and whether the system commonly advocated and practised is not to blame for losses attributed to other causes. An impression has spread that anyone can grow *Odontoglossums* anyhow; some have even gone to the length of including them with greenhouse plants, and I have had frequent inquiries as to what species were best adapted for such structures. Being designated "cool house Orchids" has led to the idea that they cannot have too cool quarters provided they are protected from frost, and the effect of this has even been tried upon them, because it has been said that in their native habitats some have not infrequently been found with icicles on their leaves.

We know that the *Odontoglossums* may be regarded as the alpine Orchids of the New World, for the elevations at which they

are found in the Peruvian Andes and the table lands of Mexico must subject them to a comparatively cool climate, even though their homes are in a tropical region. Collectors tell us that the plants are found from 5000 feet upwards to 8000 or 9000 feet or even in some instances, as with *O. compactum*, to an even greater elevation—10,000 to 12,000 feet. The prevailing atmospheric conditions must, however, be considered, for the mere elevation is not a sufficiently definite indication of the natural requirements of a plant. Throughout the greater part of the long extent of mountain ranges where the *Odontoglossums* are found there is an exceptional and almost continual condensation of moisture from the winds of the Pacific Ocean, and though in some districts fairly defined dry and wet seasons are experienced, as a general rule the atmosphere is heavily charged with moisture where *Odontoglossums* most abound. Travellers tell me that in the daytime with a clear sky and the sun nearly directly overhead the temperature rises rapidly, and as it falls as quickly in the evening dense fogs and mists are produced by the condensation of vapour, and this in turn is still farther condensed as a saturating dew, to be rapidly raised in mist in the morning. The range of temperature extends over 40° or 50° between the extreme day and night temperature, but of course in cloudy weather the variation would be materially decreased. Add to this that *Odontoglossums* are found on rocks or on trees usually in a partially shaded position, and we have the principal available facts that can be utilised as a guide to cultivators.

How far it is necessary or desirable to attempt to follow the natural conditions of a plant's habitat is a matter well worthy of discussion, and has a direct bearing upon our present subject. It is very seldom possible to reproduce exactly the whole of the climatic and other conditions of a district where certain plants are found, yet they can be successfully grown, and from our point of view they may even be superior to those in a state of nature. The objects are widely different. Here we are chiefly concerned with vegetative and floral development; there the perfection of seed and increase is the requirement. This applies to many plants, and one well known cultivator of alpine plants, who claims to have never had a failure, even with those reputed the most difficult to grow, pots the whole of them in one uniform compost derived from his old disused Tomato or Cucumber beds, utterly regardless of the soil in which they are found wild. Many other plants could be named that have been and still are grown with success under very different conditions from their natural surroundings, and it has been proved that, though useful hints are often afforded by particulars of a plant's habitat, that information is by no means essential to success. Different opinions, I know, exist upon this subject, and therefore it is the more worthy of consideration.

Returning to the *Odontoglossums*, I could point to several cases where cultivators have been struggling to provide "the natural conditions" with rather dispiriting results, and to others where a bolder experimental course has been taken and attended by much more satisfaction to owner and gardener. The opinion is rapidly gaining ground that *Odontoglossums* have been for years grown in too low a temperature, and one of the most experienced orchidists, with whose collection I am familiar, writes me to this effect:—"I have tried various systems, but I shall never return to the low temperature method in winter again, for the plants are now in better health than they ever were before, stronger, and flower more vigorously. I never allow the minimum temperature to fall below 45°, and only to that in severe weather; 50° is our safest minimum, and we keep it as near that as possible, allowing a considerable rise with due shade and plenty of moisture under a strong sun. Little or no ventilation is provided at the upper part of the house, for this dries the plants too much, but we admit plenty of air below direct on to the pipes." I can bear testimony to the fact that these *Odontoglossums* are some of the strongest and best I have ever seen, and there is much truth in my friend's remarks, for in nine cases out

of tea where *Odontoglossums* have become yellow, weakly, and unhealthy, it is traceable to the lowness of temperature during the winter. The roots fail, and the plants rarely recover.

Moisture is an essential requirement, and must be supplied freely, but the more the plants can be induced to take through the atmosphere the better, as continually drenching the roots is not beneficial. But it should be a wholesome moving moisture arising from shingled shelves, or from plant foliage, and not vessels of stagnant water. There can be little doubt that the difficulties experienced in growing "cool house Orchids" on the Continent are more due to the inefficient supply of moisture than to the heat. The usual way is to ventilate freely to keep the temperature down, with the result that a rapid escape of moisture is encouraged from both house and plants that cannot be adequately supplied in any way. Under such circumstances ventilation is often dangerous. Shading is also a necessity, but here, too, discretion is needed, for in constant heavy shade the plants may grow freely and appear to make larger pseudo-bulbs, but these will not be matured, and the flowers, if any are produced, will be wanting in substance and durability. A diffused broken light is needed, with a little sun early or late in the day.

These notes must be regarded as suggestions on a wide subject, which can be easily amplified by others. There is a form of cool house for Orchids that must be mentioned in conclusion—namely, one of the same style as that devoted to hardy and half-hardy plants at Kew. In a slightly heated or even a quite cold house many beautiful terrestrial Orchids may be grown, such as the North American and Japanese *Cypripediums*, the *Disas* from South Africa, several delicate Australian Orchids, with the peculiar *Satyriums*, and the showy *Orchises*. These constitute the greenhouse Orchids properly so called, and very handsome specimens may be secured with a little trouble, their attractions being more readily inspected under glass than out of doors. Cool houses of this class are within the reach of most people, and the Kew house is an admirable example of what can be accomplished in such structures.

[A paper by Mr. Lewis Castle, read at the meeting of the Horticultural Club, Hotel Windsor, April 14th, 1891.]

PEACHES AND NECTARINES.

I AM pleased to note the increased attention paid to these fruits of late in the Journal. It is needed, I am sorry to say, for in many places that I have visited these fruits seem to be in worse condition than any other things on the place. Many a gardener who thinks he knows all about Vines will admit he does not know a great deal about Peaches. This should not be so; in my opinion they ought to receive some of the attention that is bestowed upon *Chrysanthemums*; they need quite as much as the latter if the trees are to be kept in good condition and the fruit to be of the best quality.

Those who have read the articles lately appearing with the object of founding their practice upon what they read must use a little discretion. I notice your correspondent Mr. Samuel Scott mentions several distinct seasons as the only occasions upon which the trees under his charge receive water. I strongly object to this mathematical style of watering. It may serve in the case in question, but in ninety-nine out of a hundred it would not. Each person must use his own wits in the matter. The great point is, at no period of the year allow a Peach border to become dry; if such occurs once from the time the trees are started until they are started again the following year it will militate against success.

If an amateur or cottager asks a gardener, "How often should I water such and such a plant?" (this question is put frequently) he is invariably told, "When it requires it," and is then initiated into the knuckle tapping of the pot. So with Peach and Vine borders; let every man test his own, and not be led astray because so and so only waters his so many times during the season. I have had charge of a Peach range extending to 300 feet where we had to water twice a week. The head gardener was a strong advocate of lifting his trees every third year, and the border for some few feet round the trees was one mass of fibres; to only water such trees as this at long intervals would be courting disaster.

One big tree on this place covered about 700 square feet of

trellis; his lordship the proprietor wished it to be moved to the middle of one of the 100-foot long houses, so that it might be enabled to extend, and, if such a thing were possible, to eventually fill the house. The super was nothing loth, as he had prepared the tree by root-pruning, &c., the two previous seasons, expecting such a request. It took four men two days to disengage its roots from the soil (no soil was allowed to remain that could possibly be removed from the ball). On the 5th November it was placed in its new station; every crevice at its base was firmly packed with new soil by the aid of a rammer, and its roots carefully laid out in good friable loam and plaster rubble, receiving at the finish a good watering with tepid water. The following season it received water at the rate of 150 gallons per week, and finished off a grand crop of 450 fruits, some of them over 10 ozs. in weight. At Ketton Hall, where Peaches are so extensively grown, the long and stated intervals system of watering is completely ignored; the soil there is of a stiff nature, and if this system acts satisfactorily this is the sort of soil one would expect to see it exemplified in.

As to the means employed in fertilising the flowers, one system is as good as another if thought and common sense are brought to bear on the matter. For instance, in dull, damp weather the man who so strongly recommends the syringe would modify his process, using his favourite instrument on fine days and on others using some means to convey the pollen to the stigma which would effect it in a perfectly dry state. Or again, the man who so strongly recommends the camel's hair pencil for fertilising in early houses would for the latest houses, if the weather were bright and favourable, be content to give the trees a shake two or three times a day, unless it were in the case of a tree which is usually a bad setter: then he would convey some foreign pollen to the stigma, this being generally effective if the tree is in a healthy state and the wood ripe.

The principal points to observe in successful Peach culture are—do not allow the border to become dry at any season, aim at a temperature of 48° to 55° night, 55° to 58° day, from fire heat while in flower with a little air on constantly; do not allow too many fruits to remain on the trees during the stoning period, train the young shoots in thinly so as to prevent overcrowding, prune the trees directly the last fruits are gathered, and re-arrange the remaining shoots, so that they and the leaves they bear may have free access to sun and air, thus becoming thoroughly ripened before autumn sunshine has passed away; also using the syringe freely (excepting the ripening period) from the time the fruit is nicely swelling until the leaves and shoots are well advanced in ripening.—J. TUNNINGTON, *Ripley Castle Gardens, Yorks.*

CINERARIAS.

I DO not agree with "A Notts Gardener," page 244, that *Cinerarias* are deteriorating in any of the points named when grown from a reliable strain, but if seed is saved from plants in a haphazard manner, the plants from this seed being grown in the same way, it is no wonder that results are unsatisfactory. In my opinion not nearly enough attention is devoted to the growth of *Cinerarias*, or there would not be so many complaints about the inferiority of the flowers and habit of the plants. No matter how good the strain may be from which seed is saved, if the culture is not correct satisfaction cannot follow. *Cinerarias* are easily grown if a few simple rules are duly followed, but if the seed is sown at the wrong time, the plants grown in too much heat, and allowed to be infested with insect pests, success must not be expected.

Cinerarias can be had in flower for five months, commencing early in December, continuing throughout the month of April. Well grown plants, whether in 9-inch pots for conservatory decoration, or sturdy little specimens in 5-inch pots suitable for vases for room decoration, are always useful where bright colours are appreciated.

Three sowings are requisite, the first being made early in March, the second a month later, while the third sowing need not be made before the end of May. A gentle heat, such as is afforded by a partly spent hotbed, must be provided for the first two sowings. The last sowing can be made in a cold frame placed behind a north wall, which will dispense with the trouble of providing shade daily. The seed germinates much better in the shade than when exposed to the sun, which parches the soil so much that germination is retarded. A compost of two parts leaf soil and one of loam, with a free admixture of silver sand, is most suitable for sowing the seed in. Employ well drained seed pans, over which place a square of glass covered with moss. This maintains the soil in a moist state, a condition favourable to the quick growth of the plants. Directly the seedlings show above the soil remove the moss and tilt the glass a little on one side to admit air.

When the plants are large enough, place them singly into small pots (thumbs) in similar soil to that in which the seed was sown. At no time allow the plants to become root-bound. Repot them as often as required. A light free soil is required after the first potting, say three parts fibry loam, one part decayed leaves, half a part dried cow manure, and coarse sand according to the character of the loam, be it light or heavy. Pot moderately firm, and supply water carefully at all stages, never making the soil too wet, especially after potting. Many plants die suddenly and mysteriously, and this is more often due to careless watering than anything else. During the summer and early autumn syringe the foliage frequently in the evening, especially after a hot day. Admit abundance of air to the frame on all favourable occasions. Keep the plants free from insect pests; never wait for two aphides, but fumigate the plants with tobacco smoke directly one is seen. The Celery maggot often disfigures the leaves by burrowing in the substance, and upon the first signs of its presence search carefully, and remove with the point of a knife any that may be found.

Keep the plants in cold frames standing on a base of coal ashes, which they enjoy much more than the dry air of a greenhouse, until about the middle of October, preserving the foliage from frost. At that time a cool greenhouse or pit from which frost can be easily kept suits them best. From the time the seed is sown until the end of September shade must be provided, either by placing the frames behind a north wall, or applying a thick shade to them in any other position; the former plan, though, is the best, as it saves much labour. When the plants are in the greenhouse more water will be required, as the air of the house is drier. Weak liquid manure applied three times a week will improve their appearance, that from cow manure and soot being the best.—S.

EXHIBITION POTATOES.

POTATOES always constitute an interesting feature at exhibitions, but only those who cultivate them for that special purpose can fully estimate the labour and time required in preparing for competition, whether it be single dishes or a given number of varieties, forming what is commonly called a "collection." Potatoes are the first essential in a collection of vegetables, no matter whether it be six dishes or twelve dishes, and readers who have not already aspired to be exhibitors in vegetables, and who contemplate doing so this year, should bear this in mind, for many a prize has been lost by the omission of these from among the varieties staged.

Potatoes are displayed in a variety of ways at flower shows, some using open flat hampers, others flat trays or boxes; a few persons employ some kind of greenery for garnishing, which may be fresh moss, Parsley, or Carrot leaves, while some stage them without any accompaniment. There is no question as to which has the best effect. Choose not the largest tubers, which are usually badly shaped; nor, on the other hand, select the small or undersized, but aim to get a smooth and even sample. Wash them with clean water and a sponge, and be careful to avoid breaking the skin. This work should be done directly they are lifted from the ground, placing them at once in a dark place, each wrapped separately in a strip of soft paper.

In growing Potatoes for exhibition purposes much care must be exercised, and it is surprising what varying results soil has on this crop. Some enthusiasts who have a suitable soil may rely on a few roots to provide the requisite number of tubers for a dish, while others having ground less suited must grow a quantity to secure even one dish suitable for competition. Light sandy soil, free from gritty matter, is the most suitable; where this does not exist fine refuse soil from the potting bench helps considerably if placed around them at the time of planting. If manure is needed it should be thoroughly decayed and given in moderate quantities, rank manure predisposing to disease as well as other evils not contributory to success in competition. It is best, too, applied to the soil in autumn, the latter thrown up as roughly as possible to expose the greatest possible surface to the action of frost and air.

There are several large seedsmen who make a speciality of Potatoes for exhibition, some of whom distribute a selection of varieties for the purpose. This is a capital arrangement for small growers, requiring but small outlay, while at the same time the best sorts are supplied for the purpose.

The distances in planting must to some extent be guided by individual conveniences; the grower who cultivates but a small plot can ill afford to allow the space another larger grower would deem advisable, the object of most amateur gardeners being to secure the largest weight possible from their restricted plot. The aspirations and means of numberless cottage gardeners do not lead them to migrate beyond local events; such being the case,

estimation may be made of the quantity required for any particular class or classes, allotting more than ordinary space for the requirements of the exhibition sorts. These should be allowed 30 inches between the rows, and a proportionate distance dividing the sets.

Methods of planting are varied, most persons having their own favourite style; but the intending exhibitor should not be content by planting with a dibber, this being the least satisfactory of all. My favourite plan is to put them in with the fork, digging the ground as the work proceeds. This leaves the soil light and open, so that the roots can ramify without any obstruction. The severe nature of the past winter will make the work of planting easy with those who dug or trenched their ground up roughly before the frost commenced. By no means should the work be attempted while the soil is wet, for nothing is more fatal to the after treatment of the present or future crops. The tubers being duly prepared by exposing them to the light in shallow trays, no occasion will arise for undue haste in committing them to the ground, and if any variety should be so limited as to require some of the largest being cut it should be done early enough for the wounds to be healed somewhat before planting time. A careful watch must be kept for the appearance of the growing shoots, for should late spring frosts prevail much damage attends the exposure of their delicate tops. This can be avoided by drawing some of the dry surface soil over them with the hoe, repeating it as occasion arise. The usual routine must be followed, moulding them up finally before the tops get very tall and the roots widely extended.—W. S., *Frome*.

ZONAL PELARGONIUMS FOR WINTER FLOWERING.

THERE are few plants pay better for good cultivation than the above whether for cutting purposes or for conservatory decoration. Their perpetual flowering habit, together with their wide range of colour, render them indispensable to those having to keep up an unbroken supply of decorative plants and cut flowers.

Their culture is comparatively easy, but to obtain the best results for winter the plants must be well prepared and receive special attention through the summer; but even well prepared plants will not continue blooming through the dull months of winter unless they can be placed near the glass in a light warm house and a dry buoyant atmosphere maintained. A well heated span-roof house running north and south, with ventilators for admitting air just under the hot-water pipes, and on both sides in the apex of the roof, is the best form of house for flowering Zonals through the winter. For flowering next winter no time should be lost in striking the cuttings, for it is most important to have their flowering pots well filled with roots early in the autumn. They may be inserted either singly in 3-inch pots or about six in 6-inch pots, but the former will be found the most economical unless space is very limited. There is no need for placing Zonal cuttings in a propagating case or even shading them from the sun, but a fairly moist temperature ranging from 55° to 65°, or ainery just started will suit them well. When rooted they should be removed to a greenhouse and grown close to the glass under cool airy conditions. To have the plants bushy and symmetrical their points should be taken out, and if possible not less than three shoots secured to each plant, and these again should be stopped about the last week in June and two more breaks secured from each of the three shoots, which will result in dwarf stocky plants having six shoots each.

After the first breaks have been secured the plants should be placed into their largest pots (5-inch and 6-inch). If properly attended to they will be established in the pots early in June, and then they are best stood out of doors on a bed of ashes in a sunny position. Remove all buds as they appear until six weeks before the plants are wanted in flower, and when the pots are full of roots assist the plants by giving them clear liquid manure every alternate watering; this should be of a varied description, and continued with discretion all through the winter.

We like to have the plants housed early in September, so as to provide abundance of ventilation for some time, as if they are subjected to anything approaching a close atmosphere the best leaves will turn yellow and fall, and the plants will thus receive a severe check at a very bad time. All through the winter they must be kept near the glass, and a dry bracing atmosphere maintained by a judicious use of the ventilators and hot-water pipes. I have said nothing about soil and potting, as this deserves more than a passing notice. A sturdy short-jointed growth must be aimed at in growing Zonals. A thin, sappy, attenuated growth will be of no use for winter.

Three parts good fibry rather stiff loam, one part half-decayed leaf mould, half a part old thoroughly pulverised cow manure, and

one part sand will suit Pelargoniums if properly used. To every bushel of the above compost one pint each of bonemeal and soot may be added, also a sprinkling of soot over the drainage. If the compost is in a proper state as to moisture it will be impossible to pot them too firmly, as firm potting helps considerably in securing a sturdy growth.

For cutting purposes we prefer the semi-double to either doubles or singles, as the former are apt to decay in the centre of the truss, and the latter, unless gummed, soon fall.—J. H. W.

THE WINTER AND ALPINE PLANTS.

THE severe weather which we experienced during the past winter had a decidedly detrimental effect on many delicate alpine plants, which are usually wintered in ordinary frames. For many herbaceous plants such a frame will suit very well, and indeed affords all the protection necessary, but with choice alpiners, which in a great measure retain their foliage during the winter, these conditions of shutting up continually will hardly agree. Fogs in particular play serious havoc with some of these, but as we have at present no means of banishing fogs we must endure the inconvenience.

I incline to the belief that the most difficult species to grow are quite capable of resisting very severe and long continued spells of frost with impunity, provided the foliage is dry. Some years ago I had what was regarded as one of the most complete collections of rare and choice alpiners near London, which during winter occupied four frames, each about 45 feet long by 4 feet wide. These frames were specially constructed for the better class, and hundreds of commoner sorts, of which we had abundance, and such as were perfectly hardy, remained outside with no protection at all. Those that were placed in the frames were not put there because we regarded them as tender, but simply to afford them protection from rain, and except when high winds were prevalent lights were constantly propped up day and night, front and back. Under these conditions the foliage of the plants was kept dry, an important item as regards the welfare of many a good alpine as we know them in English gardens. The constant stream of air which was passing over the tops of the plants dispersed all condensed moisture.

Nine-tenths of the valuable alpiners may be thus conducted safely through our most severe or trying winters, and rather than risk them in matted or even closed frames I should consider the plants more safe when fully exposed or plunged in the open ground.

Of plants that require immediate attention the genus *Primula* stands first. Many of these will be improved by the removal of any dead or decaying leaves that too frequently constitute a convenient hiding place for slugs, and which do a great deal of mischief in a short time. *P. minima*, which generally loses the greater portion of its leaves in winter time, by the singular formation of its tufts offers quite a home for small slugs, and in clearing away dead leaves look carefully after them. This lovely little Primrose should also be encouraged by surfacing with good soil, working it well into the tufts, for from the tiny stems composing them fresh roots issue in early spring. The forms of *P. viscosa*, *P. intermedia*, *P. nivea*, or *P. pubescens alba*, as it is now called, and which so long though erroneously enjoyed the name of *P. nivalis*, with *P. marginata* and others, will all be benefited by cleaning. The deciduous species, such as *P. rosea*, *P. denticulata*, and *P. Cashmeriana*, cannot be much improved at present, beyond ascertaining that their crowns are free from slugs; others again, such as *P. tyrolensis*, *P. integrifolia*, with others closely resembling these in habit will be perfectly safe. Slugs do not appear to harm these latter forms nearly so much. Any or all of these may be surfaced with good soil should they need it, but if this be not necessary many will require firming in their pots, through having been lifted up by the recent frost. For the present and so long as the atmosphere is heavily laden with moisture the larger portion of these *Primulas* will be safest if kept rather dry.—J. H. E.

VINES AND VINERIES.

VINE growers will have a busy time for some weeks, removing superfluous shoots, stopping and tying down those retained, together with cutting away superfluous bunches and thinning the berries in those left for the crop. Upon the manner in which each and all of these details is carried out depends in a great measure the weight and quality of the crop ultimately secured from the Vines. Of course, the due application of water at the roots as well as the distribution of moisture in the houses at the proper time are also important cultural details. All the weakest shoots must be rubbed off as soon as they appear, retaining only one, and that the strongest, on each spur. These may be situate about 18 inches apart alternately on each side of the rods. Gros

Guillaume and Trebbiano require a space of 2 feet between the laterals, stopping the individual shoots at a joint beyond the bunches.

The number of bunches to be left on each Vine must be determined by the size and vigour of each Vine as well as the variety. Taking 1 lb. of Grapes per foot length of Vines extending the full length of 19-foot long rafters as a fair crop from healthy vigorous Vines, that weight should be regularly distributed over each Vine into from six to eight bunches as a crop for such varieties as Black Hamburgh, Buckland Sweetwater, Muscat of Alexandria, Foster's Seedling, Mrs. Pinck's Black Muscat, Golden Queen, Alnwick Seedling, Gros Colman, Gros Maroc, Mrs. Pearson, Alicante, and Madresfield Court, allowing about half that number to remain on Gros Guillaume, Trebbiano, Syrian, and White Nice, as these varieties usually produce large bunches. In the case of well conditioned Vines of Lady Downe's ten to twelve bunches will not be too many for a crop. Retain the best shaped as well as the best placed bunches for the crop, choosing single in preference to double bunches or clusters. In addition to being more compact and symmetrical in appearance, these ripen and keep better than the clusters. The sooner the superfluous bunches are removed after the most desirable ones to retain have been ascertained the better it will be for those left to form the crop as well as for the Vines. The same remark holds good as regards thinning the bunches. This should be done as soon as the berries are set, retaining the "crown" berries and allowing a space of 1 inch between them, giving rather more room to the variety Gros Colman, this being the largest berried Grape in cultivation, and rather less to Mrs. Pearson, which is the best late white Grape we have, and in point of flavour and colour of berry is only slightly inferior when well grown to the Muscat of Alexandria.

In order to secure a good "set" the temperature and atmosphere when the Grapes are in flower should be 70° to 75° at night for Muscats and 65° to 70° for other varieties, and 5° higher by day with a moderately dry atmosphere, the Vines being tapped once or twice a day to distribute the pollen until the berries are all set. If the above conditions are observed and the Vines are all right at the roots no difficulty will be experienced in securing a good set of Grapes. In the case of Vines growing in borders which have not been renewed for several years give frequent surface dressings of Thomson's or other fertilisers during the swelling of the crop immediately before applying water at the roots. Alternate waterings of liquid manure and clear water, applied as described, will greatly tend to increase the weight and quality of the crop. If the drainage is good there need be no fear on the score of over-watering inside Vine borders, nor those outside either. The fact that Vines growing entirely in outside borders succeed so much better during a wet summer than they do in ordinary fine seasons affords sufficient proof of the correctness of this assertion. Hence it is that Vines growing in outside borders in many cases do better, and consequently ripen more satisfactory crops of Grapes, than are obtained from Vines having their roots confined to inside borders under the same management. I have frequently noticed instances of this kind, first in Vines under my own charge some fifteen years ago. If Vines are kept uniformly moist at the roots during the growing period, with a free circulation of fresh air through the house during the heat of the day, and the borders, walls, and trellis paths well damped morning and afternoon at closing time, a sturdy, clean, healthy growth in both Vines and crop will follow.

A gradual increase in the quantity of fresh air admitted into the vineries, and a corresponding diminution in the distribution of atmospheric moisture, should be observed from the time the berries begin colouring until they are ripe to give flavour and colour to them. In our principal range of four vineries the Vines are all planted in the inside borders, between the front wall and the hot-water pipes, with access to the outside borders. Last autumn I opened a trench 3 feet wide at 5 feet from the stems of the Vines, both inside and out the entire length of the four houses, cutting all the roots clean away within that space with a sharp knife, and filled up the trenches with sound fibry loam, with a liberal addition of wood ashes, soot, charcoal, and hydrate of lime. I also treated similarly one of three vineries, whose Vines are all growing in outside borders, and I am pleased to say that the Vines so treated have all started strongly and regularly, giving promise of the operation having produced the desired effect—namely, fresh vigour, the roots having pushed into the new soil before the fall of the leaf as was intended.—H. W. WARD, Longford Castle, Salisbury.

CULTURE OF THE GLOBE ARTICHOKE.

THIS hardy perennial plant is a native of Barbary and the south of Europe, and is cultivated, as everyone knows, for the immature flower heads, of which the base of the leaf, or scale, and the fleshy receptacle, are the parts used. The soil which the Artichoke prefers is a deep free soil, such as a sandy loam, and an open situation. The ground in which it is intended to be grown being liberally manured, and trenched at least 2 feet deep, mixing the manure with the soil in the process of trenching. If the natural soil be of a heavy, clayey nature, it would be advisable to open a few trenches at 3 feet from centre to centre, 2 feet wide, and the same in depth, some time between October and January, and fill them with a mixture of dung, leaf mould, road sweepings, wood ashes, and similar corrective materials preparatory to setting the plants therein in the spring. From plants thus grown some of the finest "Chokes" I have seen were produced. The Large Green Globe and Large Purple Paris are the best varieties.

The plant is propagated by suckers, which spring freely from the old stools or plants early in April. Usually from six to twelve suckers are

produced by each plant. As soon as the leaves have attained a length of 8 or 9 inches, two or three of those (round the outside of stools) having the greatest number of suckers must be taken off with a few root fibres attached. These offsets can then be planted with a garden trowel in clumps of three each set triangularly, 7 or 8 inches apart. Allow these clumps a space of 3 feet between the rows, and the same distance from clump to clump in the row. In planting make the soil firm about each plant with the hands, after which (in the absence of rain) they must be watered, to settle the soil about the roots, repeating the application at intervals of three or four days, until the roots have taken to the soil and the plants begin growing. Plant them about 4 inches deep, after which the ground may be forked over, a surface dressing of manure of about 3 inches thick being laid on the soil. These plants will yield a good supply in the autumn, and long after those planted a year or two previously have ceased bearing. It is a good plan to destroy a row or two of old plants every year, and to form an equal number of rows of young ones. The offset, or sucker plants, may also be used for filling any vacancies in the established plantations during the winter. In the southern parts of the kingdom Artichokes will be fit to cut during ordinary seasons the last week in June or the first week in July, and in the northern parts ten or fifteen days later. Cut the heads before the crown or top leaves show signs of parting—before they push into flower; otherwise they will be unfit for use.

Keep the beds free from weeds during the summer and autumn, and as soon as the crop is taken from each of the flower stems they should be cut down, and all dead leaves should be removed at the same. Before frost sets in—say, some time in November—a good thickness of stable litter must be wrapped well round each plant close to the ground, and up nearly to the top of the leaves, as a protection from frost, following this with a surface dressing of half-decayed manure between the plants, this being forked into the ground the following April, when, as already stated, blanks in plantations caused by frost can be filled in the manner indicated.—H. W. WARD.

GREEN FLY ON PEACH TREES—SETTING THE FRUIT.

It might be concluded from what has been written that these pests spring spontaneously into life upon Peach trees about the time they flower. No doubt a check to the trees or unsuitable atmospheric conditions will predispose the trees to attack. But these causes cannot bring the insects into existence, neither will syringing nor other treatment, however wise and good, prevent their appearance. Strawberries are frequently syringed, and yet it fails to prevent aphides establishing themselves on these plants during their early stages. Before plants or Peach trees are attacked the insects must exist either in the house or on the trees in some form until the temperature of the house and other conditions are favourable for their development. I am not surprised that aphides appear annually on Peach trees. I should be surprised if they did not when we consider the plants—including Strawberries, Chrysanthemums, and others—that are placed in these structures at various seasons of the year, especially early in the season when the houses are closed. For example, only a short time ago after being in a house where Richardias were being removed for fumigation I went to a Peach house and commenced disbudding, while pulling off my coat discovered aphides crawling about on it.

A sharp look out is needed to destroy the pests directly they are noticed, and before any damage is done. If we wait until the trees are out of bloom before fumigating them very often considerable injury is done. It is true the insects can be kept in check by dusting the affected parts with tobacco powder, or spraying the young shoots with tobacco water or some insecticide; but it is difficult to destroy all, because they soon establish themselves in the blooms. Suitable tobacco paper is very difficult to obtain; it is scarcely safe to use when the trees are in bloom—in fact, much of the paper now sold will injure the plants and not kill the green fly.

Good crops can be obtained by syringing the trees, but care and judgment are needed. It is not safe to trust this operation in the hands of a careless man. Full sets can be obtained without, and I have never seen any beneficial results from syringing. In late cool houses that are full of plants syringing would be more likely to prove injurious than the reverse. I have on several occasions had to shake the trees thoroughly to rid the flowers of moisture that has become deposited in them about ten o'clock, so as to give the pollen a chance of drying thoroughly by midday. Our method of setting for years has been with all kinds to maintain a circulation of air when the weather is favourable, and then give the trees a good shaking at midday. On dull days we raise the temperature slightly until the pollen will fly freely. I am of opinion that failure often results from maintaining too high a temperature during the flowering period. A temperature of 50° at night is ample, with a rise of 5° on dull days, with an advance of 5° or 10° more by sun heat. Rather than admit cold cutting winds we allow the temperature to rise considerably higher.—WM. BARDNEY.

FOR many years I was troubled with green fly on Peaches when they were in flower, and found the insects very difficult to get rid of, as the house could not be smoked without injuring the blooms. I tried a good smoking just as they were opening their first blooms, but that did not prevent the pests coming, although they did not seem to come so soon. Our Peaches are not trained under the glass in the usual way, but

upright across the house, and the house is filled with Chrysanthemums by the middle of September. As soon as they are in they have a good smoking, and since doing so I have not been troubled with green fly while the Peaches are in flower. I have come to the conclusion this smoking kills the green fly which may come into the house, and I think if all our houses were fumigated at that time we should not suffer so much the following spring and summer from green fly as we do, and most plants are hardier in the autumn and can stand smoke much better than they can in the spring.

I do not think a house can be so thoroughly cleansed during the winter months to reach them, as it seems natural for them to secrete in crevices beyond the reach of their enemies. Although much may be done by destroying them in old walls outside, we had a garden wall (covered with Peaches and Apricots) which was full of nail holes, and as we were very much troubled with green fly we gave the wall a washing of fresh slaked lime, working it well into the holes in March, and we have never been troubled so much with the pest since.—ALMA.

DELICATE DAFFODILS.

UNDER the albicans and cernuus series of the Ajax section of *Narcissus pseudo-Narcissus* some beautifully delicate white and sulphur Daffodils are included, and amongst these the variety here figured

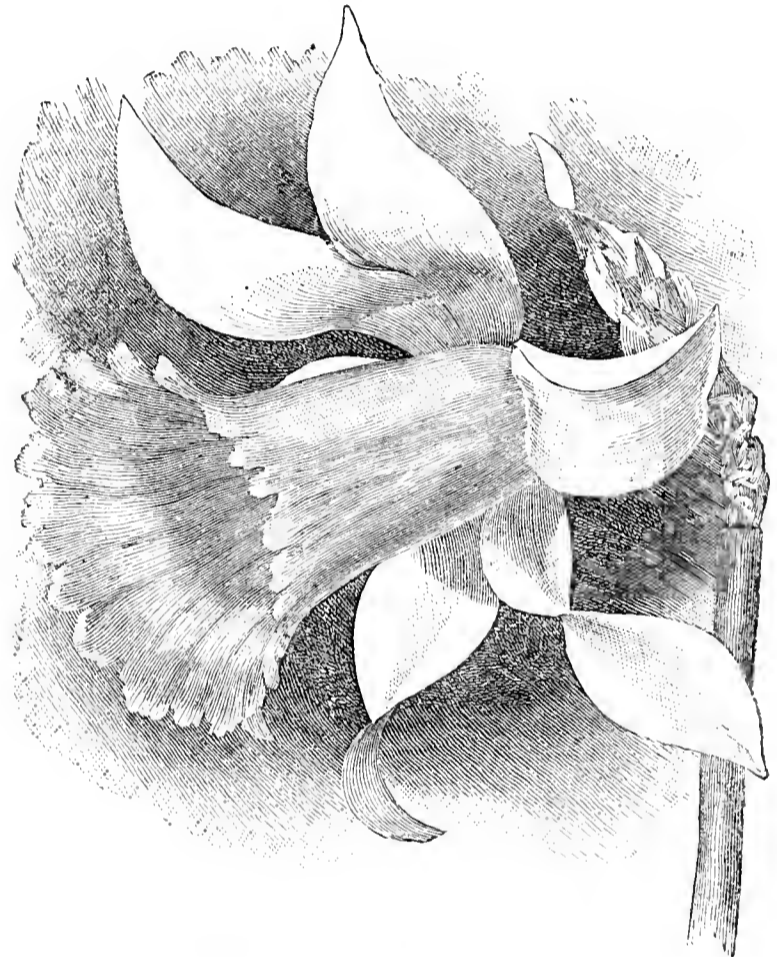

FIG. 55.—DAFFODIL DR. HOGG.

(Dr. Hogg) is one of the most elegant. It has a white perianth with a long even corona slightly recurved at the margin and of a soft sulphur tint fading to white. The illustration was prepared from flowers shown by Messrs. Barr & Son, King Street, Covent Garden, who have paid much attention to these white and creamy Daffodils.

The following are a few well marked forms:—Antoinette Sterling, uniform sulphur, trumpet having an elegantly spreading brim; Cernuus, perianth and trumpet silvery white and of the same length, early, and very beautiful; Cernuus pulcher, perianth silvery white, with a large bold spreading primrose trumpet, passing to white; Colleen Bawn, perianth and trumpet pure white, broad and twisted, graceful and early; Countess of Desmond, perianth sulphur, trumpet rich primrose yellow; C. W. Cowan, perianth white, trumpet sulphur, very distinct and elegant; Duchess of Connaught, perianth and trumpet primrose passing off white, neat flower; Lady Grosvenor, perianth white, trumpet sulphur white, brim elegantly recurved, very distinct; Madame de Graaff, this is the largest of all white Trumpet Daffodils, perianth and trumpet pure white and of great substance; Marchioness of Lorne, perianth sulphur white, trumpet primrose, brim elegantly recurved; Mrs. F. W. Burbidge, perianth white, trumpet straight, primrose passing to snow white; Mrs. J. B. M. Camm, perianth white and elegant, trumpet sulphur white, very graceful and distinct; Moschatus of Haworth (the snow white Spanish Daffodil), variable in size of flower, a charming variety, and the whitest of all Trumpet Daffodils, for pots, edging, beds, and bouquets; Princess Ida, large white perianth, large handsome white trumpet, brim flanged and conspicuously edged golden yellow; Silver Bar, perianth pale primrose, trumpet lemon yellow; Sir Stafford Northcote, perianth white, long pile sulphur trumpet, robust and distinct; Snowflake, white, tinged apricot, passing off pure white, very distinct and handsome; Tortuosus (*Leda*), perianth

pure white, twisted, somewhat shorter than the trumpet, which is pale sulphur passing to a snow white, exhales a delightful perfume; W. P. Milner, perianth and trumpet sulphur, small neat dwarf plant, with beautiful distinct flowers; and William Goldring, long snow white perianth, enveloping the primrose trumpet,

HORTICULTURE IN AMERICA.

[A paper by Mr. JAMES H. LAING, F.R.H.S., read at the Birmingham Gardeners' Association, March 9th, 1891.]

(Continued from page 291.)

WASHINGTON is the political capital of the United States, and is situated on the Potomac River. Its site is an admirable one. The plan of the city is, I think, like Versailles. The avenues and streets are simply magnificent, several streets being 160 feet wide. The public buildings are the chief attraction of Washington, and the capitol is not only the finest of these, but probably the most magnificent public edifice in the world, as it stands on $3\frac{1}{2}$ acres, and is surrounded with beautifully cultivated grounds, embellished with fountains and statuary. The United States Treasury, and other government offices, are also grand buildings. We ascend the Washington monument, the loftiest in the world, except the Eiffel Tower. It is 555 feet high. A grand panorama of the city and its surroundings is obtained at its summit. I made sundry calls at Washington nurseries. Mr. John Saul's nursery was crammed with excellent stocks of fruit trees, shrubs, and Conifers in great variety. A good collection of Orchids and other plants, also in capital health, were to be seen in the houses. Messrs. Field Brothers are splendid cultivators of Roses for forcing; the entire stock planted in benches in the several houses deserved special commendation. I have here to thank Mr. Hugh Kane of Strauss & Co. for pioneering me through the city and places of interest.

I did not omit to call and see that pattern of Botanical Garden Curators, Mr. Smith, a true and kindly Scot, and inspect his fine collections of plants and flowers. Mr. Smith is a man of repute, not only in Washington, but in the States generally. He is one of the Commissioners of Washington City, and holds other important pos's. Mr. C. F. Hale has a good nursery, and grows Roses on a large scale. Leaving with regret such a charming city and such friends, I took a sleeping carriage for Buffalo. I there called on another friend, Mr. Wm. Scott (an Englishman well known some years back at Chichester) at Buffalo, New York, on the side of Lake Erie, *en route* to Niagara. Mr. Scott grows general plants, but his Carnations always do well. His store in the city is neatly decorated and filled with floral displays. Mr. Scott was good enough to go with me to the Niagara Falls. What a sight it was! It is one never to be forgotten, though it cannot be realised unless seen. The Rapids, American and Canadian Falls, are extraordinary sights. We went on board the "Maid of Mist," amongst the passengers being the Toronto photographer who safely crossed the Falls on the wire rope last autumn, and then amidst the roar and splashing, we beheld the Horseshoe Falls and Cataracts in all their grandeur. Leaving the little steamer, we alighted on the Canadian shore, and returned over the new suspension bridge; the old one was carried away three years ago by a gale.

I am afraid I have dwelt too long upon some of the former subjects, so we shall return to New York once again, and before starting for home I found time permitted me to visit several friends up the lovely Hudson river. The Hudson has been compared to the Rhine, and what it lacks in crumbling ruins and castle-crowned steep is more than supplied by its greater variety and superior breadth, but I have seen no river to equal it. Many wealthy Americans have delightful seats here, and carry out gardening with taste. Jay Gould, Esq., has an elegant garden and houses at Irvington. Jas. B. Co'gat, Esq., Yonkers, also has splendidly kept houses and garden, the pleasure grounds being in fine form. Mr. Brett is a skilled gardener, and knows how and what to do. I was much struck with his Grapes, as the Vines were in full bearing when I called. Muscat of Alexandria and Lady Downe's (with 5 lbs. bunches), and Black Hamburgh, beautifully coloured, were equal to any seen in the old country. Winthrop Sargent, Esq.'s (a relative of Professor C. S. Sargent) place is one of the finest I saw of its size in the States for specimen Conifers, many rare specimens growing luxuriantly. Mr. Lister is an excellent Scotch gardener who emigrated to the States a few years since, and Americans should be proud to have a man of his stamp amongst them. Mr. Dinsmore's magnificent garden higher up the Hudson was in grand order when a friend and I by invitation visited it. A splendid collection of the choicest Orchids were well grown. Crotons had a separate house to themselves, and superb, well-coloured specimen plants they were. A general collection of stove and greenhouse plants were also represented in fine condition. Then, turning to the out of door arrangements, we found massive and well-designed flower beds in the flower garden facing the splendid range of glass, and sloping down from the terraces. Beds of well-coloured Crotons, Coleus, Alternantheras, and many other bedding plants, presented a brilliant display. I noticed Tuberos Begonias doing splendidly. Mr. Emmerson, the courteous head gardener, had evidently given these superb flowering bedding plants good soil and attention, and they had repaid this by the satisfactory results. I think Begonias will become a fashionable bedding plant in time in America, but they require a little more study and care when planted out, as to the position selected, and manuring the beds. If Mr. Emmerson's system is adopted they will soon secure public favour and find a prominent place in outdoor bedding out. Mr. Dunmore's noble mansion, though a wooden construction, as many of the dwelling

houses are, stands on a commanding position on the banks of the Hudson, from which beautiful views of the river are obtained. The gardens are superintended by Mr. Dinsmore in an admirable manner. Mr. Pierson's nursery at Tarrytown Heights (of Liliun Harrisii fame) was in excellent trim. I must refer, in drawing to a close, to the very pleasant visit I had at Glencoe, where Mr. Falconer, a true gardener, directs a large and beautiful estate so well for his employer, C. H. Dana, Esq. Several other calls were made, not forgetting a brief stay at Mr. W. Elliott's notable auction rooms, by whose vivacity lucrative prices are realised, and then terminated the most enjoyable tour I have been fortunate enough to take.

I will now briefly give my own opinions of our American horticultural friends in business capacities. The Americans are a wide-awake people. They do not like to be behind the world in anything. I think the majority of their horticultural tradesmen are smart, business-like men, quick of perception, not niggardly in their commercial purchases, though keeping a keen eye all the same after turning the dollar at as big a profit as possible. There seems to me to be also more fraternal intercourse, particularly noticeable in the Boston Convention. Social meetings, lectures, conferences, and all other things pertaining to the advancement of horticulture are done to encourage and educate the masses. Labour is the great detriment, even an ordinary boy receiving about 20s. a week. This is a serious expenditure, so that many things are adopted to reduce the labour bill. The indiarubber hose is used largely for watering and damping down in the stove, greenhouse, Rose, Carnation, Chrysanthemum, and even Orchid houses, doing away with the slow, though perhaps the more effectual method, as we English think, of the watering can. Floral societies seem to be flourishing in all parts. Florists' shops, as a rule, are elegantly and artificially arranged, a good deal on the Parisian method, though cleanliness and neatness are even more scrupulously carried out. Designs of kinds are used largely and with effect. The florists are very clever in their floral decorations of ballrooms, house ornamentation at receptions, New York *élite* of society especially spending large sums on these affairs.

I am told there are over 10,000 florists in the United States, and their greenhouses cover about 1000 acres. Forcing Perpetual and Tea Roses is the American florist's great forte, and from what I could see (though too early to judge personally) and learn, the blooms produced during the winter months far exceed our own. The great thing in their favour, however, is the appearance of the sun, and though the temperature often falls as low as six or eight below zero, the sun's rays expand the flowers freely, and produce fine colour. Roses are grown on their own roots a great deal, and propagated from January to April, using for cuttings well-matured wood from healthy plants. If the cuttings have bottom heat they will be rooted in about four weeks, when they can be potted off in $2\frac{1}{2}$ -inch pots. If properly grown, these will in four or five weeks need repotting into 4-inch pots. As soon as they are well established in these they can be planted into the benches where they are to remain. The benches should not be more than 4 to 6 inches in depth. Before turning the plants out of the pots they should be well watered, for if planted with dry balls they will seldom do well. Thoroughly water the bench after planting, syringe well every clear day, and cultivate the soil once a week for the first month. The soil is then firmed around the plants by pressing it down with the hands, and do much better if the soil is firm; after this cultivate lightly. A heavy loamy soil is preferable. The number of varieties of Roses, which may be considered as staple since they are quoted as wholesale in most of the large markets in the country, is about twenty-five, as follows:—Bon Silene, Safrano, Isabella Sprunt, Niphotos, Perle des Jardins, Sunset, Papa Gontier, Souvenir d'un Ami, Madame Cusin, Souvenir de Malmaison, Maréchal Niel, Cornelia Cook, William Francis Bennett, Pierre Guillot, Bride, Catherine Mermet, American Beauty, Général Jacqueminot, La France, Baroness Rothschild, Madame Gabriel Luizet, Magna Charta, Anna de Diesbaeh, and Duke of Connaught. Other varieties which are grown for the market, but less generally, are Douglas, Duchess of Edinburgh, Yellow Tea, Royal Tea, Lamarque, Reine Marie Henriette, Climbing Devoniensis, Boule de Neige, and an assortment of Hybrid Perpetuals, which are forced for winter use. The most desirable points in a market Rose are continuous and abundant blooming, long stems bearing single buds, which is a most important point, 2 and 3 feet being the usual length, and robust foliage with fragrance, clear colour, and good keeping qualities in the flower.

(To be continued.)

INJURIOUS INSECTS AND METHODS OF PREVENTION.

I HAVE received the interesting book, "Manual of Injurious Insects and Methods of Prevention," written by that learned and indefatigable lady Miss E. A. Ormerod, and the volume I shall regard as a precious possession.

I have not yet had time to peruse the book entirely, but only examined a few articles on subjects with which I am acquainted, and was as astonished by the correctness, the completeness and clearness with which these subjects are treated. The way in which the work is brought together is highly practical, and a skilful sub-division makes it most easy for consulting and most acceptable for the library. My opinion is that it ought to be in the hands of every gardener, every farmer, and every amateur of gardening. This reminds me of the hard battles I have had to fight against several insects, and induces me to record two struggles in which I obtained a complete victory. The means I used were in accordance with the methods described by Miss Ormerod,

but it may be useful to record the ways in which I worked them out so successfully.

The American Blight (Schizoneura lanigera).—Some years ago this pest was introduced in our gardens by some new varieties of Apples received from France, and within a short period nearly the whole of our young Apple trees all over the nurseries were infested. We possessed at that time the now well-known English insecticide Gishurst compound, or sort of soap, made up with nicotine or some other poisonous substance, and which had proved to be very effective in destroying green and black fly, thrips and scale in our greenhouses and gardens. I decided at once to try it on the Apple blight, and proceeded as follows:—

A lump of Gishurst was dissolved in water in such a proportion as to obtain a thick liquid of the consistence of oil paint. A strong painter's brush was provided, and one of our assistants was appointed to the work. He was to examine every Apple tree, and to look on every side and corner after the aphides, which at the beginning of the spring are clustered in the crevices of the stems or on the under side of the young twigs, and apparent enough by the white down or wool which covers their bodies.

The man was ordered to touch firmly, and to brush with the paint every visible white spot, and to go from tree to tree all over the ground. The trees being young, and not above 8 feet high, were examined and brushed, where necessary, in a relative short time. We began on a Monday, and arranged that the same man should do the same work every Monday morning for his first work.

After two or three operations many clusters or nests had already disappeared, and a strip of bast was put as a mark on every tree which still showed signs of the presence of the insect. This spared much time afterwards, and by taking away the mark from the healed trees the number of invalids to be brushed diminished every week, and at the beginning of August the last infected trees were cleaned, and since that time our nurseries have been completely free from the pest. It was extirpated at a trifling cost and not too much labour.

The Cockchafer (Melolontha vulgaris).—One of the most troublesome and voracious insects which infest many gardens and nurseries in Belgium and in France, is certainly the grub or maggot of the cockchafer, which in France is called *ver blanc* (white worm), and in Belgium *vet maai* (fat grub). It is specially plentiful in the neighbourhood of plantations where Beech, Hornbeam, and Oak trees are abundant, and as the grub remains quite three years in the ground before it makes its metamorphosis into a cockchafer the number accumulates, and their ravages must be enormous.

We were troubled with this plague for many years, and tried different ways to master it. We hunted and killed the cockchafer as much as we could, and paid sometimes one franc for every hundred. We dug all the beds where the young plants and trees were dying from the attacks of the grubs which wandered under the ground from root to root. We caught part of them, but these and other means were of little avail, as the whole of the land was infested, and the grubs scattered in every part of the ground.

I had observed that certain birds were very clever in finding the cockchafer, especially the rook, the magpie, and the starling; but the rook and the magpie are shy, and do not like to descend in gardens and nurseries where men are working. The starling, on the contrary, is not afraid to reside and to live near buildings and habitations. The birds like to make their nests in places having but a small opening, through which they can fly in and out. A wooden box about 8 inches square, with a hole the size of a crown piece in the middle of the front side is what they prefer, especially when the box or case is fixed on a pole some 8 or 10 feet high, and not too near any tree.

I prepared in this way a few boxes the first year, and a pair of starlings did not wait long before selecting one of them for their habitation. The second year the other boxes were occupied, and the third year I planted half a dozen more on poles about 50 yards apart, and all of them became inhabited the same year. Since that time more than 100 boxes have been placed in different parts of the grounds, some of them 600 yards from the first installation, and in every case they have been occupied by a family of starlings.

The pairing time of these birds is about the end of March, and they lay five to six eggs, which are hatched in about eighteen days. The young ones remain a long time under the care of their parents, and are exclusively fed with insect food. This period coincided precisely with the season at which the cockchafer is crawling from under the ground to make his appearance and fly in the wide world.

In watching one of our box nests occupied by young starlings it is a pleasure to observe the parents arriving at short intervals, and presenting their offspring with a fat morsel, which in reality is a cockchafer deprived of its wings, head and claws.

I have reason to believe that every family of starlings consumes at least fifty cockchafers in one day, and as the chasing goes on for weeks the slaughter of chafers must be enormous. The fact is that since our installation was completed young grubs are no more to be found in our grounds, and I feel confident that with our 200 nesting boxes, giving us

a yearly supply of clever combatants, we shall be in a very short time completely released from the cockchafer plague.—CHARLES VAN GEERT, *Antwerp.*

[All visitors to Mr. Van Geert's extensive and highly interesting nurseries of trees and shrubs at Calmpthout must have observed the nesting boxes to which he refers, one of which we reproduce from a sketch by an English tourist.]

BOMBAY GARDENS.

(Continued from page 241.)

THE Mango Tree, which rarely in Bombay is seen to assume that perfect shape by which it at once attracts the attention in the jungle or along the country roads, is still very attractive by the beauty and varying colour of its leaves, in which tints of pink, violet, mauve, copperd, and all shades of green are of no rare occurrence, while the individually inconspicuous flowers when covering the tree with their masses are very effective. The *Spathodea campanulata*, with its large brilliant scarlet flowers in great clusters, is still too rare in Bombay gardens. The Indian Laburnum (*Cassia fistula*) with its large drooping sprays of pure yellow flowers, is a most beautiful object, far surpassing the English Laburnum in beauty. The *Lagerstræmias*, with their large fringed mauve, pink, or white flowers, are universally admired, but are far surpassed in gracefulness by the *Lagerstræmia parviflora* of our hills, which I hope ere long to see commonly established in Bombay gardens. The *Sterculia urens* with its large hand-shaped leaves is not a bad substitute for our Plane trees at home. The *Michelia champaca*, the sacred pila "Champa," is famed for its strong scented yellow flowers, which are much used by native women for adornment of their hair, thus occasionally serving a double purpose, that of ornament and that of a powerful insecticide. The *Plumieria acuminata*, another "Champa," with its handsome strong scented white, yellow, and often pinkish-tinted flowers is a general favourite. A dark red-flowered, scentless kind has lately been introduced.

The most striking tree of our gardens is perhaps the Lettuce Tree (*Pisonia alba*), which cannot fail to attract attention by the splendid effect of its bright yellow foliage, nowhere I believe so perfectly developed as in Bombay. The Kurranj Tree (*Pongamia glabra*) reminds us very much of our Beech tree at home, when producing its light green new foliage in the hot weather. Bombay can only boast of a few handsome specimens of the Tamarind tree, which grows to so great perfection up country. Some fine specimens of the beautiful Jack Tree (*Artocarpus integrifolia*) and of the Bread-fruit Tree (*A. incisa*), which perhaps has no rival in beauty of foliage, are occasionally met with, as also of the wild Mangosteen (*Garcinia xanthochymus*), distinguished by its extremely handsome pyramidal growth, and the Putranjiva Roxburghi, to which the drooping branches covered with handsome foliage and white nuts lend a peculiar charm. Among other common trees the country Almond (*Terminalia catappa*), with its regularly whorled branches and handsome large leaves, the Si k Cotton tree, with its prickly stem and branches and dark crimson flowers, the Undi (*Calophyllum inophyllum*), with its glossy foliage and handsome sweet-scented white flowers, are sufficiently common to be noticed, while the beautiful scarlet flowered *Cordia sebestana* is perhaps the most appreciated tree of all in Bombay, and the Malayan Rose-apple (*Eugenia molucana*), when its branches are loaded with bright purple flowers is well calculated to attract attention. Of trees of more recent introduction I shall but mention a few which promise to become favourite inhabitants of our gardens.

The Rain Tree (*Pithecolobium Saman*) with its handsome glossy foliage and pink flower clusters vieing in beauty with the indigenous "Lu ei" (*Albizia stipulata*), a tree that ought, sooner or later, to find a place in our gardens; the *Peltophorum ferrugineum* of perfect shape, with dense handsome foliage and beautiful yellow flowers succeeded by shining brown pods; *Solanum maroniense*, the Potato Tree, with large prickly leaves, and handsome, large, dark violet flowers changing to pale lilac; the Australian Oak (*Grevillea robusta*), with silvery grey finely cut leaves; the Star Apple (*Chrysophyllum Cainito*), of graceful drooping habit, with dark green leaves which are golden brown beneath; and the Australian Bottle Brush Flower, *Callistemon speciosus*. The only representative of the order of Coniferae, which to such a great extent assist in the adornment of our gardens at home, are two or three kinds of *Araucaria* (*A. Cunninghamii*), *A. Cookii*, *A. Bidwillii*, and a few kinds of *Thuja* and *Cupressus*, but neither of them succeed well enough to deserve general cultivation. The allied *Casuarinas* are, however, common in Bombay, and are often trimmed into quaint pyramids and other ungainly shapes.

The Palms form a conspicuous feature in Bombay gardens. Nothing can rival the beauty of a young healthy Cocoa-nut Palm, with its graceful feathery arched leaves. The common wild Date Palm with its spiny greyish densely tufted leaves is frequently very effective, specially when young, and the magnificent head of large fan-shaped leaves crowning the stems of the common "Brab" or Palmyra Palm is very picturesque. The Fishtail Palm, *Caryota urens*, is at once graceful, peculiar, and highly ornamental. Its long drooping clusters of flowers and fruits, originating from the stem, are a feature that strikes all strangers with wonder and surprise. The Betelnut Palm has often been called the most graceful of Palms, and is when loaded with its bright scarlet fruits, in truth, a striking object. The *Oreodoxa regia*, the *Ptychosperma Cunninghamiana* (*Scaforthia elegans*), the Oil Palm (*Elai guinensis*), *Livi-*



FIG. 56.

tona sinensis, *L. australis*, *Washingtonia filifera*, *Coccos plumosa*, *Phoenix rupicola*, *Hyophorbe Verschaffelti*, and other Palms occasionally met with are all very graceful and desirable objects in Bombay gardens, but none of them surpass in grandeur of foliage or magnificence of flowering the Talipot Palm (*Corypha umbraculifera*), which, however, unfortunately is very rare in Bombay gardens. Though not belonging to the natural order of Palms, *Cycas*, commonly called Sago Palms, must be mentioned here as very common in Bombay gardens, and nothing may perhaps be compared to the beauty of the light green feathery, gracefully arching crown of new leaves, contrasting beautifully with the spreading and recurve dark green leaves of the *Cycas circinalis*, though the much smaller *C. revoluta* is not without effect. The Screw Palms (*Pandanus*) form other most picturesque objects of our gardens, while the allied but very differently shaped *Carludovica palmata* is a frequent ornament. The Traveller's Palm (*Ravenala madagascarensis*) with its peculiar flattened crown of Plantain-like leaves is perhaps one of the most characteristic of tropical plants.

(To be continued.)



EVENTS OF THE WEEK.—The Royal Society meet at 4.30 P.M. to-day (Thursday), also the Linnean Society at 8 P.M. The Quckett Club have a meeting on Friday, April 17th, at 8 P.M., and the Society of Arts on Wednesday, April 22nd, at 8 P.M. The Royal Horticultural Society's Committees will meet on Tuesday, April 21st, at 12 noon, in the Drill Hall, James Street, when there will be an Exhibition of Daffodils, Orchids, fruits, and vegetables; the National Auricula and Primula Society's Show will also be held on the same day, and a lecture on Cape Bulbs will be delivered by Mr. J. O'Brien at 3 P.M. The Royal Botanic Society's second spring Show of the season will be held on Wednesday, April 22nd.

— **THE GARDENERS' ROYAL BENEVOLENT INSTITUTION.**—Just as we are going to press we learn that Mr. George Ingram, Secretary to the Working Boys' Homes, Buckingham Street, Strand, has been appointed Secretary to the Gardeners' Royal Benevolent Institution as successor to the late Mr. E. R. Cutler.

— **THE WEATHER.**—Somewhat more favourable weather has to be recorded in the metropolitan district this week, but the winds still continue cold. Rain has fallen on several days; there have been occasional glimpses of sunshine, but the temperature has averaged rather low generally.

— **THE WEATHER IN THE NORTH, APRIL 13TH.**—The weather during the past two weeks has been on the whole dry, but with bitterly cold easterly winds throughout. Slight frosts have occurred on one or two mornings. Vegetation has made very little progress. Within the last day or two a slight tinge of green is observable on our hedges, but everything is late.—B. D., *S. Perthshire*.

— **BIRMINGHAM GARDENERS' ASSOCIATION.**—At the closing meeting of the winter session, Mr. H. E. Milner, the well-known landscape gardener, read a paper on "The Influence of Art in Practical Landscape Gardening," and gave much valuable advice as to the formation of pleasure grounds, terraces, planting, and the formation of ornamental pools of water, or the development of existing sheets of water. The great experience Mr. Milner has had in this kind of work enabled him to treat the subject in a masterly manner, and to the entire satisfaction of his audience. A cordial vote of thanks was given, the proposer speaking of the high position Mr. Milner's father held as a landscape gardener, and as an old pupil and friend of the late Sir Joseph Paxton.

— **THE show fixtures of the NORFOLK AND NORWICH HORTICULTURAL SOCIETY for 1891 are as follows:**—Spring Flower Show, St. Andrew's Hall, Norwich, April 23rd; Rose Show, Catton Park, Norwich, July 2nd; Chrysanthemum Show, St. Andrew's and Blackfriars' Halls, Norwich, November 19th and 20th.

— **ANDROMEDA FLORIBUNDA.**—This North American shrub is now in full flower, and no plant better exemplifies the difference existing between those planted in suitable soil and those which are not. Where sandy peat mixed with leaf soil is employed it grows freely and flowers

profusely; the leaves also are of a deep green colour, which fact alone betokens health. In a heavy retentive soil, and especially that in which chalk is mixed, it does not make any headway, but will remain about the same size for many years; but if replanted in better soil a difference will soon be discernible. The pure white flowers are somewhat marred in appearance by their drooping habit, and the pale green calyx which partly obscures the flowers when looked at from above. But in spite of this, for the rockery or small beds this is a capital early flowering shrub.—E. M.

— **GARDENING APPOINTMENT.**—Mr. Albert Baxter, foreman at The Gardens, Canford Manor, Wimborne, has been appointed gardener to Lord Rodney, Berrington Hall, Leominster, Herefordshire.

— **WE are requested to state that MESSRS. WALTER CARSON AND SONS**, of anti-corrosion paint renown, have found it necessary, in consequence of the great extension of their business, to remove from La Belle Sauvage Yard to the Grove Works, Battersea.

— **RANUNCULUS ANEMONOIDES.**—For flowering on the rockery in the spring months this is a useful plant. Its parsley-like foliage forms a good contrast to its blush-white coloured flowers, about the size of a shilling, which are freely borne singly on stout footstalks, and which last fresh a long time. Where the soil is shallow this *Ranunculus* will flourish, hence its value where early flowering hardy plants are appreciated.

— **CHIONODOXA LUCILÆ.**—This early flowering bulb is more attractive than ever this year, as the clumps appear to have thrown up more flower spikes. We have it growing in several places on the rockery, where it has a good root run, which it seems to enjoy. Many seedling plants from the originals here are now flowering well. I consider it far more showy than *Scilla sibirica*. The *Chionodoxa* flowers stand more erect, so that they can be seen easily. The outer part of the petals is a deep blue, which fades to pure white in the centre. The slender looking spikes vary in the number of the flowers they carry, ranging from six to eighteen. Seedlings should not be disturbed for three years.—S.

— **THE WEATHER IN MARCH.**—This was a cold month all through, with snow on the 9th at night, which was 4 inches deep at 9 A.M. on the 10th, and lasted in some places until the 16th; we had sleet occasionally all through the month. The total rainfall was 1.21 inch, which fell on twenty days, the greatest daily fall being 0.22. Snow on the 9th. Barometer highest, 30.32 at 9 P.M. on the 3rd; lowest, 29.24 at 9 P.M. on the 15th. The wind was in a westerly direction seventeen days. Highest shade temperature was 63° on the 1st; lowest, 21° on the 12th; lowest on grass, 16° on the 12th; mean temperature of the month 40.05°. The garden spring ran 12 gallons per minute on the 31st. Grass fields commenced to become green again during the last week of the month.—W. H. DIVERS, *Ketton Hall Gardens, Stamford*.

— **ASPARAGUS PLUMOSUS.**—Propagation by division of the crowns of this *Asparagus* is a slow method, and divided plants often have strong crowns and quickly run up tall, which renders them unfit for decoration in small pots. Small handsome plants can only be obtained by this method when a plant makes quantities of small crowns instead of large ones. Useful plants can, however, be obtained in a very short time by cutting up one of the stems when matured. Portions 1 inch long with a joint and a "leaf" form a capital cutting. The smaller the plants needed at first the smaller should be the stems selected for cutting. Insert each piece singly in thumb pots in sandy soil, burying the stem half an inch deep. If these are placed in brisk heat under handlights, shaded and kept moist, they will be rooted and pushing up crowns in a month. Large quantities from one plant can be raised by this method in a short time, and will be found invaluable either in the conservatory, in rooms, for the table or any purpose for which decorative plants are required. In a cut state there is no comparison between the fronds of Ferns and these for lasting.—O. M.

— **I HAVE read Mr. Laing's account of his visit to U.S.A. with interest, especially that relating to Mr. Henderson's SYSTEM OF HEATING BY STEAM.** Would any correspondent kindly inform me where I can obtain particulars of this mode of heating, also a little explanation as to the following (I could give it a fair trial, as I am about to heat 10,000 feet of glass):—1, What is the pressure on pipes and boilers? 2, Whether good ordinary hot water (vertical, with plenty room for steam chamber) would do? 3, On what principle does it work? Does the steam have vent and escape, or condense and flow back again into

the boiler? I have thought that the mains and centre pipes could be made to take the steam at higher pressure, letting it into 3 or 4-inch hot-water pipes near Vines or plants from these mains, on the principle of the steam going from the high pressure to the low pressure cylinder in the triple expansion engine.—OMEGA.

— EARLY POTATOES IN IRELAND, THIS YEAR'S CROP.—One of the finest samples of early Potatoes we have ever seen at this period of the season have been sent us by Mr. R. Allison, gardener to Mr. Hume Babington, Creevagh. They are of the variety known as Sutton's Early Regent, and are exceedingly healthy and well grown. They were planted in December in the garden, and only covered during the night.—(*The Londonderry Sentinel.*)

— SUMMARY OF METEOROLOGICAL OBSERVATIONS AT HODSOCK PRIORY, WORKSOP, NOTTS, for March, 1891, 56 feet above mean sea level.—Mean temperature of month, 40.0°. Maximum on the 1st, 58.5°; minimum on the 9th, 22.6°. Maximum in the sun on the 26th, 110.3°; minimum on the grass on the 13th, 14.4°. Mean temperature of the air at 9 A.M. 39.4°; mean temperature of the soil 1 foot deep 39.7°. Nights below 32°, in shade thirteen; on grass, twenty-two. Total duration of sunshine in month ninety-nine hours, or 27 per cent. of possible duration. We had five sunless days. Total rainfall, 1.31 inch. Rain fell on nineteen days. Average velocity of wind, 13.8 miles per hour. Velocity exceeded 400 miles on nine days, and fell short of 100 miles on three days. Approximate averages for March:—Mean temperature, 41.8°; sunshine, ninety-eight hours. Rainfall 1.61 inch. A rather cold, dry, and windy month with average sunshine; a few snow showers at times, but none to lay on the ground. Vegetation very late; no signs of spring growth at the end of the month. Some rain and warm weather much wanted.—JOSEPH MALLENDER.

— THE COTTON PLANT IN THE UNITED STATES.—The Director of the Agricultural Experiment Station of the Agricultural and Mechanical College for the State of Alabama has issued his Bulletin No. 13, which is devoted to an exhaustive account of the different varieties of Cotton grown in the State, by Mr. P. H. Mell, the Botanist and Meteorologist to the station. According to Mr. Mell, says *Nature*, only three species of *Gossypium* are of special commercial importance—viz., (1) *G. Bahma*, or Egyptian Cotton; (2) *G. barbadense* or *nigrum*, Sea-Island Cotton, or Long Staple, or Black-seed Cotton; (3) *G. herbaceum* or *album*, Short Staple or Upland, or Green-seed Cotton. These three species have been multiplied into twenty or thirty so-called varieties, by certain kinds of cultivation and careful selection. *G. Bahma* is supposed to be originally a hybrid between the native Egyptian Cotton Plant and a species of *Hibiscus*. The "Sea-Island Cotton" requires a salt atmosphere, and is mainly used in the manufacture of lace. Mr. Mell gives the microscopic characteristics of twenty-five varieties of Cotton, and his descriptions are accompanied by photographic illustrations made with a photo-micro camera and micrometer. The Bulletins are supplied free on application to any citizen of the State.

— BOTHWELL BANK AND PRESIDENT STRAWBERRIES.—In the *Journal of Horticulture* recently Mr. G. McDougall asks, Is Bothwell Bank Strawberry President under another name? As far as my experience guides me I say certainly not. When I came here I had a few runners of Bothwell Bank, and I planted two rows by the side of President. My plan is to plant half the quantity required here one year and half the next, so that we only take two crops from the plants before they are destroyed, and during the last eight years the above named have always been grown side by side as succession varieties, President coming in from six to eight days before Bothwell Bank. The fruit of the latter with us is paler in colour, much more cockscomb-shaped, and nearly as large again as President, and equal in flavour to anything we grow; in fact it is the favourite Strawberry here. The foliage, too, is paler, and is easily distinguished from President. It also forces well. I might add that many well-known first-class Strawberries will not do well with us—for instance, Dr. Hogg, British Queen, Sir J. Paxton, and several others. Our best are President, Bothwell Bank, Sir Charles Napier, and Helena Gloede. Noble we only planted last autumn, and therefore have no experience of it on our soil, which is a heavy marly loam resting upon a subsoil of sandy clay. The natural soil does not contain more than 1 per cent. of lime, which probably accounts for some varieties not doing so well as others. It is the same with Peas. Such excellent varieties as Veitch's Perfection and Stratagem are not satisfactory here, and it will be easily understood how well Rhododendrons thrive here in the natural soil with this absence of lime.—J. DOUGHTY, *Angley Park, Cranbrook.*

— THE COMMON YELLOW COLTSFOOT AS AN AQUATIC.—I saw this plant in full bloom and growing luxuriantly at the sides of an ornamental pool of water, some of the plants being quite immersed, and seemingly thoroughly at home in this perpetual bath; and it was growing freely in the immediate locality of the pool, and as a spring-blooming plant I thought that if it was not so common and so very difficult to exterminate when getting beyond bounds how much we should value it as one of our harbingers of spring. Useful as it is for making a delicious wine from, our yellow-flowered friend will not be received with open arms for garden work.—D.

— UNITED HORTICULTURAL BENEFIT AND PROVIDENT SOCIETY.—The quarterly meeting of this Society was held on Monday evening last at the Caledonian Hotel, Mr. Nathan Cole in the chair. Six new members were elected, making a total of twenty-five in the three months. Two members have died during the quarter, Mr. J. W. Vine of Oak Park, Tralee, and Mr. R. H. Bard of Forest Hill. The amount standing to the credit of the late Mr. Vine, £13 4s. 3d., was paid to his widow at the March meeting, and the Committee has also granted £5 from the Benevolent Fund, Mrs. Vine being left with four young children. The sum standing to the credit of the late Mr. Bard (£39 8s. 5d.) was also paid to his widow. A general meeting was held after the Committee meeting for the purpose of altering rule 20 respecting the date of the annual meeting. The rule will now read "second Monday in March," instead of second Monday in February.

— COMTE BRAZZA'S VIOLET.—I can quite endorse all that Mr. Oliver writes in praise of this charming variety. For winter and early spring gathering it is unsurpassed, and has given a far greater percentage of blooms than either The Czar or Marie Louise, when grown and treated in precisely the same manner. Another great point in its favour as a winter frame Violet is, that it is less liable to damp than any other variety, and will when necessity occurs, as during the past winter, when the frames had to be kept closed with heavy covering to exclude frost for weeks together, keep fresh and green with scarcely a damped leaf. I notice that some of your correspondents take exception to this variety as not being a pure white, and also to its having a green centre. This may be true to a certain extent, but it only happens in the autumn, after the plants have been lifted and before they become re-established, or through the plants being weakly and worn out. Under proper management and treatment the flowers produced should be pure white, double, and very fragrant. It seems highly essential that this variety to succeed well should have the protection of a cold frame. Plants that are allowed to remain in the open all winter suffer to such an extent that they are unable to produce their flowers at the proper time.—JOHN AUSTEN, *Witley Court Gardens, Stourport.*

— ALLIUM NEAPOLITANUM.—This plant is so useful in pots that no garden should be without a few dozen bulbs. The pure white flowers with stalks 18 inches long are well suited for vases with other flowers and some greenery, it also keeps well in a cut state. A pretty arrangement I once saw consisted of a groundwork of *Pelargonium* Henry Jacoby, from which rose flower heads of this *Allium*, the pure white of which contrasted so well with the dark velvety red of the *Pelargonium*. The culture of this bulb is a simple matter. Early in October place four bulbs in a 3½-inch pot in fairly good soil, plunge them for a time in cocoa-nut fibre refuse until new growth has started, afterwards stand them in a cold frame close to the glass to prevent the foliage being drawn weakly. Protect the plants from frost, and admit plenty of air to the frame on all favourable occasions. Here they may remain until the flower spikes are coming, when a light position in the greenhouse will suit them. Abundance of water at the roots, alternating it with liquid manure, will be of much service in encouraging strong flower spikes and ample foliage. If larger potfuls are required put about six bulbs in a 5-inch pot.—E. M.

— THE "FLORA OF BRITISH INDIA" has reached the seventeenth part, and Sir Joseph Hooker may be congratulated on having so nearly accomplished his great task. Since his retirement from the Directorship of Kew Gardens, Sir Joseph has worked single-handed, and several large families yet remain to be done, notably the Grasses, which are very numerous, and, in some respects, more difficult than the Petaloid Monocots, and mainly so because the majority of the species have a much wider area of distribution, thus entailing more literary research. The last published part of the "Flora of British India" is of more than ordinary interest, inasmuch as it contains the conclusion of the descriptive account of the Orchids of India. About 1400 species are described; they are referred to upwards of a hundred

genera, and they constitute about 10 per cent. of the flowering plants of that vast country. This is a larger proportion than that recorded for the rich Orchid flora of Mexico and Central America. Among epiphytal, or tree Orchids, the beautiful genus *Dendrobium* contributes upwards of 150 species, and *Habenaria* among ground Orchids numbers 106 species. All lovers of Orchids will welcome this masterly synopsis of the Indian species, and all botanists will wish the eminent author health to finish his great work.—(Nature.)

THE BIRMINGHAM SPRING FLOWER SHOW.

THE weather was very unfavourable on the 8th and 9th inst. for the eighth annual Exhibition, still there was a larger attendance than last year, and a first-class display was brought together. Hyacinths, always a feature at these Exhibitions, were very numerous, but not up to the usual standard of excellence; and this was not to be wondered at with the many difficulties growers have had to contend with. The chief exhibitors were Mr. J. Palmer, gardener to Wm. Brown, Esq.; Mr. Dyer, gardener to Mrs. Marigold; Mr. E. Cooper, gardener to the Right Hon. Joseph Chamberlain, M.P.; J. B. Manley, Esq., and others. Of some kinds there were good specimens, especially in blues, of *Czar Peter*, *Grand Maître*, *Blondin*, *Marie*, and *King of the Blues*. In reds *Roi des Belges* is very bright and fine, so also *Lord Macaulay*, *Cardinal Wiseman*, *pale blush pink* and *very fine spike*, and *Mont Blanc* were conspicuous. There was a rich and extensive display of Tulips in the various classes, none of them drawn, and all with good foliage, excellent culture predominating. The white variety of *Joost Van Vondel* was conspicuous as a very lovely white, and *Proserpine*, *Keyzers Kroon*, *Chrysolora*, *Vermilion Brilliant*, *White Pottbakker*, *Joost Van Vondel*, *Ophir d'Or*, *Royal Standard* were in almost all the collections. Mr. Cooper, gardener, was first for six excellent pots of *Lily of the Valley*, also for six *Cyclamens*. Some very fine specimens of *Dielytra spectabilis* were shown, especially the first prize lot of these, exhibited by Mr. Palmer, Mr. Cooper being a good second. Large specimens of *Spiræa japonica* were very numerous, and there were good *Deutzias*, and a large number of *Cinerarias*. The *Indica Azaleas* were good, Mr. Brasier taking the first prize for six medium-sized specimens, profusely flowered, and not too formally trained, Mr. Cooper being placed second with larger plants, not sufficiently in flower. The class for three specimen *Azaleas* also brought out a new competitor, *Thomas Clayton, Esq.*, with very fine specimens. Mr. Brasier, gardener to Sir Thomas Martineau, and an excellent cultivator, took first prizes respectively for six and three stove or greenhouse plants in flower, and his plants were certainly well grown. Very noticeable was a grand *Thomas Hogg Hydrangea*, *Rhynchospermum jasmimoides*, *Anthurium Schertzerianum*, and *Franciscea calycina*. In the class for three fine-foliage plants a handsome specimen of *Dracæna Lindenii* was conspicuous, exhibited from *Highbury*. The bouquet classes are generally well represented at the Birmingham Shows, and some very beautiful examples were staged on this occasion. Mr. Finch, gardener to Mr. Alderman Marriott, Coventry, took first honours for bridal and ball bouquets with artistic work, and Messrs. Pope & Sons, nurserymen, were first in the open classes for a grand bridal bouquet. Three fine stands of twelve varieties of cut stove and greenhouse flowers were staged, Mr. Finch taking the first position with a very fine lot, containing some Orchids.

The Committee wished to have a large display of Orchids, and offered for groups arranged with Ferns and foliage plants, handsome prizes in the hope of inducing distant visitors to come; but the very cold weather upset these calculations. Two grand lots from local growers were set up, that from *Highbury*, staged by Mr. Burberry, who is at the head of the Orchid department, being especially meritorious. In this group there must have been close upon a hundred plants of Orchids, amongst them *Cattleyas Schroederi* and *Lawrenciana*, and others; *Dendrobium Falconeri*, a very fine *Densoni*, *Devonianum*, *Wardianum* and others; *Odontoglossum Ruckerianum* and others; *Masdevallias*, *Oncidiums*, *Cypripediums*, &c. Mr. Powell, gardener to G. A. Kenrick, Esq., was second with an excellent lot, and would have been a stronger opponent, but Mr. Kenrick objected to his fine *Dendrobiums* being taken out in such weather.

Some very fine specimens were staged in the classes for Orchids. For six plants Mr. Burberry again came first for six and three specimens. They consisted of *Dendrobium thyrsiflorum*, a fine variety of *Dendrobium fimbriatum*, *D. nobile*, *Cattleya Lawrenciana*, and *Odontoglossum Pescatorei*. These were all massive plants, especially the *Dendrobium Wardianum*, a fine variety, and *D. fimbriatum*. The three plants consisted of *Dendrobiums nobile pulcherrima*, *Freemani*, and *Wardianum*; very fine specimens. The second prize for six Orchids, and the first prize for single specimens were won by Mr. Palmer, the single specimen, a large mass of *Cypripedium villosum*, with about seventy blooms.

Exhibits not for competition were numerous. Mr. Thos. Ware, Hale Farm Nurseries, Tottenham, contributed a very extensive display of cut Narcissi, the beautiful *Chionodoxa sardensis*, *Anemones* in variety, double scarlet *Ranunculus*, and other plants. Messrs. Cutbush & Sons, Highgate Nurseries, London, sent a large display of hardwooded plants, some fine *Clivias*, their new Mignonette "Snowdrift," excellent *Mushrooms*, and other things. Messrs. Richard Smith & Co., Worcester, contributed a group of winter decorative plants, such as forced *Rhododendrons*, *Clematis*, *Azaleas*, *Japanese Maples*, &c. Messrs. Ryder and

Son, Sale Nurseries, Manchester, contributed forty pans of *Primula Sieboldi* varieties, including the newer kinds—*Maiden's Blush* (exhibited for the first time), *Bruce Findlay*, Mrs. S. Woodward, *alba magnifica*, Mrs. Ryder, *Queen of the Whites*, Mrs. A. H. Jones, and Miss Nelly Barnard, all very desirable varieties.

Messrs. Hewitt & Co., Solihull, staged a group; at the back a large specimen in bloom of *Magnolia Soulangeana Alexandrina*, several *Japanese Maples*; also a good assortment of early spring-blooming alpine and other plants, and *Auriculas* staged in boxes. The *Auriculas* were very good indeed for this early season. Messrs. Vertegans & Co. sent a very interesting collection of *Himalayan Primroses* and fruit of the *Melon Pear*, which the Judges regarded with considerable favour, the fruit having a flavour somewhat resembling that of a *Melon* combined with the *Banana*. Messrs. Thomson & Son set up one of their always admired artistic groups, which had a well thought out design throughout, and a rich display of floral work in baskets of flowers, sprays, bouquet, and especially a harp of *Erin*, beautifully made. Messrs. Pope & Sons set up a good group, in which were some very fine specimen *Clematis Marie Boissclot*, a large-flowered very fine white. There was a good plant of the *Golden Latania borbonica*, and a group of the fine double scarlet *Zonal Geranium Le Bruant* in it. Henry Hollis, Esq., Edgbaston, was awarded a certificate for a good specimen *Dendrobium densiflorum*, and a cultural certificate was given to Mr. W. Jinks, gardener to J. E. Wilson, Esq., Edgbaston, for *Phalænopsis Stuartiana*. Messrs. Pope & Sons also exhibited a superb cross of *Narcissus Irish King* and *Variegated Ivies* and *Euonymus*, all from out of doors. Mr. J. Shuttleworth, Edgbaston, exhibited a display of rustic garden furniture of various designs, in which lightness and elegance prevailed; and Messrs. Frazer & Co. a patent tap splicer, which the Judges thought useful for repairing damaged indiarubber tubing.

RUTHIN CASTLE.

ON an eminence commanding an uninterrupted view of the greater portion of the exceedingly picturesque and fertile Vale of Clwyd in Denbighshire stands Ruthin Castle, a noble castellated mansion, erected in the early part of the present century by the Hon. Frederick West on the site of a previous castle founded by Edward I., and most probably of a much more ancient British fortress. It is now in the possession of Col. W. Cornwallis West, M.P., who is also Lord Lieutenant of the county. The grounds are entered by massive oaken doors from nearly the centre of the quaint old town bearing the name, and from entrance to exit as we pass along circuitous paths, and through subterranean passages, we are held almost spell-bound by the enchanting interest of the various scenes presented. Nature and Art on every hand seem to have successfully combined to render the once scene of conflict, strife, and bloodshed a scene of peaceful and perfect beauty, and where instruments of war and torture once glittered in defiant hands, the more noble instruments of tillage are now brandished in the arts of peace. To notice at any length these glorious scenes would be quite impossible here, so a few halts only will be made in our tour. We start through some of the underground passages already referred to, and into some dungeons from which we hurriedly escaped with a feeling of relief—these are portions of the old castle. What is called the Little Flower Garden is then reached, and a glance at the accompanying illustration (fig. 57) will afford the reader a better idea of it than a description. The figure "standing at ease" in the illustration is Mr. H. Forder, the genial head gardener, who, by the way, both designed and made the Little Garden, and, it may be added, keeps it in brilliant order. Many thousands of plants are required for this garden alone, to say nothing of other parts of the grounds that are so bountifully provided for, and it speaks volumes for the gardener's management that with such limited glass accommodation at his command, together with a reduced staff, he is able to meet these heavy demands so successfully. We pass more and more of the grand old ruins and come to a long Ivy clad building, supposed to have been an armoury, where two long herbaceous borders containing a fine collection of this class of plants claim our attention. In addition to their own beauty and attractiveness the surrounding ruins lend much additional charm, the whole forming a picture of exceeding beauty. Descending two flights of steps the tennis ground is entered, which was formerly a courtyard and main entrance to the old castle. Here we find one of the old gateways well preserved, if preservation be indeed needed for walls of solid masonry about 8 feet thick. Ascending by another flight of steps another flower garden comes in view—the front terrace garden, equalling in effect the first. The arrangements of colour seemed perfect, and a bed in the centre of the design containing subtropical plants, conspicuous among them being *Lavatera arborea variegata*, was a fitting crown to the surrounding beds, with their complement of dwarf growing plants of the ordinary bedding kinds. Magnificent views are obtained from this terrace, the most extensive being towards the sea and coast in the direction of Rhyl,

a distance of twenty-one miles, the sea being in clear weather distinctly visible.

A peep into some of the spacious rooms of the Castle from this terrace gives us an impression of the magnificence of the interior, as well as of the demand in the decorative department upon the gardener's resources. In addition to costly works of art, and other permanent decorations in these rooms, Palms and other decorative plants in quantities are dotted and grouped in every available space.

Leaving the pleasure gardens and their sentiment, we soon find ourselves in the more prosaic kitchen garden and amidst the glass, which, as already stated, is limited, and sadly inadequate for such an establishment. Of necessity, every inch of space inside is utilised. The vineries were all planted with new Vines four years ago by Mr. Forder, and have in the time done exceedingly well and carried good crops of fine bunches the last season, particularly

decorative purposes, and the other half disbudded for large blooms.

Great attention is paid to the kitchen garden, the produce of which is always both heavy and remarkably fine, and exhibits are well known at several of the leading Exhibitions—Liverpool, and Shrewsbury. Every nook is turned to account in this department, as under glass, and excellent order prevails everywhere. Winter crops of Sprouts and Kales were abundant and exceptionally good; Onions, Carrots, and Celery very fine.

One favourable condition here is the water supply. From a reservoir in the park a plentiful supply is carried by means of pipes all over the garden, and in addition to this—read, mark, and learn, ye exhibitors—the sanitary arrangements are such that stables and house are compelled to contribute materially to the success attained. Tanks are placed about 30 yards apart the entire length of the garden, and so fixed that crops can be readily

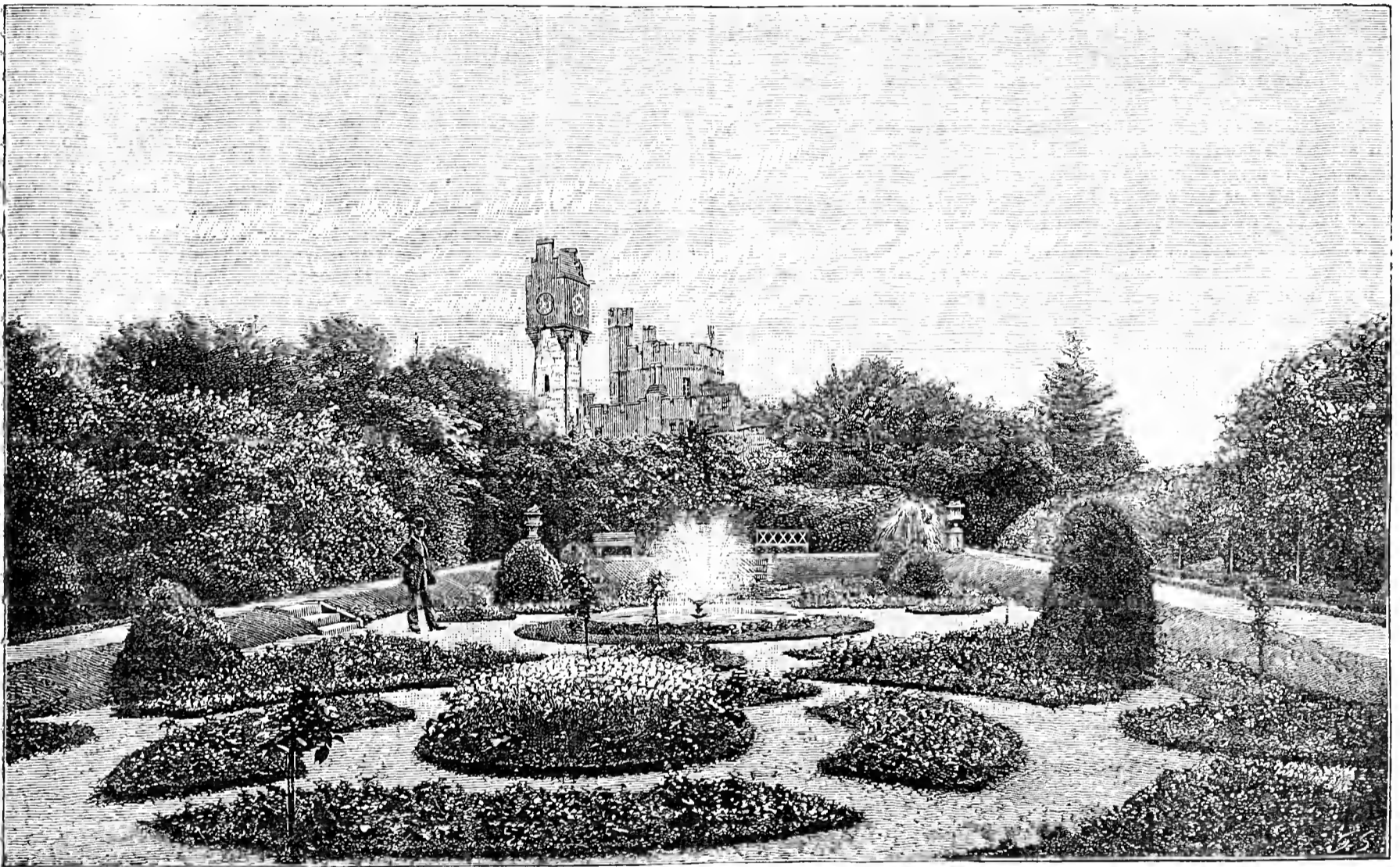

FIG. 57.—RUTHIN CASTLE AND FLOWER GARDEN.

the Black Hamburgs. Tomatoes are very largely grown, a lean-to house, 45 feet long and 8 wide, filled with these trained under the roof, was a picture, heavy crops and very fine fruit. Among new sorts being tried, Glenhurst Favourite and Cliban's Tomato were promising well. As evidence that no space is wasted, underneath the Tomatoes in this house foliage table plants were grown, and were doing finely too. Tomatoes are grown in other houses as well. In one large house, the centre devoted to large Palms and decorative plants, the side stages all round were planted with them, the plants being trained on the roof. These stages are of slate, and a turf upside down is all the preparation made for them; top-dressings, of course, are given as required. This treatment evidently suits them, the crop being heavy and fine. Dedham Favourite, Perfection, and Livingstone's Beauty seemed to be favourites. Cucumbers in abundance and Melons (a fine crop) occupied other quarters. Of the latter, Blenheim Orange and Hero of Lockinge are mostly relied on. Two span-roofed houses were well filled with healthy and useful foliage and decorative plants, Gardenias planted out in one of them being vigorously healthy, and calculated to produce abundance of bloom. Between 200 and 300 Chrysanthemums are grown; about half are grown naturally for

irrigated therefrom with the contents in the form of sewage conveyed to them through pipes from the sources named. Quantities of young fruit trees, all planted within the last five years, are thriving admirably, and much may be expected from them in future. The varieties are well chosen of each kind. On trees in full bearing Apples were not plentiful, but were very fine and highly coloured. Some Pear trees too were carrying exceedingly fine fruit, but were not very heavily cropped. Wall fruit too was scarce last season, but bush fruit and Strawberries were very abundant. Mr. Forder is certainly to be congratulated on the excellent condition of everything under his charge, particularly so with the limited supply of labour at his command.

It should be stated that Col. West generously admits the public into the gardens free, and to view the Castle also when the family are not in residence. This privilege is greatly appreciated by the numerous visitors to North Wales during summer.—BRADWEN.

[As will be apparent to our readers, the above notes refer to a visit in the autumn, and we are now informed that Mr Forder's charge of the gardens is approaching its termination, and that he is seeking another appointment.]

CROCUSES ON LAWNS.

IN December last a notice was given of Mr. F. M. Moles's method of growing fruit trees in town gardens, and I received a letter from him a few days ago, saying that if I would call at his gardens in the Westfield Road, Edgbaston, Birmingham, he thought I should be interested in a display of Crocuses planted in a tennis lawn, about a third of an acre in extent. I found a very beautiful display, for the day happened to be bright, and the flowers were seen in all their beauty. The corms, some thousands, were planted three to four years since, three roots together, each cluster about 18 inches apart, just making a hole in the grass for the bulbs, and filling with soil. The sorts used are the finest varieties, such as David Rizzio, Prince Albert, Purpurca Grandiflora, an extra fine purple; Baron von Brunow, Madame Mina, Mont Blanc, Non Plus Ultra, Queen Victoria, and others, including a good proportion of the large Dutch Yellow. The flowers at the beginning of April were as fine in quality as if grown in the open ground, and from newly planted strong bulbs; and standing a little distance away, the lawn has the appearance of a magnificent piece of fancy woolwork or an immense carpet of harmonious shades of colours.

But what about mowing the grass? Well, Mr. Mole just waits until the foliage has died; and by the beginning of June, if not before, the lawn can be mown for the first time, and he attaches much importance to allowing the foliage to die naturally. A dressing of bonedust or some other stimulant occasionally keeps the green sward in good condition and helps the Crocus roots. The little delay in spring mowing is amply compensated for by the very beautiful display at the end of March and early part of April, and there is no fear of the bulbs being disturbed by digging.

Much can be done by ornamenting portions of pleasure ground plots of grass in this way, and by Snowdrops, Winter Aconites, and the blue and white Wood Anemones, and other plants. The Narcissi alone, planted in clumps on parts of the grassy portions of the pleasure ground when early mowing is not cared for, would be objects of beauty, and I think the time is coming when the lawn planting of bulbs will be done very much more than it is at present.—W. D.

LIVERPOOL HORTICULTURAL ASSOCIATION.

THE eighth spring Show was held on April 7th and 8th in St. George's Hall, Liverpool, and, as stated in our last week's issue, surpassed all previously held. It is much to be regretted that the attendance was not of the highest order, owing, no doubt, to the great attraction of the Japanese Bazaar, which has drawn crowds the whole of the week. Foremost amongst the exhibits were the Orchids arranged in front of the orchestra, and certainly nothing approaching them has ever been seen in St. George's Hall. So superior were they that many which failed to gain prizes would have had not the slightest difficulty in being in the front rank at previous exhibitions, and if the Committee could wisely see their way to arrange a class for six Orchids it would no doubt be warmly contested by those possessing large collections, and enable smaller growers to compete with more success in the classes as at present constituted.

For three Orchids, Mr. B. Cromwell, gardener to T. Sutton Timmis, Esq., Cleveley, Allerton, took premier honours out of ten competitors with splendid examples of cultivation, *Dendrobium Wardianum*, eighty-five flowers; *Cattleya Trianae* (grand variety) eight flowers; and *Cymbidium eburneum*, sixteen flowers. Second, Mr. J. Jellicoe, gardener to F. H. Gossage, Esq., Camp Hill, Woolton, who had a beautiful piece of *Cymbidium Lowianum* with five spikes; *Cymbidium eburneum* and *Dendrobium Jamesianum*, thirteen fine spikes. Third, Mr. A. Smith, gardener to D. de Yborrondo, Esq., Prince's Park. Nineteen competed in the class for one Orchid, and the Judges had no difficulty in awarding first prize to Mr. J. Wilson, gardener to J. E. Reynolds, Esq., Sandfield Park, W. Derby, for a glorious plant of *Dendrobium Ainsworthi* with over 1000 flowers. Second, Mr. J. Madeley, gardener to W. C. Atkinson, Esq., with a fine variety of *Dendrobium thysiflorum* carrying twenty-two spikes. Third, Mr. Cromwell, who had a charming pan of the Trentham variety of *Cœlogyne cristata* which covered the foliage with its 480 flowers. Extra, Mr. C. Duke, gardener to G. R. Sandbach, Esq., Fulwood Park; and Mr. J. J. Craven, gardener to J. G. Morris, Esq., Allerton Priory.

Next in importance were the Azaleas, and here again Mr. Cromwell took the lead with perfect examples in the class for three with Roi Leopold, Model, and Duc de Nassau, not a leaf to be seen. Second, Mr. J. Wilson, gardener to H. Cunningham, Esq., Gorsey Cop, Gateacre; third, Mr. Jellicoe. Mr. Wilson was also placed first for one Azalea, being closely followed by Mr. Cromwell; third, Mr. T. Hitchman, gardener to A. Earle, Esq., Chilwall Lodge. For four Azaleas, 8-inch pots, Mr. C. Osborne, gardener to H. J. Robinson, Esq., Aymestry Court, Woolton, was deservedly awarded first prize for excellent examples and flowers of fine substance, the varieties being Plato, Illustra, Bluthiana, and Mrs. Turner. Second, Mr. Cromwell; third, Mr. Moorhouse, gardener to R. Brocklehurst, Esq., Sandfield Park. Stove and greenhouse plants formed the next feature, and here Mr. Jellicoe gained first honours with

an excellent collection, including a very fine *Rhododendron Gibsoni*, splendid specimen *Crotons Queen Victoria* and *Warreni*, a grand healthy plant of *Anthurium Andreanum*, *Kentia Fosteriana*, and a beautiful *Rhododendron fragrantissimum*. Second, Mr. Cromwell with a capital *Phoenix rupicola*, *Kentia Fosteriana*, *Dendrobium nobile* (very fine), and *Croton Queen Victoria*. Third, Mr. A. R. Cox, gardener to W. H. Watts, Esq., Elm Hall, Wavertree. One stove plant in flower, first, Mr. J. Bounds, gardener to A. L. Jones, Esq., Oatlands, Aigburth, with a chaste plant of *Cœlogyne cristata*. Second, Mr. Cromwell; third, Mr. J. Wilson, jun., both with *Dendrobium nobile*. One greenhouse plant in flower, first, Mr. T. Winkworth, gardener to R. Brocklebank, Esq., Childwall Lodge, with a noble plant of *Imantophyllum miniatum*. Second, Mr. Jellicoe; third, Mr. Cromwell.

Mr. A. R. Cox was first for four exotic Ferns with a seedling *Davallia*, seedling *Goniophlebium*, a fine *Microlepia hirta cristata* over 6 feet across, and *Adiantum cuneatum*; second, Mr. A. Smith; third, Mr. T. Moorhouse. One exotic Fern, Mr. Cromwell, with a splendid *Nephrolepis davallioides fureans* some 5 feet across; second, Mr. J. Bounds, with a beautiful *Adiantum tenerum*; third, Mr. Jellicoe. Mr. Cromwell took the lead with six forced hardy plants, three *Callas*, and two pots *Mignonette*. *Dracenas* well shown, Mr. T. Carling, gardener to Mrs. Cope, Dove Park, Woolton, leading with six fine well-grown plants; second, Mr. A. R. Cox; third, Mr. Jellicoe. Mr. J. Bounds was first for one greenhouse *Rhododendron Gibsoni*, a superb plant, but getting a little past its best; second, Mr. Jellicoe; third, Mr. Moorhouse, the last-named being first for four hardy *Rhododendrons* and one hardy *Rhododendron*. The *Azalea mollis* were perfect pictures, the first for four falling to Mr. J. Harrison, gardener to Mrs. W. G. Bateson, New Heys, Allerton, and for one to Mr. J. Taylor, gardener to H. H. Hammond, Esq., Sefton Park. *Cinerarias* and *Primulas* were only moderate. Mr. J. Warrington, gardener to Tyndall Bright, Esq., was first for the former, and Mr. Jellicoe for the latter. For two *Amaryllis*, Mr. A. R. Cox was first.

The *Cyclamens* were well flowered, Mr. J. Wilson, jun., taking the first prize for six pots. Lily of the Valley was exquisitely shown and greatly admired, that by Mr. C. Ford, gardener to Mrs. C. Hazlehurst, Runcorn, for first honours being wonderfully well grown. Second, Mr. T. Stephenson, gardener to L. H. Macintyre, Esq., Aigburth, and Mr. Carling third with good pots. Mr. Bounds secured first prizes for six table plants (pretty specimens) for one bouquet, and in the open class for ten pots hardy herbaceous and bulbous plants, and for the most tastefully arranged box of Roses. In the latter Mr. T. Wilson, gardener to O. H. Williams, Esq., Fulwood Park, and Mr. J. Mather, gardener to W. H. Evans, Esq., Charlwood House, Huyton, staged most meritorious boxes in the order named. Mr. T. Wilson was successful for three Palms or Cycads and one Palm or Cycad, first for twelve *Hyacinths* and six, and second for six pots three bulbs in a pot and eighteen *Hyacinths*. In the open class for table of miscellaneous plants for effect Mr. A. R. Cox was an easy first with a light and bright arrangement, Maidenhair Ferns forming the groundwork, interspersed with small Palms and Orchids. Mr. Jellicoe second with a rather flat arrangement and wanting in colour. Third, Mr. Moorhouse.

Hyacinths and *Tulips* were fairly well shown, and with the exception of the eighteen *Hyacinths*, which were good, which secured Mr. Cox first position, need no comment. Mr. T. Hitchman being first for six pots (three bulbs in a pot), six pots *Polyanthus Narcissus*, and six pots double *Tulips*, second for twelve pots *Hyacinths*, and second for six *Hyacinths*. Mr. D. Heany, gardener to H. G. Schintz, Esq., Mossley House, first for twelve and six pots of single *Tulips*. Mr. Jellicoe was the only exhibitor of six pots of *Daffodils*, but they were attractive and well flowered. He was also first for three excellent pots of *Lilium Harrisii*. Mr. J. J. Craven had six pots of *Laxton's Noble Strawberry* (very fine fruits well coloured), and secured the prize.

Mention must be made of the grand display made by the nursery-men, all of whom received certificates of merit—viz., Messrs. T. Davies and Co., Wavertree, for a stand containing bulbs, Azaleas, and a large number of seedling and named *Amaryllis*; Messrs. R. P. Ker & Sons, Aigburth, for stand containing all the finest varieties of Azaleas and *Lilium Harrisii*; Mr. Henry Middlehurst, Manchester Street, for pot *Mignonette*; Messrs. Dickson, Limited, Chester, for four boxes of cut flowers. The back row of each box was made up of *Lilium Harrisii*; the centre of the boxes comprised shields of *Narcissus* blooms cut with foliage, and contained all the best varieties; the front rows were made up with *Chionodoxas Lucilæ* and *sardensis*, *Scilla siberica*, and the smaller flowered *Narcissi*, set off with sprays of *Freesia Leichtlini major*. This was a charming exhibit, and found many admirers. Messrs. B. S. Williams & Son, Upper Holloway, who exhibited for the first time at the spring Show, had a magnificent collection of rare plants, including the choicest *Amaryllis*, *Cypripediums*, *Anthuriums*, *Odontoglossums*, *Heaths*, and *Cyclamens*. A certificate of merit was also awarded for *Calanthe Williamsii*. Messrs. Fishlock Bros. had splendid wreaths, crosses, and bouquets, and were awarded first prize for one bouquet. Mr. P. Harbordt showed Harbordt's Perfection Tomato. The following were highly commended:—Mr. T. Elsworth, gardener to A. R. Gladstone, Esq., Court Hey, Roby, for two fine bunches of Black Alicante Grapes; Mr. Bounds for pot Rose; J. T. Brunner, Esq., Sefton Park, for three Roses; and Isaac Davies & Sons, Ormskirk, for *Rhododendron Bridesmaid*, and Mr. Cromwell for *Dendrobium crassinode*. A simple and most useful invention in the form of a union for fastening indiarubber hose piping was on view.

The Chairman (Mr. White), Vice-Chairman (Mr. T. Powell), Secretary (Mr. E. Bridge), and the Committee all worked most assiduously to make

the Show a thorough success. Space will not allow a more detailed account, and the grand Show will not soon be forgotten by all who had the privilege to see it.

ARRANGEMENT OF HOT-WATER PIPES.

"HEATING REFORMER" a few weeks ago made a protest against the too common plan of massing the whole of the pipes in a house in one place. While quite agreeing with him that this is an evil to be avoided, yet I can scarcely go the whole length of spreading the pipes out 2 feet apart over the borders. Not that I would have any doubts of its suiting the Vines or of its heating the house to perfection, nor even the slight inconvenience in attending to the borders. The chief objection to be raised against it in private places is the question of growing plants in the vineries, which in most places is a necessity. Under the "spreading" system it would be necessary to have a lattice stage above the pipes. Upon this fresh potted bedding plants would become dry quickly and require more attention with water than if they

till they are removed. If the leaves were kept dry as proposed by lights the border would be warmer throughout the winter; the leaves might be cleared out by the end of February and the space filled with bedding Geraniums, &c., potted a short time before. These will require very little water except by syringing for some time longer, and the lights being kept rather close will catch all the sun heat to the advantage of the Vine roots now becoming active. For the summer the lights would be used elsewhere and again put in this position to shelter bedding plants, &c., before they are finally housed for the winter. In conclusion I may say that the plan here given is that of a vinery at present under my charge, with the exception of the arrangements at *b*, *c* and *d*, which I am sorry to add may be said to be an unrealised dream of the future.—R. I.

I AM surprised to learn that "Heating Reformer" finds the articles I lately referred to on "Heating by Hot Water" bear more on "the principle of heating by scientific rules" than on the subject of his article, page 179. If the scientific rules governing water when heated

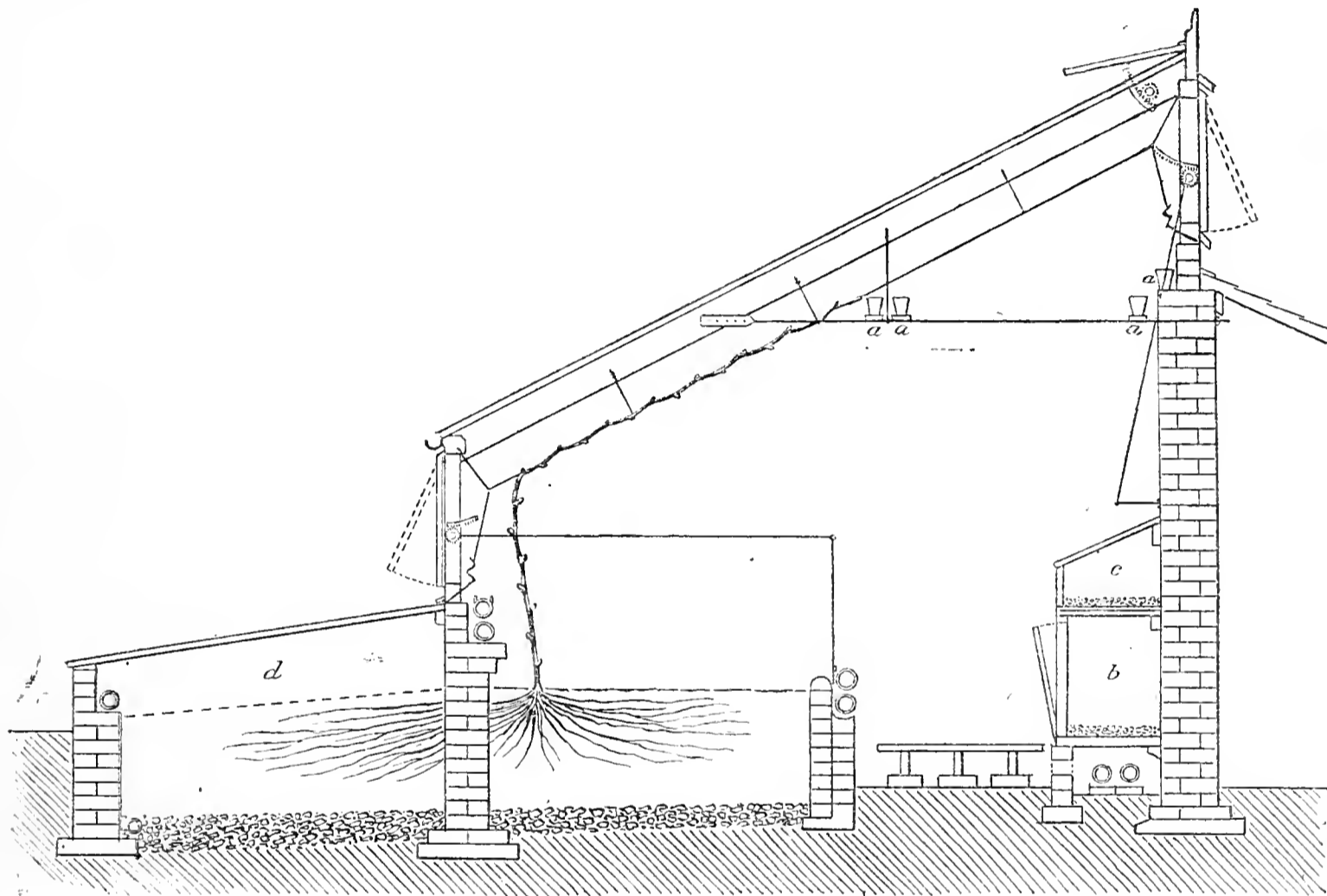

FIG. 53.—A USEFUL VINERY: ARRANGING HOT WATER PIPES.

stood on the borders. The steam arising from this and from keeping the surface of the border moist by damping, would not at all seasons be to the advantage of the Vines.

I quite agree with Mr. Williams as to the necessity of having valves on both flow and return pipes, and as close to the mains as possible. The loss of heat through this is often very great, as I can testify from the defects of the arrangement of valves in my present charge. The discussion in the "Gardener" of 1879, referred to by Mr. Williams, was more upon the subject of deep *versus* shallow stokeholes, and their influence on the circulation of the water in the pipes than disposing the pipes for the more perfect heating of a house, aimed at by "Heating Reformer." But it is quite evident that even this circulation question is not yet perfectly understood, as I see it is sometimes found necessary to have more pipes to take the water back to the boiler than flows that lead from it.

I herewith enclose a section of a vinery which I can commend to anyone who wants a really useful house to produce Grapes, say early in June. For this purpose the six rows of pipes as shown will be sufficient, and are so placed as not to occupy valuable space and yet to distribute the heat fairly well. At *a, a, a, a* there are shelves for Strawberries or other plants during the earlier stages of the Vines' growth. By enclosing the two pipes by the back wall, as shown at *b*, you have an excellent place for forcing Seakale and a first lot of Rhubarb, &c., and the frame *c* would be useful for a variety of purposes too numerous to mention. If the outside border was covered with lights and a single pipe run round it as shown at *d*, I think would be a much better plan than the usual way of protecting them in winter. We usually cover them with a good depth of dry leaves, which before the winter is half gone is wet and cold, and they keep the border in an ungenial state

and conducted through glass and other structures for the purpose of raising the temperature of those structures are right, they have a direct bearing on the arrangement of the pipes employed.

Whether Mr. Hammond's molecular theory be right or wrong matters little, the deduction I make from the articles, so far as the question at issue is concerned, is "that any obstruction offered to free circulation is bad." As "Heating Reformer" has read those articles he is acquainted with the various obstructions discussed.

I cited a case in my previous communication where three flows provided for each return in a house at some distance from the boiler did not work satisfactorily, that on the flow and return pipes being equalised the work was efficiently done. All other conditions being the same, this shows that the boiler power was not sufficient to overcome the obstruction which the three flows offered to circulation. In a house close to the same boiler this obstruction was not felt, for the obvious reason that the heating power was greater there than at a distance. Exactly the same principle applies to a greater number of flows to each return pipe, which I have no doubt will answer, as in "Heating Reformer's" case, if the boiler power be sufficient to overcome the obstruction. Where this obstructive system is largely carried out much more fuel has to be burned than for the primitive method which he condemns.

Your correspondent says that "objections may be raised to any plan, but substantiating such objections with an improved method would carry much more weight." Had he carefully perused my communication (page 243) he would have observed the following—"If a vinery is fitted with two rows of pipes at or near the front, and the same quantity from the middle to the back of the house, according to the way the house is arranged, there need be no attack from red spider if the

house is properly attended to." This is by no means a "new or improved method," though it possesses all the advantages claimed for the spreading out system, without in the least hampering any work that may be necessary on the border or causing unnecessary burning of fuel. Both as a journeyman and foreman in private gardens I have had charge of houses thus heated from which were cut Grapes which took first prizes against all comers at provincial shows held under the auspices of the Royal Horticultural Society.

I have known intimately for years a gardener whose Grapes have figured conspicuously on the boards at Liverpool and other shows, who depends mainly upon fruit ripened in June in houses heated on the principle which "Heating Reformer" deems "objectionable." Respecting the query, "Will Mr. Williams say in what respect Mr. Divers' objection is full of sound judgment?" Mr. Divers says (page 210):—"I do not consider his plan of placing six pipes at 2 feet apart on the surface of the Vine borders is a good one to follow, as I am quite certain it would be no easy matter to lift the Vine roots and renew a border under such conditions unless the pipes were taken out, which would be an expensive addition to border making." Mr. Divers' "certainty" of the difficulties such an arrangement would present is verified by "Heating Reformer" (page 243) where he says "Even this (every dozen years) is but a small affair in willing hands." I have seen made and assisted to make a few Vine borders, but I have not yet met a gardener who considered border making, though unhampered with pipes, a small affair. Last month I found it anything but a welcome addition to my numerous other duties at that time. Labour is not sufficiently plentiful, and I have not had the good fortune of being employed elsewhere where labour has been sufficiently abundant to render border making a small affair "even in willing hands." Mr. Divers was quite certain that it would be rendered more difficult by the "spreading out" system of heating, and in this his objection is sound, or, as I said previously, "full of sound judgment."

Owing to the absence of details it is difficult to say why "Heating Reformer's" plant house is heated so unsatisfactorily; but if his boiler is equal to the work it is probable that what he wants is more flow and return pipes to give sufficient heating surface with free unhampered circulation to the area to be heated.—W. R. WILLIAMS. *Great Marlow.*

ROYAL HORTICULTURAL SOCIETY.

APRIL 14TH.

ADMIRABLE in all respects was this Society's meeting on Monday last, and the Drill Hall has never presented so bright and diversified an aspect early in April. Orchids were shown in much larger numbers than usual. Greenhouse plants of the most attractive character were well represented by imposing groups of excellent useful little specimens. Daffodils and other hardy flowers formed another great feature, while in the fruit department Apples and Strawberries were submitted to the Committee. Altogether there was ample to satisfy visitors of every floral fancy, and we should have liked to see the hall much more crowded than was the case. It is, however pleasant to record that the attendance was a decided improvement upon that at preceding meetings this year, and the greatest satisfaction was expressed by all present, especially by the strangers, who were surprised both at the extent and variety of the display. In the afternoon, Mr. F. Moore, of the Glasnevin Botanic Gardens, read a capital paper on *Lachenalias* before a large audience.

FRUIT COMMITTEE.—Philip Crowley, Esq., in the chair, and present, Dr. Hogg, John Lee, R. D. Blackmore, Harrison Weir, T. F. Rivers, G. W. Cummins, W. Warren, G. Bunyard, A. Dean, J. Smith, G. Wythes, H. Balderson, F. Q. Lane, J. Willard, J. Cheal, C. Penny, W. Denning, G. Reynolds, W. Bates, and G. Clyffe.

Mr. R. Gilbert, Burghley, sent a very fine dish of John Ruskin Strawberry, and stated that he had grown the variety with Noble and other earlies, and found it ripen some days in advance of them. At Chiswick it ripened about the same time as *Vicomtesse Héricart de Thury*, which it generally resembled. The fruits exhibited were of good size, shape, colour, and flavour. A cultural commendation was awarded, and a desire expressed that it be seen again with the *Vicomtesse*, both from the open ground. Messrs. Vertegans & Co. sent specimens of *Solanum guatamalense*, or "Melon Pear," but none of the Committee required a second taste, which resembled that of an over-ripe Cucumber. Mr. J. Miller, gardener to Lord Foley, Ruxley Lodge Gardens, Escher, sent very fine dishes of *Blenheim Orange* and *Mère de Ménage* Apples, and a vote of thanks was unanimously accorded. Mr. W. Miller also sent dishes of Mushrooms, grown respectively on outdoor beds and in a house, the former decidedly the best samples, which received a similar mark of recognition. Messrs. H. Lane & Son, Berkhamstead, sent splendid fruits of Lane's Prince Albert Apples. The specimens were large, firm, and attractively streaked, and a cultural commendation was promptly accorded.

Mr. Leach, Albury Park Gardens, sent fruits of *Tomato Ladybird*, the result of a cross between *Ham Green*, also sent, and *Hackwood Park*. The fruits were much larger than those of *Ham Green* and well coloured, and a cultural commendation was granted for them. The first Melon of the season was sent by Mr. A. Bradshaw, Davenham Gardens, a small, yellow, well-netted fruit that did not, however, merit any award. Mr. G. W. Cummins, gardener to A. H. Smee, Esq., Hackbridge, sent a small collection of remarkably good and well-kept Apples, a few of the more

noticeable being *Gooseberry Apple*, *Bismarck*, *Cox's Orange Pippin*, *Wadhurst Pippin*, *Dumelow's Seedling*, *Melon Apple*, *Nonpareil*, *Claygate Pearmain*, and *New Hawthornden*. A small Banksian medal was recommended.

FLORAL COMMITTEE.—Present: W. Marshall, Esq. in the chair, and Messrs. Herbst, R. Dean, G. Nicholson, C. T. Druery, H. B. May, W. C. Leach, R. B. Lowe, C. E. Pearson, T. Baines, C. Noble, W. Furze, G. Gordon, T. W. Girdlestone, B. Wynne, J. Fraser, H. Turner, E. Mawley, F. R. Ross, and Rev. H. H. D'Ombraim.

Greenhouse plants were grandly shown by Messrs. Hugh Low & Co., Clapton, who had a diversity of useful plants, such as *Heaths*, *Cytisuses*, *Pimeleas*, *Boronias*, *Eriostemons*, *Polygalas*, *Azaleas*, the graceful *Leptospermum bullatum*, and many others that are now too seldom seen in general cultivation (silver-gilt medal). Excellent plants of a similar character came from Messrs. W. Cutbush & Son, Highgate, with the addition of some fine *Clivias* and wonderfully fine *Mignonette* of the strain *Snowdrift*, notable alike for the great size of the heads, their white appearance, the powerful fragrance, and their long-lasting qualities (silver Banksian medal).

A most effective compact group came from Messrs. B. S. Williams and Son, Upper Holloway, in which the conspicuous attractions were *Hippeastrums* of many fine varieties, the best of the free-flowering *Ericas*, and *Boronias* with foliage plants (silver Banksian medal). Daffodils in profusion and scores of select varieties from Messrs. Barr and Son, King Street, Covent Garden, formed a group of much importance to many visitors, and a smaller collection of bright *Anemone fulgens*, *Chionodoxas*, and *Primulas* was also a very acceptable addition to the display (silver Flora medal).

The charming trio of new *Roses*—*Duchess of Albany*, *White Lady*, and *Corinna* from Messrs. W. Paul & Son, Waltham Cross, found some critical admirers, the last-named being a promising Tea Rose of a peculiarly distinct colour, a soft rosy salmon, with somewhat of a metallic sheen. A handsome new *Camellia*, *Duchess*, was granted an award of merit. Under the name of *Munstead Early White Miss Jekyll*, of Godalming, exhibited a bedding *Primrose* of compact habit, having large white flowers. The Royal Gardens, Kew, contributed a basket of choice hardy plants, amongst which was a fine example of the beautiful *Shortia galacifolia*. Messrs. Paul & Son, Cheshunt, had some meritorious *Hippeastrums*. Mr. J. T. Gilbert, Dyke, Bourne, sent flowers of *Primulas*, *Daffodils*, and *Fritillarias*, and Mr. G. Wythes had a group of the graceful *Spiraea confusa* (vote of thanks). Professor M. Foster, Cambridge, showed a flower of *Iris Fosteriana*, having yellowish standards and purple black falls, a curious little gem. A dozen large flower heads of *Guelder Roses* from C. E. Smith, Silvermere, Cobham, secured a cultural commendation, while votes of thanks recognised the interest of *Andromeda floribunda* seedlings from Mr. C. Noble of Bagshot, and a fine seedling *Clivia* from Mr. G. W. Cummins.

The prizes and medals offered for Daffodils did not bring many competitors, probably because the season is so late. The challenge cup for a collection was won by Mr. Cowan of Valleyfield, with about ninety flowers of good varieties. In class 3, for six varieties, three blooms of each, the Rev. W. Wilks, Shirley Vicarage, was awarded the first prize, a bronze medal, while in class 6, for a collection of Daffodils, excluding *Polyanthus* varieties, Messrs. Barr & Son's small silver medal was awarded to Miss B. F. M. Doyne, Seafield House, Gorey, Ireland, for small but good flowers.

ORCHID COMMITTEE.—Present: Dr. M. T. Masters in the chair; and Messrs. James O'Brien, H. M. Pollett, H. Ballantine, H. Low, E. Hill, Henry Williams, James Douglas, F. Moore, Sidney Courtauld, F. Sander, and Lewis Castle.

Orchids, as already indicated, were the special attraction of the meeting, and, with the exception of such occasions as the Temple Show and the Orchid Conference a few years ago, the Society has seldom had better representative exhibits of these plants. In fact, Baron Schröder's wonderful group from The Dell has probably never been surpassed even by himself as regards the exceptional value and beauty of the plants comprised within a small space. The magnificent *Cypripedium Morganiae*, in astonishingly vigorous condition, with twenty-two of its handsome flowers, was the centre of attraction, together with a grand specimen of *Masdevallia ignea*, nearly 3 feet in diameter, and bearing over 150 brilliant flowers. Then there were strong plants of *Odontoglossum crispum*, variety *Veitchi*, with a raceme of eight fine richly marked flowers, and the variety of the same species *Stevensi* with a much larger raceme of some dozens of lighter flowers. That charmingly delicate and distinct *Lælia Digbyana Mossiae*, had two finely developed flowers of exactly the character depicted in our illustration of this most interesting hybrid last year. The peculiar *Cymbidium Devonianum* had six long drooping racemes of its strangely dark-coloured flowers, the superb *Dendrobium nobile nobilium*, the delicately tinted hybrid *Cypripedium eburneo Lovianum*, a hybrid *Epidendrum* (certificated), *Masdevallia Lindenii*, with dozens of richly coloured flowers, and several distinct varieties of *Cattleya Lawrenceana*, were the principal plants in this group, and the Committee accorded due recognition of its merits by awarding a gold medal, an honour now seldom granted.

Scarcely of less interest was the group of *Masdevallias* shown by Sir Trevor Lawrence from the Burford Lodge collection, and too seldom are such well grown healthy plants seen either in gardens or at shows. The plants were of moderate size, but had a large number of flowers, and the varieties were remarkable for their fine quality. This was very noticeable in regard to the forms of *Masdevallia ignea*, such as *coccinea* and

Massangeana, the latter being of exceptionally rich colour; of M. Harryana. There were also some fine varieties, notably acanthifolia, which, with M. Lindenii splendens, was greatly admired. One of the gems of the group was, however, the little M. Armini with numerous bright bluish purple flowers; M. triangularis, M. Shuttleworthi, and its variety xanthocorys were also included, the plants being almost hidden by their abundant flowers (silver Flora medal).

From Cheam Park, Surrey, F. C. Jacomb, Esq., sent a group of the Orchids so well grown by the gardener, Mr. May. Unusually vigorous plants of Phalenopsis, the graceful Dendrobium Devonianum, Odontoglossum citrosimum, Oncidium concolor, Cymbidium Lowianum, and Cattleyas were arranged with Ferns and a few other foliage plants to make a most pleasing group, well worthy of the silver Banksian medal awarded. Mr. William Whiteley also had a beautiful group of Orchids from Hillingdon, chiefly composed of Dendrobium nobile, Odontoglossums, and Cattleyas, the varieties in every case being of great merit, and the plants being arranged with Ferns and Isolepis, the effect was good (silver Flora medal). M. S. Cooke, Esq., Kingston Hill (gardener, Mr. Cullimore), also had a group of Cattleyas, Dendrobiums, Cypripediums, and Vanda flowers, and F. A. Bevan, Esq., Ludgrove, New Barnet (gardener, Mr. B. Phillips), had a collection in which Dendrobium thyrsoflorum was prominent. A silver Banksian medal was awarded for each group.

A cultural commendation was adjudged to W. Bryant, Esq., Stoke Park, Slough (gardener, Mr. D. Kemp), for a very strong plant of Cypripedium bellatulum with six large flowers. A similar recognition was accorded to A. J. Playne, Esq., Longford, Minchinhampton, for a well grown plant of the green and black flowered Cœlogyne pandurata bearing a raceme of twelve flowers, and an award of an equal character might have been justly granted to Mr. Wythes, Syon Gardens, for an extremely strong plant of Cymbidium Lowianum having seven racemes, each 4 or 5 feet long. The interesting hybrid Miltonia Bleuana splendens was shown by Messrs. J. Veitch & Sons, Chelsea, raised in their establishment from a cross between M. Roezli and M. vexillarium. The flower was similar in character to that described last year raised from the same parents in Paris, by M. Bleu, but they appeared to be somewhat larger.

New and rare Orchids constituted a group from Messrs. Sander and Co., St. Albans, in which handsome Odontoglossums, Masdevallias, Maxillarias, the useful free Angræcum Sanderianum, and the remarkable Dendrobium Brymerianum figured largely. Of the novelties in addition to the golden Lycaste (certificated), the two following were especially noteworthy. Cattleya hybrida Behrensianum, from a cross between C. intermedia and C. superba, has elegantly formed flowers, the spreading sepals and petals softly suffused with purplish lilac, the lateral lobes of the lips are slightly more deeply tinged, and the central lobe is an intensely rich crimson magenta, in fine contrast with the pure white throat. The other is Cattleya elegans Arnoldiana, a pleasing and distinct variety of a well known type, the sepals and petals a delicate blush, nearly white; the lower portion of the lip is white, the lateral lobes slightly recurved and soft crimson, the central lobe of brilliant crimson shade, sharply defined (silver Banksian medal).

CERTIFICATED PLANTS.

Primrose James Nimmo (G. F. Wilson, Esq., Weybridge).—A handsome blue Primrose, with very large flowers of capital shape, and extremely free (award of merit).

Begonia Triomphe de Naney (Sir Trevor Lawrence).—A distinct and graceful dwarf Begonia with large rounded peltate leaves, and multitudes of small rosy red flowers on drooping panicles (award of merit).

Epidendrum hybridum dellense (Baron Schröder).—A hybrid between E. xanthinum and E. rhizophorum, with bright orange flowers in a dense head at the apex of the stem (first-class certificate).

Lycaste Mastersiana (Sander & Co.).—A new Lycaste, with medium-sized flowers; the sepals yellow, the petals and lip of a rich golden hue, and a few darker spots (award of merit).

Dendrobium Venus (Norman C. Cookson, Esq.).—A magnificent hybrid between D. nobile and D. Falconeri; the flowers like a large D. nobile, but with somewhat of less of the solidity of that parent, and more of the graceful pose of D. Falconeri. They are 4½ inches in diameter, the lip being 1½ inch long, and 1½ broad. The sepals and petals are broad, white tipped with crimson; the lip having a deep bold maroon central blotch, a broad white band, and a crimson tip. The pseudo-bulbs are more slender than D. nobile, and partake of the character of D. Falconeri, but more erect and stronger (first-class certificate).

Camellia Duchess (W. Paul & Son).—A variety of excellent shape, the petals very evenly imbricated, and the colour a bright rosy blush, a useful addition to those already in commerce.

THE RUSH-NUT.—Cyperus esculentus is a native of India, and also grows in Egypt. The rootstocks are composed of thin fibres, to the extremity of which are attached round or oblong bulbs, about the size of a filbert, brown without, and white within; farinaceous, having a camphorous odour, a sweet, agreeable, rather saccharine taste, and mucilaginous. These bulbs, on analysis, afford starch, fixed oil, sugar, albumen, gum, salts of malic and tannic acid, and oxide of iron. The dry root contains one-sixth its weight of oil, of a beautiful golden colour, nut-like smell, and slightly camphorous taste. It deposits stearine by standing, and in general appearance resembles the other fixed oils. The roots are eaten, to a great extent, in Manilla. When boiled they are nutritious, and have the taste of Chestnut; when roasted they have been used as a substitute for coffee.—R.



FRUIT FORCING.

PEACHES AND NECTARINES.—*Earliest House.*—Where such varieties as Early Albert, Early Leopold, and Early Louise are grown it is safe to plant the larger fruited varieties Alexander or Waterloo, and Early Rivers. The first three have small perfect flowers, but the two or three last named have large flowers; the buds are liable to over-maturity or imperfect formation in embryo, and drop when the trees are subjected to early forcing for a number of years consecutively to a large extent during the resting period. The flowers also are liable to imperfect formation, the petals being thin, the stamens weak, with small anthers almost destitute of pollen, and the pistil is short, thin, and the stigma viscid; the ovaries (for there is often two or more to a flower, with their separate pistillate organs) being ill developed, consequently fertilisation is impracticable. The set is often thin, and the fruit in Alexander or Waterloo is subject to enlargement at the suture, whilst Early Rivers splits at the stone. These defects are unquestionably a result of insufficient fertilisation; for where the perfect flowers are fertilised with the pollen of other flowers the fruits are perfect. Then Alexander is a fine early fruit, and of fair quality, whilst Early Rivers, ripening a little later, has much the appearance and the quality of the richest and most delicately flavoured of all Peaches—Noblesse. Early Beatrice singularly has a large flower, and sets freely, affording good fruit on a free growing stock. Hale's Early also has a large flower, sets well, and is unquestionably the best early forcing Peach for those that can afford to wait three weeks longer than those can do who grow the very early varieties. The last wherever forced very early should be grown in a house by themselves. Hale's Early, which is much like Early York in the same conditions of soil and climate, is very prone to cast its buds; but when not early forced, say to ripen early in June, it is a fine fruit. Dagmar and Crimson Galande have small flowers, which set well, the fruits are very handsome, particularly Crimson Galande, and they ripen several days in advance of Royal George and Stirling Castle. The two last are the surest and best forcing of all Peaches. Time, however, is all-important in early forcing operations. To have the latter ripe in late May or early June the trees must be started not later than early December, and they have to flower at the worst season possible; but Alexander, or any of the early varieties, started a month or six weeks later will ripen quite as early, and for general consumption be just as acceptable, the difference is in the cost of production. The early varieties started in January ripen in time for the London season, and cost less by one-third than the better qualities.

Routine.—The stoning process being over with the earliest varieties, they may be given a temperature of 70° to 75° by artificial means, but it is not good practice to maintain that constantly, for when continued through the night it attenuates the wood; therefore allow the temperature to fall to 65°, or even 60° on cold nights, keeping through the day at 80° to 85° from sun heat, ventilating by the top at 75°, and opening the front at 80°, so as to insure a circulation. Admit a little air constantly. Close the house at 80° sufficiently early to allow of an advance to 85° or 90°, the trees being well syringed and good atmospheric moisture secured, which will insure the fruit swelling to a large size, but the fruit and foliage must become fairly dry before night, and clear rain water must be used, as spring water is liable to leave a stain upon the fruit. Remove the leaves over or in front of the fruit, and turn this up to the light by thin laths placed across the trellis, as it adds greatly to the appearance of the fruit when it is well and evenly coloured from the apex, besides improving the flavour. Syringing should cease when the fruit commences ripening, but a genial condition of the atmosphere must be maintained for the benefit of the foliage by damping available surfaces twice a day and keeping the mulching thoroughly moist. If the early varieties and Hale's Early, A Bec (a very fine fruit), with Royal George or Stirling Castle, are grown together, then the night temperature must not be more than 60° to 65° at night, and 70° to 75° by day with gleams of sun, and 5° to 10° advance on bright days until the stoning is completed in another fortnight or three weeks, to ripen Hale's Early at the end of May or early in June, the house being started early in December. The prolonged cold weather has retarded forcing considerably, and when the stoning is completed they will bear a considerable advance in temperature with safety. Pay particular attention to syringing the trees, using clear soft water twice a day, and see that every part of the foliage and old wood is thoroughly washed. This is important, because the fruit will not finish satisfactorily if the foliage is infested with insects. Keep the roots lightly mulched and supplied with weak tepid liquid manure. Regulate the flow of the sap by stopping all gross shoots before they have time to draw the supplies from the weakest parts of the trees. Allow leading shoots, particularly of young trees, to extend over uncovered parts of the trellis, and pinch out the points when the fruit begins to take the last swelling, at the same time turning aside any leaves that are likely to shade or otherwise interfere with the colouring or ripening.

Second House.—The trees in the structure started early in January have the fruit in a forward state, the disbudding completed, and the

shoots that are to follow those now fruiting have been laid in. Always allow plenty of room in the ties, and do not keep them closely tied down for some time longer. Allow no more growths to remain than are necessary for next year's fruiting or for the extension of the trees. Stop gross growths or remove them, as it is highly important the sap be equally distributed and an equality of vigour maintained through the branches of each tree. Pinch laterals at the first joint, and shoots retained to attract the sap to the fruit should only be allowed moderate extension, stopping them in the first instance at three or four joints of growth. Endeavour to provide an equal distribution of foliage that will shade and protect the strong wood from the direct rays of the sun as the season advances. Avoid overcrowding, not allowing more shoots than can have full exposure to light and air. Ventilate freely but carefully, so as to avoid cold currents of air and sudden depressions of temperature. As the fruits will be swelling fast thin them if too thick, as with the trees in good health the fruit is more likely to stone well than when they are overburdened, besides taking from the size of those that remain for the crop at the final thinning after stoning. Water the inside borders copiously, and keep them mulched with sweet rather lumpy manure.

Third House.—Trees started early in February must be examined frequently for disbudding, and as this is best done gradually the strongest parts of the trees being first commenced with, being careful to preserve a shoot at the base of the current year's bearing shoots, and to leave no more on the extensions than will be required for furnishing the trees with bearing wood at 15 to 18 inches apart, and all the others on these may be pinched in closely to form spurs. A shoot on a level with or above the fruit must be retained on each bearing shoot and be pinched at the third joint. As the fruit is swelling freely remove those worst situated, and leave only a few more than will be required for the crop, one to every square foot of trellis covered by the trees being ample. Syringe early on fine mornings, give a little air shortly afterwards, gradually increase it, and close about 3 P.M.; but if the weather be very bright later closing must be practised.

Fourth House.—The trees started early in March are out of bloom, have set well, and having trace of aphides should be carefully fumigated with tobacco paper on two or three consecutive evenings. An overdose injures the foliage and causes the fruit to fall. Syringe moderately in the morning and on fine afternoons, always early enough to allow of the foliage becoming dry before night. Disbud gradually, and rub off all small and badly placed fruit as soon as the most prominent show signs of taking the lead. Ventilate freely on all favourable occasions, and close early with a view to husbanding the sun heat, but avoid a close vitiated atmosphere, admitting a little air constantly to prevent it.

Late Houses.—The trees in these are unusually backward. This is fortunate for those who have structures with fixed roofs, for despite all the ventilation trees will start much earlier than is wanted unless they are kept exposed, and late Peaches are even more valuable than early. Besides, the blossoms are usually much stronger and set quicker than when brought forward by mild weather in the early part of the year. Ventilate freely until the blossoms begin expanding, but keep them safe from frost. When the anthers show turn on the heat in the morning so as to raise the temperature to 50°, and keep it at that with a gentle circulation of air, turning off the heat early in the afternoon so as to allow of the pipes cooling before night, and the temperature falling to its night minimum of 40° to 45°, which is quite safe, and ought to be secured after the blossoms expand, with a little air to prevent the deposition of moisture through the night on the flowers. Artificial fertilisation should be resorted to either by shaking the trees or dusting the flowers with a bunch of feathers, Pampas plume, or camel's-hair brush, but the best aids to setting are perfectly developed blossoms and a genial and well aerated atmosphere.

KITCHEN GARDEN.

ASPARAGUS.—Little or no Asparagus will be cut from the beds before the first week in May, but in anticipation of this top growth the surface should be attended to. It is a great mistake to nearly bare the crowns and roots at this time of year, thereby exposing them to all weathers. Far better is it to give all rooting very near to the surface a liberal dressing of loam, leaf soil, decayed manure, and sifted lime rubbish; this protecting the young shoots from frost, ensures a good length of stem, and prevents the loss of much needed moisture during the summer. The least that can be done is to protect with strawy litter, this probably saving many early shoots, and otherwise benefiting the beds. In many cases the beds are poisoned with manure, and if salt is also freely added every spring the evil is further aggravated. What such beds require at the present time is a dressing of newly slaked lime, applied at the rate of about 2 bushels per square rod. This will greatly benefit the Asparagus, the good effect lasting several years. Salt is supposed to be the finest manure for Asparagus, but if applied too heavily or somewhat clayey land it will do more harm than good. On medium and light soils it may be advantageously applied now, at the rate of 15 lbs. to the square rod, a second application being given during showery weather in May. Salt and guano in mixture answer well for medium soils, and for heavy land guano, applied at the rate of 6 lbs. to the square rod, is to be commended; a similar dressing being given in May or June.

PLANTING ASPARAGUS.—It is unwise to transplant Asparagus, in cold wet springs especially, much before May, or say before top growth commences. The roots cannot be forked out of the ground without many being broken, and if these are again surrounded with cold, wet soil, many of them will perish. There are fewer failures when the roots

are moved after the first shoots are 6 inches or more in height, and for this reason home-grown roots are the best. Strong one-year-old plants can be moved safely; two-year-old, if once transplanted, being preferable, while there is little or no gain in planting older roots, as in case they ought to have at least two clear seasons' growth before being cut from. They ought to be lifted carefully, and not be exposed any length of time to cold, drying winds. Raised beds 5 feet or rather more in width would hold three rows, the outside ones being fully 12 inches from the edges. Narrower raised beds about 3 feet wide, and which are to be commended for affording the earliest cuttings, to hold two rows only, the plants in either case being disposed not less than 15 inches; they may well be 18 inches apart in the rows. On warm or gravelly subsoils Asparagus succeeds admirably planted on the level, the rows being arranged 3 feet or rather more apart, and placed out 2 feet apart in the rows, all soon developing into strong clumps. More than ordinary pains ought to be taken in planting Asparagus. Open a good sized hole for each plant, resting this on a hillock in the centre and spreading the roots out evenly all round, covering with about 2 inches of fine soil; in fact no lumpy soil ought to come into contact with the roots. A sprinkling of bonemeal or some kind of artificial manure prepared for these vegetables would give a good start.

SOWING ASPARAGUS SEED.—Sowing the seed thinly where the plants are to remain, arranging the rows and thinning the seedlings to the distances apart as advised for planting is the simplest, if somewhat slower, method of forming an Asparagus bed. If this is not practicable sow the seed in drills 18 inches apart, and lightly thin the seedlings before they become interlaced at the roots. Useful plants would be thus prepared for transplanting next spring. Where Asparagus has to be extensively lifted and forced every winter those responsible usually break up the oldest bed in the garden every winter and form a fresh one every spring. This often means destroying a bed when at its most productive state, but the only alternative is to prepare several hundred plants, especially for lifting. This may be done by either sowing seed at once thinly in drills 2 feet apart, duly thinning the seedlings to 12 inches apart, or young plants may now be put out those distances apart. Supposing the ground has been freely manured and deeply dug for this or any other crops, and is in a finely divided state, the Asparagus will grow strongly, and would if required be fit for lifting after two clear seasons' growth.

KIDNEY BEANS.—The scarcity of vegetables will be felt for another two months, and too many Beans cannot be grown under glass. In very sunny weather, or during May, the plants soon fail in pots, and are far less liable to suffer from drought if grown in narrow, moderately deep boxes, or any, say 10 inches wide, the same or rather more in depth, and 4 feet in length, a single row of Canadian Wonder from choice being grown in each. Six of these boxes set on a wall or staging in a warm and not much shaded house would form a fairly good supply, there being good time for three such being sown at fortnightly intervals. Heated pits and deep frames, as fast as they are cleared of Potatoes, might be closely planted with Beans, little or no preparation beyond levelling and clearing off rubbish being needed. Sow about five seeds in each 4-inch pot, about thirty of these pots being needed each time. Place them in brisk heat, and when the seedlings are of good size plant out in the pit or frame. Two rows are ample for most lights, and the plants should be mulched and lightly staked at once. Keep them well supplied with water, syringe freely when the pits are closed, and generally keep up a brisk heat. If not crowded, Kidney Beans in pits will yield heavy crops of tender pods, a close succession being kept by sowing and planting as fast as room can be spared. Even those in frames on exhausted hotbeds will prove very serviceable, and more seed might also be sown now on warm borders, and the plants be protected in some way.

BEEF.—If the seed is sown long before May the roots are apt to become too coarse. An early supply can be obtained by sowing the Turnip-rooted now, and the less vigorous growers, including Dell's Crimson, might also be sown at the same time, deferring the coarser Pragnell's Exhibition and other strong growers to about the first week in May. Sow the seed thinly in drills 15 inches apart.

PLANT HOUSES.

Shading.—Arrange the blinds on the various houses without delay, as the sun now has considerable power, and proves very trying to newly potted plants, especially after dull weather. At the same time be careful not to give too much shade at this early period of the season, or more harm than good will result. Screen the plants for a few hours only each day. Employ open material, so that every ray of light possible may be admitted, and shading of a permanent nature cannot be too strongly condemned. Crotons and other foliage plants of a similar nature must not be shaded if they are to develop their beautiful foliage to perfection. It is difficult in mixed houses to give plants the exact treatment they require, and it cannot be done when large blinds are employed for shading; for this reason two or more blinds on each side of mixed houses of plants are better than one, then the plants can be so arranged that one portion may be shaded and the other not. For example, we devote one house almost exclusively to Crotons and Dracenas. The former occupy the brightest end, and are not shaded, while the latter will be shaded for a few hours daily.

Crotons.—Repot young plants from time to time as they need more root room. Water carefully, and keep the structure in which they are grown close and moist. To grow these plants well they should never suffer by the want of root room until they have their final potting. At

first they will have the appearance of being overpotted; but in a short time this seeming difficulty will be overcome, and the plants will be large for the size pots in which they are growing. Give to plants that it is necessary to keep in a certain size pot soft water in a clear state every time they need water; a little artificial manure applied to the surface occasionally will also be beneficial. The former in a perfectly clear state may be syringed over the foliage once or twice a week, and will have a stimulating effect upon the plants. Where Crotons are needed in a small state, and quantities are damaged for various decorative purposes, insert cuttings frequently. These root quickly in brisk heat during the season of growth. When large heads are taken off cut them where the wood is soft, and then they will root without losing a single leaf.

Poinsettias.—If the old stems are cut into lengths of two joints, inserted in sandy soil, and placed in a warm house, they will soon commence growing and form roots. This is probably the easiest way of raising these plants. When cuttings of young shoots are preferred, place the old plants in heat and keep them well syringed until growth commences. When the shoots are 3 inches in length slip them off with a sharp knife and insert them singly in thumb pots, placing a little sand at the base of each cutting. If kept close and shaded from the sun under handlights they will soon root.

Euphorbia jacquiniiflora.—Place the old plants of these in heat to start them into growth. When the young shoots are 3 inches long remove the plants to a cooler place for ten days; the cuttings may then be taken off just where they issue from the old stem with a sharp knife, and every one will root if placed round the sides of small pots and stood under handlights. Young plants of last year that have been pruned back may, when they have begun growing, be shaken out and repotted. Start these in an intermediate temperature. Cuttings of *Plumbago rosea* root freely under handlights, so also do those of *Thyracanthus rutilans*. These should be placed singly in small pots, and the old plants thrown away. Directly the cuttings are growing remove them to an intermediate temperature, and finally grow them cool throughout the summer.

Gloxinias.—The earliest of these may be placed into 6-inch pots; also pot those singly that are just starting into growth, and introduce others into heat in boxes amongst leaf mould. Prick out seedlings that are large enough to handle, and sow a little more seed where late plants are appreciated.

Gesneras.—Shake the old soil from the earliest flowering of these, and start them into growth singly or two or three together in small pots. They will start quickly into growth in Cucumber and Melon houses, but once the foliage commences to form they must have a position where they will be free from the syringe. Water on the foliage turns it brown and disfigures it.

Tydeas.—Madame Heine and other varieties of this section will be lost if dried, they form no underground stems. They are propagated by cuttings which root very freely. Cuttings are plentiful now, and when they are inserted the old plants may be thrown out at once. If large plants are needed insert the cuttings singly in small pots and pinch them from time to time. When bushy plants are needed in 5-inch pots insert the cuttings thickly together in pans, and when they have commenced growing strongly re-root the tops and throw the others away. These if pinched once will make capital plants.

Medinilla magnifica.—Place this plant to make its growth where a brisk moist heat can be maintained. Syringe freely, for it is very liable to be attacked by thrip. If a larger pot is needed, shift it at once. It does well in any rich compost; for instance, fibry loam, one-seventh of manure, sand, and a little leaf mould. It will grow in peat, and also in equal portions of peat and loam.

Achimenes.—Insert cuttings thickly in pans for making up baskets. Those for decoration in pots may be inserted in 5-inch. They do well in this size, and form handsome plants, either for the conservatory or in rooms. The cuttings strike freely if shaded in a warm moist atmosphere.

THE BEE-KEEPER.

APIARIAN NOTES.

THE WEATHER.

THE 10th April brought a favourable change; the wind was softer, and the temperature reached 53°, being the highest recorded since February. The temperature from 1st to 10th April ranged between 20° and 38°, except on the 7th, when it reached 45°. The cold has had a depressing influence on both animal and vegetable life. No one could have anticipated in February the destruction that March has inflicted. The thermometer does not always give sufficient data as to the severity of the weather. Frequently it sinks to a low degree for a few minutes, but to rise again; in that case no great harm may be done, but when it remains for days with a mean temperature of 30°, or about that, then the effects of it are felt and seen.

Frequently I have witnessed ice formed upon water in barrels an inch thick under a temperature of 25°, while at other times, with a temperature of 20°, little or no ice was formed. In the latter case the low temperature had been of short duration, while in the former it had been of long duration.

THE APIARY.

If flowers and the buds of fruit trees and bushes have suffered much, but I am glad to say my bees show no falling off. A few young ones show defective wings consequent of the cold, but nothing serious. I have seen drones and heard them while on the wing. The prosperity of hives depends greatly upon the weather for the next month; if fine they will be all that can be desired, but if untoward great care will have to be exercised by the apiarist to prevent them going back.

FEEDING.

Supplying syrup and pea meal must be attended to. The old-fashioned time to commence feeding was about the middle of April, which with few exceptions had to be kept up till some time in June, and this too although swarming was common from the middle of May. Some of the best honey seasons we have had followed a cold and protracted spring, and this taught us not to neglect the bees at that season, although discouraging. Bee-keepers attend to this, but do not open up and expose hives unnecessarily; but pay attention to their wants and actions, so that you may profit thereby.

A DWINDLING HIVE.

"C. R." has a hive that has dwindled in bees considerably. Not being strong in bees at first, he housed it when the weather was cold, taking it outside when milder, and now supposes the queen to be dead, which he has forwarded to me. It is not commendable to take bees inside, then setting them out when a sunny blink occurs at this season of the year. The bees get restless, consuming more food than is necessary, they require to evacuate oftener than they would if let alone.

Bees may be successfully housed if taken into a dark compartment with the hive entrance fully opened, which may be done any time between the last week of November and the first week of December. The bees must not be interfered with, nor light flashed upon them, and should not be disturbed till the first fine day with a temperature of 50° to 55° in the shade, which may occur in January or perhaps not till March. All things considered, bees are better to be kept outside well protected.

The bees have dwindled away through mismanagement. Although the bee-keeper may think the day mild the bees let loose after temporary confinement fly farther, and rest longer on what they alight on, than bees do kept upon their stand, consequently they chill readily and are lost.

The bee forwarded in a hollow piece of a bullrush was completely smashed by the postal stamp, but I could discern by the aid of a lens the wax pockets and the hind leg of a worker. The queen is probably still alive, but it is well to know that queens are very apt to fly out hives that are opened up in spring.

The clipping sent is, as "C. R." says, "a poor production, and not in accordance with facts." The author of it may be an "expert" in writing, but not one so far as truth is concerned. Two miles after bees have been at work is by far too short a distance to move them. Four miles is not too far. What is said about the races of bees is simply nonsense, and contrary to facts. A few years since I sent amongst others in London Mr. Alfred Neighbour samples of honeycomb made by the races in question, and it was pronounced by one and all as the prettiest and finest they had seen, and these were but small samples of the bulk, much of which was finer.

The heaviest yield of honey recorded last year was gathered by Carniolian bees. Each hive gave nearly 100 lbs. each of surplus of beautiful comb, while the Punic bees made more weight and more progress than any other variety of bee in the

neighbourhood of many hundred hives. Besides, spectacles are not required to see their superiority when at work, and their extreme hardness is much in their favour.

Possibly "Expert" never had the Panie bees. But "C. R." would do well to ask, through the editor of the journal the clipping was taken from, what experience "Expert" has had with the bees he condemns. Frequently writers who have no practical experience with these superior bees advise people against them, and it is also amusing to hear some persons condemn the foreign varieties whose bees are descended from them. The pure race of black or British bees is very rare, and it is questionable if they can be had in this country.

REGISTERED FRAMES.

Will "A Hallamshire Bee-keeper" kindly answer the following question as to patent rights? Mr. J. Stabo, Balloeb, and others, ask me "If the registration of a frame by Mr. Meadows, Syston, Leicestershire, which I have had in use for nearly thirty years, and which they have made since I sold the frame to them twenty years ago, will prevent their making them in the future?" I have not seen the frame in question, but have a description and sketch. The only difference in it that I can see or learn is the substitution of a paper clip for a fine wire staple, used and described by me in different articles for many years past. I think the law would be unjust if, after a thing was invented and sold to the public by one party, then the protection given to another. Yet this seems to be the view some take of it, but wait "A. H. B. K.'s" answer. I know that one may invent and another may patent; but I always considered that this must be done before the public has got it, as is the case with this frame, as it is with some other things in bee appliances.—A LANARKSHIRE BEE-KEEPER.



All correspondence should be directed either to "THE EDITOR" or to "THE PUBLISHER." Letters addressed to Dr. Hogg or members of the staff often remain unopened unavoidably. We request that no one will write privately to any of our correspondents, as doing so subjects them to unjustifiable trouble and expense.

Correspondents should not mix up on the same sheet questions relating to Gardening and those on Bee subjects, and should never send more than two or three questions at once. All articles intended for insertion should be written on one side of the paper only. We cannot reply to questions through the post, and we do not undertake to return rejected communications.

Miltonia vexillarium (J. F.).—The plant must have been grown very strongly, and is in excellent condition to flower so freely. We have seen as many racemes as you mention, but only from the best-grown plants.

Manure for Mushrooms (A Welshman).—To collect manure over such a long period and keep turning it as you suggest would spoil it for the purpose in question. If you commence saving the manure in June you will be more likely to succeed in your object, and it must neither get unduly dry nor be heaped so thickly as to cause violent fermentation.

Patent Water Cans (W. S. S.).—We are not able to answer your question on this subject. If a sale is desired for them they should be advertised. Good articles never fail to meet with a good sale when kept before the public in a systematic way. We are quite unable to read the name of the patentee as you have written it, as it is quite illegible.

Carpet Bedding (T. H.).—Several designs of carpet beds and methods of planting them, also instruction raising various kinds of plants, are given in Cole's "Royal Parks and Gardens," which can be had from this office, post free, for 2s. 11d. Mr. Graham of Hampton Court used to publish a small manual on this subject, but we are not sure he has any copies left for disposal; you can write to him if you like.

Cinerarias (T. Crosswell).—The flowers that reached us too late for acknowledgment in our last issue were very good indeed, and arrived in excellent condition. The damp moss in which they were inserted kept them fresh for several days. You evidently selected the varieties well, and grew the plants well also. The long winter was the reverse of favourable to Cinerarias, and many plants are not so compact and good this season as we usually see them, though we suspect yours have not suffered.

White-flowered Orchids (J. J. B.).—White varieties of several Orchids are now much in demand and realise high prices; while sometimes the ordinary type of the species may be only worth a few shillings, as in *Lycaste Skinneri*, the white variety *alba* is sold for as many guineas. Of the cheaper white-flowered Orchids, such as *Odontoglossum Alexandræ*, *Cœlogyne cristata*, and *Phalænopsis grandiflora*, many are now being grown for market, and, together with the coloured *Dendrobium nobile*, make a feature in the florists' windows in Covent Garden Market. The following is a selection of the best white-flowered Orchids:—*Aceranthus Leonis*, *Angræcums*, *Anguloa eburnea*, *Calanthe Turneri nivalis*, *Cattleya Dominicana alba*, *C. Percivaliana alba*, *C. Skinneri alba*, *Cœlogyne cristata alba*, *Cymbidium eburneum*, *Cypripedium niveum*, *C. Sedeni candidulum*, *Dendrobium Deari* (very useful), *D. infundibulum*, *D. formosum*, *D. Jamesianum*, *Lælia albida*, *L. anceps alba*, and other varieties, *L. elegans alba*, *Lycaste Skinneri alba*, *L. Harrisoniæ alba*, *Masdevallia tovarensis*, *Odontoglossum Alexandræ*, *O. Pescatorei*, *O. pulchellum*, *O. Roezli album*, and *O. vexillarium album*. Some of these are not pure white, but there is very little colour in the majority, the *Lælias*, *Odontoglossums*, and *Cœlogyne* being valuable for cutting.

Gloxinias in Frames (W. R.).—The particulars you require are as follows. The seed was sown on the 19th of February. In due time the seedlings appeared and were pricked out in pans when large enough. They remained in the pans until the leaves were about 1½ inch long; they were then planted out on an old Cucumber bed in a pit without much ceremony, the rubbish being simply cleared away, and a little peat and coarse sand and a small quantity of wood ashes mixed with the surface of the soil the Cucumbers grew in. They were watered and shut up, air being given when the sun shone on the pit, and plenty of water when dry. In about a month they began to flower, and from that time till the end of October they were a sight not easily to be forgotten—one mass of flowers with foliage as large as ordinary sized Cabbage leaves. As soon as they died down the roots were lifted and stored in boxes in sand; and now, after resting all the winter, some of them measure over 10 inches in circumference. I have just potted a lot of them, and they promise to make very fine plants. The great advantage in planting them out over growing them in pots is that we have a much larger quantity of flowers from them, and they make much finer roots the first year. They should be planted a foot apart each way, rather more than less, as it is surprising how soon they fill up the space.

Stokesia cyanea (M. T. M.).—You will find this late enough, but unless it is planted in light warm soils in favoured positions it does not expand its flowers freely. It is worth every attention, however, in this respect, and it is almost if not quite unique in its profusion of lavender blue flowers some 2 or 3 inches across during the month of October. When the soil is cold or stiff it is best grown in pots plunged in ashes during the summer, when it may be introduced into the cool greenhouse, there to expand its blossoms. It grows 2 feet high, and is in all respects a first-class perennial. It is not easily increased by division owing to the tufted or conglomerate growth on the rootstock. So closely are they packed in that they cannot be separated without considerable sacrifice. It is, however, readily increased by root cuttings, and as roots may be had in plenty there is no reason why so good a plant should not be more generally grown. This may be accounted for in a measure by its lateness in flowering, when visits to nurseries are less frequent than in the spring and summer months. By lifting a single plant and selecting some of the strongest roots a good stock may be secured. Cut the roots into lengths 2 inches or thereabouts and insert them round the inside of pots in sandy loam, leaving the top just visible. By placing them at once in brisk heat good plants may be secured by the ensuing autumn. In two or three weeks or less time, according to the heat they have been subjected to, they will commence to break freely from the apex of the root cutting, and when of sufficient size they should be moved to a cooler place, subsequently potted and hardened.

Sowing Rhododendron Seed (S. S.).—Peat should be broken up and placed in a cold frame to the depth of about 2 inches, that placed upon the top being very fine. The surface must be pressed down and made as level and even as possible, and the seed sown towards the end of this month. It must not be covered, but after sowing give a good watering with a fine rose can. Great care must be taken that the surface never approaches dryness, not even after the seedlings appear. The lights of the frame in which the seed is sown should be whitewashed and kept close to prevent evaporation, and even when this is done it will be necessary to lay mats over the frame during very bright weather. As soon as the surface of the soil is green a little air must be admitted to prevent the seedlings damping off. They must be gradually exposed to light and air until the lights can be drawn off. This should be done at first during dull or showery weather, but care must be taken that the soil in which the plants are growing does not become saturated. When the seedlings are large enough, say during the early part of July, they

should be pricked off into other frames or boxes, where they can be shaded until established, and protected with lights during the winter. It is not necessary to prick off the seedlings singly; on the contrary, they may be transplanted in little patches, leaving an inch or a little more clear space between each patch of plants. The next season they will fill up this space. They should remain undisturbed during the winter, giving them the protection of mats or fern during severe weather. In spring, when all fear of frost is passed, the young plants may be transplanted 6 inches apart, so that a small hoe can be used amongst them.

Caterpillars and Hollies (F. M. M.).—"Nearly every year, sometimes to a trifling and sometimes to a considerable extent, my Hollies, and indeed most of those I see, are injured and much retarded in their growth in the spring by a small caterpillar which is found in the buds of the leading shoots of the trees. The end of the bud is partly glued up, and on unfolding it a small, generally yellow or light coloured caterpillar will be found eating away the centre of the bud. I have unfolded numbers of these buds, and have found some of them apparently perfect and naturally closed at the end, and yet each contained the caterpillar in the very middle of it. It is a matter that has puzzled me considerably. The proprietor of a large nursery was unable to explain it, and the only thing I have been able to imagine is that at the time when the buds are just opening some insect deposits an egg in them. I pinched the ends of hundreds of the buds, and so crushed the caterpillar inside, but the mischief was done, and weak ragged shoots instead of strong healthy ones were the result. I wish to ask if you would in your notices to correspondents kindly give me the information, if you can, as to what this insect is, when is the mischief done, and what steps can be taken to meet it to any extent." We insert our correspondent's letter in case any of our readers can give better information than we can. We are in the position of having nothing before us for identification, and can only say that the caterpillars may possibly be the larvæ of a small Tortrix moth, *Rhopoliota nevana*. These attack the end buds of various trees. The moths appear in July and August. A good method of prevention would be to prune the shrubs, cutting off the tips before the caterpillars emerge and burning them. Growths would start from the back buds, and though these growths would be a little later and weaker than uninjured leaders they would be much preferable to "ragged shoots" apart from decimating the enemy. It would be desirable also to remove the surface soil from around the shrubs and burn it. If the Tortrix mentioned is the enemy spraying the shrubs with a safe solution of petroleum and softsoap at intervals in July and August might possibly render them distasteful to the egg-laying moths, as in the case of the Celery fly. Any of our readers are at liberty to give further information on this subject.

Growing Produce for Market (J. J. A.).—We are afraid you will make little profit out of so small a plot of ground, especially as you have to employ a jobbing gardener, and have a large part of the land occupied with house and pleasure grounds. Besides, sending small quantities of produce a considerable distance by rail runs away with the whole or most part of the profit. Unless you have some glass and an expert gardener we very much question if you would make "ends meet." Competition is now so keen, and so many private establishments are equally ambitious with yourself to "sell something" that the markets are glutted with the kind of produce a mixed garden furnishes; indeed, much of it is not acceptable to the general consumer. It cannot be too strongly impressed on those intending to embark in speculation of this nature that gardening for pleasure and profit are very different things, and, as a rule, a great deal too much is expected by their combination. Out of half the ground available a profit is expected to be realised that will pay for the other half and profitless portion. This is your case and that of far too many private establishments. They do not pay as a commercial transaction simply because they are not conducted on sound financial principles. A market gardener, florist, or nurseryman devotes the whole of the ground to growing "stuff" to pay, and then finds difficulty in getting a fair return for his labour and outlay. How, then, can a garden be expected to afford double profit, which it must do, if considerable part of the area is devoted to pleasure, or growing flowers, fruits, and vegetables for the proprietor's private use? Not only that, but the best is often consumed at home, and the inferior placed in the market. That is suicidal, for it is only the best specimens and those cheaply produced that leave a margin of profit. This is the sort of advice we think you desire from your outspoken letter, and it gives us very great pleasure to have an opportunity of being equally decisive in reply—namely, do not invest capital in such shaky undertakings. The jobbing gardener would not assist you in making profits. If he is willing to invest half the capital necessary, then there might be a prospect of you seeing some slight profit on the little enterprise; but it is very doubtful if anyone with means would entertain the proposal. The case is entirely different when the object is solely profit, whether a person works his own money or employs other labour in manufacture. Surplus produce as a rule does not pay for marketing, but it is better sold than wasted, and the returns help to meet current expenses. We advise you to leave the matter as it is. Grow for your own use, and if anything to spare by all means sell so that "nothing be wasted," but we do not think you will derive any profit from the plan propounded. The Mushroom beds would not do between the fruit trees, being difficult to manage and cover, as well as injuring the trees.

Names of Fruits.—The names and addresses of senders of fruit to be named must in all cases be enclosed with the specimens, whether

letters referring to the fruit are sent by post or not. The names are not necessarily required for publication, initials sufficing for that. Only six specimens can be named at once, and any beyond that number cannot be preserved. (*J. Hooper*).—It is a pity you did not send the fruit sooner. We can only say it resembles Wadhurst Pippin, and that may possibly be the correct name of the variety, though no one could be positive with only a half-decayed specimen for examination. (*G. B.*).—1, Lodgemore Nonpareil; 2, Lane's Prince Albert; 3, Sturmer Pippin. (*J. O.*).—The dark fruit is Mère de Ménage, the light one Dumelow's Seedling.

Names of Plants.—We only undertake to name species of plants, not varieties that have originated from seed and termed florists' flowers. Flowering specimens are necessary of flowering plants, and Fern fronds should bear spores. Specimens should arrive in a fresh state in firm boxes. Slightly damp moss, soft green grass or leaves form the best packing, dry wool the worst. Not more than six specimens can be named at once, and the numbers should be visible without untying the ligatures, it being often difficult to separate them when the paper is damp. (*W. W.*)—1 and 6, Insufficient; 2, *Nephrolepis pectinata*; 3, *Lastrea Filix-mas cristata*; 4, *Cyrtomium falcatum*; 5, *Onychium japonicum*. (*O. W.*)—*Veronica elliptica*; 2, *Eupatorium odoratum*; 3, *Cytisus canariensis*; 4, Insufficient; 5, *Abutilon marmoratum*. (*J. J.*)—*Ranunculus ficaria flore pleno*. (*E. M.*)—The plant is probably *Crinura ornatum*, but we cannot tell without seeing the flowers. It should succeed in the stove, and while growing give it plenty of water; afterwards allow the soil to become rather dry and well ripened by exposure to the sun in a warm position.

COVENT GARDEN MARKET.—APRIL 15TH.

A BETTER trade doing at lower prices with heavy supplies of indoor goods.

FRUIT.

	s.	d.	s.	d.		s.	d.	s.	d.		
Apples, ½ sieve	1	6	to	6	0	Kentish Cobs	40	0	to	5	0
" Nova Scotia and						Lemons, case	15	0	20	0	
" Canada, per barrel	15	0	26	0		Oranges, per 100 ..	4	0	9	0	
Grapes, per lb.	2	0	4	0		St. Michael Pines, each..	3	0	8	0	
" New, per lb.	5	0	7	0		Strawberries, per lb. ..	3	0	8	0	

VEGETABLES.

	s.	d.	s.	d.		s.	d.	s.	d.		
Artichokes, dozen	0	0	to	0	0	Mushrooms, punnet ..	1	6	to	2	0
Beans, Kidney, per lb. ..	0	9	1	0		Mustard & Cress, punnet	0	2	0	0	
Beet, Red, dozen	1	0	0	0		Onions, bushel	3	0	4	0	
Brussels Sprouts, ½ sieve	3	0	4	0		Parsley, dozen bunches	2	0	3	0	
Cabbage, dozen	3	0	0	0		Parsnips, dozen	1	0	0	0	
Carrots, bunch	0	4	0	0		Potatoes, per cwt.	3	0	4	0	
Cauliflowers, dozen	3	0	6	0		Rhubarb, bundle	0	2	0	8	
Celery, bundle	1	0	1	8		Salsafy, bundle	1	0	1	8	
Coleworts, doz. bunches	2	0	4	0		Scorzoneria, bundle ..	1	6	0	0	
Cucumbers, doz.	3	0	5	0		Seakale, per bkt.	2	0	0	6	
Endive, dozen	1	0	0	0		Shallots, per lb.	0	3	0	0	
Herbs, bunch	0	2	0	0		Spinach, bushel	5	0	0	0	
Leeks, bunch	0	2	0	0		Tomatoes, per lb.	0	0	0	8	
Lettuce, dozen	3	0	3	6		Turnips, bunch	0	0	0	4	

AVERAGE WHOLESALE PRICES.

CUT FLOWERS.

	s.	d.	s.	d.		s.	d.	s.	d.		
Arum Lilies, 12 blooms ..	2	0	to	5	0	Mimosa (French), per					
Azalea doz. sprays	0	6	0	9		" bunch	1	0	to	1	6
Bonvardias, bunch	1	0	1	6		Narciss (Paper-white),					
Camellia, white, per doz.	2	0	4	0		" French, doz. bunches ..	4	0	6	0	
" red	1	0	1	6		Narciss (Various) dozen					
Carnations, 12 blooms ..	1	0	2	6		" bunches, French ..	2	0	4	0	
Christmas Roses, dozen	0	0	0	0		Pelargoniums, 12 trusses	0	9	1	0	
" blooms	0	0	0	0		" scarlet, 12 bunches	6	0	9	0	
Cineraria, 12 bunches ..	6	0	9	0		Poinsettia, dozen	0	0	0	0	
Cyclamen, doz. blooms ..	0	3	0	6		Primula (double) 12 sprays	0	6	1	0	
Daffodils, doz. bunches ..	2	0	6	0		Primroses, dozen bunches	0	9	1	0	
Eucharis, dozen	3	0	6	0		Roses (indoor), dozen ..	0	6	1	6	
Gardenias, per doz.	2	0	4	0		" Red (English) per					
Hyacinths doz. sprays ..	3	0	4	0		" dozen blooms ..	4	0	6	0	
Hyacinth (French) dozen						" Red, 12 bls. (Fench.)	2	0	4	0	
" bunches	12	0	15	0		" Tea, white, dozen ..	1	0	3	0	
Lapageria, 12 blooms ..	2	0	4	0		" Yellow, dozen	3	0	6	0	
Lilac (French) per bunch	4	0	6	0		Snowdrops, doz. bunches	1	0	3	0	
Lilium longiflorum, 12						Spiraea, per bunch	0	6	0	9	
" blooms	4	0	6	0		Tuberose, 12 blooms ..	1	6	2	0	
Lily of the Valley, dozen						Tulips, per dozen	0	9	1	6	
" sprays	0	6	1	0		Violets (Pamel), per bch.	2	6	4	0	
Maidenhair Fern, dozen						" (dark), per bch. ..	1	6	3	0	
" bunches	4	0	9	0		" (English), doz. bunch	0	9	1	3	
Marguerites, 12 bunches	4	0	6	0		Wallflower, doz. bunches	1	6	2	6	
Mignonette, 12 bunches ..	3	0	6	0							

PLANTS IN POTS.

	s.	d.	s.	d.		s.	d.	s.	d.		
Aralia Sieboldi, dozen ..	6	0	to	18	0	Genista, per doz.	8	0	to	12	0
Arbor Vitæ (golden) doz.	6	0	8	0		Hyacinths, doz. pots ..	6	0	9	0	
Azalea, per plant	2	0	3	6		Lily of the Valley, per pot	1	0	2	0	
Cineraria, per doz.	6	0	9	0		Marguerite Daisy, dozen	6	0	12	0	
Cyclamens, per doz. ..	9	0	21	0		Mignonette, per dozen ..	6	0	9	0	
Dielytra spectabilis, per						Myrtles, dozen	6	0	12	0	
" dozen	8	0	12	0		Palms, in var., each ..	2	6	1	0	
Dracæna terminalis, doz.	24	0	42	0		Pelargoniums, per doz. ..	12	0	18	0	
" viridis, dozen	12	0	24	0		Pelargoniums, scarlet, per					
Erica, various, dozen	12	0	18	0		" dozen	6	0	9	0	
Enonymus, var., dozen ..	6	0	18	0		Primula sinensis, per doz.	4	0	6	0	
Evergreens, in var., dozen	6	0	24	0		Solanums, per doz.	9	0	12	0	
Ferns, in variety, dozen ..	4	0	18	0		Spiraea, per doz.	8	0	12	0	
Ficus elastica, each	1	6	7	0		Tulips, dozen pots	6	0	8	0	
Foliage plants, var., each	2	0	10	0							

Bedding plants (in variety) in boxes, from 1s. to 3s.



SWINE FEVER.

MR. SANDERS SPENCER of St. Ives is the most successful breeder of pedigree pigs in this country, and any advice or opinion of his is received with the respect and attention it merits; yet it was with a sense of disappointment that we read his recent paper on this subject, simply because it was so indefinite. According to him this terrible disease had its origin in this country from imported animals, but he is unable to fix the date of its introduction, and can only point to the time when the disease became so serious as to attract attention. One thing is certain, and that is, that in every country where swine are bred in large numbers an infectious disease prevails among them. The hog cholera of America, the rouget of France, the rothlauf of Germany, and the swine fever of this country are alike infectious, and it is unlikely that the disease originated only in either country, and was carried to the others by infected animals.

The fact of its existence in our midst is undeniable, and the best method of its prevention or eradication is all-important. Mr. Spencer says: "If we really expect to get rid of swine fever we must submit to the compulsory slaughter of all diseased pigs, and all those which by any means have been exposed to infection, the disease being both contagious and infectious, and the virus of so deadly a nature that it is simply impossible to rid our herds of swine fever unless every possible host of the microbe is slaughtered." Compulsory slaughter has surely been in force sufficiently long to have had a fair trial, yet the fever continues alarmingly prevalent. If to compulsory slaughter compulsory cleanliness were added, then indeed we might hope for improvement.

It may be that it is spread solely by infected animals, but whether this be so or not, it is well to consider what is the duty of individuals in the matter. Most worthy of attention was the remark of an eminent London physician, that healthy persons had nothing to fear from disease microbes floating about in the atmosphere of the metropolis, simply because of their robust condition. It is the delicate sickly persons, predisposed to disease, who are in danger from such a cause, said he. Their bodies are in a condition to form a suitable nidus for the reception and growth of the microbes, for the spread of infectious disease, whose victims they become. Might not the same remark be made with equal truth about animals, and especially about pigs? For the conditions under which they are so frequently kept are certainly not conducive to health.

The spread of disease among pigs is owing in a considerable degree to carelessness. Because they can exist in a state of filth, and consume loathsome garbage with apparent impunity, they are frequently left very much to rough it, without a thought being given to the possible evil consequences of an accumulation of filth upon their health. Often have we seen pigs, large and small, burrow into dung heaps and disappear from view under dung hot with fermentation to enjoy the pleasant sensation of such an envelopment of heated matter. The effect of this hot vapour bath upon fat pigs must be an abnormal feverish condition, and the shock to the system must be severe when they emerge from it to the open air—severe, precisely in proportion to the change of temperature. Can we wonder that disease often having a speedy ending in death is the result?

In the management of pigs, as in that of all other live stock of the farm, the general tendency to tax their powers of endurance to the utmost is wrong. The principle is as unsound as its effects are mischievous, and if it were possible to trace each form of

disease to its source, we should find mismanagement and carelessness the chief cause of it. Most praiseworthy as efforts to stamp out swine fever are, we ought not to depend solely upon the destruction of tainted animals. With this a general effort at improved management is also certainly desirable, upon the sound principle that prevention is better than cure. Let not any ardent reformer rush to the conclusion that a set of new piggeries is the first step in this good work. We like neat convenient buildings as much as anyone, but it is well to avoid unnecessary expense, and so much may often be done with the means lying ready to our hands, but which because they are rough and ready have been overlooked. Failing the piggeries, we have been content to make shift with an open shed or hovel and a yard. For example, at one of our farms we have a set of model buildings, paid for by the insurance money after the old homestead was destroyed by fire. The piggeries are most elaborate and costly buildings, replete with convenience, and the pigs there have always answered well under the care of an intelligent and able bailiff, but we are bound to say that at another farm where most of the pigs are kept and prepared for market in open hovels, the bailiff is equally successful with his pigs, and we have never had swine fever at either farm.

WORK ON THE HOME FARM.

Prospects of a favourable season are increasing, the whole of the spring corn was sown early in one of the best seed beds we ever had. Land intended for roots was then prepared for sowing so far as was possible, and the Mangold seed has been sown in time to derive full benefit from the frequent April showers which have fallen daily. Though growth is slow, it goes steadily on, and the pastures are everywhere becoming greener daily with new growth; spring corn is showing a nice full plant, and Clovers are now forward enough to be of use for sheep where feed is scarce.

A watchful eye must be kept on the flock to prevent an undue consumption of tender green food, which may bring on scouring, and do much harm. This will be prevented by the regular use of dry food in the troughs, and a frequent change from pastura to folds on Rye. All the ewes with forward lambs are now in Rye folds, and are doing exceedingly well. There is very little scouring, the lambs are growing fast, and now consume a considerable quantity of lamb food. The ewes are all choice young animals, and casualties have been exceptionally few and far between. Very different to this satisfactory state of things is that of neglected or mismanaged flocks, several of which have come under our notice during the past week. In one case where the ewes were dying fast, a shepherd of high local repute was sent for. He stayed with the flock for a few days, and then left in disgust, for the ewes continued to die, and nothing he could do would prevent it. The mischief was done by the state of semi-starvation in which the sheep had been kept all the winter; they had become so feeble that they positively had not sufficient strength to bring forth young. Do not suppose that the owner of the flock is a young inexperienced beginner. No, he is well advanced in middle age, and yet is evidently ignorant of the mere rudiments of principles governing his calling in life. Well said a lecturer on agriculture recently, that such knowledge makes the difference between success and failure, between affluence and poverty, between happiness and contentment, and anxiety and struggling for bare subsistence. Let us urge home farmers to rest content with nothing short of a thorough knowledge of their business. We must know the reason why we succeed or fail, must have nothing to do with luck or chance, and must see reasonable cause and effect in all we do.

METEOROLOGICAL OBSERVATIONS.

CAMDEN SQUARE, LONDON.

Lat. 51° 32' 40" N.; Long. 0° 8' 0" W.; Altitude, 111 feet.

DATE.	9 A.M.					IN THE DAY.				Rain
	Barometer at 32° and Sea Level.	Hygrometer.		Direction of Wind.	Temp. of soil at 1 foot.	Shade Temperature.		Radiation Temperature.		
		Dry.	Wet.			Max.	Min.	In sun.	On grass	
1891. April.	Inches.	deg.	deg.		deg.	deg.	deg.	deg.	deg.	In.
Sunday	29.576	48.4	47.8	S.E.	41.1	56.2	39.2	92.5	33.2	0.243
Monday	29.693	45.4	43.2	S.W.	42.0	56.9	39.4	109.2	33.4	—
Tuesday	29.702	41.6	40.1	N.	42.9	43.4	39.1	76.1	35.9	—
Wednesday ..	29.927	40.9	38.7	N.W.	41.8	47.8	32.1	87.1	28.8	0.108
Thursday	29.983	40.3	39.7	N.E.	41.3	44.9	37.1	63.9	35.4	0.063
Friday	30.163	44.2	42.1	N.	41.2	52.4	38.9	74.8	37.9	—
Saturday	30.135	40.2	39.1	N.	41.9	48.7	36.0	77.2	28.1	0.013
	29.832	43.0	41.2		41.7	59.0	37.4	81.7	33.1	0.432

REMARKS.

- 5th.—Dull, with frequent showers in morning, some sunshine in afternoon, and heavy rain from 4 to 6 P.M.
 6th.—Bright and mild throughout, except for a few spots of rain at 3 P.M.
 7th.—Overcast throughout.
 8th.—Brilliant morning, frequently cloudy in afternoon, overcast evening.
 9th.—Light rain all the morning, then dull till 4 P.M., and rain again till midnight.
 10th.—Fair morning; dark after 3 P.M., and a few large drops of rain at 5 P.M.
 11th.—Generally overcast; a gleam of sun at 10 A.M., and showers at midday.
 A cool week, with little bright sunshine for the time of year.—G. J. SYMONS.

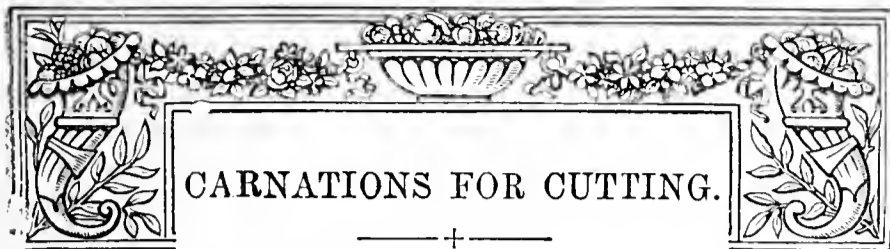

THESE present a wide field ; there are so many sections, and so many methods of treating the plants. At the outset I advise the strictest selection, for the time has passed when the number of varieties of merit were few and difficult to procure. I grow a few sorts which are planted in large numbers, and to these the ladies have gone for flowers very frequently. As a rule sweet-scented varieties are preferred, but that rule is not absolute ; and for the gardener's own use in vase furnishing some good forms which are not strongly scented will be found of value. Again, although all Carnations are hardy, there are some which my experience shows must be treated either as greenhouse or intermediate house plants. Taking first the section which can be readily cultivated out of doors, there is really no definite division, for border and show sorts can be equally well cultivated in the open air, but I refer more strictly to any varieties good for supplying cut flowers no matter of what class.

The easiest method of forming a stock of plants to supply a large quantity of bloom is doubtless by raising seedlings. The method I have pursued has been to sow in early spring, keeping the seed in heat until after germination, and then transferring the boxes to a cooler house or frame. When sufficiently large the young plants are pricked off into frames or into other boxes, and during May are planted in their flowering quarters. The following year they bear a profusion of flowers, and are earlier than named plants propagated in the usual way. In hot weather in May abundance of water is necessary, and during dry weather in summer occasional supplies ought to be given to the beds. The great drawback to seedlings is the number of plants which are practically worthless. From among seedlings I have, however, secured some good varieties for cutting, these, of course, being managed in the same way as named plants.

In selecting seedlings size should be aimed at, but if this can only be secured at the cost of compactness in the flower, then mere size is of no value. A flower which invariably splits its calyx is so imperfect as to be worthy of condemnation, and is no use for cutting purposes. Sweetness of scent is much to be desired, but the degree of intensity may be low, and the flower still remain good. Colour is a very important point, though a mere difference of shade is of no importance, for what we really want is something which tells, and if to-morrow the great majority of named sorts were to suffer a sudden annihilation, so long as the really first-class sorts in distinct and decidedly effective tones of colour remained the gardening world would sustain no loss. But given excellent qualities in the points discussed, should the plant be deficient in stamina and in free blooming qualities the lack of these ought to be sufficient to stay the perpetuation of the variety.

The best method of propagating named or selected varieties is by means of layers. When this method is carried out in the right way no one would care to rely on cuttings for a stock unless it were to increase with greater rapidity any scarce sort, when any late growths might be successfully rooted with *Calceolarias*. In growing from layers a mistake is almost invariably made in delaying the initial work to the latest possible time, instead of overtaking it as soon as possible after the intended layers are of sufficient size. The results of late propagation are roughly these. A later, and therefore less well developed, shoot has to be chosen. Roots also

are produced more slowly. When lifted to plant in autumn this operation must necessarily be delayed till late in the season, which in many years means for the plants a precarious and insufficient root-hold. If kept until spring in frames there is so much extra labour and expense incurred, and when planted they are still a long way behind what they ought to be, and have to make up arrears after getting established. The general effect is that the plants are less healthy and none of them so floriferous as they would be if treated differently.

My experience is that early propagation is all respects most desirable. By layering as soon as the grass is ready roots are formed much more rapidly, so much so that large balls of soil and roots may be lifted by the beginning of August, with plants which were layered four weeks before. These are planted directly into their flowering quarters, grown until winter, and are ready with earliest spring to go on again. As to the quantity of bloom produced by these as compared with late plants, I am a long way under the mark in giving the former six times the quantity of the latter. An earlier bloom is secured, longer continued, and a greater number of flowering stems on each plant.

Although the above is given as the result of my own experience, those who honour these notes with a perusal have only to be assured of its feasibility by reference to the modern system of Strawberry cultivation as providing a somewhat analogous proceeding. The difference between the produce of two Strawberry plants, the one layered and planted by August and the other left two months later, is so great that when early propagation and early planting were first recommended, some twenty years ago, the credibility of the proposers was called in question by not a few. Those anxious to provide a sensation with out-of-door Carnations will find the same general principles applicable, and will secure a success equally well. Where the soil is "fit" for Carnations second-year plants will be even better, and this is the method pursued by a friend of my own, but I can never depend on two-year-old plants to exist through the flowering period.

Just another point. If good flowers are wanted thin the buds. Not one bud out of five is of any use for cut flower purposes, as they are cut when unopened along with the long stalk so necessary to most people. They are otherwise hurtful, as keeping down the size of the flowers really wanted ; and I am inclined to believe that a greater quantity of flowers are in reality secured from disbudded plants, as it is quite usual for a second crop to follow the first.

With regard to varieties it is exceedingly difficult to speak. During the past ten years I have many dozens on trial, and of the greater part it may safely be said that it would have been no loss had we never seen them. The old crimson Clove, of course, ought to be grown. Madame Arthur Warocqué, I believe, will stand ahead of any other scarlet form. The best white is Mrs. Muir ; this is in every respect possessed of qualities which will place it for many years in the position of a standard plant. The best blush is Comtesse de Paris. This also is a variety of standing merit. The best "terra cotta" form is Mrs. Reynolds Hole. The best yellow is Germania, but of this variety it is only right to say that the opening buds and flowers are easily damaged by wet or damp ; of course in fine weather this is not apparent, otherwise it is possessed of the like robust growth, floriferous habit, and high quality of the flowers by the other sorts named in this selection.

Redbraes may be taken as the typical representative of Picotees I suppose that this variety will now hold a position as to popularity second to none, yet its origin is involved in obscurity. Redbraes is a name it has no right to further than it is as good as any other. Many years ago a gardener in Fifeshire sent me one or two plants with the information that he had procured it from another garden, but that no name was known for it, though it was labelled (I think) as the Crawford Priory Picotee. It has, moreover, undergone condemnation by the "florists," as it is unfortunately innocent of the few necessary accomplishments which are

indispensable in a flower of the highest cult. However, for cut flower purposes these are never missed, and most people, unless told what they are, will never notice anything amiss. Of these sorts named above from a dozen to a thousand each may be grown according to requirements, and there will be no fear of disappointment.

Culture under glass may be divided into two sections, the one to provide flowers late in autumn and during winter, and the other in late spring and during early summer. The stock for both of these sections may readily be worked up from layers, or young plants may be propagated from cuttings struck in heat in early spring. In either case the culture is of the simplest. The points to particularly note are these. If struck in heat as soon as root action begins transfer to a cooler and an airy structure. Be very careful not to pinch overmuch. I have seen some plants rendered so late from overpinching as to be useless for that season. To flower in autumn the buds must be formed during summer, and for winter and spring blooming the buds must be formed by autumn. It will be found much better to keep the plants cool until wanted with the buds ready than it is to keep growing during the shorter days in order to get them up to time. Keeping the plants quite free from aphides, and attention to watering, are the other points of importance. The plants to supply flowers in late spring and summer—a most important time for those who require flowers for the London season—ought to be kept growing very gently through the winter months, and be grown thereafter in a cool house. I propagate by layers during the preceding summer for these, and by means of this simple treatment there is no difficulty in securing flowers from the middle of March until outdoor plants are ready to cut. The queen of all autumn and early winter sorts is, without doubt, Miss Joliffe. *Germania* is also first-rate, and a batch of *Malmaison* should be prepared for this time. For the time included in the second period *Malmaisons* stand at the head of all other sorts, and along with them I now grow *Mrs. Muir*, *Germania*, *Comtesse de Paris*, *Gloire de Nancy*, *Madame A. Warocqué*, and *H. A. Elliot*, and, in addition, I have generally a good many in one to three of a sort on trial. These are all of strong growing habit, producing many flowers on each stem and with long stalks. Very good results are obtainable from plants in 5-inch pots. These take little room, and each plant furnishes a many-flowered stem. I have had them in smaller pots, but do not advise their use. Carnations, if well supplied with moisture, thrive on oft-repeated surface-dressings of chemical manures. The pots, it may also be noted, should never be allowed to stand in a position where the direct rays of the sun can dry their contents.

As to the position Carnations hold as cut flowers and the manner they are best employed, there is no doubt that they hold a very prominent place, and each year they appear to be gaining on their hold. As flowers suited for personal adornment there are none better. In the house they are always acceptable. For table decorations the pink and blush *Malmaisons* are very highly esteemed, and among yellow flowers used for the same purpose *Germania* has already taken a high place. There is no nicer method of arranging for table than by placing each *Malmaison* into a small glass globe or on occasion on the cloth. The smaller flowered varieties can be arranged in small globes several together, invariably employing good foliage of any common variety. Broad curling leafage is best. Few arrangements are more effective in summer than yellow or white or *Mrs. Reynolds Hole* Carnations, either each employed alone or in combination two at a time, or all three. These and other sorts do well in taller tube-shaped glasses. In these it is possible to make a much better effect, as the flowers can be employed with long stalks and with flowers in different stages of development on the same stem. We may secure an infinitely superior flower arrangement by employing only one stem of flowers and but a few leaves than it were possible by a greater number. On this account it is a difficult flower to arrange well.

When arranging in vases in public rooms the kind I like is a not

too large tubular glass of equal width of tube and with a narrow rim, and in this is arranged a few stems of a particular sort. For this purpose I do not think any surpasses *Mrs. Reynolds Hole*. In this sort you secure a tall branching stem 2 feet in length if you please, and with three of these and as many strong growths for setting a most lovely arrangement is secured. *Mrs. Muir*, *Comtesse de Paris*, and *Redbraes* lend themselves freely to this style. As a rule the natural arching habit of the plants should be taking advantage of; but where this cannot be done in small or flat glasses then avoid all approach to sameness. It is much better to use plenty of growths for a rough foundation and a setting, and add as few flowers as possible, set in a natural manner.—N. B.

CULTURE OF THE CALCEOLARIA.

WHEREVER *Cinerarias* and *Primulas* are grown *Calceolarias* find a place also. This is not to be wondered at, for their beautiful pouch-like flowers present to the eye a display quite as gorgeous as any plants in cultivation. From a packet of seed plants with self-coloured flowers in shades of crimson, lemon, orange, maroon, rose, and other intermediate shades may be secured, also the more delicate spotted, laced, and other forms, the whole producing a charming effect, over which the eye of the lover of colour never seems to tire. Though easy to cultivate, still in many instances they are found, alas! too often, in a most indifferent condition, and struggling through a brief existence, and in many cases entirely ruined by the pest which most infests them—viz, "green fly." These thoughts are prompted by a glance at the plants, which are pushing up fine strong flower spikes, and which will soon be ready to take the place of the last *Cinerarias*; and as the time will be soon approaching when the cultivator will be turning his attention and thinking of his stock for another season, a few notes on their cultivation may not be out of place in the *Journal*.

The first point to consider in the successful cultivation of this plant is the sowing. Mix a compost composed chiefly of leaf mould, finely sifted, and sand. Crock the pans or pots carefully, and over the crocks place a thin covering of rough leaf mould, and fill nearly level to the rim with the compost recommended, press the soil firmly, and make the surface quite level. As the seed is so minute care is needed in sowing, and it must be covered very slightly. Water through a very fine rose, place a sheet of glass over the pan, and remove to a cool frame or house, and shade from the sun. I have not advised the number of sowings to be made, as that must be considered by the amount of space at command. The last week in May or first week in June is early enough for the first sowings, which may be repeated until the end of July. I would sooner sow two or three weeks earlier than subject the seed to heat, as I have often seen done, with a view to hurrying the plants on. To do so is to court failure, and many instances of sickly grown plants may be attributed to this cause as much as to any other.

As the young seedlings become large enough prick off into pans or small pots, using much the same compost as that before mentioned. If this moisture is used and the seedlings carefully watered there is not nearly the same risk attending their damping as if placed in a heavier compost. A cool frame with a bed of ashes having a north or east aspect will be the most suitable place for them. As the pots become filled with roots shift into larger ones. Six-inch pots are very useful, but if large plants are required the size may be extended to 10-inch pots. The compost we have used for many years with great success is as follows:—Two parts leaf mould, one part good fibry loam, either red sandstone or charcoal broken small, with a fair sprinkling of bonemeal and silver sand. The pots are crocked, and on the crocks is placed a layer of flaky leaf mould, and the soil in the pots made firm and then transferred to frames. When the plants have taken to the new soil we syringe twice a day, completely wetting every part of the foliage. As they cannot remain long in the frames after the final potting we remove them to a house facing east, from which frost is just excluded. Air is admitted on every favourable occasion, and when the pots become filled with roots liquid manure should be given twice or thrice a week. This not only produces fine healthy foliage, but on this depends the vigour whereby the plants can carry stout flower spikes. The plants may be fumigated twice, and this ought to be ample if the plants have been well grown. To increase the size of the plants the points may be pinched out of a portion of them. This induces a branching habit and retards the flowering as well. In conclusion, the chief aids to their successful cultivation may be summed up. Grow the plants from start to finish as cool as possible. Let the compost be rich and porous. Water unsparingly when required, syringe on every favourable occasion, and ventilate

freely. Fumigate lightly, and supply liquid manure as the pots become filled with roots. This being done there is no fear as to the result—R. P. R.

GREEN FLY ON PEACH TREES—SETTING FRUITS WITH THE SYRINGE.

I HAVE read with some interest the criticism of Mr. H. Dunkin in answer to my remarks as to syringing Peach trees in bloom, and he has certainly tried in a very elaborate manner to upset my opinion on the subject. I may tell him at the outset that I am in no way prejudiced against any system that can be proved to be sound, but I am not going to depart from the beaten track until I have more conclusive proof of the superiority of the syringe over the camel's-hair brush.

The system of the followers of the beaten track has proved itself sound in principle for years, and it is a system that the overwhelming majority of the best practical men pursue, and that has produced some of the best results. I consider in the first place that syringing during the flowering period of Peaches is no more beneficial than judicious damping; all we require is a genial condition to facilitate the object in view. Syringing early in the day may possibly be rapidly followed by snow or rain, when the house must of necessity be closed, and cannot be of any benefit to the trees in flower to be then laden with moisture. Our friend's system may answer in some cases, but not all; it depends in a great measure upon the construction of the house and its adaptability for the occupants therein, but I maintain it will not answer generally. The camel's-hair brush is safe anywhere and under all conditions. Constantly syringing trees in the early stages to prevent the appearance of green fly is altogether a fallacy; the thing is to annihilate the enemy before the blooms expand, for it is quite possible it may be lurking near although not perceptible, and if it gains a foothold with the opening of the first few flowers then look out, for all the syringing will not arrest its progress. So much syringing about trees with very little leaf or root action is the way to bring about an unfavourable atmosphere and to encourage the pest.

With regard to having practical proof of the method your correspondent so bravely upholds, I may tell him I have tried it upon a variety of plants, Vines included, and I cannot say much in its favour. It is a doubtful method, and it happens that the doubt is nearly always well founded. I find I can obtain more satisfactory results on the good old practical lines, and as long as that continues to give such satisfaction I shall not turn aside from the beaten track, as our friend so aptly terms it.

Fumigating is certainly a serious item in most gardens of any pretensions, but the cost of a few pounds of tobacco paper is nothing when the importance of the object is considered. It is no use spoiling the ship for the proverbial ha'porth o' tar, and prevention is better than cure, for I want more proof to believe that syringing Peach trees in bloom will prevent the appearance of green fly. When I spoke of fumigating after the fruits were set on the first appearance of aphides, I meant when they were visible in different parts of the house. Of course, if there were only a few confined to one corner the person in charge must exercise his judgment as to the necessity of fumigating the whole structure. Then Mr. Dunkin tries to find a loophole in my term, which I will modify a little for him, and say generally, in all sorts and conditions of houses. Syringing in many naturally damp structures, and especially if unheated, requires a good deal of discrimination, and so does fumigating, but in the hands of a careful man who knows his business I consider the latter can be applied generally; but syringing trees in bloom cannot, no matter how careful the operator. The injury arising from fumigating is the fault of the individual doing the work, not of the system, and before the flowers expand he would be indeed clumsy to do any damage. After the trees begin growing a great deal of care is necessary, but so little smoke keeps the pest down that it is difficult to go far wrong if common sense is used; only what that able cultivator Mr. W. Coleman once called an animated machine, would do damage anywhere.

I do not believe it necessary to keep such dry atmospherical conditions when Peaches are in bloom as many cultivators do. What is required is a congenial state of things, neither too dry nor too wet. Another point is that when the stigma of a flower situated on the top of the tree next the glass is elevated above the stamens, the pollen is more apt to fall downwards than to lodge upon it, under the syringing process; at any rate there is no fear about missing it with the brush. Then your correspondent calls my theory a fallacy, when as a matter of fact it is not my theory, nor is it a theory at all, but a plain solid fact, that has been practised for years by the majority of the most successful men of the present day.

Next we come to the large flowering Peaches, when I must still beg to differ from our friend, but he has selected the three most certain croppers of all. What about Noblesse or Hale's Early in flower in January? And to conclude, any practical person knows at what a rapid rate evaporation takes place on a sunny day if a house is syringed and ventilation left on; and although while in flower there is no foliage to burn, as the season advances and the sun gains power it must certainly be doubtful practice with respect to the delicate floral organs. But upon the lines I follow I secure highly satisfactory results, and until I can procure some stronger evidence of the

superiority of Mr. H. Dunkin's plan I shall pursue the even tenour of my way.—J. J. C.

I HAVE for many years read with pleasure and profit the admirable articles which have appeared in the Journal from the pen of Mr. Wm. Bardney, but I cannot agree with him in his recent note on the above subject. Readers will naturally infer from his opening remarks that he considers Peach culture without aphides is well nigh an impossibility, and to use his own words, "Neither will syringing nor other treatment, however wise and good, prevent their appearance." Granted that when once the trees have been attacked by these pests some of them are continually lurking about the house, yet there is not the slightest difficulty in keeping them away if the trees are syringed regularly till they come into flower. Then the usual practice is to keep the atmosphere of the house much drier, and syringing is dispensed with for a time, conditions favourable to the spread of aphides.

After having kept the trees clear of the attacks of green fly up to the flowering stage the question arises as to the best means of keeping them free from these pests, and at the same time securing a "perfect set of fruit," and let it be noticed here that I draw a great distinction between a "full" and a "perfect" set of fruit. If a sufficient number to form a good crop were set this might certainly be termed a full one, but it would not be a perfect set unless there was a sufficient number to choose from, and to be able to select the best placed and most vigorous fruits, equally distributed over the surface of the trees, and situated on the upper side of the shoots so that they may be evenly coloured when ripe. Returning to the treatment of the trees during the flowering period I cannot admit that a perfect set can be insured with certainty by simply shaking the trees, although it is quite possible it may happen occasionally. In dull weather this method would not be effective, and in bright weather a gentle syringing in the middle of the day is a much better plan, because it creates conditions unfavourable to the development of aphides, and anyone who has given the matter a fair trial cannot dispute its efficacy in setting the fruit.

I ask readers generally to consider the kind of weather we frequently have when Peach trees in midseason and late houses are flowering. Cold nights are followed by bright days, often attended by a drying wind; by midday the atmosphere of the house is dry, and often feels quite parching on entering the house. This might be counteracted to a certain extent by sprinkling the floors, but it would not so effectually freshen the trees and tend to keep them in a healthy growing state any more than they might be kept so in other stages by damping the floors only instead of syringing the trees; and when, as in this case, the syringing also performs the work of fertilisation, it seems to be the best method to pursue. The services of careless men are not much valued in gardens. I have never yet been unfortunate enough to have to deal with Peach trees which retained moisture upon the flowers until 10 A.M. Where such is the case I should consider the situation must be very low and damp, or the roof of the house less acute than a well arranged Peach house should be, or—and perhaps this is most important—air was not admitted soon enough.—H. DUNKIN.

NOTES ON HYACINTHS.

BEFORE it is too late—before the last bulb of spring has faded and gone—let me crave space for a little chat about those valued flowers of spring, Hyacinths and Tulips—the former now, the latter in a subsequent paper. Many Hyacinths are already over, and have long since completed their season's duty, but in some greenhouses and conservatories later varieties are still making a display in company with their brightly coloured associates. I am tempted to enlarge on the exceptional beauty of these lovely flowers in a general sense, but, after all, this is now generally recognised, and though the time has not yet come when they are to be found in every house and glass structure, they are spreading year by year.

It is very pleasing to note that the flowering this season has been, and is, eminently satisfactory. The Hyacinths at the spring shows have been admirable examples, those of Mr. Douglas at Regent's Park being worthy of his best days. Messrs. Williams & Son of Holloway and their namesakes of Finchley also exhibited some splendid specimens. Generally speaking, whites have been very fine, blues good, reds only moderate. It is not easy to understand why the latter are so far below the usual mark. There may be some abstruse physiological problem to solve before the reason is ascertained, but it is unquestionably a fact. I inspected those at the shows with the greater interest from desiring a comparison with the condition of my own not meagre collection, in which the reds were not quite so good as the others. Von Schiller, usually one of the finest of all, has not been in its best form, but it has nevertheless been an admired object. The feature of this beautiful variety is its dense truss. The colour, red with a lighter edge or band, is distinctly pleasing, and the massive spike of bloom is always conspicuous. Lord Macaulay, which has also been a little weaker than usual, somewhat resembles it. Vuurbaak is one of the most beautiful of the deep reds; the truss is not of the largest size, but it is beautifully formed and the colour is exceptionally rich. Mr. Douglas had a magnificent example of it at the Botanic Show. Koh-i-noor, semi-double, bright rose in hue, is a charming Hyacinth with a shapely truss, but somewhat high-priced. Rubra maxima is a very pretty pale pink, and Moreno is another variety of somewhat similar colour that is well worth growing. Prince Albert Victor, with its very neat truss and rich colour, has greatly pleased me. It would be largely grown if cheaper.

Homerus has been a disappointment in one respect, but a pleasant surprise in another. It has not, as is customary with it, been the earliest of its class, being later than Garibaldi and General Pelissier, but it has given better spikes than I have ever before seen of it. This is a very useful light red Hyacinth for forcing to succeed the Romans. Garibaldi is a deep red of considerable merit, and this year was the earliest of all in bloom. It is a most valuable variety, but unfortunately it is dear. Cardinal Wiseman is a splendid rose-coloured variety with a truss almost as fine as that of Von Schiller. There were some superb examples of it at the great Haarlem Show last spring, and no one who saw it could fail to admire its beauty or note its great value as an exhibition Hyacinth. Mr. Douglas, Mr. Noakes, and other exhibition growers should certainly order it. Solfaterre, a much older variety, is noticeable from its warm and attractive colour, and the truss is fairly good.

There has been no dark blue to excel King of the Blues, and should one ever be raised it will be a great acquisition. Beautiful in hue, perfect in habit and form, it seems possible to look for no improvement on King of the Blues, save a greater breadth of truss. One can pick this variety unerringly from hundreds of others by reason of its splendid habit, symmetry, and colour. A double counterpart of it on a smaller scale is Laurens Koster. Grand Maître, though very large, is faulty. It is a useful rather than a high class medium blue. Masterpiece is very dark in colour, almost black, and its dwarf habit and even, perfectly finished truss, insure its being picked out by most persons for special admiration. Sir Henry Barkly is too loose, and so is Captain Boyton. A good Hyacinth should have the spike closely furnished. Lord Palmerston and General Havelock are both meritorious dark blues. Amongst the light blues it is very hard to select amongst Lothair, Lord Derby, Queen of the Blues, and Czar Peter. All are grand varieties. Czar Peter has the enormous advantage of being very cheap, it can be had for 6d. or even less; moreover, it is excellent in form and colour. Lothair has been superb this year. Its breadth and massiveness of truss are remarkable, while the size and substance of the bells, the dense manner in which they cluster on the spike, and the lovely shade of colour, combine to render it a variety of the highest merit. One can only understand its being seen so rarely from the fact of its being somewhat expensive. Queen of the Blues, of the purest Cambridge blue, is a fitting companion to the King; and Lord Derby, a well known Hyacinth, is equally as good, the beauty of a well-grown plant invariably eliciting the highest encomiums. Those who can afford it should grow them all. Other useful light blues may be mentioned in Charles Dickens, Leonidas, and Grand Lilas; and before passing from the blues altogether I ought to give a word of deserved recognition to the useful and cheap dark varieties, Bleu Mourant, Marie, and Argus.

La Grandesse is still the leading pure white. It is a lovely variety with its large truss, huge bells, and exquisite purity of hue, white as the driven snow. La Neige is poor beside it, and Madame Van der Hoop is perhaps the nearest to it in merit of the cheaper ones. Blanchard, though small, is extremely neat and symmetrical, and Grand Vainqueur is good and reasonable in price, the same remark applying to Baroness Van Tuyl. Snowball and L'Innocence are valuable pure whites, too. The latter is very chaste and pleasing. Finest by far of those departing from the snowy hue of the whites proper, and known as shaded or blush whites, is Anna, splendidly shown last year in Holland. I have grown it in ordinary compost in a 4-inch pot this season, and it has borne a large truss with bells more than 2 inches across, of the greatest substance, and of a delightful ivory white hue. The plant was greatly admired when I showed it at Regent's Park, and if in ordinary soil and with no special attention it is of such merit, it ought to be fine indeed if taken in hand by our skilled exhibition growers. The bulb was procured from Ant. Roozen & Sons. La Franchise also has a very fine bell, and is deliciously sweet, while other blush varieties of sterling merit are Voltaire (very cheap and good), Grandeur à Merveille, and Leviathan.

The yellows and miscellaneous shades provide some very attractive varieties. Of the former, perhaps Ida, canary yellow, is the most popular, and it is undoubtedly very attractive, but King of the Yellows has been better with me this year, and the colour is deeper. L'Or d'Australie, usually very good, has been somewhat straggling. Orange Above All, a variety of Ant. Roozen's, is as distinct as it is distinctly named. Due de Malakoff is a peculiar mixture of rose and yellow, and although some prefer a more decided colour, no one finds fault with the habit of the plant nor the well-formed truss. La Précieuse, difficult to describe as to colour, something of a lilac shade, is worth growing, and so is the purplish mauve variety Haydn, while in the rosy lilac Laura we have one of the most charming Hyacinths in cultivation. Mr. R. Sydenham, no mean judge of beauty and merit in a bulb, picked it out as the loveliest Hyacinth in the big Dutch Exhibition last year, and in due time it must become very popular. At present it is scarce and somewhat dear.

My Hyacinths, numbering about fifty varieties, have nearly all been grown on the small pot system of the Dutch growers this year. Many of them have been in 4-inch pots only, others in 4½-inch, and none larger than 5-inch. The results have been in most cases dwarf growth, stout healthy foliage, and good trusses of bloom. Mr. Cummins of Hackbridge, who grows tulbs as well as Orchids, is a firm believer in the small pot plan. The soil is made as firm as possible consistent with not making it so hard as to prevent the roots from penetrating it freely, and if abundance of water is provided when the pots are well furnished with roots satisfactory results may be achieved without elaborate attention. To amateurs, at all events, it may be interesting to hear that

excellent trusses of bloom can be had with small pots, an ordinary mixture of soil, such as loam and leaf mould, with a good sprinkling of sand, and the protection of a few rough boards for a few weeks while the pots are plunged in cocoa-nut fibre refuse. Luxuriant growth and a too early maturity are checked by the conditions indicated. Dwarf sturdy growth proceeds steadily; healthy, substantial, but not abundant leafage slowly develops, and finally the full power of a mass of stout vigorous roots is devoted to the production of a noble truss of bloom, well fitted to adorn the greenhouse, the sick room, or the window. The fleshy succulent roots will tell their own story of a love for moisture if all that has appeared on the conditions that govern the Hyacinth in its Haarlem home has been written in vain. So use the watering can with a liberal hand, thereby insuring freshness of root, plant, and blossom, glossy foliage, rich colours, and a prolonged period of beauty.—W. P. WRIGHT.

ARRANGEMENT OF HOT-WATER PIPES.

THE question of saving fuel by the employment of special boilers, new or old, is one that has occupied the thoughts of many besides Mr. Hugh Dale (page 280). It would be difficult to point to any particular boiler which possesses all the advantages claimed above others, as so many circumstances have to be considered, such as method of setting, amount of piping attached, and the manner in which the connections are made. The houses are often on various levels, and the greatest difficulty is caused, not only in regulating the amount of heat required in each compartment by the same consumption of fuel, but at times, owing to the faulty arrangement of the hot-water pipes in a particular house, the fire has to be driven harder to get up heat sufficient to compensate for the injudicious placing of the pipes. The result is a greater consumption of fuel, for which the boiler is erroneously blamed. When other houses are added to the number first arranged for, the question of whether the boiler is powerful enough to supply extra heat by the consumption of the same amount of fuel is not always considered, and the fuel bill is consequently increased.

The form of boiler is important, and the saddle shape so constructed that the full heat from the fire is utilised instead of allowing it to escape up the chimney needlessly is one to be recommended to give satisfaction; but as previously stated, it is not entirely a question of the kind of boiler employed, but of local circumstances which either sustain or detract from the professed reputation of any particular boiler. The question of fuel is under some conditions a serious item in garden management. I have tried in a 4-foot boiler of the construction referred to several kinds of fuel during the last eleven years, such as coke, anthracite, and various sorts of coal—nuts, slack, smokeless, steam, and that for household use. The preference is given to anthracite decidedly as giving much the best results. To burn this fuel the boiler should be set so that the flues and chimney will give a quick draught, but be under control with the aid of the damper. A saving not only in the cost of material but in the labour of stoking is effected by the employment of this coal in addition to maintaining heat in a satisfactory manner. Three thousand feet of 4-inch piping is attached to the boiler; the houses are of the usual kind, such as Muscat and other vineries, plant stoves, Melon, and other houses, some of them lofty, and all exposed to east winds, which are much felt in the spring. Where many persons make a mistake in burning anthracite is continually poking the fire. This is neither necessary nor desirable. The great point to observe is cleanliness of the fire bars. During the afternoon or towards evening, when the fire is low, the bars can be entirely freed from clinkers and ashes, leaving nothing but bright fire in the furnace. So few clinkers does anthracite make that no further trouble should be experienced for that night in clearing the fire; the coal added will give abundance of heat if left alone, and need little attention. If cleaning the fire bars and the end of the boiler where the flues join on both sides is neglected, allowing the latter to be choked with fine ashes, it is no wonder that anthracite is condemned as useless; a quick draught under such conditions is not possible, and without this stoking will be a failure either with this or any other fuel or form of boiler. I append the amount of anthracite burnt and its cost for the last two years. In 1889 it was 45 tons 7 cwt., £46 10s. 2d.; during 1890, 41 tons 6 cwt., costing £48 6s. 2d., neither of which can be considered extravagant in heating 8000 square feet of glass.

Regarding the question whether I have made out my case of distributing the heat equally over the house by a "network of hot-water pipes over the borders" or not, to the satisfaction of Mr. Hugh Dale, I can only say that the permanent welfare of the occupants of the houses here so heated and the general working facilities have had careful consideration. The network of pipes is regarded as a boon more than anything else for building the stages upon, which have to support numbers of plants in pots, such as those required for bedding with Palms, Ferns, French Beans, and others too numerous to mention, as we cannot afford to have houses for Vines only. I know from experience that it is easier to maintain the temperature in an equable manner under the method which I described than by the clustering system of arrangement. If I have proved that by the spreading out plan Grapes can be cultivated with immunity from red spider, I consider I have not written in vain, as this pest is the worst enemy Grape growers have to deal with, especially those with limited experience.

In arranging the pipes in a span-roofed house like that of Mr. Hugh Dale, I do not agree with the plan of having the flow pipes nearest to the centre path; if one flow had been placed close to the front of the house and the remainder spread over the border with the return pipe nearest the path, the temperature of the house would have been

regulated just as easily as by having the flows in the middle. The front of the vinery would have had the advantage of one pipe to warm the air coming in that part more than it would from the return, and the heat would ascend to the highest point of the vinery—no fear about its doing that. In his case the body of heat simply had to ascend in a straight line, not in such a useful manner as though it were equalised over the house. I have always been taught that it was necessary to provide against currents of air which come through the front ventilators. This, I was also taught, was the most easily done by fixing one flow pipe there to counteract the current by warming the air as it entered.—
HEATING REFORMER.



JOTTINGS.

ORCHIDS were grandly represented at the R.H.S. meeting last week, and afforded ample proof, if such were needed, that these plants are still first favourites in numbers of important gardens. Beyond that, too, their condition, beauty, and interest supplied abundant substantial reason for their long continued popularity, as the ornamental value of well grown specimen Orchids is unsurpassable. Brilliant and distinct shades of colour, singular forms, and profusion of flowers, are the qualities which place Orchids in so prominent a position wherever they are seen with other plants.

On the evening of the meeting in question Orchids also formed a special subject for discussion at the Horticultural Club, and a few remarks upon doubtful points in the culture of cool house Orchids led up to an interesting discussion, in which several members joined. Some gentlemen complained of the difficulties attending Orchid culture, and after trying plants successively in stove and greenhouse had discarded them as beyond their ken—a not very surprising result. Somewhat similar treatment in the early period of the plant's history in this country, even sixty years ago, led to the formation of very erroneous ideas respecting the difficulties attending the culture of Orchids, and some then went to the length of asserting it was impossible to succeed with them under artificial conditions. Such notions have long been exploded. It is now admitted by the most successful that the majority of Orchids are very easily grown, and the time, skill, and expense they require are certainly not so great as were needed by the hardwooded plants at one time so generally grown.

The Rev. H. D'Ombraïn remarked that the best greenhouse Orchid with which he was acquainted was *Disa grandiflora*, which he had cultivated successfully in a structure devoted to mixed plants for twenty-eight years. He also commented upon the beauty of this brilliant Orchid in terms of well merited praise, stating that he had never found any special difficulties in its culture. It was, however, observed that one large nurseryman had been trying to grow *Disas* for ten years and invariably failed, so that it was found necessary to have the stock grown elsewhere. Another nurseryman had, however, found it quite as easy to increase and keep in good condition as Mr. D'Ombraïn, and had raised a large stock from seed.

Some reflections upon the Glasnevin variety of *Disa grandiflora* brought out Mr. F. W. Moore, who in the course of a vigorous speech, summed up in an admirable manner, the chief requirements of cool house and other Orchids—namely, close attention and the due exercise of common sense. He was opposed to any stringent rules as to temperatures, but stated that his experience coincided with that of the individual who opened the discussion in regard to the fact that many so-called "cool house Orchids" were grown too cold, an opinion in which several others joined before the discussion elapsed.

A party of seven Orchid lovers representing five nationalities assembled at Waterloo on Thursday last for a journey to Baron Schröder's garden at Egham, and a long chapter would be required to describe all that was seen and admired that afternoon. At present only the simple fact can be recorded that the grand collection of Orchids and other plants at The Dell seems to improve in condition and beauty every season, though when inspected a few

years ago it was thought impossible that they could look better. What strikes a stranger more than anything is the uniform vigorous health of the plants, and the care that has been exercised in the selection of the best varieties has created a very high standard. Our continental friends were more than astonished, and considered their journey to England well repaid by this visit alone

Returning to the exhibits before the Orchid Committee, a new hybrid *Dendrobium*, appropriately named *Venus* (fig. 59), is accorded special notice this week because it was not only an interesting result from a well-considered cross, but it is likely to become one of the most useful of the free growing and free-flowering *Dendrobiums*. It was obtained by Mr. Norman C. Cookson of Wylam-on-Tyne from a cross between *D. nobile* and *D. Falconeri*, and presents a remarkable combination of characters derived from these species, both in flower and growth. The flowers are like a large *D. nobile*, but with somewhat of less of the solidity of that parent, and more of the graceful pose of *D. Falconeri*. They are $4\frac{1}{2}$ inches in diameter, the lip being $1\frac{3}{4}$ inch long and $1\frac{1}{2}$ broad. The sepals and petals are broad, white tipped with crimson; the lip having a deep bold maroon central blotch, a broad white band, and a crimson tip. The pseudo-bulbs are more slender than



FIG. 59.—DENDROBIUM VENUS (HYBRID)

D. nobile, and partake of the character of *D. Falconeri*, but are more erect and stronger. It is unquestionably one of Mr. Cookson's greatest successes, and with other hybrids from the same place passed into the hands of Messrs. F. Sander & Co., St. Albans.

What are frequently termed yellow varieties of *Odontoglossum Pescatorei*, but which some regard as forms of *O. excellens*, are apparently becoming more numerous. Last week one from Egham named *dellense* received a certificate, and this week another named *Prince of Orange* from Buiford Lodge received a similar award. In the rich golden yellow of the ground colour the last-named has never been surpassed; it is indeed most effective and well deserved the honour accorded. It is a pity, however, that the nomenclature is becoming more confused than ever, for at one meeting we have a variety or hybrid with a botanical name, and at the next one under a popular designation, and all alike seem to receive official recognition.—L. CASTLE.

DENDROBIUMS.

[A paper read at a recent meeting of the Liverpool Horticultural Association by Mr. JNO. GLOVER, gardener to Sir Andrew Barclay Walker, Bart., Gateacre Grange.]

(Continued from page 261.)

MOST of the *Dendrobiums* delight in a very moist atmosphere with a high temperature when growing. During the months of

March and April 70° by day and 65° at night will be suitable by fire heat, with 10° added by sun heat. During May, June, July, and August the day temperature may be 75° by day, to 85° or 90° by sun heat, with 70° at night, reducing these temperatures 5° during September if the growth is in a forward state; if not in that forward condition the temperature must be kept up to finish the growth in that month; afterwards it may again be lowered to 65° by day and 60° at night during October. Remove the plants to cooler quarters for three months where they can be exposed to plenty of light. These temperatures apply to the East Indian Dendrobiums, but there are many from Australia, Japan, China, and northern India that may be grown in much lower temperatures in vineries, and enjoy the same treatment as the Vines growing and resting with them, the shade from the Vines suiting them while making growth, and exposing them in the autumn to ripen in the lightest position in the house, with a circulation of air.

WATERING AND SHADING.

Supply water liberally in the growing season, as they require plenty to sustain the young growth. After they have made a few inches of growth, and are showing young roots on the surface, the compost must never be allowed to become dry; at that time a moist atmosphere is also essential, and must be regulated by the state of the weather. If it is hot the demand is greater than in dull, cloudy, or wet weather. If in good condition the growth will be complete by the end of September, when the supply must be gradually reduced to induce rest.

Shading is necessary during the hottest months while the growth is young, but must be discontinued when approaching maturity, to ripen the strong growth previous to rest, or shrivelling will be the consequence.

RESTING AND FLOWERING.

After the growth is finished Dendrobiums may be allowed a good season of rest by moving them into a cooler but dry house, such as a vinery where Grapes are hanging, and require just sufficient heat in the pipes to drive away damp. During the time they are resting they must have very little water, only sufficient to prevent the stems shrivelling, and it is better to give none in hard frosty weather, as they can stand a lower temperature much better when quite dry. This is the only way to make them grow vigorously and flower freely.

Many of these that made an early growth will show flowers in January, and may be introduced into heat again as required for succession, withholding water until the bloom buds are well advanced; for if water is given too soon it induces the plants to start growth, which weakens the flowering considerably.

INSECTS.

When green and yellow aphides appear in spring on the young flower buds they may be destroyed by fumigation with tobacco smoke, or by sponging the plants with rain water and a little softsoap added at the rate of 1 oz. to the gallon of water. Thrips, red spider, mealy bug, and scale will be troublesome if the plants are not in good condition, and must be kept in check by sponging with the same solution, a small portion of tobacco water being added, or any other approved insecticides according to the directions given. A free use of the syringe during the growing season, with plenty of heat and a circulation of air, will prevent any serious attack of these pests, and prevention is always better than cure. Cockroaches, crickets, woodlice, and snails must also be looked after and trapped, for they are very destructive, eating the points of the young roots, which weakens the growth of the plant seriously. They must be sought for both day and night, searching for them by candlelight when they are out feeding, and in the day by moving the pots, or any place where they are likely to harbour. Woodlice and small snails may be trapped by cutting Potatoes in two, scooping out the inside and placing them on the pots and stages. Turnips cut in slices will answer the purpose, also small flower pots, with a little dry moss or hay covering a little boiled Potato at the bottom of the inside, and laid on their sides in different parts of the house, are, if examined daily, very effectual traps. Phosphor paste laid on bits of paper about the house at night is also very good; beetle powder answering the same purpose by using it in a similar manner in small quantities and repeated at frequent intervals, as it is no use after it is wet. It is better to move these mixtures away in the morning, and lay them again on the second or third night after; persevering with these preparations will eventually clear these pests away, or at all events keep them down to small numbers.

The following are suitable for vinery treatment:—*D. nobile*, *D. moniliforme*, *D. chrysanthum*, *D. speciosum*, *D. Hilli*, *D. pulchellum*, *D. densiflorum*, *D. thyrsiflorum*, *D. Devonianum*, *D. Falconeri*, *D. Farmeri*, *D. fimbriatum*, *D. heterocarpum*,

D. Jamesianum, *D. lituiflorum*, *D. crassinode*, *D. Wardianum*, and *D. Deari*.

Stove Dendrobiums:—*D. aggregatum*, *D. albo-sanguineum*, *D. Bensoniæ*, *D. bigibbum*, *D. Brymerianum*, *D. chrysotoxum*, *D. erepidatum*, *D. cretaceum*, *D. crystallinum*, *D. Dalhousieanum*, *D. eburneum*, *D. formosum* and *f. giganteum*, *D. Harveyanum*, *D. infundibulum*, *D. macrophyllum*, *D. Parishii*, *D. primulinum*, *D. Schröderi*, *D. suavissimum*, *D. superbiens*, *D. tortile* and *tortile roscum*.

THE BOUVARDIA.

THE Bouvardia is undoubtedly one of the most useful winter flowering plants for a warm house, yet it is seldom found well grown in any quantity outside the nurseries that make a speciality of it for market purposes. The reason, I believe, is that it is grown in too much heat. A stove temperature is not required, but a warm greenhouse or intermediate house is the best for the flowering season. I have been very successful with Bouvardias, and find them so useful that I will describe my treatment in the hope that some who have not been able to grow it well may obtain a serviceable hint.

In the first place I take the cuttings at the beginning of March, and insert them five or six in 3-inch pots, and plunge them in gentle heat in a warm house. When roots are formed I place the plants singly in 3-inch pots and transfer to a Cucumber frame with a little bottom heat to start them, after which they are removed to another frame by themselves. The bed is made so that the plants are as near the glass as possible to prevent their drawing, and they are then stopped for the first time. When they are ready for attention again they are placed into 6-inch pots, which is the size I find convenient for the shelves on which I place them to flower. At this last potting I employ rather stronger soil than previously, and mix ground bones and Thomson's plant manure with the fibry loam, leaf mould, and sharp sand. I grow the plants in cold frames until the nights are cold in autumn, closing early, and giving a sprinkling with a fine rose, and keeping the shoots stopped until they are bushy plants, when they are removed to slate shelves before mentioned, slate along the back of a warm greenhouse. After the pots are well filled with roots a top-dressing of Clay's fertiliser or Standen's manure is given occasionally, which enables the plants to keep the whole of their leaves through the season.

They commence flowering at the end of October, and continue until February, when they are cut down, placed in brisk heat, and they then break and produce young shoots freely for cuttings. The old plants from which cuttings are taken are kept in a cooler house until I am able to plant them out in a frame, and take them up earlier than I house the young plants, and secure earlier flowers, thus prolonging the season. I never keep plants longer two years. The varieties I find most useful are President Garfield, Alfred Neuner, Priory Beauty, President Cleveland, Humboldtii, Corymbiflora, Hogarth, and Vreelandi; although a few more varieties are grown.—R. C. WILLIAMS, *Crosswood Park Gardens, Aberystwith*.

HEATING BY STEAM.

IN the *Journal of Horticulture* of the 16th inst. your correspondent "Omega," asks for information as to this mode of heating. On reading this I at once drew the attention of Mr. John Pope to it, and obtained some information from him which I hope may assist "Omega."

Mr. John Pope, of Messrs. Pope & Sons, King's Norton, near Birmingham, about four years since built a large block of glass houses at Middleton, close to his residence, near King's Norton, and fitted up with hot-water apparatus. During a visit to the United States he was struck with the efficacy of heating by steam at the late Mr. Peter Henderson's nurseries, as referred to by Mr. James Laing in his paper read before our association; and he determined to try steam power as a heating medium in three of the houses in this new block of glass. The houses are from 100 to 120 feet long I think, and that nearest to the boilers is a lofty and wide structure for planted out Camellias and Roses. The boilers are placed in an adjoining shed. Questions put to Mr. Pope brought from him the following replies. To "Omega's" first question, "What is the pressure on pipes and boilers?" Mr. Pope replies, "It depends upon the length of the house. Let us say 100 feet long with 3-inch pipes would require a pressure on the boiler of 25 lbs. to the inch. The supply pipe from the steam boiler need not be more than half an inch or one inch diameter, as the pressure on it is merely nominal, and any ordinary gas piping will do; and the usual make of hot-water pipes of 3 inch or more diameter answers excellently."

To question 2, "Whether a good ordinary hot-water vertical with plenty of room for steam chambers would do?" Mr. Pope says, "It must be a steam boiler, as any ordinary hot-water boiler would not be safe at such high pressure as may be necessary. A good steam boiler will stand a pressure of from 80 lbs. to 100 lbs. to the inch." Then in reply to other inquiries, Mr. Pope adds, "The steam is generated in the steam chamber, and passes through the small pipe from the boiler into

the larger pipes in the houses; and at the end of each range of piping is a steam trap, which allows the air to escape without losing heat or steam; but the water condensed from the steam does not pass back into the boiler, it is collected in small tanks outside, and can be utilised in other ways." Now even so near to the coal district as King's Norton is, firing has been an expensive item this winter, with coal and coke at double the usual prices. Mr. Pope's experience of steam heating is very pronounced, as also is that of his father, that it is the coming heating power of the future in large establishments. The economy in fuel is great, and almost any rubbish can be burned freely. The siftings of cinder heaps, slack, and refuse matter, soon disappear in the steam boiler. There is only one drawback to its use. It necessitates all night attention, but in a large establishment this is a matter of small moment as against the saving in fuel, and the readiness with which heat can be raised and maintained.

But many will ask, What about the internal temperature? Well, I visited the nurseries in the very severe weather fully expecting to find a dry scorching heat, but I did not; all the houses had hot water heat on, but in the three houses in which steam also was used I found a higher but delightful temperature, and plants luxuriating in it. One immense advantage is that houses and plants may be deluged with water at any time, and whilst the floors and beds remain moist the foliage is soon restored to a dry state.

For Orchid culture especially I venture to predict that steam heating will grow very much into favour. Mr. Pope has tried a small experiment with a few knocked about plants of *Dendrobium Wardianum*, which were sent to him for one of his auction sales but did not find a customer. So he bought them himself and used the flowers, and some time after he placed them on a bench over the steam pipes, and the plants are making stronger and more rapid growth than the *Wardianum* in his ordinary Orchid house. He has now removed some of the smaller growing *Dendrobiums* into the steam-heated houses to see the result of so doing. Mr. Pope naively remarked, "It cost me about £70 before I gained the experience I needed." So I recommend "Omega" before starting on steam heating to take a run to Birmingham and see for himself.—W. DEAN.



NEW ROSES—THE FRENCH CONTINGENT—TEAS.

VISITORS to the galleries at Versailles have doubtless been amused, if not indignant, in looking at the pictures painted by French artists of the campaign in the Crimea that a British soldier nowhere appears, and that even in the battle of the Alma, where we held the post of daring and our allies had a comparatively easy time of it, it is only a portion of the field where the French troops were engaged that has occupied the artist's attention. With more excuse the French lists of Roses have had it all to themselves. Now and then an English Rose appeared, but very rarely, and in truth until of late years they were few and far between. Now it is otherwise, and although our battalions bear no sort of proportion to those of our neighbours it is a pleasant thing to find English raised Roses appearing in the French lists—as pleasant as if the French artist had introduced a few of our soldiers in his picture of the heights of Alma or the storming of Sebastopol.

I have been assisted by Messrs. Ketten of Luxembourg, whose collection of Roses must be the most complete in existence, as their catalogue certainly is with the best of the new Roses of 1890-91, and they have supplied the want which I find in the Paris list which I have generally used—viz., the names of the raisers of the new varieties. The reason of the omission in the Paris lists I cannot understand, unless it was that finding English growers were considerably influenced by the names, looking hopefully at those which once sent out good Roses before, and askance at those from whom we have received only indifferent flowers; but so it is, and we are thankful to the provincial grower for supplying what his metropolitan *confrère* has omitted.

There are, as usual, a number of Roses of various classes, such as dwarf Polyantha, Bourbon, Hungarian Roses, and Hybrid Roses; but I confine my observations to the three most popular classes with us—Teas, Hybrid Perpetuals, and Noisettes, the latter indeed merging into the Teas until the difference is almost imperceptible. Of these classes we have announced thirty-one Teas and Noisettes, and twenty-two Hybrid Perpetuals, showing again that as they find the class of Teas most popular they have devoted their attention to these, but whether we shall ever gain in the future such Roses as we have had in the past is very questionable. With regard to this class, which I take first, I am afraid that we shall have, after the experience of the past winter, to modify our statements as to their being as hardy as the H.P.'s, for in most places they have suffered severely. The best way will, I think, be to take them under the raisers' names, beginning with the most prolific contributor to our list.

NABONNAND.

Général de Mertchansky.—Flesh rose of a very bright and lovely tint; flowers large, full, and erect; bud very long and pointed, opening itself well. This sounds promising.

Jaune Nabonnand.—Colour chrome yellow, tinted with deeper shade, and with a slight shade of copper; flowers large and full; bud very pointed, opening well.

La Chanson.—Showy carmine rose, shaded with deeper tints, golden, erect very large and full, seedling from Isabelle Nabonnand and Général Schlabling. The description ends with the thoroughly French announcement, dedicated to Gustave Nadaud, the eminent author.

Mammie Rossier.—Tender rose, lightly veined with red, the outside of the petals paler, large, full long-pointed bud, opening well. Dedicated to the Minister of Finance.

Princess Marguerite d'Orleans.—Delicate pale rose, exterior of petals lovely carmine, large, full, pointed bud; stem firm. Said to be a new colour, seedling from Isabelle Nabonnand.

SOUPERT AND NOTTING.

We have never gained much from this very persevering firm, which still endeavours to win the favour of the Rose-growing world, but with little success; for although for thirty years or more they have sent out their Roses I do not see in the N.R.S. Catalogue one of theirs, either in Teas or Hybrid Perpetuals. Again they are in the field with glowing descriptions, but we may be permitted to doubt whether we are likely to gain much from them. They are five in number.

Charles de François.—Chrome yellow, shaded with salmon yellow, outside petals slightly tinted with rose, not flowering in clusters; a cross between Sylphide and Madame Croucher.

Comtesse Eva Hartenberg.—Creamy yellow, outside petals slightly bordered with rose, pointed bud, opens well; a cross between Etendard de Jeanne d'Arc and Sylphide, and therefore, I should imagine, having somewhat of the Dijon character.

Comtesse de Vitzthum.—Clear Naples yellow, very vigorous; a cross between Adèle Jouvant and Perle des Jardins.

Gabrielle Nicola.—Silvery white, the base of the petals rosy flesh colour, shape of Souvenir de la Malmaison; a cross between Bouquet d'Or and Sylphide, doubtless another of Dijon character.

Princesse de Sarsiva.—Clear yellow, shaded with bright rose outside of petals; a cross between Madame Lambard and Solfaterre.

GUILLOT.

Christine de Noiré.—Purplish rose shaded with maroon; outside of petals clear purple shaded with silvery white; flowers, large, imbricated, very floriferous. By way of enhancing its merits we are informed that it is dedicated to the daughter of a general. Surely of all raisers of Teas Guillot has no need of such a queer way of recommending his Rose, but I suppose it is "the way they do things in France."

PRIES AND KETTEN.

Amanda Cassado.—A Rose of a very remarkable colour, difficult to describe; yellowish-coppery-rose; the outside petals rose, sometimes tinted with rosy white, flowers medium size.

Marie Scholtz.—Colour deep shaded rose, centre brick red, vigorous and free-flowering.

GODARD.

Antoinette Dorien.—Shaded chrome yellow, passing into pale yellow, moderately full.

Madame Creux.—Salmon rose with light bronzy reflex on outside of petals, opening well, large and full.

Miss Wenn.—Colour of a China Rose, large and full, very vigorous.

DUBREUIL.

Blanche de Force.—Chrome yellow reflexed with pale yellow, outside of petals lightly tinted with rose; flowers full and imbricated; bud egg-shaped. Dedicated to the daughter of an amateur of Roses in the Loire.

CHARLES VERDIER.

Souvenir de Lady Ashburton.—Flowers very variable, coppery red with salmon yellow, sometimes brown, sometimes brilliant yellow, clear yellow prevailing; all these shades, sometimes separately, sometimes mingled, according to the condition of flowering, a sort of vegetable Chameleon.

REBOUL.

Dr. Dassellet.—Flowers salmon red, centre salmon rose, tips of petals clear yellow, outside dark rose, large full; dwarf habit, nearly thornless, very free flowering.

Jenny Danzae.—Flowers canary yellow, fimbriated, petals outside white, very free, opening well; tree vigorous and very free flowering. Dedicated to the wife of the President of the Horticultural Society of Marseilles.

BONNAIRE.

Eliza Fugier.—Flower pure white, centre slightly streaked with clear yellow, very large, very full; bud very long; tree very hardy. Very much in the style of Niphotos, from which it is raised.

Souvenir de Madame Sablyrolles.—Flower apricot rose shaded with yellow, petals shaded with carmine passing on to creamy white, large, full, and globular, does not flower in clusters; new colour. A seedling Devoniensis and Elise Vardon.

TESNIER.

Etoile d'Angers.—Flower, ground colour yellow coppery, largely edged with red, reflexed with bronzy pearly red, large, full globular; bud long; stalk firm; new colour.

Madame Dorgèse.—Flower clear flesh colour, shaded with tender rose, sometimes with salmon; large full, globular; bud oval; stalk long and firm, very vigorous. A cross between Syphide and Catherine Mermet. Dedicated to a distinguished florist in Angiers.

MOREAU ROBERT.

This is another firm from which we have not received anything of any real value. They offer now

Madame Durand.—Flowers dark coppery yellow, large, full, and globular, opening well; tree very vigorous, flowering in clusters; very free.

Madame Simon.—Flower rosy white, lightly shaded with yellow, in places very large and full; form and colour of Souvenir de la Malmaison; very vigorous and free, a seedling from Madame Berard.

ELIE LAMBERT.

Madame Elie Lambert.—Flesh coloured rose, outside of petals pure white; medium size; form globular.

CORBŒUF.

Madame Delaroche.—Flower carmine rose, large, very full; a seedling from Mathilde Leonart.

BERNAIX.

Princess de Bassaraba.—Flowers very variable in colour, fresh carmine colour, shading off to flesh on the outside, and shading off to canary yellow on opening; not quite full.

PERRIER.

Professeur Gamviat.—Dark velvety red, lighter than Souvenir de Thérèse Levet; large, full; firm stalk. Dedicated to a professor of the School of La Matinasse at Lyons.

EUGÈNE VERDIER.

Souvenir de Clairvaux.—Crimson rose colour, bright; base of petals apricot yellow, shaded with nankeen, and tinted with carmine. A very sweet-scented Rose. Read this, ye John Bulls; dedicated in remembrance of the stay of the Duke of Orleans in the prison of Clairvaux for having come to France to submit himself to the law of recruiting.

There are a few others in Mons. E. Verdier's list, but as he does not give the names of the raisers I omit them.—D., Deal.

HORTICULTURE IN AMERICA.

[A paper by Mr. JAMES H. LAING, F.R.H.S., read at the Birmingham Gardeners' Association, March 9th, 1891.]

(Concluded from page 302.)

THE following flowers are in great demand in the States:—The Carnation has taken quite a hold, and to be valuable a Carnation must produce its flowers on single stems, so that they can be cut long. The flowers must be distinct in colour, large and full in form, and not inclined to burst at the calyx. The Violet is popular, and the only variety which is generally saleable is the Marie Louise, and this is subject to a disease which has baffled the most experienced Violet growers, and forced many to give up its culture. The result is that those whose plants have escaped the scourge have reaped a profitable return during the past few years. Single Violets are most popular in Philadelphia. After these the flowers most extensively grown for the market are Orchids, Bouvardias, Lily of the Valley, Roman Hyacinths, Tulips, Daffodils, and Lilies of several kinds. Other flowers regularly quoted in the wholesale market are Narcissi of several kinds, Freesias, Bouvardias, Mignonette, Callas, Camellias, Myosotis, Lilaes, Pausies, Smilax, and Ferns; also some kinds whose sale is limited to certain seasons, such as Sweet Peas, Asters, Chrysanthemums, Gladioli, Cannas, and Tritonias. I have omitted to mention that the Smilax, which is largely used by the florists for festooning, and is cut in strings. It is grown in beds or benches from seed, and is a rapid grower. It is trailed or tied upright in cool houses. It is a grand sight to see the several varieties of Sunflowers; the Golden Rod (*Solidago*), Trilliums, Orchis, and many other of our good saleable plants growing wild and flowering to profusion in the woods and fields.

The New York *World*, after alluding to the medal recently given by the *California Florist* to the first nominee of the Sunflower as our national emblem, quotes the *Florist's* reasons for adopting it, and acquiesces in these words:—"Therefore the big Sunflower will stand as the emblem of the American Republic beside the Lily of France, the Rose of England, the Thistle of Scotland, and the Shamrock of Ireland. Hurrah for the big Sunflower!" I saw several splendid plants of *Hydrangea paniculata grandiflora* with gigantic flower spikes, growing and flowering splendidly around Boston. Respecting the American fruits the following I have noted:—"With 5,000,000 acres under orchards in the States the production of food is necessarily large. With an average export of over 1,000,000 bushels of green fruit, and an equally large home consumption, there still remains a large surplus of American Apples to be utilised." The chief sorts grown are Baldwin, Greening, Ben Davis, Northern Spy, New Town Pippin, Wine Sap, &c. Bananas, Peaches, Pears, Grapes (which are of a very fussy flavour), Quinces, Lemons, Musk and Water Melons (largely used in hot weather), and Cranberries.

Chrysanthemums, according to repeated statements given me, are

flowered in perfection. Unfortunately I had not the pleasure of seeing them in bloom. I append some notes regarding the propagation and care of the plants by Mr. John Smith Bayside:—"Cuttings were put in from the beginning of April until the first week in May, and when potted the earliest cuttings were stopped once before planting out. On the 3rd of June they were planted out in the benches, which were filled to the depth of 4 inches, with a compost of two-thirds decayed turves, one-third decayed manure, and a small portion of bone flour. They were planted at a distance of 12 inches each way. When they commenced to grow they were all stopped, and during the growing season all weak shoots were taken off, and only those calculated to produce fine flowers left. As soon as the buds could be seen the plants were supplied liberally with manure water. In disbudding we seldom leave more than one bud to a shoot, the object being to get fine flowers. To support the plants we use strong twine instead of sticks, fastened to wires across the benches and others overhead."

As Tomatoes form such an important part of the American trade, perhaps these few words of a leading nurseryman will not be out of place:—"My experience in growing Tomatoes has been that the earliest fruit is obtained on light soil with but little manure; the crop will be less and sooner over, although the first few pickings for market may bring a price that will overbalance the larger crop which may be raised on heavily and highly manured soil. The results of the experiment are as follows:—All the plants were put out on the same day, the 9th of May. The ground was slightly rolling, a sandy loam, one with sandy depression, and one with quite heavy loam. The sandy depression seemed to force the fruit, and the latter to retard the ripening. Our past summer was one of successive rains, and the temperature was below the average. August was mostly dry and rather hot. That seemed to spoil many varieties. September 10th was opened with a five-days rain and very high winds, blowing the plants about and whipping the leaves almost off some of them. The day before the rain a small box of each kind was secured and placed on shelves to try their staying qualities. It is certain that with drier weather different results would have been shown. To determine the longest time fruit would keep I should pick green fruit earlier in the season, but fruit of each lot, in this case, was as nearly alike in all respects as could be had. It is a noteworthy fact that all of the purple or Acme colour were the first to rot." These are the sorts chiefly grown for family use:—Ignotum, Horsford's Prelude, Station. Market, Red:—Ignotum, Volunteer, Livingston's Favourite, Matchless, New Jersey, Paragon, Lorillard, Finch's Essex Hybrid. Purple: Acme, Turner's Hybrid, Livingston's Potato Leaf, Livingston's Beauty, Climax. Yellow: Golden Trophy, Golden Queen.

The chief vegetables for the kitchen are the following, recommended by a practical gardener:—Beans: Snap, Mohawk, and Valentine; Pole, red-flowering Scarlet Runners for their blossoms; Lima, for shelled beans, Dree's Improved. Beets: Eclipse and Long Smooth Blood. Cabbage: Early Jersey Wakefield, Early Summer, and Drumhead Savoy. Cauliflower: the various strains of Erfurt. Carrots: Early Scarlet Horn, Half Long Stump-rooted. Celery: White Plume, Golden Heart, London Red. Cucumbers: Nicolls' and Tailby's. Corn: Cory, Concord, Stowell. Egg Plant: New York Improved. Lettuce: Boston Market, Salamander. Mushrooms: English Grey. Onions: Yellow Danvers, Large Red Weathersfield, and Southport White Globe. Peas: Improved Daniel O'Rourke, Alpha, Champion of England, Bliss's Abundance. Potatoes: Puritan, Main Rose, and Hebron, Magnums Canadian, and several others. Radishes: French Breakfast, Scarlet Turnip, and of the Long-rooted, Wood's Early Frame. Rhubarb: Monarch, Victoria. Squash: Bush Summer Crook Neck, Pincapple, Hubbard. Tomatoes: Acme, Trophy. Turnips: Red-top, Strap Leaf, Purple-top, White Globe.

I think the following few remarks as to gardeners in America, written by my friend Mr. C. L. Allen, should conclude this lengthy paper. The situation in America is simply this. If an experienced gardener, a man worthy the name, comes here and gets a situation, and at the same time is determined to please his employer in all ways, he will very soon get £10 to £20 per month, and a good house to live in. Many of our most successful florists came here with this intention; they did as men should do, and the result in many cases was that the owner of the place said, "Here, John, I will put up a range of houses for you if you like; I will furnish the bullion and you the brains, and we will divide the profits." I have an intimate friend in an English gardener who started in just this manner, and who is now worth £20,000, which he has made within the last fifteen years, and there are many others I could name who are on the same road to success. In conclusion, let me say to the gardener who starts out for America, Leave caste or rank at home; do not think because you rate A1 at home that you will there rank higher than he who cannot pot a plant. Your ability will be fully appreciated, but that alone will not meet with success. You must be a man as well as a gardener—then success awaits you, and it is here considered a better indication for a man to spend his evenings at home rather than at the beer-shop. To this I will add, "Emigration is, indeed, a necessity to the British farmer and gardener. It is practically useless, however, sending a gardener abroad who has failed through lack of energy at home, for in emigrating to the United States of America it must be borne in mind that they have, so far as the States on the Atlantic seaboard and the great northern and central cities or seats of trade and commerce are concerned, to compete with a people fully equal to their own in all essential qualities, and with the advantage of being more adaptable, more inventive, more eager to get on, and less under the influence of routine and prejudice."



EVENTS OF THE WEEK.—The Royal Society meets to-day (Thursday) at 4.30 P.M., the Royal Botanic Society on Saturday, April 25th, at 4 P.M., and the Society of Arts at 8 P.M. on Wednesday, April 29th. Sales will be held as usual at King Street, Covent Garden, and Cheapside, both of bulbs and Orchids.

— **THE WEATHER IN THE METROPOLITAN DISTRICT** has not yet given general satisfaction, for the brighter days have been attended by keen north-easterly winds, very trying alike to vegetation and human beings. Frost, too, has been experienced in some low positions, and 5° to 7° registered, quite sufficient to be dangerous to early fruit tree buds.

— **GARDENING APPOINTMENT.**—Mr. John Heeremans, late foreman at the Friary Gardens, Old Windsor, has been appointed head gardener to W. Pethick, Esq., J.P., Woodside, Stoke Bishop, Bristol.

— **OMPHALODES VERNA** is extremely pretty now in a warm nook in the rockery. Its rich blue flowers with a white eye render it very distinct. Certainly it deserves more extended cultivation than it receives as a rockery and border plant. By dividing the creeping roots and stems a quantity can soon be had.—M.

— “**OMEGA**” in last issue inquires where he can obtain particulars of the method of **HEATING BY STEAM**. From circulars and plans I have received he will, I have no doubt, be able to get all information from Mr. John M. Newton, the Managing Engineer of the Manchester Heating Company, Manchester and Stalybridge.—R. IRWIN LYNCH.

— **STACHYS TUBERIFERA** is slowly making its way into favour. Many have tried it as an addition at the dinner table, and speak well of it, and I know several gardeners who are planting it extensively. Any one at all sceptical as to its usefulness may soon settle the matter by having some tubers well scoured and cleaned. Boil them for ten minutes, and then cook them as you would whitebait, or fry in butter, using bread crumbs at pleasure. It has a pleasant Jerusalem Artichoke kind of flavour.—D. S.

— **THE WEATHER IN PARIS** appears to be much more spring-like than in London, for a correspondent writes to a daily paper in these terms:—“For the past three weeks the peasant proprietors, agriculturists, and nurserymen in the rural environs of Paris have been bemoaning bitterly the lateness of the spring. The Vines which furnish the tart beverages of Suresnes and Argenteuil, immortalised by Paul de Kock and song writers innumerable, have been in a languishing condition, and *petit-bleu* threatens to be scarce and dear this season. The cultivators of the countryside about Mont Valérien and Buzenval will have barely enough wine for themselves, and whoever cares to call for *vin de Suresnes*—which is not a remarkably generous drink at the best of times—in the city restaurants out of curiosity during the summer will undoubtedly be offered a sham and spurious concoction, fabricated in the Bercy riverside *dépôt*. So far the long winter and the cold spring have done irretrievable damage. The farmers and florists, however, are beginning to pick up courage. After a fortnight of exceptionally bitter weather for the time of the year the rural districts—like the city itself—are bathed in warm and invigorating sunshine. We seem to have entered suddenly into some region of ‘cloudless climes and starry skies,’ for the nights, as well as the days, are calm, clear, and mild. Plants and flowers are thriving, as if to make up for lost time, and there will be soon a wealth of bloom and verdure all over Paris. The *Premier bouquet de Lilas*, sung by local poets so often, has come already, and only this morning loads of fragrant blossoms arrived in the Halles-Centrales, and were bought up speedily by florists, who will soon get rid of them at a profit, for in hardly any other European capital are the first flowers of spring so welcome as in this city, where rich and poor alike enjoy them while they last. Everything, in fact, denotes that spring, so long delayed, has come at last, and Paris has assumed that aspect of genuine gaiety which will continue until the midsummer heats begin to render the asphaltic intolerable.”

— **LIVERPOOL SHOW.**—We are informed that the first prizes in classes for three Palms or Cycads and one Palm or Cycad were awarded to Mr. T. Healey, gardener to Colonel Wilson, Hillside, Allerton, and not to Mr. T. Wilson as stated last week.

— **CLIVIAS** are fast taking a high place as useful and popular plants, and to this result Messrs. J. Laing & Sons, Forest Hill, may claim to have contributed in no small measure. In the Stanstead Park Nurseries at the present time these plants constitute an exhibition of great beauty, and the range of variation now secured is astonishing as compared with a very few years since. Tuberos Begonias are also advancing rapidly. The stock is this year even larger than ever, and the meaning is that all who have visited this nursery in Begonia time will fully understand.

— **HIPPEASTRUMS AT MESSRS. J. VEITCH & SONS' NURSERY, CHELSEA**, are just now in grand condition and provide a display that is worth a long journey to see. The plants are strong, the scapes numbered by hundreds, the flowers large and the colours brilliant, but with sufficient light and delicate tints to effectually remove all tendency to monotony. In addition to the fine varieties which have received certificates in recent years many seedlings are flowering for the first time, and present distinctive characters of much interest. In other departments the floral attractions are also abundant at the present time.

— **WE** are informed that **MR. WILLIAM BARRON** of the Elvaston Nurseries, Borrowash, Derby, died on the 8th inst. in his eighty-sixth year, and many of the older horticulturists will hear the news with the deepest regret. Mr. Barron had gained considerable reputation as a landscape gardener, and possessed a wide knowledge of trees and shrubs which he utilised to good purpose in his business. After serving as gardener at Elvaston Castle for some time he left and formed his nursery at Borrowash, which is well known to all interested in arboriculture. Tree moving was successfully performed on several occasions, but that which attracted most attention was removing the old Yew in Buckland Churchyard, near Dover.

— **HAYWARDS HEATH HORTICULTURAL SOCIETY.**—The schedule of this Society has just come to hand. In addition to their usual summer Show on the 29th July, at which prizes to the amount of £130 are offered, the Committee has this year arranged to have a spring show, to be held in the Public Hall, South Road, on April 28th and 29th. This, we believe, is the only serious attempt at a spring show in the county. Its position is central and convenient, may it prove such a success as to warrant its continuance.—R.

— **BOTHWELL BANK AND PRESIDENT STRAWBERRIES.**—Dr. Livingstone Strawberry was at one time grown at Bothwell Bank, and in some respects resembles President, but answers the description given by Mr. J. Doughty, Angley Park, Cranbrook, to a great degree. Many plants get a new name from the place where they are grown, which creates confusion, and ought to be guarded against, especially by gardeners. I am inclined to believe Bothwell Bank is none other than Dr. Livingstone, or perhaps Admiral Dundas.—W. T.

— **PHYLLANTHUS NIVOSUS.**—This is a distinct and beautiful plant of slender habit, and when well coloured the leaves in many instances are quite white; others have a few green spots at irregular intervals, while the young leaves at the point of each shoot have a very attractive magenta tinge. As may be supposed from the above description, this Phyllanthus is capital for arranging in groups or for dinner-table embellishment. Good sized plants of various heights can be grown in 3, 4, and 5-inch pots. When well rooted they must receive plentiful supplies of water, and be kept near the glass in a stove or intermediate temperature, in positions where they have a good amount of sunshine. Two parts loam to one of leaf soil and some sharp sand added is a compost in which they grow and colour splendidly. Young plants are easily raised, either from cuttings or leaves; the latter, if detached from the shoot with the axil of the leaf, and inserted in sandy soil, placed under a handlight where there is good bottom heat, will root as freely as cuttings, and grow into capital plants for use in 3-inch pots the first season. Cut-back plants form bushy specimens for filling vases. This plant was generally very telling in the beautiful groups put up in recent years at the West of England shows by Mr. Lock, and without doubt much of the success achieved by this well-known exhibitor when competing for the prizes offered for groups of plants arranged for effect was due to the admirable selection of plants and Ferns he prepared for the purpose, and which he knew so well how to arrange to advantage.—H. DUNKIN.

— THE WAKEFIELD PAXTON SOCIETY.—The annual dinner of this flourishing Society was held in the Paxton room, Sun Hotel, Wakefield, on the 15th inst. The large and beautifully decorated room was crowded to overflowing. Wakefield, one of the oldest of towns and newest of cities, contains about 40,000 inhabitants, yet the Society numbers 284 members. It is distinctly educational in its aims, and is supported by the municipality and influential persons. No less than forty-seven papers and essays were read during the past year. The Society encourages window gardening in the town, and originated the movement for a public park shortly to be commenced. Major Taylor, J.P., is the President of the Society, and ably presided at the meeting. He was supported by the Mayor, Mr. J. Haslegrave, Alderman Watson, ex-Mayor, and other gentlemen. Mr. Wright, of the *Journal of Horticulture*, was asked to propose "Success to the Paxton Society," and in doing so referred to the great and growing demand for flowers in towns. He instanced the expenditure of £30,000 by Mr. Whiteley, the universal provider, in establishing another fruit and flower farm near London, for meeting the demands of his customers; and Mr. Whiteley's brother, who was present at the meeting, confirmed the statement. Mr. Wright also gave what he called another "striking and sad" example of the attractive force of flowers—namely, the dense crowd of people flocking into the wholesale market, Covent Garden, on the morning following the Gardeners' Orphan Fund Fête, and stopping business, so that the show had to be discontinued, the Fund sustain loss, and needy children remain unprovided for. He also referred to the value of the library of the Paxton Society, and its assistance to members in the preparation of essays. The ex-Mayor, a gentleman of wealth and benevolent instincts, made a practical response. He asked Mr. Wright to buy £10 worth of books for the library, and accept £10 for the Orphan Fund, which would be repeated annually, and the Alderman also sent £5 4s., being 2s. a week for the year, to Mrs. Preston, the widow of a gardener in the neighbourhood, one of whose children is in receipt of 5s. a week from the fund. Another circumstance worthy of record in connection with this gentleman, Alderman Benjamin Watson, J.P., is placing £1 a year in the bank for children who are given his Christian name, to accumulate till they are twenty-one years of age, and there are no less than 120 "Benjamins" in the city who will have something to start in life with on attaining their majority, for the sum given by their benefactor has incited habits of thrift, and is in many instances added to materially by the parents of the boys. Mr. Watson's gift to the boys of Wakefield represents a sum of upwards of £2500, and is probably unique. Several other gentlemen of the city and delegates from different societies ably addressed the meeting; also talented vocalists contributed to render it in the highest degree enjoyable. It was in all respects a complete success and a credit to the old town and new city in which it was held.

— THREE GOOD PEAS.—Three varieties which I consider especially good are Fortyfold, Duke of Albany, and Duchess. I have grown the former every season for the last thirteen years, and I see no reason now to discard it. I have also recommended it to scores of people, and especially those with limited space, and I find they are all equally in favour of it. No weather seems to affect its growth adversely. Last year it grew over 8 feet high, but the haulm had an even better crop than usual, as there were more pods than if it had only reached its acknowledged height 5 feet: with us it always grows 6 feet. The pods are not so long as some other sorts, but the peas are of large size, and the flavour cannot be surpassed. We grow it as one of the second-crop sorts, as well as for the main crop. Duke of Albany is the second of the trio. If I were asked to name one Pea the most suitable for all purposes I should vote for the Duke. The advantage it possesses over Fortyfold is that the pods are longer, and they always fill well, while the flavour is excellent. We sow the seed in small pots, three or four peas in each; they are then placed in a late vinery, are afterwards shifted into 5½-inch pots, and grown in a cool house until the haulm is 4 inches high. The plants are then transferred to a cold frame for a time until a favourable opportunity can be found to plant them out in a trench, the soil of which is thrown out on each side about 9 inches high, thus keeping the cold wind from the Peas. A sunny spot is chosen in the garden. Plenty of space is allowed between the plants; the stakes are placed to them at once, and some evergreen branches on the north and east sides of the row for protection from strong winds. The surface is mulched with the materials of a spent Mushroom bed, and by the middle and end of June we are enabled to gather fine samples of tender Peas. Duchess is the last of the three which I recommend. As a main crop variety it is unsurpassed in robust growth, freedom in cropping, and flavour.—A KITCHEN GARDENER.

— HORTICULTURAL CLUB.—The usual monthly dinner and conversation took place on Tuesday last, and was one of the largest and most successful meetings that has been held. The chair was occupied by the Rev. W. Wilks, in the absence of the Chairman and Vice-Chairman of the Club. Mr. F. W. Moore of Glasnevin, the Chevalier Van Pulford, Herr de Graaf, and Herr Drassen, were the invited guests, and the following were present:—Dr. Hogg, Messrs. Crowley, Castle, Cousens, Bunyard, Walker, Lauder, Ashby, Wheeler, H. J. Pearson, Charles E. Pearson, Herbert S. Adams, F. Sander, Cockett, Druery, Martin, J. Smith, Geo. Prince, A. Prince, and the Secretary. An interesting paper was read by Mr. Lewis Castle on "Cool House Orchids," which was followed by considerable discussion, and at the conclusion the Chairman moved a hearty vote of thanks to the reader.

— THE gardeners of North Notts have set a good example. In November, 1889, they got up a concert in aid of the GARDENERS' ORPHAN FUND, which was a great success, and during the past winter one of their members died very suddenly (Mr. W. Wasley, late gardener Blyth Hall, Worksop, Notts), leaving four orphan children, and as there was no election this year it occurred to Mr. Henderson (gardener, Thoresby) and Mr. J. Mallender (gardener, Hodsock Priory) to appeal to the gardeners of the district and other friends for immediate help. Their appeal has secured the sympathy of many kind friends, and the amount collected is £28, which is being paid at the rate of 5s. per week to each of the guardians of the two youngest children. Messrs. Henderson and Mallender hope to be able next February to have one or both of the little orphans elected.

— ROYAL METEOROLOGICAL SOCIETY.—The usual monthly meeting of this Society was held on Wednesday evening, the 15th instant, at the Institution of Civil Engineers, 25, Great George Street, Westminster, Mr. A. Brewin (Vice-President) in the chair. Mr. J. Baxendell, Mr. H. Champ, and Mr. S. H. Ridge, B.A., F.R.G.S., were elected Fellows of the Society. The following papers were read:—1, "Some Remarkable Features in the Winter of 1890-91," by Mr. F. J. Brodie, F.R.Met.Soc. The author points out the peculiarities or special features of interest in the weather which prevailed over the British Isles during the past winter. In addition to the prolonged frost, which lasted from the close of November to about January 22nd, he finds that the barometric pressure for the whole winter was about a quarter of an inch above the average, and that when the wind was not absolutely calm there was an undue prevalence of breezes from some cold quarter. The percentage of winds from the southward did not amount to one-half of the average. The number of foggy days in London was no less than twice the average. The rainfall over the greater part of the British Isles was less than half the average. The author says that "almost every element in the weather has been influenced to an abnormal degree by the remarkable prevalence of high barometrical pressure, and if we were called upon to define the season 1890-91 we should have little hesitation in giving it the name of the 'anticyclonic' winter." 2, "The Rainfall of February, 1891," by Mr. H. S. Wallis, F.R.Met.Soc. This was one of the driest months upon record, the mean rainfall over England, excluding the Lake District, being only 0.066 inch, or about one-fortieth of the average. 3, "On the Variations of the Rainfall at Cherra Poonjee in the Khasi Hills, Assam," by Mr. H. F. Blanford, F.R.S. Cherra Poonjee has long been notorious as having a heavier rainfall than any other known place on the globe, the mean annual fall being frequently given as about 600 inches. Mr. Blanford has made a critical examination of the various records of rainfall kept at this place, and has come to the conclusion that the above amount is too high, and that the average annual rainfall is probably only a little over 500 inches.

BOMBAY GARDENS.

(Concluded from page 304.)

THOUGH I am conscious of a great many omissions among characteristic trees, some of which, however, are intended, because those particular trees grow to far greater perfection elsewhere in India, it will be still more difficult to point out the most characteristic shrubs without omitting a great many. Among these none are, or at the least were, more common than *Codiaeums* or *Crotons*, the beauty and often curious shape of whose brilliantly coloured foliage needs no comment, while it is well known that they succeed admirably here, and that more than a hundred varieties are found in our gardens. They are, however, nowadays partly giving way to quicker growing and, in certain respects, more effective shrubs, as the brilliantly coloured *Acalyphas*, the leaves of which vary in colour from the most brilliant metallic blood-red to

the purest yellowish green, while their shape and size offer great variety, and one kind is distinguished by its long drooping blood-red flower spikes. Among the *Frantlemums* we have similar variations—golden greyish, violet, pinkish flaked and dark purple narrow or broad, metallic shining leaves, while the many varieties of *Graptophyllums*, with broadly light or dark blotched leaves, are valuable additions to the great number of variegated shrubs, among which perhaps few are more useful, though less striking in colour, than the white-blotched *Aralia Guilfoylei*, or none more elegant and graceful than the finely feather-leaved *Panax Victoria*, or the Snow Shrub, *Phyllanthus nivosus*, which forms a beautiful contrast to its dark purple coloured congener, *Phyllanthus atropurpureus*, the effect of which is, however, far surpassed by its ally, *Exoecaria bicolor*. Among flowering shrubs none are more effective than the brilliantly coloured *Poinsettias*, of which several varieties occur, while for variety of colour, size, and beauty of the individual flowers, the numerous varieties of *Shoc-flowers* (*Hibiscus*) have no rivals. The *Cœsalpinea*s are most of the year covered with their large clusters of brilliant orange or pure yellow flowers, and the charm of our pure white-flowered or pale lilac *Durantas* can hardly be rivalled, while the masses of gigantic bell-shaped white flowers of *Datura suaveolens* are well worth admiration. The coral-stalked flowers of *Jatrophas*, the yellow flowered *Allamandas*, *Tecomas* and *Thevetia nerifolia* and the scarlet *Tecoma capensis*, the snowy white *Tabernæmontanas*, and the Almond-scented *Gardenia* (*G. lucida*) are along with the well-known crimson, pink or white *Oleanders* frequent inhabitants of our gardens, and assist with a great number of other flowering shrubs, among which perhaps the different kinds of the very popular *Jessamines*, the brilliantly coloured *Ixoras*, the white-bracted *Mussaendas*, and numerous kinds of *Clerodendrons* deserve to be mentioned in yielding a continual supply of choice flowers.

Among foliage plants other than Palms the many varieties of *Alocasias* with their gigantic leaves are perhaps the most effective, but a pleasing variety is afforded by the many often brilliantly coloured *Dracenas* by the curiously blotched *Dicffenbachias*, by the picturesque and handsome flowered *Heliconias*, *Alpinias*, *Hedychiums*, and *Cannas*, of which at present most magnificently flowered varieties may be met with in Bombay. Several hardy varieties of *Caladiums* with brilliantly blotched and dotted leaves, the well known *Coleus*, and the splendid varieties of *Amaranthus tricolor* and *A. sanguineus* deserve to be mentioned as very effective. Cactaceous plants are rare in Bombay. The wonderfully large white flowers of *Cereus triangularis* are worth sitting up for at night, the only time they expand. Some Cactus-like *Euphorbias*, several *Agaves*, *Yuccas*, and similar plants are fairly common. The selection of herbaceous plants in the open ground is more restricted and almost limited to bulbous and tuberous plants, among which the *Eucharis*, *Crinum*, *Pancratiums*, *Hymenocallis* seem perfectly at home in Bombay, and the splendid varieties of *Hippeastrums* are gradually associating themselves to the fire-coloured *H. equestre*, an old favourite of Bombay gardens. The beautiful white or pink *Zephyranthes* remind us by the shape of their flowers of our homely *Crocus*. Single *Dahlias*, *Chrysanthemums* are friends from home, which are gradually improving and gaining ground in Bombay, while *Achimenes* succeed fairly well, and nothing is more graceful perhaps than the scarlet-flowered *Rusellias*.

Of ornamental Grasses a few are very effective, as the white-variegated *Arundo versicolor*, while the ordinary *Arundo Donax*, when having sufficient room is very picturesque, especially when in flower, the Moonj Grass's (*Saccarum Sara*) is not a bad substitute for the Pampas Grass, and the striking foliage and graceful flower spikes of *Thysanolana acarifera* are very attractive. For table decorations nothing can be more useful than the copper coloured graceful flower spikes of the lately introduced *Tricholœna rosea*. *Panicum sulcatum* and *P. plicatum* are effective plants when grown in masses, and *Oplismenus imbicilis* fol. var. (*Panicum variegatum*) with white and pinkish tinted leaves, a most useful and common plant for covering bare ground. Bamboos are not very common in Bombay, and succeed perhaps better elsewhere. Perhaps nothing adds more to the peculiar beauty of the Bombay gardens than the luxuriance which several hardy Ferns display in open ground, often even when fully exposed to the sun. Of those the different kinds of *Nephrolepis* are the most graceful, while the light coloured *Polypodium irioides*, and the dark glossy *P. phymatodes* are very effective, each in their peculiar way.

The flower beds are generally adorned with annuals, among which *Zinnias*, *Balsams*, the small flowered *Sunflower* (*Helianthus cucumerifolius*), *Gallardias*, *Coreopsis*, and *Cockscombs* may be met with at different seasons of the year, but arrive to the greatest perfection during the rains. In the cold weather our flower beds can be kept more gay by annuals, such as *Phlox*, *Poppies*, *Nasturtium*, *Chinese Pinks*, *Portulaccas*, *Pansies*, *Verbenas*, *China Aster*, *Petunias*, &c., which often under favourable circumstances succeed admirably. In many cases it is a surprise and disappointment to new comers to India to see our flower beds embellished with plants familiar to us from home; and in truth it is to be regretted that so very few plants of less ordinary character have found their way to our gardens, and as a step in the right direction it must be appreciated that such plants as the *Zanzibar Balsam*, *Impatiens Sultani*, with its beautiful crimson flowers, and the *Neilgherry Violet*, *Torenia Fournieri*, to which a yellow flowered kind, *T. Bailloni*, has now been added, and a white-flowered variety (*White Wings*) may be expected to flower in this cold season, are rapidly gaining ground in our gardens. Edging plants are rather an important feature of Bombay gardens, and the old-fashioned *Justicia gendarussa* is now almost every-

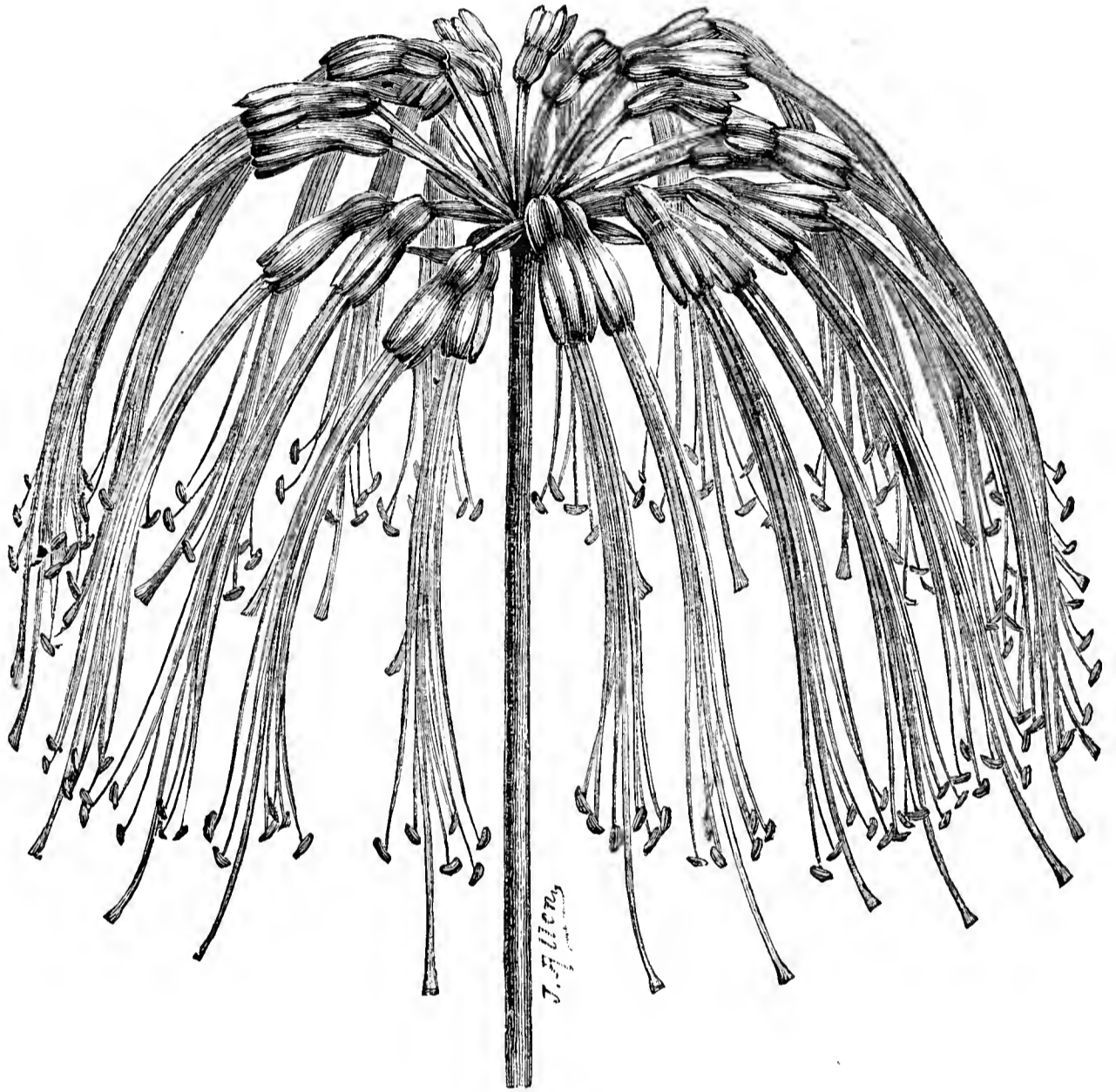

FIG. 60.—CALLIPSYCHE MIRABILIS.

where replaced by other plants, such as the Moss-like *Pilea muscosa*, the neat dwarf *Coleus*, which when covered with its beautiful sky-blue flowers is very attractive; the Australian Daisy (*Vittadenia australis*), the bright green *Stonecrop* (*Sedum sarmentosum*), the hairy crimson flowered *Purslane* (*Portulaca pilosa*), the dark olive-green, and in Bombay rarely variegated *Alternantheras*, the dark purple *Aerua sanguinolenta*, the metallic grey and purplish *Hemigraphis colorata*, the silvery *Tradescantia zebrina*, and several others. I have now, I believe, mentioned the most important and peculiar plants grown in Bombay gardens, and must defer a peep into the Bombay ferneries to a future occasion.

CALLIPSYCHE MIRABILIS.

EARLY in the present year the plant of which a flower scape is illustrated in fig. 60 was one of the most noticeable in the T range at Kew, and though it cannot be claimed as of decorative value, *Callipsyche* undoubtedly possesses much interest. The flowers and their arrangement also are so peculiarly distinct that they at once attract attention amongst those of the type with which we are familiar. Moreover the plant is easily grown, requiring similar treatment to many bulbs from tropical

regions. An intermediate temperature suits it very well, and a compost of light loam and sand with a little leaf soil and good drainage are the principal points needing attention. Perhaps the chief defect is the fact that the flower scapes are produced without the leaves, and therefore have a rather bare appearance; by placing the plant with small Ferns, this, however, is readily overcome.

In Mr. J. G. Baker's arrangement of the Amaryllidæ Callipsyche is placed in the tribe Paneratiæ between Stricklandia and Phœdranassa, both small genera but little known in gardens. Callipsyche itself comprises three species from South America, one of which, *C. eucrosioides*, is probably not in cultivation. *C. mirabilis*, the subject of our illustration, is a native of the Peruvian Andes, whence it was introduced to Belgium, and first flowered in Mr. Wilson Saunders' garden at Reigate in 1870; but it has been subsequently introduced on several occasions by nurserymen. The flowers are greenish yellow, the stamens and style white, 3 or 4 inches long, and deflexed equally round the head, giving a strange appearance. *C. aurantiaca* is also from the Andes, and has bright yellow flowers, very distinct from the species previously noted, but smaller. At Kew it seems to flower rather later, and though Mr. Baker gives the time of flowering of *C. mirabilis* as July and August, it was flowering there in February.

ROYAL HORTICULTURAL SOCIETY.

APRIL 21ST.

ALTHOUGH the previous meeting of this Society was only held a week ago, the combined exhibits of the National Auricula Society and those submitted to the several Committees sufficed to fill the Drill Hall, four rows of tables being occupied with plants and flowers. At the afternoon meeting Mr. O'Brien's lecture on Cape Bulbs brought a full audience, and he treated his subject in an interesting manner.

FRUIT COMMITTEE.—Present: P. Crowley, Esq., in the chair, Dr. Hogg, Harrison Weir, J. Cheal, W. Warren, J. T. Saltmarsh, G. Wythes, J. Hudson, H. Balderson, F. Q. Lane, James H. Veitch, M. H. de Vilmorin, G. Reynolds, A. Dean, A. Moss, and J. Wright.

Mr. R. Gilbert, Burghley Gardens, Stamford, sent two dishes of well ripened Tomatoes, Selected Criterion and Wynne's Early Forcing, the former being somewhat egg-shaped and rather small, but brisk and good in flavour, the latter resembling good fruits of Orangefield. A cultural commendation was awarded. Mr. G. Wythes sent from Sion House good well-finished bunches of Black Hamburgh and Foster's Seedling Grapes; and was accorded a cultural commendation, also a vote of thanks for a dish of Strawberries, a seedling from Keens', and plant very dwarf. Messrs. J. Cheal & Son, Crawley, staged a collection of fruit, fifty-eight dishes of Apples and eight of Pears. Some of the best Apples, large and firm, were the following:—Prince Albert, Bramley's Seedling, Wellington, Mère de Ménage, Round Winter Noncuch, Beauty of Kent, Royal Russet, Brownlee's Russet, Cockle's Pippin, and Claygate Pearmain.

FLORAL COMMITTEE.—Present: W. Marshall, Esq., in the chair, and Messrs. Herbst, C. Turner, G. T. Bryceson, C. Jefferies, R. B. Lowe, C. Noble, H. Turner, B. Wynne, G. Paul, H. B. May, J. Walker, and the Rev. H. H. D'Ombraïn.

Azaleas from Mr. Charles Turner, Slough, formed an effective group, several new brightly coloured or delicate varieties being included. In addition to the three for which awards of merit were granted, the following were noteworthy for their fine quality: President Kerchov, rosy salmon and white, double; Ami du Cœur, bright red, double; Theodore de Reimers, rich purple, double; and Vervæniana, rose and white, double, very free and fine.

Sir J. T. D. Llewelyn, Bart., Penllergare, Swansea, exhibited a collection of Rhododendron heads cut from plants in the open air. It was stated that the plants were uninjured by the winter, but the flower buds had partly suffered from severe frosts in March and April. Several fine varieties were represented with bell-shaped flowers, brilliant red rose, purple, lilac, and white (vote of thanks). Mr. Wm. Melles, Sewardstone Lodge, Chingford, sent two large plants of the old lilac-coloured *Iris fimbriata*, for which a vote of thanks was accorded. Messrs. Paul & Son, Cheshunt, contributed a collection of hardy plants, comprising fine pans of *Primula altaica* crowded with its soft tinted flowers, *Erica herbacea*, the double golden *Caltha*, *Adonis vernalis*, and *Primula rosea* (bronze Banksian medal). Messrs. Barr & Son, King Street, Covent Garden, had an extensive and admirable group of Daffodils, for which a silver Flora medal was awarded. A group of *Anemone fulgens* also afforded much welcome colour from the same firm. A silver Banksian medal was awarded to Messrs. Ryder & Son, Sale, for a magnificent bank of *Primula Sieboldi*, in many handsome varieties; and a bronze Banksian medal was adjudged to Mr. G. Fhippen of Reading for some large baskets of variously coloured Primroses.

ORCHID COMMITTEE.—Present: Dr. M. T. Masters in the chair; F. Moore, E. Hill, J. Douglas, Lewis Castle, T. B. Haywood, and James O'Brien.

Sir Trevor Lawrence, Bart., M.P., Burford Lodge, Dorking, showed a *Phalænopsis grandiflora*, with a raceme with ten unusually large flowers, also *Odontoglossum excellens*, and two yellow varieties of a similar type shown as *O. Pescatorei*, for one of which—Prince of Orange—a first-class certificate was awarded. To Messrs. Sander & Co., St. Albans, a silver-gilt medal was awarded for a group of well grown Orchids, comprising capital specimens of *Trichopilia suavis* in baskets, with large numbers of flowers, *Cattleya citrina*, *Lælia purpurata*, *Odontoglossum crispum* and *Pescatorei*, *Odontoglossum Edwardi*, bearing

large branching panicles of dark purple flowers, a large specimen of *Dendrobium Brymerianum*, a fine *Odontoglossum Halli*, and several other useful Orchids.

Messrs. J. Laing & Sons, Forest Hill, showed a plant of *Lælia purpurata* var. *Schroederæ*, a handsome form with white sepals and petals, and a delicate purple veined and tinted lip. Col. R. Trevor Clarke, Welton Place, sent racemes of an excellent *Cattleya Lawrenceana*, the lip very richly coloured. Messrs. de Rothschild, Gunnersbury House, Acton (gardener, Mr. Hudson), exhibited a spike of *Vanda tricolor*, in which the terminal flower showed a curious combination with another.

In the class for a collection of Daffodils, *Polyanthus* varieties excluded, Messrs. Barr & Son's medals were awarded as follows:—First to Mr. C. May, gardener to H. J. Adams, Esq., Roseneath, Enfield, for well developed flowers of many variety; second, the Rev. Eugène Bourne; third to Rev. G. P. Hayden; and fourth to Miss Bertie Doyné, Seaford House, Gorey, Ireland.

CERTIFICATED PLANTS.

Oncidium Larkinianum (Mr. J. Larkin, Watford).—A grand *Oncidium* of the *O. Marshallianum* type, with large golden lips and rich reddish-brown barred sepals and petals. It has been previously adjudged an award of merit, and a first-class certificate was now recommended for it.

Odontoglossum Pescatorei, var. *Prince of Orange* (Sir Trevor Lawrence).—A beautiful *Odontoglossum* of the hybrid type, remarkable for the deep golden yellow ground colour of the sepals, petals, and lip, upon which were a few rounded deep brown spots, and the flowers are of capital shape.

Azalea indica Pharailde Mathilde (C. Turner).—A double variety, with very large flowers; white, lightly spotted with rose, and with a few streaks of the same colour.

Azalea indica M. Labrousse (C. Turner).—A single variety, with flowers of great size, of a peculiarly fine rich rosy crimson colour. The habit is compact and free in flowering.

Azalea indica var. *Princesse Clementine*.—A single or semi-double variety; white, with a creamy tint in the centre of the upper petal. Very free, and of good habit.

Rhododendron Championi (J. Veitch & Sons).—A distinct species from Hong Kong, with small heads of flowers, having long twisted white petals, the upper one spotted with yellow; the leaves are lanceolate, narrow, and densely hirsute, clustered under the flower heads (botanical certificate).

Primrose Covenant (G. F. Wilson, Esq., F.R.S.).—A dark blue variety, with a golden eye and a faint red zone. Extremely free and dwarf.

Primrose Mary Erskine (G. F. Wilson, Esq., F.R.S.).—Very distinct, of a pale lilac or lavender blue, and a small yellow eye edged with pale red. A great contrast with the dark forms.

SCIENTIFIC COMMITTEE.—Present: Mr. McLachlan, in the chair; Dr. Müller, Dr. Bonavia, Professor Church, Mr. G. F. Wilson, Mr. Blandford, Rev. W. Wilks, and Rev. G. Henslow, Hon. Sec.

Bigenes.—Mr. Wilks exhibited a plant named *Chionoscilla*, which was considered to be undoubtedly a bigener between *Chionodoxa* and *Scilla bifolia*. It was received from Mr. J. Allen, Park House, Shepton Mallet.

Blue Primroses.—Mr. Wilson exhibited several specimens illustrative of different shades of purple and blue Primroses.

Lemon, Malformed.—Dr. Bonavia exhibited a Lemon remarkable for a ridge from top to bottom. He suggested that it might be due to an adherent filament, and that the rind was an independent structure. Mr. Henslow observed that an anatomical investigation into the distribution of the fibro-vascular cords of the carpels of Oranges did not appear to support that view. He added that the well known peculiarity of horn-like structures arising from the surface of Oranges, was due to the adhesion of pistiloid stamens, which are not at all uncommon in Orange flowers.

Theobroma Leaves Diseased.—Mr. McLachlan exhibited leaves of the Cacao tree badly infested by *Capnodium citri*, which forms a soot-like sheet over the surface, but does not penetrate the tissues. It was received from Mr. Smith, the curator of the botanic gardens in Grenada, W.I. The leaves are attacked first by two species of coccidæ, one stellate the other linear in form. The coccids produce a secretion by which the fungus is nourished and thrives. Mr. Blandford observed that the same fungus occurs upon Oranges in California, which have in consequence to be washed. Mr. Riley in his report of the U.S. Department of Agriculture for 1886, speaks of the large masses of secretion produced by coccids. In Florida this fungus, known as black blight, is a regular consequence of the presence of the coccidæ on Oranges, and lives in the honeydew secreted by them. The names of the coccidæ are *Vinsonia stelliformis*, *Westwood*; and *Ischnaspis filiformis*, *Douglas*. The first or stellately formed species is found on Orchids in Assam, Mangos in Demerara, as well as on the *Theobroma* in Grenada. With reference to remedies Mr. Smith recommends petroleum emulsion for the coccidæ, but for the fungus Dr. Müller suggested polysulphides—*e.g.*, sulphur boiled with caustic lime.

Injury to Plants at Kew.—With reference to the remarks made by Mr. Dyer at the last meeting, they were somewhat incorrectly reported, in that the object of keeping the temperature as low as possible within glass houses in the winter was because it is practically impossible to retain a humid atmosphere with a high temperature, in consequence of the low external temperature and nocturnal radiation. The subject will be found fully discussed in Lindley's "Theory and Practice of

Horticulture," p. 207. With regard to exposed plants injured by frost in Kew Gardens, Mr. Dyer has added that notwithstanding the long persistence of a low temperature at Kew the bulk of the shrubs and evergreen trees did not at the close show the amount of injury which might have been anticipated. As soon as the sun came out and milder weather followed the frost, the shrubs began to go off wholesale, the green colour of the leaves disappeared, and they turned, not brown, as in autumn, but pale and grey. His conviction was that they bore the low temperature with comparative immunity, but that they could not bear the sudden transition from a low temperature to a high one. Mr. Morris informed him that precisely similar phenomena are observed at high levels in the tropics after frost. Mr. Wilks' theory that the shrubs are killed at the base is not the explanation at Kew, though, from local circumstances, it may be true of his own garden; and certainly it is not the case that any of the shrubs pushed forth buds before their premature decease.

BEGONIA TRIOMPHE DE NANCY.

At Burford Lodge, Dorking, Begonias have for some years been almost as pleasing a feature as the Orchids, though they are not repre-



FIG. 61.—BEGONIA TRIOMPHE DE NANCY, FLOWERS NATURAL SIZE.



FIG. 62.—BEGONIA TRIOMPHE DE NANCY, PLANT REDUCED.

sented in such numbers. It was not, therefore, surprising that the first plant of the new continental Begonia named above should have been shown at the R.H.S. meeting from Sir Trevor Lawrence's collection. Begonia Triomphe de Nancy was adjudged an award of merit by the Floral Committee on April 14th, and it well deserved the recognition. The plant exhibited was dwarf in habit, but strong with broad, rounded peltate leaves, suggestive of some of the hybrids from *B. socotrana*. The individual flowers are small, bright rosy red, pretty both in the bud and when expanded, but they are borne in such numbers on the slender branches of large graceful panicles that the plant is very conspicuous.

In a warm house this Begonia will grow well with others of its relatives, and probably prove more useful than some of taller growth.

NATIONAL AURICULA AND PRIMULA SOCIETY.

APRIL 21ST.

No very rosy anticipations were formed of this Society's southern Exhibition this year, the lateness of the season being expected to have a marked influence upon it. However, the result was by no means unsatisfactory, and must have been a pleasant surprise to many. It is true the Auriculas were, generally speaking, deficient in smoothness and finish, but the trusses were good, and in most cases the pips were large and well developed. The chief attractions of the Show were the magnificent plants from Mr. T. E. Henwood, who crowned a career of persevering effort by practically sweeping the board of prizes, defeating former conquerors most decisively. Mr. Douglas, on the other hand, was not showing so well as usual comparatively speaking. The Primulas were a beautiful display, in itself worth a special visit.

To turn to the classes, there were four exhibitors of twelve Auriculas, and Mr. Henwood of Reading, who has worked his way rapidly up to the front rank scored a very creditable victory. He had the following varieties:—The Rev. F. D. Horner (very good indeed), Mrs. Dodwell, Prince of Greens, Black Bess, Mrs. Potts, Abbé Liszt, Reliance, Lancashire Hero, George Rudd, Heroine, Acme, and a fine example of George Lightbody, which was eventually selected as the premier bloom in the Show. Mr. Douglas, gardener to Mrs. Whitbourn, Great Gearies, Ilford, was second; his Mrs. Moore, Acme, and Sapphire were very good. The third prize went to Mr. A. J. Sanders, gardener to Viscountess Chewton, Bookham Lodge, Cobham; and the fourth to Mr. Philip J. Worsley, Rodney Lodge, Clifton. Mr. Henwood won again with six plants, showing the Rev. F. D. Horner (good, but not equal to his other plant), Heroine (a capital example), Mrs. Dodwell, Lancashire Hero, George Rudd, and Mrs. Potts. The majority of these were in glazed pots. Mr. Douglas was again second, with Heatherbell, though somewhat rough, as perhaps his best. Mr. Sanders was third, Mr. Worsley fourth, and Mr. R. Dean fifth. Mr. G. Wheelwright, Reading, won with fours. He had Mrs. A. Potts (very weak), Mrs. Dodwell, the Rev. F. D. Horner (very neat truss), and George Rudd (smooth and even). Mr. W. Smith, Bishop Stortford, was second with a fair Heatherbell and Rev. F. D. Horner; Mr. W. Badcock, 175, Oxford Street, Reading, third; Mr. Phillips, 18, Hamilton Road, Reading, fourth; Mr. W. L. Walker, Reading, fifth; and Sir J. T. D. Llewelyn, Penllergare, Swansea, sixth. Pairs also were best shown by Mr. Wheelwright. He had a good truss of the Rev. F. D. Horner, but with somewhat small pips, and a very good Geo. Rudd; Mr. Phillips was second with Heroine and Geo. Rudd, Mr. Badcock third with Mrs. Potts and the Rev. F. D. Horner, Mr. Walker fourth with Heroine and Heatherbell, Sir J. T. D. Llewelyn fifth, and Mr. W. Smith sixth. Mr. Henwood was first and second with single specimens of green-edged, having the Rev. F. D. Horner in each case, both very good. Mr. Wheelwright was third and fifth with the same varieties, Mr. Douglas fourth and sixth with Abbé Liszt, Mr. Worsley seventh with the Rev. F. D. Horner, and the Rev. R. L. Flood (gardener, Mr. Gilbert) eighth with General Neill. In the grey-edged Mr. Sanders was first with a neat Geo. Lightbody, and eighth with Mrs. Moore; Mr. Wheelwright second with W. Brockbank, Mr. Worsley third with Geo. Lightbody, Mr. Henwood fourth with Geo. Lightbody, and seventh with Geo. Rudd, Mr. Douglas fifth with Geo. Lightbody, and Mr. Flood sixth with the same variety. In the white-edged class Mr. Henwood was first with John Simonite, large, smooth, well-marked pip, and fourth with Acme. Mr. Wheelwright was second with Acme and third with Conservative. Mr. Douglas was fifth with Conservative, Mr. Sanders sixth and seventh with Acme, and Mr. Smith eighth with the same variety. In the selfs Mr. Henwood was first and second with Mrs. Potts, both carrying excellent pips; Mr. Wheelwright third and fifth with the same variety, Mr. Sanders fourth with Black Bess, and sixth with Blue Beauty; the Rev. R. L. Flood seventh with Clipper, and Mr. Worsley eighth with Black Bess. The placings were somewhat difficult to discover owing to the peculiar arrangement of the cards, and it would not be surprising if an error had crept into the report. Mr. Douglas scored his first victory in the class for fifty plants, and they formed a charming display. Mr. C. Turner, Royal Nurseries, Slough, was second, also with a delightful collection.

Alpines in twelve varieties were admirably shown by Mr. Turner, and he won with T. E. Henwood, Peter Flower, F. Knighton, Exquisite, John Bright (first-class certificate), Mungo McGeorge, Phoebe, Sensation, Sunrise, Harry Furniss, Magnet, and Roland. Mr. Turner also received a first-class certificate for Mrs. Harry Turner. Mr. Douglas was second with twelve, showing Lady Howard de Walden and Daphne capitally. Mr. Weston, gardener to D. Martineau, Esq., Clapham Park, was third; Messrs. Paul & Son, Cheshunt, fourth. Mr. T. E. Henwood pursued his victorious career by taking first prize in the class for six Alpines, showing Love Bird, Defiance, Mrs. Martin, Chas. Turner, Mary Frances, and his seedling Mrs. Douglas, for which a first-class certificate was awarded, excellently. Mr. Turner was second with dwarf plants with good trusses, Primrose Queen, a variety with a large, smooth, flat pip and splendid eye, receiving a first-class certificate. Mr. Wheelwright was third, Mr. W. L. Walker fourth, and Mr. Douglas fifth. Mr. Wheelwright won with four plants, being well represented by Defiance (very good), Hotspur, Pallas, and Garnet. Mr. Henwood was second with Mrs. Martin, Princess of Wales, Jennie, and a seedling. Mr. W. L. Walker

was third, Mr. Sanders fourth, and Mr. Phillips fifth. Mr. C. Turner had the best gold-centred single specimen, showing a variety named H. M. Pollett, for which a first-class certificate was awarded. Mr. Henwood was second with Florrie Henwood, Mr. Sanders third with Diadem, Mr. Weston fourth with Sunrise, and Mr. Douglas fifth with Scylla. The best with a white or cream centre was Mr. Turner's Maud Fellowes (first-class certificate), and he was second with Countess. Mr. Henwood was third with Paragon, Mr. J. J. Keen fourth with Edith, and Mr. Wheelwright fifth with Albion. Besides those mentioned a first-class certificate was awarded to an Alpine named Mrs. Walker, and to a grey-edged named Mrs. Henwood, raised by Mr. Barlow.

Gold-faced Polyanthus were very good. Mr. Douglas was first with six, the varieties being Formosa, Exile, Cheshire Favourite, Lancer, George IV., and an unnamed variety. Mr. Weston was second, Mr. R. Dean third, and Mr. W. Melles, Chingford, fourth. Mr. Douglas also won with three plants, showing George IV., Lancer, and Cheshire Favourite. The other prizes went to Messrs. Sanders, Weston, and Dean. In the class for single specimens Mr. Douglas was first and third with George IV., the first very fine; Mr. Melles being second and fourth with Lancer. Mr. Douglas also easily won with Fancy Auriculas, Mr. R. Dean following.

The Primroses and Primulas formed a very bright display. Mr. Douglas won with twelve Fancy Polyanthus, a beautiful collection; and Mr. R. Dean's second prize collection was also much admired. Mr. Dean won with single Primroses, Mr. Douglas being second, and O. T. Hodges, Esq., Chislehurst, third. Pots or pans of double Primroses were greatly admired. Messrs. Paul of Cheshunt were first, and Mr. R. Dean second. Mr. Douglas won with twelve species of Primula, good clumps of Nelsoni, amœna, marginata, verticillata, obtusifolia, japonica, intermedia, nivalis, cashmeriana, rosea, obconica, and floribunda representing him. Sir J. T. D. Llewelyn was second. He had the beautiful latifolia and the graceful involuerata. Mr. Hodges won with six, the kinds being viscosa purpurea, marginata, nivalis, denticulata, viscosa, and hirsuta. Mr. W. Harper, the Guildford Hardy Plant Nursery, was second with patches of Auricula variety from the Dolomites, Auricula \times pubescens, nivalis, rosea grandiflora, villosa, and Balfouriana (hybrid of ciliata). He had some very interesting baskets of Alpine Primulas, not for competition, including longiflora, ciliata, ciliata purpurea, marginata, Auricula var. marginata, and many hybrids. Messrs. Paul of Cheshunt were first for a basket of Primroses, and Mr. R. Dean second. Messrs. Ryder & Son of Sale had a large and very beautiful display of Primula Sieboldi varieties, which attracted a great deal of attention, and Mr. Melles had some stands of seedling Auriculas.

THE ROYAL BOTANIC SOCIETY.

APRIL 22ND.

THE second spring Show of the season was held in the corridor and conservatory of the Regent's Park Botanic Gardens, a bright and varied display being provided by the numerous competing and other exhibits. The day was rather dull and cold, but the attendance was good for this early date.

Specimen Roses of considerable merit secured Messrs. Paul & Son, Cheshunt, the chief award in the nurserymen's class for nine plants, bright fresh examples of Avocat Duvivier, Violette Bouyer, Magna Charta, Ulrich Brunner, and Madame de St. Joseph being very noticeable. Mr. W. Rumsey, Waltham Cross, was a good second with vigorous freely flowered plants.

The best six Azaleas in the trade class came from Mr. C. Turner's medium-sized conical specimens, well flowered. Mr. H. Eason, gardener to B. Monks, Esq., Hope Cottage, Highgate, and Mr. R. Scott, gardener to Miss Foster, The Holme, Regent's Park, were first and second respectively in the amateurs' class for the same number. Spiræa japonica was well shown by Messrs. Langley, gardener to W. T. Twigg, Esq., Croxted House, West Dulwich, W. Morle, 283, Regent Street, and Messrs. A. H. Morle, 162, Fenchurch Street, who took the prizes in that order. Cinerarias from Mr. D. Phillips, Slough; J. Ford, gardener to Sir C. Piggott, Bart., Wexham Park, Slough; and Mr. J. Douglas, Great Gearies Gardens, Ilford, were well grown and attractive, securing the prizes as named. Messrs. Hayes, Lower Edmonton, had a group of new Pelargoniums, including some fine varieties. New Azaleas from Mr. C. Turner comprised similar varieties to those shown at Westminster on the previous day.

Hippeastrums (Amaryllises) were shown by three competitors, Messrs. Paul & Son, Cheshunt, being easily first with handsome plants, bearing large richly coloured flowers. Mr. Douglas was second, and Mr. R. Butler third, with smaller plants and flowers. A collection of nine Pelargoniums from Mr. D. Phillips gained him the premier prize in the class, his best plants being Fairy Queen, Rosetta, and Duchess of Edinburgh, very freely flowered. A dozen well grown graceful Dielytras gained a first prize for Mr. R. Scott, and excellent Mignonette, very similar in character, secured prizes for Mr. W. Morle, Messrs. A. H. Morle, and Mr. F. Stansell.

Primula Sieboldi varieties from Messrs. Ryder & Son, Sale, formed a beautiful group, arranged in pans with Ferns, and with a dozen specimens the same firm gained the first prize in the class provided. Daffodils from Messrs. Barr & Son, King Street, Covent Garden, were largely and well represented in an imposing group.

In the Auricula classes Mr. J. Douglas won first honours for twelve Show varieties. He was also first for twelve Polyanthus, and second for twelve Alpines; Mr. C. Turner being first in that class. The plants

in these classes occupied one table, and afforded a capital display. Alpine and hardy plants from Mr. T. S. Ware, Tottenham, and Messrs. Paul & Son, Cheshunt, were very interesting and varied. Mr. Ware also had a pleasing collection of Daffodils.

Stove and greenhouse plants in variety, with numerous choice Orchids, formed a beautiful and most interesting group from Messrs. B. S. Williams & Son, Upper Holloway. A tasteful and extensive group of Ferns from Mr. H. B. May, Upper Edmonton, constituted one of the most important exhibits at the Show, the plants healthy and the varieties numerous. Messrs. Hugh Low & Co., Clapton, had an effective group of Dendrobiums, Phalænopsis, and other Orchids with Ferns. Clivias, Heaths, Rhododendrons, and Orchids, with Ferns, Palms, and other foliage plants formed a beautiful group from Messrs. Laing & Son, Forest Hill. Azaleas indica and mollis varieties, with Epacris, Ericas, and Mignonette predominated in a showy group from Messrs. W. Cutbush & Son, Highgate.

New Hippeastrums and varieties of the hybrid Streptocarpus were shown by Messrs. J. Veitch & Sons, Chelsea, and indicated a marked advance in characters. New Roses from Messrs. W. Paul & Son, Waltham Cross, included the beautiful Teas Corinna and Sappho, also the bright pink substantial H.P. Danmark, and the delicate hybrid Tea White Lady. The new Camellias Beauty of Waltham and The Duchess were also shown. Mr. W. Rumsey, Waltham Cross, had a group of Roses and two boxes of cut flowers. Mr. J. Ford exhibited a handsome specimen of Rhododendron Countess of Haddington, 6 feet high and 4 feet in diameter, bearing a large number of flowers. Mr. J. Douglas staged a charming collection of Auriculas and Primulas, and Mr. C. Turner also had a group of Auriculas.

CHRYSANTHEMUMS INJURED IN A FRAME.

I WISH to thank your many able correspondents for their valuable hints on growing Chrysanthemums, and if you think this note worthy of a place in the Journal it may be a useful warning to young growers. Three days ago a neighbour came here in great distress to tell me how he had lost nearly all his plants, about 200, after placing them in 6-inch pots and arranging them in cold frames. The story runs thus: He sent a man to thoroughly clean the frames and place a layer of ashes in the bottom, with a little soot to keep slugs away; the plants being potted were placed in the frames, the lights put on "close" and left. The sun was shining occasionally, and thinking the plants might be too warm he went to provide ventilation about two hours afterwards, when he found all the leaves drooping and black, and to all appearance quite dead. As a little help is worth a good deal of pity we gave him of our abundance to repair his loss, but not feeling quite satisfied with the story we thought we would try a few experiments, and thinking that lime must have been used we mixed some ashes, soot, and lime together, put the mixture in a sunny position, placed three healthy plants on it, and covered them with a bellglass. Two hours afterwards they were examined, and found just in the condition described by our friend. Plants were then put on lime and left for about fifteen hours without any apparent injury; they were then placed on soot for a few hours, but were not any the worse; the soot, lime, and ashes were then mixed as before, and the plants placed thereon, the bellglass used in each case being the same. The last mixture had the same effect as before—viz., all the leaves became quite black and drooping.—A. HAGGART.

NEWCASTLE FLOWER SHOW.

THE spring Show of the Durham, Northumberland, and Newcastle-upon-Tyne Incorporated and Botanical Society took place on Wednesday and Thursday, April 15th and 16th, in the Town Hall, Newcastle. The long and severe winter in the north has kept all vegetation very backward, but the spring Exhibition proved what can be accomplished by good culture independent of any climatal disadvantages. The entries were larger than in former years, and the quality of the exhibits better. The Hyacinths formed an excellent display, in fact this may apply to the bulbs generally; while, perhaps, the most striking improvement was seen in the Auriculas.

The awards of the Judges were as follows:—With four plants, distinct, there were four exhibitors. Mr. F. C. Ford, gardener to Mrs. Henry Pease, Pierremont, Darlington, was first. He staged an excellent *Cœlogyne cristata*, over 4 feet through, and profusely flowered; a fine specimen of *Erica Victoria Regina*, *Tremandra ericoides*, and *Imantophyllum miniatum superbum*. Mr. James Wood, gardener to T. Lange, Esq., Heathfield House, Gateshead, was second with *Azalea Duc de Nassau*, *Dendrobium nobile* and *thyrsoflorum*, the latter with thirteen fine spikes, and a plant of *Erica affinis*. Mr. E. Adams, Swalwell, was third.

Orchids were not largely represented, only two collections being staged. This is regrettable, considering the number of Orchids now in flower, and is no doubt attributable to the small amount of money the Society offers—only 45s. altogether, which includes three prizes. Mr. J. Wood was first, his best plants being *Cattleya Mendelli*, three spikes and two blooms each; *Dendrobium Heathfieldianum*, twenty spikes; and *Wardianum*, seven spikes. Mr. John McIntyre, gardener to Mrs. Gurney Pease, Woodside, Darlington, was second with *Dendrobium thyrsoflorum*, three spikes; *Cymbidium eburneum*, twelve flowers; and *Cypripedium villosum*.

For four Azaleas, distinct, Mr. F. C. Ford and Mr. McIntyre were awarded equal firsts for specimens finely flowered and not too formally trained, the former showing *Duc de Nassau*, *Vesuvius*, and *Annette*; the

latter Bernard Andreas alba, fine double white, and Oswald de Kerchove, a charming rose. Dielytras, Deutzias, Genistas, Spiræas also formed a large show at Newcastle, and added considerably to the attractiveness of the Exhibition, as the Staging Committee take care they are effectively disposed for that purpose. Mr. John McIntyre, Mr. Jos. Punton, Mr. Geo. Corbett, and Mr. James Wood were respectively first in each class.

Cinerarias, Primula sinensis, and Cyclamens formed a very important feature in great numbers. Mr. Jos. Punton, Mr. A. G. Brown, and Mr. John McIntyre were first in the classes in the order named.

Lily of the Valley was represented by five exhibits of six pots each. Mr. W. Jos. Watson was first and Mr. W. R. Armstrong second. The latter showed much dwarfier plants, the flowers on the individual spikes being very fine, but they were not so large as the first. Table plants were very numerous shown. Mr. J. McIntyre was first, and Mr. W. L. Thompson, gardener to C. L. Bell, Esq., Wolsington, second.

Auriculas occupied all one side of the Town Hall, and received a good deal of attention from the lovers of this flower, who are every year increasing in the north. For twelve Auriculas not less than nine varieties, Alpines excluded, Mr. Robt. Patterson, gardener to Mrs. Backhouse, Ashburne Gardens, Sunderland, was first with even and symmetrical plants, including Prince of Greens (five pips), Frank Simonite (eight pips), Acme (five pips), Rev. J. Horner (eight pips), Chas. Ed. Brown, and John Simonite (five pips), the latter really most distinct in every particular; it also received the award for the premier flower in the Exhibition. Mr. W. H. White, Killingworth, was second with Rev. J. Horner (nine pips), and in another week this plant will be grand. Mr. Ed. Oliver Benton was third. There were five exhibits, all of which possessed considerable merit. For six Auriculas, Alpines excluded, Mr. R. Patterson was again first, followed by Mr. W. H. White. Acme was fine and very even in the premier collection, as well as Glory and Heroine. Prince of Greens was good in the second exhibit. Mr. W. L. Thompson was first for four, with Trail's Beauty, Acme, and George Lightbody. For two Auriculas Mr. R. Patterson again scored premier honours; and for one green-edged Mr. W. H. White was first with E. Wilson. For grey-edged and white-edged Mr. R. Patterson was first with Silvio and Acme. For a self Auricula Mr. W. H. White and Thomas Battensby, were first and second.

For twelve Auriculas, Alpines, not less than nine varieties, there were six exhibitors, the first prize falling to Mr. Wm. Sutherland, gardener to Hy. B. Watson, Esq., Millfield House, Newcastle. Mr. Sutherland is a new exhibitor at Newcastle, and we congratulate him on the excellent plants staged. They were also admirably arranged for effect. The varieties were Sensation, Diadem, Paragon, Mercury, Horner's Nonsuch, Mr. Phipps, King of Belgians (twelve pips). Mr. W. H. White was second, including Love Bird, Queen Victoria, and King of the Belgians. Mr. R. Patterson was here a very good third, six being staged. For one Alpine Mr. Sutherland was also first. For six Polyanthuses, gold-laced, distinct, and Polyanthuses, gold-laced, Mr. J. Cawthorne, Windy Hill, was first, including blooms of William the Fourth, Perfection, and Napoleon.

Bulbs in Bloom.—With twenty-four Hyacinths, singly, in pots, and not less than twelve varieties, Messrs. Alex. Kerr & Son, Kalemouth Nurseries, Roxburgh, were first with fine healthy specimens. They included King of the Blues, Czar Peter, King of the Blacks (violet), Maria (light blue), Mont Blanc (white), Von Schiller, and Lord Macaulay for reds. Mr. W. J. Watson was second with similar varieties, and Mr. Dewar third. For twelve Hyacinths the latter exhibitor was first, Mr. Wm. Sutherland second, and J. McIntyre third. Six of the latter were staged, and five of the former. The first contained Koh-i-noor (very good), Lord Macaulay, Fabiola. Altogether the Hyacinths were even, and must have caused some thought to the Judges.

Mr. W. J. Watson was also first for single Talips, first for double, and first for Polyanthuses, all of which were good. Prizes were offered for Trumpet Narcissus this year, and Mr. J. T. Wheeler, gardener to C. Mitchell, Esq., Jesmond Towers, Newcastle, was first with good blooms of Emperor, Horsefieldi, Golden Spur, Albicans, and Sir Watkin. Mr. W. J. Watson was second with Empress, Princess, Golden Spur, and Bicolor Horsefieldi.

Cut Flowers and Table Decorations.—These form one of the grand features of the Newcastle spring Show, the exhibition of which is held apart from the other departments—viz., in the Town Hall above the Corn Exchange, the former of which is approached by a grand staircase, where a fine view of the Exhibition is obtained from the first landing. In the vase or epergne for drawing-room class eight competitors entered, and the first prize was deservedly awarded to Mr. Geo. Webster, Sunderland, for an artistic display. The Marsh stand had three tiers as usual, The bottom one, a new feature, was very bold in outline, indeed heavy, but evenly balanced by the judicious margining of Adiantum trapeziforme, on which was placed Dendrobium thyrsoflorum, Cattleya Mendeli, Anthurium Schertzerianum, and many other choice flowers. The second tier was less than the bottom. Pelargoniums and Tea Roses were used, and toned with that effective and useful plant for decoration, Caladium argyrites. On the top, Asparagus plumosus nanus, Cymbidium aloifolium, and Oncidium flexuosum were gracefully and evenly balanced. With the other two tiers, the second by Mr. Edmondson, was also good, the base perhaps rather stiff and heavy, but many choice flowers were used. Mr. Jos. Punton was third, also with a very good epergne.

Bridal bouquets excited strong competition, but the fashion seems to be to make them unwieldy, and far too massive in outline. Six bouquets were staged. Miss E. Armstrong, 32, Neville Street, Newcastle,

was first. Choice white flowers were used, including Lily of the Valley, Niphetos Rose, Stephanotis, Eucharis amazonica, and Cœlogyne cristata. The dressing of this bouquet was chiefly done with Asparagus plumosus nanus. The size was 21 inches across, and about the same height. Messrs. Perkins & Sons, Coventry, were second, and their bouquet contained some fine Orchids, especially blooms of Odontoglossum Alexandrae. Third and fourth, by Mr. Geo. Webster and Mrs. Oliphant, also with good exhibits.

Messrs. Perkins were first amongst five competitors for the hand bouquet. Their arrangement was most pleasing; Asparagus plumosus nanus was also used in this bouquet. Cattleya Mendeli, Disa grandiflora, Dendrobium Paxtoni and Wardianum along with Roses made a perfect combination of colour. Yellow and olive green ribbons were also appanages to the completion of the bouquet.

For the lady's spray there were sixteen entries. Mr. John Battensby, Swalwell, was first with an excellent sample, not too large as many of them evidently were; it also for the groundwork consisted of Asparagus. Wm. Allan Richardson Rose, such a charming terra cotta colour blended most easily with Odontoglossum Alexandrae and Ericas that the effect was perfect.

Buttonhole bouquets drew forth twenty-nine competitors. Mr. Geo. Corbett, gardener to John Liddell, Esq., Benwell Towers, was first. The arrangement was truly unique, a little blue Cineraria, Maréchal Niel and also Wm. Allan Richardson Rose and the smallest portion of Chionodoxa Luciliae and Spiræa or Asparagus was a simple and recherché arrangement.

In the B division of classes, where nurserymen cannot compete, some excellent plants were staged. Messrs. John McIntyre, Wm. B. Forsyth, and A. G. Brown, who were first for Spiræas, Cinerarias, and Primulas. For Cyclamens and Lily of the Valley Messrs. John McIntyre and John Morris were respectively first, and Messrs. Brown, Wood, and McDougall were successful amongst bulbs. For the cut flowers Mr. Geo. Webster scored first, and Miss E. Armstrong for the bouquet.

The exhibits from nurserymen never were on so large a scale, and added much to the general attractiveness of the Exhibition. The groups were shown by Messrs. John W. Tate, 19, Green Market; Adamson Bros., Bentwick Nurseries; W. R. Armstrong, Benwell; F. Edmondson, Green Market; J. Hood, 109, Elswick Road; all of Newcastle. H. H. Hieler, nurseryman, 10, Wycomb Street, Darlington; Jos. Robson and Sons, Hexham; and Messrs. Wm. Fell & Co. of Hexham. Mr. Thos. S. Ware, Hale Farm Nurseries, Tottenham, London, showed a capital stand of Daffodils and other flowers 60 feet long. Messrs. Ryder and Son, Sale, Manchester, exhibited a fine collection of hardy Primulas in large pans, all named varieties, similar to those shown at Manchester the previous week.

In concluding our notes of this very fine Exhibition, it is to be hoped that the summer Exhibition may be favoured with good weather. The present Chairman of the Committee, Jos. Baxter Ellis, Esq., has been raised to the dignity of Mayor of Newcastle. He is an enthusiast in flowers and plants, and takes a great interest in the city parks. Under his chairmanship, and an energetic and willing Committee, and painstaking Secretary, the future of the Show, we think, is certain.



HARDY FRUIT GARDEN.

STRAWBERRIES.—In dry situations the mulching ought to be put on early in the season, before hot dry weather comes, but it is best to let the beds be well soaked with the April rains, and then to mulch as soon as possible, thus checking evaporation and keeping the roots cool and moist, conditions which the Strawberry delights in. If weeds have appeared all should be thoroughly cleared off before mulching, or they will be troublesome before the fruit is gathered, and cannot easily be removed at gathering time without making the fruit gritty. We find manure fresh from the stables the best material for this purpose; by shaking out the smaller particles before putting it on we do not get so much corn growing among the plants as we otherwise should do, and if put on early it is washed quite clean before the fruit ripens. If this cannot be had any fairly long hay or straw litter will do if free from seeds, and is preferred to grass mowings, which are more encouraging to slugs, are apt to adhere to the fruit and cause decay, and will strike root and grow in damp weather when laying thinly. In cool and moist positions there is no need to mulch so early if the beds are hoed over once in ten days to keep down weeds and prevent the ground from cracking, but all should be completed in time to get the manure well washed with the rain before the fruit is set.

PEACHES AND NECTARINES.—Disbudding will now require attention. It is not advisable to take off too many shoots at one time; the better way is to go systematically over the trees three times at intervals of about two weeks, first taking all shoots at the back and front of the branches. The second time take away half of those remaining, leaving the best shoots at the base of last year's wood, and the others equally distributed over the trees. The third time remove all except those required for

furnishing bearing wood next season, and a few left at intervals of 9 inches along the branches to keep up a steady growth and prevent any check to the development of the fruit. These will afterwards need stopping at the third or fourth leaf. Be careful not to disturb the young fruits where these ought to remain on the trees, but at the third time of going over the trees they may be thinned out to 3 inches apart, leaving the largest and those that are in the best position for future development. The shoots left for bearing wood next year must be on the upper side of the branches. In most instances one at the base of last year's wood will be sufficient, except for young trees and those having more wall space to fill. These will require young wood laying in at intervals of 12 to 18 inches throughout the whole length of last year's wood. All terminal shoots should be allowed to grow until the final disbudding, when those not required for extension may be stopped at the third or fourth leaf.

Insects.—Green fly is sure to appear early on outdoor Peaches and Nectarines, and if left for many days unchecked it is very difficult to dislodge effectually. As soon as any trace of it is seen puff tobacco powder on with a distributor when the leaves are damp, and if many of them are blistered or curled pick them off and burn them. It is a good plan to syringe the trees with tobacco water occasionally as a preventive of fly. We use the London tobacco juice, and place about three-quarters of a pint in 3 gallons of soft water, stirring it well and applying it in the afternoon after strong sunshine has ceased; it should not be rinsed off the trees, as it will not injure the foliage at the above strength. Trees that have been previously attacked by red spider should be syringed with Gishurst compound occasionally at a strength of 1 to 2 ozs. to the gallon.

FRUIT FORCING.

VINES.—*Early Forced Vines.*—Red spider usually appears in early houses, and spreads with remarkable rapidity. Where it infests a house extensively it is difficult to deal with, but if care be taken to sponge the first infested leaves with softsoap and water there is seldom need to resort to such measures as painting the hot-water pipes when heated to 160° or more with sulphur mixed with milk. The latter is often highly prejudicial, causing the skin of the Grapes to harden and inducing cracking, whilst it injures the tender-skinned varieties irreparably, causing Muscats to assume a purple tint. Where red spider appears on Vines the fruit of which is colouring use sulphur on the pipes carefully, or if only a few leaves are infested sponge them with a solution of softsoap, 2 ozs. to the gallon.

To Vines with the Grapes colouring afford a thorough watering, mulching afterwards. This refers to the inside border. Early Grapes do not always colour well, the defect arising from overcropping or hard forcing; it is avoided by a constant supply of dry warm air and a low night temperature. Where Grapes are fully ripe a reduction in temperature is advisable, yet moderate moisture must be maintained for the benefit of the foliage. The moisture will not do the Grapes any harm provided the air is changed by free ventilation. Afford a temperature of 60°.

Succession Houses.—Attend to stopping and tying the shoots. Where the space is restricted stop the shoots two joints beyond the fruit, and as foliage is necessary leave the laterals on the shoots both above and below the bunch, or at least those from the two lowest eyes and those level with and above the bunch. Pinch these at the first joint, especially the basal ones, also above unless there is space for extending the laterals, when they may be allowed to make two or three leaves, but no more growth must be encouraged than can have exposure to light and air. After the space is fairly furnished keep the growth closely pinched to one joint as made. Where there is more space stopping will not take place until growth has extended four or more joints beyond the fruit. The great evil is overcrowding, which deprives the foliage of the essential light and air, and restricting the growths is intended to prevent that.

Routine.—Tie the shoots into the places where they are to remain during the summer is an operation which commands much attention. It is a common practice to commence tying down the shoots as soon as they are long enough to bend. This is not advisable except as a precaution against injury from frost, as the shoots at this stage are so tender that the slightest twist the wrong way breaks them. It is a better plan to defer tying down until the shoots are less sappy, which may be when the fruit is forming, but a better plan still is to so dispose the rod that the shoots, instead of having to be brought down to a nearly horizontal position, will have an incline upward, yet sufficiently outward to admit light to the basal leaves of the shoots. Afford Muscats in flower a free circulation of rather dry air and a temperature of 80° to 85° or 90° by day, falling to 70° or 65° at night, raising the points of the bunches to the light and liberate the pollen at midday by gently rapping the footstalks of the bunches. If there is a deficiency of pollen take it from those that afford it plentifully, as Black Hamburgs and Foster's Seedling, and apply it to the shy setting varieties with a camel-hair brush.

Thinning.—Where there is a quantity of Grapes to be thinned commence as soon as they are out of bloom with the free-setting varieties, such as Black Hamburgs, and some, like Gros Colman, Gros Guillaume, and Trebbiano, may be thinned whilst they are in flower; but Muscat of Alexandria, Lady Downe's, and Mrs. Pince must not be thinned until the properly fertilised berries can be determined by their taking the lead in swelling. Follow it up early and late, and on dull days. Surplus bunches may be removed boldly, as overcropping is alike fatal to well swelled berries as to colour and finish, also next year's crop.

Feed swelling crops liberally, either by surface dressings worked in or liquid manure, and maintain a moist genial condition of the atmosphere.

Young Vines.—Those planted last year are breaking naturally, and may be assisted with gentle fire heat in cold weather. The canes will have been depressed so as to cause to break regularly down to the basal buds, when they can be tied in position. Disbud, leaving the best shoots about 18 inches apart on both sides of the canes. Crop very lightly, one or two bunches being the maximum. Any extra Vines planted to fruit early and afterwards to be cut out, may carry a bunch on every side growth, but six to eight bunches according to their vigour are more satisfactory than a greater number to a Vine.

Planting Vines.—This is a good time for planting young canes. The borders are preferably partly within and partly outside in successful practice, planting the Vines inside the house; but for Muscats and early forcing the borders are best wholly inside. If the subsoil is unfavourable the border must be concreted. Avoid asphalt and cement, but bricks on flat laid in cement answer very well, yet Vine roots do not appreciate the asphalt and cement nearly as well as concrete formed of gravel and lime. If the substratum be gravel or other porous substance concrete is not necessary. Provide drains with proper fall and outlet to carry off the superfluous water, the bottom inclining to them. Rubble a foot thick should be placed on the concrete, 9 inches of clean rubble, and 3 inches thickness of old mortar rubbish, freed from pieces of wood and the finer particles by passing it through a half-inch sieve; 24 to 27 inches depth of border is ample. Turf 3 inches thick, taken off loam preferably friable than very tenacious over limestone, broken up roughly and mixed with a sixth of old mortar rubbish and charcoal, forms a suitable compost, but well drained and fertile garden soil will grow Grapes after the first "flush" of the turf is over quite as well. Bones are just as well kept out of the compost, using them, however, in bonemeal or superphosphate form as surface dressings, thereby keeping the roots near the surface and feeding them as required.

The Vines cut back in winter and kept in a cool house now have shoots 2 or 3 inches long. Turn them out of the pots, remove every particle of soil, carefully preserving the fibres. Spread the roots out straight and flat, the soil of the border having been brought to the required level, covering the roots to the depth of 3 or 4 inches, working the soil well amongst them with the hand, and giving a good supply of water at a temperature of 90°, mulching with a little short litter. If the canes have not been shortened do not cut them now, but remove the buds from the upper portion down to where fresh growths are desired to issue, and cut away the disbudded part when the Vines have made some leaves, as there is then no danger of bleeding, nor will any take place from rubbing off the buds after they start into growth; but if they are extracted with a knife, and the wood laid bare, bleeding ensues, greatly weakening the Vines.

Six feet width of border will be sufficient to commence with. Sprinkle the Vines and house twice a day, but avoid sharp forcing. Temperatures of 55° at night, 65° by day artificially, and 70° to 75° with sun, are suitable. If the weather be bright and the panes of glass large, shade from 10 A.M. to 2 P.M., when the house should be closed, damping all available surfaces. If the temperature rise to 85° or more it will be an advantage. When the Vines have started into growth give every encouragement, increasing the temperature to 60° to 65° at night, 70° to 75° by day, and 80° to 85° from sun heat.

FIGS.—*Earliest Trees in Pots.*—The fruits of the very early small varieties are ripe, and the finer Brown Turkey and White Marseilles are nearly so, hence the supply of water at the roots must be diminished, discontinuing syringing, and a free circulation of warm air afforded, leaving the top ventilators open a little at night. Although watering is advised to be lessened during the ripening of the fruit, the soil must be kept moist, and a moderate moisture in the atmosphere secured by an occasional damping, but this will only be necessary in very bright weather. As soon as the first crop is gathered syringe the trees twice daily, renewing the top-dressing, and watering at the roots with weak liquid manure. If the second crop be very abundant, the fruits must be thinned so as not to overtax the trees for early forcing next season.

Early-forced Planted Out Trees.—The fruit is advancing rapidly towards the ripening stage, and must have plentiful nutriment. If necessary, give the trees a thorough supply of water or liquid manure, and mulch with partially decayed rather lumpy manure. Do not cease syringing until the fruit commences ripening, avoiding then a superabundance of moisture about the house, having a little ventilation at the top of the house constantly, and a free circulation until the fruit is all gathered. Do not gather the fruit until it is thoroughly ripe, unless it has to be packed.

Succession Houses.—Attend to stopping the shoots at the fifth joint, and subsequently to one or two, but too many side shoots must not be encouraged, as the fruit and wood require light and air for its maturation. Train extensions in their full length, thinning or removing strong growths so as to admit light and air to the fruit. Attend daily to syringing the trees, and supply water as necessary to maintain thorough moisture at the roots. Renew the mulching if necessary, and keep it moist so as to encourage the roots and keep them at the surface.

Cherry House.—Directly the stoning is complete the fruit commences colouring and takes its swelling for ripening. The temperature may now be raised, but it must not exceed 65° by artificial means and 55° to 60° at night, with a little ventilation, increasing it at 70°. Subject to the leaving of a little air on constantly at the top of the house, close at 70°; but the temperature must not be allowed to exceed

that degree in the early part of the day without full ventilation. From the commencement of colouring until the trees are cleared of their fruits syringing must cease, or the fruit will crack; but a good moisture should be maintained in the house by keeping the surface of the border moist, or if the trees are in pots damping the floor two or three times a day, avoiding, however, a stagnant atmosphere. Aphides must be kept under by an insecticide, but fumigation only can be had recourse to after the fruit commences ripening. The border must not lack moisture, and liquid manure should be liberally accorded trees in pots.

PLANT HOUSES.

Chrysanthemums.—Potting plants intended for the production of large blooms should be proceeded with as rapidly as possible. If they have been grown in cool quarters they will be sturdy by this time. Pots 5 and 6 inches in diameter will be large enough for them, and the plants as they are potted may be arranged in cold frames. Any plants that have grown weakly may when once established in these pots be well pinched. Keep the frames close for a few days and then ventilate freely, as quick soft growth is not desired. Those intended for bushes, and stopped as soon as they were rooted, may be transferred into larger pots; pinch the shoots from time to time as they need it. Be careful not to "overpot" weak growing varieties and early flowering. Cuttings may still be rooted and grown without pinching for the production of fair sized blooms, or they may be pinched according to circumstances. Insert cuttings of late flowering varieties in triplets, and grow them on together afterwards, as these will be found useful.

Clivias.—As these cease flowering large plants may be divided. These plants are most useful for decoration in 6 and 7-inch pots. To place strong pieces into these sizes the old roots may be cut away, and remove them after potting into a vinery or Peach house; they will soon become established. Good varieties flowering now may produce seeds, but do not sow the seeds directly they are gathered or they will decay; they must be thoroughly dried and then will soon germinate. Propagation by offsets is a very slow process, and seedlings take three years before they become strong flowering plants. Some superior varieties may often be obtained by raising seedlings—even better than the parents from which they have been saved. Where light coloured flowers have size and the smaller ones brightness, it is advisable to cross them. This we have adopted with marked success.

Heliotrope.—Where standards are desired insert cuttings at once, or select from those already rooted. Grow the plants in heat, and repot on as they need more root room. When a few inches high place to each plant an upright stake, and remove all laterals from the axils of the leaves until the desired height of stem has been obtained. Allow the plants to extend 4 or 5 inches above the height required before they are pinched. If trained upon standard trellises the lateral growths must be allowed to extend until they reach the outside of the trellis before they are pinched; if not they can be supplied with a stiff stake and stopped frequently to induce a bushy head. For this purpose White Lady is one of the best. Insert cuttings for flowering during the autumn and winter in 5 and 6-inch pots.

Francoa ramosa.—The best way of obtaining a stock of this useful plant for furnishing purposes is by seed, which can readily be saved from old plants. In heat it germinates freely, and if grown on into 5-inch pots the plants will be found very useful. Their light arching spikes of bloom are very effective, standing above other plants, and are also useful in a cut state where light effective arrangements are desired.

Libonias.—Cuttings rooted some time ago and placed in small pots will be ready for 4-inch pots. Place them in a compost of loam, one-seventh of manure, a little leaf mould and sand. Remove the point of the plant to induce free branching. Place them after potting on a shelf close to the glass where the night temperature does not fall below 50°. Cuttings may still be rooted.

Primulas.—Double Primulas that flowered early and were surrounded with light soil have rooted freely from the collar. These may now be divided and placed into small pots. Place these on a shelf in a warm moderately moist atmosphere, and shade from the sun until they are established. Surround others with light soil, and induce them to root in the same way in a moderately moist atmosphere. Do not supply water too freely at first or the plants may suffer from damp. It is a good plan to keep them somewhat dry and cool before earthing them. With increased heat and moisture they soon emit roots. Single varieties that are large enough should be placed into small pots and more seed sown in about a month. Establish the young plants in heat, and then gradually harden them to cooler quarters until they can finally be grown in cold frames.

Solanums.—Seedlings and those raised from cuttings may be potted as they need it. Those that have been cut back and have commenced growth should have their roots partially reduced and be repotted in the same size. For the present these plants will be at home in a vinery or Peach house where the temperature is not too high. Pinch the former and any shoots on the latter that are taking the lead. Syringe freely and watch for aphides.

Rhodanthes.—The earliest of these will be better in cold frames than in a close atmosphere. Place round the sides of the pots four or five small stakes and a thin shred of matting, which will be ample to support them at first; as they grow taller more matting may be placed round the stakes. Sow more seed in pots and place them in heat until the seed has germinated, then remove them to cold frames.

Statice Suworowi.—Seedlings that are large enough may be transferred to small pots and grown in a temperature of 50° where air is

admitted daily, for nothing is gained by trying to hurry them. The remainder of the plants not required for pots may be placed in pans or boxes for planting outside. In pots this plant is useful for grouping in the conservatory.

Primula obconica.—Place a few plants that are flowering in a cool airy frame for seed-bearing. When given abundance of air they set seed freely. Prick off seedlings into pans until they are large enough for potting. Seed may also be sown, but do not cover it; sow on the surface and water with a fine-rose can.



APIARIAN NOTES.

WEATHER NOTES.

WITH the exception of the morning of the 16th, when the thermometer registered 38°, all the other morning temperatures were 25°, except the 15th at 30°, the highest day's reading being 53°. On the 17th by 11 A.M. the temperature had risen from 25° to 53°, so expect it to be the warmest day of the month. I have known fine summers follow a dry April, or what has been termed, and the opposite if wet, so that the future weather may depend more upon that than either the severity or mildness of the winter. In most cases a warm summer followed a mild winter, succeeded by a dry April.

STATE OF HIVES.

The calm air and sudden rise of temperature on the morning of the 17th enabled me to look around the hives all busy at work carrying large pellets of pollen, the Punicus far outstripping all others. The most striking feature, however, observed is the advanced state of unfed and well covered hives over those in double cased ones, and a few that had been fed. But the contrast is greater with a few hives not far from my own, well covered, but which had a less supply of food at the end of the season are nearly worthless.

BEE PROSPECTS.

Should fine weather continue for two weeks the bees will have ample honey and pollen to enable them to stand a campaign of cold in May, and be ready for swarming in that month. In all fruit-growing districts where the frost has not injured the buds, Plums and Gooseberries are about bursting into bloom. Should our wishes be granted all artificial feeding will be dispensed with, but if not syrup will be supplied liberally, even to stocks with abundance. We must neither allow eggs nor grub to be destroyed now if profit is to be expected in the autumn.

LOSS OF BEES.

There is perhaps no time during the whole year so destructive to bees as during a cold spell in the month of May, and I know nothing that will prevent it, except it be in having the hives in good condition, to lessen the desire of the bees to go abroad in search of the needful.

WEAK HIVES.

Sometimes these become so much affected by the cold that they are an easy prey to robbers, choosing to remain in a dull state upon the combs rather than to defend their stores. Feeding weak hives renders the bees less inclined to defend, and even strong hives become affected in this way, a good objection to feeding. When a hive is discovered to be in this comatose state transfer the combs into a heated hive, but if they be damp or mouldy do not restore them to the bees until they have been thoroughly dried and heated. Those with the bees adhering may be transferred into the warmed hive, and kept within doors in a moderate warm place, and well ventilated until the combs are all restored, and set outside if warm, but if not keep them inside until the weather is favourable. The bees will make no effort to escape so long as the weather is unfavourable. After the above has been accomplished take the first opportunity when young bees are airing themselves to pick up a few and drop them into a wide-mouthed small bottle, which is closed by the thumb. When the bottle is well filled

invert it over a block of wood, having a hole in the centre corresponding with the neck of the bottle, and which leads to the interior of the hive. Cover the bottle, and in a few seconds the bees will join the cluster without the risk of killing or being killed, and will put spirit in the older bees to defend and work better than anything I know. Several bottlefuls of bees may be put in, which may be gathered from all the hives in the apiary. Many a hive have I improved in this way which yielded large quantities of Heather honey, and in some cases a surplus of Clover honey. The above plan is quite practical in the case of "C. R.'s" weak hive.

COVERING HIVES.

A correspondent has erred in covering his hives by placing the dried grass between boards. It should be kept close to the sides and the tops of all hives, the top always demanding the greatest quantity. Although the treatment of bees in some cases should be different from that of human beings, in this case it should not. Just as blankets are kept close to the body for warmth in the bed, so should the covering upon the hive. I am glad to hear the supposed lost queen is safe. Many an older and greater experienced bee-keeper has taken a swollen worker for a queen; aye, and authors of works on bees, but lacked the right knowledge. It makes little difference whether the super cover is removed or not, providing the covering touches the crown and sides.—A LANARKSHIRE BEE-KEEPER.

[An interesting letter on the patent laws by "Hallamshire Bee-keeper" cannot be published this week.]

TRADE CATALOGUES RECEIVED.

Thomas Painter, Smallwood.—*Catalogue of Dahlias.*

W. L. Lewis & Co., Southgate, London.—*Price List of Orchids.*

William Paul & Son, Waltham Cross.—*Catalogue of New Roses and Florists' Flowers.*



•• All correspondence should be directed either to "THE EDITOR" or to "THE PUBLISHER." Letters addressed to Dr. Hogg or members of the staff often remain unopened unavoidably. We request that no one will write privately to any of our correspondents, as doing so subjects them to unjustifiable trouble and expense.

Correspondents should not mix up on the same sheet questions relating to Gardening and those on Bee subjects, and should never send more than two or three questions at once. All articles intended for insertion should be written on one side of the paper only. We cannot reply to questions through the post, and we do not undertake to return rejected communications.

Glazing without Putty (*R. A. P.*).—Possibly the system to which you refer is Helliwell's. We do not know whether they have a branch at Birmingham or not, and we do not find any advertisement in the "Horticultural Directory."

Woodlice (*A. E. A.*).—There was neither a pink nor any other coloured specimen in the box on its arrival here, but from what you say we conclude that what you regard as a curiosity is *Oniscus aspidillo*, and though by no means rare it is much less common than the ordinary kind, *O. asellus*.

Pelargoniums for Winter (*M. M.*).—Some varieties are better adapted for winter flowering than others. The plants you have ready for potting would, if grown as advised on page 299 last week, be very suitable for the purpose in view, choosing as far as possible the most floriferous varieties. If you thoroughly wash the cans immediately the weed killer has been used no ill results will follow. Mind you do not destroy Box or any other edging plants as well as weeds.

Cutting down Vines (*A. J. L.*).—You must not cut down the Vines now, but the canes ought to have been shortened, as we have repeatedly advised, in the autumn. When that has not been done the upper growths or buds may be rubbed off gradually at this season down to where a good bud exists more than half way down the cane. See our

reply to a correspondent on page 235. We fear you are not such a close and attentive reader of the *Journal of Horticulture* as you ought to be.

Tasmanian Apples (*W. M. B.*).—In a list of varieties of Tasmanian Apples, sold by auction last week, we observe there were six times as many cases of Ribston Pippin as of any other varieties, those following in relatively greatest bulk being Adams' Pearmain, Scarlet Pearmain, French Crab, Sturmer Pippin, Alexander, Scarlet Nonpareils, and some others not grown in this country. Perhaps the next cargo may be different, both in varieties or the relative proportions of those enumerated. We have noticed a considerable number of Cox's Orange Pippin and King of the Pippins in some fruiterers' shops. We have no list of Pears.

Pears not Ripening (*F. H.*).—If such fruits as you have sent had each been wrapped in tissue paper and placed in a sweet, closely fitting box they would have ripened, especially if brought into a warmer place than they have been kept in. By adopting the method advised a week or two after gathering the fruit, and introducing a few at a time into a plant stove, a succession of ripe Pears may be had of any good keeping variety. The paper used must be perfectly free from newspaper ink, and the boxes sweet, or the flavour of the Pears will be spoiled.

Encephalartos caffer Outdoors (*X. Y. Z.*).—This plant is very effective in sub-tropical gardens during the summer months; but we are not aware that it has proved sufficiently hardy, even in sheltered spots or warm nooks, to pass our winters safely. Perhaps it might succeed planted out in a sheltered spot on the lawn, the site being dry in winter and protection afforded in severe weather, but that is a matter for experiment, and we should not advise it without the full consent of your employer. The plants being covered with scale would enjoy a sojourn outdoors in summer, say from June to September inclusive; they will be much freshened, and the scale, perhaps, washed off by rain. It may be destroyed by brushing the affected parts carefully with methylated spirit.

Raising Irises from Seed (*Somerset*).—Sow the seed in sandy soil, preferably as soon as ripe, in pans or boxes, placed in a cold frame, keeping the soil moist. Sow thinly to prevent disturbing the seedlings, but they may be gently raised when large enough and pricked off a few inches apart. After June they should have full exposure, and for safety may be wintered in a frame, planting them out the following spring, or preferably assigning them their flowering quarters in autumn, protecting the roots with a mulch of cocoa-nut fibre refuse. Efficient drainage must be given, and the less the roots are dried the better. The situation should be fully exposed to the sun, yet protected from easterly or strong winds. Roots sufficiently strong for flowering may be expected after three years' growth.

Mentzelias (*Idem*).—The *Mentzelias* are hardy, annual, biennial, or perennial herbaceous plants, closely allied to *Bartonia*, the flowers being orange or white, solitary, racemose or cymose, opening only during sunshine. They grow 1 to 2 feet high or more in rich soil. The species are showy and well worth growing. Any ordinary garden soil suits them, and the seed may be sown early in April where it is to remain; but in dealing with doubtful species it is desirable to raise the plants in gentle heat in spring, and when the seedlings are sufficiently large they should be placed singly into small, well drained pots, keeping them near to the light, not too close and not giving too much watering. Some of the seedlings could be planted out, others kept in pots and wintered, if not annuals, on a dry shelf in a cool greenhouse or protected frame, planting out the following spring after well hardened.

Sweet Potatoes (*A. J. L.*).—It is not necessary to strike the tops of *Batatas edulis* if you can keep the growths healthy and comparatively short by not starting them too soon in a warm and more or less shaded place. A frame on a mild hotbed is very suitable for them, starting them towards the end of the month, or in May, in a temperature in which Kidney Beans would grow steadily. If the growths get too advanced it would be advisable to strike cuttings just as you would Dahlias, and treat the plants similarly till they can be planted out in June. They require rich soil and a warm position, and we prefer placing sticks for supporting the growths to allowing them to trail like Vegetable Marrows, but you might try both methods. They are very tender and require to be prepared with care, and not planted out till the weather is suitable for planting Vegetable Marrows.

Camellia and Tacsonia Leaves Spotted (*X. Y. Z.*).—The brown spots are caused by the sun acting powerfully upon the parts whilst wet, or excessive evaporation from their surface when covered with water. It may be caused by drip or condensed moisture falling upon the leaves. Washing them will not prevent the spotting, but a freer circulation of air would be beneficial, especially in the early part of the day. This, we presume, is impracticable, as the roof being opaque, ventilation in that part is not provided for, which is sufficient to account for the spotted condition of the leaves through the moisture accumulating at the back part of such unsuitable structures for plant growth. A solution of 2 ozs. of Gishurst compound to a gallon of water is quite strong enough for washing the leaves, and you could not have a better substance for the purpose. We do not know the soap you mention, and therefore cannot give any information as to its employment with petrolcum.

Peach Leaves Scorched (*J. E.*).—The leaves are very thin and badly scorched; in fact, the tissues are destroyed—skeletonised, the injured parts being separated from the living. It has been caused by excessive fumigation, and the destruction of the leaves causes the

tender fruits to fall, only those leaves and fruits remaining which have better substance and denser cuticles than those submitted to us. There is no remedy; the only thing is to admit air more freely and secure better textured foliage, avoiding over-fumigation in future. It is better to fumigate on two or three consecutive evenings moderately than spoil a year's crop of fruit by an overdose. Peach and Nectarine trees are very liable to injury by fumigation from the time the leaves commence unfolding up to the fruit stoning, but if care be taken to fumigate moderately, to have the foliage dry, and deliver the smoke cool no harm results; and fumigation, all points considered, is the most effectual means of annihilating aphides and thrips.

Camellia Flower Buds not Opening (R. F.).—The defect is peculiar to some varieties, particularly the large flowered. We have found it more associated with plants that set their buds early and commence developing in the winter, when the temperature of the structure in which they are growing is low and moist. The only thing we can suggest is to secure a free root action, repotting in fresh soil, and in this case use the top inch of fine sward where the soil is light, tearing it up roughly and potting firmly. This should be done immediately the flower buds are set or just showing, say the size of peas, at the points of the shoots. This will insure a vigorous root action, and the buds being well thinned the flowers will generally expand the following winter or early in spring. A genial temperature of 50° will assist the buds to swell kindly after they commence enlarging for flowering. Sometimes we have found liquid manure from cow or sheep manure assist the swelling buds and expanding flowers, also to produce and mature stout wood and plump buds.

Vine Leaves Warded (E. G. B.).—The leaf sent shows its tissues to have received a check during formation, and this may have arisen from excessive evaporation from its surfaces by a too free admission of air, especially after a period of dull weather, during which the house had been kept close and moist. This, combined with the Vines having to make their growth in a house along with established Vines started somewhat early, is sufficient to account for the condition of the leaf and the difference between the foliage of the recently planted and older Vines. The latter having more abundant roots and stored matter would better withstand climatic vicissitudes than those recently planted which had fresh roots to make before they would be able to support the growth forced from them by the hasty excitement. There is no organic disease nor any trace of insect pests. Perhaps the soil has been kept too moist for the speedy formation of roots. There is a great lacking of chlorophyll in the leaves, due either to defective root action or a deficiency of soil constituents. Afford more air, encourage lateral growth, and surface dress with superphosphate of lime five parts and nitrate of potash two parts, mix, and apply at the rate of 4 ozs. per square yard, washing in moderately with water at 90°.

A Garden Difficulty (S. J. A.).—We perceive what you require, and our reply of last week was by no means irrelevant, and if it does not afford you serviceable hints it will not be lost sight of by others, and possibly not by yourself. We do not know whether the extent and character of your glazed structures are equal to the production of what you hope for. Their extent we cannot remember, and their character we could only appreciate if portrayed by a practical cultivator. It seems you cannot do what we first advised, and the more we depart from that advice the less we feel satisfied with our efforts. Probably the best thing you can do under the circumstances is to take the advice of a competent gardener on the spot, and he will be able to give you an idea of the capacity of your resources for meeting your desire. It is a very natural desire, and we shall be glad if the object in view can be attained. We have already said that Mushrooms well grown are profitable, as are Tomatoes, Cucumbers, Roses, Daffodils, and various other popular flowers, but it is not every man or even gardener who can make the crops pay expenses and leave a good margin beyond, though there are many who not only can but do, and especially when not hampered by the advice of persons whose experience is much less than their own. A good man might help you materially, but there could be little or no results the first season commencing from the present late date.

Cucumbers Scorching (G. G.).—Either the provision made for ventilating is inadequate, or there is some fault in management. If you had stated the length and width of the house, also its height at the back and in front, as well as given the number and dimensions of the ventilators, we could have formed a more definite opinion on the case than is possible in the absence of information on those points. As a rule plants in flat-roofed houses scorch less than in structures having steep roofs. You, perhaps, do not commence ventilating soon enough, and so as to prevent a great and sudden rise in temperature. Allowing it to rise unduly, then endeavouring to lower it, is the worst practice that can be resorted to. You do not, however, state what temperature is reached. If you write again, please do so as registered by a shaded thermometer. We have never found it necessary to shade Cucumbers (grown in sound loam mainly, and which by judicious ventilation produce stout foliage) except on the return of bright weather after a dull period, and then only lightly for a day or two. We should not like to employ permanent shading of any kind regardless of weather, but should use a net or tiffany blind occasionally if we could not otherwise preserve the foliage. Possibly you do not use water enough, and both the soil and atmosphere might with advantage be kept more moist. We have seen tons of Cucumbers grown in houses which have no ventilators, but the quantity of water applied would probably astonish you. The houses

resemble a tropical swamp, and there is no scorching, because not sufficient evaporation from the leaves to cause their collapse. When the escape of moisture from them largely predominates over the supply to them from the roots scorching follows, not otherwise. Your Tomatoes need either a good deal more air, or an earlier supply, especially through the ventilators at the top of the house. Shading the plants would aggravate the evil of tall weak growth.

Names of Fruits.—The names and addresses of senders of fruit to be named must in all cases be enclosed with the specimens, whether letters referring to the fruit are sent by post or not. The names are not necessarily required for publication, initials sufficing for that. Only six specimens can be named at once, and any beyond that number cannot be preserved. (*Subscriber*).—London Pippin. (*Allan*)—1, Lane's Prince Albert; 2, Bramley's Seedling; 3, Cockle's Pippin. The Pear is Easter Beurré.

Names of Plants.—We only undertake to name species of plants, not varieties that have originated from seed and termed florists' flowers. Flowering specimens are necessary of flowering plants, and Fern fronds should bear spores. Specimens should arrive in a fresh state in firm boxes. Slightly damp moss, soft green grass or leaves form the best packing, dry wool the worst. Not more than six specimens can be named at once, and the numbers should be visible without untying the ligatures, it being often difficult to separate them when the paper is damp. (*S. K.*).—*Pulmonaria angustifolia*. (*J. B.*).—1, *Adonis vernalis*; 2, *Anemone fulgens*; 3, *Anemone nemorosa*; 4, *Saxifraga oppositifolia*. (*R. J. M.*).—1, *Narcissus cyclamineus*; 2, *Narcissus pseudo-narcissus minimus*; 3, *Narcissus odoratus plenus*. (*T. H. S.*).—*Pholidota imbricata*.

COVENT GARDEN MARKET.—APRIL 22ND.

BUSINESS improving, and all classes of goods readily cleared.

FRUIT.

	s.	d.	s.	d.		s.	d.	s.	d.	
Apples, $\frac{1}{2}$ sieve	1	6	to	6	0	Lemons, case	15	0	to 20	0
" Nova Scotia and	1	0				Oranges, per 100	4	0		9
Canada, per barrel	15	0		26	0	St. Michael Pines, each..	3	0		8
Grapes, New, per lb.	5	0		7	0	Strawberries, per lb. .. .	3	0		8
Kentish Cobs	40	0		50	0					

VEGETABLES.

	s.	d.	s.	d.		s.	d.	s.	d.	
Artichokes, dozen	0	0	to	0	0	Mushrooms, punnet .. .	1	6	to 2	0
Beans, Kidney, per lb. .. .	1	0		1	3	Mustard & Cress, punnet	0	2		0
Beet, Red, dozen	1	0		0	0	Onions, bushel	8	0		4
Brussels Sprouts, $\frac{1}{2}$ sieve	3	0		4	0	Parsley, dozen bunches	2	0		8
Cabbage, dozen	3	0		0	0	Parsnips, dozen	1	0		0
Carrots, bunch	0	4		0	0	Potatoes, per cwt.	3	0		4
Cauliflowers, dozen	3	0		6	0	Rhubarb, bundle	0	2		0
Celery, bundle	1	0		1	3	Salsafy, bundle	1	0		1
Coleworts, doz. bunches	2	0		4	0	Scorzoner, bundle	1	6		0
Cucumbers, doz.	3	0		5	0	Seakale, per bkt.	2	0		2
Endive, dozen	1	0		0	0	Shallots, per lb.	0	3		0
Herbs, bunch	0	2		0	0	Spinach, bushel	5	0		6
Leeks, bunch	0	2		0	0	Tomatoes, per lb.	1	6		2
Lettuce, dozen	3	0		3	6	Turnips, bunch	0	0		0

AVERAGE WHOLESALE PRICES.

CUT FLOWERS.

	s.	d.	s.	d.		s.	d.	s.	d.	
Arum Lilies, 12 blooms .. .	2	0	to	4	0	Mimosa (French), per				
A-lea doz. sprays	0	6		0	9	bunch	1	3	to	1
Bouvardias, bunch	1	0		1	6	Narciss (Paper-white),				
Camellia, white, per doz.	2	0		4	0	French, doz. bunches .. .	4	0		6
" red	1	0		1	6	Narciss (Various) dozen				
Carnations, 12 blooms .. .	1	0		2	0	bunches, French	2	0		4
Christmas Roses, dozen	0	0		0	0	Pelargoniums, 12 trusses	0	9		1
Cineraria, 12 bunches .. .	6	0		9	0	" scarlet, 12 bnchs	6	0		9
Cyclamen, doz. blooms .. .	0	3		0	6	Poinsettia, dozen	0	0		0
Daffodils, doz. bunches .. .	2	0		6	0	Primula (double) 12 sprays	0	6		1
Eucharis, dozen	3	0		6	0	Primroses, dozen bunches	1	0		1
Gardenias, per doz.	2	0		4	0	Roses (indoor), dozen .. .	0	6		1
Hyacinths doz. sprays .. .	3	0		4	0	" Red (English) per				
Hyacinth (French) dozen	12	0		15	0	dozen blooms	4	0		6
bunches	12	0		15	0	" Red, 12 bls. (Fench.)	2	6		4
Lapageria, 12 blooms .. .	2	0		4	0	" Tea, white, dozen .. .	1	0		3
Lilac (French) per bunch	5	0		6	0	" Yellow, dozen	3	0		6
Lilium longiflorum, 12	4	0		6	0	Snowdrops, doz. bunches	1	0		3
blooms	4	0		6	0	Spiraea, per bunch	0	6		0
Lily of the Valley, dozen	0	6		1	0	Tuberose, 12 blooms .. .	1	6		2
sprays	0	6		1	0	Tulips, per dozen	0	9		1
Maidenhair Fern, dozen	4	0		9	0	Violets (Parme), per bch.	3	0		4
bunches	4	0		9	0	" (dark), per beh. .. .	2	9		3
Marguerites, 12 bunches	4	0		6	0	" (English), doz. bnch	0	9		1
Mignonette, 12 bunches .. .	3	0		6	0	Wallflower, doz. bunches	1	6		2

PLANTS IN POTS.

	s.	d.	s.	d.		s.	d.	s.	d.	
Aralia Sieboldi, dozen .. .	6	0	to	18	0	Hyacinths, doz. pots .. .	6	0	to	10
Arbor Vita (golden) doz.	6	0		8	0	Hydrangeas, per doz. .. .	12	0		15
Azalea, per plant	2	0		3	6	Lilium longiflorum, per				
Cineraria, per doz.	6	0		9	0	dozen	12	0		18
Cyclamens, per doz.	12	0		24	0	Lily of the Valley, per pot	1	0		2
Dielytra spectabilis, per	8	0		12	0	Marguerite Daisy, dozen	6	0		12
dozen	8	0		12	0	Mignonette, per dozen .. .	6	0		10
Dracena terminalis, doz.	24	0		42	0	Myrtles, dozen	6	0		12
" viridis, dozen	12	0		24	0	Palms, in var., each. .. .	2	6		21
Erica, various, dozen	12	0		18	0	Pelargoniums, per doz. .. .	12	0		13
Euonymus, var., dozen .. .	6	0		18	0	Pelargoniums, scarlet, per				
Evergreens, in var., dozen	6	0		24	0	dozen	6	0		9
Fairy Roses, per doz. .. .	12	0		15	0	Primula sinensis, per doz.	4	0		6
Ferns, in variety, dozen .. .	4	0		18	0	Solanums, per doz.	9	0		12
Ficus elastica, each. .. .	1	6		7	0	Spiraea, per doz.	10	0		12
Foliage plants, var., each	2	0		10	0	Tulips, dozen pots	6	0		8
Genista, per doz.	10	0		12	0					

Bedding plants (in variety) in boxes, from 1s. to 3s.



THE GRASSY MIDLANDS.

"OUT of cultivation" was the term so frequently used in reference to land laid down or let down to grass under the agricultural depression. Exception was taken to the term as implying utter negligence of pasture, and that is really what it did point to, as anyone travelling through the Midlands in this present month of April can see. Certainly we do so as we sit down to write this article at a farmhouse in the very heart of the Midlands on the morning of April 17th. From the window the land trends gently downwards to the bottom of a valley, whence it as gently ascends in grassy undulations to the sky line. Pasture and nothing but pasture is in sight; but the prospect, though lit up by bright sunshine, is not attractive, for the uniform grey hue of the pasture has a sad depressing effect. It tells only too plainly of the negligence of the farmer and of the poverty of the land.

Not so, says the farmer himself. He will tell you of a severe drought last autumn, of a long hard winter; and if you speak to him of what is possible under the systematic cultivation of his pasture, your statements are received either with an air of incredulity, or with that "smile superior" which shows that he does not believe you. Well, whether he does or not, we are bound to regard very much of the practice of the Midland graziers as farming gone wrong, and to explain why we do so.

When the permanent character of the reduction in the price of corn was evident, it was only prudent to lay down much of the land to pasture. Equally prudent would it have been to have adopted a regular system of culture, both to insure the speedy formation of really good pasture and its subsequent maintenance in the highest possible condition of productiveness. The best evidence that this was not done is found in its present condition. If the soil was as rich in fertility as it ought to be, no severity of weather would impart that brown or grey colour. It is a want of fertility, which may be read like an open page of a book, wherever we turn, and this sterility is just owing to the suicidal practice of close grazing without anything like an equivalent application of manure. Most of what manure the land does have is from the cattle droppings, which are spread about and worked in by bush or chain harrows at this season of the year. Such a dressing is most inadequate to impart or sustain fertility, and the pasture never yields anything like a full crop. It is probably owing to the heavier bulk of crop of a wet season that the crop generally has come to be regarded as a thing of seasons, but such an idea is altogether erroneous. It is more—it is mischievous; for its tendency is decidedly to render the grazier a sort of easy-going waiter upon Providence.

The pity of it all is that the farmer might do so much better for himself if only he would acquire correct knowledge of the land and its requirements, and apply such knowledge in his practice. He has very little expense for labour, none for tillage, and the outlay which we advise to enrich the land need not much exceed £1 an acre; but how to induce him to venture upon it is the difficulty. Once again we ask landlords to see their interest in making the home farm a school of farming to which their tenants may find it worth while coming occasionally to get a "wrinkle" or two. Let them see how possible it is to have a full and early bite of grass, either by the judicious use of chemical manures, or by sheep folding, or by a combination of both. Tangible proof is what they require: let them have it. It is quite useless to endeavour to advise the ordinary farmer on paper. He is not much given to reading, but he can understand and take an interest

in a growing crop or fine animal. Show him that when land is really as rich in nitrogenous and mineral manure as it ought to be, the pasture, even if it is grazed closely, remains green and not brown all winter, and is always so full of growth that it is much earlier in a late spring than the ordinary poverty stricken pasture with which farmers generally seem content. Show him, too, that a full crop of hay is always possible, because rich fertile pasture under its annual dressing of manure is always so forward in growth as to be comparatively unaffected by drought. If he can be induced to treat only a single meadow, that will be sufficient, as it is quite certain to lead to regular systematic pasture cultivation.

Fluctuations in the price of cattle tell so frequently against the grazier that he has indeed ample reason to bestir himself and see what he can do in the way of obtaining better results. Home-bred well-bred stock, rich fertile pasture, ensilage, and perfect means of shelter are among the means open to him for so desirable an end. Then, too, richer pasture points to the certain possibility of an enlarged head of stock, and if only due care is taken to have it of the best, so as to ensure early maturity, it cannot fail of proving really profitable.

WORK ON THE HOME FARM.

White Wheat up to 45s. per quarter will act as an incentive to Wheat growers, and prove an inducement to spend more money upon corn hoeing than they would otherwise have done. Unfortunately the advance in price comes too late to be of much benefit to farmers, most of us having sold out long ago. But such an advance is nevertheless cheering, as affording proof of the possibility of Wheat growing becoming profitable once more. So clean is the land that we should not hoe the Wheat at all were it not for the Charlock, which we never can pass by. A single season's negligence of this weed, though it is only an annual, is sufficient to give work for a dozen years. It is, indeed, the worst pest we have, most difficult to eradicate, yet if left it robs the legitimate crop of much soil nutriment, and spreads its seed far and wide.

Grass land laid in for hay that is at all infested by Thistles should now be looked over and the Thistles destroyed. If this is not done they will prove a nuisance in the hay. Docks have been got out of a new piece of permanent pasture where the seed must have been in the soil when it was laid down. There is nothing else to be done but to uproot and burn Docks. The process is slow and costly, but it is certain and thorough.

Turnips appear to be about used up for folding. We have seen some sheep recently on an excellent growth of Kale, and Rye and Clover are now forward enough to be useful. Late lambs have much improved, but the weather continues changeable, and is very trying for weak animals. Shelter must still be afforded them, and it is a good plan always to provide enough of it in all folds or on open pasture that is liable to be windswept. We have only to place it there, and even the younger lambs will soon find it and take advantage of it. Castration and docking have been done in favourable weather, as each batch of lambs become about a month old. In folding especial care must be taken to make all hurdles secure, and all gates opening out of pasture should be locked. The very sight of green food outside of the flock enclosure is a temptation which they will try to gratify, and they often do so to the annoyance of neighbours if one is not always on the alert and the fences are not quite sound.

METEOROLOGICAL OBSERVATIONS.

CAMDEN SQUARE, LONDON.

Lat. 51° 32' 40" N.; Long. 0° 8' 0" W.; Altitude, 111 feet.

DATE.	9 A.M.					IN THE DAY.				Rain	
	Barometer at 29.2 and Sea Level.	Hygrometer.		Direction of Wind.	Temp. of soil at 1 foot.	Shade Temperature.		Radiation Temperature.			
		Dry.	Wet.			Max.	Min.	In sun.	On grass		
1891.											
April.											
Sunday	12	30.143	42.2	39.1	N.N.E.	41.7	49.1	34.6	94.4	29.0	0.143
Monday	13	30.083	41.0	37.4	W.	41.8	47.8	35.2	65.6	27.7	—
Tuesday	14	30.153	42.1	38.1	N.	41.1	50.8	39.2	101.9	23.2	—
Wednesday	15	30.210	45.0	41.8	N.W.	41.7	58.3	38.2	92.9	35.2	—
Thursday	16	30.193	49.2	44.9	W.	42.9	57.9	40.4	102.0	33.4	0.030
Friday	17	30.157	44.7	39.9	N.W.	43.3	54.4	37.0	102.4	31.4	—
Saturday	18	30.205	46.1	41.3	E.	43.6	53.2	33.6	101.1	25.3	—
		30.164	44.3	40.4		42.3	53.8	35.6	94.3	29.3	0.173

REMARKS.

12th.—Alternate cloud, sunshine, and showers; heavy rain, with hail from 3.45 to 4.30 P.M.

13th.—Overcast morning; a little sunshine in afternoon.

14th.—Brilliant early, and generally fine; but little sunshine in afternoon.

15th.—Fine, and generally bright; but cloudy at times in afternoon.

16th.—Brilliant early, but generally cloudy after 11 A.M.; showers in evening.

17th.—Brilliant morning; cloudy at times in afternoon.

18th.—Bright and pleasant.

Barometer still high, rainfall deficient, and temperature below the average.—G. J. SIMONS.



HARDY FLOWER NOTES.

APRIL is now drawing to a close, but so far this fickle month has been unmindful of its reputation for smiles and tears. The smiles have been few, and the tears, so much desired, fewer still. Despite the want of rain and the low temperature which has prevailed, the garden of hardy flowers from day to day unfolds some fresh beauty to our eager eyes, and gives its owner fresh cause to regard with gratitude the happy inspiration which led him to the culture of flowers like these.

There is now the beauty of foliage and flower. Here the bright yellow leafage of *Valeriana Phu aurea* shines like a sheet of gold in the border; there a clump of *Hemerocallis fulva* presents another shade of yellow, clumps of *Tradescantias* shine with a brilliant deep purple, and the greys and the greens of the *Saxifrages* and many other plants touch us with their beauty.

Sheets of *Arabis albida*—beloved of the bees—are like belated masses of snow which have lingered too long with us this season; but if one did believe the illusion it would be dispelled by the humming of the industrious little insects as they hover over the flowers or draw from their honey-bearing recesses the nectar they bear cheerily to their stores. Had we but seasonable weather there would be no lack of supplies for the bees. But I am afraid I am trespassing upon the preserves of my fellow countryman who is so great an authority upon the subject, and must turn to other things.

The sight of *Primulas cashmeriana* and *denticulata* growing near each other reminds me of the late *Primula* election, where these two species occupied very different positions at the poll. I must contest the decision which would place *cashmeriana* far below *denticulata*. For some years I have accounted the former the superior species, but this year for the first time I feel undecided. *P. denticulata* has, I think, been finer than I have ever seen it. The colour is not so deep as *cashmeriana*, but it is more refined. I am here speaking of the superior form of *denticulata*, that known as *P. d. purpurea*. *Primula nivea* is very fine at present. I believe I am correct in giving this name to this beautiful little white flower. It is generally known as *nivalis*, which I understand is erroneous. *Nivea* also expresses better the snowy whiteness of the flowers. The *Muscaris* are very attractive at present. I have only made the acquaintance for the first time of *M. Heldreichi*, a Greek species, which is, to my mind, one of the finest of the Grape Hyacinths. It is much taller than the ordinary *M. botryoides*, and is of a beautiful sky blue colour with a white mouth. I have noted it from the time it commenced to open, and my admiration has increased daily. It seems to be perfectly hardy. It recalls to one's mind what Ruskin says of one or other of the genus:—"The Grape Hyacinth, which is in South France as if a cluster of Grapes and a hive of honey had been distilled and pressed together into one small boss of celled and beaded blue" (Queen of the Air.) There are many notices of flowers in the works of this master of the English language which flower lovers would do well to study. I know of nothing finer in its way than his description of the "zone of blue" formed by a mass of one of the *Gentians*. I came upon this in "*Frondes Agrestes*," and the memory of the delight experienced on reading this passage for the first time is as fresh with me as ever. It is to be regretted that the *Muscaris* are not in more general cultivation. *M. botryoides* is, it is true, like a

weed for increase, but it will grow anywhere, and the fine tone of its blue flowers is very welcome in the garden; very desirable, too, are its white, pearl-blue, and flesh coloured varieties. Of the first there are two forms, one of which, known as *album grandiflorum* or *maximum*, is much superior to the other. My variety is the, small form, which has small close bells, and although good in its way is inferior to the larger variety. Several other Grape Hyacinths, such as *M. atlanticum* and *M. armeniacum*, are worthy of notice, and I hope in time to give the genus more careful study than hitherto.

The *Narcissuses* are coming rapidly forward. Whatever the weather may be the Daffodil never fails us. As Swinburne says:—

"For all the storm saith, still
Stout stands the Daffodil.

* * * * *
Erect, a fighting flower,
It breasts the breeziest hour
That ever blew."

And looking through my small collection of some fifty kinds one is almost disposed to say that *N. obvallaris* comes as near as may be to the "fighting flower" of the poet. Although it is comparatively cheap it can also hold its own as regards beauty with any of its compeers. It lacks the massive proportions of Emperor or Sir Watkin, but it is of exquisite form and colour. The chaste little *N. moschatus* (true), is also in flower on the rockwork. I have grown this for the last two years, and find it perfectly hardy here. Alongside *N. cyclamineus* and *N. triandrus albus* have perished, but it holds its own and increases. It is a little flower which, for purity of colour and modest beauty, can hardly be excelled. One would think that the author of "*The Rose Garden of Persia*" had this drooping beauty in view when penning the lines:—

"The fair Narcissus, humble still,
Reflecting on her lowly birth,
And feeling Nature prone to ill,
Inclines her soft eyes to the earth."

But one must leave the Daffodils for the present, although there is constantly at this season much of interest in a small but typical collection.

Many alpine are coming rapidly forward. *Anemone blanda* and its white variety *A. blanda alba* are past for some time. Both are very desirable, although the former is, I think, more pleasing in every way. I have not yet seen the rose-coloured form, which will probably be an acquisition. One of the choicest alpine I have met with for some time was *Synthryis reniformis*, which was in flower a short time ago in the collection of Mr. James Davidson of Summerville, Dumfries. It is a perfect gem in its way, growing about 6 inches in height, with thick, fleshy, glossy stems and leaves. The leaves are alternate, reniform, and elegantly notched. The flowers are produced in a large head, and are of a beautiful light blue with projecting deep blue anthers. This *Synthryis* is said to be quite hardy, and if it should prove so it will be a most desirable plant. It is a native of North America, and belongs to the natural order *Scrophulariaceæ*.

Cardamine trifolia, syn. *C. trifoliata*, a pretty little cruciferous plant, is now in flower, and although it prefers a moist shady position is doing well with me in dry soil with partial exposure to the sun. It is not by any means a showy plant; but this objection may be taken to many of our alpine flowers. *C. trifolia*, which is the name given to the plant by Linnæus, is so called from its pleasant dark green Trefoil-like leaves, which form compact tufts. The flowers are numerous produced on stems which seldom rise above 6 inches in height. These flowers are white with waved edges. This three-leaved Bitter Cress or Ladies' Smock is, as may be understood, a relative of the common Ladies' Smock, *C. pratensis*, which ornaments many of our meadows and roadsides with its pretty white or

pink flowers. The double form of this is a neat garden flower also. *C. trifolia* is an old plant in our gardens, having been introduced from Switzerland in 1629. Parkinson tells us that "It was sent me by my especial good friend John Tradescante, who brought it among other dainty plants from beyond the seas, and imparted thereof a root to me." One can almost fancy seeing Parkinson and Tradescante meeting and comparing notes on the various novelties collected by both hardy plant growers.

Calliprora flava and *Bloomeria aurea* are two pretty bulbous plants, but must be noted as being of doubtful hardiness. With me both have succumbed to the severity of the past winter. The *Calliprora* which survived the winter of 1889-90 is, I fear, lost, and the *Bloomeria*, after making top growth, has rotted off close to the neck of the bulb. It is unfortunate that this is so, as the beautiful yellow flowers are very desirable. Both are natives of the United States.

I see Primrose Munstead Early White has been exhibited at one of the recent meetings of the Floral Committee of the Royal Horticultural Society, and has been favourably noticed by the horticultural press. Miss Jekyll very kindly sent me a few plants last year, and I can speak very favourably of the variety on account of its earliness, compact habit of growth, and purity of colour. Where spring flowers are bedded out it will be a most useful plant. The stems are not so long as some, and for cutting from I have a fine seedling of my own which I should prefer. If Munstead Early White should come into the market lovers of the "fragrant Primrose" should secure it.

Now that the Crocuses and *Bulbocodiums* have spent all their beauty for the season *Romulea Bulbocodium grandiflora*, which is not unlike them, has come into flower. The flowers are small, bright purple with a yellow base, and have sharply pointed petals. The leaves are grass-like in appearance, and are produced before the flowers. It has done well with me in light sandy soil planted about 3 inches deep, and has been without protection during winter. The flowers last only about a day, but as several are produced in succession a few plants last in bloom a considerable time.

I suppose the plural of *Eremurus* should be *Eremuri*, but it is probable that *Eremuruses* will be the one in general use. I have not met with any of these noble plants in bloom so far north as yet, but if they do not flower in the neighbourhood of Dumfries before long it will not be the fault of some of the ardent lovers of hardy flowers, who are now fast increasing in number there. I am afraid, however, that none of the several plants in this locality are looking particularly happy. They appear to make growth too early, and to feel keenly the unkindly breath of this backward season. The tops of the leaves become brown, and further down yellowish. Few of the plants sold by nurserymen appear to be of a flowering size, and patience seems to be needed while waiting for flowers. My plant is *E. robustus*, and this and *E. Olga* and one or two others are also in the district. Should anyone attempt to grow these from seed I should advise cutting through the hard outer cuticle of the seed. This will save nearly a season. Seedlings will be some years before they flower. I shall be glad to hear the experience of some growers of these fine plants.—S. ARNOTT.

[Our correspondent appears to have been favoured in the abundance of his outdoor flowers; here in the south they are making but slow progress, and even the Primroses are generally later and inferior to previous seasons.]

MAKING SHOULDER-SPRAYS AND BUTTON-HOLES.

In the majority of private gardens there is a great demand for these, and all young men should make the most of the opportunities they have of becoming adepts in this pleasant branch of their calling, as next in importance to the ability to grow fine plants is the art of displaying flowers to advantage.

Another point to be considered, which requires tact and judgment, is to study the taste of those we have to please. Individuals differ so much in the colours they prefer and the type of spray or button-hole which comes up to their idea of perfection, that perhaps the true secret of success lies in possessing the necessary acumen to discern correctly the style that each prefers, and shape our course accordingly, rather than keep too closely to rules generally considered as standards of correct taste. Where sprays and button-holes have to be provided at the dinner table every night, if close attention is given to the matter the necessary knowledge is soon acquired, and I trust these remarks may prove useful to many who desire information.

All flowers and foliage used should be wired, as it is not only a saving of material, but each flower or Fern frond when wired can be bent into the exact position desired; without wiring this is impossible. Among Ferns *Adiantum cuneatum* and *A. gracillimum* continue to hold their own as the most suitable for the purpose; the fronds should be as ripe as obtainable, otherwise the beauty of the flowers is marred by withered Fern before the evening is over. Where there is a good quantity of *Asparagus plumosus* or *A. tenuissimus* to cut from these are preferable to Fern, on account of their lasting qualities, though many give the preference to Maidenhair Fern as far as appearance goes. For balls and parties the *Asparagus* should certainly be used, as it may be depended upon to last even longer than the flowers.

In regard to the arrangement of colours a mistake frequently made is to use too many in each individual spray. This often renders them less effective than they should be, and where an accurate knowledge of the principles that govern the art of colour blending is not possessed it is by no means easy to steer clear of offending the eyes of ladies who have a thorough knowledge and correct taste in the matter. This difficulty may, however, be overcome by using only one variety of coloured flowers, with the addition of a few white ones and the usual greenery for each spray, such, for instance, as rose, pink, scarlet, or crimson; these make simple yet still very effective combinations. But it is not at all times desirable to use these simple arrangements, as in the case of orange and yellow coloured flowers these require the addition of blue or purple to be thoroughly effective, although unfortunately the last named colours have the disadvantage of not exhibiting their full beauty under artificial light. Some years ago I learnt the following pithy remarks upon this subject, which have been of great service since:—"Pink should be separated from violet, scarlet, and crimson, orange from orange-yellow, and blue from mauve."

Another reason why many colours should not be used in each spray is that by so doing it is more difficult to give a distinctive character to each spray where numbers have to be made. I find that, as a rule, salmon and rose are preferred to pink, and deep scarlets to bright ones. Single pips of the many beautiful shades of Ivy-leaved *Pelargoniums* are exceedingly useful for cutting, and deserve to be extensively cultivated for that purpose alone, although they are also greatly admired when used in many other ways.

An important point to be observed in all floral arrangements is to pay due regard to form. This has a wonderful effect in giving finish. Colours may be ever so well arranged, if lightness and variety of form are wanting formality is the result. Small sprays of *Spiraea japonica*, Lilies of the Valley, Jasmynes, *Bouvardias*, *Cyclamens*, *Begonias*, and many Orchids supply flowers that give good variety of form. In making them up care should be taken not to overcrowd them. Let each flower stand well clear of the other, with a few light sprays of *Spiraea* or *Oncidium flexuosum* coming up between, and protruding behind to give a light surface, using plenty of Fern to set the flowers in and hide wires. Some prefer sprays to be full in the middle, while others like them somewhat flat, so that they fit close to the dress when worn. These are matters of taste which have to be considered. One end of each spray should be rather tapering, gradually becoming fuller towards the other end, where it should be fullest, being finished off with good Fern fronds to hide the stem. In other cases both ends may be made tapering, and the spray fullest and widest in the centre. This can be accomplished by working in the usual way till the fullest portion is completed, then the other end should be started as if it were to form a separate spray. When long enough fit up to the portion already made, and fasten the two stems underneath with wires. With a little practice this can be done in a very neat manner. The finishing touch is given by looking over each spray, and when the flowers appear crowded bending them apart from each other, and so regulating them that they point in different directions to take off anything approaching a formal style. In doing this the advantage of having each flower wired is very apparent.

For buttonholes a Rose bud set in a leaf, a *Gardenia* with three of its own leaves or Fern placed around it, or a *Carnation* or

Encharis similarly treated are preferred by the majority to examples made up of several flowers, although there are endless combinations of various kinds which may be made up into tasteful buttonholes. Single pips of Hyacinths wired, double Primulas, Pelargoniums both single and double; any of these with a spray of Spiræa at the back, a few Violets or pieces of Mignonette added, and some Fern arranged neatly around them are very effective. Five or six Lilies of the Valley arranged loosely and fastened to a leaf, or three pips of Tuberosæ surrounded with greenery are generally greatly liked. All sprays or buttonholes should be scented, and although I have touched upon this point last it is none the less a very important one, as whenever either are presented they are instinctively held up to the nasal organ, and a sense of disappointment quickly results if no scent is detected. Violets, Heliotrope, Mignonette, Boronia megastigma, scented-leaved Pelargoniums, the Lemon-scented Aloysia, and Sweet Peas, besides a host of other flowers in addition to those already mentioned, will supply scent at various seasons, and if at any time the scented flowers used do not harmonise in colour with the others, which must of necessity be employed, they may be placed underneath them, and be partially hidden by Fern, and though thus placed in the background where their charms cannot please the eye, their delightful fragrance will not fail to give pleasure.—D. L.

CULTURE OF THE BEETROOT.

THE Beet is a hardy biennial, it is a native of the seaboard of the South of Europe, and numerous varieties have been raised. Where seed is saved from two or more varieties growing a short distance from each other the seedlings will partake more or less of the character of both or all. Hence the multiplicity of new and mixed varieties, some of which are improvements on the old varieties, whilst many others would be better left out of the lists altogether. The following, however, may be depended upon:—Pine Apple Short Top is a dwarf, compact-growing variety, having leaves 6 or 7 inches high, dark purple, the stalks tinged with dull orange; roots 6 to 9 inches in circumference, flesh deep crimson; when cooked tender, sweet, and well flavoured. Sutton's Blood Red produces medium-sized symmetrical roots; the colour of the flesh is dark, and the flavour when cooked is everything that could be desired. This variety produces dark rich crimson leaves. Carter's Perfection, Pragnell's Exhibition, Hooper's Covent Garden, Frisby's Excelsior, and Nutting's Dwarf Red are also most reliable varieties.

Soil and Situation.—Beet will do well in any light, deep, and moderately rich soil, but the latter should not contain traces of any recent or strong manure, inasmuch as a rank soil or one which has been dressed with animal manure shortly before sowing the seed will yield coarse roots. Therefore the seed must be sown in an open plot of ground which had been well manured the previous year. The best results will be secured from seed sown in a light loamy soil away from the shade of trees. It requires an open situation.

Preparing the Soil.—Let ground be deeply dug some time before sowing the seed, to be rendered mellow by exposure to the weather. If the soil is of a healthy nature it should have some chalk or leaf mould added as soon in autumn as the space is cleared of the summer crops, and ridged up for the winter. Take advantage of dry weather to level down the ridges, and dig the whole regularly just before sowing, treading the soil firmly as soon as it has been dug, raking and making it level preparatory to sowing the seed.

Seed and Sowing.—A small sowing may be made in warm districts towards the end of March, with a view to securing roots for use between those of the previous year and those from the main sowing of the current year. This sowing, however, will run the risk of being destroyed by late spring frosts. The seed can be sown in drills from 1 to 2 inches deep, and from 12 to 15 inches apart. The seed—assuming it to be good—may be sown about 2 inches asunder in the row. The soil should then be closed in with the feet, trodden and raked over. If the soil is heavy 1 inch will be deep enough for the drills, and if light 2 inches will be none too deep. The main sowing may be made the third week in April in warm districts, and a week or ten days later in less favoured parts.

After-treatment.—When the young plants are large enough to handle they should be thinned from 6 to 9 inches apart in the row, and if it is necessary to extend the crop the thinnings may be transplanted in ground prepared as recommended for the reception of the seed and at the distances indicated, doing the work in showery weather, and taking care that the roots of the individual plants are not bent in transplanting. If the weather happens to be dry at the time, with no immediate prospect of rain, the plants should be watered when transplanted and every other afternoon, more with a view to refreshing the plants until they have taken hold at the roots than moistening the soil about the latter. Keep the plants free from weeds, the Dutch hoe being run between the rows occasionally during the summer months, both for the purpose of destroying weeds and stimulating growth.

Taking up and Storing the Roots.—Towards the end of October the roots should be stored, selecting a fine day for the work, when the plants and ground are dry. In order to preserve their freshness the roots should be packed in damp material which will not tend to absorb the moisture from them, and for this purpose the following is the most simple and effectual method:—The roots must be taken up before they

are injured by frost, and with care, avoiding breaking or wounding them in any way, as that would cause them to bleed, and consequently to lose their colour. They should be taken to a dry situation, such as, for instance, a border next a south or west wall or wooden fence. Earth should be taken out at the end of the border, so as to form a trench 12 or 15 inches deep and about the same width, digging the ground being proceeded with. When the trench is filled and the ground has been levelled in the ordinary way the soil should be cut straight down the whole width of the border, and two or three rows of Beetroot be placed perpendicularly in the opening thus formed, and digging be again proceeded with until the roots are all covered, burying the crowns about 1 inch under the surface of the soil. The operation is thus continued until the work is completed. The leaves should not be removed from the crown of the root; they will afford sufficient protection for the roots from several degrees of frost, but in the event of its being severe a protection of dry litter or fern will be necessary; this should, however, be removed on every favourable opportunity, and returned in frosty weather. In the spring, before the roots show signs of growth, they may be taken up, the leaves (with the exception of those roots intended for seed), with a portion of the crown cut clean away, and the roots laid in again as before. The roots will thus keep fresh and of good colour.

Saving Seed.—About the end of the third week in April the necessary number of roots of any variety of which it is intended to save seed should be planted from 12 to 15 inches asunder at the foot of a south wall, to which the flower spikes should be secured in due time with a length of string or thin flower sticks tacked to the wall or fence with a few nails and shreds, so as to expose the flowers well to the sun, as well as to prevent the plants from being broken by the wind. The roots must be watered as soon as they are planted, to settle the soil about them. Some time between the middle and end of October, according to the season, the flower spikes should be cut, tied together in small bundles, and hung up in a dry airy shed, to be rubbed out and cleaned a month or two later, and put away for future use.

Insects.—The roots of young plants are sometimes attacked by the grubs of the dart moth (*Agrotis segetum*). This may be prevented by hand-picking, and by strewing sufficient fresh soot over the ground to cover it before drawing the drills for the seed.—H. W. WARD.

CURRENT NOTES.

TOP-DRESSING POT PLANTS.

PROBABLY this practice might be carried out much more extensively than it is at present, but whether it is a good plan—except in a very few particular cases—is an open question. Personally I do not approve of it either for large specimens or for small plants. My principal objection is that when the surface soil is removed from over or amongst the top roots and new soil added in its place, it is difficult to ascertain the true condition of the lower part of the ball in regard to moisture. Sometimes the old soil will be dry sooner than the new, and *vice versa*, much depending upon the nature of the plant, the state of its roots, the mechanical condition of the old soil and of the new, and on the density of both. Under such circumstances judicious watering is a difficult matter, even in most careful and experienced hands. I cannot help thinking that an occasional dressing with artificial manure would be preferable when it is desirable to keep plants in the smallest pots for the greatest possible length of time. To prevent misapprehension, I may add that I have followed—under orders—the plan recommended by “D.” upon nearly all classes of plants in general cultivation, and upon many that are not, and by the experience gained then I have long since arrived at the opinion that it is not a practice to be generally carried out. “D.” appears to have formed an opposite opinion, otherwise he would not recommend it.

CUTTING OFF THE ROOTS OF PALMS.

I have no doubt that “D.” successfully practises the methods he sets forth, and that other people with the same knowledge, facilities, and carefulness may obtain the same satisfactory results. Probably it is quite within the knowledge of “D.” that hundreds of Palms are annually killed by the disrooting process, and mainly because the operators either do not know the conditions necessary to enable the plants to withstand that ordeal, or because they have not the facilities, or they may be lacking in both. Few, if any, plants are so unable to withstand the operation as Palms. I have seen, and had to deal with large Palms so injured that their lives were in jeopardy for a long time, indeed until new roots were coaxed from the base of the stems, and were spoiled in appearance for years. The same results attend the operation in a proportionate degree upon small Palms. The fibrous rooted withstand the operation the best, and the strongest and thickest rooted are the most liable to injury.

COOL HOUSE ORCHIDS.

Mr. Castle, in his valuable paper printed on pages 297, 298, gives the “key note” to the successful culture of this lovely section

of Orchids. The most satisfactory results are obtained with a winter temperature of 50° to 55°, and a summer temperature of 60° to 65°. The nearer these temperatures are adhered to, with a correspondingly moist and buoyant, not draughty, atmosphere, the more satisfactory will be the results. It is true that cases have been cited where numbers of these Orchids have been subjected to greater extremes of temperature with apparently satisfactory results, and it has been reported in these columns, with satisfactory proofs, where they have done well out of doors in this country; but on the whole, taking differences of latitude and variations in local conditions into proper consideration, I believe the conditions previously and briefly stated are those most suited for the most successful cultivation of cool Orchids in these islands.

CINERARIAS.

There is little doubt that the "strains" of these showy and easily grown plants vary considerably in quality, but I have no reason to think that they are deteriorating generally. Perhaps too much attention has been paid to mere size of flowers lately, but I think, given flowers the size of half a crown or a little larger, perfect in form, brilliant in colouring, freely produced, and the plants somewhat dwarf in habit—not too dwarf—say an average of 18 inches with "heads" of flower nearly as much across, and bold foliage nearly hiding the pot, there is little more to be desired from the Cineraria.

CROCUSES ON LAWNS.

Having adopted the practice some fifteen years ago of planting out under trees on the lawns Crocuses that had been forced, I can testify to the bright and charming effect produced by such masses of colour on a "setting" of green in the months of March and April. A thousand corms were forced every year, and these were afterwards planted under and around the trees each year until there were many square yards of ground so occupied. The larger the masses the grander the effect. We never found the foliage objectionable; indeed, it had the value of covering the rather bare patches under the trees until either the foliage or trees hid it from view or patches of grass grew.—HUGH DALE.

LETTUCES—LEE'S HARDY GREEN.

LAST autumn this variety was described as an excellent Lettuce for withstanding the winter, and the exceptionally prolonged one just passed has been a good test for proving the hardiness of this and different other kinds. Two sowings were made of Lee's Hardy Green, one about the 20th of August, the other about the 6th of September, in rows a foot apart, thinning the plants to about 6 or 8 inches asunder when large enough. Both sowings have withstood the winter well, but the September sown plants have proved the best, quite 90 per cent. of them being alive, and have been in use for salad since the end of March. Potatoes were taken from the land previously, and no manure used when the Lettuce seed was sown. For weeks also during the most severe frost they were well covered with snow. But to have them for salad purposes by the end of March a little special attention since the middle of February has been necessary. Some old handlights about 20 inches square that had done duty through December, January, and part of February in covering good patches of Parsley to pick from when snow covered the rest of the bed, also some clumps of *Helleborus niger*, not being wanted for that purpose any longer, were then put over the Lettuce, each handlight covering about six plants. On fine sunny mornings light sprinklings of water were applied. Heavy waterings were not required as the ground was quite wet enough underneath, but the slight waterings on the foliage promoted a moist genial atmosphere within the handlight. A little air is necessary at all times day and night. This can easily be admitted at the corners, but if any of them have a little of the glass out of the lid (as mine have) it is sufficient, and although it is almost impossible to secure good hearts so early in the season, some tender and crisp Lettuce can be had for the salad bowl after a month or so being grown under handlights. Another plan is that of placing clean 6-inch pots over each Lettuce plant, leaving the crock hole open to admit air, and allowing moisture to escape. A fortnight or three weeks under flower pots in the months of March and April very much improves them, and carries on the supply till those left unprotected are ready.

Bath or Brown Cos and Hicks' Hardy White were planted as usual a foot apart in October, but about 40 per cent. have perished, and what are left will not be fit for tying up for a few weeks yet. These three varieties were the only ones sown to stand over the winter. Twenty-eight degrees of frost was the lowest recorded. All the Year Round Cabbage Lettuce seed was sown the first week in March of the present year on a warm border, and the plants are now thinned to a foot apart. This is one of the best for summer and autumn use, and should be sown every fortnight or three weeks till August. It turns in quickly, and is ready before the spring sown Cos Lettuce.—A. HARDING.

HELLEBORUS ATRORUBENS.—A distinct form of a most interesting and useful family of spring flowering hardy plants. Nowhere does this show to better advantage than at the front of a shrubbery, backed up by

dark evergreens. Certainly no hardy plant will give a better return for the attention required to ensure a full crop of flowers during the month of April. We have several clumps in the shrubberies, which never fail to flower abundantly, in spite of the fact of their not having had any assistance in the shape of manure for the last ten years. They are freely exposed to the sun, not being overhung by trees. The flowers do not last long when cut, only a few hours, being quite different in that respect from the good old *H. niger*.—M.



DENDROBIUM THYRSIFLORUM.

WELL flowered plants of this *Dendrobium* are decidedly attractive objects at this period of the year—their natural season to flower, and being of tolerable easy culture, it is suitable alike for the specialist as well as amateur cultivators. It adapts itself very readily, as do many *Dendrobiums*, to the conditions of the ordinary plant stove, and therefore demands some notice on the part of those growers having no structures strictly set apart for the convenience of these now popular plants. They may be also purchased at a cheap rate, now they are so largely imported; and while several plants may be grown, each would possibly differ either in the shade of colour, form, or habit of the flower spike. This variety is singularly rapid in the development of its pseudo-bulb, and frequently vigorous plants will mature two, and sometimes even three, courses of growths in one year, although they do not all flower the same season. This tendency to give successive growths in one year makes it a comparatively easy matter to get a good specimen in a short space of time.

Of the several plants of this species in bloom in Mr. Porter's collection at Park House, Kingsclere, one has developed ten handsome spikes, another having unusually long pseudo-bulbs carries seven, the longest of them being nearly a foot in depth, the other racemes only slightly less than this measurement makes it a very distinct and naturally much-prized plant by its owner and grower alike. Other plants carry from five to eight spikes each, the whole making a bold and choice display. *D. densiflorum* is also represented with its uniformly coloured pendent spike, and is cherished even more greatly than the first named, though both are equally desirable and indispensable in a collection, however small it may be. Strong growths of *D. thyrsoflorum* produce two spikes often from near their extremity, but it would not appear to be so common an occurrence for three spikes to issue from one individual pseudo-bulb, at any rate not under ordinary cultivation. Being of an evergreen disposition they must not be subjected to the severe drying off that is practised in the case of some of the deciduous species, but on the full completion of their growth they are benefited by cooler treatment until the flower buds are visible in spring, and in this state less water is naturally required than is customary during the growing period. Unfortunately the flower spikes are somewhat short-lived compared with some of the others, but by placing them in cooler structures, provided with shelter from direct sunshine, and having several plants to form a succession, this failing is less observable than is the case of growers having but a solitary plant or bloom spike. But little trouble is experienced in the matter of insects, their tough leaves seemingly resenting any interference on the part of these tropical enemies so common to many Orchids. Generally speaking, the merits of this species are numerous, and owners of small collections should not be content without at least one or two plants.—W. S.

ODONTOGLOSSUMS—COOL WINTER TREATMENT.

I FULLY agree with all that has been said respecting the mistake of maintaining a low winter temperature for *Odontoglossums*. In a temperature that ranges about 40° the plants are at a complete standstill, or they deteriorate, and are not in spring in the same satisfactory condition as in the previous autumn. This is due mainly, if not entirely, to the plants starting late into root activity and growth. The plants thus often have to make their growth during the dull days of autumn, and in some cases the pseudo-bulbs are scarcely developed before spring. This results in weakly flower spikes and puny flowers. To grow these plants really well the winter temperature should not fall below 50° except on solitary occasions when the frost is severe. A temperature 5° lower then does no harm. Plants that have been kept in this temperature throughout the winter have now commenced root activity and growth, and potting or top-dressing must be attended

to. Some years ago we were tempted to give these plants a low winter temperature with the result that we shall never do it again. Two years elapsed before the plants recovered the freedom of growth they previously possessed. More recently we had a house of these plants from which frost had merely been excluded. Throughout the summer they moved slowly, but they did not grow freely, and it is only now after warm treatment throughout the winter that they display signs of being restored to health and vigour.

SHADING ODONTOGLOSSUMS.

I have commenced shading our plants for a few hours daily. Hitherto we have not provided the dense shade that some are in the habit of doing. No. 3 tiffany is heavy enough, and better for the plants than material of a closer texture. Shading will prove an advantage to the plants after they are top-dressed and potted, and thus prevent the atmosphere and the moss used on the surface of the pots drying. Maintain a moist atmosphere, and on fine days syringe lightly twice daily. No harm results from this practice provided a little air is daily admitted to evaporate the water that lodges in the young growth.

METHODS OF POTTING.

For some years I have discontinued the practice of using sphagnum moss mixed with the peat for *Odontoglossums*. It decays more quickly than good fibrous peat, and then if not removed proves injurious to the plants. It is also a mistake to employ too little drainage. Drain the pots to within $1\frac{1}{2}$ inch of the rim, and then if the plants are well elevated they have ample material to root in. My method of potting is to have the crocks perfectly clean; if they are not in this condition they are washed, and over these a thin layer of moss is spread, and then the plants are potted in peat fibre or in lumps if good. If the material is decomposed we carefully remove it from amongst the roots. If good the surface only is removed, and the plants practically are re-potted. On the surface I place living sphagnum, but not to cover the surface, it is used in patches. But in this matter we are not particular, for I have found plants do equally well when about equal quantities of peat and moss are used on the surface. The living pieces soon become established by this method, and cover the surface more quickly perhaps than by the other. If moss is too freely used on the surface, especially during the winter, it holds too much moisture, more in fact than is good for the plants. When they are rooting and growing freely it is almost impossible to give them too much; but in the early part of the season, in autumn and during the winter, they can easily be overwatered the same as any other plant. While they enjoy a moist atmosphere they resent one that is stagnant. One of the greatest mistakes that can be made in the culture of these plants is to employ too large pots, and too much material about their roots.

SUITABLE POSITIONS.

O. triumphans should be relegated to the coolest position in the house, next to it *O. Pescatorei*, while *O. Alexandræ* must have the warmest. I rarely find any of these suspended in shallow pans from the roof, and yet they succeed capitally in these positions. They appear to flourish as well in low houses as when elevated on pots over the bed. They need careful syringing, and more frequent supplies of water.—ORCHID GROWER.

NATURAL HYBRID ODONTOGLOSSUMS.

It has become the custom in Orchid nomenclature to speak of all *Odontoglossums* which possess a combination of the characters distinguishing certain species or types previously introduced to cultivation as "natural hybrids," and the term is so convenient that it has been generally adopted. It is impossible to say how far it is strictly accurate, nor is this of much real consequence, as we can only deal with probabilities, and up to the present no progress has been made under artificial conditions in the direction of either confirming or disproving the accepted opinions. It is not unreasonable to regard many of the most boldly marked of these as the commencement of botanical species, and it is more than likely that some of those already ranked as species have originated in a similar manner. Experienced orchidists incline to this view of the matter, and they are justified in giving titles of the same value as those bestowed upon forms considered by botanists as worthy of specific rank. Whatever their origin, they to all intents and purposes constitute as it were the central points of what would ultimately be definite groups of variations.

This subject has excited some comment because at the two last meetings of the R. H. S. so-called "yellow forms of *Odontoglossum Pescatorei*" have been shown from two of the principal collections of Orchids in England and certificated under very different names. First we have *O. dellense* from Baron Schröder, of which a flower is depicted in the illustration (fig 63), the

colour soft yellow with reddish brown markings. The other was from Sir Trevor Lawrence under the name of *Odontoglossum Pescatorei* Prince of Orange, the ground colour a rich and deeper yellow, with bright brown markings, and the flower of good shape; in fact this is one of the best of the type yet seen. Some ten years ago Reichenbach adopted the name *O. excellens* for a supposed natural hybrid between *O. Pescatorei* and *O. triumphans* (or, as others say, *O. tripudians*). Since that time several yellow tinted *Odontoglossums*, more or less similar in character, have been introduced, and have either received distinct names like "dellense" or have been placed as varieties of *O. Pescatorei*. It is now suggested, and I think with good reason, that a preferable course would be to take *O. excellens* as the type, and arrange the others as varieties under it in the same way as would be done with true species. In this way we should have *O. excellens* var. *dellense*,

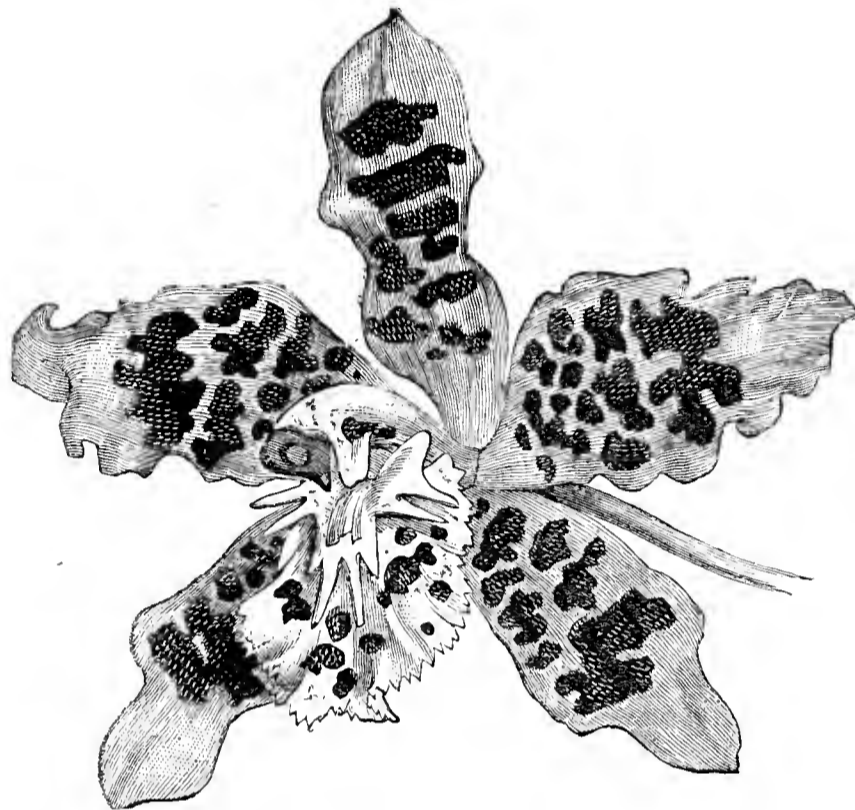

FIG. 63.—ODONTOGLOSSUM EXCELLENS VAR. DELLENSE.

and *O. excellens* var. *Prince of Orange*, and it would then matter little whether popular or Latin nomenclature were adopted.—L. CASTLE.

PEACHES AND NECTARINES.

THINNING THE FRUITS.

IN order to obtain large and handsome fruits, a point of great importance is to make a careful and good selection when the operation of thinning is carried out. Anyone who has paid due attention to this matter must have noticed a marked difference in the vigour and form of the fruits on each shoot; this can be clearly seen when they are about the size of peas, at which stage thinning should commence, and be carried out with determination and judgment. We like to crop each shoot according to its length and strength. In the first place all small or deformed fruits are removed, then those left are examined quickly, and critically selecting the most robust sturdy looking fruits of good shape, with due regard to having them well placed, so as to equalise, as far as possible, the crop retained over the whole surface of the tree, with the exception that very strong shoots are allowed to carry more than the average quantity of fruits, and the weaker portions of the tree thinned more freely. At the first thinning one, two, or three fruits should be left to each shoot, according to their length and strength. This will give a pretty severe thinning, but there will still be a good number to be removed at a later stage, and although I am no advocate for doing all the thinning at the first operation, neither do I believe in leaving the final thinning till after the stoning period, because I have never seen trees that were well attended to cast their fruits at stoning time unless they were then carrying far too heavy a crop. In such cases it seems to be a law of Nature for the trees to rid themselves of a part of their crop to show that they cannot be thus badly treated with impunity.

The final thinning I would make when the fruits are about the size of marbles, when in most cases one-third or so of those previously left will require removal. And the slight strain of carrying these extra fruits for a time is amply justified by the fact that it can be seen to a nicety which are swelling the most freely and evenly. For exhibition purposes to obtain fruit of the finest size and quality one fruit to a square foot is quite enough for Peaches, and one to 9 square inches for Nectarines, but for table use where very large fruit are not always required the trees may safely be allowed to carry a crop one-third more in number. I have noticed on some varieties of Peaches, notably

Goshawk and Sea Eagle, that the calyx of the flower frequently adheres closely to the ovary which afterwards forms the fruit; if this is not removed at the first thinning it slightly disfigures the fruits at the points, and gives to these varieties a more elongated appearance on the top than they should have, and prevents them from developing evenly all round. Of course, as the fruits grow the calyx is in time forced off, but the deformity indicated may still be noticed when the fruit is ripe.—H. DUNKIN.

WATERING TREES.

I QUITE agree with Mr. Tunnington (page 298) that the object of watering a border is to prevent the soil becoming dry, but I must remind him that I have not recommended that Peach trees be watered at stated periods generally, I merely mentioned the treatment they received here in passing. If Mr. Tunnington will refer to page 400, November 6th, 1890, he will there find the times mentioned when I watered the Vines, but I also stated that if the borders were loose or shallow the number of waterings would be insufficient. Still I recommend waterings at those seasons, or as near to them as possible where borders require it, as I find the times suitable for giving food, such as artificial manure, to the roots. When a man knows the condition of the trees and borders he can easily arrange for supplying water at given times. I am not now referring to borders which require watering perhaps every week or so, but those which, owing to their compost, depth, or situation, require from about four to seven waterings throughout the year. As far as my experience goes more damage is done by excessive than by insufficient watering. Moreover, if the surface is kept in a moist condition, less thorough watering is required. A good fruit grower can always manage to have the principal roots near the surface. I write from experience, and I have also learned much from writings in this Journal.—S. SCOTT, *Rathmore*.

SETTING FRUITS WITH THE SYRINGE.

I DO not feel in the least flattered by the apparently generous admission of "J. J. C." when he states he has read my criticisms of his recent remarks with "some interest," because I should consider it a somewhat remarkable fact were he not interested in it, as it clearly shattered the foundations of his objections against syringing Peach trees in flower, and has caused him to modify other assertions. But in the face of his uncompromising statement that he intends to stick with such absolute tenacity to the beaten track, I feel it would be labour in vain to attempt to convince him by either proof or reason of the error of his ways, and that the system he prides himself so much upon following may, under a great variety of conditions, be greatly improved upon. Nevertheless, I intend to point out that his recent contribution has not strengthened his position by any fresh argument. I am by no means so certain as my sanguine opponent that the system he so exclusively advocates is the one that the overwhelming majority of the best practical men pursue, and even if it were so, that is no proof that it is superior to all others. Not many years ago the majority of practical men thought it almost impossible to make a Vine border too rich, and not being satisfied with animal manures they introduced animals, in the shape of dead horses, but the successful men of the present day have quite changed their views and their practice in that direction. Time-honoured customs, however good in most cases, have their weak points. I fail to see that the camel-hair brush is always safe, for the simple reason that it is not always effective. I have known more than one instance in which the syringe was successful in setting a splendid crop when all other methods had failed to produce such desirable results. No doubt we have not yet reached that grand state of mathematical precision in setting Peaches as to be able to apply any system without discrimination. But I can say without fear of contradiction that I have never known the syringe fail in setting a good crop, but whenever it has been used as the means of effecting fertilisation, it has been done with such care and judgment as a man who understands his business will always exercise. I shall require more than the bare statement of your correspondent to convince me that to syringe Peach trees in the early stages to prevent green fly is a fallacy when I see daily the beneficial results of the practice.

Those who do not syringe their trees from the time they are started till they come into flower ought not to be surprised at being troubled with aphides, or if their trees sometimes break irregularly. There is no necessity to deluge them with water, but they should be syringed regularly every day if the wood is dry, and in bright weather twice a day. I regret that my persuasive friend was not more successful with his attempts to set both Peaches and Grapes with the aid of the syringe, and I am filled with an intense longing to know the conditions under which he practised it. The assertion "that the cost of a few pounds of tobacco is nothing when the importance of the object is considered," I quite agree with. I should never think of advising anyone to refrain from fumigating when the trees were attacked to any extent by green fly; but this I do most emphatically state, that if the trees are treated as I have described the cost for tobacco will be reduced to a minimum, and the necessity for fumigating will be of extremely rare occurrence.

I have always thought that when we are anxious to find a loophole of escape there must first be something we wish to escape from; but I trust my friendly critic will not remain under the erroneous impression that I wish to escape from any of the arguments by which he has attempted to surround me, because they are arguments through which there is room to drive a carriage and pair, like the proverbial Act of Parliament. When he talks about syringing in naturally damp structures he would lead one to infer that a heavy syringing is necessary to disperse the pollen. This is by no means the case. All that is wanted

is to give the trees a firm spraying with the syringe, and with a little circulation of air on the house, which is quite necessary at flowering time, half an hour after it would be scarcely possible to see the operation had been performed. When practised under the conditions I have already stated it is quite as satisfactory in unheated as in heated structures. In early houses more heat is required from the hot-water pipes to keep up the necessary buoyant atmosphere, and in late unheated houses the days are long before the trees come into flower, and then the fear of damp rests upon no surer foundation than the fleeting fancy of a fervid imagination rather than upon real facts.

No one has more respect for Mr. W. Coleman than I have, and I well remember reading some remarks of his two years ago in which he wrote, "He did not mind stating that by syringing his Muscats when in flower he had secured a better set than he usually obtained," but he did not mention that an animated machine could not be trusted to perform that operation. The case of my opponent has not been improved by his theory, that as "the stigma of a flower situated on the top of the tree next the glass is elevated above the stamens, the pollen is more apt to fall downwards than to lodge upon it." Does he not see that it cuts the ground from under his other arguments? He admits the syringing plan may answer in some cases when the houses are properly constructed, but his greatest fear is from damp, but the object on concerning the stigma would apply in all cases in heated and unheated, dry or damp houses. The real fact is that no matter in what direction the pistil points the flowers set equally well.

One more point, and I have done. The large-flowered varieties of Peaches which I have selected seem to have been singularly unfortunate for "J. J. C.'s" contention, so he asks me what about Noblesse and Hale's Early in flower in January? About Alexandra Noblesse I can tell him this much, that the best set ever obtained upon a very strong tree was obtained by syringing when in flower at a time when I was in charge of the house containing it, and Hale's Early, Early Alexander, and Elruge Nectarine answer under the syringing system equally as well as those my friend terms the most certain croppers of all.

In conclusion, let me earnestly advise readers of the Journal not to be deterred from trying for themselves, under the conditions I have laid down, the effect of syringing Peaches and Nectarines when in flower, both with a view of keeping green fly in check and of securing a good set of fruit. There need be no risk in the matter. Try a single branch till you are satisfied with the result, and in cases where there has been any difficulty in securing a good set the chances are ten to one the wished-for result will follow. Meanwhile I will leave my courteous but emphatic opponent to pursue the even tenor of his way.—H. DUNKIN.

I HAVE been much interested in the discussion on the above subject, and while agreeing with some remarks thereon I disagree with others. I will briefly as possible state my own practice, which has always proved so satisfactory that I see no cause for change. Our earliest Peach house is started every year about the middle of November; the house being a large three-quarter span, and is planted with Royal George, Early York, and Early Alexander Peaches and Darwin Nectarines. The trees are usually in bloom at Christmas, fruit ripe in May and early part of June. When in bloom the trees are given a sharp rap about mid-day and the set is perfect; syringing or using a camel-hair brush on the flowers is never practised. The next house is started in the middle of January, and is planted with mixed varieties of Peaches and Pineapple Nectarines, the same mode of setting the fruit being followed. Early Alexander is considered by some to be a little uncertain in setting and swelling its fruit, but this has not been my experience. In a house started February the 1st we have a tree carrying a splendid crop. It is very unusual for any blooms to miss setting, which entails a good deal of work in thinning. I think much of our success in setting the fruit is due to feeding the trees with liquid manure after the crop is gathered; in fact, they receive stronger doses then and during the time the trees are at rest than at any other time. I believe that the health of the trees, gentle forcing, a genial atmosphere, and discretion exercise a greater influence on the setting than anything else; and now, after chronicling a success, I must confess to a failure, for which I can give no reason. In our Alcante house one Vine started as usual, and has since died down to within 4 feet of the soil; the Vines on each side (4 feet away) are in capital order. Up to this year that Vine has done equally as well as the others, carrying a good crop of well finished Grapes. Why it should start and so suddenly collapse is a problem I am unable to solve. Have any of your readers had a similar experience?—S. T. WRIGHT, *Gleuston Court Gardens*.

ROOKSBURY PARK.

THE residence of J. Carpentier Garnier, Esq., High Sheriff of the county of Hants, is most pleasantly situated three miles from Fareham on an elevated site. The park comprises 400 acres, beautifully wooded, and including splendid specimens of Elm, Oak, and other forest trees. The mansion is large, squarely built of brick, and faced with cement, which gives it the appearance of being of stone, the principal entrance, from which can be obtained good views towards the west and in a northerly direction, is a portico built of stone, having massive stone pillars. From the roof of the house can be obtained capital views of the Isle of Wight and the surrounding country. The approach to the mansion from the high road which runs from London to Portsmouth is through a double lodge entrance, the drive being about half a mile in length, having a gentle ascent, and winding through a wood some

part of the distance, the trees on each side showing luxuriant growth, capital specimens of *Pinus insignis* and *Abies Douglassi* being conspicuous. On each side of the drive *Rhododendrons* are freely planted, and are growing strongly, the sandy soil appearing to suit them admirably. To the south of the house is a large space of lawn, which slopes gently away into the park, the natural ground formation being especially beautiful. Near the outskirts of the lawn clumps of shrubs, mainly evergreen, are effectively planted, a few good specimens of Conifers being judiciously dotted here and there. *Pinus insignis* standing on the side of a sharp slope, where it receives the full force of "sou-westers," which are prevalent there, proves by its uniformity and luxuriance of growth what a capital tree it is for such a site. The one in question was planted by the present owner about twenty-two years ago, and which has reached a height of nearly 50 feet. From there a fine sheet of water can be seen away in the distance among the trees in the park, where white Water Lilies are flourishing grandly.

South-east of the mansion are the flower garden, lawns, and shrubberies, which altogether cover six acres. This part of the garden is separated from the lawn just referred to by a thick belt of shrubs, which effectually prevents the south-west winds sweeping through this part of the garden. The flower beds are formal in appearance, cut out on the grass, and are devoted to the usual summer occupants. Tuberous *Begonias* last season appeared to have been a great success. The soil between the plants was neatly carpeted with *Herniaria glabra*, making a good setting for the various coloured flowers of the *Begonias* above. *Zinnias*, *Petunias*, *Coleus Verschaffelti*, *Calceolarias*, and *Pelargoniums* were planted in bold masses, and viewed from the windows of the house had a good effect. A long border close to the house was devoted to carpet bedding, with the addition of a few "dot" plants, which gave variety and relief, the raised perpendicular edgings covered with *Herniaria glabra* making a good contrast with the gravel path alongside.

From the flower beds the ground slopes sharply away into a deep valley, in the bottom of which were several beds, some filled with numerous sub-tropical, others with herbaceous plants, all of which were very showy as viewed from above. In the valley named large masses of *Rhododendrons*, *Kalmias*, and *Ghent Azaleas* luxuriate in the natural soil, and the quantity of bloom the two latter produce is marvellous. On the slopes rising from the valley are numerous shrubs and trees, most of them planted by the owner and his uncle, who preceded him. A specimen of *Liquidamber styraciflua* has a spread of branches of fully 35 feet, and it is about 20 feet high, and the foliage at the time of my visit was assuming the rich tints which render this such a conspicuous object wherever it succeeds. *Wellingtonia gigantea*, *Cedar of Lebanon* and *C. atlantica*, *Abies Menziesi*, *Picea Nordmanniana*, *Arancaria imbricata*, *Thuja Lobbi*, *Cryptomeria elegans*, *Thujopsis borealis*, *Cupressus macrocarpa*, and *Picea nobilis* are noteworthy examples of young thriving trees. A mass of *Aucuba japonica*, growing in a rounded form fully 20 feet across, is conspicuous as a lawn plant, and so is a group of *Yucca filamentosa*, which never fails to flower freely. Large plants of *Pampas Grass*, variable in form, are planted on the grass, and are very graceful when bearing their tall flower spikes. In this part of the grounds I noted a medium-sized healthy specimen of the Mulberry tree, which is a handsome lawn plant, as also is *Magnolia purpurea*. A small collection of hardy British Ferns increases the interest of this part of the grounds, and the plants grow freely in a prepared mound or rockery.

To the east side of the mansion stands a large conservatory, reached by passing through a verandah about 50 feet long, on the end of which is a fine plant of *Magnolia grandiflora*. The pillars supporting the verandah, which is 15 feet high at the front, are neatly covered with *Jessamine*, *Honeysuckle*, *Aristolochia Siphon*, and numerous other hardy trailing plants. The back wall is covered with *Camellias* in rude health. One specimen of *Mathotiana*, 15 feet in diameter, reaches to the top of the wall, and another of *Alba plena* is the same height. These and others produce a fine display of flowers in the spring, and have no protection beyond that afforded by the roof of the verandah and a thick mulching of bracken over the roots in the winter. The conservatory is 100 feet long, 40 feet wide and 25 feet high, with a perpendicular front, the lights being fully 18 feet high. The roof is divided into two spans, a broad gutter running between the two roofs. Inside this house several remarkable plants are to be found, one especially so—*Bignonia Chirere*, planted about 20 feet from the east end of the house in a central bed; the stems coil around one of the posts or supports of the body of the house. The two main stems are connected close to the surface, each of them being fully 10 inches in diameter, which will give some idea of the size and age of the plant. From the base numerous other branches proceed to the roof, quite three parts of it being occupied with this *Bignonia*. It is one of the finest in the kingdom, and produces a wealth of bloom during the summer months, especially during June and July. The proper system of pruning and manipulation of the shoots was explained to me by Mr. N. Molyneux, and consists in allowing some of the growths to hang downwards from the roof in such a manner that abundance of sunlight is obtained by all so as to thoroughly mature them, as only under these conditions can blooms be secured. From these shoots or branches additional growths are made which show bloom buds, and directly these are discernible the point of growth beyond the flower trusses is pinched out, thus concentrating the strength of that portion of the shoot upon the flowers. Neglecting to pinch the young growth at this time would end in blind flower buds.

Nowhere have I seen *Daturas* or *Brugmansias* flourishing so well as at Rooksbury. The white single-flowered *D. suaveolens* is planted in

the border, and is of tree-like proportions, being 22 feet high, and 10 feet across, completely covered with its pure white blooms, which are so sweetly scented. All the year round, with but few intermissions, does this plant flower. A younger but very healthy specimen of the double *D. Knighti* grows and flowers freely, and so does *D. sanguinea*, which is very showy both when in bloom and also when covered with its freely produced healthy foliage. A plant of *Cassia corymbosa* nearly 20 feet high and half as much in diameter was laden with bright orange yellow flowers and dense green leaves, which made a capital contrast. On the north side of the house *Camellias* are planted in a broad border, and appear satisfactory. A plant of a double red variety is 20 feet across its branches and 18 feet high. One of *Alba plena* is nearly equal in size, and *Lady Hume's Blush* a little smaller—all most useful in producing blooms through the winter and spring. The pillars which support this structure in the middle are clothed with *Abutilons*, *Plumbago capensis*, *Clematis indivisa*, and similar plants that succeed in such a temperature, the back wall being covered with *Heliotrope* and *Pelargoniums*. A plant of *Guava*, *Psidium Cattleyanum*, is planted in the border at the base of the back wall, the branches being trained under the roof, and flowers and fruit are freely produced. Several Palms, such as *Latania borbonica*, were growing freely in pots. Arranged in a mass along the front of the house and on the borders among the regular occupants were 400 capital plants of *Chrysanthemums*, grown on the tall system, mainly consisting of incurved and Japanese varieties.

The kitchen garden and glass houses are situated a quarter of a mile from the mansion, reached by pleasant winding paths, on each side of which *Rhododendron ponticum* and common Laurels are growing freely. Magnificent specimens of *Beech*, *Silver and Scotch Fir*, *Larch*, *Ash*, and *Balsam Poplars* are to be seen on the way, many of them 100 feet high, and as straight as a gun barrel for a considerable distance upwards. The glass houses are inside the kitchen garden, which is thoroughly sheltered from winds, especially those from the east and north. There are two vineries, one being filled with several varieties of Grapes, and so well do they succeed that the idea of having a separate house for some varieties is thoroughly upset. Splendid examples of *Muscat of Alexandria* are cultivated in the same house as *Black Hamburg*, *Trentham Black*, *Buckland Sweetwater*, and even *White Frontignan*. So good were the *Muscats* that they easily secured leading honours at the Southampton Show last year in the class for any white Grape. The Vines throughout this house are old, but all have borne full crops of serviceable fruit. The other vinery, 30 feet long and about 18 feet wide, is devoted almost entirely to late sorts, comparatively young Vines, which were lifted last year, and by the growth and crops produced this season indicate clearly what may be expected from them when they are well established in the new soil in which the roots were laid. An iron lean-to house, 100 feet long, 16 feet wide, was devoted mainly to *Peaches* and *Nectarines* with a few *Plums*, *Apricots*, *Figs*, and *Tomatoes*, the latter growing in any spare space between the trees, and a row the whole length of the house down the middle beside the footpath. The stems were trained singly upwards and then under the roof until many of them measured 12 feet long. Plentiful crops of both *Trophy* and *Sutton's Earliest of All* were obtained last year. From the Peach trees, *Royal George*, *Walburton Admirable*, *Violette Hative*, and *Nectarines* *Pineapple* and *Elruge*, a full crop had been obtained, and the growth was well ripened. One three-quarter span house, 20 feet long, was devoted to small table plants and Ferns, while profusely flowered plants of *Allamanda Hendersoni* were growing in 12-inch pots, trained under the roof, and had done good service in supplying flowers over a long time, a circumstance which was attributed to the fact of the growth having been kept thin and well matured. Pits and frames filled with the usual occupants were noted as being satisfactory. That part of the garden devoted to vegetables and fruit comprises four acres, half of which is inside the walls and has a gentle slope to the south. The soil is of a light description, easily worked, and most suitable for vegetable crops. The fruit quarters are well stocked with *Apples* and *Pears*; many of the former are espaliers newly planted, all of the leading kinds. Capital crops of outdoor *Figs* on bushes have been gathered, *Brunswick* and *Brown Turkey* especially. The place altogether shows signs of the improvement which has taken place since Mr. N. Molyneux took charge a little over two years ago.—A.

EARLY FORCED STRAWBERRIES.—If these are carefully attended to in hardening off and watering when removed from the fruiting house they make good plants for planting out, as they will give a full crop of fruit next season, and thus save a year in the growth of young plants. *Vicomtesse Hericart de Thury* and *La Grosse Sucrée* will also fruit again this year if desired, but this only applies to plants that have by this time finished fruiting. These large plants require a little extra care in planting. The balls of soil should be put in entire without disturbing the roots, and the soil must be thoroughly rammed firm all round them. They must also have a good soaking of water before turning them out of their pots and again soon after planting, mulching must also be attended to before dry weather comes. All ground intended for Strawberries must be well manured and worked deeply with the spade before planting. Alpine varieties are much appreciated by some people after the others are over, as they keep up a succession of fruit until stopped by frost in the autumn, and although the fruits are small they are of excellent flavour for creams. Pick off the earliest flowers in order to reserve the energies of the plants for the later fruiting. New plantations of these may still be made if attention is afterwards given to watering and mulching; they will then bear well in the autumn if good strong plants are put in.—G.



EVENTS OF THE WEEK.—The Royal Society meet to-day, Thursday, at 4.30 P.M., the Quekett Club on Friday, May 1st at 8 P.M., and the Society of Arts on Wednesday, May 6th, at 8 P.M. Sales of Orchids are also announced for Thursday, Friday and Tuesday at King Street, Covent Garden, and Cheapside.

— COVENT GARDEN MARKET.—Dutch Flowers, Canary Island Potatoes, and Tasmanian or New Zealand Apples, have been the chief centres of the auction trade in Covent Garden during the past week, and on Tuesday in particular some thousands of cases were sold. The Apples have arrived in good condition, and we saw excellent samples of Ribston Pippins, but the arrival of such large quantities at one time materially reduced the prices. The Potatoes were mostly of capital appearance, and the flowers included Hyacinths in abundance.

— THE WEATHER IN THE SOUTH is steadily improving, for though the wind continues cold the days are becoming much warmer, Sunday, Monday, and Tuesday being bright, sunny, and springlike. The low night temperatures and occasional frosts still, however, keep vegetation in check, and the progress is astonishingly slow for the time of year. Almond trees in suburban gardens have been gay for several days.

— WEATHER IN THE NORTH.—April 27th. For the last two weeks the weather has been of a uniform character, occasional frosty nights, generally bright days, with a dry, hard, ungenial atmosphere, in which very little growth has been made. A change of wind to the west on Saturday brought no alteration for the better, and the wind is again from the east.—B. D. S., *Perthshire*.

— GARDENERS' ORPHAN FUND.—At the Committee meeting held on Friday evening last, sums of £10 from Alderman Watson of Wakefield, also £10 from Mr. G. Dominy, were received, and the donors warmly thanked. The last named sum was in compliance with the wishes of the late Mr. Dominy. Following the generous example of Alderman Watson Mr. John Wills promised a gift of ten guineas on his approaching birthday and annually during his life. Mr. J. B. Stevenson was appointed a local Secretary for the Bournemouth district. Negotiations are in progress for holding a "Rose Fête and Floral Fair" at the Crystal Palace, on a day to be fixed in July, on behalf of the Fund, and all the gardeners and friends of gardeners in the kingdom will be gladly seen there.

— A CENSUS CURIOSITY.—A Sussex gentleman writes:—"When the Census enumerator was leaving the schedules at the different houses in our parish, an old cottager to whom he offered one said he need not leave it as he had received one by post. The enumerator naturally asked to see it, when the man produced one of Carter's seed catalogues." We wonder whether the native gave the firm an "order?"

— DOWNSHIRE HOUSE GARDEN, ROEHAMPTON.—Owing to the recent death of Mr. D. B. Chapman the gardens and estate at Downshire House, Roehampton, are about to be broken up. The plants will be sold, and it is said the land will be disposed of for building purposes. The well-known experienced gardener, Mr. M. Sullivan, is consequently in search of another sphere of duties. Although Chrysanthemums have been so great a feature at Downshire House, and so many prizes have been won with the blooms from these gardens, miscellaneous plants, fruit (particularly Peaches), and vegetables have been cultivated with equal skill and success, as many can testify who have visited the place at various times of year, and Mr. Sullivan is not likely to be long without employment.

— ALYSSUM SAXATILE has proved itself to be one of our best hardy spring flowering bedding plants, and it does not afford the slightest indication of having passed through such an exceptionally severe winter as that just experienced. Perhaps the most suitable place that could be found for this Alyssum is in a mass on the rockery. In that case plants half a dozen years old or more are preferable. They give more and earlier flowers than yearlings do, although individually they may not be so robust in the trusses. The easiest plan of securing a stock of plants is by sowing the seed out of doors in May,

transplanting the seedlings during showery weather in rows 10 inches apart, the plants 6 inches from each other, finally transferring them to the position they are to flower in afterwards.—R.

— GARDENING APPOINTMENT.—Mr. Thomas Phillips, late foreman at Gredington Gardens, Whitchurch, Salop, has been appointed head gardener to Colonel Cornwallis West, M.P., Ruthin Castle, Ruthin, North Wales.

— CHIONODOXA SARDENSIS.—This is one of the earliest and also one of the prettiest plants for flowering on the rockery. Grown in a sunny position, it was in flower three weeks before *C. Luciliae*, and in colour a darker blue. Both species should have plenty of room for spreading, as they seed freely, and the seedlings flower when two or three years old. They associate well with yellow Primroses and dwarf Daffodils.

— SELAGINELLA KRAUSSIANA.—Although the winter has been exceptionally severe and prolonged, this most useful Selaginella has proved itself again sufficiently hardy to withstand 28° of frost. Good clumps of it are growing in the hardy fernery between roots of *Scolopendriums*. The position is damp, and shaded by *Coniferæ*. It also withstood the severe winters of 1879, 1880, and 1881. So it is alike useful for the stove, greenhouse, and hardy fernery.—A. H., *Hunts*.

— PORTSMOUTH SHOW.—At a summer Exhibition to be opened by H.R.H. The Duchess of Connaught on July 1st in the Victoria Park, Portsmouth, in aid of local charities, some liberal prizes are offered, including £12 10s., £7, and £5 for twelve specimen plants, and £5, £3, and £2 for groups. The chief prize for a collection of six dishes of fruit is £2, and for nine sorts of vegetables £3. The schedule comprises fifty-three classes. Mr. B. Miller is the Secretary.

— THE remarkable and useful STREPTOCARPUS HYBRIDS now being sent out by Messrs. J. Veitch & Sons, can be seen in excellent condition in one of the houses at the Chelsea Nursery. The plants are exceedingly floriferous, the flowers most varied in colour and markings, and the compact habit renders them well suited for culture in pots. They can also be grown in a moderately cool house, and will be useful for conservatories. At the recent Royal Botanic Society's Show four distinct named varieties were certificated.

— MESSRS. J. PEED & SONS' ROUPELL PARK NURSERIES, TULSE HILL, are at the present time in attractive condition. Anthuriums are largely and well grown, their brilliant spathes being abundant. Orchids occupy several houses. Crotons, Dracenas, and other foliage plants have much space devoted to them, while forced plants of the usual character afford a gay floral display. Some thousands of young Gloxinias are advancing, and will constitute an interesting feature later in the season, for this is one of the specialties at Tulse Hill. Vines, too, are admirably grown and promise a plentiful crop of fine bunches.

— TRENTHAM SHOW.—A large and successful horticultural Show was held at Trentham last year, and judging from the schedule before us a still larger may be expected on July 16th. As may be seen by the advertisement last week some excellent prizes are offered, including one of exceptional value, £25, no less than £57 10s. being provided in the class for a miscellaneous group of plants in a space not exceeding 300 square feet. The prizes for fruit and Roses should also invite good competition. Mr. Blair's popularity will bring good support, and the Show and gardens be a great source of attraction to the inhabitants of the district and visitors from various parts of the country.

— "POTATO CULTURE FOR THE MILLION."—This is the title of a manual by Mr. H. W. Ward, recently issued by Messrs. Eyre and Spottiswoode. The author appears to have said as much as he could in the space which large type allowed. It goes without saying that his advice, concisely as it is rendered, is sound. Mr. Ward gives prominence to the following varieties of Potatoes:—Veitch's Improved Ashleaf, Suttons' Windsor Castle, Suttons' Seedling, Chiswick Favourite, Kinver Monarch, Suttons' Matchless, Carters' Holborn Favourite, Hooper's Paragon, Wordsley Queen, Carters' King of the Russets, Carters' Holborn Perfection, Magnum Bonum, and Imperator as suitable for maintaining an all the year round supply. He gives the following hint on cooking Potatoes:—"Put them in boiling water with a little salt; boil till nearly done, then drain off the water, replace the lid, and stand them aside on the hot stove to finish in their own steam. They will then turn out like balls of flour. Many Potatoes of good quality are spoiled through bad cooking."

— WHAT a difference there is in the time of flowering of old AND YOUNG PRIMROSES in the beds or borders. Beds filled with plants grown from seed four years since have been covered with bloom for the last month, while beds of last year's seedlings have not a flower open. The foliage on the young plants is in a much better condition than that is on those older plants. In the former case the leaves are quite green, in the latter the leaves have decayed to a great extent; but they have somewhat compensated for lack of foliage by the full crop of flowers.

— THE deep violet blue dense heads of flower of PRIMULA CAPITATA render it a showy plant for the borders or on the rockery during the greater part of April. The under side of the leaves is thickly clothed with a mealy powder of a distinct golden hue. Judging from the manner in which flower heads are now developing this plant is decidedly hardy, having withstood the late winter on an east border without any protection. It may be had in bloom in a cool house early in March, though the colour is not so rich as when out of doors. Forcing in heat it objects to, the flower spikes run up too high to give a favourable appearance. By dividing the roots after flowering a large stock of plants can quickly be had.

— TULIP OPHIR D'OR.—Bright golden yellow flowers are never too plentiful, especially early in the spring, out of doors; therefore anything in the way of this Tulip is acceptable. The growth is dwarf, foliage good, the flowers long, and supported upon stout stalks. It is at the present time in a fully developed state in a warm border, showing how well this single Tulip is adapted for early flowering.—S.

— QUEEN WASPS.—We are once more again entering upon the season for these wasps. It has often occurred to me why, in country localities where flower shows are held, prizes could not be offered for the greater number of queen wasps caught during the months of May and June—for instance, by offering a prize of £1, and by dividing it into as many prizes as may be deemed necessary. Secretaries would, I think, find plenty of competition amongst country lads. By so doing we should help to eradicate the often destructive pest.—A. E. FUME.

— BLACK CURRANT MITE.—I have been glad to see notes about this in the Journal, as I have been wishing to know something about its life history and habits. It threatened to be very destructive to fruit plantations. Last year and this I have had women to pick them off by hand, and it only costs about 5s. per acre. I do not think they are as numerous this year as last. I have had this done in the spring, but should like to know the best time, as it is no use picking the buds off if the insect has left them. If they fly they do not appear to fly far. Usually if a bush is affected badly the side of the next bush nearest to it is also badly affected.—WALTER KRUSE. [As the Phytoptidæ or gall mites are wingless they cannot fly.]

— A PROPOSED BOTANIC GARDEN IN NEW YORK.—The *American Florist* has the following note:—"New York is going to have a Botanical Garden in one of its new parks, and it is going to be got up on such a magnificent scale that it will rival the Botanic Garden at Kew, England, the most important botanical garden in the world. Good. We want such a garden, and there is no reason on earth why we should not have it. And it is mooted that the assistant director of the Kew Gardens may be proffered the directorship of the New York garden."

— WEED-KILLERS AND SUGAR POISONING.—A curious case of extensive arsenical poisoning is recorded in the *Lancet* as having occurred at Crieff recently. It appears that the effects were traced to sugar supplied by a certain dealer, and further investigation revealed the fact that in transit a bag of sugar had been in contact with some leaking tins of a liquid "weed-killer." The obvious moral is, that it is not safe to send "weed-killer" in leaky tins, and above all it is most undesirable that they should be packed with bags of sugar, which, to say the least, shows a singular want of thought.

— LADY GARDENERS.—A correspondent sends us the following advertisement cut from a London journal. He wants a gardener, but dare not engage this young lady, not alone because he doubts her attending to the fires late at night, but for other reasons. Here is the request:—"Jardinière, F.R.H.S., wants to hear of a situation as gardener for a young lady of gentle birth, strong and healthy, has great practical experience, understands forcing, Melon culture, and many of the higher branches of horticulture, as well as ordinary work in a private garden." He does not say she will do the work, though she is "strong and healthy." But

how a "young" lady, or gentleman either, could have "great experience" is not explained, and gardeners have to be at least middle aged before they claim great experience as a recommendation. However, no doubt the young lady will get a "place."

— ROYAL BOTANIC SOCIETY OF LONDON.—At a meeting of this society on Saturday, Mr. J. Bell Sedgwick in the chair, among the collection of Orchids and other interesting plants in flower shown and explained by the Secretary was a species of *Drimia* having snow-white flower buds, which, however, change to a vivid green as they open, thus forming an exception at once curious and interesting to the ordinary rule in nature of green buds and white or coloured flowers. Mr. H. Smith exhibited a specimen of the Calla or Trumpet Lily, in which a leaf remaining attached to the flower stalk had become perfectly white as the flower itself, while retaining its own shape and consistency.

— WE learn from a daily paper that the Director of the Royal Gardens, Kew, has just accepted the offer for the Economic Museum of a large and unique collection of objects representing the USES OF BAMBOO IN JAPAN. The donor is Mr. Charles Holme, F.L.S., a well-known connoisseur of Oriental art, who has for many years been an ardent student and enthusiastic collector of things Japanese. The collection embraces only such objects as are made for native use, and is interesting not only from an economic, but also from an artistic, point of view. It is intended to place this collection in separate cases, and to publish a popular illustrated handbook, which Mr. Holme has consented to write in relation to it. The value of such popular handbooks has been abundantly evidenced by the success of those issued by the Natural History Museum at South Kensington.

— WAKEFIELD PAXTON SOCIETY.—At the ordinary weekly meeting of the members of the above Society, held at the Saw Hotel last week Mr. B. Whiteley presided and Mr. W. Pyc filled the vice-chair. There was a good attendance of the members, and several new members were proposed. A long, interesting, and most instructive lecture was delivered by Mr. T. Tate, F.G.S., of Leeds, on "How do Fluids Move in a Plant?" Mr. Tate, who had on two previous occasions lectured before the Wakefield Paxtonians, dealt with his subject in a thorough and most interesting manner, and his remarks were rendered exceedingly clear by the exhibition of specimens and diagrams. After the lecture, which was most attentively listened to and very warmly applauded, a few questions were asked by Messrs. Corden, Tunnicliffe, and Garnett, and then, on the motion of Mr. G. W. Fallas, seconded by Mr. T. Garnett, and supported by Mr. H. S. Goodyear, a very hearty vote of thanks was accorded to Mr. Tate.

— EFFECTS OF SNOW UPON PLANTS.—I have previously mentioned the destructive effects of snow upon some plants. Since then I have witnessed at an elevation of upwards of 500 feet, about 200 feet higher than here, with more snow, plants flowering and apparently uninjured that are killed with me, and I have lost many. The only solution of the problem I can give is a pure atmosphere in the one case, and a polluted one in the other. The sulphurous and ammoniacal compounds in the smoke-laden atmosphere are brought down with the snow, forming a freezing mixture that lowers the temperature greatly and more than the plants can stand. There are few plants that preserve their foliage above ground but have suffered. I preserved a few double Primulas and Auriculas by covering them with earth at the beginning of March. I have at other times buried Chrysanthemums, then after the frost was gone lifted and replanted them, thereby saving what would otherwise have been lost, but the operation must not be too long delayed. If winters or rather springs are to be as severe in the future, I have no doubt but the preservation of hardy plants in smoke-laden localities will have to be attended to in some way.—W. T., *Blantyre*.

— HARDY FRENCH PERPETUAL FLOWERING CARNATIONS.—I have been absorbed of late in office work, but have not forgotten my gardens or greenhouses, and this morning I was engaged in transplanting yellow ground Carnation seedlings of my own raising and rearing. The reason why home-grown seedling yellow ground Carnations is unusual is because, first, those "aristocrats" of the Carnation world are rarely grown and flowered in the open garden, and, second, even if they were they rarely produce seed. I was fortunate in getting a few podsful of seed from a strain that I have found wonderfully floriferous and very vigorous, almost completely proof against the winter's severity, I mean the "French Perpetual Flowering," that flower continuously for at least six months. To attain this object I sow the seed in the autumn, give them

one shift, and have them ready for transplanting in spring. Ordinary town garden soil should not be used if good yellow loam in a raised bed can be procured. Seed sown now and the seedlings transplanted in the open air in the autumn will give splendid plants for next year's flowering. More than twenty years' experience enables me, therefore, to endorse the views of your correspondent, "The easiest method of forming a stock of plants to supply a large quantity of bloom is by raising seedlings."—W. J. MURPHY, *Colonnel*.

— PARSLEY DURING THE WINTER.—I, like some others, have found that Parsley will succeed better during the winter on dry sunny banks where such a thing as cultivation—such as deeply digging and enriching the soil with manure—has never been thought of. Six years ago, being desirous to dispose of some rough soil—the excavation for a pond, which was mainly composed of almost clay with flint stones—I had it wheeled into a long ridge-shaped heap running east and west. On the top of the bank, which was 4 feet high, I planted Spruce Firs, 6 feet high, for shelter to a piece of newly enclosed ground. The soil composing the bank facing the south in a couple of years' time was by the action of frost, rain, and sun reduced to a fair working state on the surface, although it was never dug. It struck me that this spot would be just the place to grow Parsley; consequently in March four years ago seed was sown in drills, very shallow, and being showery at the time the young plants grew well; the results were so good that more plants were placed on the bank the following season. This time they were put out with a trowel from the seed box, and the weather being showery the roots commenced making progress at once. From then until now we have never been short of Parsley from that bank, and it is possible to find a little after the recent severe wintry weather without any protection whatever, except what the snow provided. With the exception of keeping the Parsley free from weeds nothing has been done to the soil; it has never been dug, nor has it ever received one scrap of manure. Even during the extremely dry weather of the Jubilee year the Parsley grew luxuriantly, showing what a hold the roots of Parsley can take when growing in a close heavy soil.—S.

— GRAVELLING PATHS.—The present is a good time to lay gravel, either on new paths or old, breaking up the surface of the latter and turning it under to bury moss. Laying down gravel in the spring is much better than doing the work in the autumn for two reasons. First, the gravel binds better when dry weather follows, as it usually does in spring, whereas autumn and winter rains prevent its binding. Secondly, the continual falling of leaves in the autumn necessitates constant sweeping, which is both tedious and undesirable on newly gravelled paths. In laying gravel on new paths the stones, or whatever material is employed for the foundation, must first be well rolled. This effects a great saving in gravel, and enables it to be spread more evenly. The foundation may be of the same shape as the finished surface is intended to be, or the gravel cannot be of the same thickness all over. For ordinary garden paths it should not be less than 2 inches thick when spread loosely, to be compressed into about 1 inch by rolling to make a firm and lasting path. It is best to apply the desired thickness at once, raking the surface level. After drawing a roller over the gravel to press it down, make it thoroughly wet by pouring water on the moving roller through the rose of a water-pot till a smooth surface is obtained. The rolling ought to be continued until the gravel will absorb no more water, but stands on the surface, then cease. The path must not be walked upon for a few days to allow the gravel time to "set," then use the roller again till the surface is quite smooth and firm. Gravel paths cannot have too much rolling, provided it is done judiciously.—S.

— CONFERENCE OF FRUIT GROWERS.—In New South Wales a London paper announces that the Conference of Fruit Growers convened by the Hon. Sydney Smith, Minister for Mines and Agriculture, was held at the Royal Society's Rooms, Sydney. The Minister presided, and about forty delegates were present, representing the principal fruit-growing districts. Each delegate contributed specimens to what was really an excellent exhibition of native grown fruit. The President, in his inaugural address, referred to the great success of fruit growing in California. Speaking of the new Agricultural College, Ham Common, he said it was proposed to set apart 50 acres of land entirely for experimental purposes in regard to orchard work. It was intended to plant about ten fruit trees of every kind worth cultivating, in order that their value might be tried and proved. An orchard expert would be engaged to take charge of this orchard, under whom

experiments might be properly and profitably conducted, and who would impart his knowledge to the students at the college. He (the President) said he hoped to exhibit the value of irrigation within a few miles of Sydney, and in view of a population equal to nearly a quarter of the inhabitants of the colony. They would be pleased to hear that he had prepared a comprehensive Bill dealing with insect pests, and providing for the inspection of all fruit and fruit trees coming from foreign countries, and he hoped to introduce the measure into Parliament at an early date. There could scarcely be any doubt that the great market for the fruit of the colony would be England. It would be necessary, therefore, to consider what would be the most suitable kind of fruit for that market, and the best mode of packing to insure delivery in good condition. At the close of the last day of the Conference the Minister invited the delegates to a harbour picnic.

— THE second spring Show of the season at the ROYAL AQUARIUM, WESTMINSTER, was opened yesterday and continues to-day, a satisfactory display of plants being provided in the body of the building. Messrs. J. Laing & Sons, Forest Hill, have handsome groups of miscellaneous plants and Clivias; Messrs. Barr & Son, Covent Garden, have an extensive collection of the best Daffodils; and Messrs. Paul and Son, Cheshunt, contribute an imposing group of Roses and other plants. Auriculas are well represented, Messrs. J. Douglas, Henwood, and C. Turner securing the chief prizes. Spiræas are shown by several trade and amateur cultivators. Mr. Adams of Roseneath, Enfield, shows well in the Daffodil classes; Messrs. Cutbush & Son, Highgate, also exhibit in this section of the Show.

— THE SULTAN OF TURKEY'S CHIEF GARDENER IN FORMER DAYS.—One of the most influential officers of the Court was the bostanji bashi, or chief gardener. This functionary was Governor of the Seraglio (the palace generally, not the harem alone, which the term Seraglio is commonly believed to imply), and overseer of all the Sultan's gardens and summer palaces. The shores of the Bosphorus and Sea of Marmora from the entrance to the Black Sea as far as the Dardanelles were all under his inspection, and no one might erect or even repair any kind of building on the land subject to his jurisdiction without his permission, which had to be paid for. He was Ranger of the forests in the neighbourhood of Constantinople, and had charge of the Royal Hunt and Fisheries. Among his duties was the steering of the imperial barge whenever the Sultan went on the waters, over which he exercised control, an office which afforded him many opportunities of confidential communication. He had, moreover, to preside at the execution of great men, when that took place within the Seraglio precincts, and to superintend the prison where suspected officials were put to the torture. The bostanjis, or gardeners, who numbered about 2500 men, nominally formed part of the army corps of the Janissaries. They were the real guards of the Seraglio, and to members of their body was entrusted the protection of the various imperial parks and pleasure grounds. They also acted as gardeners, whence their name. One of their duties was to row the imperial barge when the Sultan was on board.—(From Stanley Lane Poole's "Turkey," in *Story of the Nation's Series*.)

— IN a recent report by Lord Vaux of Harrowden, Secretary to the British Legation at Stuttgart, on AGRICULTURE IN WURTEMBERG, reference is made to AGRICULTURAL EDUCATION in that State. This is cared for by numerous schools and societies, and appears to be fully appreciated by the peasants and others. Almost every institution of this sort had greater demand made upon it in 1889 (the year to which the report specially refers) than in the previous year. The agricultural and gardening school had its normal number of students; the school of vineyards, in consequence of increasing demands for tuition in this branch, was again forced to exceed its statutory number of pupils; the agricultural winter school was attended by 103 scholars, being an increase of six on the previous year. A sixth school was added to the five already in existence for teaching country girls and young women farmhouse and dairy work. The travelling teachers of husbandry, as well as those specially devoted to orchards and vineyards, were in great request among local societies, and by the communal authorities. Sixty-four students attended the lectures upon orchard cultivation; ninety-two farmers were taught at the various veterinary colleges and schools throughout the country. The winter evening agricultural schools, reading clubs, and local libraries all showed a considerable increase both in numbers and in attendance. Altogether some 23,400 persons attended agricultural schools or lectures on husbandry during the year. This is rather more than 1 per cent. of the total population of the country, and is good evidence that the people as a rule do not neglect the opportunities given them of becoming successful agriculturists.—(Nature.)

HARDY AZALEAS.

VARIETIES of the North American Azaleas nudiflora, calendulacea, viscosa, and some other allied species, were favourites in English gardens half a century ago, and in old establishments they are still abundantly represented in beds or shrubbery borders. The variations in colour obtained by intercrossing are practically innumerable, the plants flower most profusely in the spring or early summer months, and their fragrance is delightful. Where the so-called "American gardens" receive due attention no department is more interesting during the season, and the majority of the plants are adapted for damp, partially shaded positions, where nothing else would succeed so well. In the pleasure grounds at Kew to the right of the Siou House vista, when

single varieties; now, however, a series of double forms have been secured, which in some respects will prove even more useful. At the Royal Horticultural Society's meeting on March 21st this year Messrs. J. Veitch & Sons, Chelsea, showed several of these, and two were selected by the Floral Committee for awards of merit. One of these, named Azalea mollis fl.-pl. Mecene (fig. 64), has large heads of double white fragrant flowers, its compact habit rendering it well adapted for culture in pots. The other was named Azalea mollis fl.-pl. Norma, and had rather larger flowers of a reddish orange salmon tint, very showy and distinct. The impression conveyed by these plants is that they have resulted from crosses between the Japanese and the American Azaleas, and whether this be so or not, there is an evident tendency towards the characters of the last named. Some, in fact, were inclined to regard

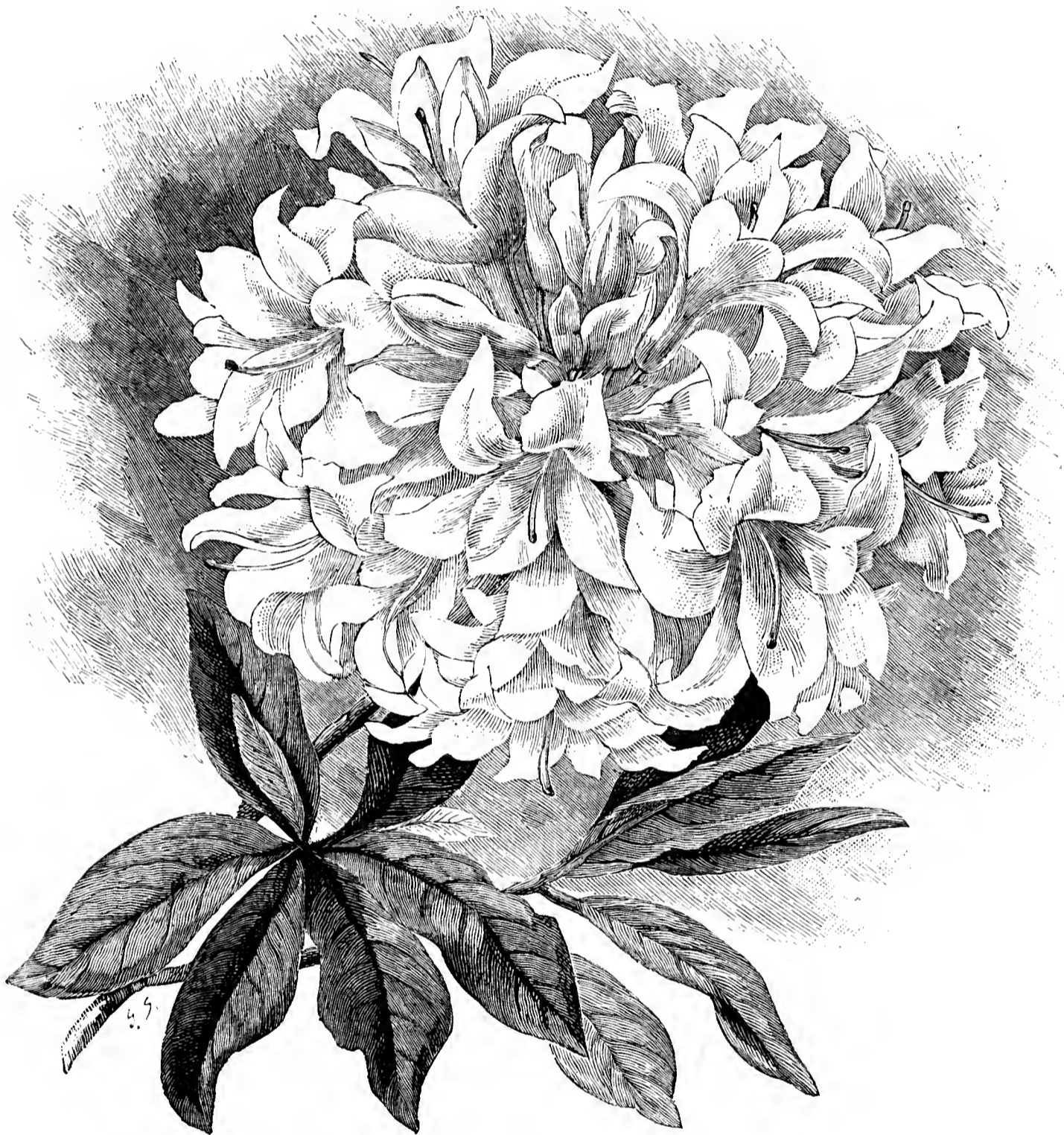

FIG. 64.—AZALEA MOLLIS FL.-PL. MECENE.

proceeding from the Palm house, there is a large collection of these Azaleas, with Ledums and other plants, and for some weeks, when in flower, they furnish the chief attraction in the gardens, though many strangers miss them owing to the inconspicuous position they occupy.

It is not much more than twenty years since the Japanese Azalea mollis made its appearance in this country, but the usefulness and variability of the plant were at once perceived and taken full advantage of, especially by raisers on the Continent. Numbers of beautiful distinct varieties were secured, ranging through indescribably delicate shades of orange, buff, and rosy salmon, and Azalea mollis became one of the most valued of flowering shrubs for forcing. The flowers are much larger than those of the group previously mentioned, and more showy, except that they do not possess the peculiarly bright colours distinguishing some of the others. Amongst the American Azaleas double varieties are abundant, but the Japanese have hitherto been confined to

them simply as varieties of that type. However, they are certain to become favourites with cultivators who have to force plants in quantity for early flowering.—C.

ROYAL HORTICULTURAL SOCIETY.

APRIL 21ST.

SCIENTIFIC COMMITTEE.—Present: Mr. D. Morr's in the chair; Mr. McLachlan, Dr. Müller, Mr. Blandford, Prof. Church, Mr. Wilson, and Rev. G. Henslow, Hon. Sec.

Primroses.—Col. Clarke forwarded flowers of a cross, showing the effect of a "blue" (female parent) with a very dark purple (male). The colour was a bluish purple. He reports that it is a first attempt to form a blue tint with a yellow eye. M. Wilson also exhibited a number of flowers showing new shades of light and dark blue, varying to purple. In some the red circle round the yellow eye had quite disappeared.

Auricula hybrid (?).—Rev. A. Rawson of Tallbarrow, Windermere, sent two umbels. One was of the typical yellow form, the other being striped with crimson. The latter is a presumed hybrid by intercrossing with a crimson Polyanthus. Upon division of the plant in order to propagate it the stripe disappears, and the plant reverts to yellow. No plant taken from the yellow ever produces a striped flower.

Grapes Grown in the Dark.—Messrs. T. Rivers & Son sent a portion of a Vine bearing a well-shaped and good sized bunch of white Grapes. They were very pale coloured, and apparently unable to ripen. The rod appeared to have formed no leaves, the whole shoot having been developed in total darkness.

Foliage Injured by Sulphuric Acid.—Professor Church exhibited leaves of various plants which were dried, shrivelled, and blotched, or streaked with red. They were taken from plants in a hothouse, and also from a second, the door of which faced that of the first. The injury resulted from the presence of free sulphuric acid, which, there was little doubt, arose from some small leakage in the flue. The subject of injury by gases will be found discussed by Herr L. Just and H. Heine ("Landwirthsch. Versuchsstat.," xxxvi., 1889). See also "Bot. Centralbl., xl., 1889, p. 296). The authors consider sulphurous acid to be the most injurious. When taken into the tissues it is oxidised into sulphuric, which destroys the protoplasm, and ultimately causes the death of the plant.

Kaempferia Tubers.—Mr. Morris exhibited specimens of tuberous roots produced by a species of *Kaempferia* at Trinidad, and used as food under the name of Toppee Tambo. Mr. J. H. Hart, F.L.S., the sender of the specimens, stated that the small tubers are preferred, and these are boiled and eaten like a Potato with suet and butter. They have an agreeable nutty flavour, and are much liked by the people. Similar tuberous roots are used at Dominica under the name of *Tokkee Tambo*. Mr. Morris added that this was an interesting record of the use of the swollen roots of a Scitamineæ for purposes of food, and he suggested that they might be carefully investigated. Professor Church was good enough to undertake an examination of the specimens, and report the results at a subsequent meeting.

DAFFODILS.

DESPITE the fact that we have not yet lost the cold winds, we are at the present moment in the midst of the Daffodil harvest, the most useful of all hardy spring flowering bulbous plants, such as should be possessed by all who have a garden. For many years these charming flowers made but little progress, and it was thought the few specialists who fifteen or twenty years ago were devoting so much time to the improvement of the Daffodils were wasting time and energy. The plants now, however, have a popularity they justly deserve, due to the enthusiasm which spurred on the true lovers of the flower years ago. Even these in their most sanguine moments never perhaps dreamt that there would be Daffodil farms in many parts of the country, and not a few were inclined to the belief that the whole thing would soon be overdone. Yet we still find single bulbs of new varieties commanding five guineas each, and others proportionally high prices. Cheap Daffodils there are, of course, as well as cheap Orchids, still the high prices demanded for many, notwithstanding their rapid increase, point to their firmly established popularity. I do not think the present fancy for Daffodils a mere passing one, for year by year we are being strengthened in our experience of one of the most delightful groups of spring flowers. Who, having grown them and realising their merits, could spare them from his garden?

The Daffodils this year are naturally later than usual on account of the season, but many good varieties are fully expanded, and the earliest are on the wane. In early March we had the tiniest of all the Trumpet section battling with an unusually severe winter on the open rockery. A pigmy curiosity this, which satisfies a few, and is too short on the stem to be of any commercial value. For pots or pans, or given sheltered positions on the rockery, protecting the flowers from heavy pelting rains, the tiny *Narcissus minimus* is well deserving to be grown in patches here and there. The advent of this is but the forerunner of a rich harvest of gold and yellow flowers of sulphur and creamy tints with the lemon and white of the bicolors, the pure white drooping forms of *cernuus* and *moschatus*, all assisting to glorify a genus unparalleled either in endless varieties or beauty. Take for example the exquisitely delicate and varied forms of *N. pallidus* *precox*, mostly with pleasing sulphur trumpets and segments, some long and tubular, others bold and finely developed, with broadly expanding mouth, each and all charming; unfortunately, however, it is not one of the most robust constitution, and can hardly make itself content under cultivation in English gardens, while in its Pyrenean home it grows, flowers, and seeds with remarkable freedom.

Quite opposed to this one in these respects are the showy though common double forms of *Telamonius*, a plant we could ill afford to lose, notwithstanding the almost endless variety we at present possess. All these double forms are beautiful for

naturalising in the woodland or for growing in pots for early work, for either of which purposes they are extremely useful. Then we have some delightful varieties in the Golden Trumpet Daffodils, and among these none stands out more conspicuously than Golden Spur, a bold and handsome form, wonderfully vigorous in constitution, and foliage even broader and more ample than in the double Daffodil. The intense golden tint of the trumpet in this kind, and the broadly expanded mouth, are points of importance in a Daffodil flower on a stem 15 inches high. By no means the least of its many good qualities is its free flowering, and those who would see one of the very best of all the Trumpet Daffodils in good condition should plant this one in rich loamy soil and let it remain undisturbed for three successive years. Another fine form is Henry Irving, but lighter both in the trumpet and perianth, and slightly earlier flowering than the last.

The Tenby Daffodil (*N. obvallaris*) must not be omitted among the early varieties, and as one of the neatest, showiest, sturdiest, and most compact it should be in all gardens where it will thrive. It does not do in all soils, however, though in others it grows and increases rapidly enough. *N. spurius* and several of its forms are much the same in these respects, and no ground seems to suit these so well as a bit of maiden loam; and on an equal footing is Ard Righ, an excellent Daffodil in suitable ground, always selecting loam and avoiding hot sandy soils. *N. princeps* is excellent, extremely free flowering, and increases freely; this should be in all collections by reason of its grace and general beauty, while, as affording variety, the many forms of *incomparabilis*, such as Stella, Glow, or even mixed strains of seedlings, are chaste when arranged with others in vases.

In speaking of this section we could not forget the giant Sir Watkin; this is exceedingly handsome, bold, and vigorous, possessing a fine constitution and freedom of growth as well as flowering that fit it for any and every purpose—in the garden as an ornamental plant of sterling worth, or one of the noblest and best among cut flowers. It is such as these that are destined to figure as standard kinds for many years. All who engage in improving Daffodils should select those of vigorous constitution to work upon, and what is yet wanted among Trumpet Daffodils is the unique colouring which makes *N. maximus* famous in combination with the vigorous constitution and freedom of flowering of Golden Spur, and whoever is fortunate in obtaining such a one will have accomplished a great work, and will have added a decided acquisition to an already long list of meritorious Daffodils.—J. H. E.

THE NATIONAL AURICULA SOCIETY'S SHOW.

IT would hardly be correct to say that this was a disappointing Exhibition, although it was doubtless inferior to many that had gone before; but this was what all *Auricula* growers anticipated would be the case. A couple of months ago I ventured to hazard the opinion that we should have a bad *Auricula* season, and this I did, not from claiming any prophetic instinct, but simply on looking at past experiences. Since that time a long spell of cold north-easterly winds has added another element of disappointment by retarding the bloom, so that when heating is not available it was quite impossible to get flowers on, and even where it was available it did not in the north avail, for Mr. Horner had nothing in flower to send up, although he can and does apply heat to his *Auricula* house. I myself, although so far in the south, had only one fully expanded truss on the Show day. We have unquestionably had of late years much colder and later springs than we used to experience. Last year was not quite so late, but I can remember that we always used to count upon our *Auriculas* being at their best about the 20th of April; but it never so happens now, unless when the grower can apply heat.

The frost displayed its power in the distorted character of the pips, and in the "out of character" description of many flowers, and this whether they were from the centre of the truss or outside. There were plants in the Show, for instance, which it was very hard to believe were the sorts which their labels asserted them to be; while there were numbers of pips where the eyes were crooked, the tube in some instances being enlarged and the paste angular. This was noticeable, not only in second-rate varieties, but in the very best. I have always noticed this as the effect of frost.

The character of the season had also to do with two other shortcomings which tended to injure the character of the Exhibition—the smallness of the truss, that is, the fewness of the pips which go to make it up. Thus there were to be seen many *Auriculas* at the Show which had only three pips. This would delight an old Lancashire grower, but I do not think it can be considered a truss. I am no advocate for a crowded truss, and have never seen one with twelve or thirteen pips that would not have been a better truss if few of the pips had been taken out. The best and most symmetrical truss for an edged flower is one consisting of seven pips; and an edged one with less than five or a self with less than seven I look upon as a defective truss.

Another feature of this season has been the number of blind plants—i.e., plants which did not throw up any truss. This tells of course on an

exhibitor, as he has fewer plants to select from. I suppose that it must be laid down in some way or other to the season, as I have heard of it from all quarters, so that it was quite independent of culture, and can only be accounted for by that great cause of all our gardening woes—the weather.

All these causes tended to make the Exhibition not up to the average, but now we turn to the brighter side of the picture, and I think the most noticeable point in it was the high position attained by Mr. Henwood of Reading. His set of twelve was a most admirable one; the flowers were of the best varieties and excellent in character, the plants in the best of health, and in many instances the stems would have held themselves upright without any support. All the flowers in his stand were very refined in character, and it is noticeable that it contained three of my late good friend Mr. Woodhead's seedlings, but I hope to say more on this subject by-and-by. Anyone who looks through the list of prizes given in the last number of the Journal will be able to estimate the excellence of culture which Mr. Henwood pursues. He swept the board, and yet his collection is a small one, not consisting of more than 120 blooming plants. Mrs. Dodwell (Woodhead's) was shown in excellent condition, and so was Mrs. Potts, which I think at present we must pronounce to be the best self out. The course of many seedlings is, however, erratic. Heroine has been very disappointing this year, and the blooms exhibited of it were not by any means equal to those one has seen before. Another noticeable point was the prominent position taken by Mr. Simonite's flower, the Rev. F. D. Horner, unquestionably the best green edge we have in cultivation; its tube is better than Prince of Greens, and its paste than Colonel Taylor, while in constitutional vigour it excels both. Not only was it the prominent green edge in most of the winning stands, but in the single plant competition it secured five out of the eight prizes, amongst them being the first, second, and third, a strong testimony to its value. Mr. Henwood had the only seedling exhibited, a very promising green edge (Mrs. Henwood), with light green edge, heavy body colour, not running into the edge, and a first-rate tube; it is one of a class in which we are especially short, and although some have from time to time put in their claims, they have after awhile gone into the rear guard—such as Talisman, and such, I fear, will Monarch. George Lightbody maintains his position as the leading grey edge, and although not so numerous or so well exhibited as in former years, was in some instances well shown. Mr. Henwood's plant of it was the premier of the show, and in the single class four out of the eight prizes were awarded to this variety. Rivals to this fine flower have from time to time arisen, but he has simply benevolently smiled at them. They have done their best, poor things, but they can no more equal him than could the frog blow himself out to the size of the bull. In white edges another somewhat limited class, for so-called white edges run into greys, and are hardly to be distinguished from them. Read's Acme still maintains its position, four out of the eight prizes for single whites being taken by it, although the first went to a very fine plant of John Simonite, a very fine flower no doubt, but a plant of a most delicate constitution, slow to increase, the very reverse of Acme, whose fault it is that it will so often break off into breeding, instead of forming a large plant, as does Conservative, which seems to be one of its progeny. It is possible after what we saw of Mrs. Dodwell that it may, when it becomes better known and more generally distributed, take the place assigned to Acme. It is of good constitution, and not slow to increase. The older varieties which we used to cherish—Glory, Smiling Beauty, and Truc Briton seem almost forgotten, although some of us old boys cherish them for the past memories they call up.

As I have already said, the absence of the northern growers was very regrettable, as we southerners not only missed the genial presence of Messrs. Horner, Barlow and others, and the pleasant chat we are wont to have with them about our pets; but we should have very much liked to have seen the champion pitted against our southern champion, Mr. Henwood, who ran him very close last year, and I think that it would have been very difficult for Mr. Horner to have beaten the twelve shown by Mr. Henwood this year.

Another pleasant matter about the Show was that it evidences the spread of the taste for the Auricula in the south; it has been a long time coming, but at last we seem to be nearing land. The prizes were all taken by southern growers, and Reading especially seems to supply a goodly band of amateurs, and their success this year will perhaps encourage them to further efforts. I see, too, an improved notion of what Auriculas ought to be, and a higher standard of excellence is set up: There was a time when growers thought the bigger they got a truss and the larger and coarser the individual flowers were, the more excellent was the culture, while great flopping leaves were looked upon as another proof of good cultivation. This era has, we hope, passed, and that refinement, shape and quality will be in future more regarded than great size.—D., Deal.

RIBES SANGUINEUM.—The common form of "Flowering Currant" is more profuse than I ever remember seeing before, due, probably, to the exceptionally warm and dry months of September and October, which did much towards ripening the wood of plants like this, dependent upon the previous season's growth for the next year's crop of flowers. Where a bush of this Ribes is allowed space to develop in a natural manner its growth on a lawn it is charming. Failing this convenience, if planted in a clump of about five at the back of the shrubbery a fine display is assured during the month of April if space is allowed for the free growth, for which this Ribes is conspicuous.—E.



THE SINGLE BANKSIAN ROSE (*ROSA BANKSIÆ*).

THE double Banksian is familiar to many admirers of the smaller varieties of Roses, but the single type is much less frequently seen, although its graceful habit should render it a favourite. No apology is therefore needed for the introduction of the appended woodcut (fig. 65) and notes. A correspondent at Stoke-on-Trent favoured us early in the present month with the following letter:—

"Enclosed please find three sprays of the single Banksian Rose about



FIG. 65.—THE SINGLE BANKSIAN ROSE (*ROSA BANKSIÆ*).

which I wrote you a short time since, and I hope they will reach you in good condition. I may add that by the kindness of Messrs. Paul & Son of Cheshunt this Rose was identified at Kew some three or four years ago as the true single Banksian Rose, but since that time my plant has not flowered until now.—J. W. DUNN."

The specimens arrived fairly fresh, and from them our artist prepared a sketch reproduced in the engraving. Strangely enough the current issue of the "Botanical Magazine" gives a coloured plate and full historical account of this interesting Rose from the pen of Sir Joseph Hooker, and from this we take the liberty of making the following extract:—

"Under the description of *Rosa multiflora* I mentioned that I hoped soon to figure in this work another Rose that had long been known in cultivation, but only in late years in its single state, *R. Banksiæ*. Thanks to the Rev. Canon Ellacombe I am now able to do this; and though I have nothing absolutely novel to add to the history of this

beautiful plant, I may accompany the figure with a brief *résumé* of what has been recorded. *Rosa Banksiæ* was first described in 1871 by R. Brown in Aiton's 'Hortus Kewensis,' where it is stated to have been introduced into England (presumably to Kew) from China in 1807 by Mr. William Kerr. It is not stated whether the plant was white or yellow flowered, nor whether single or double flowered. That it was however the white and double flowered is certain, for the next published account of it is in the volume for 1818 of the 'Bot. Mag.,' where it is represented (plate 1954) in this condition, the specimen having been obtained from Sir Joseph Banks' garden at Springrove, Isleworth (now the residence of Mr. Pears, the energetic manufacturer of soap). Though delicate, it at once became a favourite under the name of 'The Lady Banks' Rose,' or the 'Rose without a thorn,' the latter a hardly correct name. In 1819 it was figured in the 'Bot. Reg.' (plate 397) in the same white double condition, and from the same garden, where it had attained 20 feet in height or more, and with the remark that the single flowered variety had been found by Dr. Abel growing on the walls of Nankin.

"In 1820 Lindley's admirable 'Monograph of Roses' was published, in which the double white again appears as the only form known. In 1827 the double yellow is for the first time figured, and by Lindley in the volume of the 'Bot. Reg.' (plate 1105), with the observation that the first indication of its existence is to be found in a note (overlooked when elaborating the 'Monograph') in Roxburgh's 'Hortus Bengalensis,' where, under the name of *R. inermis*, both the double white and double yellow are alluded to with their Chinese names, as they were also in the Roxburghian MSS., preserved in the Banksian library. It was on discovering this, after the publication of the 'Monograph of Roses,' that the Royal Horticultural Society, of which Lindley was Secretary, directed Mr. John Dampier Parks (who was being sent to China in 1823 by the Society) to obtain the yellow form, which he did, returning with it in 1824. Dr. Lindley describes it as, on the whole, a more desirable plant than the white variety, being more hardy, flowering more freely, and having deeper green leaves, but adds that it is less fragrant. The only other early notice of this plant is by Dr. Abel in his narrative of his travels in China, to which country he went as physician to Lord Macartney's embassy. Abel mentions it as *R. Banksiana*.

"Indigenous specimens of *R. Banksiæ* are in the Kew Herbarium collected in the Ichang province on the Nan-to Mountains by Dr. Henry, and in Yun-nan, by the Abbé Delavay, also from Japan (Siebold). The single yellow form was sent to Kew by Mr. Hanbury, from his magnificent garden of the Palazzo Orenco, near Mentone, in 1871, and by Messrs. Paul & Son, from Cheshunt, in 1887. As stated above, the specimen figured is from Canon Ellacombe's garden at Bitton, near Bath, where it is quite hardy."

The flowers are of a yellow tint, somewhat like that popularly termed "old gold," the petals are deeply notched at the margin, but are rounded or cordate in form. The umbels contain six to twelve or more flowers on short slender peduncles, and are chiefly borne on lateral growths. The leaves are composed of pure narrow lanceolate bright green pinnæ, and have an elegant appearance.

THE HANGING GARDENS OF BABYLON.

[A paper read by Mr. HUTCHINGS EAVES, at a meeting of the Croydon Gardeners' and Amateurs' Mutual Improvement Society, March 24th, 1891.]

At the invitation of my friend Mr. Stanley Baxter I have come to address you briefly upon a subject which, I regret to say, is so hedged around with uncertainty, and so shadowy, consequent upon the lapse of ages, that I fear my few remarks must be at best fragmentary in character. I shall, however, endeavour to string together those fragments in such manner that you may be enabled to form some idea of that marvel of antiquity, "the hanging gardens of ancient Babylon."

The Babylonian gardens of any moment were few, but sublime in character; our modern gardens, on the other hand, are universal, but chastened in character, beautiful in design, highly calculated to elevate the mind, and possessing by their charm a true incentive to happiness. We must honestly confess that it is a difficult matter to fully estimate the true character of these Babylonian groves by a mere comparison of them with institutions of our own times. Take for instance a rustic bridge which spans the brook in yonder sylvan valley—how it delights one by its very simplicity. There is a charm about it which calls forth our warmest admiration; whilst on the other hand we behold a gigantic structure stretching across the dark waters of a Scottish Firth, which appals by its magnitude, and fills one with wonder rather than admiration. In like manner the Ivy-clad village church, surrounded by stately Elms and the rich foliage of the Copper Beech, no less rejoices by its picturesque simplicity, whilst the hoary pile of a Milan cathedral or the majestic ruins of a temple of Karnak fill one with awe and seal one's lips in mute astonishment, and I presume this in a greater or less degree has been the experience of the majority. I shall never forget how fully some few years ago I realised this difference between the sublime and the beautiful. On a bright afternoon in the month of March I was leaning against the bulwarks of a French steamer; as we glided through the blue waters of the Gulf of Suez I was gazing with some feelings of awe upon the distant, rugged, lightning-riven heights of Mount Sinai. I thought and felt as I contemplated this hoary range that there was no mountain on earth so unique in character, history, and grandeur. An Everest and a Matterhorn may rise to a higher altitude, but in that their interest ceased. What a contrast this is to the Pine-clad hills which grace the shores of a Scotch

loch or an English lake. On the one hand we are awed by sublimity, on the other charmed by simple beauty. Thus much by way of illustration. The contrasts are great I admit, but equally great is that which exists between a modern and an ancient eastern garden. From the sublime and beautiful of to-day we will now turn to that which characterised the hanging gardens of Babylon, and the better to realise their stupendous character we will take a hasty glance at the City of the Nimrods.

Babylon (the modern Hillah) is the Greek Babel, or Bab-ili—the Gate of God, or, as is sometimes designated, "The Gate of the Gods." It was also known as the Hollow, consequent upon its situation on the banks of the Euphrates, and down to later times as Din Tir, or the House of the Jungle. There can be no doubt that Babylon, the metropolis of the Babylonio-Chaldean empire, was one of the most wonderful cities of the old world situated on a plain on both sides of the river Euphrates, which equally divided it. It is supposed to have occupied the site of the Babel of Nimrod's kingdom. Its circumference is supposed to have exceeded fifty-five miles, and it was surrounded by a wall 350 feet high, outside of which was a vast trench filled with water. To Nebuchadnezzar that marvellous city was indebted for those vast structures which made it one of the wonders of the world, though it may be said to have been at the height of its glory at the accession of Assur-bani-pal, the famous Sardanapalus of the Greeks.

One of the most famous buildings (and the one which concerns us mostly) was the magnificent palace of Nebuchadnezzar known as "The Admiration of Mankind," which, together with its gardens, measured nearly eight miles in circumference. The building of this marvellous structure, together with the perfecting of its unique gardens, was commenced by Nabopolassar somewhere about 625 B.C., and completed by his son Nebuchadnezzar some years after his accession in 604 B.C., so that, roughly speaking, remembering the long reign of the latter king (forty-three years), it is not improbable that that vast undertaking spread over a quarter of a century, although it is on record that it occupied but fifteen days in building. Next to impossible as this may appear, we must, nevertheless, not lose sight of the fact that in those remote ages Eastern potentates, in order to compass their lightest wishes, unblushingly imposed upon whole armies of their subjects forced labour, without respect to person; men of subtle brain and ingenuity in their several vocations, to hewers of wood and drawers of water, were alike drafted (however much against their will) into this vast army of skilled humanity, impotent as slaves to withstand the will of this all-powerful descendant of the mighty Nimrod. It was so in ancient Egypt under the Amenamats, the great Thothmes, and the early Ramases; and we all know what Meneptha I., son of the mighty Sesostris, said to the Jews when in bondage and deprived of the means for making bricks—Ye are idle! Ye are idle!

Now I am going to ask you to try and carry your thoughts far away back over that vast bridge of time which unites to-day with twenty-five centuries ago—a hard task, I admit; nevertheless, let us make an effort. Judging from my own experience of the intense heat which usually prevails along the shore of El Hejaz and Yemen, from the Gulf of Acaba to the Straits of Babel Mandeb, I would suggest that we imagine ourselves in Babylon the Great on a fine October morning, waiting admission to the gardens of the palace. The entrance gates are of massive brass, and are opened and closed by means of a machine, the mechanism of which I am unable to interpret. The stalwart Chaldean keeper of the gate, satisfied from our tablets that we are satraps of the great king from far distant provinces, desirous of rendering homage and becoming eye witnesses of his state and magnificent surroundings, admits us. We pass the second and third walls which surround this royal compound, and then gaze in admiration upon the enchanting vistas of superb arboriculture which can claim no equal in gardening records, except perhaps in such as characterise the subtle ingenuity of our modern horticulturists. But we may not linger, for through the long vistas of rich foliage we espy the glittering spears of the Chaldean sentries as they pace to and fro upon the terraces of this superb palace, whose verandahs, pavilions, and terraces of granite, marble, porphyry, jade, and malachite, wrought as occasion required with rare and odoriferous woods, scintillate in the bright Eastern sunlight. So through long avenues of Palms, Cypresses, and Laurels (whose foliage effectually shelter us from the sun's rays) we wend our way, charmed by the music of the thousand and one rivulets of water which irrigate the soil and freshen the atmosphere, by the melodious song of birds and the odour of exquisite perfumes. Arrived at the outer court of the Palace, we again establish our identity by the presentation of our tablets, but learning that the great king is sleeping off last night's surfeit we are permitted by the courteous Chamberlain of his Majesty to wander through the fairy land which surrounds this unique pile.

Through groves of Orange trees planted in straight lines we therefore wend our way. Presently our path leads through alleys bordered with Roses, Violets, and other odoriferous flowers, then through avenues of the Narrow-leaved Elm, now known as the English Elm, and supposed to be a native of the Holy Land. Here we espy the graceful gazelle, bounding along, and in an adjoining grove the lazy, inquisitive-looking goat of Thibet disputes our right of passage, and presently espy a troop of agile monkeys, importations doubtless from India or Ethiopia. We now pass on through groves of Date Palms and Pomegranates, and then through enclosures planted with other Palms and Sycamores, containing large basins of porphyry where the Lotus grew, and where, as in Egypt, doubtless may have been seen the sacred ibis, the ichneumon; and amid those clusters of Bamboo the terrible najah, a reptile, which for

deadliness has no equal on earth, save, perhaps, in that of the cobra, or amadriad of India; but we will not disturb his noonday slumber, for we are just entering the vineyards surrounded by Dates, and probably the Doum Palms of Upper Egypt.

You need feel no surprise at our finding so many foreign trees and flowers in these Babylonian gardens. It was a custom in early ages for eastern potentates to exact of tributary nations that they should pay a portion of their imposts in the grain and plants of their country; as a consequence, therefore, an abundance of rare flowers—rare everywhere else even in the favourable season—found their way into the groves of Nimrod, and were cultivated with such care that during the entire year round the apartments of the Babylonian monarchs were graced with the richest floral tributes (interspersed with wreaths of Papyrus), which only the most experienced amongst these old world horticulturists could possibly produce. I am convinced, after many careful inspections in the British Museum of the monuments and tablets of the ancients, that a Nimrod or a Pharaoh would countenance nothing short of perfection either in the arts of horticulture or architecture, and I may mention in passing that only a fortnight ago as I strolled through the Assyrian room in our great national repository, I was struck by the delicacy of outline and the marvellous mastership which seems to have characterised the lapidaries of ancient Babylon. After admiring several exquisite wall carvings of the great king Assur-Nasir-Pal, B.C. 880, my attention was drawn to a tablet of the same epoch, upon which was depicted certain fugitives swimming for refuge to a certain castle when sorely pressed by Assyrian archers. In the background of the scene before us we are struck by the beautiful outline of Date Palms, and what appears to me a Palm intended to represent the Doum, of which I have already spoken (of the identity of this, however, I am in doubt); but passing on to tablets 27 and 32 we find elaborate outlines of priests offering flowers (no doubt this would take place in the great Temple of Bel). I counted the petals of these flowers, and in tablet 27 found there were eight, and in that of 32 twelve; and again in tablet 31 a winged figure was represented making a similar presentation. In this instance, too, there were eight petals to each of the three flowers which formed the offering; in form the flowers are somewhat like a single Dahlia.

But to return. We had entered the vineyards, when for a moment we deviated to glance at the monuments. Well, after winding our way through these vineyards and labyrinthine groves, where silvery fountains played, surrounded by Myrtle and Olives, under the shadow of which colonies of plaintive Bul-buls dwelt and thrilled your very heart by their deep pathos, we find ourselves approaching one of those stupendous artificial works, which, whilst being characteristic of the ancients for its magnitude, has been ranked amongst the seven wonders of the world because of its unique character. I refer to the hanging gardens of the Babylonian Palace, of which we have already spoken. Nothing could be more wonderful than these so-called hanging gardens, which Nebuchadnezzar caused to be constructed in order to gratify the wish of his Queen Amytis to possess elevated groves, such as in her earlier days she had enjoyed on the hills around her native place of Ecbatana in Media. For this purpose an artificial mountain was reared in the form of a square of 400 feet on each side, with terraces rising one above another to a height overtopping the walls of the city, and when we remember that the city walls were some 350 feet in height we must feel amazed in contemplating the gigantic proportion of this artificial garden rearing its head to a height far beyond that of the cross of St. Paul's. The ascent from terrace to terrace was by steps 10 feet wide; the terraces were reared to their several stages on ranges of regular piers over 75 feet high, which, forming a kind of vaulting, rose in succession one over the other to the required height of each terrace, the whole being bound together by a wall 22 feet thick. These measurements were arrived at during excavation amongst the ruins of this ancient Babylonian city.

The floor of each terrace or garden was formed in the following manner:—On the tops of the piers was first laid a pavement of flat stones, 16 feet in length and 4 in breadth, over which was a layer of reeds mixed with a great quantity of bitumen or mineral pitch, the most perfectly inflammable mineral known. It burns with a bituminous smell, and was doubtless what we now designate petroleum; its principal source was the fountains of Is, the modern Hit, on the banks of the Euphrates. The layer of reeds was in turn covered with two courses of bricks closely cemented together with plaster, while over all these were placed thick sheets of lead, on which was laid the earth or mould of the garden. This floor was designed to retain the moisture of the mould, and in order to provide a sufficient depth for the largest trees to take firm root hollow piers were built and filled with earth, and water was forced into these piers from beneath, thus securing to timber trees the necessary degrees of moisture. Upon the uppermost of the terraces of which we have spoken reservoirs were constructed and supplied with water from the Euphrates by means of an engine, and from these reservoirs the several terraces or gardens were irrigated as occasion required, the work being performed by legions of Ethiopian slaves, whose labours were regulated by experienced men, and who like the ancient Greek philosophers, appreciated not less the efficacy of the Vine than the mystic charm which attached to the Myrtle; men with whom, I doubt not, our friends would by no means have thought it derogatory to shake hands and hob-a-nob awhile, the better to settle some vexed question concerning the growth and culture of Ambrosia, an odorous plant which yielded the fabled food of the gods, and according to the mythology of the ancients produced immortality to whomsoever partook of it.

We have now taken a hasty glance at Babylon, its antiquity, its magnitude, palaces, princely benefactors, and, lastly, its hanging gardens. Of course the name applied to the latter arises from the dense hanging foliage each terrace garden presented as they rose one above another, until an altitude was reached at which the luxuriant tropical vegetation appeared almost ethereal as each Palm frond stood or hung out against an opal sky on the one hand, or vanished altogether in the deep gloom of shadow on the other. It remains for us now to take just a passing glance at the trees and shrubs which in all probability graced these garden terraces, but here on the very threshold of our investigation we are met with an almost insuperable difficulty; so little is known concerning the horticulture of the period of which we are speaking, that at best our decisions can be but speculative. I have already remarked that it was a custom of the Nimrods no less than of other Eastern rulers to exact of their conquered neighbours certain imposts in the form of grain and plants. I do not mean to convey by this that ancient Babylon and its environs were absolutely destitute of indigenous botanical features. On the contrary, its situation upon the Euphrates must naturally dispel such a notion, but at the same time its propinquity to the Syrian desert, and consequent exposure to the hot winds which periodically sweep over the land, parching as with the breath of a furnace everything living, are reasons, I venture to think, aptly calculated to effectually dispel any leanings we may have entertained in favour of a luxuriant indigenous vegetation. At any rate we have very little reliable data upon which to build up an hypothesis favourable to such an opinion, and at best the monuments are but fragmentary. Our only alternative, therefore, is to turn to those countries where the power and influence of Babylon was felt as the best interpretation of the sources whence its botanical wealth was drawn. From Egypt, Palestine, India, Ethiopia, and Arabia the majority of the beautiful trees, shrubs, and flowers which graced the hanging gardens of Nebuchadnezzar doubtless came, and though it were idle to speculate upon the particular nature and character of its botanical features, we shall not err very considerably when we sum up in the few concluding words the general appearance of the various terraces of these gardens as they presented themselves in all the varied beauty of tropical luxuriance.

The uppermost terraces were planted with the Date Palm, and from it were made bread, honey, wine and vinegar, and even articles of clothing; on the next series of terraces the Theban, or Doum Palm, flourished, standing out in marked contrast to the Date. On the next stage we find the Benzoin, a tall tree (*Styrax Benzoni*), a native of Siam and the East Indies; it was cultivated on account of its gum, which was doubtless used in the manufacture of incense for use in the Temple of Bel. The Weeping Willow (*Salix babylonica*) is said to have been found there, yet, despite its name, is not only not a native of Babylon, but in these days is not even known there. The Oleander in all probability flourished amongst the shrubs. The Olive, too, was common, particularly the *Olea fragrans*, with white flowers of exquisite fragrance; and in all probability the common *Olea europæa*, found all over Palestine. On another of these terrace gardens may have been seen the *Boswellia serrata* or *thurifera* of India, which produced the frankincense, used in conjunction with Benzoin in Temple worship. The Myrtle (*Myrtus tomentosa*) of India, with dark purple berries of aromatic sweetness, and several kinds of Mimosa and Acacia, doubtless flourished, but amongst so many hundreds it would be idle to speculate upon their species, though doubtless they would be natives of India or Ethiopia.

The remaining terraces were planted with Mulberry trees, Pomegranates, the Tamarisk, and Egyptian Privet, said to have been a flower of Paradise. Of the flowers which added beauty to these gardens we are in doubt: Violets, however, and a species of Lily flourished, and probably a kind of Rose, and by the watercourses the Lotus was trained, but beyond this it would be idle to speculate. We may, however, flatter ourselves that in spite of the stupendous character of these gardens they can lay no claim to comparison with modern horticulture, which is one of the noblest arts, and those to whom its perfection is indebted are the most enviable amongst men.



FRUIT FORCING.

PEACHES AND NECTARINES.—*Earliest Forc'd House.*—On early varieties the ripening fruit must be kept dry, also the foliage, but the border must not be allowed to become very dry, or it will act injuriously upon the growth and affect the formation and maturation of the buds for future bearing. As the fruit of the other varieties will not be ripe for some time, keep the atmosphere moist by frequent sprinkling during the day, syringing in the morning, and again when closing the house. The night temperature will be perfectly safe at 65° to 70°, but 5° less, though it will retard the ripening, will not tax the energies of the trees so much as the higher temperatures.

Fruit Stoning.—During this process the trees must not be hurried; 60° to 65° at night is ample, and 70° to 75° by day, avoiding high night

temperatures and sudden fluctuations by carefully attending to ventilation. A little air admitted at night will prevent the deposition of moisture on the foliage through the night to any serious extent, and enlarge the openings when the sun acts on the house, yet without lowering the temperature, which should advance with the increased power of the sun and a corresponding increase of ventilation. Avoid fumigating as far as possible, as it dries the atmosphere, and not unfrequently cripples the foliage, when the fruit from the check may be seriously imperilled and fall. Early closing is to some extent an advantage, but it must not be continued too long. It is also advisable to allow a little extra latitude to the growth, but on no account permit foliage to be developed that must afterwards be removed in quantity. Keep the inside border well supplied with water, and avoid undue excitement at the roots by stimulating them with liquid manure. Judicious feeding, however, is a great aid to trees when stoning, but let it be of a phosphatic nature, such as dissolved bone (superphosphate), also potassic. A mixture of five parts superphosphate and two parts muriate of potash distributed at the rate of 2 ozs. per square yard, will assist trees carrying heavy crops in stoning, washing it in, or dissolve in four gallons of water, and apply that quantity per square yard. The surface may be mulched lightly to keep it moist and attract the roots.

Trees Swelling their Fruit.—These swell most at two periods—viz., after setting until the commencement of the stoning process, and after stoning. The first is materially, if not entirely, influenced by the previous storing of matter in the trees and the available food in the soil; but a genial condition of the atmosphere accelerates the swelling of the fruits and the means employed to secure a good root action, which is best effected by a judicious and gradual regulation of the growths by the process of disbudding and in thinning the fruits. Overcrowding is a great evil, but large reductions of foliage at one time, as well as of fruit, are not good. There is no safety save in a steady progressive growth and careful disbudding. The more vigorous the tree the greater is the danger of the fruit being cast in stoning, and the evil is afterwards increased by severe disbudding, also by a close and moist atmosphere. In the last swelling after stoning tie the shoots down, so that the fruits may be fully exposed to the light; but moderate extension of growth will materially assist the fruit in swelling, care being taken that the principal foliage and fruit be not interfered with. Supply water thoroughly to inside borders when necessary, and liquid manure to weakly trees.

MELONS.—*Early Plants.*—When the fruit begins ripening lessen the supply of water at the roots, but not so as to distress the plants, for if the foliage has been kept clean and the roots are in good condition a second crop may be had. Withhold atmospheric moisture, and provide a circulation of dry warm air, increasing the temperature to 70° to 75° artificially, and 80° to 90° with sun heat. Cut the fruits before they are very ripe, keeping them in a fruit room for two or three days, or until they are in proper condition to send to table. Cracked fruits are produced by a close and moist atmosphere, and too much water at the roots, which induces an excess of sap. If any fruits show a tendency to crack, cut the shoots about half way through with a sharp knife a few inches below the fruit, and diminish the supply of water at the roots and in the atmosphere, leaving a little ventilation constantly to prevent moisture condensing on the fruit.

Succession Plants.—Continue fertilising the flowers when fully expanded, the atmosphere being kept rather drier and warmer, and ventilation attended to early, with a little constantly if there is danger of moisture condensing on the flowers. Stop the shoots at the time of fertilisation one or two joints beyond the fruit. To secure a full crop have a number of fruits on individual plants in the same stage of growth. Earth the plants with some rather strong and rich loam after the fruits begin swelling, ramming it firmly, and place a little fresh lime around the collar to prevent canker. Plants swelling their fruits may be syringed in hot weather about 3 P.M., damping the floor several times a day, and in the evening sprinkle available surfaces with weak liquid manure or guano water, 1 lb. to 20 gallons of water. Shade only to prevent flagging; ventilate freely in favourable weather, commencing from 75° to 80°, increasing or decreasing it during the day as may be necessary, maintaining a day temperature of 80° to 85°, or 90° with sun heat, closing between 80° and 85°, and if an advance be made after closing to 90° or 95° it will materially assist the fruit in swelling, and lessen the necessity for fire heat at night, but it must be accompanied by plenty of atmospheric moisture. If thrips appear fumigate moderately on two or three consecutive evenings, taking care to have the foliage dry.

Train out the growths in pits and frames, still maintain a good bottom heat by linings, and employ thick night coverings over the lights, as the nights are still cold. Sow seed for raising plants for planting in pits and frames as they are cleared of bedding plants, potting the young plants as required. Add more soil to the hillocks as the roots push through the sides of the mounds, which must be repeated at intervals until the allotted space is filled. Do not allow young plants to become root-bound before placing them out, or they will be stunted and rarely make a free growth afterwards. Any that are likely to get into this state should be shifted into pots a couple of sizes larger than those they are at present in, in order to keep them in steady progressive growth until the beds or hillocks in the pits or frames are prepared for them.

CUCUMBERS.—Those growing in houses and hot-water heated pits must be syringed twice a day, so that every portion may receive a thorough washing, which will be the means of keeping them free from the attacks of red spider and other troublesome insects. Plants growing

in dung frames will not need syringing so often; a sprinkling at the closing time will be sufficient on bright days, and none at all when the weather is dull. Give liberal and frequent (but not unnecessary) waterings of liquid manure at a temperature of 75° to 80° to plants in full bearing. Avoid overcropping and overcrowding the growths. Straight fruits being in request, and they are certainly finer-looking, they should be placed in glasses as soon as they have set, or three pieces of wood nailed together make a good substitute. Attend to the necessary stopping, thinning and tying, keeping a succession of fruitful growth. No more fire heat should be used than is absolutely necessary, and with the reduction of fire heat moisture will need to be reduced correspondingly. Make another planting if necessary, so as to maintain a supply of fruit exceeding rather than unequal to the demand.

Strawberries in Pots.—La Grosse Sucrée is grown for early forcing, as it is an excellent setter, always swells to a good size, and is brilliant in colour. This is the time when difficulty in most places arises, especially where forcing has to be carried on in vineries and Peach houses, for however good the management red spider appears, and this pest is soon transmitted to the Vines and Peach trees, hence a cause of much anxiety to the grower. Arrangements will need to be made so that there may be a succession of plants, and crops that are ripening too fast may be retarded in various ways for several days in case an extra supply is required for particular occasions. The expedients are turning the fruits from the sun, shifting the plants to a north house, or removing the plants from under glass into an airy fruit-room or a cool shed after the fruits are fully ripe. Much can be done at this season in cold frames with judicious management. All plants that can be accommodated in cold or low-heated pits should have their flower spikes thinned out to the requisite number, and be plunged in coal ashes well up to the glass, leaving room for a circulation of air to play between the glass and the leaves of the plants, and the forward plants from these structures can always be picked to take the place of those that are ripe and ripening. Supply liquid manure at every alternate watering to plants swelling off their crops, but care must be taken not to give it too strong and never cold.

THE KITCHEN GARDEN.

BROCCOLI.—Plants of Veitch's Autumn Protecting, a variety that ought to be very extensively grown, raised under glass in some way, must be well hardened off and pricked out on a sheltered border before they become "drawn." The soil for them should be light and free-working, or otherwise the plants will move badly out of it. Dispose them not less than 4 inches apart each way, fix them well at the roots, and give water if the soil is at all dry. A few branches of evergreens would afford temporary protection from either strong sunshine, cold winds, or frosts, but these should be removed in a few days. Now is the best time to sow seed of main crop and late varieties. Raised much earlier the plants are often ready long before the ground is fit for their reception, and they become much drawn and really unfit to put out if long left in the seed beds. For Broccoli to be hardy the start must be made with sturdy plants. Select an open position, and poor ground rather than a warm or much sheltered border, and sow the seed thinly either in drills or broadcast. If the latter plan is adopted, the seed ought to be covered with sifted soil, this being better than attempting to rake it in. If this advice comes too late, much seed having been sown some time previously, the least that can be done is to sow more seed of Late Queen, Latest of All, Model, Cattell's Eclipse, or other selected late varieties, a later supply of hearts being thereby secured in most seasons.

CAULIFLOWERS.—Any being forwarded in pits or deep frames should have abundance of air, and be kept well supplied with moisture at the roots. Directly hearts commence forming give a good supply of liquid manure, more of this being given in the course of a week. This will have the effect of causing comparatively coarse plants to develop very serviceable hearts. What plants there are left after handlights and rough frames have been filled, this applying to any raised either last autumn or early this year, ought to be put out on good open ground, room being also found for a few at the foot of sunny walls. They like fresh ground with plenty of solid manure mixed with it. Eighteen inches apart each way is ample room for the small early or forcing varieties, including Snowball, but the rows of Early London, Erfurt Mammoth, Magnum Bonum, Pearl, and Walcheren may well be 2 feet apart, and the plants 18 inches asunder. Autumn Giant and Eclipse should have rather more space. Successional plants raised under glass to be pricked out as advised in the case of early Broccoli, and more seed of Autumn Giant should be sown in the open, the plants from this sowing giving a useful supply of late hearts. A good stock of this popular variety being raised under glass, there is little need to sow any more seed of the quicker growing but less reliable sorts.

BORECOLE, CHOU DE BURGHLEY, AND SAVOYS.—If the seed of a good stock of Curled or Scotch Kale, not forgetting the valuable Read's Hearting, and also Cottager's and Asparagus Kales is sown as advised in the case of main and late crop Broccoli, capital sturdy plants will be ready for putting out in succession to early Potatoes and other quick maturing crops. Chou de Burghley is of little value when raised and planted early on good ground, the plants growing far too rankly, also hearting in before they are wanted. The seed being sown in the open with the late Broccoli, and the plants duly put out on good ground, a valuable supply of good hearts ought to be available at midwinter and later. Nor is it as a rule wise to raise and plant Savoys very early, these being wanted most during the winter. Tom

Thumb, Early Dwarf Ulm, Green Curled, and Drumhead form an excellent succession, Gilbert's Universal also being an excellent mid-season variety. The first week in May is a good time to sow the seed. Late sown seeds of the Brassica family germinate quickly, and are not often much interfered with by birds. Should the latter prove troublesome, and frequent dustings over with soot and lime not keep them off, then ought the beds to be netted over for a few days, no risks being run at this late date.

SALSAFY, SCORZONERA, AND CHICORY.—Sown early the plants of the two former especially are liable to experience a check from frosts or cold winds, premature flowering and useless roots being the consequence; whereas if the seed is sown at once on land some time since deeply dug and now in a finely divided state, no animal manure being used unless buried deeply, it will germinate quickly, and clean, straight, and sufficiently thick roots eventually result. Contact with solid manure or partially decayed leaves causes the tap roots to fork badly, hence the advice to sow on unmanured land. At the same time the latter ought not to be very poor, and if not well manured for the preceding crop, stir in a dressing of soot or some kind of artificial manure prior to sowing the seed. In each case sow the seed thinly in shallow drills drawn 15 inches apart.

RUNNER BEANS.—If these are wanted very early the better plan is to sow seed in either small pots or boxes and place in heat, the plants being duly hardened off and planted out before commencing to form running growth. Being very tender they will further require to be protected after they are in position, strips of serim canvas and benders answering well for the purpose. This extra trouble is not often taken by growers other than exhibitors who may require early dishes of fine pods, Kidney Beans being obtained much earlier with little trouble, and by some persons are preferred to the coarser pods of running varieties. The ground in many cases is very wet and cold just below the surface, snow water not agreeing well with clay, but all the same it is advisable to sow seed for the principal supplies, another sowing being made a month hence. Runner Beans thrive best and remain longer in full bearing when the plants are given the benefit of a freely manured deep root run, it being necessary to form Celery-like trenches for them in all cases where the subsoil is of a hot or hungry nature. In dry weather they require abundance of water, and this should be remembered, a convenient site being selected accordingly. It is most unwise to crowd them in any way. If a number of rows are sown arrange these quite 6 feet apart, and still more space should be allowed if stakes 9 feet and upwards are used. Grown on good ground they will attain a great height, and there is nothing to prevent the use of the tallest stakes obtainable. A single line of plants and stakes answers well, but if preferred the old-fashioned plan of arranging double rows of plants and stakes can be adopted. Sow the seed thinly, and thin out the seedlings to about 12 inches apart. In sunny open positions these Beans may also be grown without stakes. Dispose the rows 3 feet apart, thin out the seedlings to about 15 inches apart, and pinch out all running growth that shows. Everything depends upon the latter detail being strictly carried out, the closely stopped plants forming plenty of strong flower spikes all the season. The old-fashioned varieties, and with which the Champion is included, are the most generally serviceable, the large podded forms better suiting exhibitors. There is nothing to prevent two or more rows of early Potatoes, Cauliflowers, or Cabbage being planted between the rows or intended lines of Beans to be staked, and a single row between those to be stopped. These will have matured before the Beans want all the space.

THE BEE-KEEPER.

APIARIAN NOTES.

THE WEATHER.

APRIL so far in the north has not given us either the mildness or the genial showers the poets sing about, but instead chilling winds with scarcely a blink of sunshine. The winds have not been so tempered as to permit the flowers to display their "graceful charms." The temperatures for another week have been on five mornings 25°, one at 21°, and another at 30°, the day temperature between 43° and 53°. Bees are having a trying time of it, and it is to be feared fruit will be injured. In 1841, exactly fifty years since, we had a similar spring. It was July before snow had disappeared from the hills. We had a heavy fall on the 15th May, and sleet showers for some time after, then by the end of September the stacks and uncut corn were again under a deep covering of snow.

THE APIARY.

In order to keep the bees at home or from flying far, I am still supplying them with pea meal and water, but never saw so few in search of the latter. There must be much loss of bees, as go where I may there they are chilled to death, but these may be from other

apiaries where the same attention has not been paid the hives. All my entrances are still kept as they were during winter—viz., not more than three-quarters of an inch wide. As long as this weather continues I shall feed them with the tin scoops. All my stocks are in the best of condition considering the season, and as we are later here than some districts, if genial weather would only come the bees would soon make up for lost time.

THE PUNIC BEES.

It will be remembered that I started last year with two weak stocks of these bees (mere nuclei), but by the end of the season gathered 9 lbs. more from them than from the best stocks of any other breed. Starting this year with them at a normal strength compared with others they are now far ahead of any of them, and with fine weather would swarm early. Good enough for breeding bees for sale, some will perhaps say; but they have already proved themselves not only the best honey gatherers, but the prettiest of builders. They have also another quality—they work at times when other bees remain idle, and I have observed within the past few days that they do not venture out so readily when they are likely to be caught in a storm or chilling wind, and I fail to see any of them lying dead about the hive. The above are the simple facts as I have witnessed, and I am sure most persons will agree with me that a truthful description of anything and everything is better than carping criticism, wholesale condemnation, or superfluous praise.

FRAME HIVES.

The following has lately appeared elsewhere:—"All brood chambers of whatever type should be made to take standard frames, all others being worthless." Worthless for what? Had the author of the above added all other types contrary to ours, we could have understood what was meant, but as it stands I defy him to prove the assertion. The "Standard" hive, perhaps at our suggestion, has undergone much alteration for several years past, a singular one being the adding of different sized frames in one hive, the very thing its disciples tried to prevent, as would any sensible person. What virtue is there in the standard frame or hive over others? None, but in many respects it is faulty. What benefit is it to any bee-keeper although his hives differ in size a little from his neighbours? None, but it is to the dealer.

THE STEWARTON HIVE.

The produce from this hive has neither been surpassed nor equalled in quantity or quality by any modern hive. Many bee-keepers who use the Stewarton hives do not manage them upon proper principles, but are led away from the practice of the old bee-keepers, who are now rapidly dying out, by following modern instructors. Repeatedly I have witnessed and have had Stewarton hives weighing 2 cwt. Is that a worthless hive?

I have had numerous instances of the Lanarkshire storifying hive as heavy, while with the one-storeyed Lanarkshire hive, the winner of so many prizes, I have had 2½ cwt., 2 cwt. nett of contents. Can these be said to be worthless hives? The truth is novices are apt to fly from one thing to another, and it is as well to let them buy their wit.

SPRING DWINDLING.

With such a protracted low temperature as we have experienced it is a wonder bees exist at all. Need we then wonder at there being so many dwindling hives? Lately I visited the apiary of an acquaintance with several Lanarkshire storifying hives, the rest Stewartons, who has a strong inclination to manage his hives according to his own ideas. Out of a dozen three only appeared active. These three hives were the Lanarkshire storifying and ventilating hives, which were all that could be desired. The others seated upon solid floors and covered closely upon the top with iron presented a sad appearance, the combs mouldy and decayed, few bees, and the floor damp with a deep layer of *débris*. How could bees live in such hives? For wintering stocks successfully the floor as well as the other parts of the

hive must be dry; there must be nothing between the combs and the floor that is likely to chill the bees, and the former as near the floor as possible, so that the bees can leave them quickly without being chilled, and as easily return. It is the want of these precautions that is a principal cause of spring dwindling, was so in this case.—A LANARKSHIRE BEE-KEEPER.

PATENT RIGHTS.

“A LANARKSHIRE BEE-KEEPER” (page 314) asks for my opinion on the validity of Mr. W. P. Meadows’ claims to his new style of frame. It would hardly be fair to form such an opinion or to make it public, simply because I have not seen any “claims” of Mr. Meadows to any part of the frame he is putting on the market. But answering the question generally, whatever is old or publicly known cannot be patented or registered legally by anyone—*i.e.*, if it is, such patent, &c., is of no legal value.

The public have many curious ideas about the patent laws, and often patent things which should be registered as designs, and register things that should be patented. If this is done such registration or patenting is of no value. Thus anything which has a useful effect should be patented, while anything which appeals to the eye should be registered as a design. Registration protects shape or configuration only; but if this shaping has a useful tendency only and does not appeal to the eye, then it must be patented to protect it.

Patents are granted for inventions only—*i.e.*, something which has been found and which is useful. No idea can be patented, but the person who first shows how an idea can be carried out to effect a useful result is entitled to a patent, no matter how old the idea is or who first originated it. If it can be shown that the matter patented is something that any intelligent person would think of the patent would be void, no matter how new it was in its application. For instance, the patent on fish plates applied to railway rails was upset because fish plates had been used long enough for fastening two pieces of wood together; but if it has been long sought to remedy an evil, a patent would be upheld, no matter how simple and stupid it had seemed not to think of it.

A patentee who holds a patent on a useful invention can prevent all and any subsequent improvements or infringements from being worked or used, but if these have been protected by patent he cannot make use of them without arrangement with or a licence from such subsequent patentees. A notorious instance of the working of this principle is afforded by the telephone patents—*viz.*, Bell and Edison each invented and patented a telephone, both of which infringed on the other, while each had got something which the other had missed, the result being that they joined partnership as it were—*i.e.*, the two owners united. Subsequently Professor Hughes invented the microphone, which, used as a transmitter, has made the telephone a wonderful success. He, however, unfortunately for himself, did not patent it; the result being that the United Telephone Company are reaping all the benefit, and will continue to do so to the end of their patents, not even Hughes himself being allowed to use it. Had Hughes patented it he could have blocked the way and had his share of the benefits; as it is, by “giving the public the benefit of his invention,” he practically gave all the benefit to the holders of Bell and Edison’s patents.

Any person can get a valid patent on any improvement in any old thing, and if an improvement should make some old, abandoned, useless invention useful, he would get all the benefit—*i.e.*, if someone else, after seeing how he made it useful, effected the same result in a different way, or added some further improvement, they would be infringements; or, in other words, an inventor can monopolise anything that has been abandoned as useless if by doing something to it he can make it useful, as a just reward for making it a success and a public benefit for all time.

I see that I have omitted to say that any article registered as a design must bear some mark indicating the fact of its being registered; if any are sent out—even samples or patterns—without such mark the registration would be void. On the other hand, a patented article need not be marked in any way, or anything said about its being patented. I trust this short digest of the Patent Laws will enable “A. L. B. K.” and others to answer all such questions for themselves, but if anything is not clear I shall be glad to answer it, as the matter is of importance to bee-keepers, seeing how many patents, &c., there are on bee gear now, and likely to be.—A HALLAMSHIRE BEE-KEEPER.

TRADE CATALOGUES RECEIVED.

The Hardy Plant Nursery, Milmead, Guildford.—*Catalogue of Select Herbaceous, Alpine, and other Hardy Garden Plants.*

W. Wood & Son, Wood Green.—*List of Sundries.*



TO CORRESPONDENTS

•• All correspondence should be directed either to “THE EDITOR” or to “THE PUBLISHER.” Letters addressed to Dr. Hogg or members of the staff often remain unopened unavoidably. We request that no one will write privately to any of our correspondents, as doing so subjects them to unjustifiable trouble and expense.

Correspondents should not mix up on the same sheet questions relating to Gardening and those on Bee subjects, and should never send more than two or three questions at once. All articles intended for insertion should be written on one side of the paper only. We cannot reply to questions through the post, and we do not undertake to return rejected communications.

Books (A. R.).—Rivers’ “Rose Amateurs’ Guide” is probably the book you require. It is published by Longmans, and is a little less than the extreme price you name. The specimens you mention never reached us; perhaps the labels were detached in the post. It is a good plan to write the address on a label to which the stamps are attached, and to repeat the address on the covering of the box or parcel.

Maggots on Austrian Pines (G. H. A.).—They are probably the larvæ of the Pine beetle, *Hylurgus piniperda*, and as you appear to have Miss Ormerod’s work you will find an illustration and three or four pages of matter relating to the enemy and preventive and remedial methods. See pp. 242 new and 217 old edition. Syringing with lemon oil might do good now and is worth trying. It can be had from most nurserymen, and is advertised by Messrs. W. Clibran & Son, Altrincham.

Peach Trees Gumming (Constant Reader).—Some varieties of Peaches are more liable to different maladies than are others, and you do not give the name of the tree from which you send shoots. If you really cannot grow the Peaches under glass you had better try others, for there are plenty that will succeed quite as well as Nectarines. We have to tell you, however, that the wood before us was not more than half ripened last year, and its present condition is only what might be expected. The roots are not as they should be. They should be more fibrous in firmer and more calcareous soil, and the wood must be very much firmer too. All the trees in a house are not always in the same condition, and one may need lifting when another does not, also some need more water and support generally than others. The condition of each must be the guide to its treatment. The tree from which the shoots are taken must not have more water than is necessary for promoting steady healthy growth, and should be lifted before the leaves fall in the autumn and the wood well ripened. It most certainly was not ripened last year, and scarcely any nutrient matter was stored in the stems.

Definition of Gardeners (An Old Gardener).—For the purpose of exhibiting you are right on both points. A labouring man working one day a week in an amateur’s garden is not a gardener, but an unskilled worker in a garden, which is quite another thing. Strictly speaking, gardening is not a profession, but a vocation. The three professions—learned professions—are theology, law, and medicine. Even banking is not a profession. But the term “professional” has another signification perfectly legitimate and understood—namely, to distinguish between a person who practises gardening or any other calling as a skilled exponent, and who executes his work professionally as a means of livelihood, and not in the character of an amateur who has not been taught the art and does not depend on it for subsistence. In that sense, and it is the right sense for the purpose of arranging the schedule in question, you come within the definition of a professional gardener, and could not compete in the amateurs’ classes. The schedules of the Royal Horticultural Society are arranged on a different, yet correct, basis, and all persons who are not nurserymen or traders are regarded as amateurs. They may employ gardeners, but the gardeners themselves are not admitted as exhibitors, and the entries are in the names of the owners of the produce. For instance, plants and flowers exhibited from Great Gearies are exhibited by and in the name of Mrs. Whitbourn, and she employs Mr. Douglas to grow them for her, not for her profit or gain, but for pleasure. Mrs. Whitbourn is a true amateur, but secures professional aid, and very justly allows her gardener to profit by his skill and endeavour to provide what she wishes—the best plants and flowers he can produce, and as he does this as his means of livelihood he is eligible to be described as a professional gardener, though gardening itself is not in law a profession. It is an old and honourable calling, and many of the skilled and educated men who engage in it are as much, and deservedly, respected as are doctors and lawyers. We are proud to have such men in the gardening ranks, and these are not the men who every time they allude to their business describe it as a “profession,” for the

simple reason that they know better, and men who possess considerable educational acquirements are the last to indulge in pedantic references.

Cockroaches (S. B.).—They are the largest of our native cockroaches, the *Blatta germanica*. Professor Westwood, however, has great doubts whether this is truly indigenous. It is very abundant in Germany, and occurs also at the Antipodes. It is not a very common species, seldom occurring in houses, but being found in fields amongst heaps of rubbish, dead leaves, &c., sometimes in hollow trees. We have never heard or read of an instance of its having done any mischief to cultivated plants; still, if introduced to a garden it might soon increase and become troublesome, if circumstances were in its favour. For, as was pointed out some years ago in this Journal, the familiar *B. orientalis* sometimes quits the kitchen and makes excursions to gardens and frames where, owing to its nocturnal habits, it may do mischief frequently and escape detection.

Rhubarb (Curious).—The Early Red Rhubarb as grown in the London market gardens has been described in the Journal of the Royal Horticultural Society, as synonymous with varieties grown at Chiswick, as Early Albert, Royal Albert, and Prince Albert. As it was doubtless grown in the London market gardens before the late Prince Albert was born, this name can scarcely have priority. It is usually the earliest, and has often been large enough for use in February. We believe the Yaxley Vicar's Rhubarb to be the old Early Red and nothing more, though we quite believe the Vicar offered it in good faith as being distinct. We know that when the stalks of both were mixed even Mr. Barron could not separate them, and he has as quick an eye for detecting the differences in Rhubarb as anyone we know, though, perhaps, Mr. N. Pownall may equal him. When Early Red and Hawke's Champagne are grown by the acre for market, the former is gathered from first, the latter following, and is better in colour and quality. As growing side by side at Chiswick this year there was no appreciable difference in earliness; perhaps the former was a trifle the taller at a given date, but the stems of the latter were somewhat thicker, and certainly richer in colour. Paragon was as tall, if not taller, than either, and almost as well coloured as Hawke's, but Mr. Pownall found it later. As grown at Chiswick it is undoubtedly a good early variety. Amongst some seedlings of Mr. Laxton, now developing their characters at Chiswick, one especially is very distinct, of great promise, and as coming in between the first earlies, and Victoria bids fair to be about the best in the collection. It is good enough to be called Conqueror, unless its raiser can give it a better name.

Culture of Scarlet Runner Beans (M. R.).—The present is a good time to make the first sowing of this indispensable vegetable. The usual practice is to make several sowings of Runner Beans between the end of April and the end of June, and to afterwards support the haulms with sticks from 5 to 7 feet high, and to stop the shoots at that height. The best results, however, are not obtained by following that practice. We plant two rows of Runner Beans, between 60 and 70 yards long each, in drills 3 or 4 inches deep, and 8 feet apart, and running east and west. The first planting is, as already stated, made the last week in April, and the second two months later in front (south) of the first row. As soon as the plants appear and have had a little soil drawn up to them on each side, the sticks, from 12 to 20 feet long, are stuck firmly in the ground 1 foot apart on each side of the same, and are then braced together by a line of Bean sticks fastened longitudinally on the upright sticks at 6 or 7 feet from the ground by means of cross-ties made of tarred string. Instead of stopping the runners, as is generally done, with a view to hastening the formation of pods, they are allowed to grow uninterruptedly, and so cover their allotted space, thereby prolonging considerably the supply of Beans, inasmuch as the individual plants yield a succession of Beans until cut away by frost, the finest Beans being on the top. Our two rows of Runner Beans thus grown are, when in flower, greatly admired as being a capital example of the ornamental and useful combined. In consequence of the rows running east and west, the first row having been planted north of, and a couple of months earlier than the second, the latter is protected effectively from autumn frosts, hence it is that we frequently secure daily gatherings of Runner Beans up to the middle or end of November. When sharp frosts are apprehended all the pods that are fit for use should be gathered and spread thinly on a shelf in a cool room, thereby prolonging the supply three weeks or a month after the haulms had been destroyed.

Names of Fruits.—The names and addresses of senders of fruit to be named must in all cases be enclosed with the specimens, whether letters referring to the fruit are sent by post or not. The names are not necessarily required for publication, initials sufficing for that. Only six specimens can be named at once, and any beyond that number cannot be preserved. (H. S.).—The Apple is Moss's Incomparable, the Pear Beurré Rance.

Names of Plants.—We only undertake to name species of plants, not varieties that have originated from seed and termed florists' flowers. Flowering specimens are necessary of flowering plants, and Fern fronds should bear spores. Specimens should arrive in a fresh state in firm boxes. Slightly damp moss, soft green grass or leaves form the best packing, dry wool the worst. Not more than six specimens can be named at once, and the numbers should be visible without untying the ligatures, it being often difficult to separate them when the paper is damp. (J. J.).—The variety is one of hundreds that have been raised from seed by florists, and, as you will see above, we do not undertake to name varieties of florists' flowers, many of which resemble each other too closely for satisfactory identification. If you obtained the plant from

a nursery you might perhaps be able to procure its name from the vendor. (W. G.).—We should be glad to oblige you, but the specimen received will not permit us to do so. In the conditions above you will see we require flowers, or at least descriptions, neither of which are forthcoming, and leaves or small portions of stems do not afford sufficient material for the determination of doubtful plants. (M. R.).—1, *Spartanum africana*; 2, *Iris fimbriata*; 3, *Tremandra hirsuta*. (Broomer Hall).—By comparison with a large collection your Daffodils are determined to be as follows:—1, C. J. Backhouse; 2, Princeps; 3, *Incomparabilis Figaro*; 4, *Bicolor Horsefieldi*; 5, *Incomparabilis sulphureus*. (A. J. L.).—*Diosma ericoides*. Thanks for your letter. Your Vines will improve.

COVENT GARDEN MARKET.—APRIL 29TH.

A STEADY trade doing with good supplies.

FRUIT.

	s.	d.	s.	d.		s.	d.	s.	d.		
Apples, $\frac{1}{2}$ sieve	1	6	to	6	0	Kentish Cobs	40	0	to	50	0
" Nova Scotia and						Lemons, case	15	0	20	0	
Canada, per barrel	15	0	26	0		Oranges, per 100 ..	4	0	9	0	
" Tasmanian, case	6	0	12	0		St. Michael Pines, each..	3	0	8	0	
Grapes, New, per lb. ..	5	0	7	0		Strawberries, per lb. ..	3	0	8		

VEGETABLES.

	s.	d.	s.	d.		s.	d.	s.	d.		
Artichokes, dozen ..	0	0	to	0	0	Mushrooms, punnet ..	1	6	to	2	0
Beans, Kidney, per lb. ..	1	0	0	0		Mustard & Cress, punnet	0	2	0	0	
Beet, Red, dozen	1	0	0	0		Onions, bushel	3	0	4	0	
Brussels Sprouts, $\frac{1}{2}$ sieve	3	0	4	0		Parsley, dozen bunches	2	0	3	0	
Cabbage, dozen	3	0	0	0		Parsnips, dozen	1	0	0	0	
Carrots, bunch	0	4	0	0		Potatoes, per cwt.	8	0	4	0	
Cauliflowers, dozen ..	3	0	6	0		Rhubarb, bundle	0	2	0	3	
Celery, bundle	1	0	1	3		Salsafy, bundle	1	0	1	6	
Coleworts, doz. bunches	2	0	4	0		Scorzoner, bundle	1	6	0	0	
Cucumbers, doz.	3	0	5	0		Seakale, per bkt.	1	0	1	6	
Endive, dozen	1	0	0	0		Shallots, per lb.	0	3	0	0	
Herbs, bunch	0	2	0	0		Spinach, bushel	5	0	6	0	
Leeks, bunch	0	2	0	0		Tomatoes, per lb.	1	6	2	0	
Lettuce, dozen	3	0	3	6		Turnips, bunch	0	0	0	4	

AVERAGE WHOLESALE PRICES.

CUT FLOWERS.

	s.	d.	s.	d.		s.	d.	s.	d.		
Aram Lilies, 12 blooms ..	2	0	to	4	0	Marguerites, 12 bunches	4	0	to	6	0
Azalea, doz. sprays	0	6	0	9		Mignonette, 12 bunches..	3	0	6	0	
Bouvardias, bunch	1	0	1	6		Mimosa (French), per					
Camellia, white, per doz.	2	0	4	0		bunch	1	3	1	6	
" red	0	9	1	6		Narciss (Various) dozen					
Carnations, 12 blooms ..	1	0	2	0		bunches, French	2	0	4	0	
Christinas Roses, dozen						Pelargoniums, 12 trusses	6	0	9	0	
blooms	0	0	0	0		" scarlet, 12 bunches	4	0	6	0	
Cineraria, 12 bunches ..	6	0	9	0		Primula (double) 12 sprays	0	6	1	0	
Cyclamen, doz. blooms ..	0	3	0	6		Primroses, dozen bunches	0	6	1	0	
Daffodils, doz. bunches ..	2	0	6	0		Roses (indoor), dozen ..	0	6	1	6	
Eucharis, dozen	3	0	6	0		" Red (English) per					
Gardenias, per doz.	1	6	4	0		dozen blooms	2	0	4	0	
Hyacinths doz. sprays ..	3	0	4	0		" Red, 12 bls. (Fench.)	2	6	4	0	
(Fench) doz. bunches	12	0	15	0		" Tea, white, dozen ..	1	0	3	0	
(Dutch) in boxes	1	0	3	0		" Yellow, dozen	2	0	4	0	
Lapageria, 12 blooms ..	2	0	4	0		Spiraea, per bunch	0	6	0	9	
Lilac (French) per bunch	5	0	6	0		Tuberose, 12 blooms ..	1	6	2	0	
Lilium longiflorum, 12						Tulips, per dozen	0	6	0	9	
blooms	3	0	4	0		Violets (Parne), per beh.	3	0	4	0	
Lily of the Valley, dozen						" (dark), per beh. ..	2	9	3	0	
sprays	0	6	1	0		" (English), doz. bunch	0	6	1	0	
Maidenhair Fern, dozen						Wallflower, doz. bunches	1	6	2	6	
bunches	4	0	9	0							

PLANTS IN POTS.

	s.	d.	s.	d.		s.	d.	s.	d.		
Aralia Sieboldi, dozen ..	6	0	to	18	0	Genista, per doz.	9	0	to	12	0
Arbor Vitae (golden) doz.	6	0	8	0		Hyacinths, doz. pots ..	5	0	8	0	
Azalea, per plant	2	0	3	6		Hydrangeas, per doz. ..	12	0	15	0	
Cineraria, per doz.	6	0	9	0		Lilium longiflorum, per					
Cyclamens, per doz. ..	12	0	24	0		dozen	12	0	18	0	
Deutzia, per doz.	6	0	8	0		Lily of the Valley, per pot	1	0	2	0	
Lilytrea spectabilis, per						Marguerite Daisy, dozen	6	0	12	0	
dozen	8	0	12	0		Mignonette, per dozen ..	6	0	10	0	
Dracena terminalis, doz.	24	0	42	0		Myrtles, dozen	6	0	12	0	
" viridis, dozen	12	0	24	0		Palms, in var., each ..	2	6	21	0	
Erica, various, dozen ..	12	0	18	0		Pelargoniums, per doz. ..	12	0	18	0	
Eucalyptus, var., dozen ..	6	0	18	0		Pelargoniums, scarlet, per					
Evergreens, in var., dozen	6	0	24	0		dozen	6	0	9	0	
Fairy Roses, per doz. ..	9	0	12	0		Primula sinensis, per doz.	4	0	6	0	
Ferns, in variety, dozen ..	4	0	18	0		Solanums, per doz.	9	0	12	0	
Ficus elastica, each	1	6	7	0		Spiraea, per doz.	10	0	12	0	
Foliage plants, var., each	2	0	13	0		Tulips, dozen pots	6	0	8	0	

Bedding plants (in variety) in boxes, from 1s. to 3s.



THE GRASSY MIDLANDS.

FARMERS generally in this district appear to make no provision of shelter whatever for the lambing. There are no folds, cribs, thatched hurdles, or lamb cloths, nothing but the bedges.

The lambing is wisely timed late, in view of having some fresh grass for the lambs, and apparently in view of the vague chance of a spell of mild weather. This may answer in some seasons, but it has certainly not done so this year, for the pastures are still very bare of feed, and the bitter weather during the lambing killed the lambs by scores. It did more, it caused the death of many ewes also. The poor animals had fallen off in condition so much during the long hard winter that many of them could not bear the severe strain of the cold weather and low diet which they had to endure as lambing time approached, and they died. Well would it be if this were the worst of it, if there were any probability of this lesson of adversity being really understood, and due precaution taken in the future. But we have reason to fear it is not so, and that another winter will witness no improvement in practice, no intelligent effort to do better. Yet surely a little thought should convince anyone of the severity of the strain which hard weather makes upon the vitality of all animals. Certainly in our own practice we cannot afford to run any risk of loss from such causes, and, what is more to the purpose, we are able to avoid such losses by using the simple means that are open to all farmers.

Again, among calves and yearling beasts, losses mount up here so fast that we are convinced there would be a terrible list of casualties if all could be recorded. Scour and blackleg are the two great evils, both arising very much from mismanagement. The two great wants are shelter and proper food. Grass and hay form the staple dietary, to which there is an addition of cake—more frequently decorticated cotton cake than not—“just to plump the beasts a bit for market.” But there is nothing of a system worthy of the name—no intelligent inquiry into the cause of the losses, no effort so to alter and improve the treatment of young stock as to prevent the ailments which destroy so many every year. Yet it is well known that this is possible, and the means necessary to so desirable an end are well within the reach of every farmer. To show what these are, we cannot do better than to give the pith of Professor Sheldon's practice as set forth in his great work on dairy farming, for we have found his teaching sound, and entirely suitable for the ordinary routine of farm management.

He strongly recommends giving the cows 2 quarts of cold water immediately after calving, as it revives them and does no harm whatever. Afterwards, for a few days, linseed and flour gruel strengthens the cow and promotes a free flow of milk. Much stress is laid upon the importance of giving calves a good start. Caution must be exercised in feeding, as the calf is at once withdrawn from the cow, and has from 2 to 3 quarts of its milk daily, at first the quantity being regulated according to the size of the calf, increasing by the end of the first week to 4 or 5 quarts, to 6 or 8 quarts by the end of the second week, and to 9 or 10 quarts at the end of the first month. After the first month discontinue the new milk, and use skim milk thickened with ground linseed and oatmeal, boiled or steamed to assist digestion. Give this food to the calf at a temperature of 95° to 98°, which is the temperature of the milk in the cow's udder. If the milk or gruel is of a higher or lower temperature it is a deviation from Nature's rule, and is proportionately improper.

With very young calves the great thing is to avoid scour. This is done by making little and often the rule of feeding, by giving the food at a proper temperature, and by keeping them clean, dry, and warm, but not too warm. So fed the risk of an accumulation of coagulated milk in the stomach, which so often proves fatal, is avoided. Use also a pinch of condimental food from the first in the calves' food, increasing the quantity with advancing size and age. It imparts tone, and helps to keep off scour. We are convinced also that feeding pails are health promoters, as the calf has to suck the milk through the indiarubber tube, and thus secretes salivatory juice to aid digestion.

At two or three weeks old the calf begins to nibble hay, and should be taught to eat early. Shelter thoroughly, but as the weather becomes warm enough a run out on fresh grass is good for a few hours daily. Teach calves of six or eight weeks old to eat linseed cake broken small and put into the gruel. When the gruel is discontinued for grass continue using the cake, and give a pinch of salt twice weekly, but never use decorticated cotton cake for such young stock. So fed and well sheltered there should be no losses from blackleg. Professor Sheldon claims that he has only lost one calf since he adopted this method, and that loss was owing to the use of decorticated cotton cake.

WORK ON THE HOME FARM.

April wet and gloomy was certainly true of the first week of the month, but it has changed to bright skies and cold nor'easters in the third week of the month, enabling the laggards to get in their Mangolds; but if this drying wind and hot sun continue much of the moisture will soon be out of the seed beds. We certainly have ample reason for satisfaction with sowing Mangolds and the first crop of Swedes early in the month. The advice not to sow Mangolds early because a few of the plants from early sown seed bolt into stems is unworthy of attention. Sow early while the soil is moist, and ensure speedy seed germination and a full crop, and do not mind a few running to seed.

Grass in our small paddocks is now becoming plentiful, and it is very useful for young stock. Our plan of having a cow or two to calve at short intervals throughout winter gives us a certain number of forward calves. The very best quarters for them just now is a snug lodge or hovel, with its yard and paddock on a sunny southern slope. We continue feeding these calves very much according to the method given in our farm article this week. The gruel, or as some term it porridge, continues to be taken greedily. Linseed cake, well crushed, is given with it regularly, and the condition of the calves is entirely satisfactory. Our aim always is the maintenance of a healthy thriving condition, and yet to avoid overfeeding, which so often proves fatal to young beasts. The paddocks are well sheltered by belts of Austrian Pines, which we strongly recommend for the purpose as soon forming a dense thick belt, admirably calculated to break the force of cold winds. With the lodges and yards opening into the paddocks the calves are always certain to be well sheltered, and all risk of harm from exposure to cold and wet is avoided.

Younger calves are still kept in altogether, and will follow the early ones in the paddocks in the course of another month. They will not be turned out altogether, but will be either shut in or let run out according to the weather. They are never exposed to cold and wet, and are kept in by day when the weather becomes very hot and flies are troublesome. It is by constant supervision and very close attention to detail that the live stock of the farm is kept healthy and thriving. But there must also be a thorough knowledge of its requirements and intelligent aptitude to gather up and apply every crumb of information, every sound practical hint about it.

OUR LETTER BOX.

Lamb Food (Constant Reader).—At the first use half a pint daily for the lamb, and a pint or pint and a half for the ewe. Watch the consumption of it closely, see that it is always cleared up soon after each time of feeding. Let the rate of consumption and the condition of the animals be your guide as to any subsequent increase of quantity, which must also be influenced by your intention to fatten early for market or otherwise.

METEOROLOGICAL OBSERVATIONS.

CAMDEN SQUARE, LONDON.

Lat. 51° 32' 40" N.; Long. 0° 8' 0" W.; Altitude, 111 feet.

DATE.	9 A.M.					IN THE DAY.				Rain.
	Barometer at 32° and Sea Level.	Hygrometer.		Direction of Wind.	Temp. of soil at 1 foot.	Shade Temperature.		Radiation Temperature.		
		Dry.	Wet.			Max.	Min.	In sun.	On grass.	
1891.		deg.	deg.		deg.	deg.	deg.	deg.	deg.	In.
April.	Inches.									
Sunday	30.226	43.4	39.4	N.E.	41.3	50.1	36.2	68.8	27.4	—
Monday	30.303	44.2	40.9	N.E.	44.0	52.4	36.8	99.8	28.6	—
Tuesday	30.259	49.3	44.6	E.	44.1	57.3	37.2	100.8	29.4	—
Wednesday	30.132	45.1	42.2	N.E.	45.0	54.3	37.6	96.8	34.0	—
Thursday	30.088	51.2	44.8	N.E.	45.0	59.7	37.8	109.7	30.7	—
Friday	30.183	46.3	40.8	N.	45.9	58.4	34.4	108.8	28.6	—
Saturday	30.164	44.4	41.3	N.	44.9	51.1	36.1	80.0	29.7	0.010
	30.194	46.4	41.9		45.0	54.8	36.6	94.9	29.8	0.010

REMARKS.

19th.—Bright early; generally cloudy after 10 A.M.
 20th.—Fine, but without much strong sunshine.
 21st.—Occasionally cloudy in morning, bright afternoon and evening; lunar halo at night.
 22nd.—Fine and pleasant, but frequently cloudy, and at times threatening.
 23rd.—Almost cloudless throughout.
 24th.—Bright and mild; spots of rain at night.
 25th.—Overcast, with frequent sprinkles of rain in morning; fair afternoon.
 Another dry week, with rather low temperature and high barometer.—G. J. SYMONS.



ABOUT LONDON.

WHAT is here to be said is not anything connected with the great city itself, but a simple record, with reflections, on gardening in its environs. As a young man from the country, I did not so much wish to see what I had seen before—the great nurseries, such as those of Messrs. Veitch, Williams, Bull, and others; but I had a wish to make a circuit beyond them, and spend a day (a long and somewhat tiring day it was) in seeing what was going on in the suburbs. I was fortunate in having a guide who appeared to know his way about, and he first took me to Chiswick to note, as he said, the promise of fruit. Great, indeed, is that promise, and in about a week or so the garden will be like a fairy scene with blossom. Trees of all kinds, shapes, and sizes were simply studded with retarded blossom buds “struggling to be free.” Peaches on the walls were in flower, and cold as had been the days and nights the blossoms were so far safe, though they had not been protected. With the air so dry, Mr. Barron said the trees were better exposed, though coverings, such as nets, were in readiness for quick use if they should be suddenly required. He appeared to think, and my guide was of the same opinion, that there was danger in over-protecting, and to be effective the work must be done with great discrimination. It is well for the young to hear what old hands say, and see what veterans in cultivation do, as the experience affords valuable lessons. Peaches under glass will bear abundantly. Vines were showing well, and Tomatoes advancing for planting; but the fog fiend had stifled hundreds of plants, one variety alone curiously escaping, and this a French sort named *Chemin*, which is of vigorous growth, and bears very large fruits in its season. The rockery was being renovated, and the whole garden looking well; but to see it in its beauty it should be visited about the middle of May, when the rosy tinted Apple blossom is expanding, and before the Pears cast off their silvery dress.

From Chiswick we took the tram for Kew, about fifteen or twenty minutes' run, and walked over the ancient and hump-backed old bridge to the gardens. But the gates were locked, and the notice board told us the time for waiting. The guide, however, said Kew is a garden of education, and gardeners with a definite object in view are not refused admittance. He inquired for Mr. Nicholson, who had “just gone into the garden.” “Ah, yes,” he muttered, “just what might be expected, people are often ‘just gone’ when we want them.” However, on signing the book and stating the object of our visit, we were passed into the famous establishment, the first of its kind in the world, and of which the nation should be proud. What did we see? Chiefly men working with a will in the various houses, cleaning, arranging, syringing, watering, and washing down as if it were a race against time in view of the public opening. It is only necessary to see what has to be done in the time at disposal to perceive how unreasonable is the demands of the inexperienced for the houses to be thrown open to the multitude during the early part of the day. It is impracticable, and even if more men were employed and money spent in completing indispensable work sooner, the change would be prejudicial to the plants, and the public be less satisfied than they ought to be now. We did not interrupt the men in their work, and speedily the houses were closed for the dinner hour, to be opened at one o'clock to all comers. We therefore were content to examine them from the outside in peering through the windows.

It was easy to see the quaint Cactuses in one house, the fine *Cinerarias* and *Hyacinths* in another, the gigantic *Palms* in a third, and in others *Ferns*, *Orchids*, and plants in divers kinds and bewildering variety, all in admirable order.

In the grounds the nodding *Daffodils* in semi-wild profusion brightened many a knoll and vista, with, in contrast here and there, deep blue banks of *Scillas*. The *Hyacinth* beds were, and still are, splendid. There is no higgledy piggledy mixing of varieties, but the planting is systematic, and the varieties have been thoughtfully chosen. There are, as a rule, only two sorts in each bed, four rows in the centre, and two surrounding, the colours well associating, and all the spikes opening at the same time. The plan has been well conceived and well carried out. Here are a few of the floral associations—Grand *Lilas* in the centre, pale blue, surrounded with the white *Grand Vedette*. Grand *Maître*, deeper blue; and the rose tinted *Gigantea*. Charles Dickens, Oxford, and Czar Peter, Cambridge blue, a magnificent bed. Then we came to central blocks of the rich pink *Robert Steiger*, banded with double rows of *Gigantea* and *Grand Vedette*. There are other varieties, but the above examples are fairly representative. The effect produced by the distinct masses of colour that shimmered in the sunshine, each lending a charm to the other, far exceeds the conventional mixtures. The *Hyacinth* beds at Kew are worth a journey to see, and we came away satisfied, even if the houses were closed, and felt it only reasonable the men should want their dinners, because we wanted ours, and as an hotel sentry outside the gates appeared to think so too, we walked into his parlour like the proverbial fly, and he made the best of us for the time, but treated us not unfairly.

Outside was a tram waiting to take passengers, as it informed us in large letters, to “Richmond Town.” Quoth the guide to the conductor, “Does Mr. Herbst live along this road?” “Mr. Who, sir?” was the response. “What is he?” “Oh, nothing now, but he used to have a nursery.” “Ah; is he about this height?” indicating with his hand. “Yes.” “And does he wear gold rims?” making a circle round his eyes. “Yes.” “And has a beard like this?” making a long graceful sweep with his arm; receiving a nod of approval he gave a quick reply, “Right you are, sir; jump up, and I will put you down where you want to be,” and he did. I had not seen Mr. Herbst, but knew *Iresine Herbsti*. Luckily the famous man was at home, and he gave us a hearty greeting. How pleasant it is to see a man who has worked diligently with head and hands for years win success in the keenest competition in the world—growing flowers for Covent Garden, then retire with plenty to rest in a charming home and dispense hospitality to his friends, or be a friend to the needy. His garden is a little model, and perfect in its keeping. His rockeries, shrubs, alpines, *Ferns*, *Daffodils*, *Lilies*, vineries afford him exercise and pleasure, while his potting shed is such as many a nobleman's gardener would rejoice in. It is not known to all men that Mr. Herbst has been a pioneer in the floral supply of the market. It is interesting to hear him tell how he worked up stocks of plants and placed them in the market, at once created a demand for more, and took his friends by surprise. One example of his initiatory methods will suffice—forcing *Lilies of the Valley*. He was the first to send them into the market—half a dozen pots—in November, and did not know what to ask for them. Then he thought single spikes with a leaf might sell for buttonholes, and they were clamoured for at a shilling each. Hundreds of thousands he sold in the early days, some thirty years ago; then commenced forcing clumps in pots, and these were bought as fast as produced for 8s. each; next he commenced the single crown system. Other growers followed, but he was always ahead, and when, owing to the great supply, prices fell, he struck into something else, and so he went on adding to his fame and making his fortune; and he says, great as the competition is he could make a living now in growing flowers for sale as the demand is greater than ever.

"Find what is wanted, grow it better than anybody else, treat the public fairly in putting nothing bad at the bottom of a box or in the middle of a bundle, and confidence will be gained, then trade follows and success is certain." That is the delivery of a man worth listening to, and others who have been successful know how true the utterance is. Inferior culture, bad marketing, and especially "dodgery," are what Mr. Herbst and such as he condemns, well knowing that no one can sell inferior produce profitably or deceive the public for very long. We leave after a pleasurable visit a good and genial man, wishing he may enjoy a long and happy eventide in his pretty Ivy-clad villa between Richmond and Kew.

But on departing, Lilies linger in the mind, and we remember that Twickenham is the next station, and that Messrs. Hawkins and Bennett grow them by and for the million. We found Mr. Hawkins at home directing the cutting out of canvas for covering those of his beds that are wanted to succeed others which are covered with glass. They are about 6 feet wide, enclosed between planks on edge, and sashes or covers placed across the enclosures, that are filled, row after row of them, with vigorous Lilies, for they are thoroughly well grown. When flowers are wanted early a portable boiler is placed near a glass-covered bed, and pipes run round for heating. The cost of production is not great, and small bunches, when sold in huge quantities at even a moderate price, leave a good profit behind them. Lily growing in Mr. Hawkins's way has grown into an industry, of which he by no means enjoys the monopoly; and he does not appear as if he wanted, as he conveys the impression of being a man of generous instincts—a live and let live sort of individual, who looks well after his business, and does not trouble himself beyond that. He is a veteran in growing flowers for the million, and has attended Covent Garden Market for forty years, where business often commences at three or four o'clock in the morning, but has relinquished the duties of salesman, and now "sees to things" at home, no doubt pretty sharply.

The Victoria Lily of the Valley has been the chief market variety for years, and the favourite at Twickenham. A very robust and early form known as the Jubilee is now being increased, and a large bed of it protected with sashes was flowering grandly, the Victoria covered at the same time being apparently ten days later, but the earlier flowers when fine pay the best.

In addition to Lilies of the Valley, Maidenhair Ferns are grown in thousands for cutting. Several houses are a mass of green fronds, the plants in 5 and 6-inch pots, with here and there a larger specimen hoisted above them. The fronds, grown large and "hard," pay well. Gently brushing his hands over a specimen in passing in a fondling sort of way, Mr. Hawkins remarked, "That chap's given me 9s. worth," and was rapidly perfecting another fine crop. "Demand great?" quoth the guide, inquiringly. "Great!" was the response, "we can hardly keep pace with it. Why Mr. Wills will often order 300 bunches at once—big handfuls, but they must be good;" and then goes on soliloquisingly, "Yes; Mr. Wills has done much to create a demand for plants and flowers, and to increase the trade all round."

Then Pelargoniums, chiefly Zonals, are grown in enormous numbers, both as "market plants" and for supplying flowers for cutting. But the winter has been cruel to these plants. There was nothing but frost, and no sun for six weeks, plus the poisonous fogs. These brought off the leaves to such an extent that no less than twenty-two barrowloads were removed. But the plants now look as if nothing had happened, which shows how clever these market men are in making things grow.

Mr. Hawkins did not hesitate to name the varieties he found the most productive. As a pink Constance holds the field for freedom, fine blooms, good trusses, and charming colour. Four or five whites have each some point of merit, the distinctions being never so well seen as when hundreds of plants are grown together in "blocks." Eureka is the earliest. Then comes "The Seedling,"

always pure, never "tints," and The Queen, while Niphetos is retained because of its freedom, though the flowers individually are not of good form. Of single scarlets De Lesseps is a prime favourite, while West Brighton Gem and John Gibbons are classed amongst the usefuls. As a single crimson Henry Jacoby is mainly relied on, and seldom fails to produce rich trusses freely. Of doubles Duke of Albany has passed the old favourite "Raspail," and now leads the way with its velvety rich red semi-double flowers in neat trusses on erect stems. A fine winter and spring variety is the Duke no doubt, indeed good all the year round. But there is a new comer, a home sport, like a "Raspail" in foliage, but with better flowers, and the habit and light stalk of West Brighton Gem. It is prized as possessing a combination of virtues, and its name is Twickenham Gem.

"I suppose you gum your flowers, Mr. Hawkins," observed the guide. "Yes, every one. Here, where's that tin, let me show the young man." Forth came the little broad-based tin, like a lady's sewing machine oiler, but with a very thin curving spout for dropping the gum exactly where wanted. Taking a truss in one hand and the tin in the other the pressure of the thumb did the rest, and the flowers were gummed with deftness and celerity. They then travel safely and remain attractive over the longest possible time. "Make your own gum?" "No, it isn't often we have time, but it's simply made by mixing 1½ lb. of white shellac in 2 quarts of methylated spirit; if you want a small quantity reduce the proportions, and you will find it answer the purpose well." Thank you, Mr. Hawkins; three-quarters of a pound of shellac to a quart of spirit, 6 ozs. to a pint, 3 ozs. to half a pint. That is about it, if I am not out in my reckoning.

This is all I can tell. We were tired of sight-seeing that day, but the courtesy of all the men we met will long be remembered. And now I am tired of writing. The guide said if I would do what I could and send it to him he would "touch it up." How far his "touchings" go I shall be curious to see, but am hoping for the best.—A NOVICE.

CURRENT NOTES.

A GARDEN DIFFICULTY.

THE answers to correspondents column is always full of the best of information, and it is very rarely, if ever, that the best informed or most critical reader will challenge the replies there given to correspondents. Your answers to "J. J. A." (page 315) and "S. J. A." (page 335) are so good in every way that they ought to be carefully studied by the numerous noble—market gardener, nursery—men, and others who now wish to make their gardens pay by selling their "surplus produce." It is actually believed that such a garden—a large private garden—exists. Is this so?

I know of a nobleman's garden that is supposed to pay for itself, but it is so much like a market garden, and the family requirements so very small as compared to its capacities, that it could scarcely be accepted as a fair specimen. In addition, the produce consumed by the family is booked at much higher prices than the same produce would command in the open market; and even after that I do not think the garden clears its own expenses. I also know a home farm that is supposed to pay a clear 4½ per cent. The bailiff received a part of his education on the estate of the above nobleman. The farm is not debited with any rent, the produce supplied to the mansion is charged at top—and sometimes fictitious—market prices, and if bare, and very frequently short, weights and measures. There being no transference of cash, the complaints of the cook and the housekeeper are ignored. The bailiff's salary is not included in the accounts. Your able writer in the "Home Farm" would find that there is at least one "home farm" in the country that is a standing example of how "not to do it" were he to visit it; and yet the proprietor really believes that farm pays him 4½ per cent.

I think there are many gardens that could be made to "pay" in the same way, but I should not like to be the owner of them, and have to find the cash. To keep a horse, employ it for two days drawing manure, charge 10s. per day for horse and man, credit the sovereign to the garden, and fail to charge it on the manure, is a charming way of making farms and gardens "pay."

HOT-WATER HEATING.

I am glad "Heating Reformer" agrees with me as to the advisability of having the flow pipes near the walls and the return near the centre of the house, but am sorry I cannot endorse his recommendation of pipes at intervals of 2 feet over a Vine or Peach border. I consider they should be not less than 4 nor more than 6 feet apart. The less the borders are artificially—within certain healthy limits—dried, and the more uniform the moisture of the surface of the borders, the better it will be for the Vines and the Peach trees. Red spider is encouraged by the overheating of the pipes, and not by the particular situation of the pipes, and no arrangement of hot-water pipes will prevent spider if the atmospheric conditions in other respects are congenial for its production. I saw a vinery in 1872 that was heated in the manner advocated by "Heating Reformer," and they were the poorest examples of Vines I have ever seen.

SETTING PEACHES.

The discussion going on is an old one, but it will bear repetition. I believe Messrs. John Miller and John Simpson were the chief if not original exponents of the syringing system many years ago. I have seen the enormous "sets" of fruit by Mr. Miller by means of the syringe; better could not be desired. Whether one system is better than the other I do not presume to say, but in mild genial weather I do not hesitate to use the syringe, and in cold variable weather in January I prefer to trust my reputation to the camel's hair pencil, when trees and Peach houses are very limited in number, and the heating apparatus not sufficient to guarantee a suitable temperature for the "syringe" system. I know Mr. Miller reads the Journal, does he continue to use the syringe?

HEATING BY STEAM.

Mr. Dean's note on the above is interesting, and further particulars would be very welcome. For some years I have thought it practicable to heat greenhouses by steam and to light the dwelling house, stables, and offices by electricity, produced by the same power; but the cost of "plant" has always been the stumblingblock. Now that greenhouses are so heated, perhaps the day is not far distant when our most enterprising hot-water engineers will produce the machinery for the double purposes of lighting and heating.—HUGH DALE.

DOUBLE ANNUAL POPPIES.

THOSE who have not grown this annual should do so during the coming season. Two colours, scarlet and white, are especially noteworthy. Not only do they make a grand display during the summer in the herbaceous border, but they are useful for cutting where distinct colours are required. In a cut state these double Poppies perhaps show to the best advantage placed singly in specimen glasses. Like all the Poppy section they are best placed in water at once before the pores are sealed by the sap from the flower stalk; in this way they last much longer than if the wounded part is exposed for a time. Although rose and lilac can be had, I think there is none to equal scarlet and white.

The height attained when the plants are strongly grown, as they should be to give the best results, is about 4 feet, and stiff soil suits them much better than a light peaty one. Poppies like manure, and pay for the outlay, not only in more and finer flowers, but by the improved appearance of the foliage. Culture is a simple matter; one point especially should have attention—do not crowd the plants; if so, failure must follow. Each should stand almost clear of its neighbour, then success is assured. Sow half a dozen seeds at once in a space of about 1 square foot, and cover with fine soil. It is useless to transplant these Poppies, as they cannot bear the roots being disturbed, no matter how carefully it is done. Except in exposed positions the plants need no support, being strong enough to stand erect without assistance. If they require any place a stout stake in the centre of the group, loosely securing the plants to it. When the plants are about 1 foot high, if the weather be hot and dry, several thorough soakings of water at the roots will assist the growth considerably. We arrange the two colours alternately at the back of the border, but this is a matter for individual choice.—E. MOLYNEUX.

FRUIT PROSPECTS.

THE prospect of a heavy crop of all kinds of hardy fruit is decidedly good. If there is any cause to be doubtful of the results it is the superabundance of flowers, as I have noticed when we have previously been favoured with so much bloom that this is weakly, sets badly, and is liable to fall off wholesale. Apricots

had a very rough time of it when in flower, especially the more forward trees, but there is yet a good sprinkling of fruit swelling, some, however, being fully three weeks ahead of the rest, so long did the flowering period last. Plums also flowered or are flowering grandly. The best trees against walls were lightly protected with doubled fish netting, and apparently we shall be well repaid for this timely attention, a good set being effected, and that too in spite of frequent frosts and much cold weather. Much, however, depends upon the weather experienced during the next month, Plums frequently failing to swell in a cold sunless May. Trees on late walls and in the open are flowering strongly, bullfinches having been prevented from spoiling our prospects. Peaches are scarcely so forward as Plums, but they have flowered better than usual, and I have every confidence in the crop being heavy. Pears are a glorious sight, the Jargonelle being particularly beautiful. In many instances the flowers are somewhat weak, but the more forward hold on well. Apples come on very slowly, but there will be abundance of bloom.

There is much aphid on the buds, and insect-eating birds are damaging many of the flower buds trying to get at the fly. Gooseberries promise to be unusually abundant, but there is much red spider on the foliage, April showers being badly missed. Currants and Raspberries are much as usual, while Strawberries were never more promising. Noble is opening its flowers rapidly on raised borders, and these we are protecting as much as possible from frosts. I shall be very agreeably surprised if there are many Filberts, as these flowered early, and had a bad time of it.—W. IGGULDEN, *Somerset*.

On the 25th of April I visited a number of orchards on the Clyde in the neighbourhood of Carluke and Crossford, where there is more shelter than here, consequently the trees are further advanced. No signs of injury from frost could be detected, and the blossom is profuse on bushes as well as on trees, favourable weather being all that is necessary. Raspberries are grown extensively along the Clydeside; all are in good order so far as could be seen, but previous to digging and dressing a critic might have viewed them in a different light, as unmistakable signs of full-grown weeds were easily detected; and the practice of allowing the beds of the last crop of Strawberries to be so overgrown with rank weeds cannot be profitable. It is much easier and a great deal more profitable to kill weeds in their youthful stage than when fully matured and seeded several times over.

Digging in Gooseberry plantations has been wisely abandoned for some years, and I am sure the same would hold good with Raspberries. One plantation of Gooseberries was pointed out to me where many blanks were caused by the fungi from the roots of Apple trees allowed to remain in the ground instead of being grubbed out. From ten to fifteen years elapse after the tree has been removed before the fungi appear. Sawdust has similar results, and with me is so mischievous that I cannot but condemn its use, however valuable fertilising agents may be mixed with it. Here several large plantations of the Brown Beurré Pear were, after a few years' vigorous growth, in a dying state, while other varieties of Pears appeared healthy. Had the proprietor of these plantations been with me I would have asked for an examination of the roots, and I think the subsoil would have shown sand and rubble stones containing much iron. One large orchard had its trees all polled and regrafted, tar being used instead of grafting mixtures. It is to be hoped that fruit growers will come to see the folly of growing such crops of weeds for such sorry crops of Strawberries, and that the soil upon which they intend to plant will receive a thorough scientific investigation before risking expensive plantations.—W. T., *Lanarkshire*.

CLIVIAS, CALADIUMS, AND BEGONIAS
AT FOREST HILL.

MR. JOHN LAING is a very old florist, and not only determines as if instinctively the merits of new flowers and plants, but appreciates their capacity for improvement. He has raised new and superior forms of most kinds of florists' flowers during the last half century, and if he should happen to be able to continue his work for another similar period there is no telling what he would accomplish. But if he does not, what then? He has a son, and England and America know it. Yea, he has two, one the traveller, the other the home worker, both equally diligent and helpful to the respected head, and therefore the Laing dynasty in the kingdom of Flora is not likely to be soon extinct. Able and enterprising, the Laings have made a great business. They are sometimes said to have made the Begonia what it is to-day; but one of those individuals who seem to be born to dispute every proposition said the other day they had done nothing of the kind,

it was the Begonia that made them. The truth seems to be that each has added to the fame of the other. The firm is prosperous and the flowers beautiful, and are finding their way into houses and gardens innumerable in this and other countries.

But to the Clivias, please. These were once called by most persons, and still are by some, *Imantophyllums*. The shorter name is correct and agreeable, and the long one must lapse. The newer Clivias are stately plants with the darkest of dark green strap-shaped leaves, some more or less erect, some arching, but all forming a bold glossy setting to the noble heads of flowers. These are as large and shapely as Vallotas, but much more substantial, and when it is conceived that twenty to thirty of these crown the summit of each thick stem, and that the colours possess a soft rich glow of orange tinged with red, yellow tinted with rose, salmon suffused with buff, soft yellow with a sheen of purple, and so on in delicate blendings, the effect produced by a houseful of plants compels admiration. Then after the flowers fade seed pods form, and these in due time resemble clusters of red Cherries, but erect. Mr. Laing secured a few of the best obtainable forms of Clivias a few years ago, and fell into his old habit of crossing, and now has the satisfaction of seeing beautiful varieties unfolding, every one of them possessing great decorative value, and some showing such marked advance in size, form, or colour that make the eyes of the old master twinkle with satisfaction, and he then feels as he looks, almost as young as ever again. Among the varieties flowering a short time ago, and several of them probably still in beauty, for they continue attractive for weeks, are the following:—

John Laing.—This appropriately heads Messrs. Laing's Clivia novelties. It is a grand variety, in colour very deep orange red, perfect formed flowers in a dense umbel.

Lady Wolverton.—A grand acquisition. It produces reflexed flowers of a very large size, and is of perfect form with enormous truss. In colour the upper half is orange, with a pale yellow-and-white throat. Many will remember the grand spike of bloom of Lady Wolverton, carrying over thirty flowers, Messrs. Laing exhibited at the Royal Aquarium Show, and for which a first-class certificate was awarded.

Mrs. Laing.—This has been twice certificated, and well it merited the dual honour. It has a noble truss of bold, smooth flowers, reddish orange in colour, with a paler throat.

Orange Perfection.—This, which has also received the hall mark for excellence, was all aglow with its clear orange scarlet-tinted flowers, and very telling.

Sulphurea (F. C. C.) is in distinct contrast with the preceding, the colour being pale sulphur yellow; very soft and pleasing.

Sunray.—Quite new and very charming; rosy salmon, with yellow throat, the edges of the petals margined with white; a step in advance, and very distinct.

Those six are undoubtedly splendid Clivias, as are several more, including Bronze Queen, bronzy salmon; Delicatissima, orange and white; Exquisite, a blend of orange and lemon; Margaret, purplish orange; Crocea and Salmonia, the names of which indicate the colours. It would not be difficult to select a third half dozen, but it is not necessary for indicating the richness of a collection that may fairly be pronounced unequalled.

Clivias are easily grown, good loam, cleanliness, attention to watering, and a warm greenhouse being the chief requirements. But they are not "cheap" plants, because not common; and the varieties cannot be propagated like Fuchsias. Plants are raised from seed readily enough, and flower in a couple of years. But good parents are essential for good varieties, and Mr. Laing has very clearly found that a plant may be really cheap at ten guineas, though he does not charge half the amount for the best of those he can offer. Clivias are grand for spring, and go on flowering for many weeks, if not months, and are destined to have good positions in the best conservatories in the kingdom.

Now to Caladiums. When these most beautiful of foliaged plants were too generally neglected John Laing, to employ an expressive phrase, did not run away from them. On the contrary, he kept acquiring the best continental varieties till he formed a large and unique collection. Caladiums are now much more extensively grown than they were some years ago, and this is not to be wondered at considering the glowing richness and delicate tracery of their handsome leaves. Provide them with heat, moisture, and the requisite shade, and they will repay by their manifold charms in summer, then conveniently go to rest, and liberate space for plants that are required in winter.

Some varieties of Caladiums are stately plants, forming magnificent specimens, while others are dainty gems. The former are seen in striking force at the Crystal Palace shows, while the others may often be seen sparkling in the "effect" groups at summer exhibitions. At Forest Hill may be seen handsome specimens of such standard varieties as Anna de Condeixa, Baraquini, B. S. Williams, Candidum, Charlemagne, Comtesse de Condeixa,

Ferdinand de Lesseps, L'Aurore, Leopold Robert, Le Titien, Madame M. Scheffer, Madame F. Kæchlin, Mons. A. Hardy, Ornatum, Princess Royal, Raymond Lemoinier, Souvenir de Madame Bernard, and Triomphe de l'Exposition among others.

Among the dwarfier forms for table decoration, edging groups, and other purposes are Le Nain Rouge, new and very rich; argyrites, Chactus, Comte de Germiny, Ibis Rose, minus erubescens, and Salvator Rosa.

Most of the newer varieties are extremely beautiful, including James Laing, certificated this year; John Laing, Louis A. Van Houtte, Lilie Burke, Madame Groult, Madame Léon Say, Marguerite Gelinier, Mrs. Veitch, Oriflamme, and Reine de Danemark.

All or any of the above, and more that might be named, are worthy of a place in collections of stove plants, and the colours and characters are fairly described in the catalogue of the firm.

So much, in brief, for Clivias and Caladiums; but no one can call at the Forest Hill Nurseries in spring without being struck almost with astonishment at the work going on among Begonias. The number is quite bewildering, and men and boys are continually employed week after week for months pricking out the seedlings, transplanting to boxes, then in frames, as well as potting as the plants progress, and in preparation for the purpose for which they are required. It appears the demand is only limited by the power and means of production, and the rule is to raise as many as can possibly be grown into "good stuff" by the middle of May. In one house alone boxes containing 75,000 plants were being arranged, and there were—well, an uncountable number in other houses, and then many more in various stages from seed pans to frames, and thrifty specimens showing their buds. Long ranges of enclosures, 6 or 7 feet wide, formed by planks affixed on edge, were being nearly filled with warm hops from breweries as a genial bed for the plants that are put in, covered with glazed sashes, and neither shaded nor ventilated for weeks, and there they make fat stems and thick leaves. But it is really of little use going on where there is so much that cannot be told. When we thought we had seen all there was something more, and at last we were invited to peep into the "lion's den." The door was opened, and there sat a long line of boys pricking out Begonias, with the trainer at the end to keep the young animals in order—no light task, but it has to be done, for the world wants Begonias in ever-increasing numbers, even if they are reared in a menagerie, and every effort is made to produce as many as possible at Forest Hill. A great deal more might be said about these plants, but now we have got to "Laing's lions" it is time to stop.—A BEAR.

CELERY FOR LATE USE.

GOOD Celery forms from March to May an important dish in the daily supply from the kitchen garden, not only for salad, but for cooking purposes. During that time of the year green crops are not too plentiful, hence Celery, which can be served up in a variety of ways, is very acceptable. Much depends on the management to have a good stock available at that time, but every sort will not withstand such a winter as that experienced this season with impunity, and be available at the time named. Not only for the latest supplies, but for the whole season when Celery is required, commencing the first in September, I find none equal to Sulham Pink. Out of 1000 roots grown last season not six have decayed, and fewer still have seeded prematurely. I had this Celery in excellent condition on the 1st day of August.

Where many persons err is in sowing the seed too soon, inducing a free growth before the winter sets in; consequently, the Celery does not "keep" as it should do if sowing was retarded a little. Some, also, do not consider it necessary or wise to apply any covering to the leaves during frosty weather, but allow the frost to penetrate into the heart of every stem, which cannot be otherwise than injurious to the Celery for its long-keeping quality. Three or four degrees of frost will not injure Celery in the least; a temperature 10° below freezing point does much harm, especially after a spell of wet weather. In the autumn, when severe frost is expected, some strawy manure or litter is laid between the rows ready to be placed at the top of the ridge over the leaves to prevent frost penetrating into the hearts of the plants. The covering is removed directly a change takes place, and it is not replaced until absolutely necessary. If the straw covering is not taken off when not required, but remains on all day, perhaps more than one, it prevents the air drying the leaves and soil about the Celery. When the foliage is kept in a wet state frost causes far more injury than otherwise. If boards could be so arranged that rains may be warded off, and the Celery obtain a supply of air at the same time, I think its keeping qualities would be much improved. We sow the seed for the latest crop at twice about April 20th and May 10th, which periods allow for any unforeseen occurrence, such

as the difference of seasons, extra wet or dry. The seed is sown in boxes in a cold frame, and the seedlings pricked out in a temporary frame when large enough. The trenches are made to admit double rows. Planting is done directly the seedlings are large enough, not waiting till they receive a check in the operation. At all times plenty of water is given, especially when in the first stages. The final earthing is carefully performed, well sloping the sides to carry off heavy rains.—E. M.



JOTTINGS.

THE charming *Odontoglossum crispum*, which in so many gardens still bears the name of our popular Princess, has yielded more distinct variations than any other type in the genus; in fact, it has been correctly observed that scarcely two imported plants are absolutely identical in their characters. Necessarily in numbers of these the differences are very slight—a spot or two more or less, a shade of colour deeper or lighter, and it is recognisable as a variation, but not sufficiently marked to merit a special name. But amongst the thousands of plants imported to this country from their South American alpine homes, forms have occasionally, at wide intervals, appeared which possessed so many distinctive characters that they have even been assigned specific rank. They are, however, extremely rare, and are proportionately valued by connoisseurs when they are found, not merely because they are scarce, but because they are exceptionally beautiful in themselves.

There is an exquisite charm in a finely proportioned and richly marked *Odontoglossum* flower that is not surpassed even by the most superb *Cattleya* or *Lælia*, and it is not surprising that admirers of Nature's choicest handiwork find ample satisfaction in these delightful Orchids. I would venture an opinion that Baron Schröder derives almost as much pleasure from his unique collection of rare and beautiful *Odontoglossum* varieties or natural hybrids as he does from all the rest of his wonderful specimen Orchids. One of these forms with a long gracefully arching raceme of boldly marked flowers is an artistic study that the finest picture from the hands of the greatest master cannot equal. This is the opinion of an enthusiast, it may be said, but I know it is shared by other and better judges than myself who have ever found more to admire in Nature's floral masterpieces of all kinds than in the best of her human imitators.

But returning to *Odontoglossum crispum* and its well-marked types, a question was asked me a day or two ago that requires a few words in reply. The inquiry was, "Where are such *Odontoglossums* as *O. crispum* chiefly found—on trees or rocks, or the ground level? I have been told by a traveller that they are seen in some places growing together by thousands, forming, in fact, extensive fields." This traveller must have been indulging in the supposed privilege of those who wander in foreign lands—in other words, he was romancing. Perhaps "the wish was father to thought," for it would gladden the eyes of any traveller to collect *Odontoglossums* by the acre, as they might Buttercups and Daisies in this country. The operation is indeed a very different one, involving an amount of labour that few have any idea about. An experienced collector states that in his opinion for every half dozen plants of *Odontoglossum crispum* imported into this country a tree has been felled; and incredible as this may appear, the statement has been confirmed by other equally reliable authorities. A moment's consideration will show what this means, for in recent years thousands of plants have been brought into England and forests have perished to yield the floral gems so much prized here.

Beyond this, too, the exceptional types already referred to constitute possibly one in five or ten thousand of those so introduced, and we thus gain some idea of what is involved in the importation of *Odontoglossums*.

Most of the leading firms in England and on the Continent have shared in the work of introducing choice varieties, and the forms so obtained have worthily received commemorative, honorary, or expressive titles. I now have the pleasure of adding another to the list—*i.e.*, *Odontoglossum crispum* var. *Amesianum*, named in honour of F. L. Ames, Esq., Longwater, Boston, Massachusetts, who is one of the most successful Orchid amateurs in the United States. This is a peculiarly handsome variety, and deserves a place amongst the best of those hitherto obtained. The contour of the flower, the colour of the blotches, and their distinctive shape, together with the vigorous habit of the plant, render it in some respects unique. One flower from a raceme of nine is represented in the woodcut (fig 66), but a few words of description are needed. Measured from tip to tip of the petals the flower was $4\frac{3}{4}$ inches in diameter, the sepals rather over 1 inch across, and 2 inches long, broadly lanceolate, flushed with bright rosy crimson, and having in the centre two or three large irregular rich reddish chocolate blotches, and a few smaller ones near the margins of the two lower



FIG. 66.—ODONTOGLOSSUM CRISPUM VAR. AMESIANUM.

sepals. The petals are over $1\frac{1}{2}$ inch across, broadly rhomboidal, beautifully and evenly undulated at the margin, white with rich reddish chocolate spots confluent into a central clearly defined blotch, which is brought into bold relief by the wide pure white margin. The lip is almost triangular or hastate, with a yellow base and crest, a pure white margin, a solid central brown blotch, and a few smaller ones at the side. The whole flower is of great substance, and the crystalline texture of the petals is quite exceptional. This variety is flowering in Messrs. Sander & Co.'s nursery at St. Albans.

Increasing attention is being paid to Orchids in Holland, and this is probably the first year when two exhibitions have been specially devoted to those plants in the land of canals. A week or two ago a Show was held at Utrecht which is said to have been a fairly satisfactory display, amateurs contributing good collections and specimens. To obtain the weight of English authority in their jury, Mr. W. Watson of Kew was invited to assist in determining the awards. Towards the end of the present month a Show will also be held at the Hague, and the invited English representatives are Mr. J. O'Brien, and an individual whose name is occasionally seen in this column. The Chevalier Quarles Van Ufford appears to be the moving spirit in both schemes, for at Utrecht he was

the Hon. Secretary, and at the Hague he is the President, while recently he undertook a journey to this country in company with a friend to ascertain how Orchids are cultivated and shown in England.

Visitors to the Temple Show will be able to form some idea of the way these plants are grown here, and the wealth of British collections, for it is confidently expected that the display will even excel those of the two previous years, and they were something to remember. The only regrettable point is that they cannot be shown on banks, mounds, or in dells, as they are at Regent's Park, or as they were at the Royal Horticultural Society's Liverpool Exhibition a few years ago. That is the only way Orchids can be seen to the best advantage, on formal stages half their beauty is lost.—LEWIS CASTLE.

FURTHER NOTES ON MISS ORMEROD'S REPORT.

A FEW words in the preface to Miss Ormerod's valuable annual report upon destructive insects and some other pests inform us that this lady is now in somewhat improved health. I am sorry to find that she has suffered from close application to the many interesting subjects to which she has devoted time and anxious thought for many years past. All would rejoice, I am sure, that a lady who has done so much to distinguish herself amongst practical entomologists should still be able to continue her researches, which have been aided by a small band of fellow workers, and from which both farmers and gardeners have derived great benefits. I naturally turned at once to that important portion of the report which deals with the orchard caterpillars, concerning which we have heard a great deal during the last four or five years, and particularly about that of the winter moth (*Cheimatobia brumata*). It is in evidence, however, that taking England generally, even where no special precautions were taken against these caterpillars, they were less abundant in 1890 than they had been the previous year.

Miss Ormerod, and several of her fellow workers, appear now to be fully convinced that of all the methods suggested for the destruction of these most troublesome pests, nothing equals the syringing or spraying with Paris green, suspended in water by agitation, for it is not soluble. Professor Riley of America, indeed, advises the admixture of a small quantity of flour or starch with the water; but no satisfactory trial has been made in England of the application thus modified. In this Journal I have already expressed an unfavourable opinion with regard to the use of this dangerous insect killer, and need not repeat the reasons I then gave for objecting to it, except that the strongest one was that it is next to impossible to clear the trees thoroughly afterwards of a heavy insoluble compound such as this, and which, lodging in various nooks or angles, is likely to be a cause of mischief to human beings and the lower animals, even though it be used early in the season before the foliage is fully out. Much stress is laid in this report, I notice, upon the investigations of the Evesham Committee, the said Committee trying a variety of washes and applications, but finding that none of them approached the Paris green in efficacy. Doubtless Paris green may be relied upon to kill, and also the yet more deadly London purple, another arsenite of lime. The question is, Are we forced to adopt these because the other killers are unsatisfactory? Most of the fruit growers I have the pleasure to know in my district of Kent own they are reluctant to try this preparation, though so greatly extolled, as they feel apprehensive the remedy might prove worse than the disease. This report shows how the use of it has to be fenced round with cautions. We read that "Workers with the article should not allow it to settle in any crack of the hands, nor stir it about unnecessarily with the hands, and they should be very careful not to breathe in the powder through mouth or nose." Again, "It should not be used so as to souse the trees and run off the leaves in drops, nor should sprayings be given in rapid succession. Injury to leafage is likely to occur if the mixture is not kept of an even strength, and sediment allowed to form at the bottom." And again, "Cattle and stock, or other animals, should never be allowed to feed under trees that are being or have been recently sprayed, for fear of injury from the grass, upon which there may have been drip."

Then with regard to the frequent failure of the applications that have been formerly relied upon, I would remark that one reason for this was the inadequate apparatus employed. We have now great improvements in the form of spraying machines, and some of them are found to work admirably. Miss Ormerod has recently stated that an ordinary small barrel or two-wheel garden engine, if fitted with a Stott's nozzle, will answer very well,

Hemingway's, now advertised, is excellent. It seems to be acknowledged that although a wash made from softsoap and quassia wood is fatal to most aphides, it does not kill caterpillars. A petroleum wash has been often tried; doubtless it is the means of killing some, but fails to clear the trees. Lemon and Fir tree oil have been recommended; their costliness is against their employment on any large scale. A fruit grower tells me he has succeeded in destroying the caterpillars on his trees by means of a sulphur application, made as follows:—He boiled in an iron pan 7 lbs. of black sulphur (*sulphur vivum*) in 3 gallons of water, adding a lump of lime about the size of a man's fist. This was kept well stirred, and after fifteen minutes boiling 9 gallons more water added, and the boiling kept up for another twenty or twenty-five minutes. The clear liquid, after cooling and subsidence, is mixed for syringing in the proportion of 1 pint to 2 gallons of water. As to nipping the caterpillars in the bud, so to speak, by preventing the deposition of eggs, Miss Ormerod has shown that the "sticky banding," so called, may disappoint, owing to the females being lifted above it by their male companions. Also, it is difficult to hit the right time for the operation, the moths appearing at variable dates, and sometimes trees are hurt by the compound that is laid on. Miss Ormerod advises that the grease or smear should be spread over strips of common strong grease-proof paper, cut into suitable lengths of about 7 inches wide, and fastened round the trunk by string or a touch of paste.

In North Kent we found the lackey (*Bombyx neustria*) very abundant during the early summer, but no particular damage was reported to Miss Ormerod as attributable to this species, which generally selects the Apple amongst fruit trees. The "looper" caterpillars of the mottled umber moth, and the web-weavers of the small ermine species were complained of by some, and the familiar caterpillar of the vapourer was caught in several places while feeding numerously upon the Plum and Pear. This species, however, is such a liker of variety in diet that it is seldom noticed to greatly infest any particular plant or tree, and it is easy in the winter season to remove the empty cocoons left on the branches upon which the parent insects deposit their eggs.

An interesting portion of this report relates to the "Apple-sucker" (*Psylla Mali*), which, though it has figured on the list of hurtful insects for many years, has never apparently been a serious foe to the Apple till last year, when from three places widely separated statements regarding its proceedings were received. Were it to become common it would be a troublesome pest, for the insects (which resemble the scale or coccus) swarm in the young flower buds, and deprive them of their sap. Each larva or grub as it advances towards maturity exudes a number of fine hairs, which serve to protect it, and while quite small it is hidden within the bud. Owing to these facts washes have little effect upon it, nor is it much use seeking the eggs, since they are laid in various places about the tree. The winged insects appear in August and September, they are more active than the cocci, being able to run briskly, also to fly, but they may be caught and killed when depositing eggs. It was observed that this species was most plentiful on Apples which had crowded branches. A beetle, the blossom weevil of this same tree (*Anthonomus pomorum*) was unusually troublesome in several localities, at Swanley and Sittingbourne in Kent, also near Hereford, and it was stated by Mr. Hiam of Astwood Bank, near Redditch, that through this he reckoned that he lost 25 per cent. of his blooms. John Curtis long ago advised the placing of bands round the trees to keep the females from crawling up the trunks in March to lay eggs in the buds, one egg upon each, but Mr. Staples of Swanley remarks this plan is of no utility, for the weevils can fly readily. Miss Ormerod thinks the only effectual remedy where this weevil has appeared is that suggested by Schmidberger, that of picking off all buds on small trees which contain the insect, and with large trees shaking the boughs over cloths about the time the weevil has become a chrysalis, when they will fall out, and can be burnt. The date for this operation would be the end of May.

For some years past Miss Ormerod has been calling attention to the insidious proceedings of a group of minute creatures, the eelworms, which are the unsuspected cause of the death of many plants. One of these, *Aphelenchus Fragariæ*, the cause of what has been styled "Cauliflower disease" in the Strawberry, has just been described and figured in this Journal; it produces very curious and annoying effects, but as yet does not seem to have spread extensively. We are unprepared at present to deal with it, unless it be, as Miss Ormerod suggests, by the application of such chemicals as the sulphates of ammonia and potash, which have been proved of value in other cases of eelworm attack. The species, *Tylenchus devastatrix*, for a good while noticed upon Clover and Oats, has now been proved to affect field Beans, a circumstance that had been suspected. They are not destroyed by the decay of the plants on which they feed, so are probably sometimes conveyed with manure to new localities. Much injury was caused to

Willows in many parts of England by the Willow beetle, *Phratora vitellinae*, occurring almost by millions amongst some plantations. The trees receive a double attack from this foe; the hibernating beetles lay eggs in spring, the larvæ of which feed greedily upon the leaves in May, and then at the time the foliage is recovering somewhat the beetles emerge and assail the leaves during July or August.—ENTOMOLOGIST.

HARDY FRUIT.

[A prize essay read at a meeting of the Cardiff Gardeners' Mutual Improvement Society.]

THE subject of this paper being "Hardy Fruit," it naturally followed that the first question to be decided was what fruits should be regarded as hardy. Many consider wall fruits hardy, but, inasmuch as they require protection, especially the Peach, Apricot, Fig, and Vine, I am constrained to think all such should be omitted, more especially in the present instance, when we think of the number of fruits which, while being strictly hardy, are at the same time of sufficient importance as to be enough for a paper of much greater length than this. Therefore I have decided to omit wall fruit from consideration, also Nuts, and to commence with the Apple, following with the Pear, Plum, Cherry, Currants, Gooseberries, Raspberries, and concluding with the Strawberry; briefly giving their origin, but devoting the most space to their cultivation. I have endeavoured to be as practical as my experience will allow. I have grafted and grown all the Apples and Pears mentioned, with the exception of a few varieties, also the Plums and Cherries, struck the cuttings of the Currants and Gooseberries, and grown them and the Raspberries on to fruit, also the Strawberries.

THE APPLE.

The Apple is native of Britain, and found growing wild in the form of the Crab, and from which all the cultivated varieties of this grand fruit have been produced, some by careful hybridising, but by far the largest portion by the merest chance. This being so, the question might reasonably be asked, Why not grow our Apples right away from seed, without the intervention of the mechanical and tedious process of grafting? I would reply, Because out of every hundred seeds sown it is exceedingly probable that not more than one or two would be found equal to the parent, and none superior. The element of chance in fruit culture finds no favour with experienced pomologists, whether in the trade or out of it. It does not pay, and we owe many of our fine varieties of Apples to the enthusiasm of amateurs.

It is the established custom now to perpetuate varieties by grafting on stocks of a kindred nature raised from seed. Of these I give a brief description. First, The Crab stock, a native, preferred on account of its durability as a stock for orchard standards. That prince of pomologists the late Mr. Thos. Rivers, however, was a strong advocate for the Paradise stock, of which there are some four varieties. Second, The French Paradise, a miniature, surface-rooting, dessert Apple, extensively used at one time by nurserymen as a dwarfing stock. But Mr. Thomas Rivers improved upon this, and gave us three varieties of what is now known as the English Paradise—viz., the Nonesuch, Broad-leaved, and Pigmy. The first two are remarkable for the fertility they give to Apple trees, the Pigmy for its minute proportions, and in consequence is not much in demand. The Broad-leaved Paradise has undoubtedly proved itself of great value, especially in small gardens, where much space could not be afforded, and in cases where a quick return of fruit was of the first importance. Third, The "Free Stock," from the pips of Apples sown and grown until it is the size of the finger. This is the best, the most extensively used, and in the long run the most profitable, as well as the most natural.

The Apple may also be grown from cuttings, although it is not practised to any great extent. Yet undoubtedly good and durable fruit trees may be had by this method. I do not know whether any of our fruit-growing nurserymen grow any from cuttings. I have never seen any in the nurseries of my acquaintance. I am inclined to think that it would be a good thing if some of our leading nurserymen were to make a trial of cuttings, in order to ascertain if such trees struck from healthy cuttings are liable to canker. I have certain ideas respecting this disease, which I refer to further on. I will only say here that cuttings inserted, as is usual with other hardwooded things, from October to Christmas, will take root, and ultimately form trees, though they do not grow with that precocious vigour which is characteristic of the graft, and this is no doubt the reason why they are not more frequently grown. I will not say to describe the means adopted to raise the various kinds of stocks. I will only say that in two years, or at the most three years, they would be of a suitable size for grafting upon. In most nurseries they are set in rows 4 feet apart, and 1 foot between the plants, and there they are grafted.

Grafting operations commence in spring, as soon as the sap is in rapid motion—late in March or early in April. The stocks are then headed back to within 6 inches of the ground, a slice taken off the side, with a transverse cut across for the insertion of the tongue of the scion. An expert knifeman will fit it so that the bark of both stock and scion shall be in conjunction, though this is not always possible all round, but it is very desirable; and it is to be regretted that the exigencies of trade do not permit of closer attention to this important part. The cambium of both being fitted together it is firmly kept there with a binding of matting, and afterwards covered with grafting wax (a much more efficient method of excluding the air and preventing evaporation

than the old custom of covering with a mixture of clay and cow manure), and the process is complete. Low grafting is found to be the best. No cultivator would go higher than 6 inches, while many graft below the surface; and there is much to be said in favour of such a method, inasmuch as it is possible to hasten and to make the union more effective by earthing the part up with soil.

Budding is another form of grafting, and takes place in August. I would sooner have budded than grafted trees; to my thinking the union of stock and scion is more complete, and there is less danger of canker, and I believe it will continue to grow in favour. The stock needs little preparation beyond cutting away a portion of the lower branches for convenience; the bark of the stem is then opened, and a bud inserted. Those who have ever budded a Rose will need no further description of the process. It is similar in every respect to budding on the Manetti in Rose culture.

The grafting operations of spring will result in maiden trees the same season, any that fail will come in for budding in August. These remain dormant until the spring. They are then headed back to within 6 inches of the bud. This 6 inches is left to act as a support, to which the young bud may be secured when it bursts forth in spring. Handsome and straight trees are the result of budding. Some varieties are more prone than others to produce pyramids; others again will make a clean stem of 6 feet, all such are taken for standards. Apples are grown in various forms; there is the standard high and low, pyramids, bushes, espaliers, and cordons. Some prefer one shape and some another. I do not care for cordons, it seems to me to be a too restricted form. I prefer the horizontal form for espaliers, the bush for the open ground, and the standard for orchards, and I believe the majority of gardeners are of the same opinion.

The popular idea of an orchard is a piece of land planted with fruit trees in regular lines at equal distances apart, enclosed by a hedge and laid down in grass for grazing. There is a growing conviction, increasing in volume every year, that the time has come for a sweeping change in our ideas of fruit culture in general, and in orchard trees in particular. To the credit of gardeners be it said, aided by the horticultural press, they are not behind in this matter. It is gratifying to notice the improvement which is manifest with regard to garden culture of fruit trees, but the orchards of the country are under their control, only to a small extent. Were they in the charge of gardeners, what with the splendid varieties of Apples we have and the improvement of our knowledge of the principles which govern fruit culture, we should soon see a change for the better, and the day of the poor varieties of Apples which glut the markets of the country would have an end.

It has often occurred to me that the walled enclosure is not the proper place for large fruit trees and vegetables at the same time. Let it be one thing or the other. The vegetable quarters should be free and open on all sides, with a standard if you like in the centre of the squares. The old idea, too, of espaliers to line the sides is good, and ought not to be lightly set aside. If such ideas were adopted we could devote more time and attention to the orchard proper.

Apples would take the most exposed side of the orchard, and should be planted 25 feet apart in well prepared ground. Grass walks might intersect every two rows, the ground around the trees being kept open and manured, much in the same way as we would do in a Rose garden. I fail to see why we should take so much trouble with our Roses and neglect the more valuable fruit trees. Let the air and sun heat into the soil, and apply manure to encourage the roots near the surface. Low bushes of Currant and Gooseberries could be grown between the trees, and the whole kept as a fruit garden, and not as grazing ground for sheep. Standards two years old can be purchased at 2s. each, or less if a quantity is required. They are better than maiden trees, and are generally furnished with from three to five shoots. Cut off with a sharp knife all roots the ends of which were damaged in lifting, endeavour to keep them within the top foot of ground when planting, press moderately firm, but do not ram hard, and secure the young tree to a stake. It is best to leave the pruning until March in the case of newly planted trees; they should then be cut back to four or five eyes. This hard pruning is necessary to form the foundation for the future head; no central shoot should be allowed; mulch around the roots and let the tree alone. After the first year, unless the growth is irregular, there will be no need to cut back, but thin weakly growths, keeping an open and well-balanced head, merely removing the tips some 3 or 4 inches, not more. In the cases of good strong stout shoots but not long 1 inch would be sufficient. This makes the base of the tree strong enough to bear the future and stop the weeping tendency which totally unpruned trees are inclined to take. Always remember that light and air are necessary to produce fertility; hide the light, and we get a mass of leaves which have not the texture of those which encourage the development of fruit buds at their base. Attend to this and be liberal to the roots, and the orchard would prosper.

Espaliers.—Nurserymen usually take considerable pains in training these into the horizontal shape. In the grafting quarters those trees which are not required for pyramids or standards are headed back to 1 foot. They require watching, however, previous to training in order to induce them to throw the laterals properly. When one pair is made and the leader is going ahead it is sometimes necessary to pinch the point to get the second pair. In midsummer the trees are trained to a rough trellis made on the spot by driving small stakes in the soil on either side of the tree; cross pieces are fastened with matting, the tree being brought into position as soon "knocked" into shape. If maiden trees are preferred this operation can be most satisfactorily done on the espalier they are intended to cover. Espaliers if of iron are a costly

item I admit, but it is a form of fruit tree training that looks well in a garden. As they do not reach higher than 5 or 6 feet they throw no shadow to speak of, and with judicious pruning will yield a fair return of fruit. Of course it is not the most profitable form, but in the gardens of the rich this is not the first consideration, and there are other places where no other form is so well adapted, especially in the small grounds of suburban villas, of which we have so many around us. Their price varies from 2s. 6d. maidens, to 5s. according to age and number of shoots. The summer pruning of espaliers consists in encouraging the extension of the main laterals, thinning out unnecessary shoots when quite young, and breast pruning the remainder in August. Winter pruning, if the summer work was well done, will consist of little else than cutting off the extremity of the main laterals, keeping the spurs free from each other without crowding, taking care not to cut away any young wood that would be likely to form fruit buds. The Apple is not so largely used for espaliers as the Pear or Plum, but it will succeed and yield fine fruit. I have seen it grown as a wall fruit, but it does better on the espalier than on walls. Root-pruning as well as canker I deal with separately further on.

Bush fruits may be planted in the garden or the orchard. The latter is the best place for them, but if in the garden the espaliers have to clear out, and these then line the sides of the walks instead; there is certainly something noble in an avenue of well grown fruit trees, more so if well loaded with fruit and needing support. In small gardens where space is not plentiful and this form is wanted, have trees on the English Paradise, but where room is no object employ the free stock. On the Paradise, 8 or 9 feet apart will be ample, while for the more vigorous free stock double that distance will not be too much. Plant maidens from a good and reliable source, true to name and on the proper stock, even if the price be a trifle higher. By having maiden trees, the gardener has the making of his trees from the start. It is impossible to give directions on paper for pruning that would apply with equal force to every individual tree; every tree should be studied separately.

There is no greater evil in a garden than the inexperienced apprentice who has just been presented with a new knife, and yet I have seen valuable fruit trees in quantity entrusted to such hands for pruning. I have myself pruned so-called valuable fruit trees in quantity when I had not mastered the rudiments sufficiently to make a workmanlike cuts. But that was long ago, since then fruit culture has made great strides and I hope to live to see it take rank as one of the great industries of England.

To avoid repetition I would say that in the main the instructions for the pruning of standards also govern bushes to a great extent, making allowance of course for the shape of the tree. Keep it well open, reduce weakly growths in summer by cutting them right away, or pinch them off when in a young state, only allow the necessary quantity for new spurs and renew old ones. In winter the ends of the main branches should be just tipped, and the spurs cut in to four or five buds; every branch should be at least a foot distant from the next. By doing this we keep the interior of the bush nearly as fruitful as the exterior, light and air being the chief factors in producing fruit. If this was fully understood and appreciated as it should be we should not have to attribute failure to this cause and to that, such as soil, subsoil, stocks, &c.; we should hear less of these excuses.

Throughout fruit culture there is of course great uncertainty. The best of cultivators have to cultivate patience too. Some seasons we have abundance of rain with a minimum of sunshine. This is of course beyond our control, but we know that the crop of the following season will suffer through the immaturity of the wood made under conditions. Again, rough winds and late frosts baffle us, also seasons of great drought. We need not complain of our climate for all that. Other countries, too, have their drawbacks, but it certainly does seem as though there were localities in America where the Apple loves to grow. How otherwise could the American growers produce such quantities as they do, and sell in our markets fruit grown 4000 miles away cheaper than we can afford to sell our own? It is a work of time, but I believe that the day is coming, judging from the signs of the times, when the attention of the country will be concentrated on the possibility of raising fruit culture to the rank of a profitable industry that deserves encouragement, by keeping on the land more labour, and relieving our towns and cities of the enormous pressure of populations, with all its train of evils.

I believe there are over 1000 varieties of Apples. To be able to pick a good selection out of this vast number is at once perplexing and easy. But select how we may, we should soon find plenty of critics to censure our selection on account of the absence of their particular favourites from the list. These, I believe, will cover the year round, but if only a small number are required then take those marked with an asterisk (*). *Dessert*.—Duke of Devonshire, Fearn's Pippin, Court Pendu Plat, Dutch Mignonne, Old Nonpareil, Reinette de Canada, Kerry Pippin, Northern Spy, Lord Burghley, Cockle Pippin, Early Red Juneating, *Duchess of Oldenburgh, Scarlet Nonpareil, Sturmer Pippin, Ribston Pippin, *Cox's Orange Pippin, Golden Reinette, *King of the Pippins, Red Juneating, Irish Peach, *Worcester Pearmain, Early Harvest, Margil. *Culinary*.—*Ecklinville Seedling, Annie Elizabeth, *Keswick Codlin, Hawthornden, *Lord Suffield, Manks Codlin, Mère de Ménage, Winter Majetin, Cox's Pomona, Hoary Morning, Alfriston, *Dumelow's Seedling, Warner's King, Small's Admirable, Bedfordshire Foundling, Cellini, Blenheim Pippin, Kentish Fillbasket, *New Hawthornden, *Stirling Castle, *Tom Putt, Frogmore Prolife, Striped Beeching, *Alexander, Rymer.

(To be continued.)



EVENTS OF THE WEEK.—The British Fruit Growers' Association has a meeting at the Horticultural Club to-day (Thursday) at 5 P.M., and the Linnaean Society meet at 8 P.M. The Royal Botanic Society meet on Saturday, May 9th at 4 P.M. On Monday, May 11th, the United Horticultural Benefit and Provident Society's Committee will meet at 8 P.M., and on Tuesday, May 12th, the Royal Horticultural Society's Committees meet in the Drill Hall, James Street, Westminster, at twelve noon.

— THE CRYSTAL PALACE HORTICULTURAL SUMMER EXHIBITION, which is always one of the great attractions of the year, will be held on Saturday next, May 9th, when the usual substantial prizes for specimen plants and cut flowers will be competed for in numerous classes. The Show is expected to be fully up to the standard of previous years.

— THE WEATHER IN THE SOUTH has been much more seasonable, the rain which fell on Saturday and Sunday being most welcome. A rapid advance has been made in the foliage and flowering of fruit and other trees during the past week. Plums and Pears are showing extremely well, and Apples also look promising. A Devonshire correspondent says, "The frost has not done anything like the damage here that it has about London. Escallonia macrantha is but slightly browned on the tips of the leaves, Phormium tenax is uninjured, also a Cordyline 10 to 12 feet high, but some shrubby Veronicas are killed." Mr. Davies, Mote Park Gardens, Maidstone, writes, "We had some rain here at last on Friday, and again on Saturday, 0.24 inch in all, but we must be thankful for small mercies. Still the rain could not come without frost when everything was wet on Saturday night, cutting Potatoes that were through the soil."

— WE are desired to state that MESSRS. MESSENGER AND COMPANY, horticultural builders, hot-water engineers, &c., of Loughborough, Leicestershire, have taken a London office at 163, Palmerston Buildings, Old Broad Street, E.C.

— APRIL IN STIRLING has been a cold dry month with a mean temperature of 42°. The maximum was 65° on the 17th, the minimum 20.6° on the 1st. Frost was registered on thirteen nights, amounting to 60°. May 1st was a warm night, 46°, but the night of the 2nd left the hills white with snow.—G. MCD.

— PRIMULA CAPITATA.—Reference is made at page 345 of the Journal of last week to the hardiness of this plant. In a low lying situation in the suburbs of Birmingham, but within the city boundaries, a large number of plants of the varieties can now be seen in bloom, having stood out in the beds and quite unprotected during the winter. Primula denticulata has also stood the winter safely, planted out on rockwork in an exposed high situation in the neighbourhood of the metropolis of the Midlands.

— PANSIES are late in flowering this year, and the long spell of cold winds are producing roughness in the early blooms. It is to be hoped that genial warm weather will soon set in, as the Midland Counties Pansy Society's Exhibition is fixed for June 10th at the Central Hall, Birmingham, and prizes for Pansies are specially offered at York on June 17th. The display of Pansy blooms increase there year by year; thus giving the Yorkshire and Lancashire growers a good opportunity of seeing so many of the new varieties, as some of the great growers from Scotland attend with their seedlings also.

— PULMONARIA OFFICINALIS.—The reason I suppose that this old-fashioned Lungwort is not more often seen is because it is thought too "common." In good sized clumps at the front of the shrubbery this plant brightens many an otherwise bare spot throughout the month of April. We have it growing in masses a yard across. It is perfectly hardy, does not need a rich soil to grow in, is easily increased, and is certain to produce abundance of red flowers, which change to violet afterwards. By dividing the roots at any time, except when in flower, a large stock can quickly be raised.—E.

— A SPECIAL display of CATTLEYS AND ODONTOGLOSSUMS is expected at the approaching meeting of L'Orchidéenc, the Amateur Orchid Society of Brussels, which will be held in the Parc Leopold on May 17th, 18th, and 19th next.

— THE HORTICULTURAL CLUB.—The usual monthly dinner and conversazione will take place at the Hotel Windsor on Tuesday, the 12th inst., at 6 P.M., Sir J. D. T. Llewellyn, Bart., in the chair. The subject for discussion will be "Gardens and Plants in the West Indies," illustrated with lantern slides, to be opened by Mr. D. Morris.

— THE DEATH'S HEAD MOTH AND HONEY BEES. — Some entomologists are anxious to clear up the mystery that attaches to the proceedings of the death's head moth, and they hope for the assistance of the many bee-keepers who read the Journal. This moth emerges from the chrysalis in June or July. The points of importance to know are:—1, Does it haunt the vicinity of bee hives? 2, If so, is it merely attracted by the smell of the honey, or does it go there with the express intention of entering the combs? 3, How are the bees affected by the moth—are they alarmed by its cry and lustrous eyes, or will they attack it as a foe?

— THE YELLOW ANEMONE.—*A. alpina sulphurea* makes a good show on the rockery when planted in conjunction with other members of the family. As yellow flowers during the month of April are scarce, this Anemone is all the more welcome. The foliage, which is plentifully produced, is deeply cut, and enhances the appearance of the deep yellow flowers, which are not too abundantly developed, as in the case of others of the Windflower family.—M.

— MR. J. W. MOORMAN, who had the immediate supervision of the laying out of Camberwell Park (Myatt's Fields) for the Metropolitan Public Gardens Association, which after completion was taken over by the London County Council, has been recently promoted to be superintendent of Brockwell Park, a valuable addition of seventy-eight acres to the South London recreation grounds. Mr. J. Pallett from Battersea Park succeeds Mr. Moorman in charge of Myatt's Fields.

— THE TOTAL RAINFALL AT CUCKFIELD, SUSSEX, during April was 0.37, being 1.38 inch below the average. The heaviest fall was 0.30 inch on the 4th. Rain fell on four days. The total fall for the four months is 3.11 inches below the average. Highest temperature, 62° on 28th and 29th; lowest, 30° on the 2nd; mean maximum in shade, 51.1°; mean minimum, 34.2°; mean temperature, 42.6°. Partial shade readings a little below the average.—R. I.

— THE WEATHER DURING APRIL, 1891.—The past month was remarkably dry, with a very low temperature, and sharp frosts in the early mornings. There has been very little sunshine on the whole; in fact, during twelve days the sun was scarcely visible. Vegetation is very backward, but fruit trees are promising remarkably well. Rain fell upon ten days during the month; maximum in any twenty-four hours was 0.33 inch on the 4th; minimum, 0.01 on the 7th; total for the month, 0.90, against 0.77 of 1890.—E. WALLIS, *The Gardens, Hamels Park*.

— THE most recent issue of the ROYAL HORTICULTURAL SOCIETY'S JOURNAL, part i., vol. xiii., March, 1891, which is just to hand, contains much of an interesting character. It includes the papers read at the Dahlia and Grape Conferences, also those read at the ordinary meetings of the Society during last year, together with extracts from the proceedings of the several committees, and a list of certificated plants. We shall have occasion to refer at a greater length to this part of the Society's Journal another week.

— ACCOMPANYING the volume is a leaflet giving the following particulars concerning the TEMPLE SHOW this month and the Society's dinner in June:—The date of the Temple Show has now been definitely fixed for Thursday and Friday, May 28th and 29th. The Show will be opened at 1 o'clock on Thursday, May 28th, by Her Royal Highness the Princess Christian. The band of Her Majesty's Scots Guards will be in attendance each day. Admission: Fellows, free on either day, on showing their Fellows' tickets. The public by purchased tickets: For Thursday, 3s.; for Friday, 1s. To avoid the inconvenience of crowding, these tickets may be obtained beforehand at the Society's Office, 117, Victoria Street, S.W. On the days of the Show they will be on sale at the entrance to the Gardens only. Gates open on Thursday, 1 to 8 P.M.; on Friday, 10 A.M. to 6.30 P.M. On Tuesday, June 23rd, a dinner of the Royal Horticultural Society will be held at the Whitehall Rooms, Hotel

Metropole, Charing Cross, at 6.30 for 7 P.M. precisely. Tickets 12s. 6d. each, not including wine, may be obtained on or before Saturday, June 20th, on application to the Secretary, 117, Victoria Street, Westminster. Early application is particularly requested. N.B.—All applications for tickets for the R.H.S. dinner or the Temple Show should contain postal orders and a stamped and directed envelope.

— THE LATE MR. JOHN WILSON.—We regret to announce the death of Mr. Wilson, at his residence in Maida Vale, London, on the 28th ult., after a short but painful illness. Mr. Wilson was for a number of years in business in York, and was one of the founders and guarantors of the Great York Gala, and for about twenty-eight years its Secretary. Many old exhibitors and judges will feel regret at his death, for pleasant memories remain of his kindly attention and courtesy to exhibitors and others, by whom especially he was much esteemed.

— THE WARE HORTICULTURAL MUTUAL IMPROVEMENT SOCIETY.—At a meeting of this Society, held on the 28th ult., an able paper was read by Mr. Alexander on "Peach Culture." A lengthy discussion followed, in which Messrs. Brown, Smith, King, and others took part. Mr. A. King exhibited a dish of fine Seakale and some fresh Camellia blooms cut from plants in the open, where they have been growing for the last five years with no more protection than a mat placed over them during severe weather. Votes of thanks to the essayist and to Mr. Brown, who presided, brought the meeting to a close.

— CROSS-BRED AURICULAS.—The cross-bred Primulas, shown for me by Mr. Douglas at the Scientific Committee of the R.H.S., were not Primroses, but self Auriculas. The parent was the lovely blue Simonite Mrs. Douglas, the pollen used having been that of a dark maroon coloured kind, with rich golden eye. These two types, I believe, always preserve their characteristic eye colours respectively. The crossed seedlings have dark flowers of a sort of mixed tint, showing both brown and purple. The eye is either a fairly clear lemon or partially dusted with white. Now, here is a curious deadlock at the first start. If I cross again with the golden eye the blue will be extinguished, if I cross with blue the white eye will come back again.—R. TREVOR CLARKE.

— STRAWBERRIES BOTHWELL BANK AND PRESIDENT.—Thanks to Mr. Doughty and "W. T." for their reply to my query "Is Bothwell Bank not President under another name?" By Mr. Doughty's note it is quite evident that what he has for Bothwell Bank is distinct from the variety I have. "W. T." suggests that Mr. Doughty must have either Admiral Dundas or Dr. Livingstone, which he knew to have been grown at Bothwell Bank. Seeing Mr. Chisholm has made no reply, I will endeavour to cast some light on the origin of Bothwell Bank. Whether the original plant was a chance seedling or an accidental runner dropped at the root of a Gooseberry bush I know not. The plant was—as my informant who had seen it, told me—growing for some years without any notice being taken of it, until one year it fruited splendidly. The plant disappeared from its old home on the Tay, whence no one knew, until one of the young men was some time after visiting his old bothy mate at Bothwell Bank, to whom Mr. Chisholm related his triumph in sending out as a new Strawberry that to which no heed had been paid at Camperdown.—G. MCD.

— AT a recent meeting of the DUTCH HORTICULTURAL SOCIETY the Floral Committee awarded first-class certificates to Messrs. E. H. Krelage & Son for *Chionodoxa gigantea*; to Mr. H. J. Van Heijst for *Arum palatinum*, *Veltheimia curvifolia* and *latifolia*; to Messrs. De Graaf Brothers for *Hippeastrums Koningin Wilhelmina* and *Conqueror* and *Tulipa Kaufmanni*; to Mr. C. G. Van Tubergen, Jun., for *Chionodoxa gigantea* and *Iris Rosenbachiana*; to Mr. J. Dibbets for *Tulip Pink Beauty*. Second-class certificates were accorded to Messrs. E. H. Krelage & Son for *Fritillaria Walujewi*; to Messrs. De Graaf Brothers for *Hippeastrums Hercules* and *Shakespeare*; to Mr. J. C. De Lange for *Odontoglossum crispum* var.; to Dr. J. Th. W. Neeb for *Cymbidium ensifolium*; and to Mr. C. G. Van Tubergen, Jun., for *Iris reticulata* var. *major*. Botanical certificates were granted to Messrs. E. H. Krelage & Son for *Allium Regelianum*, *Chionodoxa cretica* var. *albiflora*, *Ornithogalums exscapum* and *Kotschianum*; to Messrs. De Graaf Brothers for *Tulipa turkestanica*; to Mr. H. J. Van Heijst for *Primulas Palinuri* and *frondosa*; and to Mr. C. G. Van Tubergen, Jun., for *Cyrtanthus angustifolius*.

— SUMMARY OF METEOROLOGICAL OBSERVATIONS AT HODSOCK PRIORY, WORKSOP, NOTTS, FOR APRIL (56 feet above sea level).—Mean temperature of month, 41.7°. Maximum on the 30th, 64.2°; minimum on the 1st, 23.4°. Maximum in the sun on the 30th, 116.1°;

minimum on the grass on the 1st, 15.2°. Mean temperature of the air, 43.1°. Nights below 32°, in the shade, sixteen; on the grass, twenty. Total duration of sunshine in the month, eighty-six hours, or 21 per cent. of possible duration; eight sunless days. Total rainfall, 1.39 inch. Rain fell on seventeen days. Average velocity of wind, 9.7 miles per hour. Velocity exceeded 400 miles on two days, and fell short of 100 miles on five days. Approximate averages for April:—Mean temperature, 46.4°; sunshine, 123 hours; rainfall, 1.66 inch. A dull, rather dry, and very cold month, with a great deal of N.E. wind. No April in the last sixteen years has been so cold, and only one of the last ten years has had less sunshine. The night temperatures were lower, and we had actually less sunshine than in March. A maximum of 60° was only reached on the last day. All vegetation is very late.—J. MALLENDER.

— THE BLACK CURRANT MITE.—From the general distribution of the above mite I fear the task of extermination will be a difficult one. Picking off the buds as practised by Mr. Walter Kruse, especially when done by assistants, will not be effective. One bud dropped or not picked cleanly from the twig will render the labour abortive. Where a few buds are affected only it might be accomplished, but even that is not a desirable way, as no doubt the mites travel from exhausted swollen buds to healthy and unsuspected ones, and when these blossom the bees carry them from affected to healthy plants. Nothing but pruning closely and burning immediately they are cut will suffice, and this should be performed during December or January, keeping a strict watch thereafter for every suspected bud. Experiments by syringing with petroleum might assist in warding them off; as it is the centre of the buds that the mites attack any arsenical or poisonous solution would not be likely to reach the parts the mites eat. Then every one should do something, as one in a neighbourhood neglecting precautions will infect a wild area, through bees and other insects transmitting them.—W. T.

— THE VALUE OF FLOWERS.—We sometimes see reports of the prices obtained by American florists for bouquets, &c., but in a recent case the evidence indicated that our own florists have not much to complain about in this matter. A London florist sued a customer for the recovery of £34 17s. 6d., declared to be owing for flowers. The defence was that the charges were excessive. The main opposition was that 5 guineas had twice been charged for bouquets, and 10 guineas for one supplied to him last Boxing Day. "The reason, it was said, that 10 guineas were charged was because of the time of year, and that two young ladies were occupied the whole of Bank Holiday upon this bouquet. For nine years defendant had dealt with the plaintiffs, and always paid similar sums to these for flowers. One of the plaintiffs said one of the items of 5 guineas was for a basket of flowers. The basket would be about 3 feet high, and cost about 17s. 6d. Then it was filled with pink Roses. The usual price for a buttonhole was 1s. 6d., but sometimes defendant was charged 3s. 6d. because he had a very large one made. The actual cost of the bouquet was £8 15s. 6d. The balance was the profit. The defendant generally wore Carnations in his buttonhole, and the usual charge for them was 3s. 6d. Judgment was given for plaintiffs for the amount claimed."

TOP-DRESSING POT PLANTS.

THE principal objection which Mr. Hugh Dale urges against this practice is one that carries considerable weight in certain cases; but I believe those cases are exceptions rather than the rule. In the majority of instances when plants are top-dressed the roots are in a healthy condition, and root so quickly into the fresh soil that the difficulty about knowing when to water is really more imaginary than real.

With the pots crammed full of roots and the whole mass thoroughly watered through a rose after top-dressing, those in charge of the plants ought not to be deceived or be in doubt as to when to give water, and it is surprising to see how quickly plants "pick up" after having been top-dressed; this in itself should be a proof that the watering difficulty has been overcome. I do not advocate this practice instead of the highly beneficial one of dressing with artificial manures, but to be used in conjunction with it, for this reason, after repeated dressings with artificial manures the soil becomes close and sour on the surface. Then if this is removed and a suitable top-dressing given, young roots quickly push into it and are in the best possible condition to benefit from dressings of artificial manures, the value of which it would be difficult to over-estimate.

CUTTING OFF THE ROOTS OF PALMS.

I cannot help thinking that the Palms which Mr. Hugh Dale mentions as being annually killed by the disrooting process must have been in a very unsatisfactory condition when that operation was performed, as I have never in a single instance failed to carry the plant through the ordeal satisfactorily when the operation was conducted under the con-

ditions given in my previous article. My experience leads me to believe that the great loss that we sometimes see in Palms is due to the fact that they are disturbed at the roots at a time when their constitution is debilitated by having been used for decorative purposes in unfavourable positions, and by not taking the necessary precautions to keep them in a close moist house, where they are well shaded from sunshine for a few weeks after the roots have been curtailed.—D.

PEACHES AND NECTARINES.

SETTING FRUITS WITH THE SYRINGE.

I DO not for one moment suppose that Mr. H. Dunkin would feel flattered at my reply to his criticism; at any rate, he seems to have extraordinary faith in his own opinions on the matter, but with all his arguments I fail to see how he has shattered my objection to syringing Peaches in bloom; the facts remain indisputable. With respect to modifying my assertion, the word was merely altered to suit my fastidious opponent, not the meaning of it. I simply endeavoured to fix it so that there was no possibility of warping it into something else. If your correspondent can give me absolute proof of the efficacy of his system I shall only be too pleased, but having tried it a great many times, and also seen it tried by other experienced practical men with very meagre success, I have stamped it as doubtful, and I have yet to learn I am in error. Then our friend tries to draw a parallel between rich Vine borders and Peach blossom, which is a wide shot. The former are easily subjected to modification, but there can be no alteration in the structure of a Peach flower, and we must have made slow progress, comparatively speaking, in the way of fertilising Peaches when we are still pursuing the same plan our forefathers did; surely this fact alone proves the soundness of it. The success attained by syringing pointed out by your correspondent was brought about in all probability by being performed in a house that had previously been kept far too dry in the flowering stage, and the syringing equalised matters and so brought about the desired state of things to ensure a good set. My opponent still finds fault with the brush, but it is not its inefficiency but the fault of imperfectly developed flowers. I presume the syringe would not put that right.

Then Mr. H. Dunkin seems filled with a burning desire to know under what conditions I practised with the syringe. Out of numerous instances I will give him one of the most important—viz., a lofty lean-to vinery, containing Gros Colman, Lady Downe's, Alnwick Seedling, Alicante, and Golden Queen were syringed judiciously about midday during the flowering period, at which time the weather was of the most brilliant description, and highly favourable to the success of the experiment. The Vines were not deluged, but syringed sufficiently to disperse the pollen, and I do not think in all my experience I ever saw a more miserable set. Then my adroit critic becomes exultant, for he is the first I ever heard of who was able to shatter practical facts to such an extent as to be able to drive a carriage and pair through. "What a grand avenue!" this is, indeed, the height of fervent imagination. But, Mr. Editor, as I have already trespassed too much on your valuable space I will conclude, as I cannot see any matter of practical importance in my friend's remarks to necessitate any further reply from me, wishing him every success with the theory he so emphatically upholds, I will finally leave him to pursue the error of his ways.—J. J. C.



ROSE MRS. PAUL.

FEW Roses obtain the coveted distinction conveyed by the award of the National Rose Society's gold medal, and so much care is exercised in conferring this honour, that it is a reliable indication of exceptional merit. Messrs. Paul & Son of Cheshunt were successful some time since in raising a series of seedlings from Madame Isaac Pereire, and by far the best of these which has yet come under our notice is that bearing the name of Mrs. Paul, and of which we are enabled to present an illustration in fig. 67. This handsome Rose, one of the Bourbon type, was shown last year with much success, as besides securing the gold medal of the N.R.S. at the Crystal Palace, it was adjudged awards of merit and certificates by the Royal Horticultural Society, the Royal Botanic Society of London, at Manchester, and elsewhere; it has quite a long record of distinctions in fact.

The flowers are notable for their great substance; the petals broad, thick, and being well expanded at the outer part of the bloom give it a very imposing appearance. The colour is a delicate rosy blush shade, becoming nearly white when fully open; but the centre is always of a clear pleasing pink tint. The plant is of good constitution and evidently well adapted for culture in pots and forcing, for Messrs. Paul & Son had a plant in flower at one of the Drill Hall meetings early last month, and the flower was as fine as that depicted in the engraving.

ROSES FROM CUTTINGS.

Where Roses are grown in pots to flower during April they afford a ready means of increasing the stock by cuttings. At no time of the

year can Roses be increased so readily by this method as at the present ; nine out of every ten inserted properly and treated in the same way are certain to grow and make useful little plants by another year. Not only do these remarks apply to the various climbing Roses, such as Reine Marie Henriette, Lamarque, Gloire de Dijon, and the like, but are equally applicable to the Hybrid Perpetual section, which are general favourites during the month named, either when growing on the plants or in a cut state. When the flowers are past the shoots which bore

one eye inserted in the soil from which roots will push, and two above to provide future growth is all that is needed. Make a clear cut below a joint, removing the leaf, retaining the two above intact. Insert the cuttings firmly, five in a 3½-inch pot, using sandy soil, with a sprinkle of silver sand on the surface, a little of which will be carried to the bottom of the hole by the dibber when inserting the cuttings ; roots form more quickly in sand than soil. Give a gentle watering to settle the soil and sand, and plunge the pots in a gentle bottom heat, in either a propa-

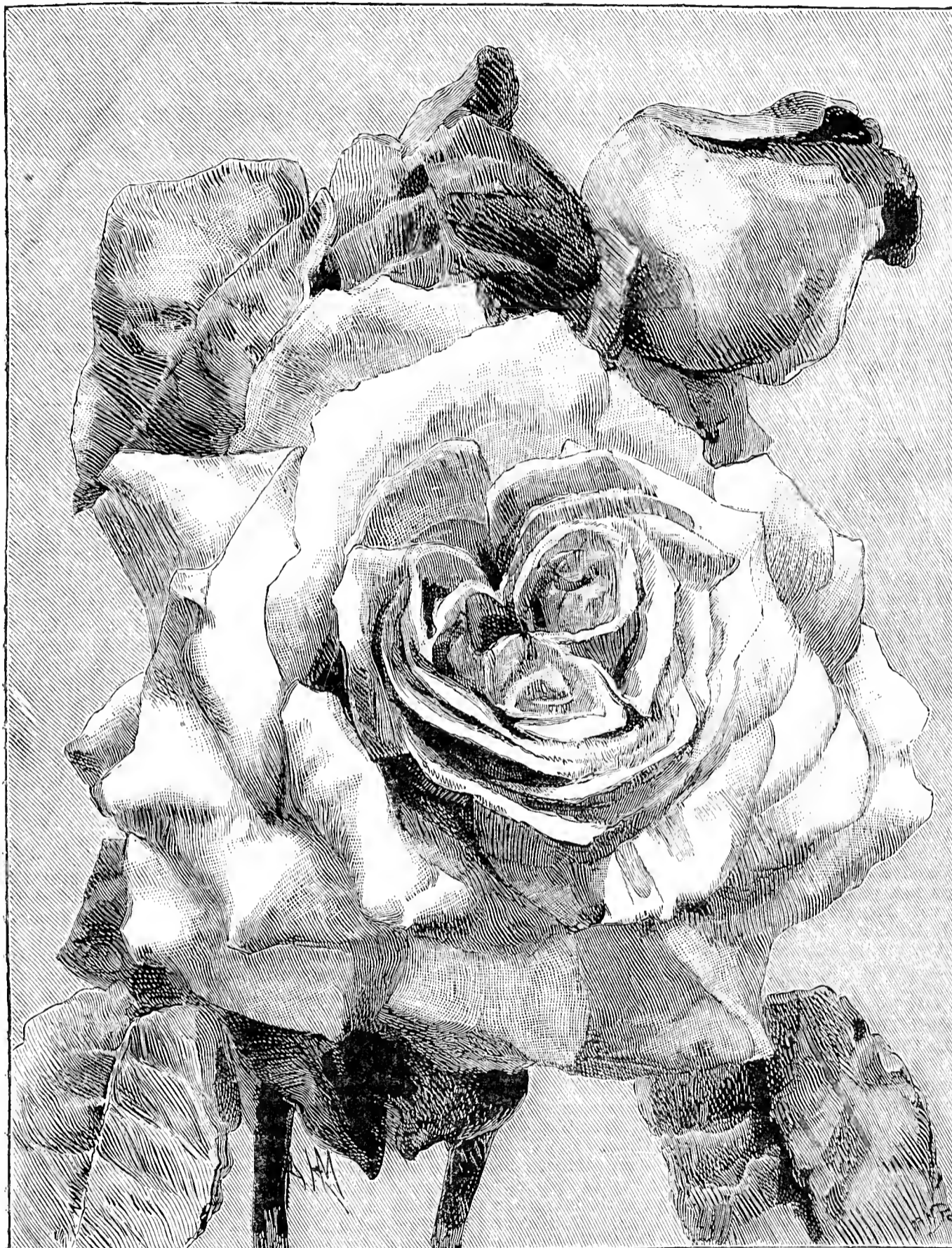

FIG. 67.—BOURBON ROSE, MRS. PAUL.

them will be partly matured and just in the right condition for cuttings. The nearer it is cut to the base of the branch the more certainty there will be of roots forming quickly, but as that would tend to spoil the plants for next year it is not desirable to take the branches off so low.

If about 3 inches of the base wood of the current year's growth is retained for next season, that will suffice, and of course it will not be a wise act to cut all the shoots as low as that even, better have fewer cuttings in number than spoil existing plants. If the shoots are cut into lengths of three eyes each that will be enough to secure good plants ;

gating case or a partly spent hotbed. Violent heat is not desirable, a gentle moisture is the best to insure perfect rooting. Shade must be applied to the frame, by no means allowing the leaves to flag. Moisten the cuttings with tepid water daily, and in a short time roots will be formed, even if the plants show no signs of growth. Sometimes the eyes remain dormant a considerable time.

When the cuttings are well rooted they are ready for separate pots ; those 3½ inches in diameter will suffice. Two parts fibry loam, one part of leaf mould, or the materials from a spent Mushroom bed will answer

equally well. Stand the plants in a warm house until new roots are formed, or the same position in the hotbed frame will answer, as but little heat will be available by that time. Afterwards gradually inure the plants to a cold frame, where they may be plunged in ashes for the remainder of the summer, drawing off the lights entirely during fine weather. In these pots they may remain until the new year, when a shift into 4 and 5-inch pots will be advisable, using a similar compost to that previously employed. Prune the stems to within about four eyes of the base, when useful little plants, each carrying the same number of shoots and flowers, if they are disbudded to one on each shoot, will be had the following May in an ordinary greenhouse. These are extremely useful for either conservatory or vase decoration. If a few cuttings are struck in this manner every year a constant supply may be kept up. As all varieties do not succeed equally well upon their own roots, I append the names of a few that can be relied upon, in addition to those previously named—La France, Baroness Rothschild, Magna Charta, Edouard Morren, John Hopper, Comtesse de Serenye, Marquise de Castellane, Her Majesty, Captain Christy, Emilie Hausberg, Madame Lacharme, and Merveille de Lyon.—E. MOLYNEUX.

THE EARLY RED RHUBARB.

I CANNOT accept the opinion of your contributor (page 355) who believes "the Yaxley Vicar's Rhubarb to be the Old Early Red." He does not say that he has seen any of the Yaxley Rhubarb, and perhaps the fact is that he never has. The Vicar's "good faith" indeed! Never prophesy unless you are quite sure. On my part I write to say that I have seen and tasted the Old Early Red, and am certain that it is not the same as mine, for my own is greatly its superior.

A few weeks since I bought in London, on 7th April, some of the Rhubarb which was sold as "natural Rhubarb," "grown," it was said, "by the acre at Isleworth," done up by two osier withs into a bundle containing eight thick sticks, 5 to 7 inches long; sixteen medium sticks, 5 to 6 inches, and fifteen thin and poor, 7 to 4 inches long; in all thirty-nine stems. None of the stalks were as thick as my thickest, and unlike mine, at that particular time, they were, in a curious way, uniformly red from the bottom of the leaf to the root end of the stem, and of a much deeper red than mine. My Rhubarb is really of a beautiful pink, and peculiarly crisp, in both respects unlike the Old Early Red. A mere glance could see that the London Rhubarb was of an entirely different sort of growth to mine. I had some of it cooked by stewing, and some was baked. After both modes of cooking the flavour was so much inferior to that which I am cultivating that I have no hesitation whatever in saying that my Rhubarb is quite distinct. The London product was considered in my household to have a nauseous flavour, whether stewed or baked.

This year in Notts some of the Yaxley Rhubarb was sent to table on March 23rd. From a Suffolk garden some of it was sent to table on March 12th. From my own garden it was sent to table on Thursday, March 5th. Has anyone this year grown Rhubarb in Great Britain of any other sort or kind, giant, medium, or dwarf, and sent it to table unforced and palatable as early? Kindly give us the replies in print if any reply comes in.—W. H. SEWELL, *Yaxley Vicarage, Suffolk*.

[Most assuredly the writer of the remarks on page 355 had seen, handled, and tasted the Yaxley Vicar's Rhubarb, or he would not have been in a position to arrive at a definite opinion on the subject. But it seems the Vicar has not yet had an opportunity to compare the true Early Red with his own. The small deep red Rhubarb referred to as having been bought in London and grown at Isleworth is not the Early Red in question, but a totally distinct and inferior variety, of which large quantities are grown in the Thames valley. The Vicar's description of his own Rhubarb equally applies to the Early Red in its first stages, but the stalks become green towards the top with age; so do those of the Vicar's, for his Rhubarb is the Early Red, though he does not appear to know it. He thinks the small Early Crimson is the Early Red, and that being so, it is only natural that he "cannot accept the opinion" expressed on the page quoted. The writer of that opinion did not "prophesy." He had carefully compared a genuine sample of the Yaxley Rhubarb with a genuine sample of the Early Red, both cooked and uncooked, and could detect no difference between them. The Vicar appears to be the prophet in this case, for by his own evidence he does not know the Early Red, yet asserts his own is "quite distinct" from it. It is distinct from the small Rhubarb known in the market as Early Crimson, which is quite another thing. This is either the Tobolsk or a form of it, and is "uniformly red from the bottom of the leaf to the root end of the stem."

Had the Vicar, as was suggested to him in 1889 (page 10, vol. xvii.), sent roots of his variety to Chiswick to be grown in the collection there the point would have been settled conclusively; but he did not do so. Had his Rhubarb proved distinct in character, and decidedly earlier than the Early Red, as grown side by side, it would have been officially acknowledged, and made known as a matter of public interest. No one is justified in selling an old variety of Rhubarb, or anything else, under a new name, however firmly convinced the vendor may be of the distinctness and superiority of his pet product, and it is not to be supposed that the Vicar of Yaxley would knowingly do anything of the kind. His Rhubarb is all the same an old variety extensively grown under one or other of the names published last week.

Obviously, the time at which Rhubarb may be gathered in different districts proves nothing in determining the earliness of any particular

variety, and the only evidence that is worth anything is that derived from an examination of varieties grown side by side under similar soil and climatic conditions.

Mr. Pownall has told us (March 26th, page 246) that he had the true Early Red from Chiswick and the Yaxley Rhubarb from Yaxley, and described them as "very similar in character," though the latter was slightly the earlier yet not quite so early as Hawkes' Champagne. The trifling lead of one variety over another may be merely accidental, and one crown of any of them will push stalks 2 or 3 inches longer on a given date than will others from the same stool. The true characters of varieties cannot be determined at that stage because they are not developed, but they can a few weeks afterwards, and the writer of the note of last week will be somewhat surprised if at the present time, now that the growth is considerably advanced, Mr. Pownall can point out differences sufficiently well marked that would justify him in recommending that the two alleged varieties may be properly sold as distinct.

Since the Vicar has suggested it as a "fact" that the author of the note had "never seen" his Rhubarb, it now rests with Mr. Sewell to withdraw the curious imputation if he think good to do so, and he is assured that the most conclusive proof can be adduced that his Rhubarb was very closely examined and carefully compared without the least prejudice with other early varieties, and no other conclusion could be arrived at than that the Yaxley Rhubarb is none other than the Early Red as grown at Chiswick and in several London market gardens.

The Vicar can now, if he likes, appeal to Mr. Pownall for his opinion as founded on experience of the two varieties (?) growing side by side with their essential characters now fairly developed, and if he does this Mr. Pownall will greatly oblige by sending a copy of his reply for publication in the *Journal of Horticulture*, in which he will agree that, under the circumstances, it ought to appear.—THE WRITER OF THE NOTE ON PAGE 355.]

GOLDEN LILIES.

"To gild refined gold, to paint the Lily."

WELL, if this be "wasteful and ridiculous excess," how much more so to praise the Lily of Gold, the marvellous flower from the great country of the East, from the home of that other "golden flower," the Chrysanthemum—Japan. The glory of the Golden Lilies is not of our making. They came to us with a brilliancy that dazzled; they showed us stately growth, and great hanging blossoms of cream and purple and gold, redolent with a rich fragrance. They followed a long line of relatives from other lands and eclipsed them all. The Golden Lily was recognised as the queen of her tribe. All this was only thirty years ago, but the richest promise of those days has been abundantly fulfilled, and now the Golden-rayed Lily of Japan, the beautiful and majestic *auratum*, is one of the most prized of all bulbous flowers.

Were it not that this grand Lily is amenable to cultivation in almost any garden it would be astonishing to note the enormous quantities that are every year imported. There would be no room for them if the many thousands of amateur gardens were not open. At one time the professional gardeners were alone considered by the trade, but they do not have it all their own way now. Dealers know that there is a vast and spreading field open in another direction, in which the demand for certain popular flowers is almost inexhaustible. *Lilium auratum* is one of these. Many gardeners prefer home-grown bulbs, which can be bought in the autumn, but the great bulk of the importations which arrive about midwinter are absorbed by the amateur element. May it increase and multiply.

It would be reviving an old controversy to discuss the respective merits of home grown and imported bulbs, and as a matter of fact there is no direct comparison between them. It is a question of time and price as much as anything. If you must pot early, say in October or early in November, it is a case of Hobson's choice, for only home bulbs are then procurable, and the recollection of this fact may save a certain amount of hesitation. It may also be well to bear in mind that really good home-grown bulbs cost 1s. 6d. to 3s. each. Those who do not mind waiting until December, when the imported bulbs begin to arrive, will be able to procure fine bulbs at 6d., 9d., and 1s. each, and these give very good returns if properly treated. I believe that at no very distant date the trade in home-grown *Liliums* will practically die out. The enterprise of British dealers in opening up direct communication with the bulb beds of distant Japan has brought into the market *Lilium auratum* bulbs at one-third the price of those which are grown here. They are later, as before stated, but they come early enough to meet the wants of amateurs, and it is this class which becomes responsible for the great bulk of the importations. One of the largest bulb dealers in the country told me last autumn that the home-grown bulbs were not of much use to him, the trade was now too small to be remunerative. Imported bulbs paid him much better. These arrive encased in clay, and it would be hard to imagine more uninviting-looking objects before the hard dry casing is removed. Naturally the bulbs have not the fresh, clean appearance of the home-grown, as they are soiled by the clay, and often somewhat dried from their long voyage, but they quickly freshen up under proper treatment. Trade dealers usually place them in damp cocoa-nut fibre refuse immediately they are unpacked, and send them out in much improved condition, but those who buy at the auctions have to take their chance. Just before Christmas I purchased a small box of imported *auratum*s from a big dealer. He counted them out of a large case without selection, and as he was making a reduction in

price to an old friend I could not ask to pick and choose. When I looked them over afterwards I saw that there was no necessity for it. Although such as he sold at 5s. per dozen ordinary retail price they were beautiful bulbs, firm, solid, clean, and heavy. I potted the greater part of them at once, as they had evidently been freshened up before I bought them, and I fully expect them to turn out a great success.

These imported bulbs may still be potted, but it is getting late. Use clean pots twice the diameter of the bulbs, crock them well, and cover the potsherds with a few pieces of flaky manure or rough portions of the compost. Loam, peat, and leaf mould in equal parts, with a good dash of sand and a sprinkling of crushed charcoal, or a fourth of decayed manure in the absence of leaf soil, will suit the plants. With regard to this soil question, however, I should like to add that those of your readers who have neither means nor room for stacks of different kinds of soil may achieve success with a bushel or two of prepared potting mould from the nearest florist. This is cheap and saves much embarrassment, for amateurs not infrequently put down their gardening paper in despair when a writer with a large well stocked establishment talks lightly and unconcernedly about the preparation of elaborate mixtures. It is easy for him, but it is difficult for them. Make the soil in the pots firm, but not absolutely hard when filling in, and let the tip of the bulb be quite 2 inches below the rim of the pot when it is placed in position to leave room for a subsequent top-dressing. The pots should be plunged in cocoa-nut fibre refuse under a light or a few old boards, and with the soil moist at potting time they will not require water till growth commences, and the roots are working freely. If then removed from the fibre and placed (after a few days in partial shade to inure them to the light) in the greenhouse they will commence to grow rapidly. Water them whenever the soil approaches dryness, and directly roots have pushed from the base of the stem fill up the space left in the pots with fresh soil. The plants may be stood out of doors during the summer.

The Golden Lily is a queenly garden plant, and quite hardy. A few clumps established in the border by working the soil freely, adding a spadeful or two of fresh compost if poor, placing three bulbs triangularly about 4 inches apart, and covering them 3 to 4 inches deep, will make a splendid display. Bold clumps with a background of shrubs are magnificent. A few spadefuls of peat are wonderfully acceptable to the plant, and though peat can be dispensed with, those who are in a position to provide it may look for superior results, whether their gardens be in town or country. As a town gardener I can vouch for the easy management and majestic beauty of the Golden Lily even within the sound of Big Ben, and I urge its claims earnestly upon all as a sterling garden flower of commanding beauty and rich fragrance.—W. P. W.

THE ECONOMIC PLANTS OF AUSTRALIA.

THE re-discovery of Australia by Captain Cook presented to Europeans botanical novelties of an astonishing kind, plants of singular structure and of the highest scientific interest, together with floral treasures of great beauty. Thus were two classes of people served with a great feast—the scientific botanist and the horticulturist. Seeds of our native plants were forwarded to Europe the very first year of settlement, and the frequency with which expensive plates of Australian plants are to be found in botanical literature at the beginning of this century attests the interest which was taken in them. Collectors of different nationalities found their way to this continent and sailed away with new species, to be described in the proceedings of every botanical society in Europe; active commerce in seeds and plants followed, which has been more or less maintained up to the present day, and although this is, in a measure, economic botany—one of the sordid pounds, shillings, and pence aspects of our indigenous vegetation, it is not the sense in which the phrase is commonly understood, which is the utilisation of plant products—a wide subject, and one which can only be imperfectly dealt with in the brief space at my disposal.

There can be no doubt that Governor Phillip and his officers were disappointed at the prospect of useful plants which the first district settled in Australia presented. Partly because Sir Joseph Banks perhaps painted the usefulness of the vegetation a little too much *couleur de rose*, and partly on account of the favourable expectations excited in sanguine minds at the prospect of unexplored country, the early settlers felt disappointed when they did not find abundance of edible fruit awaiting the pulling, and soft timber which could be fashioned into their requirements with a minimum of labour. They were concerned with two things—food and shelter, and great was the outcry when the timber proved to be hard, and the vegetable food peculiar to the country little tempting to Europeans. The economic properties of Australian plants are frequently not evident at first sight, and after the lapse of 100 years we are bound to confess that our knowledge of the subject has not passed the elementary stage, partly on account of the vastness of the continent, and partly because the great mass of the vegetation is endemic, and we are, therefore, deprived of the assistance obtainable by analogy.

Nowadays it is not sufficient to throw a new timber on the market without an explicit statement of its properties; a bark will not be accepted as a drug because it has an unpleasant taste, and so on. We must persevere in the investigation of the properties of our plants; this work is the handmaid to commerce, and in these investigations we can build upon the grand foundation of an elaborated flora, a privilege which no equally large portion of the earth's surface can boast.

The articles obtained from our native vegetation, which at one time

and another have been exported to other countries, do not make a very long list. Our timbers are far and away the most useful products of our native plants, but they have not been sent beyond the seas to any great extent. They include some of the hard woods, such as Jarrah and the Ironbarks, noted for their durability and strength; the Sandalwood of Western Australia, taken to China and the Straights Settlements; Red Cedar; Casuarina timber, or "Botany Bay Oak," for turnery; together with occasional parcels of our ornamental woods; also a few drugs, such as *Alstonia* (Fever Bark), *Atherosperma* (Victorian Sassafras), *Duboisia myoporoides*, together with Grass Tree gum, up to the discovery of a method of manufacturing picric acid from coal tar. We have also sent Eucalyptus oil during the last quarter of a century; the gum (Kino) of our Eucalyptus as a substitute for the kino of medicine; Wattle gum and bark, also a treacly extract of the latter, have frequently been sent.

We will briefly consider the principal economic plants, taking them in groups according to their uses.

Local conditions which obtain in Australia—the severity of the droughts, and the competition of rabbits and marsupials, cause sheep and cattle to fall back upon innumerable plants which, by courtesy, are therefore termed "forage plants." The indigenous Grasses are very numerous, and some of them are valuable for pasture; perhaps the ubiquitous Kangaroo Grass (*Anthistiria ciliata*, *Lim.*) is the best known and most valuable species. Australia being largely pastoral, the matter of Grasses is very important, and some have asserted that the high quality of Australian wool is mainly attributable to indigenous vegetation of this kind. This is, perhaps, true, but it scarcely admits of proof, as this excellence is probably largely accounted for by a variety of other contributing circumstances, chief of which may be reckoned climatic conditions, and the great attention which has been given to scientific sheep breeding. Following the Grasses, the vegetation known as Salt Bushes comes second, and without these plants a large portion of the dry country could not support the life of domestic animals. These plants, which are largely endemic, and belong to the natural order *Chenopodiaceæ*, are bushes varying in height from a few inches to several feet; their foliage is saline, and very palatable to sheep and cattle. Salt Bush country is a novelty to Europeans, and the early explorers imagined it to be worthless until the sheep themselves ascertained its value. In time of drought vegetable matter of all kinds is consumed, even trees—*e.g.*, Mulga and other *Acacias*, *Belar* (*Casuarina*), and spotted tree *Flindersia*, being either pollarded or felled for hungry animals.

The vegetable food products suitable for man yielded by Australian vegetation are not remarkable. In the more arid parts of the continent deaths are of course of more frequent occurrence on account of want of water than of food; in fact, they are comparatively rare from the latter cause. Nevertheless there are few people who could support life on what they could obtain from our native plants. With the blacks the case is different, inasmuch as all their faculties were sharpened for the one object—the pursuit of the scanty food supply—while white men lost in the bush, without their own edibles, as a rule do not look to the native plants to satisfy the cravings of hunger, and, if they do, seldom find it. Even in very arid districts water may be obtained from the roots of some trees (the dwarf Eucalypts, known as *Mailees*, being usually chosen), by the simple expedient of cutting the roots into lengths and sucking them or draining the water into a receptacle. In other warm parts of the world the method of obtaining water from the trunks of climbers is practised, but I believe Australia is the only country in which it is taken from the roots.

The edible fruits are usually small or insipid. One of the best is the Quandong (*Fusanus acuminatus*), which envelopes a large seed or nut, itself good eating. Then we have such plants as the Native Pomegranates (*Capparis*), the Wild Melon (*Cucumis*), and innumerable fruits giving a minimum of succulent matter—*e.g.*, Ground Berries (*Astroloma*, &c.). Doubtless some of these fruits and other food products are capable of improvement with cultivation, but as the cultivation of plants was unknown to the blacks, and white men have brought their own foods with them, the extent of possible improvement is an unknown quantity. We have a splendid edible nut with a hard shell known as the Queensland Nut (*Macadamia ternifolia*), while a large Conifer (*Araucaria Bidwilli*), the Bunya-Bunya produces in certain seasons abundance of nuts about the size of Walnuts, which are eagerly sought after by the blacks, who have instituted a kind of hereditary property in various trees on that account—perhaps the only instance of this kind among the natives. The *Macrozamia*, or Nut Palms, and the Bean Tree, or Moreton Bay Chestnut (*Castanospermum australe*) yield abundance of large starchy seeds, which, however, require to be soaked in water and roasted to free them from certain deleterious properties with which they are accompanied. They form good sustenance to hungry Europeans, but are poisonous if eaten raw. The aborigines also used to eat the seeds of certain Wattles (*Acacia*), and in fact they utilise any vegetable product which promised even a minimum of nutriment. Roots were in much demand, amongst which may be mentioned those of many kinds of Orchids, the succulent roots of even some largish trees—*e.g.*, Kurrajong (*Sterculia*), while the roots (corms) of plants belonging to the *Arum* tribe (*Aroidæ*) were largely used for food, their poisonous properties being removed by treatment similar to that described in the case of *Macrozamia*.

Australia has not, up to the present, contributed any large number of articles to the armament of the physician. At the same time, very few articles from our indigenous vegetation have been subjected to critical

examination, in which the efforts of the botanist, chemist, physician, and physiologist have been combined. One of the directions in which science has made important progress of recent years is in the investigation of plant products with the view to their use in medicine, and some of this activity is being extended to Australian plants, each year advancing our knowledge in this direction. The products of Eucalyptus will be alluded to presently, and I will confine myself, in this brief sketch, to little more than an enumeration of our native drugs to which most attention has been given. Bitter barks seem to obtain most notice in all parts of the world. We have several of these, such as *Alstonia*, *Tabernaemontana*, *Petalostigma*, *Chionanthus*, &c., which usually go under such names as Quinine, or Fever Barks. The first one (*A. constricta*) has been most worked at, and has rewarded scientific chemists with a number of interesting alkaloids; but so much *Cinchona* and so many *Cinchona* substitutes are offering from all parts of the world, that bitter barks are a drug in the market in a double sense. With the aromatic barks, such as the *Sassafras* (*Atherosperma*, *Doryphora*, *Nesodaphne*, &c.), the case will probably be different, although they can yet scarcely be said to have passed the experimental stage. They will probably be presented to the pharmacist in the form of essential oils. I will allude to but one other class of barks—the pungent, peppery bark of *Drimys*. The true Winter's Bark of the Straits of Magellan belongs to this genus, and was in high repute in medicine for over two centuries until the supply fell off. We have two species, and their bark is at present under examination with a view to its substitution for the better known one. Glancing for a moment at herbs and leaves, we have the *Duboisia* (*D. myoporoides*), which has been before ophthalmic surgeons for some years, but partly because of the intermittent supply, and partly because the active principle is deemed by some to present no advantages over *Atropine*, it has not come largely into use. A species of *Euphorbia* (*E. pilulifera*) has received much attention in Australia as a cure for asthma, but while marvellous results are said to have followed its use, it can only be held forth as an important palliative in this distressing complaint. We have a Native Centaury (*Erythraea australis*), extensively distributed in Australia, and one of the best known of our native plants by country people as a simple bitter, and also for use in diarrhoea, &c. Like all countries we have a multitude of plants possessing nasty tastes of one kind and another, which possess local reputations more or less deserved, but whether they will come into more extended use remains to be seen.

We now come to an important group of substances—namely, the exudations, *i.e.*, gums and allied substances yielded by our native plants.

The only true gums in which we do any export trade, or are likely to do, are Wattle Gums, which form a low grade gum arabic, and are used for calico printing and other purposes. The *Aracarias* yield beautifully clear resins, which may have a limited application in varnish making, while those of *Frenela* (*Callitris*), known as Cypress Pines, yield resins which cannot be distinguished from *Sandarach*. A species of *Myoporum* yields a dark coloured, easily fusible resin, while the best known of all, erroneously known as grass-tree "gum," and obtained from various species of *Xanthorrhæa*, is chiefly used as an inferior substitute for shellac. The reddish astringent exudations of our gum trees are of much more promise, and, since they are so abundant, a trade in them could readily be established. They contain a high percentage of tannic acid, and many of them are in every way fit to replace the expensive *Kino* of the *Pharmacopœia*.

Australia is as remarkable for its fewness of plants yielding fixed oils in any quantity, as for its wealth of plants yielding essential oils. As far as I am aware, not a single indigenous species actually yields, in this continent, fruit or seeds for the oil press.

Chief amongst Australian essential oils, of course, come those of *Eucalyptus*. Every tree of the countless myriads of "gum trees" in this continent contains essential oil in its leaves, but comparatively few species yield it in quantity sufficiently large for its extraction to be profitable commercially.

The analysis of essential oils is surrounded by peculiar difficulties, and matters have been complicated by the varying oils which have been supplied to different workers, but the composition of the principal ones is in a fair way to be settled, and the conclusion of these researches will place commerce in these products on a surer footing. *Eucalyptus* oils are chiefly employed as antiseptics and rubefaciants, the chief species employed being *E. amygdalina*, *E. oleosa*, and other *Mallecs*, and *E. hæmastoma*. Two Queensland species, *E. citriodora* (the Citron scented gum), and *E. Staigeriana* (the Lemon scented Ironbark), yield sweet scented oils, which, in addition to the uses above mentioned, may perhaps be employed for perfumery purposes. Other plants of our indigenous vegetation have been distilled for their oils, but their products at present remain curiosities of the laboratory.

As far as is at present known Australia yields no indigenous dye-stuffs of any consequence in these days of chemical preparations, but she makes up for this lack by a great profusion of tanning substances. The astringent properties of our *Kinos* have been briefly referred to, and the barks of some *Eucalypts* (*Ironbarks* and a few other trees), are locally used for tanning; but one genus of plants has made the reputation of Australia as a producer of tans. I, of course, allude to the *Wattles* (*Acacia*), of which this continent is the headquarters. Spread over these colonies are over 300 species, varying in size from a few inches in height to large trees. The barks of all are more or less astringent, though the vast majority are too small in size, too limited in distribution, or too poor in tannic acid, for them to enter into commerce. Four

Wattles deserve particular mention. First comes the Golden Wattle of South Australia and part of Victoria (*Acacia pycnantha*), a small tree with a solid bark, which in mature specimens contains from 40 to 50 per cent. of tannic acid; *Acacia decurrens* Sydney Black Wattle, and *Acacia mollissima* New South Wales Green Wattle, or Victorian and Tasmanian Black Wattle, larger trees than the preceding, but not so strong in tannic acid (35 to 40 per cent. in best specimens); and *Acacia saligna* Weeping Wattle, found in Western Australia, and yielding the best tan bark (30 per cent. of tannic acid), in that colony. In the early days of settlement *Wattles* were abundant in most of the colonies, but the greater number have been got rid of with great prodigality. The result is that now there are comparatively few mature Wattle trees of tanning value remaining; trees are stripped before the bark has attained its full strength, while the price of good bark has increased to an almost prohibitory figure, and export has almost ceased, except in one or two colonies. The remedy for this is conservation of existing trees and replanting. For replanting we have *Acacia pycnantha*, which prefers warm and dry situations; and *Acacia decurrens*, and the closely related *mollissima*, for damper and colder localities.—J. H. MAIDEN, F.L.S., F.C.S., &c., Curator of the Technological Museum, Sydney; author of "The Useful Native Plants of Australia," (in the *Year Book of Australia*.)

(To be continued.)

SETTING LAWN MOWERS.

THE term "setting" is well understood by gardeners as adjusting the knives, plate, and rollers, so that the machine cuts cleanly, smoothly,

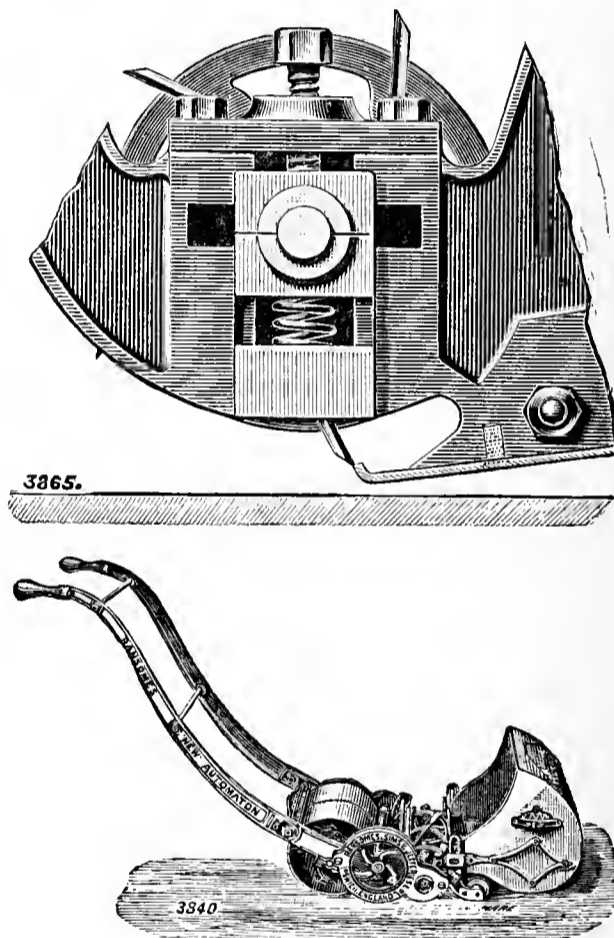

FIG. 68.—RANSOME'S LAWN MOWER.

and evenly. Messrs. Ransomes, Sims, & Co., Ipswich, send the accompanying illustrations, the first of which shows the method of setting adopted in their machine, and the second the machine set for work. We have not received any description of the contrivance, but as we have seen the machine are able to say that the method of adjusting the parts for working is as simple and satisfactory as anyone could desire, and more so than could be imagined by persons who have only had experience with machines that had to be turned over to work the bottom screws, and some of these difficult to reach. So far as we remember, and as the engraving shows, one screw only on each side needs turning to loosen or tighten as may be required, and this can be done with the greatest ease when the machine is in its natural working position. It is a good mechanical arrangement.

AURICULAS AT SLOUGH AND READING.

THESE two places are associated in my mind with many floral memories. Slough I knew in the days of "Brown," but it was not until the nursery passed into the hands of my late friend Charles Turner that it became a regular place of pilgrimage to me, with the great firm of Sutton & Sons—that is, before that time my old friend was then in his quiet little cottage at Chalvey, and had not burst forth into the full-blown florist he afterwards became. But ah! how well I recollect his frames of Pansies—he had not then begun to grow *Auriculas*—and often do I muse over the pleasant visits paid there when we were both young,

and when all possibilities seemed within our reach. Then as to Reading, my recollection of it does not date so far back, but I well remember a visit I paid many years ago to Mr. Hoyle, the raiser of so many fine Show Pelargoniums, while my acquaintance with the members of the great house of Sutton & Sons has led me many times to spend pleasant and profitable days. Yet never has Reading been connected in my mind with the Auricula until of late years; indeed, I do not think that the oldest inhabitant could tell of a grower of Auriculas there, though I believe that Chapman—the raiser of a flower which for beauty of body colour has never been excelled, "Maria"—lived somewhere in the neighbourhood.

Of late years, however, Reading has made its mark in the Auricula world, and especially has this year brought it into prominence. Having, then, an opportunity of visiting these two homes of the Auricula I gladly availed myself of it, and now report a few things which may be interesting to the lover of the flower.

There is one great advantage in the present style of Auricula growing which makes such visits much more agreeable. Formerly when I used to go through the Slough collection it was a great labour for John Ball to be lifting and holding up the lights of the frames while I looked in, and then if any plant had to be examined further trouble was occasioned, while, should the day prove stormy or wet, there was no getting at them in any way. The Auriculas at Slough are now contained in a house somewhere about 50 feet in length, with stages about 4 feet wide on each side, the walk being in the centre of the span-roofed structure. One side of this and half the other is filled with Alpine Auriculas, of which Mr. Turner is the most successful and celebrated raiser, the best varieties in growth having come from this establishment; but as I have often said, I cannot get up an enthusiasm for these flowers, which seem to me so vulgar in comparison with the Show varieties with their delicacy and refinement. I have more than once thought I would grow them, but it has always ended in their being relegated to the borders. The stock of Auriculas is large, as well it might be, as he is the only grower for sale in the South of England, but no one must expect to find such plants here as are to be seen in a private collection, for the simple reason that they are for sale, and if a buyer offers a good price for them, why go they must. As the space is heated the plants were well in flower, considering the backwardness of the season, for it is needless to say that the house in which they are grown is heated. There was a good stock of many valuable varieties, notably George Lightbody, which is said in many places to be losing vigour and to be difficult to keep.

I may say in passing that the nursery seems in all respects to be up to its high mark—Pelargoniums, Azalcas, pot Roses, and especially Carnations and Picotees being in fine condition. For these latter a new house is being put up, which will be a grand sight in the blooming season. It has with many Carnation growers been a disastrous season, but the stock here is as extensive and as healthy as ever.

Widely different was the garden of Mr. Henwood in Hamilton Road, Reading, but just such a spot as the Auricula lover delights to visit. A small back garden not containing many square feet, with nothing whatever to give it an advantage over any of its neighbours, has here been made the home of a flower dearly loved by its owner; and as love conquers all things quite as much as labour does, so the love borne by Mr. Henwood for his favourite flower has, combined with intelligence and skill, enabled him to overcome any difficulty, and in this back court garden to grow plants which have raised him to the foremost place amongst exhibitors.

When Mr. Henwood about eight years ago set himself to grow Auriculas he went the right way about it by declining to grow any but the best varieties he could procure, and hence his collection, although small, is one of the most select I have seen. The house in which he grows them is of very diminutive proportions in comparison with those one has seen in other places—not more than 10 feet long, a span roof with a central path and a stage on each side. He has a small Loughborough boiler, and although he has not used it very much yet it has been sufficient to bring on his flowers in time for the show, which he otherwise could not have accomplished. One side of the house is devoted to Alpines, but I should not be surprised if the Show varieties gradually usurped their place, and although he has been as successful in growing these as he has in the Show section, yet I can see that his love for these will some day or other absorb all his affection.

Of the Show varieties he has only about 120 flowering plants, and I think very few, on looking down the stages at the Show at the Drill Hall on April 22nd and read in class after class "First prize Mr. Henwood," could believe that it was all done by so limited a number of plants; but the wonder abates a little when you find he has half a dozen plants of Mrs. Potts and nine of Heroine and F. D. Horner, and that it is only the very best varieties which are admitted. We inferior mortals who content ourselves with Traill's Beauty, Lord of Lorne, Topsy, Imperator, &c., can only look on and admire; but all the good varieties in the world would not gain him the position he has acquired were their growth not directed by one who thoroughly understands them, studies their idiosyncracies and tastes, and acts accordingly. We had of course much conversation about the various kinds grown, and our opinions very much coincided. Thus in green edges he believes in Rev. F. D. Horner to hold the first place, and his blooms of this fine variety are in excellent order; and as Headly associated his friend's name with his own, and Headly's George Lightbody will ever be connected, so has "Ben" associated his friend's name, and it will be a long time before a green edge will be associated with himself, and Simonite's F. D. Horner will record their work for many a year to come. All other green edges,

even those of the highest character, are defective; and the newer one has this advantage, its better growth and stronger constitution. He, however, grows both Colonel Taylor and Prince of Greens. Monarch he looks upon as a decided failure. There were two plants of it in bloom, but they were both defective, the body colour being too heavy and the petals having a very queer habit of frilling, if I may so call it, which spoils their symmetry. Of grey edges he had, no doubt, no more than all Auricula growers, that George Lightbody has the highest place, and is likely to hold. He had a good opinion of George Rudd, but as I hope to say a word about Mr. Woodhead's varieties at some future time it is needless to say more now:

In white edges Read's Aeme holds, I think, the first place in his estimation, but he thinks very highly of Woodhead's Mrs. Dodwell, of which he had some fine blooms, and plants of which he exhibited so well at the National. Conservative is good, but it has its defects; the edge is often too undecided, and it is difficult to get a good truss of it, as it breaks up into stock. John Simonite he also thinks very highly of, but it is difficult to get, and more difficult still to keep.

As to self's Mrs. Potts holds the premier place in his estimation, followed very closely by Heroine, and then by Woodhead's Black Bess. It was not a good year for Heroine, and many of the pips were malformed, while in most cases Mrs. Potts was true to character.

There were many other matters concerning the Auricula we talked about, and could have gone on, but Mr. Henwood is a busy man, and had to be off to attend to things not quite so captivating as Auriculas. He is an enthusiastic grower, and I have no doubt will maintain the position he has won.—D., Deal.

FRUIT GROWING IN INDIA—THE MANGO.

A SHORT time ago (says the *Madras Times*) we drew attention in these columns to the importance, generally, of encouraging the cultivation of fruit trees in this country as an industry, and on the present occasion we propose to deal with it more specifically by entering in greater detail into how it should be done, and the varieties most suitable for a commencement. In the forefront of all Indian fruit trees we will place the Mango; not only on account of its being most generally grown all over the country, but also because it is the one fruit tree in which the natives of India really take an interest. Those who have not had opportunities of tasting good Mangoes, have a notion that this fruit is like so much tow and turpentine. A more erroneous idea never was entertained; it would be as accurate to conclude that the characteristics of the Crab Apple are those that distinguish all the varieties of the Apple in England. Even the fibrous uncultivated Mango very often has a most exquisite flavour, but the only way to enjoy it is to do as the native does and suck it! There are Mangoes of all shapes, sizes, colours, and varieties, and they flourish all over India. Some years ago a scheme was submitted to the Government of the N.W. Provinces for the establishment of a Mango Society, with the object of studying and tabulating the varieties of this fine fruit; of making coloured drawings of them; of forming an extensive orchard where all the known choice descriptions might be collected, propagated, and distributed; and for learning by experiments the best ways of cultivating and improving them from seed. The proposal unfortunately did not meet with the approval of Government, and fell into abeyance. Attempts were then made amongst native gentlemen to promote the idea, but met with no support. The following instance illustrates the light in which some minds regard philanthropy. A certain collector of choice varieties possessed a rare specimen, for a few grafts of which he was asked for planting in a public garden. His reply was that he could not think of parting with cuttings of his unique specimen, as it would at once be propagated and diffused and so become common. His one idea was to jealously guard what he had, instead of permitting his fellow men to participate in its production.

In the "Flora of British India" about twenty distinct species of *Mangifera* are described, and it is stated that there are about thirty in all. There is, therefore, a fine field for horticultural societies in India for their further development. Bengal, Bombay, Madras, and the N.W. Provinces can produce quite fifty different varieties, all well worth sending to Europe, in place of the wretched specimens from the West Indies now to be found in the London shops. In Madras we have the celebrated Salem and Bangalore Mangoes; in Bombay the Alphonso, the Pairee, and the Fernandina are grown; whilst in Benares the Singra, and in Fategarh the Takari are of delicious flavour. In India Mangoes are always plucked when still unripe, and allowed to mature in straw. This habit might easily be taken advantage of for export, and large quantities could be transported to Europe in specially prepared cool chambers. Since Australia can successfully send fresh fruits to England, there is no reason why Bombay, which is but half the distance, should not do the same; and the trade once started would certainly prove remunerative enough to cause a large extension of operations to America and Australia. There is, moreover, room for an extensive trade between Northern India and Bombay. A comparison of prices shows that whilst in the latter place good Mangoes at the commencement of the season sell at 16 rupees per dozen, and at the height of the season at 8 rupees or 9 rupees per 100, the choicest Mangoes of the N.W. Provinces may be bought at 4 rupees per 100. The rail journey occupies under forty hours, and these facts only require to be known to create a trade. It is always difficult to initiate anything in India without Government support, but if Government would but see fit to move in the matter, say by inaugurating a show to be held in Bombay, there is little doubt

but that the idea would rapidly develop. Natives will not be backward in taking up new methods of cultivation if such have been proved to them, by means of experiments carried out in Government gardens, to be profitable. At present their ways of cultivation are crude and barbarous. For instance, the leaves that fall in the autumn and winter from trees in orchards are swept away and used as fuel. Now in these leaves there are all the ingredients for the nourishment of the tree, whilst they also prevent the moisture from evaporating too rapidly from the ground. Their own fallen leaves go on nourishing the trees for centuries, and an experiment in Lucknow showed how an almost arid bit of ground was turned into all but a tropical garden almost entirely by the use of surface leafage and irrigation. The leaves were first brought from outside, and afterwards the trees themselves provided this surface manure, which kept on increasing every year. Another point in which natives are very careless is irrigation. They almost invariably give the ground too much of it; probably going on the principle that as they pay no more for a lot they may as well have it. Without proper drainage the soil gets waterlogged and the trees become miserable and perish in a few years.

What we have written regarding the prospects of increased cultivation of the Mango applies with equal force to many other hardy and universally grown fruits, such as the Plantain, the Guava, the Orange, the red and white Grape, and the Loquat. These trees will grow on all soils; though for the Orange a *kunker* or gravelly one is preferable. A great benefit to Orange growing is shade, and no tree is better suited for this purpose than the "bair." Grapes are best grown in localities where the rainfall is scanty, or where the monsoon is late, and the best variety is a thick-skinned one which resists the bursting action of the rains. Guavas may be cultivated to a state of great perfection, and in Etawah a species is grown that is almost entirely free from seeds and of charming flavour. A fruit garden should be laid out somewhat as follows:—A high wall should surround it to keep out jackals and protect the trees from storms. Inside it a row of "Jack" trees should be planted, and inside them a row of Mulberry trees, and inside them again a row of Guava trees. This triple row all round the fruit garden forms an admirable screen for breaking the force of hot winds and storms. If the ground be extensive it should again be divided into squares and rows by avenues of fruit trees, such as Mangoes and Li-chis, which are not injured by hot winds. The squares, thus protected, should be planted with Plums, Apples, Lemons, Pummeloes, Plantains, Oranges, &c. All kinds should not be jumbled into one plot, but a separate plot should be devoted to each kind, so as to suit the canal irrigation to the wants of that particular kind of tree. There would then, too, be ample space amongst the trees for Pine Apple plants, which prefer a certain amount of shade. On these lines a fruit garden should be a great success. Government might be induced to start a public garden on this plan, instead of maintaining the costly establishment it now does for horticultural gardens, mainly for the supply of vegetables and flowers for sale to European residents.

AURICULAS—THE NORTHERN SHOW.

THE Northern Show of the National Auricula Society was held in the New Town Hall, Manchester, on Tuesday, April 28th, in connection with the Spring Show of the Botanical Society. Until within three days of the Show we had had no spell whatever of genial spring weather since the precocious warmth of February. There had been days of bright sunshine in country places, but with a drying bitter wind, and with such cold nights that the Auricula, which at this season does its day's work largely during the night following, could make little of such weather, and stood, as it were, anxiously watching for the better times that came so late.

Seeing that some of our growers live in smoky districts, and others in situations much exposed, it was almost wonderful that they had any edged flowers out at all. Mr. Simonite, who has the evil influences of smoke, poisonous gases, and exposure combined to a degree unknown outside Sheffield, had scarcely an Auricula flower open. A late bloom is seldom a very long-lived or very good one, and those of us who grow the Tulip as well as the Auricula will see the two in flower together, though of course Tulips will be young and Auriculas old.

My own situation is both naturally and otherwise sheltered, but although it is possible to break the pressure of the east wind, nothing can neutralise the subtle searching influence of it. The Auricula houses, for the seven years they have stood here, have never had any heating apparatus attached to them, because in any season unlike the past I have had no need of it, nor used to employ it before, except to keep the temperature at or about 45° when severe frosts occurred while the flowers were expanding. Considering the season there were quite as many flowers at the Northern Show as could be expected; and, as at the Southern Show, some were in fine character, and some were rough and shaken. But for the unusual loss of winter foliage in the drought of the long frost, many would have made more powerful trusses. The winter foliage has very much to do with the elaboration of the flower head, and where that green "cloth" is in scant measure, the "coat" of course is cut accordingly. In cases of severe defoliation plants have had to supply themselves with breathing organs by sending up in haste and as with a gasp leaves out of the new heart that in ordinary course would not have been needed yet.—F. D. HORNER, *Hon. Sec.*

PRIZE LIST.

Class A.—Six Auriculas, dissimilar.—First, Rev. F. D. Horner, with green edges Rev. F. D. Horner (Simonite) and Attraction (Horner);

grey edge, Thetis (Horner); white edge, Magpie (Horner); selfs, Favourite (Horner), dark violet, and Nightshade (Horner) dark brown. Second, Miss Woodhead, with green edges Rev. F. D. Horner and Prince of Greens (Traill); grey edged, Rachel (Woodhead); white edges, Mrs. Dodwell (Woodhead) and Acme (Read); self, Mrs. Potts (Barlow). Third, Mr. T. Lord, with green edges, Rev. F. D. Horner and Prince of Greens; grey edge, Geo. Rudd (Woodhead); white edge, Acme (Read); selfs, Heroine (Horner) and Brunette (Pohlman). Fourth, Mr. H. Wilson, Halifax. Fifth, Mrs. Kyrke Penson, Ludlow. Sixth, Mr. Irving Hind, Queensbury. Seventh, Mr. Geo. Middleton, Prestwich.

Class B.—Four Auriculas, dissimilar.—First, Mr. H. Wilson, with Col. Taylor (Leigh), green edged; Geo. Lightbody (Headly), grey edged. Miranda (Horner), white edged; Mrs. Potts, self. Second, Rev. F. D. Horner, with Rev. F. D. Horner, green edged; Diogenes (Horner), grey edged; Desdemona (Horner), white edged; Enid (Horner) self. Third, Miss Woodhead, with Prince of Greens, green edged; Geo. Rudd, grey edge; Acme, white edge; Black Bess, self. Fourth, Mr. T. Lord. Fifth, Mr. Irving Hind. Sixth, Mrs. Kyrke Penson. Seventh, Mr. Wm. Taylor, Middleton.

Class C.—Dissimilar pairs in variety and class.—First, Mr. Edmund Shaw, Moston, with Rev. F. D. Horner, green edge; and Geo. Lightbody, grey. Second, Mr. H. W. Nixon, Leek, with Rev. F. D. Horner, green edged; and Heatherbell (Simonite) white edge. Third, S. Barlow, Esq., Stakehill, with Geo. Lightbody, grey; and Heroine, self. Fourth, Mr. James Wood, Staleybridge. Fifth, Mr. J. Clements, Harborne. Class D.—Pairs for maiden growers.—No exhibitors.

Class F.—Single plants, green edges.—Premium, Rev. F. D. Horner with Green Dragon (Simonite). First, Mrs. Kyrke Penson with Col. Taylor. Second, Rev. F. D. Horner with Mercury (Horner). Third, Rev. F. D. Horner with Dragon Fly (Horner). Fourth, Mr. Hy. Wilson with Col. Taylor. Fifth, Mr. T. Lord with Rev. F. D. Horner. Sixth, Rev. F. D. Horner with Lively (Horner). Seventh, Rev. F. D. Horner with Achilles (Simonite). Eighth, Rev. F. D. Horner with Monarch (Horner).

Class G.—Single plants, grey edges.—Premium, Mrs. Kyrke Penson with Geo. Lightbody. First, Mrs. Kyrke Penson with ditto. Second, Mr. T. Lord with Lancashire Hero. Third, Mr. E. Shaw with Geo. Rudd. Fourth, Mr. Wm. Taylor with A. Meiklejohn. Fifth, Mr. E. Shaw with R. Headly (Lightbody). Sixth, Mrs. Kyrke Penson with A. Meiklejohn. Seventh, Mrs. Kyrke Penson with John Waterston (Cunningham). Eighth, Miss Woodhead with Rachel.

Class A.—White edges, single plants.—Premium, Rev. F. D. Horner, with Mrs. Dodwell. First, Rev. F. D. Horner, with Magpie. Second, Mr. T. Lord, with Mrs. Dodwell. Third, Mrs. Kyrke Penson, with Acme. Fourth, Mrs. Kyrke Penson, with Frank (Simonite). Fifth, Mr. T. Lord, with Conservative (Douglas). Sixth, Mrs. Kyrke Penson, with Dr. Kidd (Douglas); seventh, with John Simonite (Walker); and eighth, with Highland Queen.

Class I.—Selfs, single plants.—Premium, Rev. F. D. Horner, with Enchantress (Horner), and first with Juno (Horner), and second with Priscilla (Horner), and third with Dusk (Horner), and fourth with Heroine (Horner), and fifth with Mrs. Potts. Sixth, Mrs. Kyrke Penson, with Black Boy (seedling). Seventh, Mr. Ed. Shaw, with seedling (Shaw). Eighth, Rev. F. D. Horner, with Laura (Horner).

Premier Auricula of the whole Exhibition, Magpie (Horner) white-edged, shown in class A of six Auriculas by Rev. F. D. Horner.

Alpine Auriculas.—Class E.—Four Alpines, shaded and dissimilar.—First, Mr. T. Beswick. Second, Mr. Chas. Turner. Third, Mr. T. Clements. Fourth, Mr. H. Goggie. Fifth, Mr. J. Edwards. Sixth, Mr. E. Shaw. Seventh, Mr. W. Taylor.

Class K.—Single plants, Alpines, yellow centres.—Premium, Mr. G. Thornley. First and second, Mr. C. Turner. Third, Mr. T. Clements. Fourth, Mr. T. Beswick. Fifth, Mr. C. Turner.

Class L.—Single plants, Alpines, white centres.—Premium and first, Mr. C. Turner. Second, Mr. T. Clements. Third, fourth, and fifth, Mr. C. Turner.

Class M.—Three Polyanthus, black grounds.—First, Mr. G. Thornley. Second, Mr. S. Barlow. Third, Mr. T. Beswick.

Class N.—Three Polyanthus, red grounds.—First, Mr. G. Thornley. Second, Mr. W. Taylor. Third, Mr. T. Beswick.

Class O.—Single plants Polyanthus, red grounds.—Premium, first, second, third, fourth, and fifth, Mr. G. Thornley.

Class P.—Single plants, Polyanthus, black grounds.—Premium, Mr. W. Taylor. First and fifth, Mr. G. Thornley. Second and sixth, Mr. T. Beswick. Third and seventh, Mr. S. Barlow. Fourth, Mr. R. Dyson.

In Class R, for twelve Fancy Auriculas; in Class S, for twelve Fancy Polyanthus; and Class T, for twelve Fancy Primroses, Mr. S. Barlow was the prizetaker.

HAYWARDS HEATH SPRING SHOW.

THE first spring Show attempted by the above Society was held in the Public Hall on the 28th and 29th ult. The entries did not quite equal expectation, but, all things considered, the promoters have every reason to be satisfied with their first experiment. For a small group of plants in flower there were five entries. Mr. H. Townsend, gardener to E. J. Arbonin, Esq., Lindfield, was a good first with bright well grown plants, Azaleas being the chief feature. Mr. J. Sands, gardener to T. Bannister, Esq., Haywards Heath, Mr. W. Upton, gardener to the Rev.

H. J. Rush, and Mr. M. Purvey, gardener to Miss Culley, Burgess Hill, followed in order named. It is quite a mistake to limit exhibitors in such a class as this, to plants in bloom. A few bright flowering plants arranged on a groundwork of Ferns or other foliage produces a much better effect and with less trouble to the exhibitor. Amongst other successful exhibitors were Mr. C. Crosby, Lindfield; Mr. J. Cottingham, gardener to Mrs. Wyatt; Mr. J. Harmes, gardener to Miss Wyatt, both of Haywards Heath; Mr. W. Brockway, gardener to A. S. Culley, Esq., Burgess Hill. In the class, a centrepiece for ladies only, Miss H. P. Willmot was successful with a simple but light arrangement of double Daffodils. The other ladies who were to the fore in this and other classes were Misses M. Willmot and J. R. Vincent, Mrs. R. Pennet, Mrs. A. Alwin, and Mrs. Newington. The date of this Show was decidedly too late for Hyacinths, Cinerarias, Primulas, and Cyclamens, while it was quite early enough for a good show of Pelargoniums. The class for the best decorated window was a pleasing feature and deserves to be encouraged with more prizes. There was a fair competition for six plants of Auriculas, and this also should receive attention as the cottager and amateur can never come on more equal ground with the gardeners, as was shown on the present occasion.

The exhibits not for competition did much to make up for the short entries. Messrs. J. Peed & Son of Norwood staged a fine group of decorative plants; their Ericas were especially fresh and vigorous. Messrs. Barr of Covent Garden sent some fine Daffodils—over fifty sorts—and were much admired. Messrs. Grimsdick of Haywards Heath suitably decorated the stage. Messrs. Balchin of Hassock and Brighton contributed a small group of plants. Messrs. Roots of Cuckfield had a large assortment of Pansies and some fine Neapolitan Violets, their specialty; and Messrs. Cheal of Crawley had a large collection of Apples in wonderful fine condition for the season. The following were noted as being as sound and firm as when picked from the trees—Alfriston, Blenheim Pippin, Gloria Mundi, Golden Reinette, Hollandbury, Hornead Pearmain, Kentish Fillbasket, Lady Henniker, Ottershaw Pippin, Lane's Prince Albert, Winter Queening, Wellington, and others. Why should we not have a show of Apples at spring shows? and why not have Strawberries in pots? A specimen of the old-fashioned Brugmansia (*Datura*) was sent from the gardens of Sir John Stokes, K.C.B., and the same gentleman's gardener, Mr. S. Lawley, also embellished another part of the hall with handsome decorative plants.



HARDY FRUIT GARDEN.

APRICOTS.—These have flowered freely and set well this season, and now require attention in disbudding. Take off all foreright shoots and any that are too gross to form fruiting wood; lay in enough young wood for fruiting next season wherever space can be found for it, and pinch sufficient of the best placed shoots about 6 inches apart to keep the older branches covered with fruiting spurs. A sharp look-out must be kept for caterpillars, which often do much damage to the young foliage and fruit. Hand-picking is the only remedy, and it is seldom anything else attacks the Apricot, but a good wash two or three times a week in warm weather with a garden engine will assist in keeping the trees healthy. In dry weather supply water at the roots, giving a good mulching afterwards of half-decayed manure, the young fruits being thinned to 3 inches apart when they are as large as Peas, leaving those that are best placed for swelling, and all the largest fruits. When these attain the size of marbles they can be again thinned, leaving them 9 inches apart in the large fruiting varieties such as Moorpark, and 6 inches for the smaller ones; the best of those pulled off at this period make excellent tarts.

PEARS.—In the colder parts of the kingdom these will now be in full flower, and are worthy of a little assistance in the shape of protection if frost is expected. A piece of dry canvas, frigi domo, or some similar material, stretched over them for one frosty night will sometimes insure a crop where failure would otherwise be a certainty. Caterpillars soon appear on Pears after the flowers open, and should be dealt with at once, or they soon attack the fruit and spoil it. They are easily found by the leaves, which they roll together.

WALL TREE PROTECTORS.—Nets and canvas must be dispensed with as soon as all danger of severe frost and cold winds is over, and while they remain remove them every day to give the trees the full benefit of the sun and render the foliage hardy.

WATERING.—In dry weather all newly planted trees will be much benefited by a good soaking of water, and old-established trees on walls may be assisted in a similar way. The rainfall lately in many places has not been sufficient to reach the roots of trees in dry positions. If liquid manure can be obtained it may be used for any fruit trees that have set a good crop, but those trees that usually make too much strong wood should have nothing but clear water. All wall trees ought to be occasionally washed with the garden engine during warm weather after the fruit is set. This is best done in the afternoon as soon as the sun is

off. If green fly is troublesome syringe them with tobacco water as before advised, or with softsoap at the rate of 2 ozs. to the gallon of water, and the clear water spraying may be discontinued for a few days. Gishurst compound is still one of the best remedies for mildew or red spider if applied at 2 ozs. to the gallon of water and not rinsed off afterwards; it is also destructive to aphides. The efficiency of these insecticides depends very largely on the mode of application. The syringe must be worked gently in an upward direction so as to reach the under side of the leaves, and always commence operations before the enemy gains a strong foothold.

FRUIT FORCING.

VINES.—*Early Houses.*—Insect pests are inseparable from early forcing operations, and the appearance of red spider on Vines is certain. They not only prejudice the current crop, but so impair the vital forces of the Vines as to affect that of the following season. Thrips are in degree only worse than attacks of red spider, and are usually introduced by plants infested with them. Persons in charge of fruit houses cannot be too careful not to commence operations on Vines direct from working amongst red spider infested plants, or Azaleas attacked by thrips. Where red spider has obtained a hold prompt measures must be adopted for its destruction. Recourse cannot be had to syringing after the Grapes are advanced in colouring, because the water washes off the bloom and often leaves a stain on the berries. Sponging the leaves, though a good means of preventing the spread of the pest, and if taken in time effectual, yet in most cases recourse is had to it so late as to render it but a partial remedy by a tedious operation. The judicious application of sulphur to the hot-water pipes is the most effectual remedy. Heat the hot-water pipes to between 180° and 200°, and paint them thinly with a mixture of sulphur and skim milk. Keep the pipes hot for about an hour, and then the heat may be allowed to fall to the ordinary degree. Close the ventilators, and take care not to give too much. Some Grapes, such as Frontignans and Muscats, are apt to be discoloured by the sulphur fumes, and sometimes have the skins hardened to an extent that causes the berries to crack. Sulphur applied to hot-water pipes whilst the Grapes are young is liable to cause them to rust, and unless carefully used is not safe. It would be unnecessary to use sulphur were proper regard paid to assailing the pest upon its first appearance, and there is nothing better than sponging the affected parts with softsoap, 2 ounces to the gallon of water. Thrips readily succumb to fumigation with tobacco on two or three consecutive calm evenings, repeating at intervals of a few days so as to destroy those escaping the first fumigations through being in the egg state, and since hatched out. Early Grapes that are ripe will only require enough fire heat to maintain a circulation of dry air, allowing the temperature to fall to 60° at night.

Second Early Houses.—The fruit of Vines started at the new year is commencing to colour. No great means should as yet be taken to produce a dry condition of the atmosphere, as the Grapes swell considerably in ripening. Maintain a moist atmosphere in the early stages of ripening, sprinkling the house in the early part of the day, and at closing time. Provide a little ventilation constantly to induce a change of air and prevent the deposition of moisture on the berries. A warm genial condition of the atmosphere with a circulation of air is essential to the thorough swelling of the berries. Maintain the temperature at 70° to 75° by day from artificial means, and 80° to 85° through the day from sun heat, advancing in the afternoon to 90° or 95°, falling with the declining sun or light to a night temperature of 60° to 65°, 5° more both day and night being necessary for Muscats. As the fruit advances in colouring the moisture should be gradually reduced and the ventilation increased, but there must not be any diminution of the temperature until the Grapes are thoroughly ripe. The inside border must have due supplies of water or liquid manure, the quantity being such as to thoroughly moisten the border to its full depth, and give a mulch of short material. Grapes that are liable to crack, such as Madresfield Court, may, when ripening commences, have the needful supplies of water or liquid manure, and then have the inside border mulched with 4 to 6 inches thickness of dry material, which, with early ventilation, insures this remarkably fine Grape arriving at perfection.

Succession Houses.—The remarks as to thinning, disbudding, stopping and tying given in former calendars still apply; especially let all superfluous bunches be removed as soon as the number to be left on a Vine is decided. Examine the borders of all succession houses at least once a week, and when dry supply water freely. Inside borders will take almost any quantity of water after the Vines are in full foliage, and with a full crop of Grapes apply liquid manure at every alternate watering. Outside borders, except in special cases, will not as yet require water.

Late Houses.—The Vines making rapid progress must be tied out, and stopped as soon as they have made sufficient growth to cover the trellis with foliage. Every care should be taken to secure good colour and firm texture in the leaves by free yet judicious ventilation. Take advantage of sun heat to increase the ventilation early in the day, but close early, excessive fire heat being injurious and costly.

Newly Planted Vines.—With advancing growth—an evidence that the roots are active—close attention will need to be given to the roots to see that they do not suffer from over-dryness. Allow all the wood to remain that can be exposed to light, but supernumeraries intended for fruiting next year should be confined to one rod or cane, and the laterals pinched at the first joint, and to that of subsequent growths, stopping the canes at 6 to 8 feet.

Vines in Unheated Houses.—The Vines are making rapid progress, and in many instances the growths will require disbudding, stopping, and tying. One shoot is sufficient to each spur unless they are wide apart, when two may be left, but there must be scrupulous attention to prevent overcrowding; every leaf must have exposure to light and air. Reserve those that show the best bunches, rubbing the others off. Stop two joints beyond the bunches, but rather than crowd the foliage stop them at one joint. Tie down the shoots carefully and gradually. Old Vines sometimes do not bear freely on spurs, being weak. It is best in that case to lay in shoots from the base and along the rods at intervals of 2 to 3 feet, which will increase the root action, the Vines attaining increased vigour, and longer pruning will usually afford better crops of Grapes; indeed old Vines with fresh canes bear excellently. Apply a light dressing of artificial manure to the border, and point it lightly in. Inside borders may be given tepid water or liquid manure, when dry a thorough soaking, and a mulching of short rather fresh stable manure will, by keeping the surface moist, encourage active roots.

THE FLOWER GARDEN.

Calceolarias.—Shrubby Calceolarias are somewhat scarce this spring, a variety of causes having contributed to their destruction. Their loss will be much felt, especially by those who are obliged to depend largely upon half-hardy plants to fill their beds. Those that were preserved ought to be temporarily bedded out in rough frames, wide trenches, or other positions, where they will have a chance of gaining strength and be protected, if need be, from severe frosts. They root the most strongly and transplant the most surely out of a rather light and rich compost, and either leaf soil or old Mushroom bed manure may well, therefore, be freely mixed with the soil used in the beds. Put out the plants not less than 6 inches apart each way, keep well supplied with water, shade from strong sunshine for a few days, and protect from cold winds and frost. If only a few are grown these would be better placed in rather deep boxes of good soil than singly in pots.

Substitutes for Calceolarias.—Calceolarias are undoubtedly the best yellow-flowered bedding plants, but if not forthcoming substitutes must be found. *Tagetes signata pumila* and Golden Ring, an improvement on the old form as being more compact in growth, sown now or a week hence somewhat thinly in boxes and placed in a warminery or gentle heat of some kind, germinates in a few days, and will be quite large enough for transplanting direct to the beds by the time wanted. The individual flowers are poor, but they are continuously produced and a mass of colour soon presented. For the back rows of borders, centres of beds, and for mixed beds the lemon and orange-flowered African Marigolds are to be recommended, and these ought especially to be grown where many flowers are required for church decoration at harvest thanksgivings. Dwarf forms, these attaining a height of about 18 inches, can also be had in both colours. The French Marigolds are also very effective in borders, but as a rule scarcely regular enough in growth for any but mixed flower beds. A noteworthy exception will be found in the miniature forms, these seldom exceeding a height of 6 inches, and are therefore admirably adapted for the outer rows in beds. There are two distinct colours, brown and yellow, the latter being the most effective and a good substitute for Calceolarias. Both African and French Marigolds may be raised very quickly as advised in the case of *Tagetes*, and should be hardened carefully, a slight frost crippling them. It is a mistake to raise them before May.

Iresines, Coleus, and Alternanthera.—If any or all of these are required in large quantities or are scarce, the propagation by cuttings should be persevered with up to the end of May. Every tiny top will root quickly in brisk heat, and being kept growing strongly good plants will be available by the middle of June or by the time this class of plants can safely be bedded out. Cuttings being plentiful, the simplest plan of raising a large number of plants is to turn out Violets from pits and frames and to form a slight hotbed in these. Cover this with 6 inches or rather less of fine light soil, face over with sand, and dibble out the cuttings direct into this, disposing them not less than 3 inches apart each way; keep them close, uniformly moist, and shaded from sunshine, and they will root quickly and rapidly develop into strong plants. Being duly hardened off they can be transplanted direct to the flower beds. Smaller numbers of cuttings may be placed in boxes of fine sandy soil, and in other respects be treated similarly to those in beds. Coleuses move best out of small pots, and cuttings should therefore be potted where possible, rooted plants of *Iresines* and *Alternantheras* being either placed in boxes or potted.

Ricinus, Maize, Perilla.—Seeds of these and also of Sunflowers, Nasturtiums, Amaranthuses, and Beet may yet be sown in heat, and good plants be had for the beds and borders. *Perilla* and Amaranthuses move out of seed pans and boxes without experiencing much check, especially if the seed is not sown very thickly, but the seeds of the rest may well be sown singly in pots, 5-inch sizes answering well for the *Ricinus*, and 3-inch pots for the rest. Place in gentle heat and keep the seedlings near the glass to prevent them from becoming drawn.

Pricking out Seedlings.—For carpet bedding the Golden Pyrethrum ought not to be large, the best plants for the purpose being those raised moderately thickly in beds or boxes, and not pricked out. Stronger plants being less trouble after they are put out are the best for ordinary bedding out, and the seedlings in pans and boxes should therefore be pricked out either in other boxes, or better still, in frames. Dispose them 3 inches apart each way in good soil. Treat *Ageratum*s similarly, only giving the plants rather more room, also pinching out the flower

heads. *Lobelias*, again, whether raised from seed, cuttings, or by division, ought not long to be kept in a starving condition, but would pay well for being temporarily bedded out under glass, and prevented from flowering. *Gaillardias*, *Antirrhinums*, *Pentstemons*, *Asters*, *Stocks*, *Zinnias*, *Godetias*, *Helichrysums*, and other half-hardy annuals if raised at all thickly soon spoil each other, and bed out badly. Make up frames with or without gentle bottom heat for these, and prick out 3 inches apart each way in good light soil. Failing frames prick them out in boxes. Keep all pricked-out plants somewhat close and well shaded for a time, overhead sprinklings being frequent, and gentle waterings given whenever the soil is at all dry, and they will then rapidly recover from the check, and make fine plants by the end of May. Even if there is not time for much top growth to be made, they will have formed fresh roots, and will transplant the more readily accordingly.

Violets.—The late winter destroyed a considerable number of these, old plants being the greatest sufferers. Young plants, in addition to being the hardiest also produce much the finest flowers, and new plantations ought, therefore, to be made every spring, a breadth of plants being destroyed, none being retained after they have been on the ground two or at the most three years. Moderately rich well worked ground suits Violets well, and the more exposed the plants the hardier they are, those drawn up among trees being the first to suffer from damp, red spider, and frosts. Make the ground firm, select rooted divisions, discarding the very old pieces, and dibble out 12 inches apart in rows 18 inches asunder. The Russian varieties, notably *The Czar*, are the most serviceable for affording blooms throughout the winter or whenever the weather is not very frosty, but the Italian *Marie Louise* and *Comte de Brazzi's White* are hardier than it is generally thought, and are charming objects in the flower garden. For the latter purpose a good stock of plants may be raised from divisions, putting these out on good not lumpy ground 6 inches apart. They will readily transplant to the flower beds next autumn. Keep all newly planted Violets well supplied with water, mulch early with leaf soil or other short material, and if red spider is troublesome syringe frequently in hot weather.



APIARIAN NOTES.

THE WEATHER.

MAY has brought a pleasant change; copious showers, with a rise of 20° in night temperature. There were two mornings only during April, when the temperature was above freezing; the one 38°, the other 35°; only three mornings above 25°, and only one slight shower on the morning of the 30th. During the whole month bees were never out longer than a few minutes at a time.

AMONGST BEE-KEEPERS.

It was not the least pleasant part of my business to visit recently some historical and picturesque places on the Clyde. One of the grandest lies between Crossford and Tillietudlum Castle; from the bottom of the ravine of the Nethan water the cliffs rise almost perpendicular to between 200 and 300 feet. Bee-keepers are numerous, and all admit the present untoward spring has kept the bees back greatly. Bee-keeping in general had a good share of our talk and time, and certainly no little amusement was created by the remarks of some on what Mr. Wm. McNally has written in a contemporary, "That the Scotch bee-keepers are comparatively behind the times in taking bees to the hills;" but all were of the opinion that the writer would be much enlightened if he paid a visit to Scotch bee-keepers, where he would learn that what he deplures, and what he tries to teach them, was perfected long ago. Honey pressers were here in great variety, and some of an ingenious nature. One thing most of the bee-keepers were agreed upon was the unsuitableness and unportableness of the standard hive for bee-keeping generally.

ROBBING.

With fine weather and the incoming of honey, robbers will not be so troublesome as they were during April, but if a cessation of a honey flow takes place it is likely to be resumed. Prevention is in this, as in some other things, better than cure. When once several strong hives attack the weaker there is absolutely no cure but to remove the robbed hive to a distance out of the way, and

this in many cases is not worth the trouble. The next best thing is to add young bees till it acts on the defensive. What we wish to fully impress on bee-keepers is to avoid the teachings of those who advise smearing the robbed hive with carbolic acid. To do so is courting failure. It turns the bees from the point of defence, and allows the marauding bees to enter without resentment, and will pass through entrances heavily smeared with carbolic acid for the coveted sweets within. We have lessened the robbing greatly by smearing the entrance and landing board of the robbing hive, but only made matters worse when the robbed hive was smeared.

BEE ESCAPES.

Contrivances for emptying supers of bees have been receiving much attention of late from Americans and bee-keepers of this country. I think it was the late Rev. Mr. Taylor that was the inventor of this "bee trap," as it was then called, and was described in the "Cottage Gardener" and "Bee-keeping for the Many" about thirty years ago, or perhaps more. I am writing from memory. Of the different contrivances I have seen and tried, none is superior to the original ones; but many were sent out that had the trap in one piece, so that when bees passed out others went in.

The proper form was to cut the talc or other transparent material into narrow strips, a little less than quarter-inch wide. These were either hinged to a wire transverse to the pieces of talc, or gummed to a ribbon; the former plan was the best. A bevelled doorway, cut out of an inch board the width of the trap, completed the arrangement. The super stood upon the board, and the doorway was cut from about 1½ inch down to nothing in the bottom edge, and the trap placed in this the bees soon left the super, and none could enter.

But neither it nor any other effects the emptying of supers of bees so satisfactorily nor so quickly as the carbolic paper. When properly performed a few seconds suffice to finish the operation; consequently, there are no combs broken by the bees, as are sometimes apt to be when escapes are used.

"THE HONEY BEE."

My opinion is asked respecting the above work. I have not seen it, but have heard the plates are good, and I think the text compiled from such high authorities should also be good, although it may not be faultless. I understand that he mentions that stimulating bees is the cause of queens failing sooner than otherwise. Stimulative feeding certainly exhausts the queen both in egg-laying and constitution, and is productive of much evil in the hive, and it will be well if the warning note be taken, although it is not intended as one. It states that it is the spermatheca that becomes exhausted, but in ninety-nine cases out of every hundred exhausted queens I have examined, the ovaries and not the spermatheca were exhausted. The review also states that "care has been taken when treating of discoveries to give the discoverer the full credit of his work." If this is new in bee literature, and worth purchasing on that account.

PATENT RIGHTS.

I beg to thank "A Hallamshire Bee-keeper" for the valuable information he has given. Some of it is just what I expected. I never could understand why patents could either be sought for or granted for contrivances that little intelligence could conceive, as is the case with many things connected with bee appliances, some of them being but the common arts of the trade. A great fuss was made in America about the invention of the one-piece sections; one-piece supers and one-piece boxes have been made in this country from time immemorial. I have made them for forty years, and have still the patterns of some in my workshop. As regards Meadows' claim to protection I cannot see he has the slightest, and I am prepared if required to defend any action that he might think of commencing.

The fundamental principles of bee-keeping have in many cases been entirely ignored under the régime of modern bee-keepers, who are but gradually beginning to grasp what they ought to have taken a firm grip of at the commencement of their career. Happily self-interest has had its day, and bee-keepers are now seeing that they have been misled, and are now striking out for themselves into paths and appliances more consistent with and for bee-keeping than they were forced to adopt.—A LANARKSHIRE BEE-KEEPER.

PATENT RIGHTS.

OUR friend, "A Hallamshire Bee-keeper," is not quite correct in his explanation of the Patent Laws. The public do not "patent things which should be registered as designs, and register things that should be patented," for the simple reason that they cannot; the Office looks after that. The Comptroller cannot refuse an application for a patent for anything so long as it is not *contra bonos mores*—that is, not against good morals, and anything can practically be patented whether it is useful or not, provided the stamp duties are paid. The "validity" of the patent rests with the Courts—that is, it does not follow because the Great Seal has been appended to a specification that the "inventor" has a monopoly in his invention. That is a matter to be tested. The "Hallamshire Bee-keeper" is altogether wrong about Bell, Edison, and Hughes. Bell's telephone in its original form is known as the "English Mechanic" telephone, because a description of it was published in that paper before the patent was granted in this country; Edison claims the carbon transmitter, and those who own that patent have succeeded in establishing their point; but it is wrong to say that "subsequently" Professor Hughes invented the microphone, and that "unfortunately for himself" he did not patent it. Professor Hughes never had any intention of patenting his microphone, which in its simplest form was merely three wire nails (one laid across the others). He certainly was not "subsequent," but rather preceded Edison's patent, and Edison accused Preece of informing Hughes, as can be seen by reference to correspondence in the *English Mechanic*.

The "Hallamshire Bee-keeper" is also wrong when he says that "Any person can get a valid patent." He must omit the word "valid," the validity being entirely a matter for the Law Courts. To put it briefly a patent is simply a register that So-and-so invented, or said he invented, such and such a thing, and until his claim is upset in a court of law it holds good; but letters patent do not do more than offer proof that he claimed the invention, and obtained a patent on his specification, the wording of which, especially the claim, is of great importance, as in the very instance cited of the Edison telephone, which turned entirely on the question as to what is a "carbon contact." The advantage of taking out a patent is just this, that it is a *prima facie* evidence of prior invention, and that the onus of proof to the contrary lies on the infringer.—SAMUEL RAY, *Algernon Road, Hendon, N.W.*

BEEES AND BEE PLANTS.—The busy bees have worked their way into the good graces of the masses, and their sweet product is welcome upon the table everywhere. The apiary is not unknown to many countries of the older States, and in many townships there are several. The subject is so important that the leading farm journals devote space regularly to the subject. If all this is so it seems about time to begin to consider the honey crop as one to be planned for as much as for Sorghum or Maple sugar, for Maple orchards planted for tapping are not rare nowadays. Some plants are pre-eminently honey or nectar producers, and it may be possible to grow these as a crop for the sake of furnishing a pasture for the bees. Professor Cook claims that the greatest hindrance to bee-keeping is not "winter killing" or "foul brood," but lack of nectar. It is possible to depend upon wild flowers for a large share of the crop, and provide a pasture at the times when there would otherwise be dearth of nectar. There is a species of Cleome known as the Rocky Mountain bee plant that has been tested somewhat. Then there is the Chapman honey plant (*Echinops*). A Mint (*Melissa*) has also been employed. The right plant may not yet have been found. Those experimenting in the apiary are doing a good work along many lines, and in time the bee pasture will be a thing to be admired for its beauty and its profit as well.—(*American Agriculturist*.)

TRADE CATALOGUES RECEIVED.

Messrs. Messenger & Co., Loughborough.—*Illustrated Catalogue of Horticultural Buildings and Heating Apparatus.*
Messrs. Hogg & Wood, Coldstream, N.B.—*List of Farm Seeds.*
Auguste Ray G. Boucher, 164, Avenue d'Italie, Paris.—*General Fruit Catalogue.*



TO CORRESPONDENTS

All correspondence should be directed either to "THE EDITOR" or to "THE PUBLISHER." Letters addressed to Dr. Hogg or members of the staff often remain unopened unavoidably. We request that no one will write privately to any of our correspondents, as doing so subjects them to unjustifiable trouble and expense.

Correspondents should not mix up on the same sheet questions relating to Gardening and those on Bee subjects, and should never send more than two or three questions at once. All articles intended for insertion should be written on one side of the paper only. We cannot reply to questions through the post, and we do not undertake to return rejected communications.

Letter (E. T. B.).—The letter has been forwarded in accordance with your request.

Peach Culture (J. A.).—You will find an article by Mr. Rivers in this Journal on page 220, September 11th, 1890, which may perhaps be the one you require. Another by the same authority appeared on page 340, October 11th, 1888.

Proliferous Hyacinth (Jus. Carter & Co.).—We made no pretence to report the Show in question, though we subsequently heard you exhibited a plant of Hyacinth Grand Maître with nine good spikes of flower from one bulb. Your letter of verification arrived one post too late for insertion.

Mulching with Lawn Mowings (J. X. Z.).—The short grass cut from lawns may be applied with advantage to most crops in soil of a light sandy nature. The dressing is more useful in arresting evaporation than for any fertilising properties it contains; but will do more good than harm if dug in when no longer needed as a mulch in supplying a little humus which is generally deficient in sandy soils.

Tasmanian Apples (E. Ockenden).—As you live so near Covent Garden, by far the best plan would be for you to examine the different priced samples that are usually on view there. Your question is incapable of a categorical reply, as the prices vary more than 100 per cent. In a fruiterer's shop we have seen them sold this week at 2d. a pound for poor fruit, 6d. for superior. Prices are governed by quality and supply, and therefore constantly changing.

Hyacinths Failing (North Staffs.).—The bulbs sent were good, and not the cause of the failure. We have seen similar examples, and attributed the origin of the evil to water having lodged in the axils of the leaves, then becoming frozen, and remaining so for a considerable time, and thus rupturing by compression the sap vessels in the stems. The particular varieties or plants injured may have been somewhat more advanced than others at a critical time, and possibly the others had a very narrow escape from being similarly strangled. The bulbs are sound and roots and leaves healthy.

Thrips on Vines (A Lady Gardener).—The vinery may be fumigated with good tobacco paper, but take care to have the foliage dry and not give an overdose, delivering the smoke cool. It is better to fumigate on two or three consecutive evenings moderately than one powerful fumigation likely to damage the tender growths. The great evil of thrips is that fumigations for their extirpation need to be repeated at intervals of a few days, because the first fumigation only destroys the pests then existing. Vines, therefore, may be perfectly free from insects after a fumigation, and in the course of a week or ten days they are again infested with thrips simply because another generation has appeared. Repeat the fumigation at not more distant intervals than a week for a few times, but avoid fumigating whilst the Vines are in flower.

Propagating Clematis from Cuttings (Nemo).—These are generally grafted on pieces of root obtained from old plants grown outside, those of *C. flammula* answering the purpose well. These should be split open and the small scions inserted and tied with matting. A single bud is sufficient. They should be placed in small pots, and transferred to a propagating case or close frame with a warm moist atmosphere. When well united harden them gradually. Cuttings can be made of the young shoots, which may be cut up to an eye, and inserted in small pots of sandy soil in gentle heat, covering with a close frame. Layers emit roots at the joints covered, in the course of a year, provided they are well watered, severing in spring just before growth commences.

Arranging Carpet Beds (Merchant).—It is contrary to our rule, as we have many times stated, to propose arrangements of plants; but we examine those that are submitted, and suggest amendments if we can. In this case, however, we had the opportunity of showing the design and list of plants to Mr. A. Graham, of Hampton Court, and he says the plants are not the best for the purpose, but might be employed

as follows:—Raise 9, 10, 11, 12, 13, 14, 15, and 16, about 4 inches above the grass, bevel the edges, and plant with *Echeveria* and a little *Sedum* interspersed between; 1 and 5, blue *Lobelia*, with a little edging of *Alternanthera*; 7 and 3, Golden Feather, with an edging of blue *Lobelia*; 6 and 2, *Centaurea*; 4 and 8, *Alternanthera*, edged with *Mesembryanthemum*. If you desire further information on this subject please indicate your propositions on any diagrams you may enclose.

Bunches of Grapes Dwindling (A. W.).—The bunches are little further developed than tendrils, and are probably the result of an insufficient storing of elaborated sap, due to immaturity of the wood. There is no remedy but duly exposing a larger amount of foliage to light and air, not necessarily with a quantity of growths, but the principal ones kept rather thin, and the leaves to which the Vines will be pruned must be kept free from laterals shading or in any way interfering with their elaborating and assimilating functions, pinching the laterals from those joints at the first leaf, and to one of subsequent growth. To further concentrate the strength on the buds stop the side growths at the sixth leaf, and the leading growths at 3 feet, taking up a lateral as a continuation. Above all avoid overcrowding, ventilating freely so as to insure sturdy growths and thick textured leaves. Prune to plump round buds as near the base of the current growth as possible. Too close pruning often means cutting away all the coming year's Grapes.

Grafting Orange Trees (F. K.).

—Your seedlings, we presume, being young, may be grafted now with any good variety of which you can obtain cuttings of healthy shoots with leaves grown last year and now a little firm but not hard. Let these be long enough for inserting in a bottle of water, and about 3 inches from the top of the shoot to be attached, take a slice off the bark 2 inches long, and just into the firm wood. An exactly similar slice, and exactly opposite, being taken from the stock, the two can be joined and secured, as shown in the sketch. The water will support the graft until the union takes place, and this is quicker and more certain if the grafted part is shaded from the sun and sprinkled every day. When the graft commences growing gradually cut away the head of the seedling tree, removing a little at a time, until only the graft remains. The part inserted in the bottle may then be cut off close to the stem. If the portion attached is taken from a fruitful tree, fruit will be produced years before it could be borne by a seedling tree. Your small house will be suitable for the plants, and if established in separate pots, and healthy, do not repot them till some time after the grafts are growing freely, and then you had better, perhaps, write again. You ought to have given particulars respecting the age and condition of the seedlings.



FIG. 69.
GRAFTING ORANGE TREES.

Dressing Fruit Trees with Artificials (S. J. A.).—The use of artificial manures over the foliage is not judicious, particularly those that dissolve readily, or become deliquescent, or rapidly absorb moisture when mixed with other substances. Nitrate of soda will disfigure every leaf it falls upon, so also will either of the other two substances, namely—superphosphate and muriate of potash, but it is only when the former contains an excess of sulphuric acid, which is very seldom, and the latter an undue proportion of hydrochloric acid, this being more common than the other. The injury probably arises from this cause; in fact, it appears you have far more chloride proportionately than potash, but that of course can only be ascertained by analysis. Muriate of potash is not safe to apply over foliage, and in soils deficient of humus this salt is destructive alone, but nitrate of soda neutralises its injurious properties, and it is most efficacious when mixed with bonemeal, therefore avoiding danger of an excess of acid.

Paris Green and Red Spider (W. B.).—Paris green sprayed on Apple and Plum trees does not do the least harm to Gooseberry and Currant bushes growing under them, but on the contrary has been of great benefit to thousands in preventing their being devoured by caterpillars. It must not be used in excess, 1 oz. to ten gallons of water sufficing to destroy caterpillars, and it must be constantly stirred or the poison will sink to the bottom of the vessel. Through this cause it has often done serious injury to fruit trees. Paris green can be kept in suspension in water by constant agitation, but cannot be dissolved. It is best because safest in the paste form, as advertised by Messrs. Blundell & Spence. We should not apply it to red-spider-infested Gooseberry bushes, as the fruit is usually large enough for use when the bushes are infested. We do not know of anything better for destroying the spider than syringing with sulphur and water; but the insects chiefly attack the under sides of the leaves. Plenty of liquid manure applied to the roots now to promote the development of stout foliage and fine fruit, is an excellent preventive of the insidious enemy.

Remedies with Sulphur (S. S.).—Many substances may be mixed with sulphur that will cause it to adhere to the hot-water pipes. Oils are not good, neither those that remain soft nor those that become hard. The former give off fumes not suited to healthy vegetation, and the latter seal the sulphur, rendering it useless as an insecticide or fungicide. Linseed oil is the least objectionable, but it becomes a fixture, and sulphur if used at all should be in a form that it can be washed off. The following are good for forming sulphur into a thin cream such as is suitable for applying to hot-water pipes for the destruction of red spider and mildew:—Best skim milk can be incorporated thoroughly, and is easily washed off; softsoap solution 4 ozs. to the gallon; quicklime formed into a thin whitewash, adding sulphur to bring it to the consistency of cream; or to be definite, take 1 lb. of quicklime and 1 lb. of flowers of sulphur, slack the lime in a tub, add water to form a thin whitewash, then add the sulphur. These compositions should be applied with a brush whilst the hot-water pipes are heated to 160° or more and the house closed, keeping the pipes hot about an hour whilst and after the mixture is applied, then allowed to fall to the ordinary temperature. Sulphur fumes are effective against red spider, but require care, for when the pipes are highly heated and the fumes are long continued there is danger of the foliage being hardened so as not to develop well afterwards, and Grapes are often seriously damaged. Good management is the best preventive of red spider, and syringing with a solution of softsoap 2 ozs. to the gallon of water will destroy it. There is no better preventive than clear water. Sulphur is not soluble without forming it into a sulphide. That may be done easily—viz., slack 1 lb. quicklime in a pan or copper, forming a thin whitewash with a gallon of water, then add 1 lb. flowers of sulphur, mix thoroughly, and boil a quarter of an hour, keeping it stirred all the time. Let it settle and cool, then pour off the liquor, bottle it, keeping it well corked in a dark place. Use 1 pint to 12 gallons of water, or a quarter of a pint to 3 gallons. This is for mildew; if for insects add 2 ozs. softsoap to each gallon of water, thoroughly dissolving before adding the bisulphide of calcium. All sulphides discolour paint, but it passes off. If using sulphur form it into a paste with a solution of softsoap 8 ozs. to the gallon, using 2 ozs. of sulphur, dilute to 4 gallons, and keep it mixed by alternately syringing into the vessel and on the infected plants. It was not in the least necessary to adopt your suggestion.

Spiræa japonica (H. J. H.).—To prepare these plants so that they will flower profusely they should be planted in an open sunny position in autumn, winter, or just preceding growth in spring. It is not too late even now to attain success for another year, provided you have suitable plants to start with, and water is supplied after they are placed out, if the weather prove dry, until they are established in the soil. Our plan is to prepare some plants annually, and then throw to the rubbish heap all those that are forced after flowering, unless they are required for stock purposes. In this case they are turned out of their pots and "laid in" thickly together until autumn or winter, when they are divided and planted out on well manured ground 1 foot between the plants, and 15 inches between the rows. Lift at once those you are certain will not flower, and if the clumps are large divide them according to the size desired. Those with moderate sized crowns are the best for planting, because they will in one season's growth develop flowering crowns. Plants that will flower freely outside if allowed to remain, are useless if lifted and divided for producing in one season strong flowering crowns. After flowering the crown divides naturally, and there is not time in one season for the new ones to develop. For our annual stock we plant more than are really needed, and leave them to flower outside. These after flowering form small or moderate crowns only, and whenever convenient after the foliage has naturally died away are lifted, divided, and replanted for the next season. When lifting we select for pots only those clumps that have well developed crowns, and a little experience will enable anyone to detect these. Those that are deficient in flowering crowns are preserved and planted again, either as they are for larger pots, or again divided according to requirements. These clumps invariably have one or more crowns that will flower amongst those that will not, and these are cut out with a knife before planting, in fact all that we think likely to flower. This is done because crowns that would flower afterwards form a number of small ones and crowd the others. We do not doubt that your plants have failed to flower because the crowns have never been thoroughly matured. Had they been given a south instead of a northern position they would probably have flowered well. Plants in pots now that have failed to flower, if well cared for in a cool house for a time until they can be plunged in a sunny position outside without checking them, would develop plump crowns, and flower profusely enough in the same pots another year. It will be necessary to keep them well supplied with water, and manure in a liquid state would also be beneficial.

Names of Fruits.—The names and addresses of senders of fruit to be named must in all cases be enclosed with the specimens, whether letters referring to the fruit are sent by post or not. The names are not necessarily required for publication, initials sufficing for that. Only six specimens can be named at once, and any beyond that number cannot be preserved. (*Inquirer.*)—The Apple is the Northern Greening.

Names of Plants.—We only undertake to name species of plants, not varieties that have originated from seed and termed florists' flowers. Flowering specimens are necessary of flowering plants, and Fern fronds should bear spores. Specimens should arrive in a fresh state in firm boxes. Slightly damp moss, soft green grass or leaves form the best packing, dry wool the worst. Not more than six specimens can be named at once,

and the numbers should be visible without untying the ligatures, it being often difficult to separate them when the paper is damp. (*G. H.*)—*Stapelia variegata.* (*W. H.*)—We cannot undertake to name varieties of Azaleas; but as a nurseryman's labels were attached to the specimens received from whom probably the Azaleas were obtained, why not send to him for the names? (*G. M.*)—1, *Dendrobium Wardianum*; 2, *Dendrobium luteolum*; 3, *Dendrobium macrophyllum.* (*G. B.*)—1, *Chionodoxa sardensis*; 2, *Anemone nemorosa*; 3, *Sanguinaria canadensis.* (*Broome Hall.*)—Thanks for your letter. We were glad to be able to help you, but the specimens you send this time are not so easily determined, and no numbers were attached. As near as we can judge the larger flower is near to *Narcissus bicolor* Empress and the other to *N. Barri conspicuus.*

COVENT GARDEN MARKET,—MAY 6TH.

MARKET steady. Supplies good at lower values.

FRUIT.

	s. d.	s. d.		s. d.	s. d.
Apples, ½ sieve	1 6	to 6 0	Kentish Cobs	40 0	to 50 0
" Nova Scotia and			Lemons, case	15 0	20 0
Canada, per barrel	15 0	26 0	Oranges, per 100 .. .	4 0	9 0
" Tasmanian, case	6 0	12 0	St. Michael Pines, each..	3 0	8 0
Grapes, New, per lb. ..	3 6	5 0	Strawberries, per lb. ..	3 0	6 0

VEGETABLES.

	s. d.	s. d.		s. d.	s. d.
Artichokes, dozen .. .	0 0	to 0 0	Mushrooms, punnet ..	1 6	to 2 0
Beans, Kidney, per lb. .	0 9	1 0	Mustard & Cress, punnet	0 2	0 0
Beet, Red, dozen .. .	1 0	0 0	Onions, bushel .. .	3 0	4 0
Brussels Sprouts, ½ sieve	3 0	4 0	Parsley, dozen bunches	2 0	3 0
Cabbage, dozen .. .	3 0	0 0	Parsnips, dozen .. .	1 0	0 0
Carrots, bunch .. .	0 4	0 0	Potatoes, per cwt. .. .	8 0	4 0
Cauliflowers, dozen .. .	3 0	6 0	Rhubarb, bundle .. .	0 2	0 3
Celery, bundle .. .	1 0	1 3	Salsafy, bundle .. .	1 0	1 6
Coleworts, doz. bunches	2 0	4 0	Scorzoneria, bundle .. .	1 6	0 0
Cucumbers, doz. .. .	3 0	5 0	Seakale, per bkt. .. .	1 0	1 6
Endive, dozen .. .	1 0	0 0	Shallots, per lb. .. .	0 3	0 0
Herbs, bunch .. .	0 2	0 0	Spinach, bushel .. .	5 0	6 0
Leeks, bunch .. .	0 2	0 0	Tomatoes, per lb. .. .	1 6	2 0
Lettuce, dozen .. .	3 0	3 6	Turnips, bunch .. .	0 0	0 4

AVERAGE WHOLESALE PRICES.

CUT FLOWERS.

	s. d.	s. d.		s. d.	s. d.
Arum Lilies, 12 blooms ..	2 0	to 4 0	Mignonette, 12 bunches..	3 0	to 6 0
A alea doz. sprays .. .	0 6	0 9	Mimosa (French), per		
Bouvardias, bunch .. .	0 9	1 0	bunch .. .	1 3	1 6
Camellia, white, per doz.	2 0	4 0	Narciss (Various) dozen		
" red .. .	0 9	1 6	bunches, French .. .	2 0	4 0
Carnations, 12 blooms ..	1 0	2 0	Pelargoniums, 12 trusses	6 0	9 0
Cyclamen, doz. blooms ..	0 3	0 6	" scarlet, 12 bnchs	4 0	6 0
Daffodils, doz. bunches ..	2 0	6 0	Primula (double) 12 sprays	0 6	1 0
Encharis, dozen .. .	3 0	6 0	Primroses, dozen bunches	0 4	0 9
Gardenias, per doz. .. .	1 0	3 0	Roses (indoor), dozen ..	0 6	1 6
Hyacinths doz. sprays ..	3 0	4 0	" Red (English) per		
" (Fench) doz. bunches	12 0	15 0	dozen blooms .. .	2 0	4 0
" (Dutch) in boxes ..	1 0	3 0	" Red, 12 bls. (Fench.)	2 0	4 0
Lapageria, 12 blooms ..	2 0	4 0	" Tea, white, dozen ..	1 0	3 0
Lilac (French) per bunch	5 0	6 0	" Yellow, dozen .. .	2 0	4 0
Lilium longiflorum, 12			Spiræa, per bunch .. .	0 6	0 9
blooms .. .	3 0	4 0	Tuberose, 12 blooms ..	1 0	1 6
Lily of the Valley, dozen			Tulips, per dozen .. .	0 4	0 6
sprays .. .	0 6	1 0	Violets (Parme), per beh.	3 0	4 0
Maidenhair Fern, dozen			" (dark), per beh. ..	2 9	3 0
bunches .. .	4 0	9 0	" (English), doz. bnch	0 6	1 0
Marguerites, 12 bunches	4 0	6 0	Wallflower, doz. bunches	1 6	2 6

PLANTS IN POTS.

	s. d.	s. d.		s. d.	s. d.
Aralia Sieboldi, dozen ..	6 0	to 18 0	Foliage plants, var., each	2 0	to 10 0
Arbor Vitæ (golden) doz.	6 0	8 0	Genista, per doz. .. .	6 0	9 0
Arm Lilies, per doz. ..	9 0	12 0	Hyacinths, doz. pots ..	5 0	8 0
Azalea, per plant .. .	2 0	3 6	Hydrangeas, per doz. ..	9 0	12 0
Cineraria, per doz. .. .	6 0	9 0	Lilium longiflorum, per		
Cyclamens, per doz. ..	9 0	18 0	dozen .. .	18 0	20 0
Deutzia, per doz. .. .	6 0	8 0	Lily of the Valley, per pot	1 0	2 0
Dielytra spectabilis, per			Marguerite Daisy, dozen	6 0	12 0
dozen .. .	8 0	12 0	Mignonette, per dozen ..	6 0	10 0
Dracæna terminalis, doz.	24 0	42 0	Myrtles, dozen .. .	6 0	12 0
" viridis, dozen .. .	12 0	24 0	Palms, in var., each ..	2 6	21 0
Erica, various, dozen ..	12 0	18 0	Pelargoniums, per doz. ..	12 0	18 0
Euonymus, var., dozen ..	6 0	18 0	Pelargoniums, scarlet, per		
Evergreens, in var., dozen	6 0	24 0	dozen .. .	6 0	9 0
Fairy Roses, per doz. ..	9 0	12 0	Primula siccensis, per doz.	4 0	6 0
Ferns, in variety, dozen..	4 0	18 0	Spiræa, per doz. .. .	8 0	12 0
Ficus elastica, each .. .	1 6	7 0	Tulips, dozen pots .. .	6 0	8 0

Bedding plants (in variety) in boxes, from 1s. to 3s.; in pots, per doz., 1s. to 2s.



FARM POULTRY.

THIS is the title of an article in the new part of the Journal of the Royal Agricultural Society of England. It is by Mr. W. B. Tegetmeier, and is so able, so practical, and so admirably

calculated to place the matter before farmers in a manner to arrest their attention and promote their best interests, that we emphasise its teaching, and extend its usefulness by bringing the pith of it under the notice of our readers.

At the outset the grave charge is brought against poultry shows of "useful properties having been almost entirely ignored, and prizes have been awarded for accuracy of marking in feathers, symmetry of comb, and other fancy points, having no reference whatever to the value of fowls as market or table poultry, or as egg producers." Deterioration all round in practical utility is, we are told, the outcome of such shows. We agree that undue stress has been laid upon fancy points, yet we must claim that the prizes now offered at some of the shows for dead poultry and eggs is a step in the right direction, and the extension of such classes is a thing much to be desired.

It is usefully explained that the constantly increasing numbers of imported eggs, especially from France, is not owing to the existence of large poultry farms abroad, but rather to fowls being kept everywhere, "every peasant proprietor, every *bordier*, with perhaps two or three acres of land, keeps fowls, the produce from which is collected by dealers who scour the country." Well, we have something very similar to this in the great chicken rearing district of Sussex, where every cottager and farmer rears all he can, some sending them to London dealers, but the majority being collected by the dealers' carts. Although the middlemen have the bulk of this business in their hands, it is still a very profitable one to the producer. But it involves constant attention and unflagging industry, for the chicken rearer is on the alert from dawn till dewy eve, and it is precisely a want of such attention that causes poultry to hold such an insignificant place in the farming industry of this country. From 200 to 300 head of poultry can be kept profitably on a single farm, and the number varies according to accommodation or system. No doubt portable poultry houses offer great facilities for the production of eggs, and with a visit to them twice daily there should be no difficulty in the way of keeping the maximum number of hens on even a medium-sized farm. Given that number and a good ordinary strain of farmyard Black Minorcas, if we place the average produce at 150 eggs per hen we have the respectable total of 15,000 eggs for every 100 hens kept.

Even when eggs only are the primary consideration there must be a systematic rearing of chickens every season, and for winter eggs early broods before May must be had. Mr. Tegetmeier gives much valuable advice about this matter. The nests, in accordance with Nature, should be on the damp ground, or in boxes containing moist earth. When the hen has sat a week the eggs are tested at night or in a dark room. Use a piece of stiff cardboard having an oval hole in it slightly smaller than an egg. Hold the cardboard upright between the eye and a lamp, place the egg against the hole. If the light shines through the egg clearly it is not fertile; if it does not, and the egg appears quite dark, it is fertile, and may be replaced under the hen. The other eggs should be withdrawn from the hens and kept as food for the prospective chickens. Of this food he says—"The first food for the chicken should be egg and milk (the clear eggs removed from the hens answer admirably for this purpose). Each egg should be beaten up with a couple of tablespoonfuls of milk, and set into a custard-like mass by the side of the fire or in the oven. This should not be given to the chickens until the hen has been abundantly fed with corn, and has satisfied her own hunger. For other food I much prefer to use a little canary seed or Egyptian dari to crushed grits, which are apt to become rancid from the external covering having been removed. Bread and milk can also be given to the chicks, and sweet meal and milk; but much loss in rearing chickens occurs by the use of old meal which has been exposed to the air after grinding, and has become pungent and acrid."

Of breeds, preference is given to Black Minorcas for eggs; we

are able to endorse this selection, as we have found it entirely satisfactory. For table poultry a cross between the Dorking and either the old fashioned English Game or Indian Game is recommended as affording a hardy, early matured and very plump breed. This is of special importance to home farmers, to whom repeatedly recommended the first cross. The fallacy of crossing we have for mere size, as has been done with Cochins, Brahmas, Langshans, &c., is explained, and the wisdom of careful selection and caution in bringing about changes is also usefully expounded.

In fattening for market or table, feeding three times a day with coarse fresh oatmeal mixed with milk, the first meal being given at sunrise, is advised. About a fortnight being the time given as necessary to fatten fowls. When cramming is resorted to the oatmeal is mixed with boiling milk, and a little mutton fat added to the mixture.

WORK ON THE HOME FARM.

Our cross-bred lambs from first cross Suffolk ewes and Hampshire Down sheep are fine, sturdy, vigorous animals, just a little larger, perhaps, than those from pure Suffolk dams and Hampshire Down sheep. All of them were early lambs, and are now so forward that we have had to consider carefully what shall be done with them. The best ewe lambs will be fed so as to keep them in lusty condition, as we intend breeding from them next season, but they will not run with the tups till next November, or till they are between ten and eleven months old. There will, probably, be a few barrens among them, but only a few; for at that age ewe lambs in high condition have hitherto answered very well, and we prefer the little extra outlay involved for food to waiting another season for a lamb. Forward wethers will be pushed on so as to come out for the butcher in August or September, but later ones will not be fed so highly, as they will be held over as hoggets for winter folding.

Many graziers are almost at their wit's end for food for the stock; well will it be if they are not also straitened so much in means and credit as to have to sell stock at a sacrifice. Better not do so if it can possibly be avoided, for a change of wind and a few warm showers would now quickly clothe the fields with verdure. The trial is certainly a severe one, and animals in purely grazing districts are falling off sadly in condition.

Meanwhile work on arable land goes gaily on, harrows, rollers, and cultivators being in full swing, and root crops are being got in with unusual celerity. Horse-hoeing corn, too, is being done with unusual quickness, and, what is more to the purpose, with excellent results, for weeds uprooted now under a clear sky and drying wind are soon dead. Much caution is necessary under present conditions of weather in harrowing spring corn. This is done to destroy Charlock, but it frequently loosens the Barley plant so much in the soil as to cause it to suffer severely. We have had Barley so badly infested with Charlock that we have ploughed it in Barley and Charlock together, and sown Oats. Some weak pieces of corn will have a dressing of 1 or 2 cwts. per acre of nitrate of soda should the weather become showery. Where mixed seeds are sown with Oats it is better to refrain from top-dressing with manure, and so avoid the risk of a too vigorous growth of corn to the damage of the "seeds."

METEOROLOGICAL OBSERVATIONS.

CAMDEN SQUARE, LONDON.

Lat. 51° 32' 40" N.; Long. 0° 8' 0" W.; Altitude, 111 feet.

DATE.	9 A.M.					IN THE DAY.				Rain	
	Barometer at 325 and Level.	Hygrometer.		Direction of Wind.	Temp. of soil at 1 foot.	Shade Temperature.		Radiation Temperature.			
		Dry.	Wet.			Max.	Min.	In sun.	On grass.		
1891.											
April and May.											
Sunday	26	30.032	42.8	39.0	E.	45.9	53.0	32.2	92.7	23.4	—
Monday	27	29.814	48.1	44.9	E.	44.9	61.3	31.9	100.4	23.0	—
Tuesday	28	29.555	57.1	47.2	N.W.	45.9	66.3	40.9	111.3	32.4	—
Wednesday ..	29	29.876	48.3	40.8	S.	47.7	57.0	37.6	66.8	27.9	—
Thursday	30	29.713	54.9	51.2	S.W.	47.2	63.9	46.4	97.1	43.0	—
Friday	1	29.649	55.2	51.6	S.W.	43.9	59.9	52.0	92.7	50.9	0.168
Saturday	2	29.658	51.6	48.6	S.	48.9	57.3	46.3	96.8	41.2	0.169
		29.747	51.1	46.2		47.1	59.7	41.0	94.0	34.5	0.337

REMARKS.

- 26th.—Bright early; overcast after 8 A.M., but a good deal of sunshine in afternoon.
 27th.—Bright till 3 P.M., then generally cloudy. Solar halo at 5 P.M.
 28th.—Brilliant morning; cloudy at times in afternoon.
 29th.—Cloudy, with spots of rain.
 30th.—Overcast with occasional drizzle early; fair day, with occasional sunshine.
 May 1st.—Gale from S.W. and heavy rain in morning; frequent sun in afternoon.
 2nd.—Overcast, with one or two heavy showers in morning; alternate rain and sunshine in afternoon.
 At last the temperature has risen to the average, the barometer has fallen, and we have a little rain.—G. J. SYMONS.



IT is questionable if during all past years such a profuse display of blossom has been seen at one time as is now expanded, or approaching expansion, in orchards and gardens. In the first place there was never so many fruit trees in a bearing state in the kingdom as at present, and it is impossible that the majority of them could be more floriferous. Nor does this remark apply to one kind of fruit alone, for all kinds appear to be fully robed in their light spring dress. It has occasionally, if not often, happened that Apple blossom has been abundant and Pear blossom sparse, or *vice versa*, while trees of one or other of the stone fruits have failed to appear in their most cheerful garb; but this year each kind seems to be as productive as the other, and the whole present a display such as has never been surpassed at one time if equalled. This is not altogether because of the different kinds of fruit trees producing blossom so abundantly, but this and something more—namely, all expanding within a shorter limit of time than is usual. Apple blossom is probably not far behind the ordinary period of expansion, but the prolonged cold and a dry atmosphere materially retarded the flowering of Pears, Plums, and Cherries, with the result that all may be seen in beauty at the same time, but not all in the same stage of development. Apples are naturally the latest, but more trees of them flowered this year before Plums, Cherries, and Pears cast their blossoms than were probably ever seen together before, and therefore the blossoming time of the present year may be regarded as one of the most complete that has been experienced.

A good fruit year appears to be generally anticipated, and at present the prospect is cheering; but it does not of necessity follow that if the yield is abundant it will be entirely the result of the late blossoming of the trees. It is not the time at which the flowers expand, but of the state of the weather at that time and immediately afterwards that is the governing factor in the case, or at least one of them, the other being the condition of the trees. During some previous years Pears and Plums have borne good crops when the trees blossomed three weeks or a month in advance of Apples, and although these flowered freely little or no fruit followed. In other years the reverse has been the case. Again, it has been noted that Apple trees which blossomed early, as some varieties do, have borne much better crops of fruit than have others which flowered a week or two later. No doubt the opposite of this has been apparent occasionally, and possessors of the trees have rushed to the conclusion that only late flowering sorts should be planted, and this they have advised. Possibly they may not have followed their own advice very rigidly; but, be that as it may, it is best avoided by fruit growers generally who desire to have the best supply of fruit. Common observation, if extended over a series of years, is sufficient to prove the fallacy of the late blossoming theory containing the elements of safety; and last year Mr. William Paul settled the matter by recording his observations systematically. He not only took note of the dates of flowering of ninety-five varieties of Apples, but of the size, substance, and character of the petals in reflexing from or incurving to and sheltering the essential organs of fructification. The result of his observations as tabulated in the *Journal of Horticulture* for March 6th, 1890, might be interestingly referred to at the present time.

The two varieties which expanded the first, Irish Peach and Duchess of Oldenburgh, are among the most reliable bearers, as are some others that flowered soon after them, such as Keswick Codlin, Red Astrachan, Golden Spire, Lord Suffield, Bedfordshire Foundling, and Warner's King. It is true that some of the late flowering sorts are equally free as a rule, but this does not prove the others untrustworthy. Most of the best bearers, however, among the early openers have cup-shaped flowers, and these may afford some protection to the pistil, which is the tenderest part; but in several of the regular-bearing later sorts the blossoms are reflexed, as Cox's Orange Pippin, Blenheim Pippin (slow to begin, but reliable when in a fruiting state), Dumelow's Seedling, King of the Pippins, and Fearn's Pippin. A glance at the varieties in Mr. Paul's list will suffice to show that what may be termed the most reliable bearers are scattered over the whole blossoming period, and it is perfectly clear that several of those which expand their flowers during the early part of May are just as certain to bear fruit as are those which do not open until after the middle of the month. In alluding to this subject at Chiswick last week Mr. Barron pointed to trees of the Duchess of Oldenburg in blossom, the earliest to open in the collection, and to others near them of Evagil, scarcely showing growth movement, but looking as if dead by comparison. Yet he remarked the early flowering Duchess rarely fails, and is just as likely to bear fruit this year as is the very late Evagil, and no doubt he is right.

The blossoms of some varieties of fruit appear to be essentially more hardy than others; and it is not unreasonable to assume that the hardiness of all is influenced by the condition of the trees. When the wood is what is known as well ripened, or, in other words, charged with nutrient mineral matter obtained from a well stored soil, and secreted by the leaves during a fine preceding autumn, it would be surprising if the blossoms did not share in the benefit, and be firmer and more highly perfected in consequence. There cannot be a doubt that they are better fortified, so to say, with the essential organs better developed, and to that fact is due the setting of those on well ripened, healthy, sturdily grown trees, while on over-luxuriant trees, with more or less sappy stems, they fall in shoals and leave no fruit behind them. The difference in productiveness of trees as influenced by the character of their growth has often been apparent when some have been taken up and transplanted, and others of the same variety have remained undisturbed. An instance of this may be cited. Last year was the reverse of a good Apple year, as most persons know, yet in a Kentish fruit plantation was seen one of the most prodigious crops of Cox's Orange Pippin Apples that the imagination can conceive. It was tenfold too great; or, in other words, if nine out of ten of the fruits had been removed in thinning, the crop then remaining would have been of at least twice the value of that actually produced, and the trees less exhausted. The Apples were wedged on the spurs and branches from base to summit, bushels of them not being so large as shelled Walnuts. It was a mistake; but that is not the question, but this is, Why did those trees bear ten times more Apples each than other trees of the same fine variety of the same age near them? Because the extraordinarily productive examples had been removed—taken up from among the others to give them more room and replanted. The result of this was the growth made afterwards was shorter, firmer, hardier, and the blossoms were also better developed in their essential parts and hardier in turn. They passed uninjured through weather vicissitudes to which millions on surrounding trees succumbed, and the fact is worthy of record. It teaches a lesson that ought not to be ignored—that trees, or those of them which are under control in gardens as thousands are, may be made to bear better and more certain crops than many of them do, by good management, or growing sound blossoms instead of luxuriant shoots like Willows, to be cut out in winter by the armful. Trees of this nature, though they may contain plenty

of blossoms, are totally unreliable for producing fruit; whereas those of an opposite nature, with short well nourished wood, and properly developed blossoms, are as certain to bear fruit as it is in the power of man to make them. But there is a limit to his power, and the weather, notwithstanding all his efforts, may prove the master.

There are two kinds of weather that are most injurious and may be fatal to fruit crops—these are the extremes of prolonged wet at a critical time, the blossoms “never dry” on the one hand, and unusually hot sun and dry winds extracting the moisture from them and shrivelling them up in a few days on the other. The danger from an excess of wet is generally admitted, that from the opposite circumstance not so widely appreciated. With an unclouded sky by day, no dew at night, and a brisk dry wind blowing all the time, fruit blossom vanishes too soon for the setting and swelling of fruit, and probably the more thickly the trees are covered with flowers the greater the liability of failure, because of the greater expanse of evaporating surface provided by the myriads of petals.

Fruit never sets and swells so well as when the blossoms are not overcrowded, when the temperature is genial, with sun enough to dry the pollen, gentle winds to disperse it, an occasional shower to freshen and sustain it, and promote free uninterrupted sap movement for the support of the embryo fruit. Those are the conditions to be hoped for. We cannot produce them, though we, perhaps, supply something that may be wanting. Small trees overlaid with blossom may be relieved, others that need support may be supported. A few “dashes” with the syringe at a well judged time, in dry blossom-exhausting weather, has caused fruits to set on one-half of Plum trees thus refreshed on a hot south wall, the other half being fruitless; and the same results have followed a similar experiment with Peach trees under glass, when the atmosphere of the house has been too dry, not otherwise.

Liquid manure applied to certain trees when blossoming may be of very great benefit—trees that do not make much growth extension, but develop many fruit buds, and now covered as with a sheet by pink or silvery flowers. Let a pailful or two of liquid manure be given to such trees as are small, and a proportionate quantity to larger, to feed the blossom, and note the results. The application cannot do harm to such trees, but may, and probably will, do good. Let an example be adduced. It may have been narrated before, but if it has is worth repeating. Mr. A. J. Thomas who had such a splendid table of fruit at the Guildhall Show last October is a grain, root, and fruit farmer near Sittingbourne. He has a Gascoigne's Seedling Apple tree on grass—a low standard, apparently nearly twenty years old. It affords him about £6 worth of its scarlet fruit annually, seldom or never failing. When the blossoms are opening he gives it a barrel or two of strong liquid manure, not a mere sprinkling, but a good soaking. To that he attributes its productiveness and handsome fruit. The liquid does much more good given to the tree than later in the season, and perhaps it would do more good still if given a little sooner; but the owner of the tree is satisfied, for he says by the few hours' labour expended and liquid supplied he obtains more profit from the small plot of ground the tree covers than he does from an acre of Wheat. There is not the least doubt he does. The tree is the reverse of luxuriant, but makes moderate healthy fruitful growth. The treatment suits it, as it would many another in similar or worse condition.

Blossoming time is a pleasant but an anxious time. We know not what the weather may be, what fruit blossoms may have to endure; but there is one favourable provision—a good leaf growth with the flowers, to afford them a little shelter or shade as may be needed, and neither will do harm, while the extending shoots and expanding leaves will draw the sap to the blossoms and sustain, let us hope, a good set of fruit for swelling to maturity.

—J. WRIGHT.

A CLEAR COURSE.

KITCHEN gardens generally have for many weeks past presented a desolate appearance, and few gardeners remember having previously seen them so destitute of green vegetables. Serving the kitchen and packing hampers has been, and still is, a very unthankful task, and in all probability many a vow has been registered that by “hook or by crook” such a scarcity shall not again prevail. Naturally we are much at the mercy of the elements, frosts included, and all we can do is to prepare as far as possible for all emergencies. Such a winter as that only recently passed through may not occur again during the lifetime of the present generation of gardeners, but, on the other hand, it may only be the first of a series of extra severe winters. In any case the course has been only too well cleared, and it will require no great amount of skill to arrange the crops for the ensuing year, the principal difficulty being how best to crop the ground so as to have plenty of vegetables during the summer and autumn, and above all things a well prepared stock for the winter and spring months. I am of opinion the majority of us frequently err in devoting too much space to summer vegetables, and also to winter crops of doubtful hardiness, and if I am wrong in my conclusions as far as the majority of gardens are concerned, it will yet be found that my remarks are applicable to many cases beside my own.

There is no mistake about the effect of the severe winter upon the breadths of Broccoli, these being destroyed wholesale, very few instances of survivals being heard of. As a rule I consider that far more Broccoli are grown in the gardens of the well-to-do classes than is desirable. Even if the same amount of space can be devoted to the crop I would advise that fewer plants be placed out, the additional space, coupled with a fairly solid root run, causing them to be sturdier and hardier accordingly. Borecole, notably the ordinary Scotch or Green Curled, Cottagers' and Asparagus Kale survived fairly well. Brussels Sprouts also came out of the ordeal better than might have been expected. Borecole and Brussels Sprouts being put out early on good ground, or between widely disposed rows of early Potatoes, can be depended upon to prove serviceable in the worst of winters, and if they receive more attention, from amateurs especially, and Broccoli less, no mistake will be made. They will also thrive and survive in the lower or colder parts of a kitchen garden, whereas Broccoli ought to be located on higher ground. Savoys have proved of somewhat doubtful hardiness, at the same time are so useful, that I would advise them to be planted as largely as ever.

Chou de Burghley, the seed being sown in May, and the plants placed out on fairly good ground, rarely fails to give satisfaction. Last winter we cut hundreds of tender hearts, the snow being cleared off them as they were wanted. When raised and put out much earlier it is far too coarse.

After Peas and Beans are available in quantity Cauliflowers are less valued, and it is not advisable to plant large breadths of plants raised under glass. Better by far plant a moderate number now, sowing more seed in June and July, the plants thus obtained being serviceable in late autumn and early winter. Mistakes may easily be made in planting too many early Cauliflowers. During very early hot weather, or say during July, far more Cauliflowers are wasted than are cooked and eaten. Autumn Giant, raised now and planted in succession to early Potatoes or other crops that come off the ground quickly, would form an admirable succession to the same variety put out at the present time or during the next three or four weeks. Veitch's Autumn Protecting Broccoli is extremely valuable, and it will be well to plant it extensively for use late in the autumn.

Never before, probably, have roots of various kinds been more fully appreciated than during the past winter, Jerusalem and Chinese Artichokes, Parsnips, Salsafy, Scorzonera, Celeriac, Carrots, Turnips, Beet, Onions, and Leeks all being nearly or quite used up. This points to the necessity of growing all these in greater quantities, it may be, than formerly. Anything that could be forced to produce tender, blanched, or green tops, notably Asparagus, Seakale, and Swedish Turnips, were even more highly valued, every scrap of the two former that could be thus turned to good account being utilised. With good ground available it is advisable, therefore, in many cases, to plant both Asparagus and Seakale more extensively than heretofore, specially for lifting and forcing, and vegetables must be very plentiful indeed in any winter when either of the two kinds just named are too abundant. Nor will any mistake be made in growing a few rows of Swedish Turnips, as the roots obtained, if not actually wanted for forcing purposes, might come in handy after the ordinary Turnips are exhausted, or even as a change to them. Nor ought the great value of Winter Spinach to be overlooked. What we should have done without it is hard to say. All the while the snow was off the ground, and there was no severe frost, large quantities of good

leaves were available, three, four, and even as many as six pecks a week being picked. The seed was sown about the middle of August. If Spinach fails this more often than not is due to an insufficient preparation of the soil.

Advantage should be taken of the clear state of the ground to prepare Celery trenches early, so that good time is allowed for the manure and soil to become fit for the reception of the roots—a very important point, seeing that the plants may spoil by being kept a few days too long where pricked out, owing to there being no opportunity to prepare the trenches just at that time. Then, again, the spaces between the trenches are admirable positions for Lettuces and Kidney Beans, these crops often thriving surprisingly well on these in quite the hottest and driest seasons. It is only by preparing the trenches early on heavy ground, at any rate, that the spaces between them can be effectively cropped, newly dug ground being quite unworkable for a time, or till it has been baked by sunshine, and then moistened by rains.—W. IGGULDEN.

SETTING MELONS.

OF late much interesting reading has appeared in the *Journal of Horticulture* on the several modes of setting Peaches, and as there usually is, to a very great extent, the same uncertainty attending the proper fertilisation of Melon flowers, some of the able critics on the Peach and Nectarine might give the general readers information to enable them to avoid the frequent partial failures among small Melon growers. Large growers, no matter in what sphere their energies are directed, need no advice; but the younger and inexperienced men do that fill places where most things are required of them, while the conveniences provided are very meagre and complicated. In the large establishments these crops of necessity have houses expressly set apart for their growth, where their attendance is, in a sense, more simple; but plenty of cases can be cited where the one house (perhaps a small one) has to do duty as a stove for various kinds of plants, the roof being shared proportionately both by the usual climbing or trailing plants found in such structures, as well as Cucumbers, Melons, and Tomatoes. No one can assert that a man working under these latter conditions has the same chances as another who can devote a house strictly to the one crop. It is a matter of decided uncertainty, and the single-handed man usually considers himself lucky to secure a good and perfect set of Melons at any time. In Peaches all cultivators agree that a uniformly moist border should be maintained at all times, though they individually differ in the treatment of the flowers at the setting period, but with Melons some growers succeed in setting them well by stinting the water supply at the roots while they are flowering, while another would ignore such a practice altogether. I have never yet heard of or seen a satisfactory explanation why such uncertainties should be common to Melons in their setting, but it does frequently occur that although a dozen blooms on a plant may be fertilised at about one time, if a single fruit should take the lead and be allowed to remain the others will fail to make any progress, and eventually have to be cut off. Except in extreme cases these precocious fruits are cut away and a later set awaited; but light crops are often chosen in preference to waiting for successional blooms.

There is no doubt but that soil has a very great influence in the culture of Melons, and a great diversity of opinion exists as to the greater suitability of light soil over heavy and *vice versa* in character; but in this as in the structures in which they are grown, the actual grower often has but little or no control, for in many establishments the soil has to be purchased, and it is not always convenient to get that suited to any one particular crop when small quantities only are procured.

There are but few gardens where the Melon adapts itself to the same perpetual or rather successional style of fruiting as is known in Cucumbers; nor, so far as concerns the ordinary cultivator, is it desirable, because it requires extended root as well as roof space to command such a condition of things. Small growers would, as a rule, be satisfied with one full crop from a batch of plants, these to be rooted out directly the fruits are cut, successional crops being forwarded in other places. I may be wrong, but I am an advocate for lime given in small quantities often, especially preceding the flowering period, believing it predisposes the plants to a fuller measure of fertility; but in this, as on the question generally, the experience of some of the many contributors to the *Journal* would be invaluable. Liquid or any manures applied at the time of setting is treacherous, as I have more than once had ample demonstration; but I have, like many others, never been able to grasp the reason why half-dozen blooms on a plant, apparently of uniform strength when each has the same individual attention in the matter of pollen application, should result in one or perhaps two fruits

swelling rapidly, the others remaining stationary, although the plant in vigour should be capable of perfecting the whole number.—W. S.

CULTURE OF GARDENIAS.

THESE handsome stove plants are met with in every establishment where room can be found for their accommodation. The flowers are so beautiful and the fragrance so delicious that they are always in great demand for floral decorations. Gardenias are not fastidious as to soil, the chief elements in their successful cultivation being heat, moisture, and freedom from insect pests, which soon spoil the beauty of the plants and mar the purity of the blooms.

PROPAGATION.

Have the pots required for the stock to be propagated duly prepared. Carefully drain them, fill with a compost of peat and leaf mould, and finish with a good surfacing of silver sand. Select good stout cuttings of the young wood, preferably those with a heel, and insert them either singly in small pots or as many as can be conveniently inserted in the pots at command. Water through a fine rose, and place the cuttings in a propagating box with a steady bottom heat, when roots will soon be emitted.

AFTER CULTIVATION.

They should next be placed singly into 4-inch pots, using a compost of three parts peat, with broken charcoal and silver sand, and keep them in a brisk heat. Water carefully until the roots take to the new soil, when the syringe may be used on every favourable occasion. When about 6 or 8 inches high pinch out the points to make them break back. As the plants become fairly established it must be determined whether they are to be planted out or grown in pots. Unquestionably where room can be found the planting out system yields the best results. The leaves not only become larger, but the flowers are produced in greater abundance, and are finer in quality.

If they are to be planted out drain the bed sufficiently with broken brickbats. Mix a compost of equal parts of peat and good fibrous loam, incorporating some charcoal and rough silver sand. Place out the plants at proportionate distances, apply water sparingly for a time, but syringe the foliage twice a day when growth is well started, and pinch again. The syringe is of the greatest importance in checking the ravages of insects. A temperature of from 65° to 85° will suit them admirably whilst growing. As the shoots progress and show signs of flowering use liquid manure at every alternate watering, or it may be given before this stage provided it be used sparingly, when vigorous shoots and healthy flower buds will be the result. During the autumn months less water will be required at the roots, but they should never be allowed for a moment to become too dry. When flowering is over the plants should be cut well back, cutting out all weakly growths entirely and shortening the more vigorous. Carefully examine the plants, and give a washing with some insecticide. This being completed, remove all the loose soil from the surface of the border, and substitute the compost before named. Keep the plants well syringed, and they will soon break into growth. The same routine as before may be gone through, but with plants at this age no pinching will be required, as shoots in abundance may be selected. If pinching is resorted to it will serve to retard the plants to some extent.

If they are to be grown in pots the advantages are, first, that if the plants are infested with insects they are easily removed to some other part, to be carefully washed or dipped; and secondly, that where numbers are grown they may, when growth is completed and flower buds set, be removed to a slightly lower temperature, and brought into heat as occasion requires. Shift the plants from 4-inch to 8-inch pots, and pinch as for those in the border, using the same compost. When growing freely keep the syringe clean, and follow the treatment before mentioned. Flowering being over they may be cut back, and when growth has commenced turn them out of their pots and shake away a portion of the soil from the roots, and pot into sizes according to the health of the plants. A stock of young plants should always be in readiness to take the place of any no longer required. Useful plants may be grown in a season, but the second season generally gives the best results if they are only kept clean.

INSECTS.

Mealy bug and scale are the most destructive enemies of the Gardenia. These may be eradicated by the use of one of the many insecticides advertised. If thrips or green fly attack them they should be fumigated, but if well syringed the two latter will not prove so troublesome.

Gardenia intermedia is one of the most useful of this class of

plants. It flowers freely, and is a good grower. There is also a variegated form of this type. *G. florida* has medium sized flowers, which are sweetly scented. *G. citriodora* is very useful, and should be in every collection. It does not require so much root room, and has smaller flowers than others of the family. The flowers are very sweet. Others well worth growing are *G. Fortunei*, *G. radicans*, with the larger type, and *G. Stanleyana*, the latter differing from all the rest of the Gardenias both in habit of growth and flowers. One or two others might be cited, but these are the more generally known.—R. P. R.

BARR'S DAFFODILS.

DAFFODILS from Barr's are to be found in gardens all over the kingdom and far beyond its shores, but Barr's own Daffodils are only to be seen in all their bewildering variety and diverse beauty at Long Ditton in Surrey. Thither do specialists and lovers of this great family of spring flowers wend their way in the season, not only to admire the floral feast, but to gain information, and study the characters of the different varieties under the guidance of the master. Mr. Barr is a Master of Daffodils in a double sense, first as the possessor of the finest collection in the world, and secondly by the great knowledge he has acquired through research, travel, and a long and critical observation of the several varieties under cultivation in his trial grounds. For some years these were at Tooting, but the Daffodil fields are now about ten minutes walk from Surbiton Station on the London and South-Western Railway, reached in about twenty minutes by express from Waterloo. There are three narrow fields extending a considerable distance along the south side of the line. Their measurement is fifteen acres, and at the least half the ground is closely planted with 500 species and varieties of the flowers, with several of which Mr. Barr's name will be associated for generations to come.

They are grown in beds $3\frac{1}{2}$ feet wide with narrow paths between them, and if any Daffodil student is as enthusiastic as the master he will have to traverse every one of these paths, stoop down and examine the "points" of the flowers, after their identity is determined by reference to the manuscript book, for all of them are numbered; then when all this is done he will most likely depart with tired limbs and Daffodil on the brain. He will be simply dazed with Daffodils, and when he sits down at night to write something about them will hardly know where to begin. A very eminent man once went to take particulars about the flowers, and tell the world about them, but the task was too great, so he wrote an interesting essay on Mr. Barr and his work, and crowned him the Daffodil King, leaving his subjects to be dealt with on a "future occasion." A wise resolve, for it is not conceivable that any person could satisfy himself in writing a description of this wonderful collection, and the "man behind the pen" at the present moment most assuredly will not do so. He has made up his mind, however, where to begin—namely, where the inspection finished, and as that was conducted on the good old lines of leaving the best till the last, it comes to pass that one or two of the finest Daffodils in the world have appropriately premier mention.

On a mat-shaded bed, for the day was the hottest of the season up to date, a few cherished gems were flowering. They were being subjected to very close scrutiny by three or four "experts," while one or two raw students looked on and listened, for it was an open conclave. The experts were the Master, Rev. C. Wolley Dod, Mr. Cammell and Mr. Dewar. Students, well, not worth naming in connection with Daffodils, though both of them think, as students will, that they know a little about them. "Now then," said Mr. Barr invitingly, "What do you think of that?" pointing to a massive golden bloom, and continuing, "We call it the best—the best florist's flower of all yellow Trumpet Daffodils. We raised it from seed, and its name is Monarch." A solemn pause, eventually broken by Mr. Cammell, "Yes, a grand flower, look at its substance and form?" "Ye'es," re-echoed the keen-eyed, cautious Mr. Wolley Dod, "but isn't it a good deal like Emperor? I should like to see Emperor with it." "It's from Emperor," explained the raiser, "but look at the flat, firm, imbricated segments and,"—but before he could finish his sentence Mr. Dewar drew from behind him the best Emperor he could find (for, like a canny Scot, he was already provided) and placed it with the Monarch; then all could see that fine as both were, Monarch beat the Emperor. It may be said to be a perfected Emperor, the trumpet without a fault, and the stout overlapping perianth segments without a twist or curl. Barr's Monarch then heads the lists of Golden Trumpet Daffodils.

"But what's this?" asked No. 1 of the experts, in surprise, "that is something very extraordinary!" "Wonderful!" observed No. 2. "Never saw anything like it!" remarked No. 3. "No," the Master dryly chimed in, "because there is nothing like it, and that is all there is of it; it is Weardale Perfection." Madame de

Graaff was small by the side of it, but the two are similar in character. The trumpet was 2 inches long, symmetrical, and recurving with the utmost regularity at the mouth, which was equal in width to the length of the tube; colour pale primrose, and the broad segments nearly white. The flowers are not to be cut for showing, but left for seeding. Weardale Perfection was alone worth going to see, and take it all in all, it is the finest Daffodil of its kind and colour that has ever been raised.

Other handsome varieties admired in the Ajax section were Glory of Leyden, with its huge smooth golden blooms; Captain Nelson, with its long clear yellow trumpet and bold spreading segments; Emperor also stood out boldly; but Santa Maria, one of Mr. Barr's Spanish finds, is the richest in colour of all, not excepting the noble maximus; P. R. Barr, a "small Emperor," is very free and good. Several of the early varieties were over and others fading. In the white-winged bicolor section, Dorrien Smith, John Parkinson, James Walker, Harrison Weir, Michael Foster, and Grandis were all fine, while Murrell Dobell and Alfred Parsons, similar in colour, were conspicuous by their neatness.

Small, in comparison with those mentioned, yet smooth, distinct, beautiful, and not sufficiently grown are the Johnstoni varieties, Queen of Spain, Mrs. George Cammell, and Pelayo. The first is the most effective in a mass, but the flowers of the second are individually more refined, and in the third the sepals are a little twisted, in the others flat. The clear soft yellow and clean finish of these varieties render them particularly appropriate for vase decoration. In commencing a trial with one only we should choose the first.

J. B. M. Camm leads the way in the white and sulphur coloured trumpet varieties (after Madame de Graaff previously mentioned), with its well-shaped, good-sized delicate flowers. Dr. Hogg, C. W. Cowen, Mr. and Mrs. Burbidge, Mrs. Camm, Mrs. Vincent, Lady Grosvenor, Snowflake, and the pretty little Minnie Warren attracted attention in passing down the beds by their soft chaste beauty, but there are several more of these "white Daffodils" well worth growing.

Judging by the enormous number grown, it is evident that there is a great demand for the lighter and more elegant forms of Daffodils of the *Incomparabilis*, *Leedsii*, *Barri*, and other types. Mr. Wolley Dod and Mr. Cammell are great admirers of these, and know them well. When flowering in clumps or masses they have a pleasing effect, and when cut are admirably suited for vase decoration. It is difficult to choose from such a great assemblage of good sorts. Among many others, however, possessing strong claims to attention in the *Incomparabilis* were noticed *Autocrat*, *Frank Miles*, *Gloria Mundi*, *Gwyther*, *Beauty*, *C. J. Backhouse*, *King of the Netherlands*, *Albert Victor*, *Lorenzo*, *Titan*, *Princess Marie*, *Mabel Cowen*, *Fair Helen*, and *Splendens*; and as a giant among them is the bold *Sir Watkin*, a striking flower, popular with the million but "wanting in refinement," say connoisseurs, in comparison with others in the section. The cups of the flowers vary from pale yellow to deep orange, and the segments from white to buff and yellow, and the general effect is bright and cheerful without any suspicion of gaudiness.

The *Leedsii* varieties are paler, some approaching pure white, and as a group may be fairly described as chaste and charming. Mr. Cammell described the *Duchess of Westminster*, *Gem*, and *Minnie Hume* as a very delightful trio; also very attractive were *Beatrice*, *Duchess of Brabant*, *Elegans*, *Catherine Spurrell*, *Mrs. Langtry*, *Palmerston*, *Maria M. de Graaff*, *Grand Duchess*, and *Princess of Wales*—all of them, and many others, being worth growing in gardens.

With the short chalice shaped cups, varying from orange scarlet to pale yellow in colour, and yellow or white perianth segments, the *Barri* varieties are distinctly attractive. Conspicuous will long remain a favourite, and so probably will such as *Maurice Vilmorin*, *John Stevenson*, *Orphée*, *Crown Prince*, and *Dorothy Wemyss*, for all press their claims to attention. Passing the distinct *Nelsoni*, *Backhousei*, *Macleai*, *Bernardi*, *tridymus*, and *triandrus* varieties, not because they are inferior, but because mention cannot be made of even the cream of the sorts occupying 7 or 8 acres of ground in a page of the Journal, we come to the "Burbidge's," which link some of the others with the *Poets' Narcissus*, and find distinct and good varieties in *Bacchus*, like a yellow "Poet's," *Agnes Barr*, *Ellen Barr*, *Model*, *Ossian*, *James Bain*, *Little Dirk*, and *Crown Princess*, jotted down in the pocket book as possessing attractive characteristics in either form or colour, or both; and then there are "Poets" by the score, a whole army of them, early and late in all their pearly beauty.

The entire collection at Long Ditton represents a great national or international museum of Daffodils that could only have been provided by years of perseverance, great expenditure, and unceasing work, prompted by a deep love for the flowers that conquered all difficulties, in acquiring so many, selecting them so well, "weeding"

them so carefully, and arranging them so systematically; and surely all who admire them must hope Mr. Barr will spend many happy years amongst them, and enjoy the reward to which he is justly entitled. There are collections of most other hardy plants in the Ditton fields, but as night has passed to morning not a word can be said about them. The pen is tired, the hand shaky, the eyes heavy, the mind weary, and fleecy masses of yellow and white that float across the vision will soon shape themselves into the form of a dream about Daffodils.—ONE OF THE STUDENTS.

FRUIT CULTURE UNDER GLASS.

SUCCESS in the production of high-class fruits is due, in a great measure, to the skilful management of the houses and borders while the plants or trees are swelling their crops. A good set of the various fruits may be obtained, the foliage may be healthy and free from insects, and the prospect of securing the desired results may appear to be within the grasp of the anxious cultivator, when alas! some unlooked-for difficulty or error of judgment may cause the long-cherished hopes to result in only partial success. I have sometimes noticed that Grapes, Peaches, and Melons in most establishments look particularly promising in the early stages just as the fruit begins swelling, but it is not usual to find them quite so satisfactory when fully matured. I propose, therefore, to give a few hints on management during the time the fruits are swelling, with a view to assist, as far as I can, those readers of the Journal who desire information on the subject.

GRAPES.

The sooner these are thinned after it can be determined with certainty which berries are swelling the best and most evenly, the better chance there is of securing Grapes of large size, because if this operation is deferred till the berries are as large as peas the bunches seldom develop into such fine examples of good culture as it is possible to produce. As soon as thinning is completed examine the border by thrusting a pointed stick into it at several places, and if the soil is found to be dry a thorough watering with liquid manure should be given, as at this stage of growth I consider that Vines may with advantage be kept a little moister at the roots than at any other time, because a good deal of growth is going on, the roots are in a very active state, and the berries swell with such rapidity as to cause a heavy strain upon the Vine. Still, a good deal of discretion must be exercised at all times in the matter of watering, after finding out the condition of the border in regard to the drainage and the porosity of the soil. Where Vine borders have been covered with plants during the winter and in the early stages of the Vine's growth, and are removed when they come into flower, it may often be noticed that the borders will dry more than they did during the previous month or two. At each watering while the berries are swelling, liquid manure should be given, or one of the many good kinds of artificial manures applied as a dressing to the border, to be well watered in, as there can be no question that to obtain good crops of fruit liberal feeding must be practised.

Another point which greatly assists in swelling the berries to their fullest size is to close the houses early on bright days and thoroughly saturate the atmosphere with moisture. In my opinion sufficient attention is not given to this matter. Houses should be ventilated as soon as the temperature begins rising on bright mornings, and the amount of air be gradually increased as the day advances, and the floors and stages damped two or three times to create a genial atmosphere. When midday is reached, especially in the spring time, keep a sharp look out upon the weather, so as to reduce the ventilation as the sun loses power, or when there are signs of the advent of several hours' dullness close the ventilators at once, to preserve the sun heat. Syringe the house freely, as there is no danger of the foliage being scorched so long as there is plenty of moisture in the atmosphere, and should the sun burst through the clouds later in the afternoon another damping of the floors will make matters safe. Where the stages and walks of vineries are of stone or slate these substances absorb so much moisture that heavy syringings are not sufficient. When houses are closed early in the afternoon of bright days a few cans of water should be poured upon the floors. I have a great belief in the efficacy of closing with plenty of atmospheric moisture, in order to swell fruits up to a large size. During the time Grapes are stoning early closing must be discontinued, as some varieties are apt to scald when so treated.

MELONS.

These perhaps illustrate in a more striking way than any other fruit the beneficial effect of closing early, with plenty of moisture, in order to produce large fruits. Some of the finest Melons I have yet seen were in houses which were closed at one or two o'clock

during the hottest days in summer, the plants of course receiving a heavy syringing; this operation was repeated an hour after. The plan was first tried in order to get some promising fruits ripe in time for a show. It succeeded so well that it was frequently practised afterwards when extra large fruits were wanted. But on ordinary occasions from three o'clock to half an hour later is soon enough to close Melon houses at midsummer, otherwise a great amount of extra labour is entailed in keeping the atmosphere thoroughly moist while the sun has great power.

PEACHES.

When these have completed their first stoning they may with advantage be subjected to a higher temperature after the house is closed than many imagine; so long as plenty of water is syringed upon the trees the thermometer may be safely allowed to run up to 90° or 95°, and I consider much may be gained in the size of the fruits by paying special attention to this point, while they are making their last swelling up to the time when colouring is well advanced.—H. DUNKIN.

DAFFODIL CRESSIDA.

THIS fine Golden Trumpet Daffodil, recently shown by the Rev. W. Wilks at the Drill Hall, is not only distinguished by its golden



FIG. 70.—DAFFODIL CRESSIDA.

colour, but also by its massive form. The flowers have a peculiarly bold and impressive appearance, the corona being of great size and much undulated at the margin. This variety was, as a seedling from *Troilus*, some seven or eight years ago in Mr. Wilks' garden at Shirley, near Croydon, and has been shown several times, its true character being preserved on each occasion. The engraving has been prepared from an admirable drawing by Mr. John Weathers, the Assistant Secretary of the Royal Horticultural Society.



NEW ORCHIDS.

AT the R.H.S.'s meeting on Tuesday last the Orchid Committee adjudged awards of merit to five distinct varieties, which are here briefly described.

Odontoglossum crispum Wrigleyanum came from Mr. G. Beddocks, gardener to E. G. Wrigley, Esq., Howick House, Preston, and is a remarkable addition to the variations of this type. The flowers are of good size and shape, but their peculiarity consists in the colouring, the numerous light brown blotches being also tinted and edged with pale purple on a white ground, producing a singular effect. It is very rare this purple tinting is seen in *O. crispum*, though we occasionally find it in *O. Pescatorei*, deepening to a very rich shade in the variety *Veitchi*.

Phalaenopsis speciosa var. *Imperatrix* was shown by Mr. W. H. Young, gardener to F. Wigan, Esq., Clare Lawn, East Sheen, and is unquestionably the richest coloured variety yet obtained. The flowers are comparatively large, with polished rich rosy purple or violet sepals, petals and lip all uniformly coloured. The plant was a strong one, and had a raceme of eight flowers. With it was a plant of another variety with white petals, but the character did not seem to be constant.

Cattleya Schroederæ var. *Leyswoodiensis* bears the name of Leyswood Groombridge, the residence of W. Temple, Esq., by whose gardener (Mr. Bristow) it was exhibited. The flower is of great size, the lip very broad and rounded, softly blush tinted, with a gold throat, and evenly frilled at the margin; the sepals and petals are also broad, and of similar colour to the lip. *C. Schroederæ* is one of the most beautiful *Cattleyas* we have, and good varieties are becoming more numerous. Another from the same exhibitor, simply named Temple's variety, has smaller flowers and a narrower lip, but the latter is of a fine golden bronze hue, margined with mauve. The name *Leyswoodi* was applied to the first mentioned, but this is so obviously incorrect that the one here given has been substituted.

Cattleya Mossiæ var. *gigantea*, from M. S. Cooke, Esq., Kingston Hill, is remarkable for the great size of the flowers, the lip being $3\frac{1}{2}$ inches across, open, frilled with crimson and gold mottling. The sepals and petals also are highly coloured.

Odontoglossum Halli leucoglossum, from G. le Dux, Esq., is not a new variety, but it had never been certificated before, and was well worthy of recognition. The flowers are beautifully marked with brown blotches, the white lip standing out conspicuously against them, and this character gives the varietal name. It is a handsome *Odontoglossum*, especially when a long raceme is seen, as in this case.—LEWIS CASTLE.

DENDROBIUM THYRSIFLORUM.

I CAN fully endorse the opinion of "W. S." respecting the attractiveness of the above *Dendrobium*. Just over twelve months ago, when I came here, I saw this plant in flower for the first time, and I was much struck with its beauty, for it was in a 32-sized pot, and had three long racemes with from fifty to sixty blooms each. Subsequently, however, when a large plant in a pot 14 inches in diameter, only produced one spike I was disappointed, as it had made several fine growths. After the spike had faded it again commenced growing, and developed several good growths about 2 feet long. As we were not prepared for such a severe winter as the one through which we have just passed, the temperature of the house (the warmest we have) fell so low that it killed all the *Oncidium Phalaenopsis*, both old and young plants. The average temperature did not exceed 38° or 40° during the long continued frosts, and often when I went to attend to the fires at 11.30 p.m. (the thermometer outside registering 25° and 26° of frost) I could not enter the house to see how low the temperature was, the door being frozen to the post. When at last the frost disappeared, and we were able to provide a higher temperature, this plant commenced producing racemes from the old growths and from the new, and at the present time it has twenty-one fully developed racemes, each with forty to fifty flowers. One raceme I accidentally

knocked off in tying it out, and one is not yet opened, which would have been twenty-three spikes, or over 1000 individual blossoms, making the grandest display I have ever seen of a single Orchid. I am told it has never flowered so well before, and we think is due to the low temperature, giving the plant a complete rest. Anyone failing to flower this Orchid satisfactorily should try and give it a complete rest, which we shall endeavour to do in the future by placing it in the coldest part of the house as soon as it has matured its growths. Smaller plants in 32's, 48's, and long 60's are flowering equally well.

Dendrobium Wardianum in the same house has also been flowering, and *D. chrysotoxum* is promising. I am also anxiously watching *Oncidium macranthum*, which at present has a raceme over 6 feet in length, and I am told it is not likely to flower for another three months. About thirty plants of *Odontoglossum citrosimum roseum* in 24's, 32's, and 48's in a cooler part of the house are also promising; this is a very sweet-scented flower, and should be in every collection, but it is very liable to be injured by damp, and if there is a slug in the house it is almost sure to find its way to the young spikes, consequently the only safe place is in baskets suspended from the roof. This is, I believe, the only *Odontoglossum* that throws its spike out of the new growth when the latter is about a month old. It is very interesting day by day to watch the developing spikes. Medium sized plants of *Lælia purpurata* are also showing well.—R. TURNER, *Addlestone, Surrey*.

ODONTOGLOSSUM EXCELLENS.

I SEND you the top part of raceme of *Odontoglossum excellens* to compare with other forms. Mr. Lewis Castle is keeping the *Odontoglossums* well to the front in the Journal just now, and I appreciate his notes very much. I have been rather long in sending, the blooms are just shrinking a little, and the colour is not so bright as a fortnight ago. *O. excellens* stands for two months if the bees do not get at it. I am quite at one with Mr. Castle as regards temperature. My minimum temperature during winter is 45°, the thermometer being hung on the wall and coldest place in the house. I hang another in the centre of the house, which is never below 50° nor above 55° with fire heat. I use now nothing but half pots, depth and diameter being about equal, and save thereby a considerable weight in crocks for drainage. I am not afraid to give large pots when I have good healthy roots to deal with, but then I water them myself, and that makes all the difference. I would never advise anyone to use large pots unless he attended to the watering himself.—GEO. RUSSELL.

[The variety is very good, the colour bright and the flowers of good form. The top portion of a raceme was sent bearing nine fine flowers, and Mr. Russell says "it was taken from a plant with a single lead, which always produces two racemes more or less branched, and about 3 feet long," a highly satisfactory result of good culture.]

INSECTS OF THE FLOWER GARDEN.

(Continued from page 202.)

A FRIEND who has been surveying his evergreens with some anxiety, and reckoning up his losses due to the last winter, has just called my attention to the Box, which seems, as usual, to be much infested by an insect, commonly supposed to be an *Aphis*, but which is really a *Psylla*, though near akin to our more deadly foe. It twists the terminal leaves into a cone-like form, kills many of the buds, and must weaken the plant. I believe it is generally the case that too little heed is taken of this and other insects that are mischievous to our evergreens, and I should suggest it can be dealt with effectively by syringing the shrubs with a solution of petroleum and soap of suitable strength; it may also be killed, like others of the *Psyllidæ*, by a wash of tobacco water, or the decoction of quassia chips. These insects have the power of leaping when they are adult, which is not possessed by the true plant lice or aphides; the thorax is broad for their size, the rostrum or sucker short, and the female possesses a small ovipositor. But these insects, also incorrectly called the *Chermes*, have not the rapid succession of broods notable amongst the aphides, though there may be more than one in each season; the first is probably started by females that have hibernated, the tiny eggs being artfully hidden. The *Psyllidæ* may be destroyed by the same methods found applicable to their relatives, but their agility gives them some advantage. Several of the species commit much damage amongst fruit trees, and others of them give forth a cottony secretion resembling that of the allied species of woolly aphis, known popularly as American blight.

We may take as a good example of this tribe *P. pini*, which attacks Pines or other Conifers, both in houses and out of doors. Winter is the time to arrest the increase of this species, when the

"queens," or mothers of the next season may be detected clinging to the buds by long hairs or bristles proceeding from the head. In colour they are dark brown, ringed, and spotted with grey. Rousing about April from their sleep, they feed upon the sap and increase their size, then in June they deposit eggs, each of which is mounted on a footstalk, also wrapped well round by cottony down. The young Psyllæ, or Chermes, are likely to make good progress before the mischief they are doing is apparent to the eye.

The species which infests the Rose has received the name of the rosehopper. This is named in science *Typhlocyba Rosæ*, and it has occasionally been abundant, but generally gives much less trouble than do the aphides to the grower of Roses, and I think it is held in check by some natural enemies. Then upon the Camellia another Psylla holds its revels. This is *P. Cratægi*, by no means, however, confined to the Camellia, nor to the group from which it takes its Latin specific name, but visits Fuchsias and other choice flowers. It is small, of a delicate green, and active in habit.

If we pluck a Sycamore leaf just about the time the foliage is matured we may possibly find upon the under side a number of tiny specks, mostly in some angle formed by two veins. At first we may doubt if the objects have life, but should we breathe upon these brown points they will be seen to move. It is, in fact, a small insect between the Psyllidæ and the Cocci or scale tribe called *Phyllophorus testudinatus*. Only by the microscope can we discover that it is a tortoise-shaped creature remarkable for having upon its head a sort of crown composed of minute appendages, resembling green leaves, and similar adornments are visible along the sides of the body. We may frequently see upon the flowers gathered for bouquets and buttonholes specimens of another insect akin to the scale tribe. One species of the sort is plentiful enough to be injurious to Cabbages—viz., *Aleyrodes proletella*. Small white powdery creatures these, four-eyed, and having wings with but one nervure. They are like moths of minute size; some call them snowflies. A summer breeze will waft parties of them over our flower beds, but I do not think they do any particular harm to bud or blossom.

The mealy bugs, scale insects, or cocci are, as all gardeners know, chiefly troublesome in houses, but some of them occur out of doors and upon plants, beds, or borders. Their history is imperfectly known, but had they been more mischievous to fruit or vegetables than they at present appear to be, probably a more careful study of them would have been made. True we have a serious enemy to the Vine in the mealy bug, and species of scale also infest the Apple and Pear, though not to a serious extent. Undoubtedly many of the scale insects found in our conservatories and stoves are visitors from other lands, having travelled with plants. Some of these die out, to be succeeded by others. One reason for this may be that females arrive here, and in our climate produce only female offspring, so in a few generations they become locally extinct. Much mystery attaches to the male individuals of some species; they must exist, but no one sees them, or knows anything about them. Whole generations, as with aphides, do consist certainly of females, but of the cocci there is not, in the usual way, more than one brood each year. Should you particularly wish to see a male coccus, I can direct you to some, reader. You may find on the Maple or Sycamore in June flat white cocoons on twig or branch, which opened carefully reveal a coccus, adorned, as the males mostly are, with long slender tails, like those of the May fly. These males are also distinguished by a pair of overlapping feeble wings, and a mouth destitute of a rostrum or sucker. Some of the males are bright green, others of purple and white; most of the females are either dull green or brown, befitting the places where they generally pass their lives. Professor Westwood has justly remarked that, strange though it may seem, the female cocci approach in habit the barnacles of the crustaceous division of animals, and as they near the completion of their life, instead of advancing, they become less perfect. The limbs disappear, even the articulations of the body; they are simply masses of animal matter, both motionless and senseless. Quite a contrast this to the activity which marks their proceedings while young, and so small are many of them at first that thousands of them might be covered by a florin, but as they grow they spread themselves over leaves or branches, continuing to feed through the summer and autumn. No doubt the shelter afforded by the dead body of the parent in their earliest period is a protection from enemies, also from the effects of heat or too much moisture. It has been said in some species each mother produces 1200 eggs, or more; undoubtedly they are very prolific. It is during the winter that a change creeps over the scale insects, bringing the males into the pupal state, and the females into that strange condition which ends in the body being enlarged and flattened, assuming a shieldlike aspect, its interior developing, besides the eggs, a mass of down amid which they are hidden.

It is impossible to say how many of these scale insects are truly

native of Britain. Some of those we find in gardens are hardy, too much so for us; some kinds seem to thrive only where the temperature is high. Upon outdoor Roses a peculiar scale occurs, it is called, I think, *Diaspes Rosæ*, and produces films of white on the stems and branches which might be mistaken for a lichen. The Camellia has its scale. *Aspidiotus Camelliæ* and *A. Nerii* infest Oleanders and Acacias, while *A. Bromeliæ*, known best as the enemy to the Pine Apple, breeds also upon various garden plants—the Hibiscus, for instance. Though named in allusion to the Orange, *Lecanium hesperidum* attacks not the Orange alone, but various exotics in houses, preferring succulent species. Very familiar is the kind called the Turtle scale, *L. Testudo*, which looks really like a miniature shell upon the leaves to which it clings. It is easily removed by hand-picking when the females are adult, but it is better to destroy it earlier if possible. Some Ferns are much troubled with scale of more than one kind, I think; a wash of softsoap, 2 ozs. to a gallon of water, has been effective in killing these, applied at a heat of 100°, or even 120°. Other much used remedies for scale are washes of sulphur or petroleum, Gishurst compound kills it, and also nicotine soap.—ENTOMOLOGIST.



EVENTS OF THE WEEK.—The chief horticultural gathering prior to the Temple Show will be at Manchester on Friday next, May 15th, when the annual Show opens in the Old Trafford Botanic Garden. Upon the following Wednesday and Thursday, May 20th and 21st, a Show will also be held in the Westminster Aquarium. Meetings will be held by the Royal Society to-day (Thursday) at 4.30 P.M., by the Quekett Club on Friday at 8 P.M., and the Society of Arts on Wednesday at 8 P.M.

— THE WEATHER IN THE SOUTH.—Following the cold, dull, unseasonable weather of Saturday and Sunday last, we have had several hot, sunny days, quite summer-like in temperature. The early mornings have been misty and cool, but we have not observed frost in the metropolitan district. Gardens and orchards are now in charming condition, and the fruit blossom appears to be setting satisfactorily.

— MUCH interest is being awakened in the approaching TEMPLE SHOW OF THE ROYAL HORTICULTURAL SOCIETY, which will be opened on Thursday, May 23th, and it is thought that more tent space will be required than last year. The exhibits are expected to be of a varied character, but no doubt Orchids will predominate, as the time of year is just suitable if a period of hot weather does not unduly shorten the duration of the flowers. There will be a large gathering of horticulturists, and it is to be hoped fine weather will favour the Society.

— SPINACH VICTORIA.—For summer culture this is undoubtedly greatly superior to the old or round-seeded Spinach, and as a winter crop it is even more pre-eminently superior to either the round or prickly seeded forms. With us the latter are just giving signs of running to seed, but the Victoria is not, and the rows of it are conspicuously superior both as regards weight, quantity, and colour of the leaves that can be gathered from it. When the seed becomes cheaper it is certain to be very extensively sown; in fact, there will be no necessity or wisdom in growing any other variety for either the summer or winter crops. The seed ought to be sown more thinly than is usually done in the case of the ordinary forms, and the plants will then develop extra fine succulent leaves, and the plants be slow to run to seed.—I.

— A LARGE MUSHROOM.—The Mushroom I am sending is one of a crop from a series of beds that were made up and spawned last September and October, in our unheated house. We gathered but few from them at the usual time from six to eight weeks after spawning, as the severe weather set in. The beds were well covered and kept dry during the winter, and as soon as considered safe we gave sufficient water to moisten the soil, using a teaspoonful of nitrate of soda to two gallons of water. The result is we have had splendid Mushrooms for weeks past, and are still gathering, though the beds, as stated before, were spawned six or seven months ago.—THOMAS CROSSWELL, Home Wood Gardens, Eton Park. [The Mushroom received was 8 inches in diameter and very heavy.]

— PARIS GREEN AND CATERPILLARS.—The caterpillar has now been at work for some weeks, but the fact will only be patent to most people within the next few days, and then there will be an outcry for a remedy. So far as I know, Paris green stands alone. It is not an ideal remedy, because, firstly, it is a poison; secondly, it is insoluble in water; but we have to choose between the use of it or the loss of crops, and possibly of trees. Kindly, therefore, insert these comments on "Entomologist's" remarks in your last number. No doubt it is imperative that warning should be given as to the handling of the poison, but that having been done, I am in the position, from my large use of Paris green in the powder, to affirm that the danger is practically nil. Last year we used many pounds, and not having any proper mechanical sprayer the distribution was effected by the hand, and although some ten acres of bush trees were gone over ten times, no one suffered the smallest injury or inconvenience. Now, by means of a Stott's sprayer, wet hands are avoided. Then as to danger from eating fruit so treated. Of course bush fruit should not be sprayed; but when I tell you that 18 ozs. of Paris green suffice to spray ten acres of trees—that of course the bulk of the spray falls on the leaves, and a great part on the ground, and that the fruit is exposed for months to all the washing of rain—it must be admitted that the risk is not worth mentioning. American fruit growers have been applying the remedy for many years, and we have never heard of any evil results. Surely we may conclude that, for all practical purposes, the danger is non-existent. Therefore, until some perfect remedy be found, my advice is—Spray with Paris green, and as soon as the blossom is off; lose no time.—D. LEE CAMPBELL, *Glewstone Court*.

— AMERICAN FRUIT AND VEGETABLES.—A Dalziel's telegram, dated Washington, May 10th, states: The Department of Agriculture has issued a bulletin regarding the effect upon crops of the frost which occurred on the 5th inst. "This frost," says the bulletin, "has caused wide-spread damage to Strawberries, Grapes, Cherries, Peaches, and early vegetables."

— PANSIES FROM SELF-SOWN SEED.—I send you a bunch of flowers just brought in from a friend's garden, and self-sown. What a size, and such a perfume! His garden is wild with them in the greatest profusion. The locality was due south, Sunday's Well side, and very sheltered.—H. B. W., *Cork*. [The flowers were large and the colours excellent.]

— GARDENING APPOINTMENT.—Mr. Herbert Coster, for the last six years foreman at Sprowston Hall, Norwich, has been appointed head gardener to A. H. Wood, Esq., who has taken a lease of Ickworth Park, Bury St. Edmunds, the seat of the Marquis of Bristol. Mr. Squibbs, who has had charge of the Ickworth Park Gardens for nearly forty years, has been transferred to Old Place, Sleaford, Lincolnshire, another seat of the Marquis of Bristol.

— AT the ordinary meeting of the ROYAL METEOROLOGICAL SOCIETY, to be held at 25, Great George Street, Westminster, on Wednesday, the 20th instant, at 7 P.M., the following papers will be read:—"On the Vertical Circulation of the Atmosphere in Relation to the Formation of Storms," by William H. Dines, B.A., F.R.Met.Soc.; "On Broeken Speetres in a London Fog," by A. W. Clayden, M.A., F.R.Met.Soc., F.G.S.; "An Account of the 'Leste,' or Hot Wind of Madeira," by H. Coupland Taylor, M.D., F.R.Met.Soc. Mr. Shelford Bidwell, M.A., F.R.S., will also exhibit an experiment showing the effect of an electrical discharge upon the condensation of steam.

— PARCELS POST FOR FLOWERS.—A deputation, consisting of Sir H. Selwin-Ibbetson, M.P., Mr. Round, M.P., Sir E. Birkbeck, M.P., Prebendary Jones, Rev. H. W. P. Stevens, and other gentlemen connected with agricultural and horticultural interests, yesterday waited upon the Postmaster-General at the House of Commons, to urge him by means of the Parcels Post to give increased facilities for the conveyance of flowers, eggs, and other produce of small allotments. Mr. Raikes, in reply, said that he understood that the deputation asked, not so much that the speed of delivery in connection with the Parcel Post should be accelerated, or that the maximum weight should be increased, but that the charges on small and perishable articles should be lessened. On that point he had already been in communication with the Treasury, and he thought there was a strong case indeed for the Post Office taking special charge of those perishable articles for which speedy conveyance was everything. He sympathised with the views which the deputation had expressed, and would again approach the Treasury to see if something could not be done to secure the realisation of their wishes. With regard to flowers &c., sent from the South of Ireland he

suggested that possibly a special express service might be arranged, so that the articles might be delivered in London earlier than at present.

— DAFFODIL, TRUMPET MAXIMUS.—I notice through the Press that this variety does not do well about London. Your readers, particularly from the scientific point of view, will be glad to know I have a large bed (1000 bulbs) that flowered the first week in March, the stock of which came from the Spanish side of the Pyrenees, and it is now carrying a full crop of seed pods, 2½ to 3 feet in height, the foliage is intense dark bluish green. The bloom here is long since over with most sorts. Ard Righ we shall be lifting in a fortnight, and the Horse Chestnuts are in full bloom.—W. BAYLOR HARTLAND, *Ard Cairn, Cork*.

— THE WEATHER IN APRIL.—This was a cold month, and also very dry. The wind was in an easterly direction twenty-one days. Total rainfall was 1.11 inch, which fell on fifteen days, the greatest daily fall being 0.46 on the 4th. The barometer was changeable. Highest reading 30.35 at 9 P.M. on 20th, lowest 29.55 at noon on the 5th. Highest shade temperature, 65° on the 30th; lowest, 22° on the 1st; lowest on grass, 19° on 1st and 26th. Mean temperature of the month, 42.56°. The garden spring ran 10 gallons per minute on the 30th. Horse Chestnuts only commenced to unfold their buds on the 30th, which was the first day of mild spring weather. Everything is very late in the gardens in this neighbourhood, but the prospects for a good fruit crop of all kinds are very general.—W. H. DIVERS, *Ketton Hall Gardens, Stamford*.

— THE WEATHER AT RIPLEY, YORKS, DURING APRIL, 1891.—April opened very wet and cold; snow fell in quantity on the 2nd, 7th, and 25th. From the 8th to 28th weather (with the exception of 25th) generally fine, but cold. Vegetation made very little progress during the month. Rain fell upon seventeen days; total fall for month 2.67 inches, of which 0.83 of an inch fell on the 4th. Six bright days occurred during the month. Wind northerly on twenty-one days. Mean reading of barometer, 30.09°. Mean maximum temperature, 50°; Mean minimum temperature, 34.6°. Mean temperature, 42.4°. Highest maximum temperature, 60° on 30th; lowest minimum temperature, 24° on 1st and 14th. At or below 32° on fifteen days. Apricots are set well; Pears just in full blossom, and beautiful they will be in another day or two. Plums also promise well, as do Apples, but the last-named will not unfold their blossoms for ten to fourteen days. Small fruits also give abundant promise, but we require warm rains, or I am afraid a great percentage will fall prematurely.—J. TUNNINGTON *Ripley Castle, Yorks*.

— BLACK CURRANT MITE.—I observed in your last issue a note by "W. T.," who has doubts about the efficacy of taking off the infected buds. I think if he will give it a fair trial he may think as I am now inclined to do, that it will answer very well, and would be often preferable to digging up and throwing the bushes away. The few bushes that we have which were subjected to the picking process for the last few years are now showing better for fruit than I have yet seen them. They have been picked over at intervals three or four times this spring. I enclose a small twig on which there are two bad buds that were missed, but you will see that it is thick set with flowers, and it is a fair average for the promise for fruitfulness. For small gardens I am now disposed to think it would be often better to pick the bad buds off than replace with young trees, which would take time before they reached a good bearing condition, and then there would be a little risk in that they might be again attacked. In many cases I would say try the picking process.—R. M., *Cheadle*.

— NEWCASTLE GARDENERS' IMPROVEMENT SOCIETY.—A meeting of gardeners and others interested in horticulture was held in Newcastle-on-Tyne, on the 29th April, to consider the advisability of establishing a Horticultural Mutual Improvement Society. There was a fair attendance. Mr. R. H. Irvine having been voted to the chair, addressed the meeting at some length, urging upon gardeners to combine and form some such society as it would be proposed to establish that night. Mr. J. Hood, junr., then proposed the following resolution:—"That this meeting is of opinion that a Horticultural Mutual Improvement Society would be beneficial to the district, and further that it decides to form one, and that a Committee be appointed to draft rules, solicit subscriptions, and report to another general meeting." In supporting the resolution he spoke of the entire absence of any society in the district which had for its object the mutual improvement and general welfare of gardeners, and spoke of the numerous advantages

which would be derived by gardeners and amateurs (the younger branches especially), by meeting occasionally and hearing a paper read on some gardening subject, and by taking part in the discussion. The resolution was unanimously carried, and a Committee consisting of Messrs. Moffitt, Heslop, Hood, senr., Irvine, Adamson, Gardener, Russell Bell, R. W. Hood, Harwood, and Elliott, appointed to draft rules. Mr. J. Hood, junr., is the Secretary *pro tem*.

— ASPARAGUS AND JERUSALEM KALE.—What useful vegetables these Kales were during the trying time we have passed, and fortunate indeed are those who planted the above Kales largely in addition to the usual winter and spring vegetables. Whilst Cabbages are scarce and Broccoli and Spinach nearly destroyed, we have scarcely lost a plant of either variety of Kale. We have been cutting for the past five weeks, and have still abundance to serve us for some time to come. Of the two the Jerusalem is the hardier and equal as regards flavour. It has purplish stems and leaves, whilst those of the Asparagus are pale green. Wash and tie up in small bundles and boil as Asparagus. When sufficiently boiled drain and season with pepper and butter and serve on hot buttered toast, and you have a dish not to be despised. The present is a good time to make a sowing, and a further sowing may be made in three weeks. Sow in drills 9 inches apart, and net securely from birds. As early crops are cleared away the sowing made now will come in readiness, whilst the latter sowing will give a succession. Anything that will make a change in the list of vegetables, and which will stand severe winters, such as the one we have lately passed through, ought to be borne in mind, and some portion of the vegetable ground set aside for a few rows to be planted.—P., *Liverpool*.

— WEATHER AT LIVERPOOL.—At last we have had some genial showers and a decided change in the warmth of the weather. The fields and hedgerows present a beautiful green appearance and signs of growth on every kind of tree. Fruit trees are expanding their blossoms. Many kinds of Pears have opened their blossoms and Cherries are rapidly expanding. Currants, both Red and Black, are showing in abundance. The latter suffered extensively with the ravages of the mite. Careful picking off the knotted buds has saved the trees, which are at present perfect pictures. I hope this short note may not have to be followed by one which will blight our brightest hopes.—R. P. R.

— FRUIT PROSPECTS.—The promise of heavy fruit crops is splendid, Pears, Apples, Plums, Currants, Raspberries, Gooseberries, and Strawberries all giving indications of heavy crops. Peaches and Nectarines blossomed well, and appear to be setting a full crop. Apricots are the best set we have yet had. Filberts, I think, will be a light crop. It is yet early to say that there will be a fulfilment of the promise of Apples, Pears, and Plums, as we have the caterpillar season to pass through, which may blight all hopes. Our fruit plantation is comparatively free this year from that pest, and the promise is splendid on all the trees. Most caterpillars to be found are on the Mother Apple and Beurré Hardy Pears. Every year these two are more severely attacked than any other, and the reason for it is a mystery. Some old standard Apples that I have examined are very badly infested with small caterpillars. At a distance they look all right, but on closely examining each bud, and opening the flower buds or foliage, a number of small wretches were discovered working destruction. I should state that these trees were not sprayed with Paris green; other trees in the same orchard were, and so far they are nearly free from insect enemies.—S. T. WRIGHT, *Herefordshire*.

— THE BRIGHTON AND SUSSEX NEW HORTICULTURAL AND MUTUAL IMPROVEMENT SOCIETY.—This Society may now be considered fairly established, and it will, doubtless, accomplish the objects in view. At a well attended meeting of members, held at the Odd-Fellows' Hall on Thursday evening, the 7th inst., the rules were discussed and passed. These, with some slight alterations, are those of the Liverpool Society, a copy of which was kindly sent by the Secretary for that purpose. It is intended to be worked on similar lines, that the members meet on the second Thursday of each month for mutual improvement, and to such meetings members are invited to take such object of interest as may be thought worthy. It is also intended to have shows, but for reasons well known to frequenters of Brighton shows, it has been deemed advisable to have no show this year. This has been a great disappointment to many, especially to those who live too far from Brighton to be able to attend many of the monthly meetings. The want of a show has been the means of keeping some from placing their names on the roll, but

several donations from the latter class of members was announced, and it is hoped more may follow when the useful objects the Society has at heart becomes more generally known. Suggestions were made with regard to shows to be held next year, which seemed to meet with general approval, and if carried out may prove a pleasant surprise to those who have hesitated at joining the Society. The Secretary is Mr. Mark Longhurst, 18, Church Road, Hove, who will be glad to receive names of new members.—R. I.

PEACHES AND NECTARINES.

SETTING FRUITS WITH THE SYRINGE.

ALTHOUGH I cannot congratulate my opponent upon the sound logic or consistency of his remarks concerning this subject, I will give him due credit for the smartness of his repartee, for which I entertain a far greater admiration than for any of the "practical facts" he has hitherto advanced on this subject. But before giving a short summary of the way in which my unstable friend has shifted his ground, I wish to tender my sincerest thanks for his generosity in modifying his assertions to suit so fastidious an individual as his opponent; but when I remember how well it suited his own purpose to do so I fancy I am the better able to estimate the apparently generous action at its true worth. I do not care to infer that "J. J. C." wilfully misconstrued the illustration I gave, that time-honoured customs are not always the best, but may be improved upon; I prefer to think that his natural acumen had for the time left him, and more serious consideration must show him that the shot was much nearer the mark than he would fain have us believe, for the simple reason that the requirements and constituents of the Vine are the same to-day as they were fifty years ago, just as much so as in the case of the structure of a Peach blossom. Although the structure of the latter has not changed, a vast improvement has taken place in the houses in which Peaches are grown, and I unhesitatingly affirm that with the majority of Peach houses gardeners have to deal with in these days, when abundance of light is secured, that, when practised under the conditions I have already laid down, the syringe is the most effectual of all implements for securing perfect fertilisation and at the same time retaining the trees in health and vigour, and I opine that in the future will be more generally practised than it is now.

Before concluding I will briefly review a few of the objections which "J. J. C." has urged against the practice of setting fruits with the syringe with a view to showing how he has shifted his ground as arguments were brought forward to refute his objections. In the first instance he condemned the practice because it was one that could not be practised indiscriminately, also because he thought converting the pollen into a pasty matter would not be the most suitable way of effecting fertilisation, and again that it would not answer in the case of large flowering varieties. My rejoinder to these objections showing how shadowy was the real foundation on which they rested, and asking if my vigorous critic had really practised the plan he condemned, brought out the information that he had practical proof of the method upon Vines and various plants, but could not say much in its favour, although mark! nothing was said of Peach trees, but Vines and various plants. As he took occasion in that article to bring in the name of Mr. Coleman, doubtless with a view to give indirect weight to his arguments, I embraced the opportunity of giving him that cultivator's written statement of his success with syringing Muscats, at the same time intimating a wish to know the conditions under which my opponent practised syringing fruit trees when in flower. The conditions have now come to hand, and I find not the slightest mention is made of either Peaches or Nectarines the subjects the particular fruits which are mainly concerned in this controversy, but instead a case of failure is cited with such varieties of Grapes as Gros Colman, Lady Downe's, Alicante, Golden Queen, and Alnwick Seedling. Now, with the exception of the latter, neither of these varieties requires assistance to secure a good set beyond tapping the rods and keeping up the requisite temperature; and in the case of that peculiar variety Alnwick Seedling a slight syringing would not avail to be effective, it must be done with force enough to free the capsule. Readers will now be able to judge for themselves of the want of force in "J. J. C.'s" final effusion.

Having now pointed out the intricate wanderings traversed by my vivacious opponent, and how he has shifted his ground from stage to stage, endeavouring at the same time to build up a grand avenue of arguments and facts, which few would assail, and none could hope to penetrate, but unfortunately for the triumph of his cause, his arguments were those which could be refuted by dry hard facts and practical results, while many of his facts had no surer foundation than that of a fervid imagination, leaving ample room for the metaphorical carriage and pair in the form of successful practice to pass in triumph through the shattered and the scattered objections of my courteous and extremely cautious friend.—H. DUNKIN, *The Gardens, Longford Castle, Salisbury*.

SCOTTISH PRIMULA AND AURICULA SOCIETY.

THIS Society held its fifth annual Exhibition, on May 8th, in the City Assembly Rooms, Dundee. As is well known this has been, in nearly all cases, a disastrous season for Auriculas, and it was a pleasant

surprise to all to see a splendid collection tabled, with good trusses and fine kinds. The Show in its exhibits compared favourably with any one yet held by the Society. The whole of one side of the hall was occupied by the competing plants, and a table was occupied by plants for exhibition only. The display of Alpine Auriculas was very good. The Primula entries were small, and most of the plants were inferior in quality. Fine collections of Auriculas for exhibition were tabled by Messrs. Ker, Douglasfield; G. B. Simpson, Broughty Ferry; Morris, Dundee; Kilgour, Blair-Drummond; Straton, Annfield, Broughty Ferry. Three fine trays, containing Narcissi, Hellebores, Ranunculi, several varieties of new double Primroses, and various other favourites, among which was a very lovely Primula rosea grandiflora, were shown by J. Cocker & Sons, Aberdeen. Mr. D. W. Croll, nurseryman, Dundee, had a fine stand of Narcissi and greenhouse plants. Messrs. Storrie and Storrie, nurserymen, Dundee, had a good stand of greenhouse flowering and foliage plants, hardy bedding Violets, and a grand stand of fancy Pansies, of new last year's introduction. The Heaths shown were also very fine. Mr. James Johnstone, Ashludie Gardens, had a very attractive table, containing a grand selection of cut Roses remarkable for size and beauty, also cut gold laced Polyanthus, double Pelargoniums, and Richardia. Messrs. Barr & Sons had a very fine collection of Narcissi, as also had Mr. Thomas Ware; and Mrs. Robertson, Invercarse, Dundee, had a nice stand of the leading varieties of the same flower. Miss Cox, Clement Park, exhibited a grand collection of greenhouse flowering and foliage plants, among which were fine specimens of Anthuriums and Calceolarias. Messrs. Laird & Sinclair, nurserymen, presented a fine collection of foliage and flowering plants, among which were finely flowered specimens of Liliun Harrisii, a large number of cut Narcissi and Doronicums. On looking over the Auricula table the following varieties were noticeable:—Acme, white, with ten pips, Mr. Andrew Laing, Pitcairnie, prize group; Mrs. Potts, twelve pips premier, self; and F. D. Horner, premier, green, eight pips, both shown by Mr. J. D. Ker, Douglasfield; Horner's Laura, self, eight pips, almost as good as Heroine shown by Mr. Kilgour, Blair Drummond, who also won the premier prize for grey edge George Lightbody.

The following is the prize list:—

Auriculas (stage), eight plants.—First, Mr. J. D. Ker, Douglasfield. Second, Mr. W. Kilgour, Blairdrummond. Third, Mr. A. Laing, Pitcairnie. Four plants (dissimilar).—First, Mr. J. D. Ker. Second, Mr. W. Kilgour. Third, Mr. A. Laing. Two plants (dissimilar).—First, Mr. J. D. Ker. Second, Mr. W. Galloway, Gagie Den. Third, Mr. John Menzies, Duns. One plant (green edge).—First, second, and fourth, Mr. J. D. Ker. Third, Mr. W. Galloway. Fifth, Mr. W. Kilgour. One plant (grey edge).—First, second, and third, Mr. W. Kilgour. Fourth, Mr. W. Straton, Broughty Ferry. Fifth, Mr. J. D. Ker. One plant (white edge).—First, Mr. A. Laing. Second and third, Mr. W. Straton. Fourth, Mr. J. D. Ker. Fifth, Mr. W. Kilgour. One plant (self).—First, second, and third, Mr. W. Kilgour. Fourth, Mr. J. D. Ker. Fifth, Mr. Andrew Laing. Premier (green edge).—First, Mr. J. D. Ker. Premier (grey edge).—Mr. W. Kilgour. Premier (white).—Mr. A. Laing. Premier (self).—Mr. J. D. Ker. Premier plant in the Show.—Mr. A. Laing.

Alpines (six dissimilar).—First and third, Mr. J. Menzies. Second, Mr. W. Kilgour. Four dissimilar.—First and third, Mr. J. Menzies. Second, Mr. W. Storrie, Lenzie. Two dissimilar.—First and third, Mr. J. Menzies. Third, Mr. W. Kilgour.

Polyanthus, six dissimilar Fancy.—Second and third, Mr. A. Scott, Forgan. No first.

Primula species, three distinct.—First, Mr. W. Storrie, Lenzie. Second, Mr. Oliver Straton, Broughty Ferry (Sieboldi). Third, Mr. O. Straton.

Special prize (four self Auriculas).—First, Mr. A. Laing. Second, Mr. J. Menzies.

Best seedling (green edge).—First, Mr. J. Menzies, Duns.

At one o'clock the opening function was performed by Lord Provost Mathewson. Mr. W. Straton presided, and amongst those present were the Rev. Spenser Ritchie, Mains; Mr. R. B. Laird, Mr. James Laird, Mr. James Cocker, Aberdeen; Mr. D. Storrie, Mr. John Morris, Mr. Andrew Scott, Forfar; Mr. J. D. Kerr, Mr. William Kilgour, Blair-Drummond; Mr. P. W. Fairgrieve, Dunkeld; Mr. D. P. Scott, Mr. J. B. Lawson, Mr. H. Tulloch, Mr. R. Mason, Arbroath; Mr. J. H. Mackay, Mr. J. B. Simpson, Mr. W. Ritchie, Mr. Binney Craig, Mr. James Young, and a number of ladies.

The Chairman stated that their President, Mr. Robert Cathcart of Pitcairnie, was detained in the South on account of illness. He had telegraphed expressing the hope that there would be a good attendance, and that the Show would be a success. Lord Provost Mathewson, whom he had pleasure in introducing, would formally open the Show.

The Lord Provost said all present would be exceedingly pleased, as well as surprised, to see such a display, notwithstanding the lateness of the season. In opening the fifth Show of the Scottish Primula and Auricula Society it might not be amiss to allude to its origin. Five years ago a number of Auricula growers resolved to supply the felt want in Scotland of an annual Show of their favourite flowers. While England had several shows Scotland had none. The proposal started in Dundee met with great success, and the new Society was joined by most of the growers and lovers of the flower in Scotland. The three first Shows were held in Edinburgh, and last year the Show in Dundee was so well patronised that it was agreed to have it again in the city. It would interest many to know that forty years ago Auriculas were

shown at the spring Show then held. At that time there were six well-known collections in town. On the death of the owners the cultivation of the flower fell off for a time, but of late years the enthusiasm had returned as great as ever. The Dundee growers were raisers as well as cultivators, and many of the flowers grown at the present time bore their names. The West of Scotland was also noted for the number of successful raisers and growers. Lovers of Auriculas said that when once so struck with their beauty that they took to the cultivation of them their affection was unbounded, and, looking at their exquisite forms, that was not to be wondered at. But besides Auriculas it was pleasing to see such beautiful displays of other flowers, and this spring Show would hold a worthy place among the flower shows of the year. It was earnestly to be hoped that great success would crown the efforts of the Committee of the Exhibition, and that there would be yet many shows of this favourite flower of their forefathers and of themselves. He had pleasure in declaring the Show open.



A ROSE CONCERT.

A SURREY paper says:—"Amongst the many useful functions which the 'man of ideas' performs for society is that of inventing some new form of entertainment for the public delectation. Such a man is Mr. Arthur H. Engelbach of Surbiton, who has just hit upon an extremely happy notion, the association of music with flowers, in what he is pleased to call a 'Rose concert,' to be given at the Surbiton Assembly Rooms in June. Mr. Engelbach's energy suffices to assure us beforehand that his idea will be realised most successfully, and that the event will stand out as one of the most pleasurable of the present season. But if there were any doubt upon this score it would be set at rest by the fact that he has secured beforehand the favour of the ladies, a great many of whom have already assented to the use of their names as patrons, while others have formed themselves into a Rose Committee. Mr. Engelbach has already placed an order for 5000 cut Roses to be used on the occasion, and he also anticipates large gifts of the queen of flowers to be sent to members of the Rose Committee. With these flowers, so we learn, the hall is to be decorated with great lavishness, and, as every person attending the concert will also be expected to wear Roses for their personal adornment, from a spectacular point of view the occasion will necessarily have much to recommend it."

ROSE SHOWS IN 1891.

- June 23rd (Tuesday).—Westminster (N.R.S.).
- " 24th (Wednesday).—Richmond (Surrey) and Royal Aquarium.
- " 25th (Thursday).—Ryde.
- " 27th (Saturday).—Eltham and Reigate.
- " 30th (Tuesday).—Canterbury, Diss, and Winchester.
- July 1st (Wednesday).—Bagshot, *Brighton, Brockham, Croydon, and *Lee.
- " 2nd (Thursday).—Farningham and Norwich.
- " 4th (Saturday).—Crystal Palace (N.R.S.).
- " 7th (Tuesday).—Gloucester.
- " 8th (Wednesday).—Dursley, Hitchin, Sutton, and Tunbridge Wells.
- " 9th (Thursday).—Bath and Woodbridge.
- " 11th (Saturday).—New Brighton.
- " 14th (Tuesday).—Christleton and †Wolverhampton.
- " 15th (Wednesday).—Ealing.
- " 16th (Thursday).—Hereford (N.R.S.), Bedford, Helensburgh, and Trentham.
- " 18th (Saturday).—Manchester.
- " 21st (Tuesday).—Tibshelf.
- " 23rd (Thursday).—Halifax and Worksop.
- Aug. 1st (Saturday).—Ripley (Derby).

* Shows lasting two days. † A three-days Show.

Unless I receive notice of any important alterations no farther list will be issued.—EDWARD MAWLEY, *Rosebank, Berkhamsted, Herts.*

PTERIS VICTORIÆ.

DURING recent years we have had to rely chiefly upon home-raised Ferns for the novelties, as comparatively few have been introduced to cultivation of exceptional merit. Amongst the crested and dwarf forms of Pterises variations have been freely obtained, and some of these have proved both distinct and useful in no ordinary degree. In the Fern represented in the woodcut (fig. 71) prepared from plants in Mr. W. Bull's nursery at Chelsea, we have, however, an introduction which will take a place amongst the best Ferns for decorative purposes, as it

possesses several valuable characters. The plants in Mr. Bull's houses are perfectly uniform in all the distinguishing points—viz., graceful yet compact and strong habit, with tall slender fertile fronds having a

but it is regarded by Mr. J. G. Baker as a variety of *P. crenata*, or, as it is now termed, *P. ensiformis*. This species belongs to the same section as *P. cretica* and *P. serrulata*, but, according to the "Synopsis Filicum,"



FIG. 71.—PTERIS VICTORIÆ.

central silvery line in each division, and shorter barren fronds with broader pinnae also variegated with silvery lines.

This Fern will become generally known in gardens as *Pteris Victoriae*,

it is a native of "Hindustan from the Himalayas to Ceylon, Chusan, and Loochoo Islands southward to tropical Australia, and eastward to Samoa and Fiji."

HARDY FRUIT.

[A prize Essay read at a meeting of the Cardiff Gardeners' Mutual Improvement Society.]

(Continued from page 364.)

THE PEAR.

THE progenitor of the most delicious fruit I know is found wild in the woods of Britain, and from that the grand varieties of to-day have by gradations descended. The needs of both the Apple and the Pear are very similar as regards site, soil, methods of propagation and training. The stocks, however, differ. The varieties are chiefly grafted upon either the free stock—that is, the Pear from seed, or the Quince (*Cydonia vulgaris*). Wherever the soil is deep and good and space no object, have the free stock, using the Quince on cold and heavy soils, and in cases where sufficient space is not at command. The Quince is to the Pear what the Paradise is to the Apple; both are surface rooting, and need generous feeding by mulching the ground.

Seeds of the Pear sown and grown on reach the grafting quarters the third season. The Quince stock is obtained by inserting cuttings in the autumn and early winter in the same way as we do Gooseberry cuttings, and are generally fit for grafting after the second year. As I have left out the Peach and Apricot from this paper on account of its title, these fruits needing the protection of a wall, I must perforce also omit the cultivation of the Pear on walls. But I will say this, that the varieties which succeed on walls are not placed there because they are not hardy, for it is well known that we usually cover our walls with such varieties as Williams' Bon Chrétien, Louise Bonne of Jersey, Marie Louise, &c., and no one would call in question the hardiness of these. No; we cover our walls with Pears, because it is as profitable a covering as any, and more so than some, especially on the western faces, which position they usually occupy when so cultivated.

The Pear as an espalier is more desirable than the Apple, horizontal form of course, and the directions given for the Apple apply here also as regards pruning and training. The cordon is in great favour with some cultivators, whether for walls or espaliers; but the low horizontal form of cordon trained to a single wire is a form which seems to be dying out, having failed to find favour with practical men.

The fantastical methods which have been so popular on the Continent, and of which we sometimes see sorry examples in old establishments in this country, have had also to give way to the horizontal, palmette verrier, and fan-shape as being the most effectual and simplest, whether for walls or espaliers. The trees budded in August are preferred to those that are grafted in April, the union of stock and scion being more effectual and complete, and the trees grow away with greater vigour. Standards may be planted nearer together than Apples, as the habit of the Pear is more erect than the Apple; prune as directed for the latter fruit, and keep the roots near the surface by feeding; use the fork for disturbing the soil, as the spade is liable to cause injury to the roots. A space of 18 to 20 feet between the lines and trees will be sufficient for the Pear as a standard.

Pyramid Pears are very popular. An avenue of Pears cultivated on the principles laid down for the Apple will always command admiration, alike for symmetry and fertility. To build up a handsome pyramid the main leader should never be allowed to grow away throughout the season, but should be pinched when it has grown about a foot; the sap would then force its way laterally and form the branches. By this pinching system while the growth is in a soft condition we could arrange the branches wherever they are required to form a well-balanced tree. On the other hand, if the main leader were allowed to grow to its entire length without being pinched and cut back in winter only, the result would be that another strong leader would be formed, and the balance of the tree would not be attained by the formation of the necessary branches. It is also grown in the bush form, and allowing for the nature of the Pear the same system of culture may be followed as recommended for the Apple.

Many people have become so disgusted with their fruit trees as to almost despair of seeing any adequate return, but that was under the old system of allowing every shoot, no matter how crowded, to attain maturity, and cutting them clean away in winter, only to give place to greater abundance of shoots the following season, which were served in the same way again, and so on year after year. The great fact that three or four well-developed leaves are worth a dozen of a weak texture is pretty well understood now. Such leaves alone give fertility, and they can only be obtained by the regulation of the growth in the early part of the growing season, and before the usual breast pruning takes place.

When trees are advanced in size and fairly settled into bearing they never make the growth which is characteristic of youth. The older a tree gets the less pruning is required, but it should not be forgotten that to maintain fertility we must be generous to the roots. I remember once seeing an old pond cleared, and the slimy refuse was deposited in an orchard, and left there to get dry to make it fit for further removal. The manner in which some of the old stunted specimens of fruit trees took the food and put out strong and robust growth which proved fruitful the following season was a lesson well learnt and not forgotten. The size of the fruit was increased too, and it was a pity that the varieties which came under the influence of the manure were cider Apples and stewing Pears, instead of being the grand Pippins we have now, or the delicious Pears we know. It is somewhat strange, but in another part of the same orchard there were some good varieties, including a Jargonelle.

When trees have attained their full growth upward, or nearly so,

thinning out should be looked to. It may be necessary to remove entire branches. Once done it is sufficient for years, and is more often done in the case of Apples than Pears. Old trees, whether of Apples or Pears, can be renewed if not of good varieties by heading back, and grafting good varieties thereon. A portion of the tree may be done at one time, the remainder the next season. If done at once the enormous flow of sap from such a mass of roots would overpower the grafts, and render the whole process nugatory. It is rather a tedious process, but it is effectual when well done, and who would not take the trouble to change worthless varieties for Marie Louise or Jargonelle if he were assured of success, as he might be if he took the trouble?

Twelve good Pears are as follows:—Jargonelle, Marie Louise, Louise Bonne of Jersey, Fertility, Souvenir du Congrès, Williams' Bon Chrétien, Beurré Hardy, Pitmaston Duchess, Beurré Diel, Ne Plus Meuris, Beurré d'Amanlis, and Bishop's Thumb.

(To be continued.)

THE CRYSTAL PALACE SHOW.

MAY 9TH.

THE Exhibition at the Palace on Saturday last afforded a surprise to many horticultural visitors, especially those who have not attended for the past year or two. In number of exhibits the Show surpassed those held recently, and there were also many of considerable merit, but a great change has taken place in exhibitions of this character. The large specimens, at one time so important a feature, are no longer seen, and that perhaps would not be so great a loss if the smaller ones were equally well grown. Unfortunately, with a few exceptions, this does not appear to be the case, and it is becoming evident that unless more care is exercised in the culture of exhibition specimens they will be gradually excluded from schedules, and groups will take their place. A few shapeless and poorly flowered so-called "specimens" in a class present a sorry appearance without the aid of other plants to counterbalance their imperfections, as could be done in a group arranged for effect.

At the Palace Show stove and greenhouse plants were represented in first-rate condition by few exhibitors. Mr. Chapman, who took the lead in both open and amateurs' classes, had decidedly the best and freshest, some of his medium-sized specimens being as good in all points as could be desired, but there was a great falling off in many of the others. Mr. C. Turner's Azaleas were, as usual, ahead of all exhibits, and gained him the honours, but they were not up to his usual style throughout. Fine-foliage plants, including Ferns, Crotons, Dracenas, &c., were numerous and vigorous, but the Crotons were deficient in colour, as might be expected in such a season. The Ferns which gained Mr. Howe of Streatham the premier prize in the amateurs' classes were, however, admirable, and indicated the best of cultural attention in their luxuriant clean, fresh fronds.

Calceolarias were better shown than usual. Though the plants were small they were compact and sturdy, with well developed brightly coloured flowers, and these characters were especially notable in Mr. Guyett's two collections, with each of which he gained a first prize. Messrs. J. Carter & Co.'s non-competing group of Calceolarias also found many admirers, the plants being of good habit, the colours varied and bright. Orchids on the other hand were most poorly represented, perhaps one of the worst displays ever seen at a show of this character.

In the classes for Roses Messrs. Paul & Son of Cheshunt and Mr. C. Turner were the prizewinners with well grown examples of the most popular Roses, while Messrs. W. Paul & Son's non-competing group of Roses in front of the stage was an important feature in this part of the Show. Table plants were also extremely well shown, the competition being very keen and close, as eight collections of eighteen each were staged, and in addition to nine from Messrs. Hazell of Bickley Park, Carter of Ewell, and Lane of Caterham, who won the prizes in that order; several of the others had praiseworthy exhibits, the best being that from Mr. Edwards of Witley. Pelargoniums were very showy and most welcome, Mr. Turner and Mr. Phillips, both of Slough, winning the honours in the open and amateurs' classes respectively.

Floral decorations formed an interesting department, and again Messrs. Perkins & Sons of Coventry signalled themselves by taking three first prizes. Mr. Newman of Bromley, however, also exhibited some tasteful arrangements, as also did Mr. Butcher of Norwood and Mr. Clark of Balham.

The miscellaneous non-competing exhibits were numerous and of great merit; in addition to those incidentally mentioned extra prizes were awarded to Messrs. B. S. Williams & Son, Upper Holloway, for a large group of flowering plants; to Messrs. Laing & Sons, Forest Hill, for a tasteful and effective display; to Messrs. Peed & Son, Tulsc Hill, for a fine group in which some excellent Anthuriums were prominent. Daffodils and hardy flowers came from Messrs. T. S. Ware, Tottenham, and Barr & Son, Covent Garden; a handsome group of greenhouse plants from Messrs. Cutbush & Sons; and Tree Mignonette from Mr. J. A. Causton. In the special class provided by Messrs. James Carter and Co., 237 and 238, High Holborn, London, for the best brace of "Carters' Model Cucumber," Mr. T. Lockie, Oakley Court Gardens, Windsor, was first with fine specimens. The following are the awards in the chief classes:—

Open Classes.—Nine Stove and Greenhouse Plants.—First, Mr. W. Chapman, gardener to J. Spode, Esq., Hawkesyard Park, Rugeley. Second, Mr. Henry James, Castle Nursery, W. Norwood. Third, Mr. J. F. Mould, Exotic Nursery, Pewsey, Wilts. Nine Greenhouse Azaleas.—First, Mr. C. Turner, The Royal Nurseries, Slough. Second, Mr.

A. Offer, Handcross Park Gardens, Crawley. Third, Mr. J. F. Mould. Nine Ericas, grown in not less than 12-inch pots.—First, Mr. J. Currey, Salisbury. Nine Fine-foliage Plants (Palms and Ferns Excluded).—First, Mr. J. Hudd, Blackheath Park. Second, Mr. J. Currey. Third, Mr. A. Offer.

Nine Crotons.—First, Mr. A. Offer. Second, J. A. Causton, Esq., Alley Park (gardener, Mr. J. R. Bird). Third, Mr. J. F. Mould. Nine Dracenas.—First, Mr. J. Lambert, gardener to H. W. Segeleke, Esq., Elfindale Lodge, Herne Hill. Second, Mr. A. Offer. Third, J. A. Causton, Esq. Nine Caladiums.—First, Messrs. J. Laing & Son, Stanstead Park, Forest Hill. Second, Mr. J. Day, gardener to W. S. Gover, Esq., Casino House, Herne Hill.

Eighteen Calceolarias, Herbaceous, not less than twelve distinct.—First, Mr. H. Guyett, gardener to T. Gabriel, Esq., Leigham Court Road, Streatham. Second, Mr. H. Long, gardener to H. C. Barker, Esq., Leigham Holme, Streatham. Third, Mr. J. Slater, gardener to T. Nothard, Esq., York House, Lower Sydenham. Eighteen plants suitable for dinner-table decoration, grown in pots not exceeding 6 inches, not less than twelve varieties. Flowering plants admitted.—First, Mr. H. Hazell, gardener to R. W. Mitchell, Esq., Bickley Park. Second, Mr. A. Carter, gardener to Alderman Evans, Ewell Grove, Ewell. Third, Mr. C. Lane, gardener to E. H. Coles, Esq., Burntwood, Upper Caterham, Surrey. Twenty-four Pelargoniums, show and decorative type, in 6-inch pots.—First, Mr. D. Phillips, Langley Broom, Slough. Second, Mr. Charles Turner.

Single Specimen Orchid.—First, Mr. W. Finch, gardener to J. Marriott, Esq., Queen's Road, Coventry. Second, Mr. H. James. Single specimen stove plant, in bloom.—First, Mr. W. Chapman. Second, Mr. H. James. Third, Mr. J. Lambert. Single specimen greenhouse plant, in bloom, Azalea excluded.—First, Mr. W. Chapman. Second, Mr. J. F. Mould. Single specimen fine-foliage plant, Palms excluded.—First, Mr. A. Offer. Second, Mr. J. Lambert. Third, Mr. E. Vander Meersch, Queen's Nursery, High Street, Selhurst.

Six Buttonhole Bouquets, three ladies', three gentlemen's.—First, Messrs. Perkins & Sons, nurserymen, Coventry. Second, Mr. Thos. Butcher, South Norwood. Third, Mr. A. Scrivener, 3, Queen Street, Watford, Herts. One Bouquet.—First, Messrs. Perkins & Sons. Second, Mr. Geo. Newman, florist, Bromley, Kent. Third, Mr. W. T. Clark, 5, Boundaries Road, Balham. One Bridal Bouquet.—First, Messrs. Perkins & Sons. Second, Mr. G. Newman. Third, Mr. F. End, florist, Crystal Palace. One Vase or Epergne for Drawing-room.—First, Mr. F. Bishop, Duppas Hill Lane, Croydon. Second, Mr. W. T. Clark. Third, Mrs. A. Bawtree, Mulgrave Road, Sutton. Three Vases or Stands for Dinner Table, dressed with flowers and foliage.—First, Mr. Thos. Butcher. Second, Mr. Thos. Horsman, Clock House Nursery, Beckenham. Third, Mr. E. Chadwick, gardener to C. M. Nelson, Esq., J.P., Hanger Hill House, Ealing.

Amateurs' Classes.—Six Stove and Greenhouse Plants.—First, Mr. W. Chapman. Second, Mr. J. Currey, gardener to Colonel Pepper, Milford Hill, Salisbury. Third, Mr. A. Offer. Six Greenhouse Azaleas, distinct, in bloom.—Second, Mr. A. Offer. Third, Mr. J. Ford, gardener to Sir C. Pigott, Bart., Wexham Park, Slough. Six Fine-foliage Plants.—First, Mr. J. Ford. Second, Mr. H. Hazell, gardener to R. W. Mitchell, Esq., Fairfield, Bickley Park, Kent. Third, Mr. J. Currey. Six Stove and Greenhouse Ferns.—First, Mr. W. Howe, gardener to H. Tait, Esq., Park Hill, Streatham Common. Second, Mr. J. Ford. Third, Mr. A. Offer.

Six Crotons.—First, Mr. J. Ford. Second, Mr. A. Offer. Third, Mr. H. Guyett. Six Dracenas.—First, Mr. J. Hudd. Second, Mr. C. Simmonds, gardener to H. C. Mayhew, Esq., South Norwood Hill. Third, Mr. J. Lambert. Six Gloxinias.—First, Mr. W. Leaky, gardener to J. M. Douglas, Esq. Second, Mr. J. Bateman, "Kuparra," College Road, Upper Norwood. Third, Mr. J. Slater, York House, Lower Sydenham.

Twelve Calceolarias (Herbaceous), not less than nine distinct.—First, Mr. H. Guyett. Second, Mr. J. Buss, gardener to A. W. Aston, Esq., West Hill Lodge, Epsom. Third, Mr. H. Long. Twelve bunches cut flowers, stove and greenhouse.—First, Mr. W. Finch. Second, Mr. E. Chadwick. Third, Mr. J. Hudd.

ROYAL HORTICULTURAL SOCIETY.

MAY 12TH.

ALTHOUGH within a fortnight of the Temple Show, an interesting meeting was held at the Drill Hall on Tuesday, more novelties being shown than on several previous occasions when the displays were much more extensive. The Floral and Orchid Committees found no less than eleven plants worthy of certificates or awards of merit, and several cultural commendations were also worthily awarded for exceptionally well-grown specimens. All the Committees were fully attended, and amongst the "strangers" was Mr. Harry J. Veitch, who again resumed his place as Chairman of the Orchid Committee after a prolonged absence on a Continental tour. Mr. W. Goldring was also welcomed on his return from another business journey to India.

At the afternoon meeting of Fellows and visitors, the Rev. G. Henslow discussed upon Rhododendrons in his customary fluent and pleasing manner, illustrating his remarks by specimens from the interesting collection of hybrids contributed by Sir John T. D. Llewelyn, Bart. These afternoon lectures are an important additional source of interest to the meetings, and a good audience is almost invariably secured.

One exhibit deserves prominent notice here, as it presented several features of a special character that might often be included with ad-

vantage. This was a group of hybrid Narcissi from the Rev. G. H. Engleheart, Appleshaw, Andover, in which about a dozen curiously intermediate forms were shown, together with flowers of each of their parents, the seed parent on the left, the pollen parent on the right, with the seedling in the centre. This very satisfactory arrangement enabled all visitors to see at a glance what had been effected by each cross, and the respective influence of every type could be readily traced. We shall have occasion to refer fully to these hybrids again, but it may be remarked that the principal crosses had been made between the Narcissus poeticus and the N. pseudo-Narcissus sections, although N. Tazetta, N. triandrus, N. Jonquilla, and N. incomparabilis had also been tested. The most remarkable of all was a form named Albatross (fig. 72) which was obtained from a cross between N. poeticus ornatus and N. pseudo-Narcissus Empress, the result being a greatly enlarged flower of the poeticus form, 4 inches in diameter, with rounded white petals nearly 1½ inch across in the broadest part; the corona like poeticus, yellow with an orange margin. For this hybrid the Narcissus Committee awarded a silver medal, an indication of their opinion concerning its merits. Several other remarkable results of crossing were

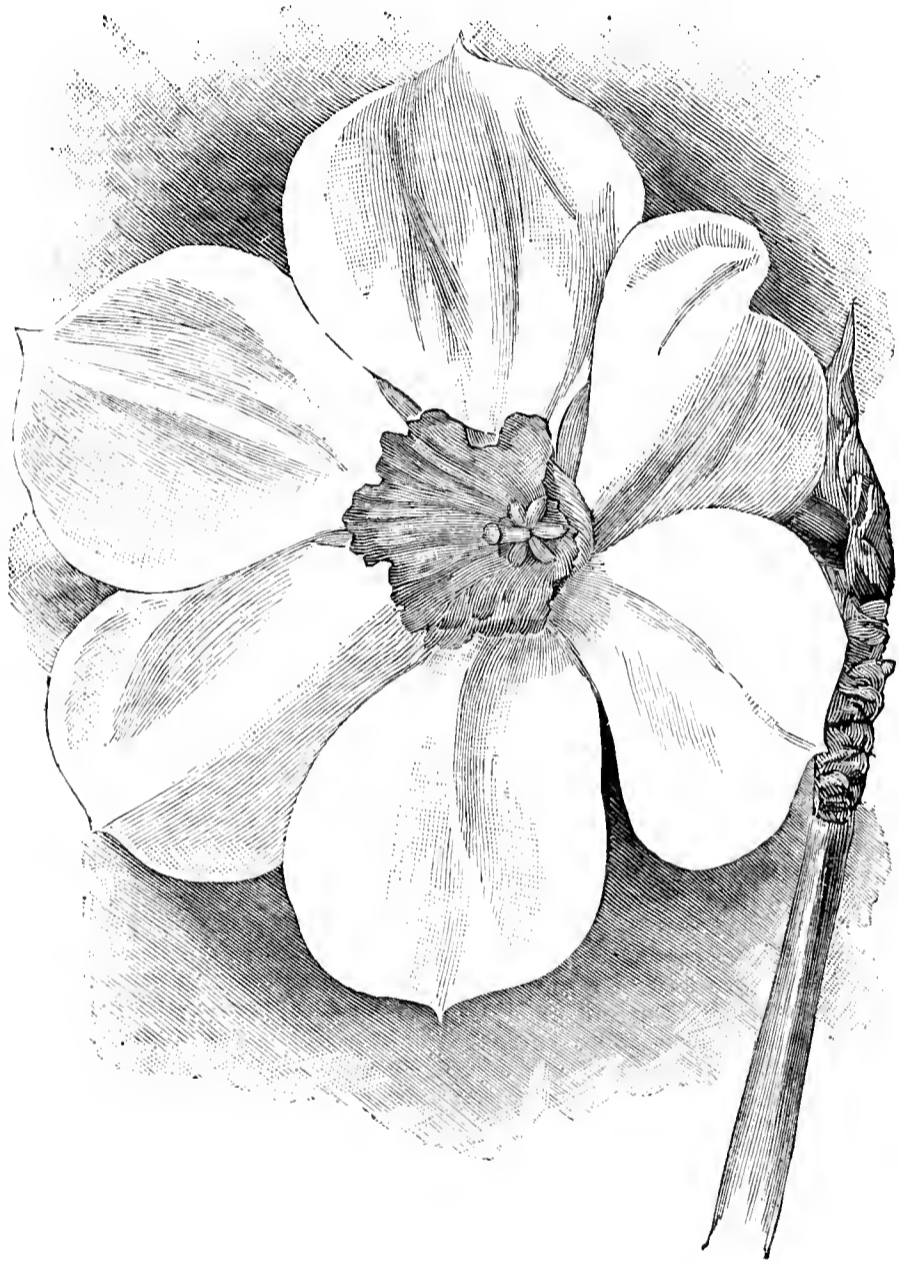

FIG. 72.—HYBRID NARCISSUS ALBATROSS.

shown, and the collection altogether was one of the most interesting seen at the Drill Hall for some time.

FRUIT COMMITTEE.—Present: Philip Crowley, Esq., in the chair, and Messrs. J. Lee, R. D. Blackmore, G. W. Cummins, J. Cheal, G. Bunyard, W. Warren, T. J. Saltmarsh, G. Wythes, J. Hudson, W. Bates, H. Balderson, J. Smith, C. Penny, G. T. Miles, and F. Q. Lane.

The duties of this Committee were extremely light, and occupied a short time. Mr. Leach, gardener to the Duke of Northumberland, Albury Park, Guildford, contributed a box of fine James Veitch Strawberries, bright, even, and tempting fruits, for which a cultural commendation was awarded; dishes of Noble and Auguste Nieaise Strawberries from the same garden were also shown. Messrs. Burton & Son, Bexley Heath, sent remarkably early fruits of Waterloo Peach of fair size and colour, and were adjudged a cultural commendation. Mr. C. Turner of Slough had four dishes of Tasmanian Apples (vote of thanks), and Mr. Maher showed a neat brace of Cucumber Pride of the Market. From the R.H.S. Gardens, Chiswick, came a collection of Apple blossom showing the characters of the early varieties. Ten varieties of Rhubarb that have been on trial at Chiswick were also sent, Victoria, Paragon, Hawke's Champagne, Laxton's Conqueror and Early Red being noteworthy.

FLORAL COMMITTEE.—Present: W. Marshall, Esq., in the chair, and Messrs. H. Herbst, R. Dean, W. Furze, W. C. Leach, G. Phippen, C. E. Pearson, W. Bain, J. Walker, T. Baines, C. Noble, H. Turner, G.

Paul, B. Wynne, G. Gordon, G. Nicholson, W. Goldring, C. T. Druery, F. Ross, E. Mawley, and the Rev. H. H. D'Ombraim.

Amateurs' exhibits were more numerous at this meeting than they have been this season, and the encouragement afforded is evidently bringing good results. A group of Roses from Mr. Perry, gardener to J. C. Tasker, Esq., Middleton Hall, Brentwood, comprised a number of dwarf plants extremely well grown, bearing abundant fine blooms and good clean foliage, and the silver-gilt Flora medal awarded was an appropriate recognition of their merits, for rarely do amateurs show such creditable examples of Roses in pots. The Rhododendrons from Sir J. T. D. Llewelyn, Bart., Penllergare, Swansea, have already been incidentally noted, but it may be added that some dozens of trusses were shown of seedlings from crosses between Thomsoni, Aucklandi, Broughtoni, catawbiense, Edgeworthi, glaucum, campylocarpum, arboreum, and other species, representing many beautiful shades of colour, the flowers, too, of great size in dense heads. A silver Banksian medal was awarded.

Mr. J. Curtis, gardener to P. F. Still, Esq., Lismore, Woodside, Wimbledon Park, exhibited two baskets of Auriculas and a group of Hippeastrums (bronze medal). J. Bateman, Esq., Worthing, sent a flower stem of *Chamærops Fortunei* (vote of thanks). W. E. Gumbleton, Esq., Belgrove, Queenstown, Ireland, had some admirable paintings of Daffodils, Snowdrops, and *Chionodoxas* (vote of thanks); and Mr. G. Couzins, Feltham, sent for name a basket of the double *Cardamine pratensis*. From Mr. Coppin of Battersea Park came a plant of *Puya Whytei*, with a flower stem 7 feet high, bearing at its summit large bright green flowers (vote of thanks); and Mr. G. Chadwick, Hanger Hill House, Ealing, showed plants of the graceful *Arthropodium cirratum* with narrow green recurving leaves and light panicles of small white flowers.

Apart from novelties certificated the chief trade exhibits were a group of Daffodils, Tulips, and hardy flowers from Messrs. Barr & Son, Covent Garden (silver Banksian medal); a collection of fine *Polyanthuses* and *Primroses* from Mr. G. Phippen, Reading (bronze medal); a group of *Spirea multiflora arguta*, with small white flowers on slender leafless branches, from Messrs. W. Paul & Son, Waltham Cross (vote of thanks); a new decorative *Pelargonium*, named A. F. Barron, from Messrs. Hewitt & Co., Birmingham, and three new *Cannas* from M. Victor Lemoine, Nancy.

Messrs. Barr & Son's prizes for Daffodils were won by the Rev. G. P. Haydon, Hatfield Vicarage, Doncaster, and H. J. Adams, Esq., Roseneath, Enfield, both exhibiting large collections of fresh well-developed flowers. From Kew came a group of *Narcissus Bernardi*, flowers most varied and graceful.

ORCHID COMMITTEE.—Present: Harry J. Veitch, Esq., in the chair, Baron Schröder, Dr. M. T. Masters, and Messrs. H. M. Pollett, H. Ballantine, C. Pilcher, F. Sander, E. Hill, J. O'Brien, and Lewis Castle.

Cattleya citrina is not too often seen in good condition, and some cultivators do not succeed with it at all. This certainly does not, however, apply to Sir Charles Strickland, with whom it thrives admirably. Nine plants were shown from this garden, all upon blocks, the fragrant yellow flowers abundant and the growth strong (cultural commendation). Another Orchid that is difficult to grow is *Lælia majalis*, but Mr. W. H. Young, gardener to F. Wigan, Esq., Clare Lawn, East Sheen, showed a vigorous plant growing in a basket, four of the handsome flowers expanded and two buds showing (cultural commendation). A similar recognition was awarded to Mr. W. Murray, The Gardens, Oakwood, Wylam-on-Tyne, for an exceedingly strong plant of *Cypripedium Rothschildianum*, bearing three grand flowers, which awakened the admiration of the Committee. Mr. B. Phillips, gardener to F. A. Bevan, Esq., Ludgrove, New Barnet, sent flowers of *Odontoglossums*, *Cypripediums*, and *Sobralia macrantha delicata*, a soft-tinted variety (vote of thanks). Mr. Johnson, gardener to T. Statter, Esq., Stand Hall, Whitefield, Manchester, had a variety of *Cypripedium Lawrenceianum* named *expansum*, with broad dorsal sepals and dark veins, also *Cattleya Mendeli cœleste*, a fine variety. R. B. White, Esq., Ardaroach, Garelohead, Dumbartonshire, sent a collection of fine *Cattleya* flowers (vote of thanks); and Mr. H. T. Chapman, gardener to G. le Dux, Esq., Langdon House, East Moseley, contributed several *Odontoglossums*, including one of the best varieties of *O. nebulosum* we have seen. It was shown as *punctatum*, but was considered identical with *excellens* previously certificated. Some *Masdevallias* were also shown (vote of thanks). Messrs. Sander & Co., St. Albans, had a peculiar green flowered *Cypripedium* named *viridiflorum*; Mr. Standing, The Gardens, Patching, Worthing, sent a *Dendrobium densiflorum* with twenty racemes; and Messrs. Secger & Tropp, East Dulwich, had a small group of Orchids, comprising *Lælias*, *Oncidium*s, *Cypripedium*s, and *Odontoglossums*.

CERTIFICATED PLANTS.

Sweet Briar Lady Penzance (Lord Penzance, Eashing Park, Godalming; gardener, Mr. Baskett).—A charming single variety, with metallic rosy bronze flowers, yellow at the base of the petals. The flowers are about 2 inches across, and the foliage is fragrant. A note accompanied the plant to this effect:—"The specimen is a graft or bud on the *Manetti* of a seedling from the common Sweet Briar, crossed with the pollen of the Austrian Copper Briar in 1886. The seedling came up in the spring of 1887, and flowered for the first time in 1889, but had only one flower. It is now a vigorous plant 4 feet high, the wood a sort of purple colour like that of the pollen parent" (award of merit).

Lilac Léon Simon (Paul & Son, Chestnut).—Flowers very double, in dense clusters, of a pale clear lilac tint (award of merit).

Pteris cretica crispata (J. Veitch & Sons, Chelsea).—An excellent

Fern of compact habit, but free and strong, the pinnate fronds with their clear silvery centre having a most distinct appearance owing to the evenly undulated and deeply serrated margins, a valuable decorative Fern (first-class certificate).

Anthurium burfordiense (Sir Trevor Lawrence, Bart., M.P.).—A magnificent variety raised at Burford Lodge, having rich crimson shining spathes, 7 inches in diameter, nearly circular, with a long white spadix (first-class certificate).

Anthurium Laingi (Sir Trevor Lawrence).—A fine contrast to the preceding; the spathes broad and larger, and white, with a fine cordate leaf 18 inches long and 15 inches broad (first-class certificate).

Myosotis Bealey Gem (W. Marshall, Esq., Bexley).—An extremely dwarf Forget-me-not, only 2 or 3 inches high, with large bright blue flowers (award of merit).

New Orchids.—These are described in the Orchid column, on page 384.

PLATYCERIUMS.

THE *Platyceriums* or Stag's Horn Ferns form one of the most distinct and interesting groups that are found in all the vast Fern tribe, and are certainly worthy of more extended recognition than they have thus far received. Of course, it is well understood that they are not likely to become just the plants for everyone's local trade, but at the same time there are some of them that will stand considerable exposure without much injury, and they are all admirable for greenhouse decoration, providing the conditions are such as would be favourable for Fern growth. The members of this genus are epiphytal in habit, and for this reason are most happy when grown either on a section of a Tree Fern stem or block of wood or in a basket, though this treatment is not absolutely essential for all, as some of the species can also be satisfactorily grown in pots. But in either case the potting material must be of an open, easily drained character, the best soil being rough fibrous peat, or peat and sphagnum, and as such soil soon dries out frequent waterings will be found necessary. In order to keep the foliage in good condition it is best to keep the water off the leaves as much as possible, especially in the winter, as at the latter season these may soon be discoloured.

The propagation of the *Platyceriums* is not a very rapid process, and depends on two methods—viz., either by means of seeds or spores, or by the production of young plants or suckers from the roots, the latter practice being common to most of the species, and the young plants so produced being readily separated from the parent plant after they have made one or two fronds. If spores are resorted to they should be sown as soon as possible after they are gathered, using a coarse compost of peat and sand on which to sow them, and keeping them moderately close until they show signs of germination, after which they need rather careful watching in order to prevent them from damping off. The spores of these plants are somewhat slow in germinating at best, and it seems a rather uncertain operation too; but the only safe plan is to give them a fair chance, and not to empty out the seed pots in disgust within six months after sowing.

The first species in cultivation and doubtless the most widely known is *P. alcorni*, the common Stag's Horn Fern, which was introduced from Australia about the beginning of the present century. In common with the other members of the genus this plant has fronds of two very different types, the barren ones being more or less flat and shield-like, while the fertile leaves are upright in habit and deeply cut into such long, narrow lobes as to clearly indicate the reasons for its ordinary name, the ends of these lobes drooping over in a very graceful manner. This is probably the most hardy member of the genus, and can be readily grown in a night temperature of 50°.

A considerable improvement on the above as a specimen plant was sent out some years ago in the form known as *P. alcorni major*, this being of much stronger growth and more upright than the type. The fronds of this variety are of thick leathery texture, and very dark green in colour, giving the plant a very attractive appearance and making it also one of the best exhibition Ferns in cultivation.

Probably the most noted species is *P. grande*. The barren fronds are very large and almost erect, and are deeply cut into spreading divisions, while the fertile ones are thrown out at almost a right angle to the first, being from 3 to 6 feet in length in a large plant, and are deeply divided into long pendent segments. The spores of *P. grande* are produced in a large irregular patch at the base of the segments noted above, and in general appearance bear some resemblance to a patch of brown fungus on the under side of the frond. I have never seen this species produce any young plants from the roots, but have raised it from spores, though experiencing some little difficulty with the young plants when they were first potted off, from their susceptibility to "damping" at that stage.

Another remarkably handsome species is *P. Willincki*, a warm house plant from Java, introduced some fifteen years ago. This is of smaller growth than the preceding, the barren fronds being erect, rounded at the base, and cut into lobes. These fronds are somewhat ephemeral in character, or rather in substance, and seem soon to have fulfilled their office, as they turn brown and dry in a short time after they are developed, whereas the fertile ones will endure for a year or more. The latter are produced in threes, attaining a length of 3 feet or more, are drooping in habit, and several times forked into perhaps the most perfect representation of a stag's horn that is to be found in the vegetable kingdom, while the colour is greyish white, this being caused by the fronds being closely covered with whitish scales.

Other fine species are *P. Hilli* and *P. æthiopicum*, both of which are strong growers and remarkably handsome. In addition to those already alluded to there is one other species that is sometimes catalogued, though probably not in cultivation, and from description is the oddest of this odd genus, as it has in addition to these two forms of fronds common to the family a special fertile segment or frond, the latter being kidney-shaped and 6 inches or more in breadth and thrown up on a stalk.—W. H. TAPLIN (in *American Florist*).

THE ROYAL BOTANIC SOCIETY.—MAY 13TH.

A BEAUTIFUL Exhibition was provided on Wednesday in the Regent's Park Gardens, and the day being exceptionally bright and warm rendered it completely satisfactory in all points. The marquee was filled but not crowded, and there was plenty of colour without being overpowering; the arrangements being skilfully managed by Mr. Coomber. There was a large attendance of visitors.

Orchids formed a fine bank in the centre, three first prize collections occupying the space devoted to these plants. For twelve exotic Orchids Mr. T. Whellans, gardener to the Duke of Marlborough, Blenheim, had premier honours for handsome specimens of *Cattleyas*, *Dendrobiums*, *Odontoglossums*, and a grand *Cymbidium Lowianum*. Mr. J. Douglas, gardener to Mrs. Whitbourn, Great Gearies, Ilford, had a similar position in the amateurs' class for a collection with a bright and varied group of large and small plants; and Mr. James, Norwood, was first in the nurserymen's class for twelve plants with healthy specimens.

Stove and greenhouse plants were represented by medium-sized examples. Mr. W. Chapman, gardener to J. Spode, Esq., Hawkesyard Park, Rugeley, repeated his Crystal Palace successes, and won premier honours in the amateurs' classes with ten and six specimens in capital condition. Mr. Scott, Regent's Park, was second in the former class, and Mr. Offer in the latter, both showing small plants. Mr. Mould, Pewsey, was first in the nurserymen's classes for twelve and six respectively, small but neat, and Mr. James was second in these classes. Mr. Mould was also awarded first prize for six Cape Heaths, *Victoria Regina* being an excellent specimen.

Azaleas were an extremely bright feature, and constituted pronounced masses of colour on the slopes. Mr. C. Turner had some finely flowered plants, taking first honours with twelve, and also with six, the last named being the largest and most freely flowered Azaleas in the Show. Mr. Offer, gardener to J. Warren, Esq., Handcross Park, Crawley, was first in the class for six with large specimens, but rather irregular. Messrs. Eason, Offer, and Scott were also the prizetakers in another class for six Azaleas in 12-inch pots.

Large specimen Roses won the chief position for Messrs. Paul and Son, Cheshunt, in the nurserymen's class for nine plants, *Centifolia Rosea* and *Catherine Soupert* with *Magna Charta* being very notable. Smaller but well grown plants gained Mr. Wm. Rumsey, Waltham Cross, the second prize, but some of his plants were not at their best. With six Roses (amateurs) Mr. P. Perry, gardener to J. C. Tasker, Esq., Middleton Hall, Brentwood, was first with neat specimens. Messrs. Paul & Son's corner group of twenty Roses, which were awarded the first prize in that class, were excellent young plants of medium size, but with abundant fine blooms.

Pelargoniums were in satisfactory condition, and occupied their usual positions on the right and left banks of the large marquee near the corridor entrance. Mr. D. Phillips won the honours with six show varieties (amateurs), and six fancy varieties (open); Mr. C. Turner being second with fancy varieties, and first in the nurserymen's class for six show or decorative varieties. *Calceolarias* from Mr. D. Phillips were also fine, and gained the first prize. Fine-foliage plants and Ferns were shown by Messrs. Offer, James, J. Douglas, and Mould.

An extensive and beautiful collection of hardy plants secured Mr. T. S. Ware, Tottenham, the leading award, Messrs. Paul & Son taking the second place, but this firm was first with a choice collection of Alpines.

MISCELLANEOUS.

Roses in pots were grandly shown by Messrs. W. Paul & Son, Waltham Cross, the outer part of the group being margined with a dozen boxes of cut blooms and an edge of *Adiantums* (silver-gilt medal). Stove and greenhouse plants, Azaleas, *Mignonette* and various hardwooded plants with graceful Ferns and Palms from Messrs. Cutbush & Son, Highgate, were awarded a large silver medal. A magnificent bank of Palms, *Caladiums*, *Tuberous Begonias*, Orchids and Heaths from Messrs. J. Laing & Sons, Forest Hill, deservedly secured a similar award.

A superb group of Orchids from Messrs. B. S. Williams & Son, Upper Holloway, was arranged on one of the banks in the centre of the marquee—*Cymbidiums*, *Cattleyas*, *Lælias*, *Cypripediums*, *Masdevallias*, *Oncidium*s, and *Odontoglossums* predominated (silver-gilt medal). *Clivias*, *Hippeastrums*, Azaleas, and *Leschenaultias* constituted another bright group from Messrs. B. S. Williams & Son. *Anemone* flowers were shown by T. H. Burroughes, Esq., Ketton, Rutland, representing several distinct and brilliant varieties. Roses in pots from Mr. Perry gained him a small silver medal. New *Pelargoniums* of the show and decorative type were exhibited by Messrs. J. & J. Hayes, Edmonton (bronze medal). Cut Roses were shown by Mr. W. Rumsey (bronze medal), Mr. C. Turner also had handsome group of Roses in pots (silver medal).

Petunias were uncommonly well staged by Messrs. J. Carter & Co., High Holborn, representing their New Emperor strain. The flowers were astonishingly varied in form, colours, and markings, and the plants being arranged with Ferns and small Palms, constituted one of the most pleasing groups in the Show.

Tree *Pæonies* from Mr. T. S. Ware formed an imposing bank, the flowers large, and varied in colour (small silver medal). The brilliant blue *Leschenaultia biloba major* from Messrs. Balchin & Sons, Hassocks Nursery, Sussex, was much admired (bronze medal). White Stocks were shown by Mr. J. Wiggins, Hillingdon Heath, very even, double, and pure (bronze medal). Tulips, Daffodils, and hardy flowers were staged by Messrs. Barr & Son, Covent Garden (large bronze medal), Daffodils, Pyrethrums, and Carnations coming from Mr. T. S. Ware.



FRUIT FORCING.

PINES.—Changeable weather necessitates careful attention in the cultivation of Pines, especially as regards plants with fruit in an advanced condition, a moderately high temperature and a moist atmosphere being essential to their well-doing, which condition renders them more susceptible to injury, the effects of sudden outbursts of sun telling disastrously, especially upon the crown, which is not unfrequently scorched if the ventilation is not carefully attended to. Large, well-finished fruits are only to be obtained by close attention to details, especially when the plants are cultivated in pots. Watering will require attending to once a week, but avoid indiscriminate periodical waterings. Plants that have heat at the roots by means of hot-water pipes need more water than those having the heat furnished by means of fermenting material; the former should have water as often as required, on every occasion employing some stimulant, 1 lb. of guano to twenty gallons of water is a suitable quantity. Admit air at the top of the house at 80°, and maintain the temperature through the day at 80° to 90°, closing at 85°; but unless it be desirable to enlarge the crowns do not quite close the house. Fire heat must be employed to prevent the temperature falling below 70° at night, and to raise it to 75° in the day, the bottom heat being kept at 80° to 90°, or with the bottom heat steady a few degrees variation in the atmosphere is not of great consequence. Syringe the plants or house two or three times a week according to the weather, and maintain the atmosphere in such a condition as is likely to secure the perfect development of the fruit.

PEACHES AND NECTARINES.—*Trees Started at the New Year.*—The fruit whilst stoning must not be subjected to a higher temperature than 60° to 65° by artificial means, commencing to ventilate at 65°, and not allowing 75° to be exceeded without full ventilation. Tie in the shoots as they advance, removing superfluous growths, as it is important that no more be trained in than can be fully exposed to light and air. If the shoots are crowded thin them well as soon as the stoning is completed. Allow one fruit to every square foot of trellis covered by the trees, which will be one to each shoot of last year, although vigorous shoots may be allowed to carry two fruits. By apportioning the fruits according to the vigour of the trees, or degrees of vigour, the evenness of vigour may be maintained throughout the tree. After stoning maintain a good moisture in the house, and water the inside border copiously, which in well drained borders will not be required less than once a week, mulching the surface with about 2 inches thickness of short manure. Unless it is desired to accelerate the ripening, continue 60° to 65° as the night temperature, and 65° by day artificially by day in dull weather, and 75° with sun heat, closing at the latter with plenty of moisture in the house. In a high temperature and moist atmosphere Peaches swell to a great size after stoning, but are not so tempting in appearance nor so well flavoured as those in less heat and moisture and with freer ventilation.

Trees Started in February.—The fruit of these will soon be commencing stoning, and should have the number reduced, leaving two fruits on strong shoots, but one will be sufficient on the weaker. The fruit retained must, in all instances, be best situated for receiving air and light. Thin the shoots where crowded. The temperature by artificial means must be kept at 55° to 60° at night, and 60° to 65° by day artificially, ventilating from 65° and fully between 70° and 75°.

Trees Started in March.—With the fruit swelling attention must be given to thinning, and as it can now be seen which fruits have been properly fertilised by their taking the lead in swelling thin them to two or three on strong shoots, and proportionately less on weaker growths. Afford liquid manure to weakly trees, but vigorous trees being more prone to cast the fruit must have water only. Remove all superfluous shoots, the remaining shoots being trained to the trellis as they advance.

Unheated Houses.—Although frosts have prevailed there does not appear to be any injury affecting the crop, which promises to be abundant, and probably nine-tenths of the fruits will have to be removed. A moderate syringing on fine mornings will be a great assistance in ridding the fruit of the remains of the blossom; but there must not be any attempt at an afternoon syringing for the present, and no sprinkling practised likely to cause a moist atmosphere at night, as the weather is not yet to be depended on, and a sudden severe frost occurring whilst the house is moist is very much more likely to prove disastrous to the crop than if the atmosphere is dry. Ventilate at 50°, not allowing an advance to 65° without full ventilation, and close at 50°, or before if there is a

prospect of frost at night. If water be necessary apply it sufficiently early in the day to allow of the surface becoming fairly dry before closing time.

CHERRY HOUSE.—Cherries are ripening rapidly, and the fruit must be kept dry, but keep the surface of the borders moist by damping with the syringe, air being admitted constantly, or condensation will seriously affect the fruit. Damping the border is calculated to mislead as regards its condition, which at this stage must be quite moist, therefore if necessary a thorough supply of water must be afforded without delay. Tie in the shoots as they lengthen, and stop those not required for training, at the fifth leaf. Black aphides can be kept under by dipping and rubbing the leaves or shoots in tobacco water. Ventilate freely on all favourable occasions, and when the external conditions are unfavourable recourse must be had to the heating apparatus to ensure a circulation of warm dry air. Netting will be necessary over the ventilators to prevent birds attacking the Cherries.

STRAWBERRIES IN POTS.—Moisture must not be lacking at the roots of these plants, as when the sun is powerful the fruits are apt to have the skin dried, and they do not swell well afterwards. After the fruit commences swelling a brisk moist atmosphere is essential to ensure good fruit, supplying liquid manure liberally until the fruit changes colour, when it must be discontinued, and watering lessened at the roots. Admit air freely whenever the weather is favourable, avoiding drying currents. Nothing is so advantageous as well thinning the fruits, especially of the large varieties such as Auguste Nicaise, Noble, President, James Veitch, Unser Fritz, Dr. Hogg, and British Queen, also those very handsome varieties Sir Joseph Paxton and Sir Charles Napier. La Grosse Sucrée also attains to a good size when well thinned, and it with Sir Harry are amongst the finest of Strawberries for forcing. A dish of Strawberries composed of a dozen to the pound of about even size is very much more taking in appearance than when the number is double for the weight. Fumigate if there be the least trace of aphides, but avoid doing so whilst the plants are in flower. Clear the plants from shelves in fruit houses directly the Strawberries are all gathered, as it is hardly possible to force them without their being infested with red spider. Water the plants twice a day, and in bright weather three times.

CUCUMBERS.—If aphides appear fumigate on a calm evening, and repeat early the following morning, having the foliage dry, but the floors well damped. On an attack of red spider remove the worst infested leaves, sponge the rest carefully with a weak solution (2 ozs. to the gallon) of softsoap, and keep the atmosphere charged with ammonia vapour by damping the floor in the evening with guano water, supplying the roots with the same about twice a week. The hot-water pipes may also be moderately coated with sulphur. If mildew appear dust with sulphur, but its fumes are more fatal to the fungus. Take care that the plants do not suffer through insufficient supplies of water, applying it at the same temperature as the bed. Plants that have been in bearing all the winter will now be showing signs of exhaustion. Remove them, and after thoroughly cleansing the house put in fresh soil and young plants without delay. Assist young plants which show signs of weakness by removing the staminate blossoms and the first fruits, stopping at every third or fourth joint, removing all weakly and surplus growths. Shading will be necessary for an hour or two in the middle of the day when the sun is hot, especially houses facing south, but shade early to prevent flagging. Houses with the roof lights facing east and west will not require shading. Little or no fire heat will be required by day, shutting the valves at about 8 A.M. and opening them again at about 5 P.M. Syringe the plants moderately between 3 and 4 P.M., keeping a good moisture all day by damping the floors.

Seed may be sown for raising plants to occupy pits and frames. A fair bottom heat should be secured by using the less decomposed material from Seakale, Vine borders, or exhausted hotbeds, which, with about a fourth of fresh material, will afford all the bottom heat now required. The nights lately have been cold, in which case close pits and frames as early in the afternoon as is safe, not allowing the temperature to exceed 90° to 95°, and afford good night coverings. See that a good bottom heat is maintained by duly renewing the linings.

THE KITCHEN GARDEN.

TOMATOES UNDER GLASS.—These have set better than might have been expected in such a cold sunless winter and spring, the earliest fruits ripening fast. Both young plants in pots and old ones planted out ought to be fed well at the roots, occasional top-dressings of turfy loam and good manure and frequent supplies of liquid manure being very beneficial to them. Pot plants that have produced a good crop of fruit are not worth retaining afterwards, young plants brought on to succeed them being much more profitable. Those planted out and allowed to spread either over roofs or sunny back walls can be kept in a fairly vigorous fruitful state for some time longer by simply cutting away old growths and bad foliage so as to let the young shoots have good room, the soil in the borders or beds being also renewed occasionally so as to sustain a brisk root action. The fruits obtained from old plants are rarely large and coarse, and suit the cooks all the better accordingly. Young plants put out in ridges or borders of any kind—and they succeed well in newly planted or partially furnished vineries and Peach houses—should have the soil made extra firm about the roots, and when once well established be kept somewhat on the dry side till a good crop of fruit is set, otherwise they are liable to grow too luxuriantly to be fruitful. If they flower moderately well and yet fail to set a crop, keep them still drier, flagging in sunshine doing more good than harm. As a rule all that is necessary to insure a heavy set is to go over the plants

every morning towards mid-day when the pollen is dry, and give them a smart tap to distribute it. Pinch out the strong central flower in each bunch, as this would inevitably be followed by a coarse fruit, and a timely removal of the flower greatly improves the size of the rest.

TOMATO DISEASE AND INSECT PESTS.—Tomatoes under glass are liable to be overrun by several diseases of a fungoid nature, the most destructive being the Cladisporiums. No cure has yet been found for the latter, but preventive measures meet with partial success, the plants affected producing a fairly heavy crop of fruit. Rank crowded growth and a moist heated atmosphere invite attacks; or at any rate, this treatment is most likely to be accompanied by disease, and by way of prevention give the plants good room and an extra firm root run. This, coupled with the maintenance of a dry atmosphere—a good circulation of dry warm air being kept up by means of the hot-water pipes whenever necessary, and the judicious admittance of both bottom and top air—will do much towards staving off the disease; and dressing the hot-water pipes with sulphur, mixed with milk or linseed oil to make it stick, will also have a beneficial effect. Applications of flowers of sulphur or mildew compositions to the foliage are of no avail. Occasionally the spread of disease has been stopped by closely and early removing all affected leaves or portions of leaves, and much may be done towards keeping up a supply of healthful foliage by leaving more young shoots on the plants than formerly. It is the usual practice to closely disbud all the main growths and single stems; but if, instead of pinching out all the side shoots as fast as they form, these were merely stopped at the first or second leaf, young leaves will be constantly coming on to take the place of the diseased old ones. The small white fly or Aleyrodes is the worst insect pest Tomato growers have to contend with; but this can be easily got rid of by sulphuring the pipes as advised for the disease. Whenever the house or the pipes become moderately hot the fumes from the sulphur bring down the flies, and a thorough clearance can be effected in that way without detriment to the crops.

VEGETABLE MARROWS.—It is a mistake to raise plants of these long before they can be planted, as they are certain to become weak and hard, and from which unsatisfactory state they are slow to recover. If the seed is sown now singly in 4-inch pots and placed in very gentle heat strong healthy plants will be available by the time wanted, or say the first week in June, and such will grow away rapidly. If early crops are required form a moderately large heap with partially exhausted heating material, such as leaves and manure, and rubbish of any kind, the whole slowly decaying and generating a gentle heat. On this place either frames or handlights, with a mound of light loamy soil under or in them, and plant the Vegetable Marrows as soon as they have well filled their pots with roots. Long White is the most generally popular variety, the small round fruited Pen-y-byd being a good companion for it.

GROWING VEGETABLE MARROWS IN MARKET GARDENS.—The market growers' method is more simple than the foregoing, and is usually attended with better results. When the roots have access to a great mass of decaying material the plants are apt to grow very rankly and to be shy bearing accordingly, a much-sheltered spot for the beds also tending in the same direction. Select a sunny, open position, mark out a bed 4 feet wide and of any length, throw out the best of the top soil on either side, fill the trench thus formed with moderately hot manure to a height of 2 feet, or rather less, and on this return the top soil. This being done now the seed may be sown in patches 3 feet apart through the centre, the seedlings being eventually thinned to three in each group, and allowed to spread unrestricted. If preferred plants can be raised under glass and turned out, needful protection from frosts being afforded by handlights, inverted flower pots, baskets, benders, and mats, or even branches of evergreens. This plan never fails in the more southern parts of the country.

GOURDS AND SQUASHES.—These are more ornamental than useful, but distributed about the kitchen garden, and either trained up pillars, over archways, or alongside the principal pathways, they attract a considerable amount of attention owing to the bright colours and the many quaint and curious forms of the fruit. The plants should be raised under glass as advised in the case of Vegetable Marrows, and ought to have two or three good spits of good manure under them when put out.

RIDGE CUCUMBERS.—These are a somewhat uncertain crop, and are not in great demand in most private places, the principal exceptions being where the small Gherkins are required for pickling purposes. Raise the plants now singly in 3-inch pots, and plant out during the first week in June either on beds or ridges prepared as for Vegetable Marrows. They are most liable to fail in cold sunless summers, and if exposed to strong winds they rarely do much good. Good protection from frosts ought also to be afforded at the outset.

THE BEE-KEEPER.

APIARIAN NOTES.

THE WEATHER.

WE are now enjoying more genial weather, although the day temperature has never reached higher than 60°. With the exception of two nights, when there was 2° of frost, the night temperature has been 12° higher than any time in April, but the

want of sunshine is against the bees, many still being chilled to death when returning from long flights.

SEVERING STORIFYING HIVES.

Very often the bees round and finish off their combs without attachments, but when it occurs insert the wire from the front, whether they be supers or divisions; if the latter, draw the mouth-piece, this will facilitate matters. With a knife or thin screwdriver pressed wedge-ways about an inch or less from the front separate the two divisions enough, but not more, to allow the wire to enter. Common copper bell wire is a good size, No. 16, as it does not run into the wood so readily as smaller sized wire. One piece of short wood is fastened at each end, which forms what we call a "twitch" as handles. When the wire is drawn back (by a sawing movement) to the screwdriver or turn-screw take the latter out and put it in front a little further than at first, and you will find the work easy, and much quicker done than it takes to write this. After the wire is half through the turn-screw may be pushed still further in.

FIXING FOUNDATION TO SUPER BARS.

The best method of fixing foundation to super bars is to have the bars grooved wide enough to admit the foundation easily without pressing. Then pour melted wax from a smelter on both sides, holding the bar at an angle so that the wax will flow freely to all parts the whole length of the foundation. Or take melted wax from a glue-pot with a teaspoon, and pour from it into the groove of the bar; the spoon to be kept immersed in the wax when not in the act of pouring, as if kept out the wax sets, and it is too cold to take a grip of the foundation. If the bars are more than one-eighth of an inch thick the above process is the best, but if only one-eighth it will be better to secure the foundation with a fastener of some sort.

I fasten mine by the aid of the honey presser, and a foundation fastener, consisting of a sole having a slotted gauge to guide the foundation to the centre of bar. The upper part is suspended on two kneed irons, and has a tooth wrought upon the front edge about one-eighth of an inch broad and a quarter of an inch deep. A piece of tin is fastened to the slotted gauge, which is the guide proper. The front edge of it is angled to catch the foundation, and as the upper jaw is balanced so that the back part is a little heavier than the front the jaw rises with the screw. The foundation is laid flat upon the bar or section, and the tin tongue guides it to the centre; then a quarter or half turn of the screw presses it firmly on and into the wood; then the foundation is turned against the face of the jaw to a right angle. The whole thing is performed in a few seconds. I have other fixers that are fastened to a bench, but the principle is the same, and are wrought by the hand. Foundation is sometimes fixed by dipping its edge into a shallow saucer of wax kept warm by a spirit lamp. When fixing foundation both it and the wood should be slightly heated. Then there is the plan of fixing by heating the edge on a hot plate, described and illustrated lately by "A Sussex Bee-keeper."

FORMING NUCLEI.

There is no better way of forming nuclei than in about ten days after the first swarm has issued from a stock hive to divide the combs, bees, and queen cells into as many nuclei as the bee-keeper thinks will be strong enough to work and defend itself from robbers. From six to eight make capital nuclei, although I have frequently formed twelve from a single stock, but it is much safer to have the lesser number. I use small boxes that hold four frames for the purpose. Every nucleus must have a queen cell, with all the bees adhering to the comb. The one that is kept upon the old stand will have most bees. Give it the fewest combs, and all small entrances, and fill the box with full-sheeted frames.

PREMATURE SWARMS.

The fine weather has brought the cuckoo, the swallow, land-rail, and absconding or "hunger swarms." It is only a few months since one of our contemporaries said that "the cause of these

swarms was unknown." I have repeatedly for many years past explained what was the cause of the majority of them. On the 5th of May I observed an unusual commotion amongst my bees, which I suspected absconding swarms to be the cause, but could not determine whether they might be from some of my own or from some other apiary. However, by the afternoon of that day I observed many killed bees at a number of my hives. The following day there were still more, and at one of them found a dead queen not belonging to any of mine, which I dissected, and as usual found the ovaries completely dried although healthy looking. There were only three or four young bees in the hive, and there can be no doubt but that in most cases of bees deserting their hive is due to effete queens. I have had others sent me, and every one shows signs of exhaustion or decay of the ovaries.

HEALTHY BEES WITHOUT POLLEN.

Lately in a previous article I showed the absurdity of writers asserting that bees required pollen in addition to honey to preserve them alive and vigorous during winter. I can now give further testimony refuting the argument. The hive that I referred to in that article has lost few bees, and are besides healthy. Other three sugar-fed hives, in a district where it was impossible for bees to get pollen, are in a similar prosperous condition; it is therefore simply absurd to say that bees, like some animals, require both nitrogenous and carbonaceous foods to keep them in health and strength. It may look well from a theoretical point of view, but it is not sound practically.

COMB-BUILDING.

It is quite desirable that beginners should know something about how bees build their combs, and for what purposes. Wax is a natural secretion, which oozes from the rings or joints of the abdomen in small scales, two coming from each joint, one from the right and the other from the left side, from at least four of them. After several weeks old every bee in the hive is capable of secreting wax, which goes on more or less for nine or ten months in the year, or from the time breeding commences in December till it stops in October, for in many cases bees breed so early and so late. It is used for comb-building, and in combination with pollen for sealing the brood cells, and by itself or in combination with propolis for stopping up crevices in the hive or contracting its doorway in autumn. The bees take the wax scales from their own bodies by the aid of their feet, but more often one bee yields it up to its neighbour, which may be witnessed in any hive. The bees manipulate these scales of wax between their mandibles, which by the aid of a secreted substance from the glands in their head the wax is softened and becomes pliable to the will and mandibles of the bee. It will thus be seen that new-made combs are not absolutely pure wax, but consist of something else which gives the combs more delicacy, and although greyish at first soon become beautifully white.

I should say the proportion of this unknown matter is about one to six of pure wax in some cases. It is much heavier and more brittle than wax, and cannot be made into foundation. It certainly consists of pure wax in certain proportions to the other material, and is most plentiful in the seals of the honeycomb. There is not so much of it to be found in brood comb, but in all pure honeycomb it is present. Wax from pure white super comb smells strongly of tallow, while that from brood combs has the odour of pollen and propolis. Pure wax of the former has been pronounced by some of our modern experts as a mixture of tallow and wax!

WORKER CELLS.

These are always built when a swarm is put into an empty hive having a young or fertile queen, until the combs exceed the size of the swarm. After that, if honey is coming in, drone combs are apt to be built, nor for the purpose of storing honey, as some writers say, but simply to work out Nature's plans, and preparing to swarm. Whenever the incoming of honey ceases drone combs are

no longer built, because, as a rule, bees will not swarm after that time.

If left to themselves a small swarm for convenience to themselves—brood rearing and honey storing—build their combs ram's horn fashion, storing their honey in the upper worker cells, showing plainly that drone cells are meant for a different purpose. The larger the swarm the straighter, and the more worker comb, but large or small drone combs are always built after the combs exceed the cluster of the bees. This is a point the beginner as well as the experienced bee-keeper has to attend to, full sheets of foundation help greatly to prevent an excess of drone combs. When bees eat away mouldy combs in spring they invariably build drone comb in their place. Queenless bees build drone comb, but cease to do so whenever they hear the sounds of a maturing queen in the cell.

It will be seen that although the queen is comparatively young and very fertile, the bees prepare to swarm after they have built combs in accordance with the initial strength of the swarm, and this natural propensity of bees is what the husbandman has to prevent. I have had swarms from after swarms, although the latter were located in hives of two and three divisions, but had only one filled; therefore, do not trust to bees not swarming because you have provided them with extra and timely room.

Always fill stock hives with worker combs at the end of the season, and take away all old combs from stock hives when there is no brood in them, which will be, as a rule, about three weeks after swarming. Bees store pollen not only for their own immediate wants, but for their prospective young, and every hive in a healthy condition never fails to have its supply. How foolish, then, is it to defer the renewing of combs till late in the year, destroying all the pollen intended for the good of the following year; equally foolish is it to remove pollen-laden combs. No doubt bees, as I have shown, live healthily without pollen, and do not require it but for brood-raising purposes. But bees with ample honey and pollen in their hive do not require to leave it in search for either during the chilling days of spring; consequently, such hives are the most forward in spring and the most profitable during summer.—A LANARKSHIRE BEE-KEEPER.

PATENT RIGHTS.—“A Hallamshire Bee-keeper,” referring to Mr. Samuel Ray's observations on page 375, says he has nothing to withdraw from his own statements on page 354, and he does not accept Mr. Ray's corrections. We cannot find space for the discussion of telephone patents in these columns.



* * All correspondence should be directed either to “THE EDITOR” or to “THE PUBLISHER.” Letters addressed to Dr. Hogg or members of the staff often remain unopened unavoidably. We request that no one will write privately to any of our correspondents, as doing so subjects them to unjustifiable trouble and expense.

Correspondents should not mix up on the same sheet questions relating to Gardening and those on Bee subjects, and should never send more than two or three questions at once. All articles intended for insertion should be written on one side of the paper only. We cannot reply to questions through the post, and we do not undertake to return rejected communications.

Address (H. H.).—The address you require is Mr. G. Steel, Heatherslaw, Cornhill-on-Tweed.

Boronias—Tuberoses (G. R. & P. H.).—Your letters not reaching us till Wednesday morning, cannot be satisfactorily answered this week.

Insects on Marguerites (W. P.).—They are similar to those which attack Celery, and these have been destroyed by dilute applications of petroleum in a solution of softsoap. This is all we can say in reply to your too late posted letter. The “samples” have not yet arrived.

Ne Plus Ultra Bean (F. S.).—Perhaps we cannot do better than inform you that a gardener who has grown Dwarf Kidney Beans for market for a number of years and tried many varieties, including Canadian Wonder, now relies wholly on Ne Plus Ultra, for the substantial reason that he has found it pays him the best.

Growing Peaches (S. J. A.).—We agree with the method of growing trees as bushes when it is properly carried out in structures well adapted to the purpose, not otherwise. In reply to your other question, if by an “ordinary” gardener you mean a casual jobbing gardener who has had little or no experience in growing fruit under glass, he would be as likely to fail as to succeed in Peach culture. The trellis system is the easiest for an inexperienced person to master (perhaps after a failure or two), and very profitable crops are grown on well-managed trained trees. Undoubtedly calcareous soil is good for Peaches, and the fruits grown by Mr. Rivers are finer and better flavoured than the others to which you refer.

Cucumbers at Prescot (H. W. G.).—Early in the season the Cucumbers are syringed twice daily, but as the season advances many of them are only syringed once. One of the largest growers practically uses a pump; one end is inserted in the wells, and the other, a 2-inch hose with a rose on, is used for syringing and watering at the same time. Very often the men are carrying out this work in the evening between seven and eight o'clock. Fire heat is used as long as it is thought necessary. The fires are discontinued as soon as the weather is sufficiently warm to avoid checking the growth of the plants. Even under “the express system” of culture it is not wise to maintain a too low temperature at night.

Camellias Planted Out in Conservatory (C.).—There is nothing better for Camellias than a surface dressing of cow manure or sheep droppings about an inch thick, watering thoroughly once or twice a week. No plant can receive sufficient moisture at the roots by syringing alone, which often makes the surface soil wet, whilst that beneath is far too dry for healthy vegetation. The manure assists the growth, and in plenty of light buds are set freely. Soot is a first-class manure. Place a peck in an old bag with sixty gallons of water; poke well up daily, using the clear liquid. Cow manure, 1 peck to twenty gallons of water, or 1 peck of horse manure to the same quantity of water, makes capital liquid manure for Camellias, as also will 1 peck of sheep manure to thirty gallons of water. Apply once or twice a week.

Artificial Manure for Roses (Kittie).—Superphosphate of lime is perhaps the best manure for Roses, applying it at the rate of 1 oz. to a gallon of water. Nitrate of potash is excellent, using at the rate of 1 oz. to 4 gallon of water. Sulphate of ammonia is also first-rate; dissolving 1 oz. in 4 gallons of water. These small quantities are better than larger supplies, and all are best varied—that is, given at different times, say at alternate waterings, but not oftener than once a week. If you prefer to use all together take 12 ozs. superphosphate, 4 ozs. nitrate of potash (saltpetre) powdered; mix thoroughly. Employ 1 oz. to a gallon of water, and apply once or twice a week. Sulphate of ammonia and nitrate of soda may be given occasionally, quarter of an ounce per gallon is better than half an ounce, because safer—*i. e.*, less danger of injuring the tender rootlets, but unless extra vigour is wanted they should be omitted. Kaolin has manurial value through its being derived from the felspar rocks, and is essentially a hydrated aluminic silicate, with variable quantities of magnesia, lime, and oxide of iron, but in kaolin the potash has been abstracted, therefore its value is infinitesimal as a manure, and may be passed.

The Early Red Rhubarb (N. H. Pownall).—The Yaxley Vicar is wholly in error. No official of the Royal Horticultural Society has written a word about this variety of Rhubarb as grown at Yaxley, in this Journal. You are the best judge on the point of identity, as you had crowns from Yaxley and from Chiswick, and after growing both this is your verdict:—“I am obliged to say they are to me identical in length of stem, in the flutings on the convex side of the stem, and in the colour—top half greenish and the lower half pinky—of the concave side of the stem. They are alike, too, in their tendency to throw up flower stems.” That is a very precise description, and settles the matter conclusively against the alleged distinctness of the Yaxley Rhubarb, and it would be wrong for anyone to sell that old Rhubarb under a new name. The letter which Mr. Sewell has sent to you to “make any use you please of” is no answer to our statements last week, and is remarkable mainly for a totally groundless assumption, and the consequent singular imputation on the capacity of a gentleman whose experience in growing and comparing different varieties of Rhubarb is not excelled, if equalled by any other person in the kingdom. We regret to hear of your indisposition, and shall return to the subject of Rhubarb again.

Northern Spy (T. W.).—The Apple you refer to is described in the “Fruit Manual” as follows:—Fruit, fragrant when ripe, large, ovate, inclining sometimes to conical. Skin, thin, at first of a greenish yellow on the shaded side, and on the side next the sun covered entirely with a thin, pale crimson cheek, which is covered with broken streaks of a darker crimson; but as the fruit acquires maturity after being kept, the shaded side changes to a rich golden yellow, and the crimson becomes brilliant. The whole is covered with a thin bloom like a Grape. Eye, small and closed, set in a very deep, narrow, and furrowed cavity. Stamens, marginal; tube, long, funnel-shaped. Stalk, three-quarters of an inch long, slender, deeply inserted in a wide hollow. Flesh, white, very tender, fine-grained, crisp, and very juicy. Juice, sprightly, sweet, and with a fine delicate aroma. Cells, ovate; abaxile. A valuable dessert Apple; in use from December till May. The tree is a fast and vigorous grower, and has an upright habit. When it acquires a little

age it is an abundant bearer; but it is apt to become bushy headed, and therefore requires frequent attention to keep the head open and free of spray. This excellent Apple originated about the year 1840 in the State of New York, on the farm of Oliver Chapin, of Bloomfield, near Rochester. It belongs to the Spitzenburgh race, and bears some resemblance to the Esopus Spitzenburgh. Gradually it became a favourite among American orchardists, and in 1843 we find it one of the sorts which were recommended "for trial" at one of the pomological conventions. In 1847 the fruit was sold in New York at twelve and a half cents each.

Renovating Pitcher Plants (S. S.).—Nepenthes that have grown tall and ceased to pitcher freely should be cut down to within 4 or 5 inches of the base. If done at once they will soon break into growth, and before the season is over it will be well furnished and pitcher freely during the autumn and winter. It is a mistake to allow these plants to run up until they become pitcherless, for if pinched from time to time when growth has been made a few inches long they will continue growing and pitching for years without being cut back. By this means a regular supply of pitchers is secured the whole year round, and large specimen plants are the result. Plants grown on the pinching system, or young ones that need larger baskets, should be placed in them at once. The whole of the old ball must be carefully lifted out of the one in which it is growing and placed into the larger one without disturbing the roots. Previous to this the baskets should be liberally drained and a layer of the compost placed at the base; the remaining space should be filled with peat fibre and charcoal, and the surface covered with a layer of sphagnum moss in a living state. These plants will grow well in loam, charcoal and sand, sphagnum moss and peat in equal proportions, but after trying these and other mixtures the one advised above is preferred for its lasting qualities. These plants should be liberally syringed and never allowed to suffer by an insufficient supply of water. If necessary to increase the stock of these plants the stems from those cut down should be cut into lengths, two joints for each cutting being sufficient. Insert these singly in 3-inch pots filled with sphagnum moss and a little coarse sand for the base of the cutting to rest upon. The top of the cutting only should be left out of the moss, then watered and plunged in brisk heat and covered with a handlight. It is necessary to keep them airtight until they are rooted. The stems cut into lengths root freely, but the greatest difficulty will be experienced in hardening them to bear full exposure in the atmosphere of the house in which they are to be grown.

The Propagation of Herbaceous Phloxes (J. J. B.).—The present is a good time for the propagation of these Phloxes, and a good place in which to strike the cuttings is a dung frame. If freely supplied with water the cuttings will emit roots in a fortnight or three weeks, when the plants may be potted singly. After having fairly rooted into the new soil may be transferred to a cold frame, and eventually planted out. The most suitable cuttings which it is possible to have are those young shoots, which at this season are being produced in quantity. Select these when 3 or 4 inches long, and insert in sandy well drained soil, either in pots or boxes. The cuttings of these Phloxes need so little preparation that they may be inserted almost as removed from the stock plant, for they root freely not only from the joint but up the stem between the joints, so that if the lower are removed the operator will have done all that is requisite. They thoroughly enjoy generous treatment, and if they have abundance of water during dry weather the result will be a rich and varied display in the coming autumn of their massive heads of flowers. Like the Chrysanthemum, they should never receive a check. Few plants are more effective when well grown, and none so miserable when neglected. Another point of importance with these plants is to make new plants annually, and discard all stools at four years old, as by this time they will have impoverished the soil, and will have become a thicket of young and weakly shoots. In planting dig deeply, apply manure freely, and plant somewhat deeper than usual with most plants, on account of their making a great quantity of surface roots. If they can be given a position where they may be saturated two or three times weekly so much the better. The following are useful varieties:—Whites: Jeanne d'Arc, Independence, Queen of Whites, Virgo Marie, Thos. Chisholm. Of mauve or lilac shades, Hendersoni and Mauve Queen are good; vermilion scarlet, Coccinea; purple, Purple King and Pius Ninth; salmon red, A. F. Barron, Lothair, Roi des Roses, and Louis Van Houtte. Of whites with coloured centres; Edith, David Syme, Richard Wallace, Jenny Grieve, Madame la Comtesse de Turenne are among the best; while from crimson we would take Madame Verschaffelt, Gloire de Neuilly, Countess of Bredalbanc, and Splendour; and apart from these there are numbers of intermediate and varying shades.

Names of Plants.—We only undertake to name species of plants, not varieties that have originated from seed and termed florists' flowers. Flowering specimens are necessary of flowering plants, and Fern fronds should bear spores. Specimens should arrive in a fresh state in firm boxes. Slightly damp moss, soft green grass or leaves form the best packing, dry wool the worst. Not more than six specimens can be named at once, and the numbers should be visible without untying the ligatures, it being often difficult to separate them when the paper is damp. (A. R.).—The Daffodil flowers you have sent can only be accurately named by actual comparison with others flowering in a large collection, and if the vendor of the bulbs is a grower of the flowers he would oblige you in the matter. (G. D. B.).—It is one of the natural hybrid Odontoglossums. Send another flower. (Ignorant).—No numbers were attached to your specimens. The white flower is Saxifraga granulata

fl. pl. The Dendrobium is lituiflorum. The Fern is Adiantum pedatum. The other is not sufficient for identification. (Inquirer).—1, Megasea cordifolia; 2, Primula denticulata; 3, Doronicum plantagineum; 4, Withered; 5, Leucium æstivum; 6, Doronicum austriacum. (Farnborough).—1, Orobus vernus; 2, Scilla nutans; 3, Adonis vernalis; 4, Spiræa Filipendula; 5, Ranunculus aconitifolius; 6, Ranunculus amplexicaulis. Some of the numbers were partially displaced. (W. W.).—1, Polygonum cuspidatum; 2, Ranunculus aconitifolius fl.-pl.; 3, Piptanthus nepalensis; 4, Saxifraga ceratophylla; 5, Tiarella cordifolia. (B.).—We cannot undertake to name the flowers sent. Consult some tradesman or amateur who grows collections of varieties.

TRADE CATALOGUES RECEIVED.

John Laing & Sons, Forest Hill, S.E.—Catalogue of Tuberos Begonias.
G. Phippen, Reading.—Bedding Plants and Dahlias.
L'Horticulture Internationale, Leopold Park, Brussels.—Catalogue of Orchids for 1891.

COVENT GARDEN MARKET.—MAY 13TH.

MARKET well supplied with all classes of goods. Prices generally lower.

FRUIT.			
	s.	d.	s. d.
Apples, ½ sieve	1	6	to 6 0
Nova Scotia and			
Canada, per barrel	15	0	26 0
Tasmanian, case	6	0	12 0
Grapes, New, per lb. ..	2	6	4 0
Kentish Cobs	40	0	to 50 0
Lemons, case	15	0	20 0
Oranges, per 100	4	0	9 0
St. Michael Pines, each..	3	0	8 0
Strawberries, per lb. ..	1	6	5 0
VEGETABLES.			
	s.	d.	s. d.
Artichokes, dozen	0	0	to 0 0
Beans, Kidney, per lb. ..	0	9	1 0
Beet, Red, dozen	1	0	0 0
Brussels Sprouts, ½ sieve	3	0	4 0
Cabbage, dozen	3	0	0 0
Carrots, bunch	0	4	0 0
Cauliflowers, dozen	3	0	6 0
Celery, bundle	1	0	1 3
Coleworts, doz. bunches	2	0	4 0
Cucumbers, doz.	3	0	5 0
Endive, dozen	1	0	0 0
Herbs, bunch	0	2	0 0
Leeks, bunch	0	2	0 0
Lettuce, dozen	8	0	3 6
Mushrooms, punnet	1	6	to 2 0
Mustard & Cress, punnet	0	2	0 0
Onions, bushel	3	0	4 0
Parsley, dozen bunches	2	0	3 0
Parsnips, dozen	1	0	0 0
Potatoes, per cwt.	8	0	4 0
Rhubarb, bundle	0	2	0 3
Salsafy, bundle	1	0	1 6
Scorzoner, bundle	1	6	0 0
Seakale, per bkt.	1	0	1 6
Shallots, per lb.	0	2	0 0
Spinach, bushel	5	0	6 0
Tomatoes, per lb.	1	6	2 0
Turnips, bunch	0	0	0 4

AVERAGE WHOLESALE PRICES.

CUT FLOWERS.			
	s.	d.	s. d.
Arum Lilies, 12 blooms ..	2	0	to 4 0
Azalea doz. sprays	0	6	0 9
Bouvardias, bunch	0	9	1 0
Camellia, white, per doz.	2	0	4 0
" red	0	9	1 6
Carnations, 12 blooms ..	1	0	2 0
Cyclamen, doz. blooms ..	0	3	0 6
Daffodils, doz. bunches ..	2	0	6 0
Eucharis, dozen	3	0	6 0
Gardenias, per doz.	1	0	3 0
Hyacinths doz. sprays ..	3	0	4 0
" (Fench) doz. bunches	12	0	15 0
" (Dutch) in boxes ..	1	0	3 0
Lapageria, 12 blooms ..	2	0	4 0
Lilac (French) per bunch	5	0	6 0
Lilium longiflorum, 12			
blooms	3	0	4 0
Lily of the Valley, dozen			
sprays	0	6	1 0
Maidenhair Fern, dozen			
bunches	4	0	9 0
Marguerites, 12 bunches	4	0	6 0
Mignonette, 12 bunches..	3	0	to 6 0
Mimosa (French), per			
bunch	1	3	1 6
Narciss (Various) dozen			
bunches, French	2	0	4 0
Pelargoniums, 12 trusses	6	0	9 0
" scarlet, 12 bnchs	4	0	6 0
Primula (double) 12 sprays	0	6	1 0
Primroses, dozen bunches	0	4	0 9
Roses (indoor), dozen ..	0	6	1 6
" Red (English) per			
dozen blooms	2	0	4 0
" Red, 12 bls. (Fench.)	2	0	4 0
" Tea, white, dozen..	1	0	3 0
" Yellow, dozen	2	0	4 0
Spiræa, per bunch	0	6	0 9
Tuberose, 12 blooms	1	0	1 6
Tulips, per dozen	0	4	0 6
Violets (Parme), per bch.	3	0	4 0
" (dark), per bch. ..	2	9	3 0
" (English), doz. bnch	0	6	1 0
Wallflower, doz. bunches	1	6	2 6

PLANTS IN POTS.

	s.	d.	s. d.
Aralia Sieboldi, dozen ..	6	0	to 18 0
Arbor Vitæ (golden) doz.	6	0	8 0
Arum Lilies, per doz. ..	9	0	12 0
Azalea, per plant	2	0	3 6
Cineraria, per doz.	6	0	9 0
Cyclamens, per doz.	9	0	18 0
Deutzia, per doz.	6	0	8 0
Dielytra spectabilis, per			
dozen	8	0	12 0
Dracæna terminalis, doz.	24	0	42 0
" viridis, dozen	12	0	24 0
Erica, various, dozen	12	0	18 0
Enonymus, var., dozen ..	6	0	18 0
Evergreens, in var., dozen	6	0	24 0
Fairy Roses, per doz. ..	9	0	12 0
Ferns, in variety, dozen..	4	0	18 0
Ficus elastica, each	1	6	7 0
Foliage plants, var., each	2	0	to 10 0
Genista, per doz.	6	0	9 0
Hyacinths, doz. pots ..	5	0	8 0
Hydrangea, per doz.	9	0	12 0
Lilium longiflorum, per			
dozen	18	0	30 0
Lily of the Valley, per pot	1	0	2 0
Marguerite Daisy, dozen	6	0	12 0
Mignonette, per dozen ..	6	0	10 0
Myrtles, dozen	6	0	12 0
Palms, in var., each	2	6	21 0
Pelargoniums, per doz. ..	12	0	18 0
Pelargoniums, scarlet, per			
dozen	6	0	9 0
Primula sinensis, per doz.	4	0	6 0
Spiræa, per doz.	8	0	12 0
Tulips, dozen pots	6	0	8 0

Bedding plants (in variety) in boxes, from 1s. to 3s.; in pots, per doz., 1s. to 2s.



THE DAIRY.

BEFORE all things the home farm should afford a full supply of home-grown or home-made farm produce for household re-

quirements. To the venison of the park, the fish of the lake and streams, the game of the woods, it adds all sorts of poultry—chickens, ducks, geese, turkeys, guinea fowls and pigeons, with eggs, pork, bacon, hams, lard and flour; also hay, corn, straw, Carrots, and green fodder for carriage and riding horses, and though last, perhaps the most important of all, dairy produce of the highest quality.

There can be no good reason why delicious butter and cheese should not always be forthcoming. Butter of a certain quality there is always, but a cheese supply would be a new departure, and yet it ought not to be so. Take, for example, that king of cheeses, the Stilton, what is there in Leicestershire pasture or cows that confers any special advantage upon the Midland dairies? Both Stilton and Cheddar cheeses of excellent quality are now made at Canadian farms, and a large quantity of Canadian Cheddar is sent to England, which goes to show how possible it is for really good cheese to be made at any farm, and we certainly fail to see why a certain quantity of really superior cheese should not be made at the home farm. At one time, with the very limited knowledge of the process of cheese-making possessed by the ordinary farmer, such a proposal would have been rash in the extreme. But now, with dairy education constantly improving, the idea is both reasonable and practicable. It was owing to ignorance that cheese made at farms away from cheese-making districts was so frequently a hard indigestible substance, decidedly as unpalatable as unwholesome. There is now no excuse for such failures, for we have creamometers wherewith to gauge the quality of the milk, and we know how rich milk requires more rennet than poor milk; that the rennet must be quite pure, and the milk be set with it at a temperature of 80° immediately after the milking. We know how to avoid lactic ferment, how to salt, to press or otherwise, and the time and process of ripening.

Butter making, too, is now not a thing of chance and guess work, but an exact science. Every detail of it is done with a degree of precision and certainty that quite precludes any possibility of failure. No doubt there has been a considerable degree of difficulty in changing from the old way of butter making with its attendant uncertainty to the new system with its precise method and perfect results. In doing this due heed has not always been given to the difference between old and new dairy utensils. The new churns are advisedly made without revolving dashers, the old ones have them, and in many a dairy where they are still used the risk remains of breaking up the butter grains into a mingled mass of butter and buttermilk, which when so mixed cannot be separated, and the butter is spoiled. This is precisely what has happened thousands of times in bygone days, and the puzzled dairymaids have wondered again and again at a failure of which they did not know the cause, and were consequently at a loss for the remedy.

It is a fixed rule in the new order of things that churning shall cease at once when the butter grains appear, that the grains shall then be washed in the churn till not the slightest trace of buttermilk is perceptible, and then the butter is ready for the butterworker. Now to obtain this result with an old churn having revolving dashers, it must be turned slowly at the rate of not more than thirty-five times in a minute to avoid breaking the butter grains. Careful attention to this enables one to make as good butter with an old churn as with a new one, and to avoid that tantalising result, butter discoloured by streaks of buttermilk.

We are now taught that in order to have potted butter quite good when made, and to ensure keeping it in perfect condition for a year, or longer if necessary, it must have the casein or buttermilk entirely separated from it—just that and nothing more, only to pot it and keep it covered by brine, which is changed for fresh brine weekly. The old idea was that in order to keep butter in crocks or pans it must be well salted; the new one is that salt in

the butter is altogether unnecessary. We have only to take all due precaution before and during the churning, then to wash well, work well, pot carefully, and cover with water or brine, to ensure a supply of really excellent, high coloured, and richly flavoured summer butter at Christmas. Who would not have such a household boon as this? That full advantage will be taken of this important fact at home farms when its full significance is grasped we doubt not, and where salting as a matter of taste is preferred let it be done with brine or liquid salt, and never with the crude salt. One word more, and that is never pot butter made from the milk of "stale" cows, but rather from the milk of cows in full milk—say a month or so after calving.

WORK ON THE HOME FARM.

The weather has continued most favourable for the corn-hoeing, and the land generally was never better in hand than now. Everything has contributed to this satisfactory state of things since last harvest. An autumn so favourable for tillage that not only was it possible to get through most of the ploughing, but also the cleaning of the land, and the subsequent ridging with the double-breasted plough of all of it not required for winter corn, left it in the best possible condition to derive full benefit from the great frost, which began on November 25th, and continued till January 22nd, or for fifty-nine days. Never did we see even the heaviest soil more delightfully pulverised, and seed beds of a fine deep tilth have been the result. The remarkable dryness of February enabled us to get the spring corn in exceptionally early, and to have the land in readiness for the earlier root crops before the great snowstorm of the second week in March. Early sown Barley should be plentiful enough this year, and consequently big crops of it may be expected from really fertile land.

But there is a per contra to all this in a long hard winter and a late spring. Never were the resources of flock masters and graziers generally put to a more severe test. To them the fine weather and drought of last autumn proved a positive source of evil, so seriously did it check the growth of pasture. Short commons has been the order of things for months past on many a farm, and much stock will go upon the pastures this month in low condition. All this serves to impart force to our teaching, that pasture cultivation is a necessity and an advantage. It is precisely poverty stricken pasture that first suffers from drought, and that is always most backward in spring growth. Store it with fertility, and not only will there be an abundant of early and late feed upon it, but summer growth in plenty to spare for silage and hay. Less roots and more silage is what we require to enable us to be safe in a long hard winter. But we cannot have the silage without cultivation. With it our store of winter food should be so abundant as to render us practically independent of the weather. To any of our readers who intend beginning making silage this season we say, If you would have perfect success, let your stacks be large and the pressure thorough and persistent.

OUR LETTER BOX.

Manures (H. W. G.).—One cwt. mineral superphosphate contains 30 lbs. soluble phosphate, and the same quantity of bone superphosphate contains 40 lbs. soluble phosphate. No doubt the sulphate of lime is available as you suggest, but soil deficient in lime should have occasional dressings of caustic lime. Muriate of potash, 80 per cent. basis, contains 41.9 per cent. of potassium, hence its superiority to kainit, 24.9 per cent. basis.

METEOROLOGICAL OBSERVATIONS.

CAMDEN SQUARE, LONDON.

Lat. 51° 32' 40" N.; Long. 0° 8' 0" W.; Altitude, 111 feet.

DATE.	9 A.M.					IN THE DAY.				Rain	
	Barometer at 325 and Sea Level.	Hygrometer.		Direction of Wind.	Temp. of soil at 1 foot.	Shade Temperature.		Radiation Temperature.			
		Dry.	Wet.			Max.	Min.	In sun.	On grass		
1891.											
May.											
Sunday	3	29.947	48.9	44.3	W.	47.8	58.7	35.3	102.7	29.2	—
Monday	4	29.993	53.4	48.9	W.	47.9	61.1	41.9	103.9	35.7	—
Tuesday	5	30.182	51.6	47.7	E.	48.9	60.9	47.6	101.9	45.2	—
Wednesday ..	6	30.129	46.9	44.9	N.	49.4	67.1	37.8	110.1	31.9	—
Thursday	7	29.970	58.3	49.4	N.N.	50.4	67.9	45.4	110.1	40.4	0.020
Friday	8	29.592	52.4	49.7	S.S.	52.2	61.8	46.0	81.1	38.8	—
Saturday	9	29.758	52.2	49.2	N.	51.4	59.2	44.7	96.0	39.4	0.010
		29.939	52.0	47.7		49.7	62.4	42.7	100.7	37.2	0.030

REMARKS.

- 3rd.—Brilliant morning, occasional cloud in afternoon and evening.
 4th.—Brilliant till 11 A.M., but not much sun after.
 5th.—Overcast till 10 A.M., then bright.
 6th.—Bright from 11 A.M. to 3 P.M., overcast before and after.
 7th.—Bright and warm throughout.
 8th.—Overcast and gloomy, with occasional drizzle in the morning; fine, with occasional sun in afternoon.
 9th.—Fair, with occasional sunshine in morning.
 Fine spring week, temperature just about the average.—G. J. SYMONS.



MIGNONETTE AS STANDARDS

TO some persons it may appear a waste of time to cultivate Mignonette as I am about to describe, but in no other way can so many fine spikes be produced on a plant. From two hundred to three hundred highly fragrant spikes of flowers can be had on a specimen, many of them measuring 6 inches long and more. In addition to the advantage of being able to cut abundance of Mignonette during the months of February, March, and April for filling vases for room decoration, what could be more pleasing than half a dozen such plants in the conservatory at that time of the year? In private gardens I do not think Mignonette for winter and early spring flowering is as much cultivated as its merits deserve. The perfume seems more powerful than from the plants growing out of doors during the summer months, and the cultural details are simple.

We only grow one variety—Miles' Spiral. The growth is strong, easily trained, and the flower spikes stand erect without support. I have had many 12 and 15 inches long after removing the first few seed pods at the base of the flower spike. This variety also carries good foliage, which is essential to the good appearance of the plants. I used to grow Parson's Tree Mignonette, which is exceedingly free, but the spikes are too small. Machet is not suited for this form of training owing to its dwarf and stiff habit. Golden Queen grows very well as a standard, but the colour is somewhat dingy and not appreciated. Garraway's White is suitable for training in standard form, but after trying all the sorts named I find Miles' strain the best.

We endeavour to sow the seed as near as possible to the 24th of May, not that a day or two makes much difference, but having had invariable success we keep as close to that date as we can. Some persons assert that Mignonette will not transplant readily, but that is a mistake; some of the best plants we ever had were dug from the open ground and potted when an inch high, but the following is the usual method adopted. A sufficient number of clean 2½-inch pots are prepared by placing a few crocks at the bottom, then three parts filling with loam, leaf mould, and sand in equal portions. In each pot four good seeds are sown, covering them with fine soil, which if moist when used does away with the necessity of applying water for a few days afterwards. The pots are stood on damp ashes in a cold frame on the north side of a wall. The soil in the pots is not allowed to become dry, but is moistened occasionally and the inside of the frame also. Directly the seedlings appear soot is scattered among the pots to preserve the succulent leaves from slugs. When the plants are large enough to handle all are removed but one in each pot, but should there be vacancies in some pots the strongest plants in others are left for a few days longer and potted separately, to make up the requisite number. The space left at the top of the pot at sowing is then filled with similar soil, which maintains the plants in an upright form, tender seedlings being liable to grow crooked.

To obtain free and healthy growth the plants must not be kept in the small pots too long, or the roots will become matted together, which checks the growth—a circumstance to be rigidly avoided. The plants are shifted into 4-inch pots, using the same kind of soil as before, but with less sand in it. A small stake is placed to each plant, to which the growth is secured as it progresses. This is important, as crooked stems have not a good appearance. The

plants are returned to the frame, and kept there until the end of August, when they are assigned a more sunny position. The frame is kept rather close for a few days after repotting till the roots take hold of the new soil, then air is admitted freely day and night. The foliage is thoroughly syringed in the evenings of hot days, also the inside of the frame, to create a moist genial atmosphere, which promotes free growth. If the plants are allowed to become dry at the roots two or three times red spider attacks the under side of the foliage, and if not quickly washed off with clean water ruins the plants. A steady uninterrupted growth is absolutely essential to success. Sometimes before the desired length of stem—18 inches or 2 feet—is obtained flower buds form at the point, and side growths push from the joints below. The terminal bud and all side shoots but the strongest near the point are promptly removed and the shoots trained upwards until the necessary height is attained. The growth is then topped for the production of side branches, which are required to form the basis of the future head.

The plants are shifted from the 4-inch into 7-inch pots, and subsequently into others 10 inches across, in which they flower. Some few plants may have pots 2 inches smaller, but those in the largest size give the best results. The compost for the final potting consists of three parts fibry loam, one of leaf mould not too much decayed, and little of the materials from a spent Mushroom bed, with a free addition of coarse silver sand if the loam is inclined to be heavy. The pots are well drained, as the roots of Mignonette are impatient of stagnant moisture during the winter, when they often do not require watering for four or six days at a time. A space of at least 1½ inch is left at the top of the pot to allow for future top-dressings. Turfy loam, with the fine soil taken out, and Thomson's Vine manure in equal parts spread over the surface of the soil a quarter inch thick forms an excellent rooting medium, giving a deep green to the foliage and massiveness to the flower spikes. The top-dressings are repeated at intervals of a month, commencing about Christmas.

It is most important that sound judgment be exercised in watering the plants during the whole period of growth. If too much water is given even in summer the leaves assume a sickly hue, while if the supply is insufficient the stems harden, and red spider takes possession of the leaves. But it is during the dull days of winter that extra care is needed, especially after the plants are placed in their largest pots, and time should be allowed for the roots to take hold of the new soil before much water is given. When these pots are full of roots or nearly so weak clear liquid made from cow or sheep manure with a small quantity of soot added is of immense advantage if applied every third time water is needed.

The best position for the plants from the middle of September is close to the glass in a greenhouse where the temperature does not fall below 45°, nor rise more than 10° above that. Abundance of air is afforded on all favourable occasions. Syringing is discontinued after the plants are housed, except in unusually hot weather, when an occasional sprinkling is beneficial, keeping the plants cool and evading attacks of red spider.

For forming the heads we employ galvanised wire trellises, which are easily made, umbrella shape, 15 to 18 inches in diameter and about 1 foot high. A stout stake is thrust into the soil near the middle of the pot, to which the trellis is made secure on the top. Over this the shoots are trained as they grow, pinching out the points wherever a bloom appears and also to increase the number of shoots. When the trellis is covered is the time to think about a supply of flowers. At the last time of topping all the growths are done at once, so as to have the spikes in the same stage of development. The plants when in bloom present a surface of evenly disposed foliage and uniform spikes; they are suitable for either conservatory or room decoration, and last a long time in perfection if supplied freely with water and receive a fair amount

of light. Not only do the plants remain longer in flower but the spikes increase in length if the seed pods are removed from the base as the flowers fade, and a little time thus spent is certainly not wasted.—PRACTICAL.

[Our correspondent sent us in March robust spikes of Mignonette upwards of 6 inches in length and highly fragrant; they extended to a foot in length in water, in which they remained for three weeks, the stems in the water being divested of leaves.]

FIG TREES CASTING THEIR FRUIT.

THIS is of common occurrence, usually happening with the "first crop" of Figs. Failure of first crop Figs seems to prevail in all countries, hence the "caprification" performed by the ancients upon Figs, with the view of hastening their maturity. It is an eastern horticultural operation, said to be still practised in some districts of the Levant, in many parts of Italy, Spain, and other countries, but the process is "dying out," because in all countries where Figs grow they are obtained in perfection without the aid of branches of the wild Fig. Caprification consists in suspending by threads above the cultivated Figs branches of the wild Fig covered with an insect, stated to be a species of cynips. These small insects coming out of the fruits of the wild Fig spread themselves over the cultivated tree, penetrate the eye of the fruit, and having contracted pollen from the wild Fig carry it into the fruit of the cultivated Fig. That the cynips piercing the eye of the fruit hastens ripening is not questioned, indeed similar result attends the pricking of the eye with a needle, straw, or quill dipped in olive oil, or dropping a little "spirit" in the eye, and it may just as well be stated that punctures of insects, particularly in or near the eye of the ordinary orchard fruits, hasten their ripening.

Casting the fruit is undoubtedly due to the non-setting of the flowers, but all fruits that fall invariably turn yellow at the eye, giving indications of premature ripening before it is cast. This is a characteristic of all fruits failing to perfect the seed, pip, or stone, but the Fig differs from those in the flowering not taking place until the fruit is considerably advanced in size, and is analogous (in stage) to the stoning of stone fruits, with the difference that when fertilisation of the Fig flowers is effected the fruit at once commences its last swelling, or concentrates the vital forces on the perfection of the seeds, and on which depends the ripening of the fruit. The flowers of the Fig, as everybody knows, are monœcious—that is, male and female separate in the same fruit, inserted upon the interior surface of the fruit or fleshy receptacle, the upper part consisting of male and the lower or greater part female. The tip of the fruit is marked by an eye or orifice, and closed with small scales. This orifice never opens in the case of cast fruits, and the caprification before alluded to is never performed on "second crop" Figs. Indeed the flowers invariably attain such development as to open the "eye" when fertilisation is effected without the aid of cynips. Therefore aids to fertilisation are, as regards Figs grown in this country, "an absolutely useless waste of time." Besides "first crop" Figs were cast "untimely" 2000 years ago in the home of the Fig as in those lands to which it has been introduced, and that whether cultivated in the open ground or under glass. There are instances of "barren Fig trees" which persist in "dropping their untimely Figs" year after year, especially during their youth, in Asia, Africa, Europe, the Americas, and Australias. Therefore the question of Fig trees casting their fruit without ripening becomes subject to variety, locality, or cultural conditions.

How much is due to variety may be gleaned from an able paper by Mr. A. F. Barron, "On Figs and their Culture at Chiswick," in the Journal of the Royal Horticultural Society, vol. xiii., page 122. Out of sixty-six varieties, "for the most part collected by Dr. Hogg in the South of France," grown in the Society's gardens at Chiswick, which Mr. Barron terms the "largest and finest collection of Figs that is to be found in this country," only five varieties were found worthy of commendation as "varieties which bear both first and second crops." "This is a very important quality," states Mr. Barron, and every grower of Figs will agree with him, because the "first crop," particularly in early forcing, is of very much greater importance than the "second crop" Figs. The varieties named by Mr. Barron as producing first and second crops are "White Marseilles, De la Madeleine, Trifer, Brown Turkey, and Brunswick." It is always pleasing to have one's own practice confirmed by those in authority. I do not know De la Madeleine and Trifer, and cannot find the former described or even named in the "varieties of Figs" enumerated. This is unfortunate, and in turning to other sources for information I find no De la Madeleine

in any list except Messrs. Thomas Rivers & Son, in which it is given as "Angelique or Madaleine; medium size, pale greenish yellow, flesh rose coloured, not very rich, but really good, forces well and bears abundantly." This cannot be the Angelique Noire of Chiswick—viz., "fruit below medium size, roundish or oblate; skin dark, flesh bright red, rich; strong grower and moderate cropper." Madeleine in Dr. Hogg's Fruit Manual, fourth edition, is stated to be synonymous with Angelique, and the description corresponds with that given by Mr. Rivers. Angelique I have known over thirty years, and found it "force well and bear abundantly." "Trifer: Fruit medium size, pyriform, skin pale green, flesh pale, thin, and watery, not rich; very early, and a sure cropper." Except in form, it is difficult to discern the difference between Dr. Hogg's and Mr. Rivers's Angelique and Trifer.

Of the other three named by Mr. Barron, Brunswick may be described as the finest of outdoor Figs, where it can be given plenty of room, but I am surprised to see it named by Mr. Barron as bearing first and second crops, particularly after stating that "In this country it is only the 'first crop' varieties which come to maturity in the open air, the season of summer warmth being too short to do more; but under glass excellent crops both of the 'first' and 'second crop' Figs may be obtained where suitable varieties are grown." Only once have I seen the second crop Figs pass the winter safely (and that under a thick thatch of straw after bundling), and then only a few fruits ripened in June. That was in 1852 on a tree against a south wall at Nun Appleton, Yorks. The Figs had probably "set" the previous autumn. The old gardener would not have the second crop Figs, which usually appear on the shoots of the current year in July and August, removed in autumn, all being stored away in the matting and straw after the leaves had fallen from the trees, and a fruit here and there ripened off the following year. I have seen excellent Brunswick Figs grown against a thatched cottage wall in North Wales—viz., at Coed Dhu, Denbighshire. Trees of the same variety produced grand fruit on the walls of Wilton Castle, Redcar, Yorks, and it bears as standards in well sheltered sunny places in Herts (St. Albans). Under glass I have not seen much of Brunswick Fig, though as a pot tree it grew fast enough, and was simply useless, and planted out it made effort to oust everything, yet was the most unprofitable variety, but on the back wall of a vinery at Loftus Hall, Saltburn, Yorks, was an old tree of this variety that produced splendid fruit "once a year."

In a cool house I found Brunswick quite as prone to cast its fruit as any other variety, and of all Figs is the most liable to "spot"—a pale salmon coloured patch at the apex of the fruit when ripening, due to a fungus—*Glæccsporium læticolor*. For the reasons given Brunswick Fig is not appreciated under glass, and outdoors requires plenty of space and an unlimited amount of patience. Dr. Hogg says, "The tree is very hardy, but not so good a bearer as the Brown Turkey. It is, however, one of the best for outdoor cultivation against walls." Dr. Eisen in "The Fig of Commerce: its Culture and Curing," states:—"Brunswick.—Fruit very large, pyriform, oblique at the apex, which is much depressed, skin greenish yellow in the shade, pale brown in the sun; very hardy, but bearing qualities medium to poor." Of White Marseilles and Brown Turkey nothing but good can be advanced. Mr. Barron also mentions Grosse Monstrueuse de Lipari as "A certain first-crop Fig," and speaks of Bourjassote Grise as "The most constantly good Fig we have grown, and a good cropper."

In respect of "casting of the fruit," Mr. Barron makes the following practical remarks:—"The casting of the fruit without ripening, which is of very common occurrence, is attributed to the non-setting of the flowers. That it is so may easily be seen by cutting open the fallen fruits and examining them, when it will be observed that the flowers are undeveloped. Many reasons have been assigned as the cause of the defect. Some ascribe it to a sudden check, to coldness, to dryness at the root, or to the reverse of too much moisture, &c., all or any of which conditions may be injurious to the plant and may tend towards the evil, but are certainly not the true or *primâ facie* cause. It may be noted that some varieties are more liable to cast their fruit than others, and that under all sorts of treatment, whilst others, receiving exactly the same treatment, do not do so. It is generally with plants that seem to be in the best possible health, and it is almost always with the 'first crop' and not the 'second,' that failure occurs in this manner."—"Journal of the Royal Horticultural Society," vol. xiii., page 124).

It may be further remarked that Mr. Barron, without saying it, practically points out the cause of Fig trees casting their fruit. Under the head of "Pot Culture" he states:—"Properly managed Fig trees in pots produce fruit in greater abundance and of better quality than those do which are planted out. When planted out they always, whilst young, grow so vigorously that little fruit

is produced, and although the remedy for this is restriction of the root space, it is found in practice difficult to regulate. When grown in pots the plants are perfectly under the control of the cultivator, and may receive whatever treatment may be required."

Over-luxuriance, no doubt, is fatal to fruitfulness, and has much influence on the "casting of the fruit." Lifting, when practised early, or as soon as the leaves give indications of falling, has a great influence on the fruit setting the following season, and persisted in, other conditions being favourable, is a good remedy for unfruitfulness; but there is still the important consideration of maturity of the wood. Mr. Knight carried up a central stem perpendicularly to the top of the wall, and then radiated the side branches horizontally and pendants in close contact with the wall. Luxuriance of growth is thus supposed to be checked, and the branches thrown into a bearing habit. How many trees that are trained to walls under glass might thus be brought into a bearing state? All! Training the shoots down the roof at a not less distance from the glass than 9 inches keeps the points of the shoots up to the light, and care being taken to keep the growths thin, the wood becomes thoroughly solidified, the points of the shoots on which the first crop is produced ripen perfectly, and store up matter for the first fruits. The "second crop" Figs are produced at the lower part of the current year's growth on the well solidified wood, those nearest the points not being nearly as good, nor attaining to anything like the perfection of those situated nearest the base; and in thinning the second crop Figs the cultivator removes the top Figs and leaves those on the firmer wood. Then planted out trees are grown on the extension, pot trees on the restrictive system, and I submit that no Figs are ever produced so fine on the restrictive as on the extension system.

With due regard to keeping the roots under proper control and the trees in abundance of light, nothing need be feared in the way of trees casting their fruit. Poor sappy ill-fed shoots never produce fruit. It is important that the trees have abundance of aliment, and equally abundant means in the shape of leaves well exposed to light and air, with heat to elaborate the wood. Fig trees are grown in such unreasonable circumstances that they cannot bear, and without favouring conditions it is practically impossible to grow Figs with any degree of certainty so as to insure an abundant first crop. Thus planted-out trees are seldom started before the new year or February to ripen a first crop in June, and the slower they are brought forward the better. This gives the trees the benefit of more light, and the fruits advance in proportion to the restriction of the growth or its elaborating and assimilating power, therefore the autumn growths become able to support the fruit at the most critical stage. But when the trees grow rapidly, whether it be from an excess of aliment, or from rapid forcing in too close and moist atmosphere, the wood is soft, the fruit is hurried rapidly forward, and the fructifying organs have not time to develop; in fact, become gross, invariably long in comparison with the second crop Figs, and never open the eye.

Pot trees, on the other hand, are closely pinched; thus the unripe wood is nipped off, and this Mr. Barron says, alluding to pinching the shoots when about 3 or 4 inches long, "will induce the production of fruit in abundance at the axils of the leaves. Shoots not so pinched, but allowed to ramble, do not fruit so freely, the incessant pinching to which they are subjected seeming to encourage the production of fruit." This pinching is only suited to pot trees, though fruit on the extension system is produced freely enough on spurs, but the spur fruits are never so fine as those grown on the extension shoots, the only essential points in either case is to effect the thorough solidification of the growth as made, storing in it abundance of food, and providing thorough maturation. The most abundant crop of Figs I have seen was at Hinchbrook, Huntingdon, the seat of the Earl of Sandwich. The trees were in a narrow border, and the house had upright front lights with a short roof like a wall case; the trees, in fact, were grown against a wall, and ever had the advantage of a "flood of light." The border might be 2 feet wide, and the rest of the rooting area the footings of the wall and a hard gravel path, which had been raised with old mortar rubbish. Spurring was practised as well as laying in young growth, but the former predominated. Last year's wood bristled with Figs at every joint, in fact more Figs than foliage. The first crop always was in "in" at Whitsuntide, when the family were "at home" for the holiday.

Fig trees outdoors cast their fruit for the same reason, the wood is not ripe or the wood on which the first crop is borne is not sufficiently solidified. The stronger the growth the later the ripening, and greater danger of the fruit falling. Early lifting and restricting the roots to a border of calcareo-silicious soil, are the only remedies, and, if under glass, with the point of the shoots up to it, and as near as is safe, whilst the second crop is perfecting. In

this soil the trees will take almost any amount of liquid manure, but none ought to be given until the first crop of Figs have opened at the eye and set, then feed until the second crop begins to ripen, after which dryness and a free circulation of air will insure a first crop, provided the second crop has not been too exhaustive of the vital forces. In calcareo-argillaceous soils the finest Figs are had, but in such the trees are more prone to cast the first crop, and are more liable to "spot."

Pot trees started by early December to ripen fruit in May are seldom allowed to bear many second crop fruits, the object is to have the wood well ripened and stored with assimilated matter and these are given bottom heat so as to accelerate root action and afford an abundant supply of aliment to the embryonic Figs. Obviously these trees must be near to the glass, and have abundance of air. Indeed they are kept very gently moving to secure well developed foliage, and the fruits do not become nearly so long as those hurried by top heat into leaf and casting off the fruit, no attempt at "forcing" being made until the fruit has set and is taking its last swelling. Consequently the Figs have time to develop their flowers, otherwise like Strawberries started at that time in strong moist heat and close atmosphere display ample leafage, but the flowers become "blind," whereas plants introduced later and brought on gently set every flower and perfect every fruit.

There are no doubt "barren Fig trees," that is, varieties or forms of the same variety which are not free. These may very advantageously be grafted, using scions from bearing trees and of known proclivities to retain the first crop fruits. The grafting alone checks the tendency to over-luxuriance. Grafting must be performed after the stocks are in leaf, similar to grafting the Grape Vine, the scions being cut and retarded in a cool place. Ring-budding is also alleged to favour fruitfulness, but I have not found anything so successful as a calcareous soil, or lime rubbish from an old building with just enough loam to encourage rootage. Really the Fig will grow in old mortar rubbish alone as luxuriantly as Nettles, and take any amount of liquid manure when in free growth, and in a paved yard it grows sufficiently to fruit abundantly with branches trained to a south wall, and if with a projecting roof all the better. The most fertile trees I have seen outdoors were in a narrow (2 feet) border and a 6 feet wide gravel path, and the roof projected so that the drip from the eaves dropped clear of the trees—soil, stiff loam over limestone. What the Fig seems to love is nitrate of lime, with enough siliceous matter to strengthen its growths.

Some growers pinch out the points of the shoots from the middle to the end of August. This is to check growth and concentrate the sap on the wood made, and by having every leaf of the future year's bearing wood fully exposed to the sun secure its solidification and maturity, thus effecting the setting of the fruit in the following year. But, as with other trees, pinching and pruning luxuriant trees is a certain means of continuing their sterility. What rampant growth needs is the spade, not the knife.—G. ABBEY.

NOTES ON PLANTS AND GARDENS IN THE WEST INDIES.

A VERY successful meeting of the Horticultural Club took place on Tuesday evening, May 12th, the Chairman of the Club, Sir T. D. Llewelyn, Bart., presiding. There were present the Revs. W. Wilks and F. H. Gall, Messrs. Adams, Bunyard, Cockett, Soper, H. G. Pearson, C. E. Pearson, Lee, Cheal, Wallis, Morris, Paul, Jeffries, Cousens, Druery, &c. In the course of the evening the Chairman brought forward the subject of the annual excursion which had been dropped for a couple of years, and suggested its revival. The suggestion met with a good deal of favour, and seems likely to be carried out. Hertfordshire, Kent, and Sussex were named, the latter seeming to find the most favour. Afterwards the members adjourned to the Royal Horticultural Society's room, where Mr. D. Morris delivered an interesting lecture on the trees and plants of the West Indies. It was illustrated by a series of lantern slides, and the Club was much indebted to the Council for allowing the lecture to be delivered there, as it was much more suitable for the lantern, and the following is a short *résumé* of the lecture, of which, however, it fails to give an adequate idea. A cordial vote of thanks to Mr. Morris was passed unanimously.

Mr. Morris first of all described on a map the geographical position of the West India islands, and said they resembled "stepping stones for giants scattered over the Caribbean Sea." They were for the most part the tops of submerged mountains heaped up by fire. In point of scenery and displays of tropical vegetation they were among the most beautiful portions of the British Empire. Discovered by Columbus just 400 years ago they had cost this country many a hard fought battle by sea and land,

and at one time they produced nearly all the sugar required for the world's consumption. When slavery was abolished their prosperity declined, and latterly they have been much depressed. Their inherent fertility and their advantageous geographical position were, however, bringing them renewed prosperity, and before long they will probably be as noted for their fruit, spices, and other products as formerly they were renowned for their sugar. From a botanical point of view the volcanic islands with elevated lands covered with virgin forests were the most interesting. The littoral or seashore plants would be the first met with. They consisted of the poisonous manchineel, the Seaside Grape (*Coccoloba*), the Coco Plum, and the naturalised Cocoa Nut. Trailing on the ground would be found the Goat's-foot *Convolvulus* (*Ipomœa*) and the Seaside Bean (*Dolichos Lablab*). In swampy places would be found the Mangrove trees, sometimes with oysters on their stems, the majestic Swamp Fern, *Acrostichum aureum*, and numerous Sedges and Grasses. Where rocky cliffs overhung the sea would be found species of *Clusia* and *Plumieria*, the ubiquitous *Keratto* or native *Agave*, several *Tillandsias*, *Pitcairneas*, and numerous *Cacti*. In some places there would be twining stems of *Cereus triangularis*, and in others the globular or truncate masses of the Turk's-head *Cactus* (*Melocactus communis*). In less rocky, but equally dry places, would be met several species of *Acacias*, *Logwood*, *Tamarind*, *Calabash*, *Euphorbiads*, and weedy-looking *Crotons*. Going inland, and especially in following one of the many valleys or ravines reaching into the heart of the coast ranges, the vegetation would become richer, greener, and more varied. There would be tall trees, with numerous Ferns, *Begoniads*, climbing shrubs, and *Aroids*. In the rich lowlands, nearly everywhere, the indigenous vegetation has been cleared to give place for sugar plantations. Where these have been abandoned the vegetation often consists of introduced weeds, and assumes a scrubby character. The true luxuriance of tropical vegetation is now seen to the best advantage in the mountains of Jamaica and Dominica, in the high woods of Trinidad, or the deep and rugged gorges of St. Lucia. Here are majestic trees with huge slab-like buttresses, their branches literally clothed with climbing *Aroids*, wild Pines, Orchids, and festooned with bright flowered creepers. On the highest slopes Tree Ferns spread their feathery fronds, and the banks are softly clothed with masses of *Filmies* of all shades of green. The broad-leaved *Heliconias*, or Wild Bananas, cover moist slopes, or fringe the banks of pools and streams.

Mr. Morris then briefly referred to the chief cultivated plants in the West Indies, and exhibited views of the most striking characteristics of each island. Where there are so many conditions favourable to the growth of plants, the task of the cultivator was to repress rather than to urge. He had to fight against tropical weeds with a persistency which his northern brother could scarcely realise. Gardening in the tropics was stove cultivation in the open air. Heavy downpours of rain and the fierce rays of the sun had to be equally borne, and hence shrubs and trees were more in favour than herbaceous plants. Indeed, delicate plants required the shelter of trees and rocks, and they seldom flourished anywhere unless they were beyond the reach of the fierce play of the elements.

The chief horticultural work in the West Indies at present is associated with the Government Botanical Gardens. There are few, if any, horticultural establishments in private hands. In the neighbourhood of all the large towns every house has a garden. Palms, Tree Ferns, very showy *Crotons*, Orchids, bright-flowering trees and shrubs are grown according to the fancy of the owner. In the verandahs are numerous Ferns in pots, variegated-leaved *Alocasias*, small Palms, and numerous creepers. Every European seeks to grow Roses with more or less success. The two best Roses for the tropics are *Maréchal Niel* and *La France*. These delight in hot situations, and are in flower nearly all the year round. At Barbados the *Crotons* are not merely bushes, they develop into trees with the most gorgeous colours. Orchids are mounted on blocks, and hung under the branches of Fig or Mango trees, or attached to the trees themselves. Some private collections of Orchids at Jamaica and Trinidad are of considerable interest and value. During the last twelve years the Botanical Gardens in the West Indies have been greatly extended. Every important island now possesses a garden which is the centre of horticultural work, and performing the functions of a school of practical horticulture. Flower shows are regularly held, and the taste for gardening is extending to all classes of the community.

Mr. Morris then exhibited views of the most striking West Indian plants, views of a West Indian town, views of gardens, and closed with an account of a very interesting little Palm only 36 inches high when fully developed, which he had found during his recent visit to the Leeward Islands. This is a species of *Thrinax*, apparently new to science, very similar in habit to *Phoenix Roebelinii*.



NEW ROSES—THE FRENCH CONTINGENT.

HYBRID PERPETUALS.

A GLANCE at the National Rose Society's last published report reveals to us the curious fact that in the years 1887, 1888, and 1889 there were offered for sale 228 Roses "of all comers." Out of these about thirty were British-raised flowers, either seedlings or sports, leaving 200 as the modest offering of our foreign friends. Amongst these are, of course, a large number of Hybrid Perpetuals; but when one comes to ask how many of these have, or are likely to have, a permanent position, we have only to say that by the analogy of late years not above half a dozen, if so many. Time was, when English growers for sale used to get all the new Roses and propagate largely; but finding that they had in so many instances spent their labour in vain, for they had to throw away the greater portion of them, and so have become more chary, and only propagate those of which they may hear something privately, or judge from the raisers' names that there is a probability of their being worth growing.

There are, as I have already said, only nineteen new Hybrids in Messrs. Ketten's list of new Roses, and out of these there are four, of these are a couple each from Schwartz and Eugène Verdier, from both of whom we have in times past received good flowers.

KETTEN FRÈRES.

Anna Scharsach.—Raised by Geishwood; flowers fresh rose colour, brighter in the centre, often clear purple, cup shaped. This is very suggestive of a Hybrid Tea with the unpleasant magenta colour which many of them assume, and I believe it is the raiser who has already given us Hybrid Teas, which do not seem to find much favour.

CORBŒUF.

Cécile Morand.—Red shaded with deep carmine, only moderately vigorous, and therefore I fear will be of no use to us.

Comte de Brasson.—A seedling of the raiser, but let out by Bruzeau, shaded rose, with deep carmine flowers in clusters.

MOREAU-ROBERT.

Commandant Larreit de Lamalaquie.—Carmine red shaded with scarlet; flowers large and full, opening well, shape perfect. Named after the commander of the fort Mont Rouge at Paris. This may be very interesting to the good gentleman's friends, but does not interest us much.

Madame Lenesle.—Purplish velvety carmine, shaded with violet; a very doubtful character.

EUGÈNE VERDIER.

Docteur Bastien.—Currant rose and bright magenta; flowers medium sized; very free flowering.

Souvenir de Cécile Villin.—Amaranth red, with purplish velvety crimson large and full flowers. Called after the daughter of a rosarian at Brie, whose early death it records.

SOUPERT ET NOTTING.

Joseph Dequeid.—Carmine lake, shaded with vermilion; flowers large and imbricated, shape of Cabbage Rose; a seedling from Duhamel Monceau and Charles Margottin.

VIGNERON.

Jules Lemaitre.—Lovely carmine red; flowers large, full, and globular; a seedling from Madame Isaac Pereire, and, therefore, probably more of a Bourbon than an H.P.

Madame E. Forgeot.—Flowers clear cerise red, medium sized; a seedling from Jules Margottin and Elizabeth Vigneron, neither of them now considered amongst first-rate Roses.

Madame Eugène Seville.—Flowers cerise red, deeper towards the centre, footstalk firm, and flowers neat; a seedling from Madame Charles Crapelet.

DUBREUIL.

Lamartine.—Carmine red, with velvety shading, verging to violet, a little fringed towards the centre; flowers erect.

TESNIER.

Madame Charles de Rostang.—Flowers colour of the China Rose, outside mauve rose; seedling from Countess of Oxford.

LIABAUD.

Madame Pierre Liabaud.—Flesh white, large and full; a seedling from Madame Isaac Pereire, named after the raiser's daughter-in-law.

Rougier-Chauvière.—Velvety purplish, amaranth red; plant very vigorous.

SCHWARTZ (WIDOW).

Madame Delville.—Bright rose, shading off to the edge of the petals, and passing into clear bright rose, large and full; a seedling from Alfred Colomb, a good parentage.

Roger Lambertin.—Velvety currant red marked with pure white and

clear rose, nearly full, called an original variety. I am afraid its description does not lead one to expect much from it; it sounds rather like the Triomphe d'Amiens and Pride of Reigate style of flower. Such, then, is the very modest list of H.P.'s offered to us this year by the French raisers. Messrs. Ketten add to their list several of the English raised Roses of which I have already spoken. I do not think

strain; but time will show us whether we have under-estimated or not the productions promised to us.—D., Deal.

TEA ROSE SAPHO:

To Messrs. W. Paul & Son, Waltham Cross, we are indebted for numbers of beautiful Roses which have taken a high place both for garden



FIG. 73.—TEA-SCENTED ROSE SAPHO.

that their list is likely to inspire many hopeful feelings, but we must remember that there are two or three raisers who have before now sent us good flowers; but the standard has been now raised so high, and we have such grand flowers already in growth, that it is hard to expect anything to beat them, and it seems somewhat difficult to hit upon a new

culture and exhibition. Additions also are constantly being made of sterling novelties, for every care is exercised in testing their merits before submitting them to a critical public. The variety Sappho, of which we are enabled to give an illustration this week (fig. 73), is one of these, and has already had its character confirmed by the

Royal Horticultural Society and the Royal Botanic Society, as two first-class certificates have been awarded for it. The blooms are of good form and substance, very pleasing in the bud stage, when the colour is a rosy fawn or buff, becoming more yellow as they expand. The plant is vigorous, and has been found to be hardy, while it flowers as freely as could be wished by the most ardent Rose lover. It is, in fact, a good and useful variety.

ROSE SAFRANO.

FOR providing an early supply of Rose blooms from the open perhaps there is no variety equal to Safrano. From a plant growing at the base of a south wall we cut our first blooms on April 28th, which must be considered somewhat early when the backward spring is taken into account. This Rose is so satisfactory out of doors that from the present time until the end of October we shall hardly ever be without blooms. In the bud it is charming for buttonhole bouquets. The apricot tinge it carries is always admired, and when full blown, although it may show an "eye," it is first-rate for vase decoration. Three or four flowers of it, together with three of its copper-coloured leaves, are seen to great advantage.—E.

ROSE GLOIRE DE DIJON.

THE flowering season of this good old variety may be considerably lengthened if some plants can be grown in a northern aspect; for instance, those that are trained at the north side of a span-roofed house which runs east and west will continue to flower long after the plants in the same house on the south side have finished. At the end of April and early in May, when the sun gains power, blooms of this variety do not last very long, which develop in the full glare of the sun; but on the north side the case is different, and this is what renders it so useful. With a few plants blooms of this best of Tea Roses may be had from Christmas until the middle of May without the employment of much fire heat, so regularly do plants flower which are accustomed to do so at the time named year after year. The roots do not require much space, but should be well supplied with liquid manure when growing freely, and the foliage should be kept clear of green fly and mildew by the usual remedies. The finest blooms are the produce of those shoots which are freely cut back after flowering once in about three years, but they are not produced in such numbers as when the branches are allowed to extend for double that time. It is rather surprising what various shades colour one plant will give; beside the natural colour there are shades of pale extra rich orange, and many are tinged with red.—S.

EARLY TULIPS.

ALTHOUGH the majority of the Tulips grown in pots are now past there are many blooming brightly in the garden. I speak of the early Dutch varieties; those of the late or florists' section are coming in. Most gardeners are aware, but many amateurs are not, that the Tulips loved of specialists are quite different to the flowers seen in greenhouses and gardens in March and April. The breeders, bizarres, bybloemens and roses of the florists, are absorbing in interest and marvellous in beauty, and were good varieties plentiful enough to be purchasable at a reasonable cost there is little doubt that they would be largely grown and become firmly established in popular favour. Unfortunately they are extremely scarce, and the price is consequently prohibitive to the great majority of bulb lovers. It is well that in the early Dutch section we have many Tulips which do much to mitigate the regret experienced in finding the others out of reach. They are different in form and their attractions are not enough to satisfy the eyes of some of those educated up to the higher forms, just as the Alpine and even self Auriculas are classed as inferior to the edged flowers, but to those who find pleasure in every phase of beauty there is much enjoyment to be derived from a collection of the simple Dutch forms. The demand for them is growing, and it will probably continue to increase.

Last year there was disappointment in many quarters owing to the Tulips flowering somewhat erratically. Several market growers lost heavily through large batches failing to bloom, and in private establishments, although the loss was not felt in the same way, a similar result was complained of. This year things have happily ruled differently, and with one or two exceptions the flowering appears to have been entirely satisfactory. There have been two or three failures in my own collection of a somewhat peculiar description, two of them, as might be expected, amongst the choice varieties. The flower stem commenced to push up, but before rising clear of the leaves the blooms were seen to be abortive, and instead of bold buds they were small, grey, and withered. This is worse than no show of bloom at all, which honestly puts you out of your misery at once instead of nurturing hopes only to blight them in the hour of anticipated fulfilment. The cause of the failure has never been explained to me and is not at once apparent, for it is associated with healthy and vigorous leaf growth in each case. It may arise from immaturity of the bulbs, which only manifests itself as the crucial time of flower and seed production approaches, or it may be due to a check consequent

on a lack of water, although the same care was exercised in their case as in that of the varieties which bloomed in a satisfactory manner.

Amongst the best of the single varieties I should class the following:—Ophir d'Or is rich, clear yellow, with a very large, well-formed flower; a fine sort that is also grown under the name of Mon Trésor on the Continent. Joost Van Vondel is a good Tulip and a fine bedder, as may have been noted in the public parks. It is crimson, feathered with white, the flower large, and the habit bold and vigorous. The white variety is, perhaps, the best of its colour, and an indispensable exhibition Tulip. It may be taken as the representative show white, as Ophir d'Or is the representative yellow. Queen of the Netherlands, single blush, the variety for which Messrs. M. Van Waveren & Sons received honours at the last great Haarlem Show, has been the queen of the collection, though hardly equal in form to the lovely flowers seen in Holland. It is well worth growing, but I understand the growers, who are wholesale dealers only, have not yet commenced to distribute their stock to the retail trade. Nelly is a pure white, closely approaching Joost Van Vondel in excellence, and much superior to the White Pottebakker, which amateurs still cling to. Both Silver and Golden Standard, the one with white, the other with yellow flakes or featherings, are charming flowers, and even more exquisitely marked are the corresponding varieties of Bride of Haarlem, which are chaste, delicate, and without the least suspicion of gaudiness. Cottage Maid, rosy pink, is still much used in beds; for pots Rose Gris-de-lin is a little finer, and resembles it in hue. Cerise Gris-de-lin, though not particularly pleasing in colour, is noteworthy for bold habit and well-formed flowers. L'Immaculée is another good pure white. Proserpine remains one of the most useful of the early Tulips. It is one of the first to bloom, the habit is admirable, the flowers large, and the colour a deep silky rose. Adelaine, rosy crimson, is not much grown, but it is an excellent Tulip, dwarf in growth, the flowers borne well above the foliage, admirable in form, and of a clear decided colour. It is well worth making a note of. Keizers Kroon, with its huge flowers of crimson and yellow, borne on long stout stems, is a familiar Tulip both in pots and in beds. Roi Pépin is little known, but attractive. As I have previously noticed it there have been a few flakes of red on a white ground, but this year the flakings have asserted themselves more boldly and half covered the flower. These variations are interesting as a mild form of the remarkable phenomenon exhibited by the florists' Tulips in their departure from the breeder to the rectified stage. Eleanora is another splendid Tulip that one rarely meets with, indeed is not to be found in many catalogues. The habit is remarkably good, the flowers boldly elevated on substantial stems, well formed, large in size, and of a telling colour—reddish violet. Lac Van Rhyn is distinct both in flower and foliage, the former being rose with a white edge, and the leaves also edged with silvery white. Rouge Luisant ("shining red") well merits its name, the rosy red flowers having quite a glistening appearance. Vermilion Brilliant may be selected as the best scarlet, and it is most effective in colour, standing out boldly in a mixed collection, and forming a brilliant bed. Van der Neer, purple, and Wouwermans, claret, are cheap varieties, worth noting from their large flowers, distinct colours, and good habit. Amongst the failures are the true scarlet Pottebakker, a rarity which I have never yet seen in bloom, and which has again perversely baffled me; and Pink Beauty, another variety singled out for special honours at Haarlem, and with which I anticipated filling the hearts of sundry bulb-loving friends with envious admiration.

From the painful reflections accompanying a recollection of these disappointments let me pass to some meritorious doubles. And first, since it caught my eye and arrested my steps in passing through the garden before commencing these notes, I may mention Emmeline, a lovely flower which a friend in Holland has earned my undying gratitude by sending me. I do not see it in the one or two catalogues I have by me, and it may not be in general cultivation. The flower is of medium size and the colour an exquisite shade of what is neither pink, rose, red, nor scarlet, but something between them that I hardly know how to specify. Anyway it is charming to a degree, and the variety has proved good both in pots and out of doors. Then there comes Raphael, very pale rose, a large full flower of recognised exhibition merit, and still finer perhaps is Salvator Rosa, a grand rose Tulip. Queen of the Netherlands, double, and Rose Blanche are useful whites. Tournesol and Gloria Solis, both red and white, closely resemble each other, but finer by far than either of them and one of the best double Tulips in cultivation is the yellow variety of the former, a very full flower of great size and pleasing in colour. Another splendid double not much grown is Soleil d'Or, yellow with orange shading, the latter making the flower very distinct. It is large, well formed, and the habit of the plant is all that can be desired.

Couronne des Roses is a good rose coloured variety ; and one of the best of the reds, alike for pots and beds, is Imperator Rubrorum. Latest of all comes Mariage de Ma Fille, with its crimson flowers feathered with white, an excellent Tulip in every respect.

It is unseasonable now to talk of general culture ; but amateurs may be warned against regarding the plants as worthless directly their flowering is over and treating them accordingly. With attention and care they will provide admirable material for planting in the beds when autumn arrives. Save them the strain of seed-ripening by breaking off the flower stems below the ovary, and give them water as needed, placing them in a frame or in a sheltered corner after removing them from the greenhouse or conservatory until they are somewhat hardened and danger of sharp frosts is over. Then if the pots are wanted, as in small establishments they are almost sure to be, the bulbs can be carefully shaken out and planted in the garden with as little disturbance as possible to complete their growth and store up nutriment for another season's flowering. They will not bloom so well as in the previous year ; but they will be bright and pleasing at a time when flowers are much wanted. Think of this, and remember that it is a result to be bought, not with gold, but with a little timely forethought and attention, which it is both a pleasure and an economy to supply.—W. P. W.

SENSATIONAL WEATHER.

THUS is the extraordinary variation of temperature which has recently been experienced aptly described by a correspondent, whose letter with some others we insert below. Sensational, indeed, it has been, like a transit from the torrid to the frigid zone within a week. On Friday storms of snow, rain, and hail passed over the metropolitan district, in some localities the hailstones being of unusual size, and covered the ground to the depth of 2 or 3 inches. Similar weather was experienced on Saturday and Sunday, while Monday will be remembered as one of the most miserable Whitsuntide Bank holidays on record, a cold driving rain continuing most of the day. The highest temperature registered was 43°, and the day is said to have been the coldest that has been experienced in May for twenty years. The range of temperature last week amounted to 47°, a remarkable variation in so short a time. Much injury has been done to the fruit blossom in many places, and in some it is feared there will be little fruit ; at Chiswick, however, Mr. Barron thinks no great amount of damage has been done. Mr. Wright stated last week that "Blossoming time is an anxious time ; we know not what the weather will be, what fruit blossoms will have to endure ;" but he did not presumably anticipate their having to go through such a wintry ordeal as that which so suddenly followed the summer-like days early in the week.

THE weather continues very ungenial. Since the 11th and 12th, which were warm days but cold at night, northerly winds have prevailed sharp and keen. Frosts of 4° and 5° occurred on the nights of the 15th and 16th, with driving showers of snow and hail. The showers of hail on the 16th were frequent and heavy. Snow of over a foot in depth is reported from some of the northern counties. Potatoes have been blackened in this district.—B. D., *South Perthshire*.

WE had very sharp frost here on the night of 16th and 17th. All tender things not covered are very much injured or destroyed. Fortunately not much fruit blossom was expanded, but where Cherries, Plums, and early Pears were open I fear they must all be destroyed. I cannot speak of bush fruits, but fear the crops are lost. Snow fell frequently all day on Sunday, with a cold north and east wind.—W. A. JENKINS, *Aldin Grange, Durham*.

JUST a line to say that we had 11° of frost on Sunday morning, and 13° this morning. Pears generally about half bloomed, but Apples in the open are just commencing, Gooseberries well protected with foliage, and Strawberries are unopened.—JOSEPH WITHERSPOON, *Durham*.

WHIT-SUNDAY in the midlands and Birmingham will not readily be forgotten. Early in the preceding week we had two warm days, the temperature then falling. Snow fell on Sunday continuously for from seven to eight hours. Everything bore a very wintry aspect indeed, and the snow had not cleared away until after breakfast on Whit-Monday, and then leaving cold biting north-easterly winds. Strong showers of hail intervened, and frost early in the mornings. What the effect on the Plum, Cherry, Pear, and other crops will be I am unable to say just yet, but we may safely estimate that much damage has been done. The cottage gardens in the Albrighton and Tettenhall districts of Wolverhampton, where Damsons are extensively cultivated, were masses of white flowers, and held out a promise of an extraordinary crop, and the district was rich in floral beauty.—W. D., *Birmingham*.

THE frost we had on the nights of the 16th and 17th has done an immense amount of damage. Potatoes, Beans and Vegetable Marrows put out to harden are severely cut. More serious still, the Plum crop looks ruined. Gooseberries are all soft on the tops of the bushes. It is rather early to say how much the Apples and Pears have suffered,

but some damage has been done to them. Young Ash in the hedges are black, also young Ivy, &c. This morning (18th) the hills all round are covered with snow.—S. T. WRIGHT, *Glewston Court Gardens, Herefordshire*.

It may be worthy of note that on Sunday, the 17th inst., we experienced a very heavy snow storm, which commenced about 9 A.M. and continued until 3.30 P.M., when the ground was entirely covered to the depth of 4 inches. It was preceded by very heavy hail storms, which played sad havoc with fruit trees. Vegetables, Potatoes, and Peas have suffered very badly, having the appearance of being fired at with buckshot. Such an occurrence has never been known in this district before by the oldest inhabitant. I shall be glad to hear, through the medium of the Journal, if your readers have any recollection of such a storm at this time of the year. On Tuesday, 12th inst., we registered 75° in the shade ; to-day the mercury is standing at 41°.—W. JNO. BLIGH, *Ruthin*.

THE weather during the past week has been of a most changeable character. Sunday, the 10th, was very cold, the thermometer being at 42° at mid-day. Monday was quite spring like. Tuesday and Wednesday we were having tropical heat, the thermometer standing at 75° in the shade. On Thursday we had cold and dull weather. Friday and Saturday heavy hail and snow showers, the thermometer on Saturday morning registering 2½° of frost ; at half-past 8 the same evening it registered the same amount, and on Sunday morning we registered 10½° of frost, the thermometer being at 21½°, which is, I think, exceptional weather for Whit-Sunday. With us it might be correctly termed Black Sunday, as all early Potatoes on borders and elsewhere were quite cut down and blackened. Some American Wonder Peas, too, were much cut, although William I. on the same border escaped. The Apple and Pear blossom is quite discoloured, although we had wonderful promise. Plums and Peaches on walls were set, and appear at present uninjured.—J. HOWARD, *Benham Gardens, Berks*.

ON Saturday afternoon, 16th inst., we had a heavy snowstorm of twenty minutes duration, not a few flakes, but a regular winter storm, and on Sunday morning 4° of frost. It is too soon to pronounce on its effects, but I fear a good deal of mischief will be done.—R. MAHER, *Yattendon Court*.

THE weather here during the last six days has been sensational in its character. On Tuesday, 12th, the thermometer registered 86° in the shade, the lowest reading the same morning being 55°, with the wind in the east. On the 13th, 80° was registered in the shade. The temperature afterwards became gradually lower, the wind changing to W.N.W. On 16th, the highest reading taken was 57°, and the lowest 34° ; while on the morning of Whit-Sunday 7° frost was registered, the wind blowing strongly from the N.W., with occasional showers of rain, hail, and snow during the day. I fear such a severe frost coming at so late a date, when the Apple trees were in splendid bloom, must have almost spoilt the whole crop. The blossom never could be more profuse. The trees now present the appearance of having been scorched, the petals being quite brown. If there should be any remaining prospects of a crop it must be those flowers which are only in the bud state, or those at the underneath side of the branches which are protected by the ample crop of leaves.

Strawberries never looked so promising in this garden, the first flowers just opened, the central part of every one of these is quite black, as also are a great number of the unopened buds upon examination to-day. One mile from here, at a slightly lower altitude, 9° frost was registered. I fear the prospects of a Strawberry crop in the neighbourhood where some hundreds of acres are grown, will be poor. Pears, Plums, Cherries, and Peaches on walls have set good crops, and may be regarded as being tolerably safe. Many breadths of early Potatoes were 6 inches high in the haulm, all of which have been cut down to the ground. Even common Blackberry shoots in the hedges, as well as young growth of Ash trees, are blackened. Many kinds of shrubs have been injured in the same way. Rain is much needed in this part, not only for seeds and garden work in general, but for the farmers, who are much troubled with wireworm in their Oat and Barley fields, only half inch having fallen for five weeks.—E. MOLYNEUX, *Swanmore, Hampshire*.

As is truly stated by Mr. Wright in his able leader entitled "Blossoming Time," page 379, which, by the way, came at a very opportune period, and would be read with interest by all fruit growers, "A good fruit year appears to be generally anticipated." But unfortunately "the prospect" is not now quite so cheering. On Friday, the 15th, a most unpleasant change of wind and atmospheric conditions took place, suddenly plunging us out of what had for some days been almost tropical summer into arctic winter. The change was ushered in by a heavy thunderstorm, accompanied by a considerable fall of snow. During the night we had a slight frost, and again during Saturday ; snow fell heavily at frequent intervals, accompanied by a biting cold north-west wind. On Sunday morning our thermometer registered 2° of frost, and as at the time of such occurring the expanded blossoms were dripping wet, and I am afraid must be injured seriously. At the time of penning this the snow is falling fast, with the thermometer only just above freezing point.

Mr. Wright is quite correct in his opening remarks when he says,

"It is questionable if during all past years such a profuse display of blossom has been seen at one time as is now expanded or approaching expansion." Such exactly describes the state of things in our Leicestershire orchards and gardens. Apples, Pears, Plums, Cherries, and indeed all kinds of fruit trees are alike, literally full of expanded blossom, or buds nearly ready for expansion. Such also is generally remarked upon as being very fine in character; large, bold, and most perfect in development; but against these cheering prospects we have first to place the unwelcome re-appearance in large numbers of our old enemy the caterpillar of the winter moth, and secondly this disappointing return of winter weather. On Thursday, the 14th, we were visited by a strong gale of wind, which dislodged a large proportion of the petals from the Plum trees, carpeting the ground underneath and around with a white covering, but it was pleasing to see that the embryo fruit remained persistent and apparently satisfactory.—W. K. W., *Leicester*.

THIS district, during the past few days, has been visited by frost and snow, hail and storms, more suggestive of January than any other month. On Friday we registered 0.10 inch of hail and snow; Saturday, 0.01 inch snow; Sunday, 0.13 inch snow; with a minimum temperature of 26°, and on Monday morning a minimum temperature of 20°. Potatoes are completely cut down; young Plums, which were just set, and had lost their petals, and completely blackened through; Pears, Strawberries, &c., have suffered in a varying degree. Bush trees are cut, as also are numbers of plants in herbaceous borders; in fact to enumerate all the damage done would require a longer list than I have time at present to prepare.—J. TUNNINGTON, *Ripley, Yorks*.



TO CONTRIBUTORS.—We desire to thank all our friends who have so promptly and spontaneously favoured us with notes on the late extraordinary weather as well as on other subjects of interest, and to assure them that if all communications we receive cannot be inserted at once they are not on that account the less appreciated.

— ROYAL HORTICULTURAL SOCIETY.—We are desired to state that this Society will hold its fourth great annual flower Show in the gardens of the Inner Temple, London, on the 28th and 29th inst. So far the entries have been numerous and important, and to prevent eventual disappointment those who are still desirous to exhibit should at once communicate with the Superintendent, R.H.S. Gardens, Chiswick. This year the arrangements have been nearly all completed somewhat earlier and more systematically than usual, and there is every reason to hope that if favoured with fine weather H.R.H. the Princess Christian will have the pleasure of opening the finest Show the Society has yet held in the Inner Temple Gardens.

— THE HORTICULTURAL CLUB.—It has been suggested that an informal dinner of the Club should take place on Thursday, the 28th inst., at 7 o'clock. This will be the evening of the Temple Show, and no doubt many members and friends will be glad of the opportunity of dining together.

— GARDENING APPOINTMENTS.—Mr. G. F. Jeal, until recently head gardener to W. J. Cheetham, Esq., Rawdon Hill, Arthington, Leeds, has been appointed head gardener to F. C. Arkwright, Esq., Willersley Castle, Cromford. Mr. John A. Wood, foreman at Culzean Castle Gardens, Maybole, N.B., has been appointed head gardener to Lord A. E. Hill Trevor, Brynkinalt, Chirk, Denbighshire; and Mr. Charles Portsmouth as head gardener and bailiff to Mrs. Baker Baker, Elemore Hall, Haswell, Durham.

— DEATH OF DR. SCHOMBURGK.—A correspondent sends us the following extract from the *Sydney Bulletin* of April 4th last. "Dr Schomburgk, the octogenarian Curator of the Adelaide Botanical Gardens, who died suddenly last week in the arms of his son Otto, was an ideal scientist—a simple-minded, single-hearted genius. He came to Adelaide more than a generation ago with a younger brother, both being political refugees from Germany. Another brother, Sir Robert Schomburgk (who discovered and named the Victoria regia in the Brazils), was a fellow traveller with the immortal Humboldt, botanist and naturalist, and it was through the powerful interest of Humboldt that the escape of the two Schomburgks was connived at. The deceased controlled the Adelaide Gardens for a quarter of a century."

— SUTTON'S POTATOES IN CEYLON.—We learn that Messrs. Sutton & Sons of Reading have been awarded a gold medal at the Ceylon Agri-Horticultural Exhibition held at Nuwara Eliya on April 1st, 1891, for a collection of Potatoes grown in the garden of His Excellency the Governor of Ceylon. The varieties were exclusively of the firm's introduction, and included such varieties as Abundance, Satisfaction, Windsor Castle, and Masterpiece, and Mr. Nock, the Superintendent, writes:—"The Potatoes were a good sample, and made a splendid show; they would have held their own in most exhibitions, and would have been hard to beat for evenness and general appearance."

— SINGLE FLOWERS DOUBLING.—I have numerous cases of single Daffodils becoming double. What is the primary cause? Has the pollen of semi-doubles any influence upon the bulbs, or is it simply a malformation from the peculiarity of the soil or cultivation?—A. L. B.

— MESSRS. JAMES CARTER & Co., High Holborn, exhibited a GROUP OF CINERARIAS at the Crystal Palace Show recently, comprising well-grown plants representing their "Brilliant Prize" strain. The colours were varied and extremely bright, the flowers also of good size and shape.

— NARCISSUS PRINCEPS.—The early flowering is very showy growing in a mass out of doors, and it is so useful on account of its earliness, being one of the first to flower of the trumpet section. For pot culture it is equally prized. The sulphur white perianth and yellow trumpet are colours much appreciated.

— EARLY PLANTING OF POTATOES.—In some districts for several years past farmers have been in the habit of planting Potatoes during the first favourable opportunity, and before cereals were sown. This year, as usual, many were planted in the early part of February, but unfortunately in several instances the seed has been destroyed by the severe frosts of March, and the ground has had to be planted anew.

— FOR planting in a mass in the flower garden NARCISSUS HORSEFIELDI is one of the best of the family. The flowers are freely produced on short stout stalks, quite in keeping with the foliage, which is very stiff in habit, the broad leaves having a decided glaucous tint. The rich yellow of the trumpet corresponds well with the white perianth. Altogether this Trumpet Daffodil is deserving of extended cultivation in the flower garden, where it is best seen growing in a mass by itself.—E. M.

— MESSRS. PITCHER & MANDA, Hextable, Swanley, Kent, write:—"I herewith beg to send you a flower of a new American CARNATION LIZZIE MCGOWAN, which we are sending out this spring. It is a very fine-growing variety, very free, and we consider it is the best white perpetual Carnation in cultivation. The flowers are much larger when the plants are grown strongly and well-established. For cutting purposes it is especially good, and therefore valuable for market work." [The flower received had suffered in its journey, but is evidently pure white and extremely fragrant, somewhat of the Clove scent.]

— WARE HORTICULTURAL MUTUAL IMPROVEMENT SOCIETY.—This Society held its fortnightly meeting on the 12th inst., when an interesting paper was read by Mr. H. Smith on "Leaves, their Form, Modification, Sensibility, Functions, and Uses." Questions were asked by several of the members, to which Mr. Smith replied. A good selection of Pansies was shown by Mr. Gull, and a choice collection of cut flowers and good pans of market Lettuces by Mr. G. Fulford. Votes of thanks to the essayist and Mr. G. Collins, who presided, brought the meeting to a close.

— THE summer Show at the ROYAL AQUARIUM, WESTMINSTER, yesterday (Wednesday) comprised some excellent groups and collections of a bright and varied character. Messrs. J. Laing & Sons, Forest Hill, had an effective group of Tuberos Begonias, Orchids, and foliage plants, also handsome specimen Caladiums. Messrs. W. Paul & Son, Waltham Cross, showed a magnificent bank of Roses in pots, with boxes of cut blooms; and Mr. T. S. Ware, Tottenham, also had a very beautiful group of Tree Pæonies and hardy plants. Extensive collections of cut Daffodils and hardy flowers were contributed by Messrs. Barr & Son, King Street, Covent Garden, and Messrs. Paul & Son, Cheshunt, which imparted much interest to the Show. Stands of flowers, a few groups of Gloxinias, Calceolarias, and miscellaneous plants were also exhibited by amateurs. Green baize screens were employed as a background to the groups arranged on the floor and tables with capital effect, a very notable improvement.

— At a recent meeting of the ROYAL BOTANIC SOCIETY of London Lord Willoughby d'Eresby in the chair, the plants in flower from the Society's conservatories, shown at the meeting, included an Amorphophallus, a plant allied to the Arums, remarkable for the offensive carrion-like odour given out by the flower when it has reached the fertilising stage, with the evident design of attracting insects to assist it. Another characteristic peculiar to the family is the greatly increased temperature at that period, a rise of 9° over the surrounding air being shown by a thermometer suspended in the flower.

— BERBERIS AQUIFOLIUM is making a great display with its light yellow flowers, which contrast well with its deep green leaves. I think it cannot be generally known that this Barberry succeeds so well under trees where the shade is not too dense, or I fancy more of it would be employed. As an evergreen it provides a great variety both in the colour and shape of its leaves. Some are green, while others vary from bronze to bright red. All are most useful for cutting as greenery for other flowers. Owing to the tough character of the leaves they last a long time fresh in a cut state. What could be better for associating with Daffodils than branches of this Berberis placed lightly in a vase?—E.

— HARDINESS OF CUPRESSUS MACROCARPA.—Where the trees of this well known Conifer assume a columnar form they are quite a feature in the pinetum or pleasure grounds, but I am afraid it is not nearly so hardy as at one time thought. With us both large specimens and quite small trees are badly injured—are so hard hit, in fact, that they will most probably be rooted up. I was in hopes they might recover, but instead of improving in colour they are gradually getting worse, and in all probability the stems are dead or dying. The south-western counties certainly had the worst of the blizzard that did so much mischief, but the trees of Cupressus macrocarpa were not unduly exposed to it. Are we to write down this noble Conifer as of doubtful hardiness?—W. I., Somerset.

— BULBS AFTER FLOWERING.—Many persons are at a loss to know what to do with the bulbs of Hyacinths, Tulips, Narcissus, and Jonquils after they have flowered in pots. They think that the bulbs are useless, and consequently throw them away, whereas a greater mistake could not be made, as if planted at the front of the herbaceous border they flower every year, for I cannot say how many of ours have flowered continuously for the last ten years. By planting them at once with the flower spike removed, they are out of the way, and the pots are available for other purposes. We plant them with a trowel, simply removing the crocks from the bottom of the pot. The soil about the roots is useful for them to grow in for some years, until they are replanted. Here they make that part of the garden quite gay when in bloom, otherwise it would be dull.—M.

— MR. JOSEPH WITHERSPOON, The Vineries, Red Rose Cottage, Chester-le-Street, Co. Durham, writes:—"As I had determined to grow a few Grapes with the object of exhibiting them at the EDINBURGH INTERNATIONAL SHOW, and as I should be very sorry, after being at the trouble and expense to find if a prizewinner that I would risk disqualification, will you kindly permit me through your columns to inquire of the Council, Are gardeners or amateurs, who sell the portion of their produce not needed for home consumption, eligible to compete in classes 1, 2, 3, 4, 5, 7, 8, and 10? If selling produce disqualifies, then, as a matter of course, selling being the order of the day, there will be some trouble in getting up an exhibition; but if gardeners and amateurs remain so irrespective of selling, then I, as an amateur who sell to live, and gentlemen, too, who sell extensively, will both be equally eligible to exhibit and take prizes. As you are aware, I am by trade a wheelwright, and therefore strictly speaking an amateur."

— A CONTINENTAL INSECTICIDE.—M. Cazeneuve, writing in the *Journal d'Agriculture Pratique*, describes the good effects of sulphuret of carbon, mixed with an equal quantity of vaseline, as an insecticide, especially for the phylloxera. The use of the vaseline is to prevent the rapid evaporation of the sulphuret of carbon, which was the great objection to this otherwise valuable insecticide. It was only in 1887 that the idea of adding vaseline was first formed, and since then the mixture has come into more and more extensive use every year. M. Cazeneuve has tried the remedy in his own vineyard since it was introduced, and has tripled his production of Grapes since he adopted the treatment. No phylloxera can now be found on the roots of the Vines, new rootlets have been formed in great number, and the vegetation is luxuriant.—(*The Standard*.)

— BLACK CURRANT MITE.—The writer who remarks that my picking off the affected buds is no use, gives no reason for it, nor for his assertion that it is of no effect if one is left or dropped. Surely one affected bud is not so bad as a thousand, and in a few years, if picking off the buds is of use at all, the pest would be stamped out. He says the branches must be cut off, but it appears to me that a bud is more likely to be missed in this way than by disbudding, unless the whole of the tree is cut down, which would be a serious loss to a fruit grower. The insects are more likely to escape if a branch lies on the ground when cut off than if the buds are picked into a pail and taken away and destroyed. When pruning a large plantation one cannot walk away with every handful.

— QUEEN WASPS.—An unusual number of these appear to have been abroad lately, and should be destroyed. A good plan is to have a syringe and pot of water handy, especially about sunset, as when their wings are wetted they cannot fly.

— CATERPILLARS are also numerous again this year, though I think we have benefited greatly by the wet weather clearing them off last summer, and which no doubt largely prevented them continuing the circle of their development. Without prejudice to other makers who may have something better, I may say that the best handpump with which I am acquainted for washing fruit trees with a short stem, is a Robins' No. 2 hydronette. This is an exceedingly handy little implement, and answers as well as more costly ones, and is also useful as a syringe, for it can be worked more quickly than the ordinary garden syringe.—WALTER KRUSE.

— FRUIT PROSPECTS.—Apples, Pears, Plums, Cherries, Strawberries and bush fruits have been flowering abundantly, and so far we are free from caterpillars. The few hot days we had caused the leaves to expand well, and being late the soft-billed birds, which are this season numerous, are busy examining the fruit trees. Some of those I noticed at work in the Apple trees were the willow wren, blackcap, chaffinch, several varieties of titmice, and greenfinches. The bullfinches have been troublesome late this season; they did not begin in earnest till April, and they have since destroyed a great quantity of Apple blossoms when nearly expanded, and I noticed they are still at work at a large Bigarreau Cherry tree in full bloom. I have enclosed a few from the above named tree, some having the embryo fruit extracted by bullfinches and some not, and since writing the above I noticed that yesterday they had been busy at work on some late-flowering Apples, notably Wellington and Cox's Orange Pippin.—R. M., Berks.

— FRUIT PROSPECTS.—The caterpillars are as yet very small, and do not appear to be doing such mischief to the foliage or the blossom as in previous years, nor do I think it is likely they will do so, as the trees were in a more advanced stage of growth at the time of their appearance; and although in many curled-up clusters of leaves—particularly in the centres of the trees—it is easy to find some half a dozen thin wiry specimens about a quarter of an inch in length, yet there are quantities of both wood and flower buds expanding freely in which no trace of the insect is to be found. Up to the present neither grease banding in autumn nor spraying the trees in spring has been at all practised in this district, so that I attribute this partial immunity of our trees from the plague to the beneficial work of birds at the time the grub would be depositing its eggs, and when they were driven to the trees for food on account of the ground being hard-baked by the frost. Gooseberries flowered satisfactorily, but the fruit then just setting freely was severely thinned from the outside branches and the tops of the trees by frost during the last week of April. Currants, both Black and Red, promise a fair crop, as also do Raspberries, which show a plentiful display of bloom buds. Strawberries are throwing up very strong trusses of bloom, in quantities sufficient for heavy crops.—W. K. W., Syston, Leicester.

— DAFFODIL TRUMPET MAXIMUS.—In reference to Mr. Hartland's note of May 16th respecting this Narcissus, I hope it will not yet be recorded as an ascertained fact that *N. maximus* grows wild on the Spanish side of the Pyrenees. Mr. Hartland writes in perfectly good faith, but the "collectors" who profess that this plant is "brought on mules' backs from over the mountains" are not trustworthy in their statements. It is not impossible that *N. maximus* is a Spanish plant, but we have as yet no sure evidence that this is so. Indeed, I believe there is considerable evidence that this particular consignment of bulbs may have had its ultimate origin in English or Dutch nurseries; but hereby hangs a long story, and one which would bring into mention names which I am not at liberty to use. I only write

to ask Mr. Hartland to speak doubtfully rather than certainly upon the point, since unverified statements of this kind are apt to get into books and be stereotyped as facts. It has already been alleged that *N. maximus* has been found wild in Southern Italy, the truth being that we do not know as yet where is its habitat.—G. H. ENGLEHEART, *Appleshaw, Andover.*

— BLUE SELF AURICULAS.—Referring to Mr. Clarke's note in your issue of the 7th inst. I may state that amongst some very fair seedlings that recently flowered two lovely blue selfs have come prominently to the front—flat, circular and high class, almost similar in height, form, beauty and shade of body colour; but one having an almost if not quite clear white tube on opening, the other a yellow one. The flowers on the latter, after some days, commenced to lose the intense colour and changed, until finally they became a dull reddish blue, and the tube a sickly white, whereas those of the former retained their brilliant intense blue to the end, and the tube its original clear white. I am not an advocate for interfering with florists' rules, but if the above is usual may we not in striving for an orange tube (which I believe is thought the desideratum for a blue self) be straining after a shadow and losing the substance? Nature apparently is reluctant to allow the combination. For my own purposes I have named the lovely white tube one "Whitethroat," after our little summer visitor, whose advent adds a charm to sylvan beauty, whereas the other will have to exist under a number unless it mends its manners next season, of which there is little chance.—T. A. J.

— THE ROYAL NATIONAL TULIP SOCIETY.—According to the usual custom, a ballot has recently been taken of the growers of the Tulip about the country as to the most suitable date for holding the annual Exhibition of the above Society, with the result that by a majority of one it has been decided the Show shall take place at the Botanical Gardens, Old Trafford, Manchester, on Saturday, May 30th. From growers as far north as the Rev. F. D. Horner at Burton-in-Lonsdale, and as far south as Mr. James Thurston of Cardiff, comes the request for the 30th of May; the Cheshire Tulip fanciers, and some further south, joining in the request. The Lancashire growers wanted the date a week later, but being in a minority they had to yield. Unless a very decided change comes in the weather, a change to warm southerly winds and bright sunshine, the Lancashire growers will scarcely have a chance; and Mr. Samuel Barlow, writing on the 16th, said that he had not a bud of a Tulip showing colour on his bed on that date. It is likely those who voted for the 30th inst. did so under the influence of the burst of warm weather of the past week, as the votes had to reach the Secretary by the 14th inst. Last year, through inadvertence in setting up the same variety of Tulips under different names, the growers met together and unanimously passed the following resolution:—"That in future all stands on being staged shall, before being seen by the Judges, be examined by the Committee, in order to ascertain whether an exhibitor has staged two flowers of the same variety and class in the same stand, and if any such be found the Committee will inform the exhibitor, who will be allowed to replace one of the flowers by another of a different variety, thus preventing the disqualification of any stand from this cause." Evidently the Tulip growers are sensible practical men.



ODONTOGLOSSUM HASTILABIMUM.

A RECENT issue of Messrs. B. S. Williams & Son's "Orchid Album" contains excellent plates of the above-named distinct *Odontoglossum*, also of *Cypripedium porphyrochlamys*, *Zygotopetalum Mackayi*, and *Cypripedium Lowi*, with much interesting descriptive matter. Concerning the two first named we extract the following:—

The plant now under consideration has been in cultivation nearly fifty years, and we have both known and grown it for some thirty years or more, having always held it in the highest estimation. The plant is said to grow as an epiphyte on the large cable-like stems which overhang the lagoons and running streams in New Grenada, whilst it is found in other localities growing with various plants in large masses. It occurs at a lower elevation than many of the species of *Odontoglossum*, having been found at some 2500 feet elevation, but yet is abundant at 9000 feet and even higher.

The species is said to have been first detected by M. J. Linden of Brussels, and the first time of its flowering in England occurred in 1846 in the collection of the Duke of Northumberland at Syon House, Brentford, where in those days were gathered together an immense number of rare and beautiful plants. The plant whose portrait we now lay before our readers was a specimen which grew and flowered in our own collection at Upper Holloway, in the month of July in the year 1889. Its natural flowering season, however, is said to be from January to April, but it appears to be a very variable plant in its time of blooming.

Odontoglossum hastilabium is a stately species, growing to a large size, the stout pseudo-bulbs being flattened at the edges, much wrinkled, and bearing on the summit a pair of leathery light green leaves, the leaves enveloping the pseudo-bulbs when young, being very fugacious, and soon falling away. The scape attains a height varying from 2 to 6 feet in length, the flowers being paniced. Upon one panicle imported from its native country we counted more than a hundred sears, which were the impressions left by fallen blooms. The flowers are some 3 or 4 inches across, and very fragrant, spreading, and showy; the sepals and petals are nearly equal, the ground colour being of a creamy green or creamy yellow, barred transversely with numerous closely arranged streaks and blotches of deep reddish purple. The front lobe of the lip is broadly acute, pure white, more or less flushed towards the base with purple, which becomes of a deeper purple at the extremity.

The plant thrives best in a pot, taking care that the drainage is kept perfectly free and open, and in good working condition. The pot should be of good size, for we have found this plant, unlike many Orchids, delights in a largish quantity of soil about its roots. The soil should consist of good peat fibre (from which most of the fine particle have been beaten) and some chopped sphagnum moss, adding in the course of potting some nodules of charcoal, and pressing the whole down firmly. This plant thrives well with other species of *Odontoglossum* during the summer season, but during the dull dreary days of winter it should have a little more warmth than such kinds as *O. Alexandræ* appear to revel in, and therefore we recommend the Cattleya house, or a temperature which does not fall below 55° or 60°. It should be kept rather dry at the root in winter if not growing, but by no means allow it to suffer through want of water.

CYPRIPEDIUM PORPHYROCHLAMYS.

The plant here depicted is one of great beauty, and is the result of a cross between *Cypripedium barbatum* Warnerianum and *C. hirsutissimum*. It is one of the few hybrids which have hitherto flowered, that have *C. hirsutissimum* as one of the parents. It was raised by Mr. Seden, at the nurseries of Messrs. Veitch and Sons, King's Road, Chelsea, and it first flowered in 1884 when it was named by Professor Reichenbach. From the great quantity of Slipper Orchids which have been raised and are coming on now to a flowering stage, there are many inferior kinds, and many that have too close a resemblance to others already in commerce, and the same will be sure to occur from those unflowered plants which already have an existence, consequently a weeding out will be necessary, when some kinds which now stand high in favour will be cast on one side, but the plant here portrayed will occupy the first rank for a very long time, and we think will become a permanent favourite. The plant here figured was grown in the once famous collection of *Cypripediums* gathered together by F. G. Tautz, Esq., late of Studley House, Shepherd's Bush, where the plants were maintained in excellent health by his gardener, Mr. Cowley, whom we hope to again see in charge of a still finer assortment in his new home, and also that Mr. Tautz may give us some startling novelties from his many hybrid seedlings.

Cypripedium porphyrochlamys, being a seedling from two Eastern plants from warm localities, naturally enough likewise requires the temperature of the warmest house to grow it freely and to induce it to flower. It is an evergreen plant, having oblong leaves of a pale green, slightly tessellated with deeper green. The peduncle is erect. At present we have only seen it bearing a single flower, but as we have seen both its parents produce two flowers this plant may also be twin-flowered when it becomes strong. The flowers are large and brilliantly coloured, the dorsal sepal very broad, the whole central part being rich crimson with darker veins, and the apex snowy white; the lower sepal is much smaller, greenish white, veined with green. Petals deflexed, the basal part yellowish green, freckled with blackish spots, and the edges ornamented with black hairs, the tips violet-purple; the lip is brown, shaded with purple on the upper side, paler beneath. Its flowers last a very long time in beauty.

This plant should be grown in a pot and raised somewhat above the rim, the soil it requires being a mixture of light turfy loam, good peat fibre, some small nodules of charcoal, and a little sharp sand, the whole well mixed together. Before potting let the

drainage be arranged in good working order, as the plant requires a liberal supply of water during the whole season.

MASDEVALLIA ARMINI.

An excellent specimen of this beautiful little *Masdevallia* was shown by Sir Trevor Lawrence recently at one of the Royal Horticultural Society's meetings, and it was greatly admired. The colour is remarkably rich and distinct from all others of the genus.

Messrs. J. Veitch & Sons, Chelsea, in their monograph of the *Masdevallias*, give the following description and note:—“Leaves oblong-lanceolate, 1½-inch long, narrowed below into a somewhat slender petiole as long as the blade. Scapes slender, longer than the leaves, one-flowered. Perianth tube short, whitish ;

to William the Conqueror, and his name is perpetuated in rather a singular manner, for the guide book tells us that the largest barrel in the principal ale cellar is named after him. It holds 1300 gallons, and twelve persons are said to have dined in it at one time.

The domain passed into the De Ros family by marriage in 1247, but was forfeited during the wars of the Roses to Lord Hastings. It was restored, however, about twenty years afterwards, and subsequently passed, again by marriage, to Sir Robert de Manners. Sir Thomas Manners was created first Earl of Rutland by Henry VIII. in 1526, and the ninth earl was elevated to the dukedom by Queen Anne. The present Duke, the seventh, so long known as Lord John Manners, succeeded his brother, who died in 1888, and thus is the present linked with the past over a period of 700 years.

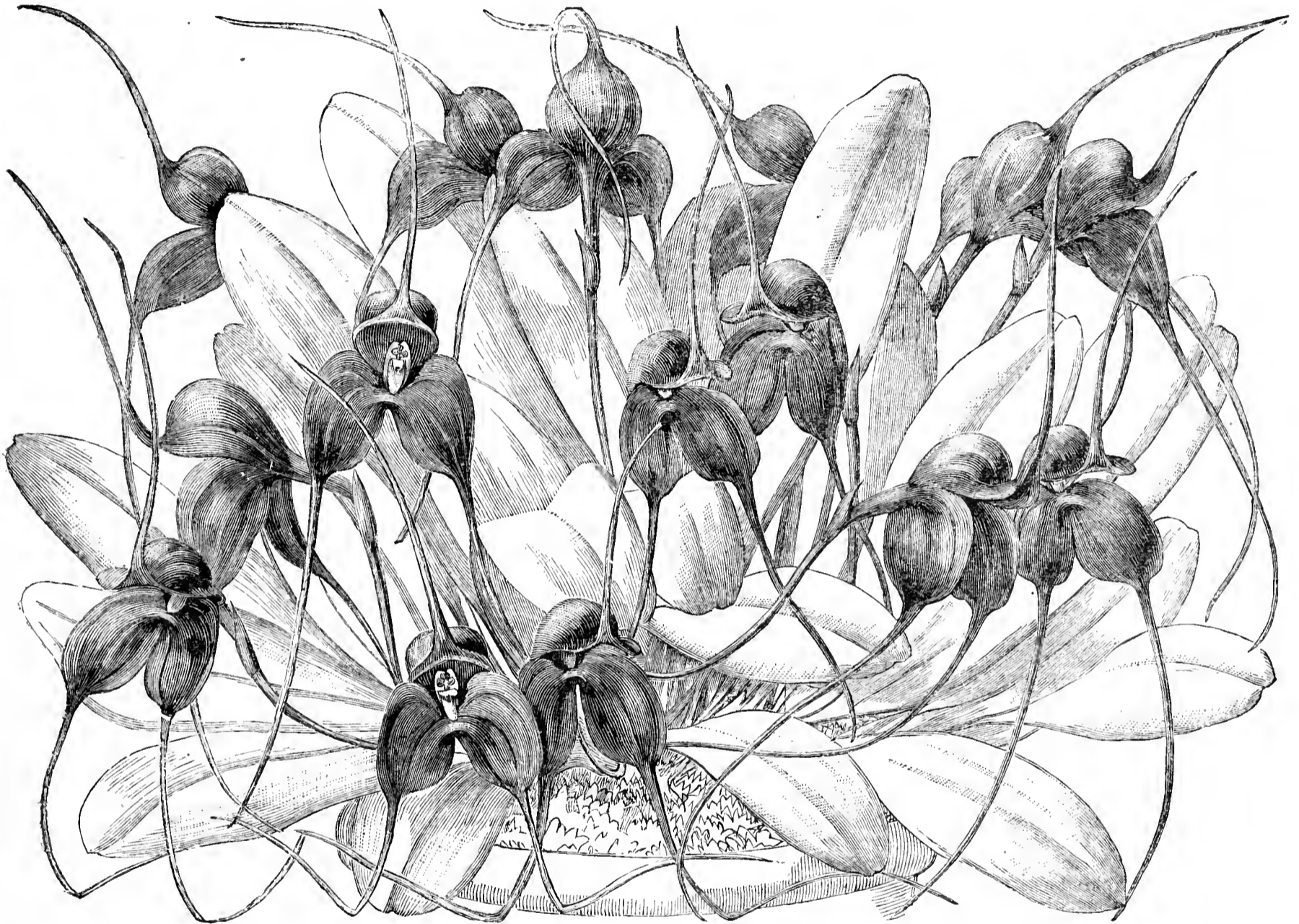

FIG. 74.—MASDEVALLIA ARMINI.

free portion of sepals crimson-purple, the dorsal one sub-orbicular, concave; the lateral two broadly oval-oblong, nearly flat, and contracted to filiform, yellowish tails 1-2 inches long. Petals linear-oblong, toothed at the apex, white; lip oblong, reflexed at the tip, where there is a blackish purple warty blotch. First discovered on the Eastern Cordillera of New Granada, in the Pamplona district, more than thirty years ago, by Selim, but dedicated by the late Professor Reichenbach to his friend Hermann Wager, by latinising the Christian name. It appears to have been first introduced into European gardens by Messrs. Sander and Co. of St. Albans in 1882.”

BELVOIR IN MAY.

BELVOIR CASTLE is famous for the grandeur of its position, its ancient foundation, and as the ancestral home of a long line of nobles—nine earls and seven dukes—also for its remarkably sheltered pleasure grounds and the beautiful flowery slopes in May.

The first castle was built by Robert de Todeni, standard bearer

So much for history epitomised, and now we pass to the flowery slopes. The character of the pleasant grounds of Belvoir is admirably described in the following extract from Mr. Ellers' work inserted in "Allen's Guide,"* as revised and in part rewritten by Mr. J. Potter Briscoe, F.R.H.S.—“Below the slope to the west of the castle there is a garden called 'the Duke's,' effectually secluded from view when in the castle and on every other point. A flight of steps with massive balustrades conduces to a kind of wilderness intersected by narrow footpaths, which lead to various portions of the desmesne below the now green terraces. Within a few hundred yards of the above mentioned garden is another still more secluded. The charm of these gardens consists not so much in their artificial embellishments or the beauty or variety of the flowers as in their situation. The visitor, passing through narrow avenues of lofty trees, winding about on the side of the hill, unexpectedly emerges upon a little cleared spot traversed by gravel walks and glowing with gay flowers. The walks on the side of this hill have something of a labyrinthal character, and without a guide the stranger

* R. Allen & Son, Nottingham.

must often retrace his steps in vain to find an avenue of communication with some longed for spot; a break in the foliage every now and then disclosing the magnificent castle, rising with royal grandeur far above him."

That description is generally representative of the grounds to-day, but there is a difference, for the secluded gardens referred to, while undoubtedly owing much of their charm to their position and surroundings, have been greatly extended and are rendered altogether delightful by the profusion, not of rare and tender, but simple, pleasing, hardy flowers, associated with consummate judgment and refined taste by a garden artist of long experience, Mr. William Ingram. Whoever may see those beds and flowery slopes as they were seen during a sunny day last week will be constrained to admit that with no tender exotics, and at no season of the year, could an equally delightful and thoroughly satisfactory effect be produced. It is spring gardening that strikes the visitor as being about as near perfection as man can hope to attain. The air is filled with the perfume of Violets, Primroses, and Wallflowers; the beds sparkle with myriads of pink and purple cushion-like masses of Aubrietias, sheets of bright blue Forget-me-nots, golden tufts of the yellow Alyssum, and snow-like masses of the white Arabis, with Tulips in contrasting or harmonising colours, also Daffodils, rising above them: with giant Oxlips in varied hues luxuriating in thousands, and belts of Alpine Daisies, blue, pink, and double white Anemones studding the ground and breaking through the boundaries of Box edging into the walks; with huge fleecy Saxifrages and Alpine Phloxes creeping, covering, and hanging over stones and rocky ledges. With these, and it may almost be said all other flowers that expand at this season of the year, displayed in various ways—in one place in large blocks of colour, in another in formal lines, in a third as if creeping down grassy slopes, in a fourth in great mixed masses, on rock-studded banks, and all in such profusion as cannot very well be imagined without being seen, Belvoir is made beautiful in May.

It is beautiful long before May with still earlier flowers—Christmas Roses, Winter Aconites, Snowdrops, Crocuses, Scillas, Chionodoxas, Iris reticulata, and many others that cover the ground for a time; then others spring up from amongst and around them for continuing the display, and the grounds remain attractive far into the summer, with the great profusion of hardy flowers which Mr. Ingram has been collecting abroad and increasing at home for a number of years. His object is not, as he says, to try for a great blaze of flowers at a particular moment so much as for prolonged interest during the spring months. In this he has succeeded, and numbers of visitors enjoy the remarkable floral feast, for with a noble generosity the grounds are free for all who desire to traverse the "labyrinthal walks," sheltered from the cold winds that then may blow, whether from the east, north, or west, by the great curving tree-clad eminence on the eastern spur of which the castle stands, and commands a panoramic view nearly all round for a distance of twenty-six miles.

So complete is the shelter afforded by the lofty encircling hill and shrubs and trees thereon, that at the foot of the slope where the pleasure grounds are formed, not only were Rhododendrons of the ordinary kinds seen in gardens flowering freely, but *R. Falconeri* was in such superb condition as it is rarely if ever seen under glass. Some huge trusses of its handsome campanulate flowers were unfolding, with numbers of fine buds higher up to continue the display. Camellias were similarly healthy and floriferous, covered with flowers as clean and with foliage as glossy as is ever seen under glass, and pushing fresh light green growths freely. No artificial protection whatever had been afforded, and no injury whatever had been sustained by these shrubs during the winter. Standing on the lawn is probably the finest example of its kind in the kingdom of the Japanese evergreen, with its elegant waving branches and small Box-like leaves, *Azara microphylla*. It was covered with its miniature yellowish flowers, which, though inconspicuous, filled the air with their Vanilla-like fragrance. This plant is usually grown against walls, but it needs no wall in the warm and delightful position it occupies at Belvoir. There are many other things worthy of note, but the flowers command primary attention in the spring. The beds and banks of them are made in positions from which they can be seen from different points of vantage, and the groups at distant intervals are linked, so to say, by the high grassy slope, studded with Daffodils and various other flowers, that extends to a considerable distance; and the bold masses of various colours are amply relieved by fine trees and evergreens, with Bamboos and Conifers just in the right places for contributing to render the whole appearance of the grounds, especially as seen on a bright afternoon, when the trees cast their shadows on the undulated lawn, altogether delightful, and, indeed, unique. With much thought and steady persevering work over a number of years Mr. Ingram has made the most and

best of a grand natural position at a minimum of expense, and both he and the ancient family he serves so well have good reason to be satisfied with the results achieved.

Not only in this department of the extensive grounds and gardens in his keeping, but everywhere he has converted a raw, cold, clay soil into a medium of remarkable fertility. He has turned his well-known geological knowledge to practical account, and far more than doubled, or even quadrupled, the producing power of the comparatively inert medium which he "tackled" some forty years ago. He knows, no one better, the great value of vegetable matter decayed or burned, according to its nature, and has turned all to the best account—the "mowings" from the lawns, leaves, and refuse of whatever kind that once grew and could be collected has been stored and used; nothing has been lost; and by degrees he has changed the entire texture of a once stubborn soil, and has now only to sow and plant in it to be assured of luxuriant growth.

It is a pleasure to see work so thoroughly done as at Belvoir; not conducted on mere rule and thumb methods and a matter of chance routine, but on a scientific basis, so that every stroke "tells," and by which it is known that certain results must follow, as far as weather permits (and it is certain to permit sooner or later) the means that have been resorted to, to produce them. Mr. Ingram is a veteran—a highly educated veteran—in gardening. He comes of a royal race of cultivators; but it is not because Frogmore was his home and Her Majesty his first employer, now many years ago, but because he has by close study, research, travel, and experiment made himself what he is—one of the grand old gardeners of his day and generation, but as active as a youth.

Nothing has been said about the "glass department" of Belvoir, and little can be said. There was no time to even peep into the chief range, but the Strawberry house was glanced at. It is surely one of the best, the roof descending step by step, like the shelves, and each "step" ventilated, while one of the finest of crops of one of the finest of forcing Strawberries, *La Grosse Sucrée*, was affording rich red fruit in abundance.

Nor can anything be said about the splendid kitchen garden, which was not traversed, beyond the obvious fact that fruit blossom on walls and bushes was most abundant, and that a good fruit year was then anticipated. There has since been a change in the weather; but though inclement, we will hope it will not prove disastrous. Last year, as most persons know, was the reverse of productive of hardy fruit, Apples especially; but at Belvoir all demands were met, and they are great; while at the present moment the fruit room is far from empty, and one of the firmest of Apples in it, as fresh and solid as when gathered from the trees, is *Bramley's Seedling*. However this Apple may "behave" in the South, in the Midlands it is one of the very best for late use. It is the best of all at the present time at Belvoir, and if anyone wants further testimony of this he can write to Mr. Ingram.

The day is over; hot and tired we enter the embowered home of our genial guide and enjoy his hospitality, then spend some pleasant moments in the studio of Mrs. and Miss Ingram, whose paintings and sculptures surprise those who have not hitherto seen them, and which are famed very far beyond the widespread vale of Belvoir.

It will be observed that there is a "we" in this case. Only one of the twain has yet spoken. If the other detects anything wrong—anything overdrawn or overdone—and he is very observant and critical, a leading provincial amateur, he can correct what he sees amiss, and if he cannot detect enough to find fault with for making an article for the *Journal of Horticulture*, he can "stretch it out" by adding to his observations those on a visit to Mr. A. Harding, and the Wellingtonias and Conifers, the rocky mounds and ferny dells of Orton. This little task shall be left, if he so wills it, to the "amateur." His friend and fellow traveller thinks he has done his share, and signs himself what he is, and he seeks no higher honour than that pertaining to the oldest out on earth—gardening.—A BRITISH GARDENER.

THE BLACK CURRANT MITE.

SEVERAL correspondents have of late been giving their experience of this phytoptus, which is devastating the Black Currants to such a serious extent. In 1858 I first saw its work of destruction not far from where "T. W." resides, and the gardener under whom I then served said it was very abundant there when he entered upon his duties in 1845. When he saw the diseased buds he thought they must be extraordinarily prolific bushes; but what was his surprise when summer came, and the bushes failed to produce a crop. In the winter of 1858 I procured cuttings from a source where there were no mites. The gardener had them

planted in a small garden about 400 yards to the north-west of the main one. When visiting the gardens eight years after I found these bushes quite free from mites, while those in the main garden had almost ceased to grow. "T. W." said he saw the mite so far back as 1838. Would he say was it anything abundant at that time or only in a few localities? because I know that twenty years later it was to be found in almost all gardens from Bothwell to Greenock. It has slowly but surely found its way northward and eastward until now it is almost as abundant about Stirling as it was about Bothwell thirty years ago. "T. W." mentions insects as an agent in spreading the phytopti, which I do not doubt; but I consider wind to be the most powerful agent we have in spreading these creatures, which are so minute that when migrating from the old and dry buds to the young buds a very gentle breeze will carry them a long distance. My reason for considering the wind an agent is observing how they have spread from the west to the east. The first I saw in this locality was at the west side of the town, about fifteen years ago. I found them some miles farther west a few years before that, and as the wind is generally from the west at the time of their migration it accounts for their eastward spread. The exact time the mites leave the old buds to take possession of the new I cannot say, but I have found mature mites and eggs in buds in October, also a week ago I found them both very abundant.

I have tried Mr. Walter Kruse's method—picking off affected buds, also pruning out shoots when badly diseased, but all to no purpose. Although for a time I kept the mites in check they ultimately proved victors, when the bushes had to be grubbed out. Buds containing nothing but eggs will not be swollen beyond the normal size, therefore will escape detection in disbudding, and will be ample to produce the parents of numerous colonies that will devastate the bushes the next season. There is no remedy equal to the rooting out and burning every bush, however slightly affected. But instead of a wholesale rooting out, if the bushes were cut down and the stumps dressed with a good insecticide the young shoots might remain free of mites. The syringing with an insecticide is impracticable, because the foe we have to contend against is very minute, and is also well protected by the overlapping scales of the bud.

This troublesome little pest is so minute, even in its perfect state, that it requires a powerful microscope to render it visible, and a very high power indeed to show its parts distinctly, and is one of those pests that become formidable to man more by their extreme minuteness than by their power. They are very sociable, and may be found in the buds in all stages of development. The egg resembles in form that of the birds of prey, being broadly oval or nearly round, smooth and shining. This in due time gives rise to the grub, which is white, almost transparent, and gradually develops into the perfect insect without undergoing the insect metamorphosis. So far as I have observed its form undergoes but little change, but its extreme minuteness renders it very difficult to trace its development. In what appears to be the perfect state it is presented to us in the form of a minute grub of a somewhat elliptical shape, tapering more rapidly at each extremity; divided throughout its whole length, excepting the head, into narrow rings, which gives it great facility of motion, although in all its movements it is extremely

four feet of the usual insect form, and these are supplied with claws, and apparently a sucker at the extremity for locomotion and security. The head terminates in front in a proboscis, which seems to be also furnished with a sucker for extracting the juices of the

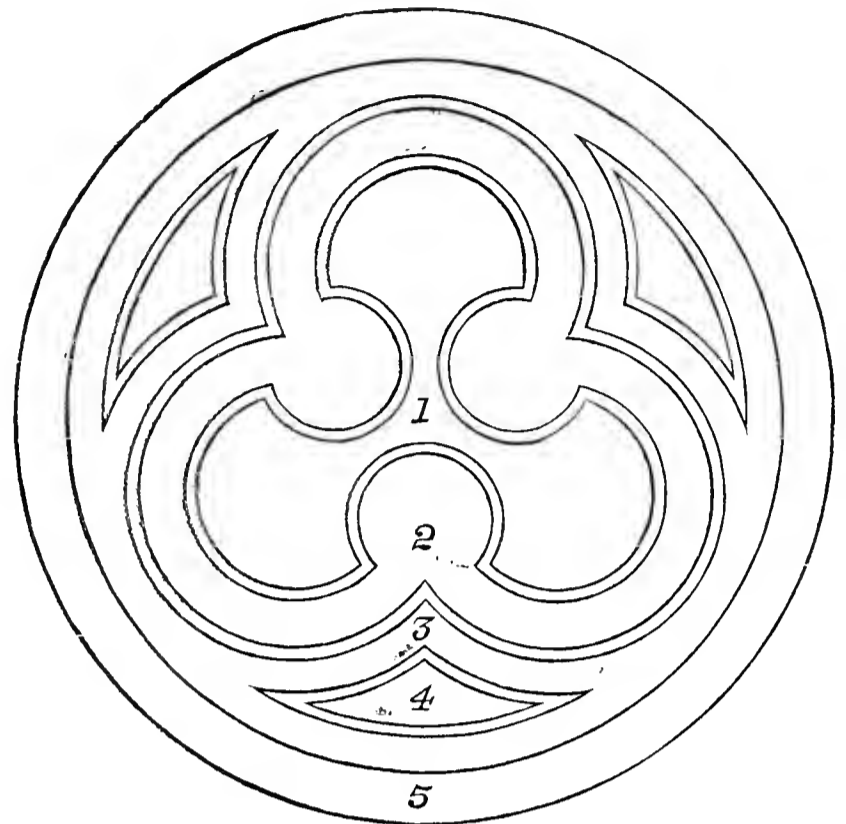

FIG. 75.—CARPET BED.

REFERENCES.—1, Alternanthera magnifica; 2, Mentha Pulegium gibraltarium; 3, Alternanthera amœna; 4, Leucophyton Browni; 5, Sedum acre elegans. Double lines, Pyrethrum Golden Feather.

bud, as well as with masticating jaws for cutting and grinding the young and tender leaves; but these parts are so minute that their structure is extremely difficult to determine. Once when exhibiting some phytopti at our monthly meetings one was observed to be more active in its movements than the others, with a very bright-looking ocellus on the top of its head sparkling like a diamond in the sun.—G. McD., *Ravenna Cottage, Stirling.*

CARPET BEDS.

FURNISHING beds in appropriate positions with low growing plants still finds favour with many persons, and especially those who desire to have distinct and varied features in their gardens. Every year inquiries come at this season for designs for carpet beds and methods of planting them. To meet the wants of those seekers for information

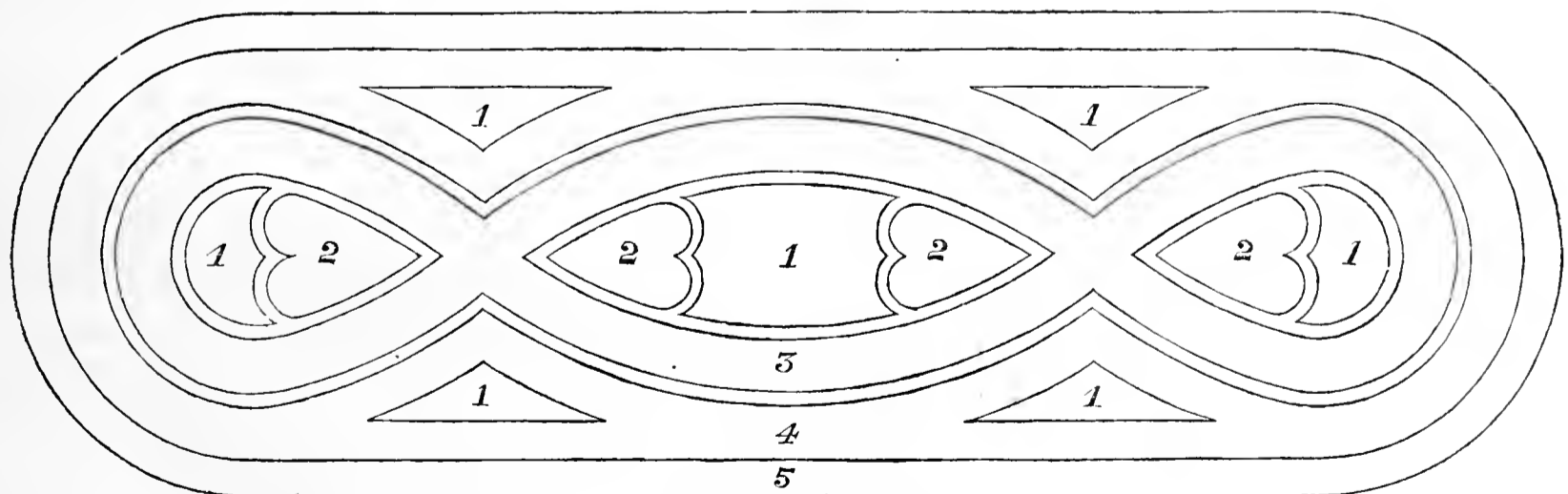

FIG. 76.—CARPET BED.

REFERENCES.—1, Blue Lobelia; 2, Alternanthera magnifica; 3, Mentha Pulegium gibraltarium; 4, Alternanthera paronychioides; 5, Echeveria secunda glauca. Double lines, Golden Feather.

sluggish and inactive. These rings are here and there ornamented with long slender hairs, and these are, like all the other parts of the creature, almost transparent.

Confined, as its perambulations are, to the little bud in which the numerous colony live and die, it is, nevertheless, provided with

and others, Mr. A. Graham, the competent superintendent of the gardens at Hampton Court, has obligingly supplied what he thinks will be useful. The diagrams fig. 75 and fig. 76 are not intricate, and the method of planting is given as suggestive, and may be varied according to taste and the plants at disposal.

THE AURICULA.

[A paper read by Mr. G. W. GILL, at the meeting of the Wakefield Paxton Society, May 2nd.]

BEFORE dealing with the cultivation of the Auricula I will briefly mention it is a mountain plant, and is described by old writers on flowers under the name of the Mountain Cowslip. It is said to be a native of the Alps, chiefly of their southern and eastern slopes, and it is also to be found in other countries farther east. The original colours of the Auricula were purple, yellow, and brown of various shades, the brown being, in all probability, a hybrid between the yellow and the purple. At that time it did not possess the rich edgings which it does now. In its florists' form the Auricula has been vastly improved and changed in its aspect by careful hybridisation, a simple process which every raiser should thoroughly understand. No plant produces seeds more readily than the Auricula, and if the seeds are properly ripened, and due care is taken with the management of the young plants, there is always a probability of a reward for labour.

In an article to the "Florist and Pomologist," the Rev. F. D. Horner says:—"Those two distant flowers, the Auricula and the Chrysanthemum, may be coupled together for the moment, because of the specially tender regard we must feel for them, as appearing the one long before and the other long after the full bloom of summer. Florist flowers extend round a good part of the year. We have not a very long gap between the latest Chrysanthemum and the earliest Auricula or the Polyanthus; while other flowers, such as the Camellia or even the Cineraria, possessing to some degree florist properties, fill up the interval. Then with the Auricula we enter upon the blooming season that stretches farther into the summer with the Tulips (in my opinion the very king of all florist flowers), followed closely by those old-established favourites the Carnation and Picotee; and then in the autumn come the Dahlia and Gladiolus. There will be much gayer scenes for us farther in the summer, but nothing has ever been, to my taste, able to overlay the memories of many an April and May with the Auricula and Tulip. In olden times I used to look forward to this period with some impatience, and afterwards the blaze of bloom and even the witcheries of the almighty Rose have not been able to console me."

We will now suppose we are on the eve of a display of show Auriculas, and I will try to give a few hints which I remember my father used to act upon when growing for shows, and of course we had his ideas well driven into us all when very young, and had to help him with his pets. March and April are the proper months for the Auricula to flower; sometimes, however, they bloom in May. Much of the work with Auriculas in March consists in taking proper care, one way and another, of the foliage. Flowers of good quality and abundance cannot be procured if the foliage is not kept in the best possible health. Do not let it be drawn for want of light or want of air, and do not let it flag for want of water. Just supply water sufficient to keep the soil moist, but never sodden. If a plant which you think is certainly wet enough should droop its foliage as if wanting water more will only hasten its death. If you turn it out of the soil you will find the neck of the plant will be almost decayed through; therefore the best plan will be to cut it back to a sound place, if there is one, and strike again under a bell-glass. In this way you will be able to save the least head with hardly a ring of neck to it.

The foliage is very liable to snap if exposed to strong winds, and would, therefore, do serious injury to the plant. Neither the Auricula nor the Polyanthus can bear having their leaves broken and twisted about with the wind, therefore this danger must be guarded against. Those who grow Auriculas in houses will often find the sun too powerful for the foliage towards the end of March. I do not like to see it much distressed by hot sun, though, as a rule, it will freshen again at night. I used to throw a shade on the glass if necessary, without shutting out the light; I found newspapers, fastened inside the top of the house, answer the purpose as well as anything. If, however, Auriculas have plenty of ventilation they can bear an amount of sunshine that would burn them if they were so shut up so as to allow no current of fresh air to pass over them.

One of the first and most important steps towards securing a fine bloom is judiciously thinning the pips. Nearly every Auricula, like the Carnation and Picotee, will give more pips than it can properly expand; and it is as unwise to leave a very large truss of Auriculas unthinned as it would be for any gardeners to leave every berry on a large bunch of Grapes. There is no gain at all, but much confusion among the pips. From five to ten flat pips are a much better show than a muddled mass of bloom. Thinning must be a daily operation among the plants. There is some responsibility in choosing what pips shall be left, and the best cannot with certainty be picked out when the operation first becomes necessary. The small central pips underneath the larger ones may with safety be singled out, as they are generally the weaker and smallest. Pulling out the pips is not always safe, as more may be taken than is wanted. Be careful to have only one neck between the points of a pair of small narrow-pointed scissors (I always carry a pair in my pocket for the Carnations and Picotees). I have frequently seen two or more pips taken off by doing the work hurriedly and carelessly. Pips of every promise in the bud may prove faulty when opened. Some people may, perhaps, think it best to disbud after seeing the pips expand, but anyone would then be able to see the gap in the truss; besides, it would have robbed the plant of unnecessary support, and thus tend to lessen the size of the remaining pips.

No Auricula, however strong, should be allowed to carry more than one truss, the second would ruin the plant; besides, all the pips would

be of inferior size and not fit to show. During my last spasmodic effort to grow Auriculas I let all the pips go and run wild, as it were; the plants were weakened and neglected, and the result is "gone for ever."

I remember the Rev. F. D. Horner (the best authority on the Auricula) saying, "Every grower, whether of a dozen or a thousand plants, and whether he means to exhibit or not, should be determined to take as much pains as if he did. Nothing less will make the bloom satisfactory to him. It is the poorest mistake and the most pitiable of excuses to say, 'I do not grow them for exhibition, so they will do well enough for me.'"

Many other attentions may be paid to the plants in the months of March and April, such as freeing a truss entangled by its guard leaf, that is the leaf that rises on the blooming stem with the pips, and which bends slightly over the bloom as if for protection, or there may happen to be a deformed pip which may want cutting out. Sometimes the plant will require a little earthing up to any new root striking out above the soil, turning the plants round to render their growth equal on all sides. Such little matters as these and others which may seem but of small detail, and which would be too tedious to name, are nevertheless of much importance taken collectively, and tend greatly towards attaining the high culture and finish which I have seen gained by constant and delicate care, and not by any rough or excitable effort. I have found that anyone wishing to be successful in growing either Auriculas, Tulips, or Carnations and Picotees must make it a duty to look over his stock at least once a day and perform any little act of kindness. During the flowering season nothing prevents my attending to my Tulips one or twice daily. Indeed very often, perhaps, as many as half a dozen times a day, and, of course, Auriculas require it quite as much as the Tulip.

We will now suppose we have the Auricula in full bloom, and a few hints as to the method of packing and carrying the plants for exhibition may not be out of place. Although I have not been much amongst Auricula showing for a long time I have had good cause to remember the time when I tramped many weary miles with a hamper full of Auriculas in full bloom on my head to shows around Wakefield, and I knew then the penalty of any damage done to them during the time they were under my care. Of course I am alluding now to the "good old days" of no railways.

The trusses are first tied to a stick, wrapped with cotton wool at all points of contact with the stem, so as to avoid any abrasion. Soft worsted should be used for tying. The stick should reach up to the footstalk of the truss, on which the pips must be very carefully parted with cotton wool gently placed between each pip. Every one must be so embedded as to be beyond the risk of being rubbed by or of rubbing any of its neighbours. The plants may now be placed side by side close together to prevent jostling in a basket, hamper, or box.

Now we have the Auriculas ready for judging I will explain their properties, but before doing so, and for the benefit of those not intimate with the florist type of Auriculas, I will briefly give a description of the various classes of which they are comprised—viz., the white edge, grey edge, green edge, and the self class. The edge determines the class of the flower, and it is a green, grey, or white edge according to the absence of or quantity of the meal upon it. The selfs are a class in which the body colour is carried through without any change of shade from the paste to the petal edge, but in their comparative plainness there is no lack of beauty.

(To be continued.)

ROYAL HORTICULTURAL SOCIETY.

MAY 12TH.

SCIENTIFIC COMMITTEE.—Present: Dr. M. T. Masters, in the chair; Mr. McLachlan, Dr. Plowright, Mr. Blandford, Rev. W. Wilks, Mr. Pascoe, Rev. W. Dod, Sir J. Llewellyn, Mr. Morris, Rev. G. Henslow (Hon. Sec.), and Mr. A. Buchanan (visitor).

Growth in Darkness.—Dr. Masters received a communication from Gloucestershire, in which it was stated that wooden props in a coal mine at a depth of 1000 feet had sent out shoots with perfectly blanched leaves. They had grown vertically upwards, and proved to be Oak and Sweet Chestnut. He also exhibited a large mass of interlacing roots, apparently of a Lime tree (judging by their bitterness and mucilaginous character), which had grown underneath the floor of a house in Bayswater. No tree was known to be anywhere in the neighbourhood. It was suggested that the root had grown along some drain-pipe, and finally found an exit where it could develop into branches.

Acacia dealbata.—Dr. Masters showed flowering branches from a tree which had been killed down to the ground ten years ago, but had sent up suckers. These proved to be hardier than the original plant, as they were uninjured during the past winter, and were now in full bloom. As another instance of a late recovery he mentioned an *Ailantus glandulosus*, which sent up suckers fifteen years after it had been cut down.

Malformed Narcissi.—Rev. W. Dod exhibited specimens of different varieties of Narcissus, showing a constriction of the mouth of the trumpet or "corona." It was suggested that it might be due to some check or enfeeblement, since it was always the later flowers which exhibited the peculiarity. An analogous constriction in corollas sometimes occurs in flowers reverting to self-fertilisation—as e.g., in *Gentiana Andrewsii*.

Excrescence on Willows.—Mr. Blandford exhibited a branch with a tumour-like growth 3 to 4 inches in diameter. They appear to be common on Willows by the river Meuse. It was suggested that a species of saw

fly might prove to be the cause. Mr. MacLachlan undertook to report further upon it.

Oak Wood Destroyed.—He also exhibited a piece of Oak completely converted into powder by attacks of *Lyctus canaliculatus*. It is a beetle which causes great mischief to gun stocks in Birmingham. He also showed specimens of wood from barrels perforated by *Carpophilus hemipterus*. In a previous case the staves were perforated on both sides; in the present instance the attack by the insects was made after the barrels had been completed, as the perforations only occurred on the exterior.

Primrose Seedling.—Miss Woolward sent a new and remarkable form of a Primrose which accidentally appeared in a cottage garden at Belton, near Grantham. Its peculiarities consist in the corolla lobes being red below and yellow above, as well as in possessing a sweeter and more powerful perfume than most varieties.

Heterocismal Fungi.—Dr. Plowright exhibited specimens of *Puccinia Digraphidis*, *Soppitt.*, on the leaves of *Phalaris arundinacea*, which were found by Dr. D. Franzschel near Wiborg in Finland, growing in the vicinity of *Æcidium Convallariæ*; also specimens of *Puccinia Agrostidis*, *Plow.*, on *Agrostis vulgaris* collected by the same gentleman near Lewasehow in Russia growing in the vicinity of *Æcidium Aquilegiæ*. He further stated that he had this year produced the *Cœoma Laricis* upon Larch by infecting this plant with the germinating teliospores of *Melampsora Betulinæ*, the converse experiment of producing the *Melampsora* on Birch from the spores of *Cœoma Laricis* having been made last year. This culture is the more interesting, as it shows that the Larch is the host plant for the æcidiospores of two species of *Melampsora*. Hartig had previously demonstrated that a *Melampsora* on *Populus tremula* similarly affects the Larch foliage.

"Antibligh," a Preparation for the Destruction of Mildew.—A visitor, Mr. A. Buchanan of Glasgow, was invited to give an account of a preparation recommended by Mr. Tait of Oporto. It was found to be beneficial to Vines in the north of Portugal, and as the Potato disease was due to another species of *Peronospora*, it was suggested as a remedy for it. He read a communication presented to the Highland Agricultural Society in which the results from its use were described as beneficial to port wine growers, as well as being destructive to mould on trees, &c. He gave a description of the composition of antiblight, which consisted of lime, flowers of sulphur, and sulphate of copper. The sulphate of copper disappears, and is replaced by a hydrated oxide of copper. The preparation is used in the dry state instead of being in solution, which, excepting the sulphur, is apparently the only appreciable difference between "antibligh" and other well-known preparations. There appears to be a certain danger in its use, in that if the powder be not ground sufficiently fine, small particles of sulphate of copper may be left on the foliage, unaltered, which destroy it. These have, therefore, to be sifted out, the finer powder being alone used. The dispersion of the powder has to be effected by means of bellows and fans of peculiar construction.

It was observed by Dr. Plowright that the flowers of sulphur, though destructive to the oidium upon Vines, would have no effect upon the Potato disease. He also referred to the extended use of preparations of sulphate of copper on the continent, as—*e.g.*, for Tomatoes, the foliage and fruit of which are dressed with it. The practice is even adopted of painting the Vine poles, as this has been found to lessen the disease. Sulphate of copper is also largely used in America.

Mr. Dod described his experience with similar materials, only used wet, in the following proportions:—3 lbs. of sulphate of copper, 10 gallons of water, and 2 lbs. of quicklime. Having applied it to growing plants of tender foliage liable to mildew it proved injurious because the sulphate of copper had not passed into the hydrated oxide. He added that flowers of sulphur, though an old remedy for foliage, proved injurious to roots, paralysing root growth by the sulphur probably becoming oxidised and giving rise to sulphurous acid. He suggested that it should never be used as a top-dressing. Bulbs thus arrested had been exhibited at a previous meeting.

Having heard Mr. Buchanan's account the Committee expressed their willingness to give publicity to his statements; but they did not consider there was sufficient novelty in the preparation to justify them in recommending experiments to be carried out at the Society's gardens. Moreover, the question appeared to them to be rather more of a commercial than scientific nature. The Committee, however, thought that if private cultivators would undertake to try it, its true value might be soon discovered by testing the powder in various ways on different plants, as well as by using the liquid preparations for comparison, to discover if it were really preferable to the latter or not.

PREPARING FOR BEDDING OUT.—Spring flowering plants that have survived the winter are later in flowering than usual, and this may seriously interfere with the work of preparing and refilling the beds for the summer. Where hardy or half-hardy edgings are used, these including Sedums, *Cerastium*, *Herniaria*, and *Golden Pyrethrum*, these might be dibbled in at once, and would then be well established before very hot weather may reasonably be expected. When the centres of the beds are cleared of their present occupants there need be no digging, a surfacing of decayed manure or leaf soil being worked in with the trowel as the planting goes on. This plan frequently answers best in cases where the soil is of a heavy nature and has not been for some time roughly dug up. Digging such soils just prior to planting is most unwise. Poor quickly drying soils ought to have a good dressing either of rich compost, decomposed manure, Mushroom bed manure, or the best sub-

stitute available. Designs for carpet beds might also be laid down now and marked with a tracing of silver sand, the groundwork being then filled in with some of the hardy kinds of carpeting plants previously mentioned in connection with edgings. It should be remembered that quite small divisions of most of the kinds named dibbled out rather thickly and neatly are preferable to stronger patches put out at wider intervals, the former being the first to regularly cover the ground.—I.

STRAWBERRY BOTHWELL BANK.

I HAVE perused the article by "G. McD." at page 365 on the above and other Strawberries, but fail to see that he has proved the identity of Bothwell Bank. I do not mean to affirm that Bothwell Bank is identical with either President, Admiral Dundas, or Dr. Livingstone, but there are grounds for suspecting it to be one or the other. The following unsolicited information I obtained when visiting some of the Clydeside orchards lately is interesting. I had a long chat with Mr. Alex. Forrest of the Gill orchard upon different kinds of fruit, particularly Strawberries, and I might, in parenthesis, here say that he is greatly in favour of selling his fruit direct to the consumer, and puts much emphasis upon people making their own preserves, which would be greatly to their advantage.

Strawberry Sir Joseph Paxton grew and bore well with him. Bothwell Bank was also a splendid Strawberry, but it became subject to mildew readily in wet seasons. Interposing, I said, "As most large Strawberries do." Continuing, he said that he, as well as others, had it direct from the gardener at Bothwell Bank, who had also sold the whole stock to an Edinburgh firm. When Mr. J. Scott (another extensive fruit grower of my acquaintance) heard of this wonderful Strawberry, visited Bothwell Bank to see it growing, he exclaimed in his usual vernacular, "Naither mair nor less than my seedling."

Now comes the mystery, How was it Mr. Scott's seedling? He had a bed of seedlings, some thousands, in a space of 6 yards completely matted with weeds, and out of the lot only one fruited, neither a red nor a white berry, but a nasty pale colour between the two. Seeing the inferior sorts, and the old fashioned way in which he grew Strawberries, I remonstrated with and invited him to visit my garden. Accepting the invitation, he was simply delighted at the large crops and huge berries, from which I gave him what plants I could spare, with the promise of more of Dr. Hogg, Mr. Radclyffe, President, Admiral Dundas, and Dr. Livingstone. Contrary to my advice, he dug in an old plantation of Black Prince, and planted the others there.

In the autumn of that year he went to America in order to export Apples to this country. When he was absent I took according to promise many Strawberry plants, including Dr. Livingstone. I found the son busy laying in other varieties, and assisted him to put in those I had taken. When we came to Dr. Livingstone with no name, and in answer to what he would call it, replied "Call it The Seedling." The following year when all had fruited Mr. Scott told me that he could see no difference between Admiral Dundas, President, or Dr. Livingstone, much to my surprise, and immediately added, "his seedling" was superior to any, which, as the saying is, took my breath away.

It must be observed that the trial Strawberries were grown upon Strawberry-exhausted soil, while the others were planted upon rich new soil. Just as I had been generous so was Mr. Scott. He at once offered me plants of "his seedling," which I readily accepted, and true to its character it bore well the following year, proving itself equal if not superior to Dr. Livingstone, but much like it. I thought about Mr. Scott's solitary seedling, and the other things already mentioned. I went direct to see it, and was astonished to see so many fine fruiting plants. "Come, give me the history of this seedling." "Oh, here is the 'tally pin' still marked 'My seedling.' My son is very particular, and would not make a mistake." I examined it, and found it to be the same pin and same writing that I had superintended the year previous. Such is the history of Mr. Scott's "seedling." Now let us see who will prove Bothwell Bank and Dr. Livingstone to be distinct Strawberries?—W. T.

[We have received a very interesting letter on the origin of this Strawberry. Mr. T. Chisholm, we are told, found it as a chance seedling at Bothwell Bank in 1875, and did not take it there from Camperdown, as has been suggested, for the very good reason that he was never employed there. Our informant still grows this Strawberry from the stock he obtained direct from the seedling plant. The fruit, he says, is nothing like President, but much more resembles that of James Veitch. Mr. Chisholm is now engaged in growing fruit in California. This is all we can say on the subject this week.]

HORTICULTURAL SHOWS.

BATH.—MAY 13TH.

AS far as the number and quality of the exhibits and arrangements generally are concerned the Bath shows are always successful, and the display on the date named was highly creditable and thoroughly appreciated by the crowds of fashionably dressed visitors who thronged the tents. The class for sixteen stove and greenhouse plants, ten of them to be in flower, was fairly well filled, but Mr. J. Cypher, Cheltenham, was easily first, he having noble specimens of *Kentias*, *Latanias*, and other Palms, with a front row of *Ericas*, *Hedaras*, *Anthuriums*, and *Aphelaxis*, all moderately large and in perfect condition. Mr. J. Currey, gardener to Colonel Pepper, Salisbury, was second, his most attractive plant being a large, grandly flowered

Tremandra ericæfolia. Messrs. E. S. Cole & Sons, Bath, were third with a creditable lot of plants. The best nine specimen flowering plants were staged by Mr. W. McD. Bennett, gardener to C. W. Mackillop, Esq., Bath, who had Clerodendron Balfourianum, Azaleas Due de Nassau and Due de Brabant, Erica ventricosa magnifica, Boronia heterophylla, Bougainvillea glabra, and Rhododendron Gibsoni, in good condition, all being well trained and very freely flowered. Mr. G. Tucker, gardener to Major Clarke, Trowbridge, was a creditable second, included in his collection being good specimens of Ericas ventricosa alba and Cavendishiana. With six specimens Mr. Cypher was well first, these consisting of Azalea Charles C. Buch, Erica Cavendishiana, Pimelea spectabilis, Aphelexis spectabile, Hedaroma tulipifera, and Anthurium Schertzerianum Cypheri, all grandly flowered. Mr. A. Hawkins, gardener to Mrs. Jolly, was second, the seldom seen Aotus gracillimus figuring conspicuously in this exhibit; while a third prize was awarded to Mr. J. Currey. A very fine specimen of Pimelea spectabilis gained Mr. Cypher a first in the class for one specimen flowering plant, Mr. Bennett being a good second with Clerodendron Balfourianum. Mr. Cypher was also first for four Heaths, and Mr. Bennett for a single specimen. Fine-foliaged plants were not so well shown as usual. Mr. J. Currey took a first for nine plants, the second prize going to E. S. Cole & Sons; and a first was awarded to Mr. W. Marchant, gardener to Jerome Mureh, Esq., Bath, for a single specimen, this being a handsome plant of Kentia Fosteriana.

Roses in pots were remarkably good. In the class for a group arranged for effect, to occupy a space 12 feet by 6 feet, and arranged for effect, there were two admirable lots staged, the Judges having considerable difficulty in deciding which should be placed first. The coveted award was made to Mr. S. Kerslake, gardener to the Rev. E. Handley, Bath, whose arrangement was the least formal, the plants also being beautifully flowered, several good Teas adding considerably to the effect. The second prize was awarded to Mr. Davis, gardener to Dr. Budd, Bath, who had capital healthy plants and fine blooms, but which were staged up too rigidly. Mr. Davis, however, was well first for six trained specimens. Mr. S. Kerslake was a good second. There was also a good display of cut blooms from Messrs. Davis, Dagger, and Hooper, the principal prizewinners in the classes. Azaleas, again, are always a great feature at this Show, but the competition was scarcely so keen as usual. Mr. J. Cypher was easily first in the class for six varieties, with large, somewhat flatly trained specimens, crowded with flowers and perfectly fresh. Mr. W. McD. Bennett was second, his best being a perfectly flowered pyramid of Madame Van Houtte, while a third prize went to Mr. Currey. The best four specimens were shown by Mr. G. Tucker, Mr. W. Marchant being a creditable second.

Orchids, though shown remarkably well by a few exhibitors, were not so plentiful as on the last two or three previous May Shows, Mr. S. Kerslake having matters very much his own way. He was the only competitor with a group of Orchids, Palms, and Ferns arranged for effect, and this fully deserved the award of first prize made to it. The same thing occurred in the class for six varieties, consisting, in this instance, of Cattleya Mossiæ, Anguloa Clowesi, Odontoglossum Alexandræ, Cattleya Skinneri, Odontoglossum vexillarium, and Lælia purpurata, all grandly flowered. There was good competition with four Orchids, though Mr. Kerslake was again well first, having Dendrobium suavissimum with sixteen flower spikes, Lælia purpurata carrying six grand spikes, Aerides Fieldingi, and Cypripedium caudatum. Mr. J. Crispin, Bristol, was second, and Mr. G. Harrell, gardener to J. T. Holmes, Esq., third, both exhibiting very creditably. A fine form of Cattleya Mossiæ with twelve blooms gained Mr. Kerslake the first prize in the open class for a single Orchid, and the same distinction was won by this exhibitor in a similar class for amateurs, this time with a grand Lælia purpurata.

There was a great falling off in the class for large flowering Pelargoniums, though Mr. G. Tucker had highly creditable plants, and was first for six varieties. Mr. J. Edwards, gardener to T. Williams, Esq., Bath, was second, and Mr. E. Hall, Bath, third. Mr. Tucker was first for Calceolarias, and Mr. Marchant second; the last named being a good first for Cinerarias. Ferns were fairly well represented, Mr. Tucker being easily first in both classes. Messrs. E. S. Cole & Son also showing well. Groups were quite a feature, one large tent being wholly devoted to them. There were four competitors with these arranged for effect on a space not exceeding 200 square feet, but Mr. J. Cypher was a long way ahead of the rest, both as regards arrangement and the quality of the plants used. Orchids in great and valuable variety were principally used, Maidenhair Fern providing a groundwork, while a few graceful Palms served to relieve any flatness there might otherwise have been. This probably was the most attractive group yet seen at Bath. Mr. T. J. Tate was second; the third prize going to Mr. Currey for an arrangement displaying more taste, but which occupied far too much space, the plants being too few in number. Three competed with groups to occupy a space of 100 square feet, Mr. W. Marchant leading with highly creditable arrangement of well grown plants; Mr. E. G. Peacock being a good second, and Mr. E. Hall third.

There was a capital display of fruit. Mr. J. Shellard, gardener to Mrs. Hill, was first for six pots of Strawberries, and for a dish of the same Mr. F. Perry, gardener to Captain Spicer, Calne, was first, having fine fruit of Auguste Nicaise. A grand dish of Auguste Nicaise was sent by Mr. T. Wilkinson, gardener to C. C. Tudway, Esq., Wells, but arrived too late to be judged with the rest, but was deservedly awarded an extra prize. Mr. R. H. Taylor, Bath, was first in the class for Pears, winning

with a well-kept dish of Beurré Rance. Apples were largely shown. A very showy dish of King's Seedling, staged by Mr. S. King, and which bore a resemblance to imported fruit, being awarded first prize; a good dish of the handsome Streaman's Pippin, another seedling staged by Mr. J. Rogers, being second. The first prize collection of nine varieties of vegetables, shown by Mr. A. Miller, gardener to W. H. Long, Esq., Trowbridge, was very superior and well set up, nothing apparently attracting greater attention. The varieties were Potato Suttons' Seedling, Tomato Old Red, Broccoli Late Queen, Turnip Early Milan, Pea Carters' Stratagæm, Kidney Beans Canadian Wonder, Mushrooms, and Asparagus. Mr. T. Ricketts was second, and in the class for six varieties Mr. H. Howell had a first prize. Classes were provided for Asparagus, Potatoes, Beans, Peas, Cucumbers, and Mushrooms, the leading exhibitors being Messrs. Perry, W. Pyatt, W. Haskell, J. Long, A. Hawkins, and E. G. Peacock, some fine produce being shown.

The most noteworthy non-competitive exhibits were those by Messrs. R. Veitch & Sons, Exeter, and J. Cooling & Sons, Bath. The former had a group of Japanese Maples, hybrid Rhododendrons, Boronias, Acacias, Tremandras, Orchids, and a variety of other serviceable pot plants, and also an attractive display of the showy and hardy Primula Sieboldi in great variety, and numerous other hardy herbaceous and rock plants. Messrs. Cooling arranged a very pretty group largely composed of Palms, Ferns, Maples, Roses, Azaleas, Pimeleas, Caladiums, Dendrobes, Odontoglossums, Cypripediums, and Cattleyas. Particularly noteworthy was the plant of Cattleya Mossiæ, Cooling's variety, this form having an extra bold and beautifully marked lip; certainly superior to any seen in the Orchid tent.

MANCHESTER.—MAY 14TH TO 20TH.

THE annual Whitsuntide Show opened on Friday last, and with the exception of the magnificent collections of Orchids, shows a falling off from previous years. First in the Show was the premier prize group of plants exhibited by Mr. Peter Blair, gardener to the Duke of Sutherland, Trentham. In the centre of the group was a fine Palm, and nestling at the base were fine plants of Cymbidium Lowianum; Asparagus plumosus was freely used, and peeping out were choice Odontoglossums and Cattleya Mendeli. Two beautiful pans of the Trentham variety of Coelogyne cristata were noticed in the background, and farther beyond Palms, &c., gave the group the necessary effects. There are Orchids freely used throughout. The second prize group staged by Mr. Holmes, gardener to G. Hardy, Esq., Pickering Lodge, Timperley Lodge, Cheshire, exceeded the first prize in the choice Orchids; Cattleyas, Cypripediums, and Odontoglossums are to be seen also, with Dendrobium Devonianum, whilst the background was filled with choice Palms, but the light elegant arrangement as seen in Mr. Blair's was here wanting to some extent. The third prize group came from Mr. J. Currey, gardener to Col. Pepper, Salisbury. The arrangement was too flat.

Orchids were really grand, and we could linger for hours admiring the glorious plants here brought together. The premier prize for twelve Orchids was taken by Mr. Holmes with Cymbidium Lowianum, fine; Lælia purpurata, two plants, twenty-six and thirty flowers; Dendrobium thysiflorum, very fine, with twenty-eight spikes; D. Bensoni, thirty spikes; D. fimbriatum giganteum; Cattleyas Mendeli and Mossiæ, fine masses of bloom; Dendrobium Devonianum, and Odontoglossum citrosimum. Mr. Holmes was first for ten Orchids, for six, for ten Cattleyas and three Vandas, and for one stove plant with Dendrobium fimbriatum oculatum. The second prize for ten Orchids was taken by Mr. Boardman, gardener to Mrs. Hodgkinson, Bowdon, Cheshire, noticeable being Vanda suavis and a fine variety of Dendrobium Wardianum. Mr. Boardman was also second for six Orchids.

Stove and greenhouse plants were poorly shown in the amateur classes, the first prize for eight being taken by Mr. J. Currey, who had Tremandra ericæfolia very fine, and good examples of Ericas profusa and Victoria. Mr. Currey was also first for ten fine-foliaged plants. The amateurs' groups of plants were most beautifully arranged, and would do credit to any exhibition. The first prize was taken by Mr. Thomas Agnew with a striking arrangement arranged in the best possible manner. Second, Miss Lord, Ashton-on-Mersey, with a graceful arrangement, but perhaps not so noble-looking. The same lady took first prize for six Azaleas and first for one greenhouse plant. For ten Roses in pots, Mr. J. G. Wood, gardener to J. Brown, Esq., Longfield, Heaton Mersey, had a good display. Mr. J. Jellicoe, gardener to F. H. Gossage, Esq., Camp Hill, Woolton, had the best twelve table plants. Calceolarias may be passed over without comment. Nurserymen made up the attraction of the Show, those prominent being Mr. James Cypher, Cheltenham, who had a magnificent display. He is first for ten stove and greenhouse plants. Others in the Exhibition are Mr. B. S. Williams and Son, Messrs. R. T. Ker & Sons (who had the first prize for grand Crotons), Mr. C. Turner, Slough; J. Waterer, Bagshot, Surrey; Ryder and Sons, Sale; A. J. Bruce, Chorlton-cum-Hardy; Liverpool Horticultural, Charlesworth; Shuttleworth, Bradford; Stott specialities and others. The fruit classes and some other exhibits will be referred to next week.

SOUTHAMPTON.—MAY 18TH.

WHAT is termed the spring Exhibition of the Royal Southampton Horticultural Society was held in the Society's grounds, Westwood Park, and in a horticultural point of view must be considered a success. The exhibits, both in point of numbers and quality, were an improvement on former years, a bright display being the result.

Groups of miscellaneous plants arranged for effect were the leading feature. Classes were provided for two classes of exhibitors. In the larger class Mr. E. Carr, gardener to W. A. Gillett, Esq., Fair Oak

Lodge, Bishopstoke, was well ahead, having a pleasing arrangement of Orchids, Palms, and Ferns, all good in quality and much more lightly arranged than is usually the case. Mr. B. Ladhams, florist, Shirley, was a good second, having a bright well arranged collection. Mr. E. Wills, Shirley, third. In a smaller class Mr. G. Busby, gardener to F. Willan, Esq., Thornhill Park, Bitterne, was first; Mr. T. Hall, gardener to the President, S. Montagne, Esq., South Stoneham House, Southampton, both competing in a spirited manner. Spiræas, Pelargoniums, Calecolarias, and Gloxinias were capitally shown by Messrs. Hall, Ladhams; Amys, gardener to the Hon. Mrs. Elliott Yorke, Hamble Cliff, Netley; and Mr. Carr, the latter exhibiting especially fine plants.

Herbaceous cut flowers in twelve varieties made a good display, the best coming from Mr. Maurice Pritchard, Southbourne, Christchurch, Cypripedium calceolus, Trollius japonicus, T. europæus, and Trillium grandiflorum being the most noteworthy. Mr. Ladhams followed for second honours. Mr. H. W. Stratton, Portswood, exhibited a splendid box of Maréchal Niel Rose blooms, taking first prize in that class. Miss Kate Golding, Portswood, secured first prize for an epergne decoration. Mr. Rogers, Red Lodge Nurseries, contributed a splendid collection of Rhododendrons and hardy shrubs in pots, which made a fine display the entire length of one side of a large tent, and two dozen boxes of cut blooms Rhododendrons. Mr. Ladhams staged some fine Pelargoniums, "not for competition." Mr. Amys had a good collection of vegetables, consisting of Tomatoes, Asparagus, and Broccoli, and was awarded an extra prize. The officials as usual worked hard to make the Show a success, especially Mr. Fuidge, the energetic Secretary.



HARDY FRUIT GARDEN.

STRAWBERRIES.—If extra large fruits are required for exhibition or other purposes the plants must now be liberally supplied with liquid manure. The Strawberry is a gross feeder while fruiting, and any extra attention in this way during the next few weeks until the fruit is half grown will be well repaid. Great care must be used in supplying liquid manure after the flowers fall, or a deposit will be left on the fruit, and it will be spoiled. If liquid manure is not obtainable a good dressing of Thomson's Vine manure should be given and washed down to the roots by rain, or by applications of clear water. All the beds will now have a good hoeing and cleaning, and some liquid manure where possible, and these will be mulched at once to prevent further loss of moisture by evaporation.

RASPBERRIES.—These also benefit largely in a dry season if treated in a similar way to that above recommended for Strawberries. Both fruits like a deep moist soil, with a good supply of nourishment. Very few growers have time to water Raspberries, but all can do something towards keeping the roots cool and moist by mulching as soon after heavy rains as possible, giving the beds a good hoeing previously. Any long strawy litter or manure may be used for this purpose; the richer it is the more benefit may be expected. Probably the best that can be had is that which comes fresh from the cowsheds; but grass mowings are better than nothing.

GOOSEBERRIES.—The earliest varieties will soon be large enough to gather for tarts and similar purposes. We like to gather the large green and white kinds for this purpose as much as possible, reserving only a few of them to ripen, as they quickly spoil in bad weather when ripe much sooner than the red kinds; but all required for dessert are benefited if heavily cropped by having half the fruit gathered in a young state, and this is especially the case with Warrington, which is still one of the best flavoured and most useful varieties.

A sharp look out must be kept for caterpillars, which soon do immense damage in a plantation if unchecked, not only by spoiling this year's crop but weakening the trees for one or two years afterwards. Handpicking is still the best remedy when taken in time, but where large quantities of trees have to be attended to this is not always possible, and hellebore powder has to be applied, either by damping the trees and dusting it on the infested parts, or by mixing half a pound in 3 gallons of water and applying it gently with a syringe, keeping the mixture well stirred. As this substance is a dangerous poison it should only be applied when the fruit is small, and if heavy rains do not wash it off the trees must have a good rinsing with a syringe and clean water.

FRUIT FORCING.

FIGS.—*Early Forced Trees in Pots.*—When the first crop fruits have all been gathered remove the loose portions of previous mulchings, and supply well sweetened manure, which will encourage root action and assist the trees to perfect the second crop. If the trees have become infested with red spider or scale thoroughly cleanse them by means of softsoap dissolved in water at the rate of 2 to 3 ozs. to the gallon, using it with a sponge or a partly worn clean brush, and syringe twice a day. Although a second crop is serviceable, a good first crop is much more valuable, therefore be content with a few fruits or none at all, if the trees have been severely taxed. Growth after this period

will necessitate frequent attention to stopping and training, as the best Figs are always produced on sturdy young shoots fully exposed to light and air.

Planted-out Forced Fig Trees.—The fruits on trees started at the commencement of the year are swelling, and must have a higher and drier atmosphere, but care must be taken to afford plentiful supplies of tepid liquid manure, and to syringe the foliage regularly, as any sudden check is against the fruit finishing well. As the Figs ripen it will not be advisable to wet them if it can be avoided, nor is it necessary, as atmospheric moisture can always be secured by keeping the mulching, walls, and paths properly moistened, and this can be prevented condensing on the fruit by maintaining a steady circulation of air with moderate fire heat. When grown in a hot, dry house the trees soon become infested with red spider and scale, and as a consequence the ripening period is shortened, and the trees simply rest because exhausted, the second crop is consequently puny, rusty, and unsatisfactory; but treat Fig trees liberally, ventilate freely, expose them fully to the sun, and syringe as often as they are divested of ripe fruit, and they become perpetual bearers. To keep a Fig in constant bearing it must be continually growing, and for this reason the extension system is the best, as the leading shoots are allowed to extend without stopping until they reach the extremity of the trellis, when they are cut away after their crop is taken to make room for others succeeding them. Thus the trees are kept constantly well furnished with bearing wood always of a character affording the finest fruits.

Unheated Fig Houses.—These may be simple wall cases or more pretentious structures. The trees are showing abundance of fruits, and this, with favourable weather, afford an acceptable supply of ripe fruit in August and September. Assuming that their roots are confined to reasonable limits inside the house, and that the borders are concreted and thoroughly drained with broken bricks and old lime rubbish, the border itself not being too rich and loose, and containing abundance of sand and lime, materials upon which Figs thrive, they will require copious supplies of water and syringing twice a day. In cloudy weather dispense with the afternoon syringing, and in bright weather syringe early in the afternoon to insure the foliage drying before nightfall. Ventilate early, and insure a free circulation of air, for it is important that the leaves be well developed. The temperature may rise to 100°, but in a close atmosphere the Fig becomes sterile and useless. Train young growths a good distance apart; but close stopping in late houses is not good, as it results in the production of a number of late growths, which may not ripen properly, and as it is on these that the fruit is produced the following year every effort should be taken to insure their thorough solidification. The safest plan is to secure firm short-jointed wood, and allow the points to grow up to the glass without touching it, in which position they will form a number of Figs ready for swelling in spring. If this does not take place the points of the shoots may be pinched out in late August or early September, relying on Figs being pushed from the firmer wood after the second crop Figs, which never ripen on these trees, have been removed.

VINES.—*Houses of Ripe Grapes.*—Afford fire heat only to prevent the temperature falling below 60°, and to admit of a free circulation of air. Do not allow the border to become very dry, but keep it moist, and mulch with rather dry litter from which the manure has been removed. It will retain moisture a long time, and lessen the evaporation from the surface of the border, though a little moisture in the atmosphere is not injurious to the Grapes and is highly beneficial to the foliage, which must be kept clean and healthy. Fumigation must be resorted to if thrips appear; for red spider there is no remedy so safe as the tedious process of carefully sponging the leaves with soapy water. Heating the pipes and brushing them with a cream of sulphur and skim milk must be done very carefully, as it turns white Grapes purple, and hardens the skins of all so as to render them liable to crack and to become spotted. Place a double thickness of herring nets over the roof lights where Black Hamburgs are hanging in order to enable them to keep their colour.

Succession Vineries.—Temperature and Ventilation.—Bright weather greatly improves Vine foliage when proper regard is paid to ventilation, and utilising sun heat saves fuel. With sun heat and plenty of moisture more real benefit is derived in a week than in a month of dull weather with fire heat. The Vines being in full growth, the temperature may be allowed to rise to 90° or 95°, closing the house at 85°, employing fire heat only to maintain a temperature of 70° to 75° by day, and to prevent its falling below 65° at night, though it may recede to 60° on cold nights. These remarks apply only to Vines in full growth, as those that have Grapes approaching ripening should have a free circulation of air, those well advanced in ripening being kept cooler and drier. Admit air early in the morning, as the sun's rays act powerfully on the condensed moisture formed through the night on the foliage, causing scorching.

Watering.—Stated interval waterings answer where the known requirements from long experience have been acquired, but there are variable circumstances which upset calculations. Thorough supplies are usually afforded at starting to insure the moistening of the border materials to the drainage when the Grapes attain to thinning size, and when they are commencing to ripen. Those are essential feedings rather than watering periods, and ought to be carefully attended to, either by surface dressings washed in with tepid water, or applications of tepid liquid manure. In moisture-holding soils Vines may take no harm with those only, but inside borders of limited area require more frequent supplies of water. There are more failures from insufficient than over-watering, the borders being properly constructed and the drainage complete.

Watering twice a week in the case of those with the roots restricted to borders of limited extent, and once a week for those that have a good run of border, is not too much from the time the Grapes swell after thinning until the berries are changing colour. There is, however, a great difference in the retentive power of soils. Some loams are naturally very loose, sandy, or gravelly, and they have the usual opening materials added, as lime rubbish and charcoal, which makes them still more sieve-like; the consequence is the greater need of the watering pot. Soil will require water less frequently, but in no case must there be any lack of moisture at the roots throughout the swelling period.

Late Vines.—These will be in flower in most places. Maintain a minimum temperature of 70°. Shaking the rods twice a day will be sufficient in most cases to distribute the pollen effectively, but in the case of shy setters do not fail to resort to artificial fertilisation, going over the bunches carefully with a camel's hair brush. All old large berried varieties such as Gros Colman and Gros Guillaume, which are good setters, should be thinned whilst they are in flower, and with those that are liable to have very closely set berries it is a good plan to thin them before the flowers expand, as a practical eye can tell which flower buds by their vigour that are likely to set, and the removal of the weaker strengthens them wonderfully. Whilst the Vines are in flower do not pinch or stop the laterals, but when the blooms are fairly set remove the laterals at once, so as to prevent overcrowding.

Planting Growing Vines.—Those raised from eyes in February or March and grown in pots or turves may from now to the early part of June be planted out, giving them a good soaking with tepid water, mulching the surface with a couple of inches of short rather lumpy manure, and shade from bright sun until they become established.

MELONS.—In Houses.—When the fruit is cut from the earliest plants the old stem may be cut to a strong shoot near its base, removing as much of the old soil as can be picked out from amongst the roots, adding fresh in its place, strong, rather lumpy and well pressed down, giving a good watering. If a moist atmosphere is maintained and the plants are syringed in the morning and about 4 P.M., they will soon start freely, showing fruit in much less time than by planting afresh. If they have healthy growths they need not be cut down so closely, but laterals taken at suitable distances and the old shortened or cut away, the fresh laterals will show fruit at a few joints of growth. If, however, the plants are affected with canker or from carrying too heavy a first crop, a deficiency of water or attacks of insects are much enfeebled, it is better to remove them, thoroughly cleansing the house, placing strong plants in ridges or hillocks as advised in former calendars.

Melons always have flavour in degree of the solar heat, and the weather lately has been all that the Melon grower covets. The days have been bright though the air has been cold, necessitating the employment of fires, especially at night, as it is a great mistake to allow too great a difference between the day and night temperatures. Maintain 70° as the minimum, though 65° or even 60° will do no harm when the nights are unusually cold and the days bright, 70° to 75° by day being secured artificially, admitting a little air at and above the latter, allowing an advance to 85° or 90°, closing at 80° to 85°, yet so early as to raise the temperature to 90° or 95°. Keep plenty of atmospheric moisture in houses containing young growing plants or those swelling their fruit, gently damping the foliage, walls, floors, and closing about 3.30 P.M., or as early as safe. Feed plants liberally that have their fruits swelling, not allowing them to suffer through insufficient supplies of water, and afford weak liquid manure. Fertilise all pistillate flowers daily, ensuring a somewhat dry condition of the atmosphere, not using the knife during that period, but pinch out the points of the shoots at one or two joints beyond the fruit. Earth plants that have set their fruits, and examine the plants frequently for the removal of superfluous growths, not allowing them to interfere with the principal foliage. Shade as little as possible, and only to prevent flagging.

Plants in Pits and Frames.—When fruits are ripening they should be fully exposed to the sun by raising them on inverted flower pots with a piece of slate intervening, as the moisture from the bed is apt to accumulate in the pot, and rising through the hole cause the fruit laid upon it to decay at that part. Admit air freely, and water only to prevent the foliage flagging. If a second crop is desired encourage about four shoots from each plant from the base of the stems now bearing, and when the fruit is cut the old growths may be removed and young shoots substituted. These will show fruit on the first laterals, every alternate lateral being rubbed off to prevent crowding. If a top-dressing of fresh compost be given, supplemented with a good supply of moderately weak liquid manure at 90°, the plants will be assisted to make a vigorous second growth. A useful crop of Melons may be obtained by making up beds now of any spent material, which with mixing and turning will generate a gentle warmth, placing over it frames that may have been used for Potatoes and bedding plants, placing in each light about a couple of barrowfuls of any strong loam mixed with some old mortar rubbish or road scrapings, if deficient of grit, and pressing it down firmly. Into this, when warmed through, turn out a strong healthy plant, pressing the soil firmly about the roots, and giving a good watering. If pits are employed the surface of the soil must be brought up to a foot from the glass and the materials firmed well, so as to prevent much settling. If the weather be bright shade for a few days after planting. Seed may yet be sown to raise plants for frames at present occupied by tender bedding plants.

THE FLOWER GARDEN.

Campanulas.—Canterbury Bells, notably the calycanthema forms, are very effective border plants, and in masses are most showy, being

at their best in June, but will flower for some time longer. They are perfectly hardy, very few plants being lost during the late winter, and if seedlings are raised during May or the early part of June these can be grown to their full size by next winter. Sown in pans, not too thickly, lightly covered with fine soil, placed in a handlight or close frame, the seed germinates quickly, and if the plants are first pricked out in other pans or boxes they ought to be ready for the open borders in August. They require good room, and ought to be eventually disposed not less than 15 inches apart each way. Room being somewhat scarce, put them out 8 inches apart each way, and in the autumn either pot up or transplant elsewhere every other row, and half the plants in the reserved rows. They move readily, and flower grandly in pots during May.

Wallflowers.—It is of the greatest importance that these be raised early, plants obtained by sowing after the stress of other garden work is over usually being too small and weakly to flower well. Sow the seed at once, preferably in open borders well prepared and got into a free working condition. Open shallow drills 10 inches apart, water these if at all dry through a rose pot, sow the seed somewhat thinly, and cover with a little fine or sifted soil. Thin out the seedlings early where at all crowded, leaving them say about 3 inches apart, and later on transplant every other one to other borders or beds. In sowing keep each colour separate, masses of one colour being most effective, and always aim to raise abundance. The double German Wallflowers to be similarly treated. Should there be no plots of ground convenient, raise the requisite number of plants in boxes, and early prick out.

Brompton Stocks.—These, though less hardy than Wallflowers, are yet frequently very serviceable, strong plants flowering freely at this time of the year. They are not well adapted for the flower beds, not transplanting well, but they are quite at home in mixed borders and in separate beds, always providing they can be well established in their flowering quarters during the summer. The seed may be sown now or during the early part of June, and the plants treated much as advised in the case of Wallflowers.

Antirrhinums and Pentstemons.—Old plants of these are scarce, the majority came to grief during the past winter. Seeing that they are among the most showy border plants, and not to be despised for the flower beds, more than ordinary pains ought to be taken with young plants that may have been raised from either cuttings or seeds. Unless they are strong at the present time and be got out early on fairly rich good ground, the flowering period will be late and the spikes weakly. They transplant well from boxes or beds of soil in which they may have been temporarily pricked out, and being hardier than the ordinary bedding plants should be placed out early. They are really very effective bedding plants, a dry season appearing to suit the Antirrhinums well.

Herbaceous Phloxes.—To have these at their best they must be well fed at their roots, and young plants in fresh soil will in any case surpass the older clumps. The latter, however, may be greatly improved by having the roots bared and a mulching of manure and a soaking of water given prior to returning the soil over the manure. They are always dry at the roots, no amount of rainfall soaking the ground immediately about them after the growing season commences. It is also advisable to freely thin out the young shoots, any kept or raised in frames to be at once planted out on good ground. Strong young tops taken off, placed singly in small pots, and stood in a close frame with little or no bottom heat, root quickly, and these, if duly planted out, or given a shift into larger pots, will develop sturdy spikes of flower.

Other Strong Herbaceous Plants.—Most of these have come well through the winter, and in many cases are pushing up far more flowering stems than it is advisable to preserve. If crowded, the display is short-lived; but if thinned the stems branch more freely and flower more continuously, the quality of the flowers also being superior. All pay well for receiving the same liberal treatment recommended for Phloxes, and the least that can be done is to well thin out the Japanese Anemones, Delphiniums, Helianthus, Heleniums, Asters, Hemerocallis, and Pyrethrum uliginosum, some of the last named being also cut half down next month in order to have them dwarfer. A mulching of short manure, leaf soil, or spent tan would also greatly benefit the foregoing and all other moisture-loving border plants.

Bulbous Plants.—These, with few or no exceptions, are best left undisturbed, not being lifted till it is necessary for them to be divided and replanted. This applies with the greatest force to the Daffodils and Narcissi—choice or otherwise, while the various other spring-flowering bulbs also improve if only disturbed every three or four years. Where they must be lifted and stored away in boxes defer the operation if possible till after the foliage has ripened and died off, but if this period has to be anticipated, as in the case of bulbs in the flower beds, take them up carefully and replant, or lay them in where they will not dry up too rapidly. Bulbs of Hyacinths, Tulips, and Narcissi are not of much or any service for the flower beds in the following season, but they would serve to brighten the mixed borders, and in time give a good supply of flowers. Much the same may be said of the bulbs flowered in pots. They are of no further service for pot culture, but they might well be bedded in closely together in any outside border and be permanently planted in the mixed borders and the fruit borders next autumn.

PLANT HOUSES.

Richardias.—Plants that have flowered may be placed outside in a sheltered position for a few days and then planted out. Provide a well-manured trench for them, so that the base of the stem will be a little below the surface. Break up old balls at planting time, and divide so that they will not need disturbing when the lifting season arrives

further than is necessary to reduce the balls to fit pots of serviceable sizes. Young stock that has been grown on may be planted out at once without disturbing the roots. If the weather continues dry give the plants a good soaking of water after they are planted out, and mulch the surface with manure or a mixture of leaves and manure that has been used for hotbeds.

Eupatoriums.—Exhausted specimens may be cut back closely if larger plants are needed another season. When they have commenced growth partially reduce their roots and re-pot them. Start them in frames until they are growing and rooting freely, when they can be hardened and planted outside or placed into larger pots and plunged in an open sunny position. Where plants are needed in 6 and 7-inch pots insert cuttings at once. They root quickly in handlights in a vinery or similar structure. Directly they are rooted pot singly and place the plants in a cool frame, and finally outside.

Chrysanthemums.—Those that are being grown on the single-stem principle are becoming too tall for frames. Harden them and place them outside in a sheltered position. As they are placed out supply each plant with a stake, for strong winds and heavy rains may break them. If these plants have been in 6-inch pots for some time and are well rooted place them into their largest pots, but be careful not to overwater them. Those that were rooted later may still have the protection of frames, but give them abundance of air to prevent their drawing up weakly. The object to be aimed at is a firm sturdy growth. Gradually harden those that are still in small pots, so that they can be placed outside as they are potted. In potting be careful that the soil is in a suitable condition for moisture. If wet the plants seldom succeed satisfactorily afterwards. Water carefully and syringe freely. Remove the laterals from the axils of the leaves as they appear from those that are grown for the production of large blooms. Some of the earliest plants will show signs of branching near the top; help them out of this condition by pinching the shoots to a lateral that is showing prominently. Early flowering varieties may be allowed to branch in a natural manner, when the required number of shoots for leading upwards may be selected and the remainder removed, the necessary supply of stakes being collected together in readiness.

Ivy-leaved Pelargoniums.—Plants that are rooted for autumn and winter flowering may be potted singly in 8-inch pots. When they are rooting freely place them in cool frames to induce sturdy growth. Cuttings may still be rooted, and the plants will be useful for winter flowering. At this season these should be rooted singly in small pots, so that they can be repotted on without checking them.

Zonal Varieties.—Cuttings may still be rooted in quantity for winter flowering on the same principle as advised for Ivy-leaved varieties. Those well rooted in 3-inch pots may be pinched and placed into 6-inch pots. Press the soil firmly into the pots, and use a compost of loam, one-seventh of manure and sand. Place the plants as they are potted into cold frames; keep them close for a time until they are rooting freely, when they may be hardened and stood in a sunny place outside.

French and Fancy Varieties.—Give those that are throwing up their flower trusses liquid manure in a weak state every time they need water. Soot water is very stimulating to these plants, and acts quickly. A suitable artificial manure applied to the surface of the soil is the safest and quickest method of feeding these plants. Keep later plants perfectly cool and give them abundance of air. The closer the glass these plants can be kept and the more air admitted the sturdier they grow and the finer are their flowers. Plants that were rooted late and are weak and puny in appearance will, if well cared for, make grand early flowering plants for another year. Those that some would throw away have a good start of cuttings inserted even now, and will, with care and good treatment, make plants 2 feet through them by next spring. Stop the shoots until the plants are well established in 4 or 5-inch pots, then allow them to grow, without pinching, outside, keeping them somewhat dry until the middle of July, when they may be partially shortened back, and when they have broken into growth potted and kept growing on. These plants may be pinched once afterwards and placed in their largest pots early in January and allowed to lengthen out their shoots and flower. They should never be really dried up. Old stool plants may be cut up for cuttings; insert wood that has a moderate amount of firmness about it. Wood of this nature soon roots, and plants of a large size may be produced for early flowering next spring.

THE BEE-KEEPER.

APIARIAN NOTES.

THE WEATHER.

DURING the past week the weather has been changeable, the night temperatures being between 35° and 38°, unless on that of the 12th, when it stood at 45°, rising to 75° throughout the day. Since that the night temperature has been 35° and the day from 50° to 53°. On the 15th a thunderstorm occurred. With the exception of three days the bees have not been much out. It is astonishing with so untoward weather to see how far the bees are advanced. I do not expect swarms for some time yet, as there are few honey-

yielding flowers about, and the Sycamores do not appear to have any blossom this year. I have seen none of it in this locality. Had there been any and the weather fine swarming would have been common this month.

To have bees in this forward condition in such a cold season as this has been is simply the result of the preparation they had in autumn, or rather how the bees prepared themselves, if we except the covering and the construction of the hive; and I may add where there is nothing but Heather produce in the hive a few pounds of the best sugar at the end of the season will prevent the bees of any hive suffering from abdominal distension.

Heather honey appears to be more stimulating than either Clover honey or sugar, and the bees may be induced to prepare more of this than is required for brood-rearing purposes, and passing through the stomach improperly digested may cause the distension. Adult bees cannot digest and assimilate pollen as they do honey, not being necessary for their existence, but for the brood.

WINTERING BEES.

This subject has received my most careful attention both in these pages and in my own apiary, and since my first article on insensible upward ventilation more than thirty years ago, which appeared in the then *Cottage Gardener*, I have never had a failure. Still there are many bee-keepers who are at the present time anything but happy over their stocks, now dwindled to mere handfuls of bees in dripping hives. By far too much has been written upon hives adapted for this or that climate. No matter what the climate is the hive for bee-keeper and bees should suit everyone, whether the temperature be high or low, and whether the air be dry or humid. All that is necessary to accomplish this end is to protect the bees from sudden changes of temperature. Let the heat from their own bodies be sufficient, never let the heat from the rays of the sun penetrate the hive. Be careful on the other hand that there be no damp walls to extract the heat from the bees. A narrow doorway will prevent a too great inrush of air which, if not kept out, would soon envelope the interior of the walls, bees, and combs with excessive moisture, which has a most baneful effect upon the bees.

The system of the "Best Hive in Creation" is now being advocated and extensively adopted in America, the louvre boarding to allow the escape of moisture being similar in every respect to what I advised and employ. At the same time I prefer the single walled hive, well protected, as I have so often explained.

FRAMES CLOSE TO THE FRONT AND BACK OF THE HIVE.

Nearly forty years ago, when I made my first frame hives, the ends of the frames hung close to the front and back of the hive, and minus the bottom rails—a plan much advocated by some modern bee-keepers, but which I do not approve. The above plan is held by some modern writers to be more comfortable for the bees during winter; but, strange to say, an American writer seems to think that frames so placed are warmer in winter and colder in summer, which need not be discussed. The argument is held by some that the combs in such frames are built close to them, in the same manner as combs are said to be built in straw hives.

This is preposterous. Bees do not build their combs in straw hives close to the hive the whole depth of the comb, neither will they in frames set close to the walls of the hive; but in frames away from the walls the combs will fill the frames. Under these circumstances how can the hive be warmer, and the bees be more comfortable? Bees do not cluster in winter to the extreme edges of the combs, but always some distance from them, in which way ventilation can only be effectually carried out.

Let us for a moment assume that the combs are built closely to the sides of the hive, and the bees packed as closely to them. How is the heated and vitiated air to escape? Some of the more attenuated will pass through the crown of the hive if of a permeable nature; but a large portion of it will be compelled, by virtue of its weight, to pass downwards amongst the cluster of bees, and unless

they have the power of rejecting the carbonic acid gas it cannot be otherwise but fatal to them. The truth is bees know a good deal better how to conduct themselves than do many of their owners.

The bees' natural mode of clustering is to preserve a space all round and above themselves, and in this way can, if the doorway is narrow, maintain a uniform temperature without much excitement even at a zero temperature. If the hive is properly constructed and protected there will be no damp to unnecessarily extract the heat from the heated curtain of air or the bees. The fresh air will enter no quicker than the wants of the bees demand, and the vitiated air will return at the ends of the seams of the bees without coming into contact with them, and the bees will remain healthy, a credit and a profit to their owners. I repeat that it is to be regretted that bee-keepers have been so much misled by interested persons.—A LANARKSHIRE BEE-KEEPER.

THE DEATH'S HEAD MOTH AND BEES.

I HAVE read your inquiry about the death's head moth (*Acherontia atropos*) and the honey bee in your issue of May 7th inst. I enclose you a specimen which I took this spring from the back of a frame hive. It is much damaged now, but you can see that the bees had propolised it to the side, and it was covered with propolis and wax. It was not until I had scraped away a good deal that I could see what it was.

I cannot think the bees are at all afraid of it, and in a populous hive it would have no chance of entry. In this case it had entered probably the night after a swarm, when there were not many bees in the hive, or on a somewhat chilly evening when the cluster had contracted, but it had not gone far, for no damage was done to the combs; it was probably stung to death a few minutes after its entry. It might enter a weak stock, but I do not think that even then it would live long. I am of opinion that it hovers about bee hives (as it undoubtedly does) only attracted by the smell of the honey. If I can further assist in any way I shall be pleased to do so.—J. O. WOOD, *Grinshill*.

NOT knowing from experience much of the habits of the death's head moth, I can throw little light on it, but I give what practical information I possess. In answer to the first question at page 365, I have frequently found the death's head moth killed within the hive, or thrown out dead from it. The second question, "Is it attracted there by the smell of the honey?" I cannot answer; it may be that, or simply as a place of refuge. As to the third question, "How are the bees affected by the moth; are they alarmed by its lustrous eyes, or will they attack it as a foe?" The answer to the first question is a partial answer to this one. But are bees ever alarmed? Before we can explain the history of the one we must understand the natural history of the other. I do not believe bees possess any fear, but have strong instincts in guarding against the raids of their natural enemies, and neither "lustrous eyes" nor cry of any kind affect bees. The sting of the bees is fatal to many insects, and their hum strikes terror in animals like the cow.—A LANARKSHIRE BEE-KEEPER.



•• All correspondence should be directed either to "THE EDITOR" or to "THE PUBLISHER." Letters addressed to Dr. Hogg or members of the staff often remain unopened unavoidably. We request that no one will write privately to any of our correspondents, as doing so subjects them to unjustifiable trouble and expense.

Correspondents should not mix up on the same sheet questions relating to Gardening and those on Bee subjects, and should never send more than two or three questions at once. All articles intended for insertion should be written on one side of the paper only. We cannot reply to questions through the post, and we do not undertake to return rejected communications.

Answering Questions (G. B.).—You are frank certainly, but do not you think it is a little cool to ask us to answer six questions because you cannot get what you want elsewhere, and send 3½d. for an odd copy

containing our reply? It would cost at least ten times the amount setting up satisfactory answers to the questions, and the subjects are of limited interest. We answer with pleasure questions from regular subscribers, and begrudge neither time nor space in doing so, and it is for them, and not casuals, that this column is provided, though some of the latter steal a march on us occasionally. This is what you get for your stamps, and is as much as we can afford under the circumstances.

Weevils on Ferns (S. A. G.).—Your Ferns are attacked by the destructive weevil *Otiorhynchus su'catus*. They deposit eggs in the soil, and the maggots resulting eat the roots.

Figs Casting Their Fruits (J. S. D.).—You will find this subject fully treated in an article on page 400.

Late Inquiries (A. L. and Others).—Several letters have reached us too late to be answered this week, and the subjects will be dealt with in our next issue.

Vegetables (J. W.).—Laxton's Omega is a good dwarf Pea for late use; All the Year Round is a good Cabbage Lettuce; and Ne Plus Ultra a good Dwarf Kidney Bean for present sowing.

Mildew on Peaches (D. W.).—We have not had occasion to try sulphate of copper. You will find a method of preparing a mixture of sulphur and lime on page 377, our issue of the 7th of the present month, which has proved effectual.

Growing Peaches (S. J. A.).—You ask, "If we agree with Mr. Rivers in considering Peaches grown under glass are more profitable as bushes and low standards than trained to trellises." Our reply is in the affirmative when grown in such structures as are provided at Sawbridgeworth, and managed by persons equal to Mr. Rivers in skill in that method of cultivation, not otherwise. Liquid manure of the strength named last week may be given both to trees in pots and against walls that need additional support. The manures named will answer your purpose, though they require time to dissolve, and may be used at the strength indicated. We presume they are uniform in quality.

Cottage Gardening (J. D.).—Your object is a laudable one. The schedule you have sent has not reached us. In all probability Mr. Wright's lecture on Garden Allotments would be of assistance to your friends, as it refers to gardening conducted on "scientific principles." A copy can be had from this office, post free for 3½d., a reduction being made when several are purchased for distribution. Offering prizes for garden produce, and especially for well-managed allotments, has a stimulating effect, and the reading of short plain and practical papers at your meetings by competent men and encouraging discussion thereupon would be of considerable service. If any of your cottagers are competent to write short essays by all means encourage them to do so. On this subject, however, we do not quite comprehend your proposition. Your last suggestion shall have our consideration.

Propagating Boronias (C. R.).—When the young shoots are about half ripened is the proper time to make and insert cuttings. The pots for them should be well drained and firmly filled with a fine peaty soil, heavily surfaced with sharp sand. Trim the cuttings with a sharp knife, and dibble in 2 inches apart and firmly, a gentle watering being given at once. Set in an intermediate temperature or warm greenhouse, and closely cover with a bellglass. Shade from bright sunshine, and wipe the bellglass dry every morning. They will root and commence growing in a few weeks, when they should be topped, and when breaking afresh potted in thumb pots, using a compost consisting of two parts of fibrous peat to one of light loam, charcoal and silver sand being freely added. Apply water carefully, pinch back repeatedly, and bushy little plants will result.

Thryasacanthus rutilans (B. C. J.).—Young shoots, not too soft, inserted singly in very small pots in a mixture of sand and peat, the former predominating, and surfaced with pure sand, emit roots freely if the pots are plunged in bottom heat of 85° in a warm propagating case or under a handlight in a heated frame or pit; or several cuttings may be placed in a larger pot and covered with a bellglass, but we prefer the former method, as the roots are not injured by subsequently repotting. The soil must be thoroughly watered before the cuttings are inserted, and again immediately afterwards to settle the sand round them. The requisite amount of shade and moisture must be afforded to prevent the leaves flagging, and eventually light and air must be gradually admitted to insure healthy sturdy growth. Gentle bottom heat is of great assistance to the plants after they have been repotted, with slight shade from the sun during the forenoons of hot days, a warm moist genial atmosphere being maintained, with careful ventilation, sharp currents of air being injurious.

Treatment of Gardenias (M. B.).—As your plants discontinue flowering they should be cut closely back and started again into growth in brisk heat. A few of the youngest and best-formed specimens should be grown without pruning, and if their growth is brought to completion early in the season they will yield a good number of their fragrant flowers during late autumn and winter. It is a good plan to restrict plants grown for this purpose at their roots, so that their growths are short and sturdy. The young stock for the main supply of flowers next spring, if raised and treated as directed, will be ready for placing into 6-inch pots. If these are grown in heat and moisture they will make bushy specimens 18 inches or more over by autumn, and produce from twenty to thirty flowers each. Those rooted early in the year must be pushed forward with all possible speed; stopping the shoots to induce them to branch, and repotting as the roots advance, are the main points to be attended to. When the plants are established in their pots give liberal supplies of water, and syringe twice daily during bright weather. Use for a compost good fibry loam three parts, one part leaf

soil, a little decayed manure passed through a fine sieve, and sufficient coarse sand to keep the whole porous.

Muscat Grapes not Setting (A. B.).—The lateral you have sent ought to have been topped at two leaves beyond the bunch as soon as those leaves were visible, but you have allowed twelve leaves to grow before stopping the leader. The growths must be far too much crowded, and as a consequence the one before us is long-jointed, and decidedly lacking in firmness. The atmosphere has also been kept too moist, and that being so the minimum night temperature at least 5° too low. Shading the roof with buttermilk or anything else would aggravate the evil, and the sooner you make the glass clear the better. As the Grapes failed last year it is a pity you did not write sooner, as we fear it is too late now to remedy the evil. We should gradually shorten the laterals, taking off a length of three joints to begin with, as the leaves there are small, then two others at intervals of three days. If the whole length were cut back at once a severe check would be given to the Vines. If you had read attentively and carried out the advice that has been given from time to time in our "Work for the Week" columns, your Vines would not be in their present unfortunate state. We sympathise with you, and can only suggest a change of management on the lines indicated, and if this is too late to assist the setting of the berries this year, the Vines and flowers will be in better condition for producing full bunches of fruit next season.

Growing Tuberoses (P. II.).—There are various methods of growing Tuberoses, and we will describe the simplest, or that which most probably will best meet your case. They may be flowered either singly in 5-inch pots, or three bulbs can be grown in large 6-inch pots. A compost consisting of three parts of fibrous loam to one each of good leaf soil and well-decayed manure passed through a coarse sieve with a little sharp sand suits them well. Pot rather firmly, the bulbs being about three parts buried; but if the soil is moderately moist do not give water. Set the pots in a frame, and heavily cover with either ashes or cocoa-nut fibre refuse; or if a frame cannot be spared place the pots under a greenhouse stage where little or no drip will reach them, and cover thickly with ashes or fibre. When rooting freely and top growth has commenced they must be at once uncovered and gradually exposed to the full light. Early started bulbs will flower in an ordinary greenhouse during the summer, and even in the open air, but later on they will require to be gently forced. The flower stems ought to be kept well secured to stakes, and liquid manure be frequently given after the pots are well filled with roots. A few may fail to throw up flower stems, but the majority will give one good spike, after which they are of no further value, and should be thrown away. Red spider is the worst enemy Tuberoses have to contend with, but this can usually be kept down with the syringe, and a puff of tobacco powder followed by a syringing will keep down green and black fly.

Storax and Benzoin (S. J. B.).—The gum resin called Storax is obtained from *Styrax officinale*. This is a tree from 15 to 20 feet high, a native of Syria, but now found in the Levant, Italy, Syria, Spain, and the south of France; but in the last-mentioned country it does not yield any of the resin. Storax is procured by wounding the bark of the tree, when the juice exudes and becomes concrete. Some of it is in the form of reddish yellow tears about the size of a pea, opaque, soft, and adhesive, and this is called Storax in grains; another is in dry brittle masses, formed of adhesive tears, and, from being wrapped in the leaves of a kind of reed, is called Storax calamita. Storax has a fragrant odour and aromatic taste, and as it contains volatile oil and resin, and yields benzoic and cinnamic acids by distillation, it ranks as balsam. It is stimulating and expectorant, but is now seldom used. Benzoin, or Benjamin, is a gum resin formed by the concrete juice of *Styrax benzoin*. The tree grows in Borneo, Siam, Java, and other islands of the Indian Archipelago, where it attains a large size; and it is by wounding the bark and allowing the juice to exude and become hardened by exposure, that the resin is obtained. Benzoin has a sweet, peculiar, and agreeable odour; which is increased by friction. Its taste is sweetish, somewhat resinous, balsamic, and when chewed is irritating to the mouth. It is easily pulverised, and when heated melts and emits thick, white, pungent fumes, which consist chiefly of benzoic acid. It is entirely soluble in alcohol. According to the analysis of Bucholz, 1500 parts of benzoin yielded 187 of benzoic acid; 1250 of resin; 25 of a substance resembling Peruvian balsam; 8 of a peculiar aromatic principle, soluble in alcohol and water; and 3 of ligneous fibre. In its medical properties it is stimulant and expectorant; and was formerly employed in chest affections. Benzoic acid, when pure, is inodorous, and its taste pungent and bitter. In India it is used by the Hindoos to burn in their temples. The milky liquor resulting from the addition of water to the alcoholic solution is used as a cosmetic.

Names of Plants.—We only undertake to name species of plants, not varieties that have originated from seed and termed florists' flowers. Flowering specimens are necessary of flowering plants, and Fern fronds should bear spores. Specimens should arrive in a fresh state in firm boxes. Slightly damp moss, soft green grass or leaves form the best packing, dry wool the worst. Not more than six specimens can be named at once, and the numbers should be visible without untying the ligatures, it being often difficult to separate them when the paper is damp. (*Onion*).—*Ornithogalum longibraeteatum*. (*J. C.*).—*Solanum Seaforthianum*. (*G. C. C.*).—1, A variety of *IXIA*; 2, *Myrsiphyllum asparagoides*. (*G. E.*).—It is a species of *Crepis*, but the flowers were not expanded. There is no method of destroying them except that you mention. (*F. S. G.*).—1, *Amelanchier botryapium*; 2, *Salix lanata*; 3, *Salix viridis*; 4, *Spiræa prunifolia flore-pleno*.

TRADE CATALOGUES RECEIVED.

G. Phippen, Reading.—*List of Bedding Plants*.
 J. Laing & Sons, Forest Hill.—*Catalogue of Tuberous Begonias*.
 Dammann & Co., Naples.—*General Catalogue*.
 Dicksons, Chester.—*List of Bedding and Border Plants, Dahlias, and Roses*.

COVENT GARDEN MARKET.—MAY 20TH.

MARKET quiet, with no alteration owing to the holiday.

FRUIT.											
	s.	d.	s.	d.	s. d. s. d.						
Apples, ½ sieve	1	6	to	6	0	Keutish Cobs	40	0	to	50	0
" Nova Scotia and						Lemons, case	15	0		20	0
" Canada, per barrel	15	0		26	0	Oranges, per 100 ..	4	0		9	0
" Tasmanian, case	6	0		12	0	St. Michael Pines, each..	3	0		8	0
Grapes, New, per lb. ..	2	6		4	0	Strawberries, per lb. ..	1	6		5	0

VEGETABLES.											
	s.	d.	s.	d.	s. d. s. d.						
Asparagus, per bundle ..	0	6	to	1	6	Mushrooms, punnet ..	1	6	to	2	0
Beans, Kidney, per lb. ..	0	9		1	0	Mustard & Cress, punnet	0	2		0	0
Beet, Red, dozen	1	0		0	0	Onions, bushel	3	0		4	0
Brussels Sprouts, ½ sieve	3	0		4	0	Parsley, dozen bunches	2	0		3	0
Cabbage, dozen	3	0		0	0	Parsnips, dozen	1	0		0	0
Carrots, bunch	0	4		0	0	Potatoes, per cwt.	3	0		4	0
Cauliflowers, dozen ..	3	0		6	0	Rhubarb, bundle	0	2		0	3
Celery, bundle	1	0		1	3	Salsafy, bundle	1	0		1	6
Coleworts, doz. bunches	2	0		4	0	Scorzonera, bundle	1	6		0	0
Cucumbers, doz.	3	0		5	0	Seakale, per bkt.	1	0		1	6
Eudive, dozen	1	0		0	0	Shallots, per lb.	0	3		0	0
Herbs, bunch	0	2		0	0	Spinach, bushel	5	0		6	0
Leeks, bunch	0	2		0	0	Tomatoes, per lb.	1	6		2	0
Lettuce, dozen	3	0		3	6	Turnips, bunch	0	0		0	4

AVERAGE WHOLESALE PRICES.

CUT FLOWERS.											
	s.	d.	s.	d.	s. d. s. d.						
Arum Lilies, 12 blooms ..	2	0	to	4	0	Mimosa (French), per					
Azalea, doz. sprays	0	9		1	0	bunch	1	3	to	1	6
Bouvardias, bunch	0	9		1	0	Myosotis, dozen bunches	2	0		4	0
Camellia, white, per doz.	2	0		4	0	Narciss (Various) dozen					
" red	0	9		1	6	bunches	1	0		3	0
Carnations, 12 blooms ..	1	0		2	0	Pansies, dozen bunches..	1	0		2	0
Cowslips, dozen bunches	0	6		1	0	Pelargoniums, 12 trusses	6	0		9	0
Cyclamen, doz. blooms ..	0	3		0	6	" scarlet, 12 bnchs	4	0		6	0
Daffodils, doz. bunches ..	2	0		6	0	Primula (double) 12 sprays	0	6		1	0
Eucharis, dozen	3	0		6	0	Primroses, dozen bunches	0	4		0	9
Gardenias, per doz.	1	0		3	0	Roses (indoor), dozen ..	0	6		1	6
Hyacinths doz. sprays ..	3	0		4	0	" Red (English) per					
" (Dutch) in boxes ..	1	0		3	0	dozen blooms ..	2	0		4	0
Lapageria, 12 blooms ..	2	0		4	0	" Red, 12 bls. (Frch.)	2	0		4	0
Lilac (English) doz. bnchs	0	6		1	0	" Tea, white, dozen ..	1	0		3	0
" (French) per bunch	5	0		6	0	" Yellow, dozen ..	2	0		4	0
Lilium longiflorum, 12						Spiræa, per bunch	0	6		0	9
blooms	3	0		4	0	Tuberoses, 12 blooms ..	1	0		1	6
Lily of the Valley, dozen						Tulips, per dozen	0	3		0	6
sprays	0	6		1	0	Violets (Parme), per beh.	3	0		4	0
Maidenhair Fern, dozen						" (dark), per beh. ..	1	0		1	6
bunches	4	0		9	0	" (English), doz. bnch	0	6		1	0
Marguerites, 12 bunches	2	0		4	0	Wallflower, doz. bunches	1	6		3	0
Mignonette, 12 bunches..	3	0		6	0						

PLANTS IN POTS.

	s.	d.	s.	d.	s. d. s. d.						
Aralia Sieboldi, dozen ..	6	0	to	18	0	Geraniums, Ivy, per doz.	4	0	to	6	0
Arbor Vitæ (golden) doz.	6	0		8	0	Hyacinths, doz. pots ..	5	0		8	0
Arum Lilies, per doz. ..	9	0		12	0	Hydrangeas, per doz. ..	9	0		12	0
Azalea, per plant	2	0		3	6	Lilium longiflorum, per					
Cineraria, per doz.	5	0		8	0	dozen	18	0		30	0
Cyclameus, per doz. ..	9	0		18	0	Lily of the Valley, per pot	1	0		2	0
Deutzia, per doz.	6	0		8	0	Lobelia, per doz.	4	0		6	0
Dielytra spectabilis, per						Marguerite Daisy, dozen	6	0		12	0
dozen	8	0		12	0	Mignonette, per dozen ..	4	0		9	0
Dracæna terminalis, doz.	24	0		42	0	Musk, per doz.	2	0		4	0
" viridis, dozen	12	0		24	0	Myrtles, dozen	6	0		12	0
Erica, various, dozen ..	12	0		24	0	Palms, in var., each ..	2	6		21	0
Euonymus, var., dozen ..	6	0		18	0	Pelargoniums, per doz. ..	12	0		18	0
Evergreenus, in var., dozen	6	0		24	0	Pelargoniums, scarlet, per					
Fairy Roses, per doz. ..	9	0		12	0	dozen	4	0		9	0
Ferns, in variety, dozen..	4	0		18	0	Primula sinensis, per doz.	4	0		6	0
Ficus elastica, each ..	1	6		7	0	Spiræa, per doz.	8	0		12	0
Foliage plants, var., each	2	0		10	0	Stocks, per dozen	4	0		6	0
Genista, per doz.	6	0		9	0	Tropæolums, per dozen ..	3	0		6	0

Bedding plants (in variety) in boxes, from 1s. to 3s.; in pots, per doz., 1s. to 2s.



A FIELD FOR EMIGRATION.

LAST August several of the leading agriculturists of Great Britain and Ireland by the invitation of Sir Charles Tupper, the High Commissioner for Canada, went out on a visit of inspection to that country, and the receipt of their reports is to us a reminder that our advice is frequently sought by would-be emigrants, so that we may now usefully call attention to the reports and the information which they afford of a country where it appears so possible for an industrious man to thrive.

Free grants of 160 acres of fertile land to male adults of the

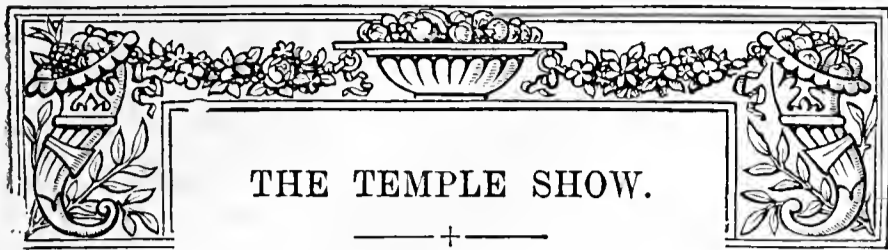

DURING the past few weeks much interest has been excited amongst metropolitan and provincial horticulturists by the Royal Horticultural Society's Exhibition in Temple Gardens, which opens to-day (Thursday). Judging by the experience of the preceding three years, something of special importance was expected, and those who visit the present Show will find their anticipations fully realised. The establishment of this Exhibition as an annual event met with general approval, and the liberality of the Inner Temple Benchers in placing their garden at the disposal of the Council has not only been widely appreciated, but has resulted in the development of one of the finest floral displays in the kingdom. The position is central, convenient of access alike for visitors and exhibitors; the time of year is also a good one to obtain an effective show; so that a combination of favourable circumstances has aided in extending the popularity of what is rapidly becoming the principal horticultural gathering of the year.

Probably no other Society could have successfully organised an Exhibition on the same basis as that at the Temple, and the result has been a surprise to many. Large money prizes have long been considered essential to the production of large shows, but in the case of the R.H.S. the fallacy of this assumption has been abundantly proved, and if £500 had been offered in prizes it would not have brought together a more brilliant display than which will greet visitors to-day. Still, as already observed, the circumstances are exceptional, and no other Society could have safely ventured to arrange for a show of such magnitude without providing a substantial schedule. There is no danger that others will attempt to imitate the action taken by the R.H.S., as it would result in certain failure at any of the provincial exhibitions, such as Shrewsbury, York, and Manchester, but it redounds to the credit of the old Society that its vitality and prestige still enable it to accomplish so much. It proves also that there are many wealthy amateurs who prefer contributing from their garden treasures to a non-competitive show to entering the lists in the ordinary way, and we know some who would never exhibit in classes of the stereotyped character. The silver cups and medals offered by the Society provide, however, honours for meritorious exhibits, and these are bestowed with judicious liberality.

The Temple Show is essentially a plant exhibition, and it must of necessity remain so, as the end of May is not a date when many fruits could be expected even of the earliest, and least of all in a season like the present. Specimen plants of the usual stove and greenhouse types also are not likely to be seen, as the expense of conveyance is so great that only large money prizes can afford professional exhibitors a chance of recovering their outlay. To take their place, however, there are scores and perhaps hundreds of equally well-grown though smaller examples, indicating fully as much cultural skill and admitting of far more artistic treatment in grouping. Apart, therefore, from the individual beauty or interest of the plants themselves, there is ample room at the Temple for taste in arrangement and groups whether of plants or cut flowers predominate. To the general public and to horticulturists exhibitions formed of groups often possess far more attraction than those where specimens are placed in competition and where too frequently one or more of the exhibits are positively unworthy of any recognition.

To provide for groups of considerable size the tents selected for the Show under notice are wonderfully spacious, and unsurpassed for horticultural gatherings. Entering the garden from the Thames Embankment the first tent is 170 feet long by 30 feet wide, which is devoted to miscellaneous flowers and plants. Next to this is the Orchid tent, 140 feet long by 40 feet wide, and proportionately lofty. Then follows the Rose tent, 160 feet long by 60 feet wide; and a fourth one 150 feet long by 30 feet wide is appropriated to various exhibits, including garden sundries. Together these afford a covered space equal to nearly 25,000 square feet, thus providing abundant staging room and promenade space for visitors. About 100 distinct exhibits are entered to occupy from a few feet to several hundred feet each, and though the tents have been greatly extended this year the whole of the space provided is engaged.

Orchids constitute the great feature of the Exhibition, and such a remarkable display of these plants has never been seen in the City of London before. The greater part of the second tent, 140 feet long, with stages nearly the whole length, is devoted to the aristocrats of the vegetable kingdom, and their admirers will find innumerable beautiful, rare, and peculiar forms to please them. Something like 500 feet run, or 3000 square feet of staging, covered with Orchids, in this and the adjoining tent, is not to be seen every day, and though there may not be an equal number of species represented, the display, as a floral effect, will probably be regarded by many as superior to that at the South Kensington Orchid Conference in 1885. Orchids lend themselves admirably to artistic grouping, and some of the larger exhibitors have an opportunity on this occasion to display their plants and skill to the best advantage. The largest and most beautiful exhibit of Orchids contributed by one firm is that from Messrs. Sander & Co., St. Albans, which occupies 150 feet run of stage by 5 feet in width, and is of so unique a character that it deserves prominent notice. Other extensive trade exhibitors of Orchids are Messrs. B. S. Williams & Son, Upper Holloway; Low & Co., Clapton; and J. Cypher, Cheltenham. The amateurs are admirably represented by Baron Schröder, The Dell, Egham (gardener, Mr. Ballantine); Sir Trevor Lawrence, Bart., M.P., Burford Lodge, Dorking; the Duke of Marlborough, Blenheim (gardener, Mr. Whillans); T. B. Haywood, Esq., Woodhatch Lodge, Reigate (gardener, Mr. C. J. Salter); A. H. Smee, Esq., The Grange, Carshalton (gardener, Mr. Cummins); Malcom S. Cooke, Esq., Kingston Hill; Mrs. Arbuthnot, Bridgen Place (gardener, Mr. Mitchell); W. F. Darnell, Esq., Stamford Hill (gardener, Mr. G. Elliott); T. Statter, Esq., Whitfield, Manchester; and Mr. G. Reynolds, Gunnersbury House Gardens.

Roses in the adjoining tent—the giant of the series—will attract crowds of admirers, and it can be imagined they will be worth seeing when it is said that the space devoted to them is 125 feet by 9 feet, and such firms as Messrs. W. Paul & Son, Waltham Cross, G. Paul & Son, Cheshunt, Turner of Slough, and Rumsey of Waltham Cross, are the chief exhibitors. Fine masses of colour are also afforded by groups of Tuberosus Begonias, Calceolarias, hardy flowers, Tulips, Anthuriums, Pelargoniums, and many other plants that cannot be referred to now, graceful Palms and refreshing Ferns also furnishing the requisite foils to so much colour. Grand banks of Orchids again constitute a feature in this tent.

Besides those already named, the following have entered the undermentioned exhibits:—Messrs. Cannell & Sons, Swanley, Begonias, Gloxinias, and cut flowers. Messrs. Ling & Sons, Forest Hill, Caladiums and Begonias. Messrs. Kelway & Sons, Langport, hardy herbaceous plants and cut flowers. Mr. W. Iceton, Roehampton, Palms, and other foliage plants. Messrs. W. & J. Birkenhead, Sale, Manchester, Ferns. Mr. H. B. May, Upper Edmonton, Ferns. Mr. J. Ford, gardener to Sir C. Pigott, Bart., Wexham Park, Slough, Calceolarias; and Mr. H. Hazell, gardener

to R. W. Mitchell, Esq., Fairfield, Bickley Park, Kent, plants for dinner table decoration.

Messrs. James Carter & Co., extensive exhibits of Gloxinias, Calceolarias, Cacti, Mimulus, and Petunias. Messrs. Dobbie & Co., Rothesay, collection of Pansies and Violas. Mr. W. Chambers, Isleworth, wreaths; and Mr. J. Lakin, Temp'le Cowley, Oxford, 300 blooms of Tulips. Mr. Jennings, Ascott Gardens, Leighton Buzzard, group of Souvenir de la Malmaison Carnations. Messrs. James & Son, Farnham Royal, group of Calceolarias. Messrs. Balchin & Son, Sussex, group of *Leschenaultia biloba*; and Messrs. Barr & Son, King Street, Covent Garden, group of hardy flowers.

Messrs. J. Veitch & Sons, groups of hardy plants, Gloxinias, and *Streptocarpus*, cut flowers, and sixty dishes of fruit. Mr. C. Turner, Slough, Roses and Pelargoniums. Mr. Wiggins, Manager to Mr. D. Baldwin, Hillingdon Heath, twelve specimen Pelargoniums. Mr. G. Wythes, Syon Gardens, Brentford, Figs, Strawberries, and Melons. Mr. G. Phippen, Reading, Violas, bouquets, and floral designs. Mr. F. Hooper, Bath, collections of cut Roses, Pansies, and Tulips. Messrs. Cheal & Sons, Crawley, collection of Apples and Pears, cut flowers, and "Tom Thumb" Dahlias in pots.

Messrs. T. Rivers & Son, a collection of fruit trees in pots. Mr. J. W. Reed, gardener to E. Pettit, Esq., Weybridge, collection of fruit. Mr. J. Hollingworth, gardener to J. F. Campbell, Esq., Woodseat, Utttoxeter, Black Hamburg and Foster's Seedling Grapes. Mr. T. S. Ware, group of hardy herbaceous flowers. Messrs. W. Cutbush & Son, Highgate, group of foliage and flowering plants; and Messrs. J. Peed & Sons, Roupell Park Nurseries, S.E., collection of Anthuriums.

The Show will be formally opened at 3 P.M. to-day (Thursday), by H.R.H. the Princess Christian, but visitors will be admitted from 1 P.M. to 8 P.M. On Friday the time of admission will be from 10 A.M. to 6.30 P.M., and the price a shilling. All that is required is fine weather for both days, and a large attendance of visitors may be safely anticipated to render the gathering as successful financially as it is horticulturally. We shall publish a full report next week.

HARDY FLOWER NOTES.

ALL too swiftly speed the days of May, and we are loth to exchange the freshness and brightness of our early flowers for the gay and flaunting colours of those of our later months. Not that our spring flowers are not gay also, but they seem to appeal to us in a different way, and, unlike the autumn plants, hold out to us the promise of summer with its sunshine and warmth. It is in May, too, that the rock garden is at its brightest, and as I look around I am well nigh bewildered at the choice of flowers presenting themselves for notice. The Arabis is past its best, but fine masses of *Alyssum saxatile* shine like gold on mound and border. In truth the name "Gold Dust" has been well applied to this brilliant flower. We are told that the name *Alyssum* is derived from the Greek *α*, not, and *lyssa*, rage, in reference to a fable that the plant allayed anger. Hence, I suppose, the old popular name "Madwort." I cannot recollect having met with the fable in question at any time, and have searched for it in vain. A charm is added to the possession of a flower when to it is attached some historical or fabulous association, and we should by no means neglect this branch of the gentle art. I am of opinion that in too many cases this *Alyssum* is not treated as it should be. It does not lend itself readily to spring bedding, as it suffers sadly from removal, and for a year or so produces its blooms far too sparsely. Place it on a dry bank, and let it remain for a few years, and the wealth of golden bloom will delight all who see it.

The Aubrietias, too, are extremely fine, presenting beautiful sheets of colour from pale lavender and deep purple to the brilliant colour of *A. rosea* and *A. Leichtlini*. Some good shades are to be found among some seedlings of the latter. It will be found advantageous to clip in the Aubrietias after flowering. By this means they are prevented from becoming untidy, and the quantity of flowers produced the next season will be much increased.

Associating well with the *Alyssum* and Aubrietia is *Hutchinsia alpina*, a pretty little Crucifer, almost pure white, which has been in flower with me for a considerable time, and will remain in bloom for a long time still. It has dark green finely divided leaves, and rises only to about 3 inches in height. It appears to do well in a dry position, and is much neater in habit and purer in colour than

the Arabis, but does not seem to be a popular flower with the bees. I have observed a stray one alight momentarily on the plant, but its stay was short, and its search evidently unsuccessful.

Several of the Fritillarias have been well in flower, but *F. accepetala* has taken a tantalising time to open. It is a new plant to me, and therefore its flowering is awaited with great interest. *F. pallidiflora* has been very fine, and is one of the most pleasing of the family. It grows to about a foot in height, has a stout stem clothed with a number of oval broadish leaves of a glaucous colour, and produces from two to six flowers on the top of the stem. These flowers are pale yellow outside, of a good shape, and the yellow inside is profusely speckled with chestnut brown. Several others which I added to my collection last autumn have failed to flower. I have, however, been somewhat struck with the variation which seems to occur among what is sold as *meleagris alba*. What I have as *F. m. alba* seems an inferior form to what I saw in another garden the other day, mine being broader in the flower and more tinged with green. Again, a white Fritillaria I received as *F. alba (præcox)* is, I am confident, only a form of *F. m. alba*, from which it differs by having smaller flowers and narrower foliage, and in being dwarfer in habit. There is much that is graceful in these "Snake's-head Lilies," which at one time received much attention, but have gradually been relegated to obscurity. What is, I suppose, one of the earliest of our Scottish gardening books ("The Scot's Gardener," by John Reid Gardner, second edition, 1721) says of the Fritillarias:—"Fritillarys, whereof are some varieties of colours, have a small round root, and white, made of two pieces as if joined together, whence springs a stalk a foot high, with some green leaves, at the top thereof cometh the flower out amongst five or six leaves, hinging (*anglice*, hanging) his head downwards." It is to be hoped that more attention will be devoted to these most interesting flowers.

Many of the Saxifrages are now in flower. The beautiful little *S. muscoides atropurpurea*, which seems to be synonymous with *S. purpurea*, is covered with its charming little red flowers. It is of a colour which is too rare among the Saxifrages, and is so easily grown as to be worthy of cultivation in every garden. Finer still is *S. globosa*, which I mentioned last year, but which I had not then seen in full flower. This is also very dwarf in habit of foliage, but the flowers rise higher, and are of a beautiful pink, becoming lighter with age. It was with great satisfaction that I added a small plant of this to my collection this season. Both of these belong to the mossy section. Another very pretty little Saxifrage is *S. marginata*, with pure white flowers. There are now so many species and varieties in cultivation that the task of selection is by no means an easy one.

The Daffodils are still with us, and I am inclined to think that Herrick's acquaintance with them was very limited when he wrote his ode "To Daffadills:"—

"Faire Daffadills, we weep to see
You haste away so soone:
As yet the early-rising sun
Has not attained his noone.

* * * * *
We have short time to stay, as you,
We have as short a spring;
As quick a growth to meet decay
As you or any thing."

However true this may be of any single variety there are now so many species and varieties in cultivation that the flowering period is prolonged over several months. I had recently the pleasure of looking over a good collection which includes some not in my possession, and which illustrated how much individuality—if we may so call it—is possessed by various varieties. *N. cernuus*, which grows quite well with me, will not thrive in the heavier soil. *N. Bishop Mann* seems to fare but indifferently, while *N. albicans*, which a high authority seems to consider a very delicate species, grows and increases well. One of the finest of the white Narcissi in flower was *N. Ajax* Mrs. J. B. M. Camm, which appears to have an excellent constitution, and produces large well-formed flowers with white perianth and sulphur coloured trumpet. Inferior in size but paler in the trumpet was *F. W. Burbidge*, but this does not seem to possess the same constitution as the former. *N. pallidus præcox* will not do in the same garden, while with me it grows well and seeds quite freely.

The wider one's acquaintance with flowers and gardens becomes the more caution will be exercised in dogmatising as to the soil and position required by particular plants. That *Primula rosea* is a bog plant one can hardly deny, yet I saw it flowering perfectly on a very dry rockery the other day; and I have never seen *P. cashmeriana* and *P. denticulata* produce healthier or finer foliage than on a dry sunny position in my own garden. I was greatly struck

with the fine healthy appearance of a clump of *Anemone nemorosa* fl.-pl. on a rockery in full sun. I have always grown mine in partial shade, but the plant grown in the sun and which came from my garden looked much finer, and the foliage had the firm "feel" which is noticeable in *Adiantums* grown well exposed to the light. Of course there are many modifying circumstances which must be taken into account; but all these things lead one to hesitate to say that a plant will not do in certain soil or certain positions, and, *vice versa*, that the same plant will do well in certain conditions. Soil, atmosphere, climate, and general surroundings must be taken into account. The mention of *Primulas* in this connection reminds me of a fine line of young plants of *P. cortusoides amœna* I saw in a garden the other day. The plants were seedlings and were remarkably vigorous and healthy. Especially noticeable, too, was the variation in shade of colour; some were pale in colour and some deep. The seed was from the typical plant, and the flowers produced showed how comparatively easily the results shown in the fine varieties known as *P. Sieboldi* have been produced.

I had intended to speak of other plants as well, but my pen seems to have run too freely, and some additional notes, including some of the *Tulip* species, must be left to another time. *Anemones*, too, claim some space to themselves, but like many other stars in the galaxy of the glory of the garden, their praise must be left meanwhile.—S. ARNOTT.

HARDY FRUIT.

[A prize Essay read at a meeting of the Cardiff Gardeners' Mutual Improvement Society.]

(Continued from page 390.)

THE PLUM.

It is a long way from the Sloe (*P. communis*) to the delicious fruits so well known to gardeners, yet this is the first of the family. The multiplication of new varieties began very early, and the origin of many is lost in antiquity. It is grafted upon stocks raised from stones of the common varieties and called the free stock, and sometimes upon the Brussels stocks or St. Julian Plum, and sometimes on *Prunus myrobalana*, described by Linnæus as a separate species, and known in the trade as the Cherry Plum, and native of Canada. The free stock, however, is universally used in preference to any other, and is raised and prepared for grafting in the same way as the Apple and Pear stocks. The methods of grafting and budding are identical.

It is chiefly as an orchard tree that we find the Plum cultivated. Beyond forming the head of the standards in the same way as we do the Apple little pruning is necessary. Suckers which the Plum throws with more freedom than any other tree should be removed. It is also cultivated as a wall fruit, and generally occupies those of an eastern aspect.

Some of the varieties of the Plum, notably the Damson and Green Gage, have features so individually characteristic as to be recognised at a glance. The Damson is valued by the poor for its abundance as much as the Green Gage is for its delicious flavour by the rich. The Damson is one of the most profitable, growing as it does in almost any soil, often bringing enormous crops later than any other Plum.

A limestone soil is the most suitable, and the trees should be planted in a sheltered part, for the blossoms of the Plum are very fragile and easily destroyed by spring frosts. Trench 2 feet deep and plant the standards 15 feet apart when the land settles, and as soon as the leaves fall if possible. There are vast numbers of varieties, but, I think, the following list includes the best. If I were forced to select one only I should take the Victoria as being the most reliable and useful. Dessert—Transparent Green Gage, Golden Drop, Reine Claude, Washington, Blue Impératrice, Goliath, Jefferson. Culinary—Early Prolific, Victoria, Orleans, Pond's Seedling, Crittenden's Prolific, Prune Damsons.

THE CHERRY.

The stocks employed for this fruit are the Cherry itself from the stones, and *Cerasus Mahaleb* for a dwarfing stock. The latter is a native of Southern Europe, and is remarkable for the fragrance of its flowers. It is also the best stock for the prevention of what is known as gumming, or Cherry canker, as it might be called, a disease which is almost unavoidable, no matter what the stock may be.

The Cherry is a most delicious fruit, and will do in almost any soil, but a good depth of loam suits it best. Shelter is necessary, as the blossoms are liable to be cut off by spring frosts. It is cultivated as standards, bushes, and on walls; and were it not for the hard and fast rule which the title of this paper compelled me to draw, I should have referred to wall culture of the Cherry, especially the Morello. As standards in orchards it is not frequently seen, but it is grown largely in some districts. Isolated trees suffer through the depredations of birds, which are especially fond of Cherries. It requires much patience to prevent their taking the entire crop in isolated cases. Cherries do not like the knife, but, like the other fruit trees treated of previously, it must be pruned hard back at first to secure a good-shaped head, after which the less pruning the better, and what little is necessary might be done during the summer. Standards need 20 feet between them. Bush fruit in the garden 10 to 15 feet, these latter might be protected by netting. It is a fruit that bears with commendable certainty, though from the causes stated it is not very profitable.

The old and well-known White Heart is superseded by the following varieties, which are suitable either for standards or bushes:—Early Duke, Late Duke, Black Tartarian, Kentish, Elton, Amber Gean, and Bigarreau.

ROOT-PRUNING.

It will be seen that I have not advised much pruning in the foregoing remarks on fruit trees, relying more upon judicious thinning after the foundation of the trees was laid, and allowing the trees to extend naturally; by so doing we obviate to an extent root-pruning, which may be called a necessary evil. But if found necessary it should be done when the leaves are falling, as the roots have then a longer time before them for healing before they are called into action by the arrival of spring. Masses of fibrous roots need pruning as much as long and barren ones. In our rather ungenial climate there is not sufficient heat to render fertile the growth made, especially in wet and sunless seasons. After such seasons it is advisable to root-prune those trees that have a mop of roots, which under generous treatment pour such a flood of sap in the branches that, although pruning and thinning may be done on the most approved lines, yet continue to make such rapid growth without forming fruit buds are long jointed and should have their roots restricted.

It is a good plan when planting fruit trees of any description to place a broad flagstone at 2 feet, or at most 3 feet, below the surface underneath the tree, so that if root-pruning become necessary it can be more effectually done without disturbing the tree too much by tunnelling underneath. It is a simple operation, and merely consists in cutting off the fringe of roots that extend beyond a certain circle, say from 3 to 5 feet, from the base of the tree according to its age, working under the ball as far as possible. Young trees that it is desirable to hasten into fertility can be lifted entirely. Old trees, on the other hand, which may have formed long and bare roots penetrating the subsoil would need great care in root-pruning. It is dangerous work in such cases—indeed, if it was in a very bad state it would be best to do only half one season and the other half the next. When well and carefully done it results in a lasting state of fruitfulness. The best way is to open a trench at least 8 feet from the base, searching carefully for the roots, which when found should be lifted, torn ends cut smooth, and relaid in fresh material within a foot of the surface, and give a coat of manure as a mulch. It often happens that owing to so severe a check the growth made the season after is of a very weak and puny nature; the second season should bring good strong short-jointed shoots, which if attended to on the lines laid down for the Apple, and not upon the old system of chopping it all off, would result in a good crop the third year. Three years seems a long time to wait for a reward, but it is not much in the life of a fruit tree, and everyone who engages in fruit culture will have to practise patience, especially in this island of ours, with its cloudy skies and absence of long-continued sunshine which other countries enjoy.

INSECT ENEMIES.

Before I proceed to the Currants, Gooseberries, Raspberries and Strawberries, it would perhaps be best to devote a few lines to the above subject, which do so much injury to our fruits, and which ought to be taken into consideration. The Gooseberry is sometimes attacked by a caterpillar (*Nematus Grossularia*); a dusting with hellebore powder will be useful if shaken over the bushes before the fruit has reached the picking stage. It is considered poisonous, and should not remain on the fruit. Currants are generally pretty free from insects. Sometimes black fly will appear on the shoots of the Cherry and Plum. Either pinch the points right away or syringe with Gishurst compound if badly attacked.

Red spider will attack anything in hot seasons. For the spider nothing is better than a good syringing with Gishurst. Some prefer using sulphur mixed with water, but as Gishurst contains sulphur in the best form I recommend it before sulphur. A mixture of soft soap and petroleum with warm water is cheaper, and is best applied with the garden engine. It will also do much to get rid of American blight on Apple trees. On small trees in nurseries they usually paint the young trees with Fir tree oil or paraffin to get rid of it. But do what we will, we always have the American blight with us.

Of late we have heard much of the ravages of the winter moth (*Cheimatobia brumata*), but we have not seen it down here in South Wales yet, at least I have not. Some time ago, Mr. J. Wright, in order to emphasise the importance which attaches to the ravages of this pest, described in an article written May 15th, 1890, what he saw of it, and in one part says:—"In some places they were an inch thick, and caution was necessary in passing along to get a firm foothold amongst them—neither on forest or fruit trees, or on Hawthorn hedges was a green leaf to be seen." It was a part of Sussex of which Mr. Wright wrote. It is to be hoped that such a terrible scourge will not invade our district. The remedies adopted to battle with this moth (it passes into a caterpillar after laying its eggs while a moth) have been rather disheartening reading.

Grease bands are used to prevent the passage of the moth up the stem, these needing constant watching. By removing the ends of shoots we can also destroy eggs already there. Then comes the work of spraying the trees with a solution of Paris green. It is a sickening story. But as this paper is on hardy fruit I could not but mention such a terrible evil, knowing that it is no exaggeration by the source from whence it came. I need hardly say the culture of hardy fruit under such conditions, were it likely to become annual for a few years, would put an end to all hopes of successful fruit culture here or anywhere else.

CANKER.

This disease has long engaged the attention of practical men, and the conclusion they arrive at is that it is caused by, and is the result of the roots foraging in the cold and unsuitable subsoil. But is this the primary cause? I think not. There is no doubt, however, that subsoil rooting does accelerate canker. Apple trees are predisposed to canker, and why? Because, in my humble opinion, of the intervention of the mechanical and tedious process of grafting, more so than in budding. The few opportunities which have been mine of observing and of inquiries which I have been in the habit of making, certainly go to prove that canker is due to grafting, as I have come across no instance where seedlings were affected by the disease or of trees that were said to be from cuttings being affected thereby. If the process of grafting be the primary cause of canker, then it points out that all grafts should be inserted on the stock as low down as possible, in order to give the trees a chance to get on their own roots. We do this with Roses, why not with the more valuable fruit trees? Budded trees are not so liable to canker as the grafted trees, because the union is more effectual, and they should be preferred. I have carefully pared away at apparently healthy young trees which I have destroyed by so doing, in order to see if the union was perfect at the point of junction of stock and scion, and I have invariably come to the line of separation, which was evident by discoloration, in some cases more marked than in others, and which evidently was the seat of decay, to show itself hereafter as canker. Canker may be retarded, however, by selecting scions and stocks which shall be more alike in size. It certainly does seem unnatural to allow one half of the cambium of the scion to rest upon the central wood of the stock, the union in such cases is not so perfect as it should be.

I certainly think we are not at the bottom of this question yet; it is a wide one, and deserves attention at the hands of experienced men, who are certainly on the right track when they agree as to the effect of subsoil on the disease. It is certainly the best to keep the roots of fruit trees out of the subsoil, as the food they would be likely to get from such a source would not be likely to benefit the trees by reason of its remoteness from the beneficial influence of the sun and air.

SOIL AND ASPECT.

We often read articles on this subject in the gardening papers. They all pretty well agree that the most favourable site either for an orchard or garden is one facing south with shelter from the prevailing westerly winds and from the biting easterly wind. Of the latter I think we have had the advice well rubbed in this winter. But as a rule the position of the orchard or the garden in a large private place is subordinate to the position of the house, the extent of the grounds, and the fancy of the proprietor, while for smaller places choice is out of the question altogether.

There is the garden; it may be in a low and damp position, one of the very worst of sites for fruit trees, or it may be unduly shaded by large trees, which must not be cut down, which if allowed a free root run (and it is difficult in many instances to prevent this) would rob the garden of its fertility. This is of course an extreme case. But it is often met with, and is one of the many obstacles which defeat the best efforts of many a hard-working gardener.

Then again we are advised, and truly so, that a good depth, say from 2 to 3 feet, of good loam is the best of soils. But how often do we get such a paradise for fruit trees? The fact is we have to do the best we can with the soil whatever its quality may be, and we know that the Apple and Pear, Cherry and Plum, will succeed in almost any soil, but of course doing best in the soil advised. We may be able to improve the staple by occasional loads of loam, and by the addition of lime for stone fruit, and with manure for all, and this is about the most we can do. Certainly, if we wish to encourage fruit culture by the many, we ought not to discourage intending planters by laying down hard and fast lines as to site and soil.

A few words as to subsoil. I saw it advised the other day in a gardening paper, that in cases where there was an unsuitable subsoil it should be removed, and suitable material put in its place. I fail to see the utility of such advice, which to my thinking is so delightfully vague as to be scarcely worth noticing. If fruit tree culture won't pay without removing the subsoil I feel pretty certain it won't with it. I would say by all means ascertain the nature of the subsoil, so that you would know how much upper soil, of what quality and staple your trees would have to rely upon. If the subsoil is clay, plant high and drain. If of hard rock, do not plant at all; but if of soft rock, sandstone, or shale, you may plant and not trouble about draining. If chalky it is good for stone fruit, and a portion of such subsoil would not be amiss if mixed with the upper soil when trenching. Marl is also a good subsoil; it contains lime, and is considered warm. Generally speaking, gardeners do not rely so much upon the nature of the subsoil as they do upon skilful management in planting and pruning, but they always ascertain its nature as a guide to cultivation.

(To be continued.)

CELERIAC.—Although not greatly in demand, there is no good reason why it should not be more grown and used than is the case generally in this country. Large or fully grown roots, properly cooked and served, please some tastes as a vegetable, while some use it in salads, though more often than not it is utilised for flavouring soups only. If either of the newer French varieties, notably the Apple-rooted and large Paris have been raised, these may well be preferred to

the much inferior ordinary form. In any case the seedlings should at once be pricked out and otherwise prepared for the open ground much in the same way as ordinary Celery. Being cultivated for the roots only, planting on the surface answers best, this crop forming a good succession to early Cauliflowers.—W.



ENGLISH CHRYSANTHEMUMS.

SOME months ago you admitted to your columns the conclusions at which I had arrived concerning the relative merits of the leading Chrysanthemum novelties sent to this country from France, America, and Japan. The results of my experimental culture were, it may be remembered, varied, but one conclusion remained very definitely in my mind, and that was that a very liberal discount must be allowed from the highly coloured descriptions which generally accompany these novelties, especially those received from our neighbours across the Channel. It is very disappointing and a considerable waste of time and space to find after a couple of seasons' trial, that some novelty, heralded with vigorous blowing of the advertising trumpet, is, after all, but an impostor, deserving residence only on the rubbish heap. So it came to pass that the one conclusion to which I have referred led to the further one, that it would be highly desirable, if it were possible, to raise one's own seedlings and novelties. And the first attempt in this direction has proved that the attainment of this result is not only possible but comparatively easy. Indeed, I see no reason why any amateur like myself, with reasonable facilities, should not be the creator of his own new varieties, and thus add a very interesting element to the ordinary culture of the flower.

It has been stated that in order to sufficiently ripen the seed of the Chrysanthemum in this country the ovules must be impregnated and the seed procured in October. This I have found to be quite unnecessary. It must be admitted that the late winter afforded a test not likely to be exceeded in severity. My operations commenced after the November shows were over, extending from about the 20th of that month to the same time in December. The result has been that in due time I obtained a certain quantity of sufficiently ripened seed. This was sowed on the 5th of March last, and I have now some forty-five promising looking seedlings already, showing that they include several distinct varieties. But for an accident which took place shortly after Christmas I should have had a very much larger quantity of seed. However, the simple fact that English seedlings can be obtained without any of the supposed difficulties is proved beyond doubt. What may be the value of the result in the present instance has yet to be seen, and, owing to the lateness of the sowing, it may need a second season to prove some of the varieties. But there ought to be some novelties of value amongst the seedlings, if one may draw conclusions from the parent varieties, which were E. Molyneux, Boule d'Or, Sunset, George Maclure, Puritan, Condor, and H. Elliot.

I may say of George Maclure that it is one of the most floriferous varieties in existence. One plant which flowered well in November has ever since thrown out lateral flowers in profusion, and some of these fully 6 inches in diameter. I expect much from this variety hereafter.—CHARLES E. SHEA.

[A bloom sent with our correspondent's interesting letter shows the variety to be Japanese, similar in colour to Edouard Audiguier, but with more substantial florets. Its character could not be seen to advantage, however, as the bloom had been subjected to both snow and frost.]

CURRENT NOTES.

FRUIT PROSPECTS.

THE remarks of Mr. Wright under the heading "Blossoming Time" were so pertinent and timely that they well repay a very careful perusal. Fruit and its production has been one of his lifelong studies, and all that he writes thereon is full of truth. Much that he says on pp. 379 and 380 contains matter that is as applicable to fruit culture under glass as outdoors, and in fact contains the gist of the whole question of successful fruit cultivation. The formation of fruitful wood moderate quantities of

well formed blossoms, reasonable quantities of fruit, timely supplies of food and of water, and genial conditions of atmosphere are essential conditions of regular crops of good fruit. All these are under the control of the gardener, who has to produce fruit in suitable houses properly heated and efficiently ventilated. Outdoors the gardener is very much the victim of circumstances, but even there he has some things generally at his command, and Mr. Wright has indicated them. Good gardeners will read and act upon those hints if they have not previously practised the things he suggests; other gardeners will—well, perhaps they will read them.

ABOUT LONDON.

Much, very much, is to be learnt by a visit to the London nurseries and market gardens by any gardener who has, like "A Novice," the faculty of carefully observing and faithfully remembering what he sees and hears and the ability to trace cause and effect. All other conditions being equal, these are the men who make our best gardeners and constitute the props of our—I was going to say "profession," but as domestic servitude is not a profession I will substitute the word calling.

TOP-DRESSING POT PLANTS.

Undoubtedly there are a few plants that are such gross feeders and surface rooters that a top-dressing of soil may advantageously be applied to them; but any plants that are neither gross feeders nor surface rooters will be much better left alone in that respect, for if they are top-dressed the operators will find that the difficulty of watering will be real, and that it will be second only to that of keeping them alive and healthy if the plants are of a delicate and fine-rooting nature. "D.'s" remarks were general, but probably he only intended to refer to the class I have first mentioned.

CUTTING OFF THE ROOTS OF PALMS.

As "D." has been so successful in his disrooting operations I cannot do better than quote the conditions he has found necessary to insure that success—viz., "Precautions to keep them in a close, moist (and he has omitted 'warm') house, where they are well shaded from sunshine for a few weeks after the roots have been curtailed." It is because so many thousands of the readers of the Journal who have Palms have neither the experience of "D." nor the conditions mentioned that I say to such who are tempted to try the operation—Don't!

SPECIMEN PLANTS.

In the report of the Crystal Palace Show remarks are made in reference to the general quality of some of the exhibits in the classes for specimen plants. Probably no one acquainted with the facts of the case will say that in some of the classes the remarks were uncalled for. The "Southrons" do not appear to be strong in stove and greenhouse plants in the month of May. Perhaps they reserve their strength for later events. The winning plants from Staffordshire were neat, fairly flowered plants as a rule, the Anthurium, and Statice, and Tremandra especially; but when an average good collection wins so easily, what is the general quality of the others?—HUGH DALE.

THOUGHTS ON THE MANCHESTER SHOW.

DURING my visit to the Manchester Show many thoughts passed through my mind as I admired the various exhibits. The groups of plants were beautiful, and represented a great advance in tasteful arrangement over the packing and massing that prevailed a few years ago. In a great measure this is due to men who strike out lines for themselves, and if only those who went to Manchester looked carefully at the grouping they must have certainly come away with some hints of a lasting and beneficial nature.

Turning from the groups to the Orchids I thought the display was gorgeous, and it was evident that the cultivation of these plants is well understood. Could some of those brave men who faced hardships innumerable, and even death itself, in collecting varieties have seen the results of their labours, how gladdened they would be; and I often think of the disappointment they must have experienced on learning that many of the plants they despatched were found to be dead on their arrival in this country. Happily for us, quicker means of transit now prevail, and the essential conditions for success are better understood. And then the nurserymen's exhibits! Many of us do not sufficiently estimate the marvellous wealth of choice plants they bring from time to time before us. At Manchester they formed the major portion of the Exhibition.

New, rare, and choice plants, sufficient to please the most fastidious and satisfy the most exacting, were arranged for inspection by such firms as Cypher, Heath & Sons, B. S. Williams & Son, Liverpool Horticultural Company, Charlesworth, Shuttleworth & Co., Dicksons Limited, R. P. Ker & Sons, J. Waterer & Son, Paul & Son, Turner, and others. The beautiful Clematis we have been accustomed to see from Messrs.

Smith of Worcester were absent, and I was rather astonished to find the progressive firm of Messrs. Clibran, Altrincham, not represented.

After viewing the Show I had just time to walk through the Botanical Gardens, with its well-kept Palm house, fernery, conservatory, Orchid house, &c., all in the best condition in the hands of Mr. Bruce Findlay, the skilled Curator. The gardens were crowded with a large concourse of people, many of whom having enjoyed the beauties of the Show, were listening to the music, and I left fully satisfied that I had spent a profitable and delightful half-holiday.—R. P. R.

SWEET BRIAR LADY PENZANCE.

THIS is a charming single variety, with metallic rosy bronze flowers, yellow at the base of the petals. The flowers are about 2 inches across, and the foliage is fragrant. A note accompanied the plant, exhibited at a recent meeting of the Royal Horticultural Society, to this effect:—"The specimen is a graft or bud on the Manetti of a seedling from the common Sweet Briar, crossed with the pollen of the Austrian



FIG. 77.—SWEET BRIAR LADY PENZANCE.

Copper Briar in 1886. The seedling came up in the spring of 1887, and flowered for the first time in 1889, but had only one flower. It is now a vigorous plant 4 feet high, the wood a sort of purple colour like that of the pollen parent." We have had occasion to note several fine seedlings raised at Lord Penzance's garden, Eashing Park, by Mr. Baskett, and this is one of the most distinct and best, proving how much there is yet to be accomplished amongst such plants by well considered crosses.

BOTHWELL BANK STRAWBERRY.

IN your footnote to "W. T.'s" article on page 413 you mention having received an interesting letter about the origin of this Strawberry. I am very sorry if I have said anything about Mr. Chisholm that was not true. I merely related the story of the origin of this Strawberry as it was related to me, not doubting the veracity of the statement. Mr. Rutherford, my author for the statement, I believe served his apprenticeship at Camperdown, and it was while he was there, he said, Mr. Chisholm was employed as foreman.

"W. T." says I have failed to prove the identity of Bothwell Bank. I can only prove to what I have grown for it, and, as I have already said, it resembles President too much to be distinguished from it. The stock from which my plants were taken was received from an Edinburgh firm the previous autumn. President was discarded for mildew, and I lifted the runners myself; therefore there could be no mistake in my plants.

Some time afterwards when talking to the head of the firm who supplied the plants, I mentioned my doubt of the variety being distinct from President. His answer was, "We supply Strawberries under whatever name asked, whether they are distinct or not." It is rather tantalizing when one gets what they suppose to be something new to find it is only what they have been growing for years under another name.

The Countess, a Strawberry largely grown in some parts of Lanarkshire, is too much like what I have seen and grow as Garibaldi. The Countess I have grown is a large, midseason, round, conical berry, and takes long to colour to the point.—G. MCD.

[A firm who supplies Strawberries "under whatever name asked, whether distinct or not," should at least take care that their stocks are pure and true to name. The Countess is perfectly distinct from Garibaldi (Vicomtesse Hericart de Thury), and in flavour is much superior to it.

Relative to the Bothwell Bank Strawberry, the writer of the letter we have received is so competent as a judge of Strawberries, was so intimate with Mr. Chisholm, gives such a circumstantial account of the origin and preservation of the variety, also vouches for the fact that Mr. Chisholm "never set foot as an employé in other than two gardens before he left Scotland" and Camperdown, was not one of them, that we must admit him an authority on the subject in question. He was in close connection with Mr. Chisholm from the first moment of his gardening career till its close in this country, and goes on to say, "I have forced the Strawberry Chisholm brought me from Bothwell Bank both early and late, and grown it in most parts of the garden with varying success. It has failed to take first rank. That, however, may be said of most other good Strawberries here except Garibaldi (Vicomtesse Hericart de Thury), James Veitch, Keen's Seedling, and Waterloo in the order named; so the failure of Bothwell to rise to 'first rank' is no disgrace. It is, however, too near to James Veitch in every point except bearing qualities to be worth growing here, and if it had not been for the way I got hold of it I would have condemned it to the rubbish heap years ago. I have no reason to doubt Chisholm's statement that he found the original plant as a chance seedling at Bothwell Bank, and knowing his movements so well I do not see how he could have obtained it elsewhere."

Our correspondent desires us not to publish his name, as he fears it would bring him "inquiries from all parts of the universe," and he would not have time to attend to them. He will perceive that "G. McD." was misled, and admit that his explanation and expressions are quite satisfactory.]

CULTIVATION OF NARCISSI.

THROUGH the courtesy of Mr. Albert F. Upstone, Hon. Secretary of the Progressive Horticultural Club in East Anglia, together with the consent of Mr. T. C. Edmonds of Caistor, Great Yarmouth, we are enabled to submit to our readers the following purport of a paper on the "Cultivation of Narcissi," which was read by the latter gentleman at the monthly meeting of the Club held in Norwich on Wednesday, May 13th. The Hon. Secretary also read a paper on herbaceous plants, and for which we may find room another week.

I have been asked to read a paper on the cultivation of this beautiful spring flower, in my opinion second to none taking all things into consideration—viz., its hardihood, general adaptability to nearly all soils and situations, and the comparatively small amount of care required to ensure a fair amount of success. I shall not attempt any botanical classification of varieties, anyone who wish to do so will find ample means provided for them to do so by consulting the works of Herbert, Burbidge, Barr, Baker, and others. For my purpose this evening I shall for identification divide them into four or five classes—viz., first the Ajax or Daffodil type, of which you may take as examples Emperor, Maximus, the common Lent Lily, Captain Nelson, &c. Secondly, the bicolor section, perhaps the best for cutting purposes, and certainly the most sought after. Of this class you may take Empress, Grandis, and Horsefieldi, J. B. M. Camm, and others, as affording a fair illustration of their beauty and usefulness. Thirdly, the Incomparabilis section and its many sub-sections and varieties, of which we may take Sir Watkin as one of the largest and best, C. J. Backhouse, Princess Mary, Cynosure, Conspicuous, Maurice Vilmorin, Orange and Sulphur Phoenix, &c. Fourthly, the white varieties of Leeds, of which none are better in my collection than Minnie Hume and Katherine Spurrell. Of the white Ajax or Trumpet varieties, there are Cernuus pulcher and William Goldring. They are good and distinct. The double form of Cernuus is very beautiful, scarce, and dear. The varieties Nelsoni major and Aurantius are distinct and good.

The fifth section I will call the true Narcissi—viz., the varieties of Burbidgei and Poeticus. Of the varieties of Burbidgei, Constance and Beatrice Hesseltine are very beautiful; of the varieties of Poeticus there are many so much alike, and only worth growing as varieties. The best are unquestionably Ornatus and Poetorum. I might say, in passing, that the double white, or Gardenia-flowered variety of Poeticus is not,

as many persons suppose, the double form of recurvus, but of patellaris, a distinct and by no means a common kind. Of all varieties of Narcissi that have come under my notice the common form of Poeticus (recurvus) is in proportion to the number of bulbs grown it gives the least number of flowers. The same remark applies, only perhaps in a less degree, to the double form; the flower stalk and spathe appears, but about 25 to 30 per cent. never produce a flower. Various causes have been stated, but no definite conclusions have been arrived at. My experience points to the fact the lighter and drier the soil the less flowers, more so if hot weather sets in at blooming time. I noticed last year a very long single row of this variety planted near the margin of Ormesby Broad, one of the freshwater lakes near to me, where the soil was alluvial, and their roots must have been sucking up water. In that situation they bloomed abundantly, and of very large dimensions—in short, the finest I ever saw.

Lastly, the Polyantha, or Tazetta group; these are not hardy in the strict sense of the term, as applied to the other varieties, although I have managed to keep and flower them for upwards of twenty years in my garden. Some few years ago I lost several thousand bulbs in the third week in March. They had speared through the ground and had cracked the soil considerably in the rows, when the frost came down, and we had near a week of it, and as a consequence 90 per cent. were killed, and the remainder were not worth keeping to recover. Last year I had the curiosity to measure some of the foliage of Grand Monarque (otherwise floribundus)—viz., 37½ inches long, 1¼ inch wide. Bazelman Major of the Dutch or Trewianus of botanists is the best of this section, shy of stock and dear in price. Soleil d'Or and Grand Monarque are two useful kinds.

I will suppose that the Narcissi have ceased flowering, and that it is the intention to take up such sorts as require to be lifted, either from their having stood long enough in one place or that they have become too thick, either in the clumps or rows. Some sorts require lifting every year, some stand two and take no harm, but the majority will be all the better removed at the end of the third season after planting. I am aware that much difference of opinion exists as to the removal and replanting of Narcissi, but I am giving the result of my experience, extending for upwards of twenty years. Do not wait until the foliage is dead, or until they have all died down; they will not all be ready at the same time. As a general rule the most delicate kinds—notably the varieties of Cernuus and its near allies, Major, Maximus, Tenby, and many others of the same section—are better on my soil by being taken up every year and replanted. I take mine up as they are ready, when the foliage is between green and yellow, and there is still a handhold above ground, by opening a trench at the end of the bed down to the base of the bulbs in the rows, so that I can see them all clearly before I lift them out of the ground, and so proceed row by row, taking a tray, basket, or barrow to hold the bulbs of each variety according to quantity. I take them at once to my fruit room; some I lay on the floor, some on the benches, small lots are left in baskets and trays, but all are housed at once from sun and rain, and allowed to gradually dry and ripen. I might say there are wooden louveres to this building, and it has a wooden floor, and I ventilate according to the weather. When the foliage has decayed so whereby it can be detached from the bulb without any force being used to injure the neck of the bulb they are gone over, and it is removed, and the bulbs are from time to time turned about.

The division of the bulbs and the removal of offsets is deferred until just before planting time. They have had time to ripen, and they separate with more ease and less injury. I am no advocate for removing small offsets. I remove as much of the old rootstock as I can without injury to the base of the bulb. Just before, or at planting time, I divide the bulbs of each variety, of which I hold a large stock, into three sizes—viz., stock, saleable, and offsets, and plant each size by itself. For trade purposes this is imperative, but for amateurs not at all necessary.

The next operation is getting the beds or quarters ready for planting. For the strong-growing kinds I trench my land, and as it has generally been manured for some previous crop I do not use any manure for them. The more delicate growers, such as Cernuus and its near allies and some others, are better grown in maiden soil if you can get it. In my garden, where the soil is of good stiff loam resting on a brick earth subsoil (not clay), they all seem to do fairly well. I think the majority of the family, in fact any that are worth growing, will thrive in almost any soil of fair quality. I like a situation that is well exposed to the sun and air, and sheltered from winds between north and east. I believe winds spoil the flowers more than frost. I have seen them whipped and spoiled by wind, whereas I have seen the flowers and stems frozen and they have not been injured to any great extent. I plant most of mine in beds in rows across the beds a foot apart from row to row and 3 or 4 inches from bulb to bulb, more or less according to the growth of the variety. Some I plant in clumps; they are those I only retain a few for the sake of having the variety—six, nine, or twelve, according to size.

Planting time with me is the month of August, and finish the first week in September at the latest. Narcissi suffer in bulb and bloom by late planting—note too early rather than too late. Much has been said and written as to the proper depth for planting Narcissi. In this as in many other directions, no hard and fast lines can be laid down. My experience points to the fact of more evils attending shallow than deep planting on my soil. I should not advise less than 4 inches from the base of the bulb to the top of the soil as a medium depth for the majority; for the small and delicate kinds rather less, and for the strongest something

more. Begin with the earliest flowering and finish with the late. All my Polyanthus Narcissi are not less than 6 inches underground. One bed of Bicolor Maximus (now Grandee) that I took up last summer, which had stood three years, in which there were about 1000 bulbs, I planted and took them up myself. They grew well, and flowered each year to my entire satisfaction, and they were rather over than under 6 inches underground. Locality, soil, and circumstances must be considered, and act accordingly. A wet or waterlogged soil is very bad for them, and a very dry or sandy is not to be desired.

When the soil has fairly settled from rains after planting, some time during the early autumn months I run the hoe and rake over the beds once or twice, according to weeds and weather. During the winter months I look through all the beds of my choicest kinds, and if I find any of them speared through the soil I cover them over with a little hillock of dry loose earth. As soon as I can in February or March, according to season and weather, I put the hoe and rake through the rows, and as soon as the soil is dry enough I press the soil down firm by the sides of the bulbs, and if the land is very spongy from frost I tread the soil with my feet, setting the top soil free again by hoe and rake the first favourable opportunity. And bear this in mind: Get your beds thoroughly cleaned before the plants flower. You cannot do it so well afterwards, as by the expansion of the leaf growth they are all over the beds.

At the flowering time (March, April, and May) I proceed, note-book in hand, every few days, recording any facts of any variety of which I wish to be reminded at any future time. I generally discard some every year, and try to keep the best I can for furnishing a continuous supply of cut blooms, beginning with Ard Righ and finishing with Double White. I find by my note-book that I have eighty-five varieties under number; I have also many kinds in large quantities without any numbers. For all useful purposes I might, with some degree of reason, considerably reduce the number of varieties; but variety is charming, and I find the sorts do not succeed alike year by year.

The period for cutting Narcissi blooms has been laid down by some to be the bud stage. This may do for some kinds, but it is inadmissible in others. Most of them lose colour and substance as soon as taken indoors—when I say so, I mean for some few days. I like mine to be fairly expanded before cutting, and with a little attention they may be kept for at least ten days in very fair condition. Narcissi need no staking, insect pests do not trouble them, slugs and snails leave them alone, they require no shading, and the first shower of rain will not spoil them, or a slight frost ruin all your hopes. They are the most accommodating hardy bulbs known to me. I have had some bulbs lying in my garden on the top of the soil for eighteen months, and to all appearances they are alive. I have had some bulbs on one of my windows inside my dwelling house for a like period, and they are as sound as acorns; but experience has proved that it takes a like period of time, or perhaps longer, for the bulb to regain its normal condition.

I am afraid that I have said more than is necessary, and have somewhat exhausted your very patient hearing; however, if you wish for my experience as to the best sorts to cultivate I will give it you in very few words. Taking the Ajax or Trumpet section, first and foremost of which stands Emperor, Golden Spur, John Nelson, Countess of Annesley, Maximus, Captain Nelson, and Tenby. Very many of this section are bad growers, notably all the varieties of Spurius; Major, Maximus, and several others are the better for change of soil and situation.

Of the varieties of the bicolor section, so far as the flower is concerned, there is a very slight difference between Horsefieldi, Empress, and what is now called Grandee. Horsefieldi is the earliest to flower, closely followed by Empress, with a longer flower stalk. Grandee is the latest, and taking all points into consideration I am decidedly of opinion that it is the best of all the bicolors. J. M. B. Camm is a very beautiful flower, and distinct. There are several other varieties very much alike to each other.

I grow but very few kinds of the Trumpet or Ajax section, with white or sulphur-coloured flowers. Of the many so-called varieties of Cernuus I only grow Cernuus, Pulcher, the double form of Cernuus, and William Goldring.

Incomparabilis embraces a large number of very good kinds; first and best, Sir Watkin, C. J. Backhouse, Cynosure, Princess Mary, Stella, Conspicuous, and Maurice Vilmorin.

Amongst the white Leeds varieties there are several very good kinds. Of those that I have grown, all points considered, there is not one equal to Minnie Hume, Gem, Katherine Spurrell, and Duchess of Westminster are good.

Many of the varieties of Burbidgei are not equal to the better forms of Poeticus. Amongst the best are Constance and Beatrice Hesseltine, the latter one of the most beautiful flowers in cultivation. Nelsoni major is distinct and useful and of good constitution. Nelsoni aurantius is very beautiful, shy of stock, and uncertain in its orange tube.

In the Poeticus section Ornatus is the most useful, Poetarum the most beautiful, and Grandiflora the largest. Amongst the doubles Orange and Sulphur Phoenix and Double White must not be omitted with those who like them, but they do not find much favour, except the later Double White.

Of the Polyanthus varieties the best is Trewianus. Grand Monarque and Soleil d'Or are good and useful.

The few remarks I have made are the results and outcome of my own practice, and such as have given me much pleasure and satisfaction extending over a considerable period of time. There may be, and per-

haps are, better varieties than I have named, but I wish you to understand that I have grown all the varieties that I have recommended.

One word more as to the number of varieties. I find by my note book I did not put up in my stands at the Norwich Spring Show a single bloom of any variety that I exhibited in the year previous. The reason is obvious—they were not in bloom, the season being late and the Show early. Only the early varieties were in, whereas last year the Show being held on the 1st May, it was the latest only that could be obtained in condition. So it would appear that for exhibition purposes you must grow a larger number of varieties than one would think necessary.



JOTTINGS.

ORCHIDS have been exceedingly well represented at each of the Royal Horticultural Society's Temple Shows, but the display on Thursday and Friday this week far surpasses in extent and variety those of previous years. The Orchid Conference at South Kensington in 1885 brought together the largest number of species ever publicly exhibited, and there were also some hundreds of fine plants; but it is quite likely, when the comparison can be made, it will be found that the Temple Show of 1891 has beaten even that record. It may be well to recall the chief facts as regards the statistics of the 1885 Conference. The total number of genera represented was fifty-seven, the species and varieties number 348. Of the larger genera there were the following species:—*Odontoglossum*, sixty-six; *Masdevallia*, forty-eight; *Dendrobium*, thirty-four; *Cattleya*, twenty-seven; *Oncidium*, nineteen; and *Laelia*, eleven. It will be interesting to see how these figures stand with regard to the present Show at the Temple, and I shall endeavour to obtain a full list for that purpose.

Few plants are so naturally adapted for effective grouping as Orchids, especially when associated with Palms and Ferns, but much might be done to render such groups still more attractive. Examples of the natural style, which at the same time is the most artistic, have been afforded by several amateurs and nurserymen; for instance, at Penllergare some years ago there was rockery, Fern, and Orchid house of a most tasteful design; in Mr Smee's garden

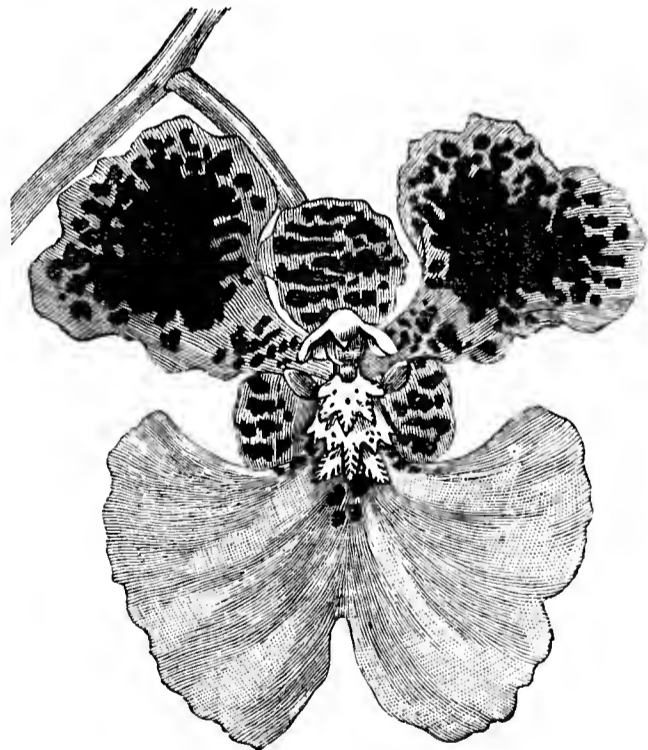

FIG. 78.—ONCIDIUM LARKINIANUM.

at Carshalton is a house of a similar character at the present time. Messrs. J. Veitch & Sons have a comparatively new house in somewhat the same style, and very beautiful effects are produced. Messrs. Sander & Co. also have shown excellent taste in this way, both by their house at one of the South Kensington Exhibitions and at St. Albans, while Messrs. B. S. Williams and Mr. W. Bull have furnished similar examples in their respective home exhibitions. A reminder of what can be effected by a little attention to the natural habits of plants was recently afforded at one of Messrs. Protheroe's meetings, when the branching stem of a tree was sent

covered with Dendrobiums in flower, producing a charming effect. It was much admired, and there was quite brisk competition to secure it. Many Orchids could be established on tree stems like this, the only disadvantage being the difficulty of removal; but where Orchids are grown for the pleasure they afford and not for sale this would not be a serious trouble.

On all sides I hear that the demand for cut Orchid flowers this season is greater than has ever been known before, and it is evident an important trade is developing. One of the florists' windows in Covent Garden Market is almost filled with these flowers, and some of the large firms that make a specialty of Orchids find it difficult to meet the demand, although scores of boxes are sent out every week. I heard of a gentleman recently who celebrated his birthday by a dinner party, when *Lælia purpurata* was exclusively used for the floral decorations, some hundreds of flowers being employed with superb effect. Most of the *Cattleyas* have a very rich appearance under artificial light, and in contrast with snow-white cloths. *Odontoglossum vexillarium* has a very soft and delicate effect, but unfortunately the flowers do not last well when cut, though one decorator assures me that completely immersing the flowers in water after cutting for some time before they are used renders them much more lasting—sufficient at least for the purpose.

Speaking of *O. vexillarium* reminds me that a friend states he finds this plant "succeed under cool treatment, a minimum temperature of 40° being allowed during winter, with plenty of ventilation." I cannot recommend beginners to try this as an experiment, but it is worth placing on record as showing how diverse are experiences in cultural matters, and I know the statement can be relied upon as to that particular case. It is true his garden is in warm and sunny Kent, and there must be some favourable local circumstances apart from attention, as several plants thrive and flower there as I never see them elsewhere. My experience and observation point to "cleanliness" being the great secret in growing *O. vexillarium* satisfactorily; a few insects soon ruin the best plants ever grown.

It is seldom that a plant receives double honours from one R.H.S. Committee. Yet this has taken place with *Oncidium Larkinianum*, of which a flower is represented in fig. 78. When originally exhibited it was adjudged an award of merit, and when shown on April 21st last this judgment was confirmed by awarding a first-class certificate to Mr. J. Larkin of Watford, whose plant had a strong inflorescence and large brightly coloured flowers. *O. Larkinianum* is one of the *Marshallianum* type, the lip very broad and rich yellow, the sepals and petals heavily spotted with deep reddish brown. It is one of the most effective *Oncidiums*.—LEWIS CASTLE.

ORCHIDS AT AYMESTREY COURT, WOOLTON.

I HAD an opportunity one evening last week of viewing the collection of Orchids at Aymestrey Court, and I came away with a consciousness that for the room at disposal for their cultivation it would be a difficult matter to see them excelled. The chief interest centred in the *Odontoglossum vexillarium*, which are in fine condition. The plants are arranged on a stage, and so profuse was the bloom that the small Ferns interspersed could scarcely be recognised. There are about seventy spikes on eighteen plants, averaging seven to eight flowers on a spike. A grand piece of *O. vexillarium roseum* in an 8-inch pot was carrying ninety-seven very fine flowers, and was especially noticeable. With this exception the remainder are grown in 5-inch pots, and several forms may be seen amongst them, one variety having gigantic flowers, whilst others varied considerably in colour. A little over three years ago these plants were in 3-inch pots. Comparing the growths of last season and those now flowering will convince one that the best treatment is provided. In another house were numerous plants of *Odontoglossum Alexandræ* all in splendid condition, and showing abundance of fine healthy spikes. Other Orchids in flower were *Odontoglossum citrosimum*, with its varieties *roseum* and *album*, *O. Roezli*, &c.; *Cypripediums Argus*, *caudatum*, *Dayanum*, *superbum*, and *Lowi*; *Dendrobiums Freemani* and *suavissimum*; *Epidendrum vitellinum majus*, with *Oncidiums concolor* and *ampliatum majus*. Numerous *Cattleya Mendelli* were pushing, as also was *Lælia purpurata*. In one of the vineries *Lælia anceps* in baskets suspended from the roof (where the plants derive all the benefit of the sunshine) were in robust health. Fine healthy *Phalænopses* are grown, and though I missed seeing them when in bloom, the remains of the old flower spikes was evidence of what they had been. Other plants are well grown here, and Captain Robinson cannot fail to appreciate the interest Mr. Osborne takes in the welfare of everything connected with the gardens.—R. P. R.



EVENTS OF THE WEEK.—The great horticultural event of the current week will be the Royal Horticultural Society's Show, which opens to-day (Thursday), and closes to-morrow evening. The Show will be open to-day from 1 P.M. to 8 P.M., and on Friday from 10 A.M. to 6.30 P.M. An important sale of Orchids will be held at Messrs. Protheroe & Morris's rooms in Cheapside on Friday, May 29th. Beyond that there is little to note except the meetings of the Royal and Linnean Societies on Thursday, June 4th, the former at 4.30 P.M., and the latter at 8 P.M.

— THE PROPOSED HALL FOR HORTICULTURE.—We have pleasure in inserting the following notification to the Fellows of the Royal Horticultural Society, by Rev. W. Wilks, the Secretary:—"An opportunity offers for at once beginning the new hall and premises: If every Fellow of the Society would lend the Trustees an average of £7, the thing would be done, and England no longer be behind France and America in the possession of a horticultural hall. A friend has offered £5000 on condition of the hall being promptly commenced. Will you not help to secure this?"

— THE BROCKHAM ROSE ASSOCIATION.—The Hon. H. D. Ryder having been prevented by the death of a near relation from receiving the Brockham Rose Association this year at High Ashurst, the B.R.A. Committee have accepted the invitation of Sir Trevor Lawrence, Bart., M.P., to hold their Show at Burford Lodge on Wednesday, 1st July, 1891.

— MESSRS. J. CARTER & Co., High Holborn, are making a specialty of CACTUS, and have issued an illustrated list comprising some of the most distinct forms of these peculiar and interesting plants. The whole of the family was reviewed in this Journal several years ago, and the articles were subsequently published as a manual, of which free use has been made in America and elsewhere, but not always with acknowledgment.

— WEATHER AT LIVERPOOL.—What a change has been experienced in the weather since I wrote you last week. Fruit trees of every description in full bloom, and the country looking delightful, and now in many instances the chief portion of the Pear blossom has been literally swept away by the strong north easterly and north-westerly winds accompanied by showers of hail and sleet. In addition to this the temperature has fallen in a remarkable degree, and we have experienced sharp frosts on several nights. What damage has been done it is impossible to say as yet, but I am afraid some of the Pears must suffer considerably. The night temperatures have been, on the 13th May, 38°; 14th May, 42°; 15th May, 36°; 16th May, 32°; 17th May, 28°; 18th May, 26°; 19th May, 26°.—R. P.

— AQUILEGIAS are showy perennials, not nearly enough seen in gardens. Single plants dotted about do not represent the true beauty of the plant, they need to be seen in masses to obtain the right effect. By far the best plan is to sow the seeds thinly in a bed where the seedlings may be allowed to grow and flower. In the case of continuous dry weather thoroughly soaking the soil with liquid manure will promote freedom in growth, followed by a profusion of flowers. Some prefer the pale blue and white type, while others choose darker shades, and even striped flowers have their admirers.—M.

— ROYAL NATIONAL TULIP SOCIETY.—I have received an important communication from the Council of the Royal Manchester Botanical Society, in which they urge the Tulip Society to hold the Tulip Exhibition on Saturday, the 6th June, for many good reasons. On the other hand, several growers who voted for the 30th of May have written asking for the date to be altered if possible to the 6th June. Considering the Arctic severity of the weather, which has been quite as bad in the south and west as in the north and east, and as an immediate decision was required by the Botanical Society, I have on behalf of the Tulip Society, and in its best interests, agreed to the suggestion. The Tulip Show will therefore be held on Saturday, the 6th June, in the Royal Botanical Gardens, Manchester.—SAMUEL BARLOW, *Stakehill House*.

— CATERPILLARS AND FRUIT TREES.—A Gravesend correspondent writes:—"So far as my observations go, we have only a small number of caterpillars on the fruit trees herabout. The commonest this season as yet appear to be the little Ermine (*Hyponomeuta padellus*), the unpleasant webs of which are beginning to be conspicuous in some places."

— THE double white HYACINTH LA TOUR D'AUVERGNE is one of the best of its class for outdoor growth. When fully expanded the spikes are 8 inches long from the bottom bells, which are very double to the tip. The colour—pure white—renders this sort very useful if required for making into bouquets if the bell's are taken off singly and wired. Double Hyacinths are as a rule not general favourites, but this stands out as one of the best of its class.—S.

— THE very dwarf growing perennial DRABA GIGAS is useful for the sunny part of the rockery. The deep green of its thick, close growing leaves hang over the stones most effectively; the pure white flowers, too, are showy even at a distance. Although it grows freely it does not flower profusely for a year or two until it is thoroughly established in a good position. The severe winter does not appear to have affected it in the least, but rather the reverse, judging from its healthy appearance.—M.

— MIDLAND COUNTIES PANSY SOCIETY.—The Committee have found it necessary to postpone their Exhibition from June 10th to Wednesday, June 24th, in consequence of numerous intending exhibitors stating that owing to the lateness of the season their plants will not be in bloom by June 10th. Will intending exhibitors and visitors please note change of date, and that the Exhibition will be held in the Central Hall, Corporation Street, close to the railway station? Schedules can be had from Mr. W. Dean, Dolphin Road, Sparkhill, Birmingham.

— DAFFODIL TRUMPET MAXIMUS FROM SPAIN.—I have no intention of entering into a paper correspondence with the Rev. George H. Englehart. See *Journal of Horticulture*, May 21st, page 407. The fact is that the collector of the bulbs, instead of selling them as Trumpet maximus, offered them (cobnut in size) as a "mixed lot" in 1888, since which period they have, under judicious care and management, grown to enormous proportions, some of the offspring appearing amongst them same in size but paler in colour, that I would not take a sovereign each for. Surely this is palpable evidence of consanguinity with the largest of wild *Pallidus præcox* during the flowering period. If the collector sold the lot as Trumpet maximus anyone might be suspicious of imposition. For my part, I am quite certain there was none; indeed, the size of the bulbs in 1888 was totally against that theory; they have turned out the finest type of Trumpet maximus in cultivation, giving the Trinity College type only second place, and the Dutch specimen a subordinate position.—W. BAYLOR HARTLAND.

— THE *American Florist* records that HENRY NANZ, the pioneer florist of Louisville, Ky., died on May 1st last, and proceeds thus:—"Mr. Nanz was born in Stuttgart, Germany, in 1819, and learned his trade in the famous nurseries and gardens of that place. He came to this country in 1847, landing at New Orleans. He first tried his fortunes in Texas, but sickness compelled him to find a better climate. He came north with the United States soldiers who were returning from service in Mexico. When he landed in Jeffersonville in 1848 he was penniless. He first found employment at the famous Spring Garden, and after the collapse of that concern became gardener to the celebrated Ward family. Their conservatory soon showed the effects of his skill. He was in charge of it at the time when a mob endeavoured to destroy the Ward property in 1853, and valiantly, but vainly, endeavoured to save his floral treasures. By diligent economy and persevering activity he was enabled to lay the foundation for his now famous business, and bought an acre of land on Third Street, between Breckinridge and Kentucky, then considered away out of town. The rapidly growing city and the ever-increasing demand for his goods compelled Mr. Nanz to look about for more extended quarters, and he finally settled at St. Matthew's Station (Gilman's Point as it was formerly known), and there he purchased 30 acres of land, which he proceeded to lay out, and which is now the nursery of the firm. The distinguishing characteristics of Mr. Nanz's life were unvarying honesty and integrity in all his transactions, and his untiring activity, which seemed to have no limit, though when he had attained his seventieth year he retired from the active conduct of his business and transferred his interest to his son, Harry Nanz, and his son-in-law, Carl Neuner."

— GARDENING APPOINTMENTS.—Mr. Henry Dunkin, having filled the position of foreman to Mr. H. W. Ward at Longford Castle Gardens, Salisbury, most satisfactorily during the last seven years, has been appointed head gardener to the Right Hon. the Earl of Warwick, Warwick Castle, Warwick. Mr. Dunkin, whose name is not unknown to readers of the *Journal of Horticulture*, began his duties at Warwick Castle on the 27th inst., and we wish him every success in his new appointment. Mr. Wm. Wright, for the last three years gardener to G. T. Clark, Esq., Tallygarn, Llantrissant, has recently been entrusted with the duties of bailiff on that gentleman's estate. We understand that Mr. William Plester, Elsenham Hall Gardens, near Bishop's Stortford, has resigned his charge through ill health after thirty-eight years' service, twenty-four years with the late Mrs. Rush, and fourteen years with Walter Gilbey, Esq., the present occupier of Elsenham Hall, and his son, Mr. William Plester, has succeeded him.

— THE *Botanical Magazine* for May contains figures of the following plants:—*Yucca rupicola* (t. 7172), a distinct type; the leaves "margined with minute horny teeth," the flowers large and creamy white. The two following plates have been transposed by the binder, and if the numbers on the plate were not observed they might cause some curious blunders. It is strange how frequently the plates are misplaced in this magazine. *Wahlenbergia undulata* (t. 7174) is a beautiful Campanulaceous plant from South Africa, with narrow hairy leaves and large purplish flowers. *Hermannia cristata* (t. 7173) is also a South African plant related to the Sterculias, bearing lanceolate leaves and reddish flowers, said to be rich crimson in their native districts. *Pitcairnia Rozei* (t. 7175) is an ornamental species, with long bright red flowers in a loose racemose head. *Cœlogyne Rossiana* (t. 7176), a Burmese species of little beauty, the sepals and petals narrow and white, the lip also narrow, orange, with crimson streaks.

— A RICHLY ENDOWED AGRICULTURAL COLLEGE.—The Governor of Victoria, the Earl of Hopetoun, early in last month laid the foundation stone of a new College of Agriculture at Mildura, on the river Murray, one of the two Australian Irrigation Colonies, founded three or four years ago by the well-known firm of Chaffey Bros., under special acts of the colonial legislatures. A full report of the ceremony appears in the *Melbourne Argus* of April 6th. Mr. Geo. Chaffey, in presenting the trowel to his Lordship, stated that the value of the college lands exceeded that of any similarly endowed educational institution in Australia. These lands comprised 16,666 acres with water easements, valued (at the initial price of £20 per acre) at £333,320. A large portion of the property had, however, doubled in value, and it was quite within the bounds of probability that the endowment would be worth more than a million sterling before twenty years. Lord Hopetoun (in laying the stone) remarked that he had no doubt irrigation would play a most important part in the future of Victoria, and the Chaffey College, in affording facilities for imparting the necessary instruction in irrigation and its dependent industries, would be of immense advantage to the whole of Australia.

— THE KELSO CABBAGE COMPETITION.—Messrs. Stuart and Mein's third annual Cabbage competition took place on Saturday, May 16th, for a prize of £5. Formerly the Cabbages intended for competition had to be sent to Kelso to be judged, thus entailing much expense in the way of carriage on distant competitors, but this year's competition was held on novel and ingenious lines, which completely did away with this obstacle to many coming forward. Seed of Mein's No. 1 Cabbage was supplied last July to 8568 competitors, who received a certificate bearing a registered number, and which had to be filled up. The certificate was as follows:—"These are to certify that on Saturday, 16th May, 1891, a specimen of Mein's No. 1 Cabbage grown by Mr. _____ at _____ weighed — lb. — oz." This certificate had to be signed by the competitor, and two witnesses to the weighing. Notwithstanding the severe winter the weights of the Cabbages now to hand are extraordinary in the records of big spring Cabbages. The prize Cabbage was grown by Miss Hildegard A. Somerville of Drishane, Skibbereen, County Cork, and was certified by Colonel Somerville, J.P., D.L., of Drishane, and Egerton B. Coghil, Esq., of Castletownshend to weigh 9 lbs. 4 ozs. This speaks much for the mildness of the climate of County Cork, as the Cabbage was grown in the open air. The next best weights were from Great Malvern (Worcestershire), Shankill (County Dublin), St. Lawrence and Bifrons (Jersey), Dover (Kent), Lesbury (Northumberland) Camborne Polkerris and St. Blazey (Cornwall), Maldon (Essex), Old Montrose (Forfarshire), Paignton (Devon).—(*Kelso Chronicle*.)

— MANCHESTER SHOW.—Among other chief exhibitors and classes not mentioned in our report last week were Messrs. Cypher, Heath and Son, and Mould, who secured the prizes with plants in the nurserymen's classes—stove and greenhouse, Orchids, Heaths, &c. For eight Azaleas Mr. C. Turner, Slough, was well to the front with finely flowered plants; second Mr. Mould. Mr. Turner was the only exhibitor for eight Show Pelargoniums in flower and eight Fancy Pelargoniums. Roses were admirably shown and very fresh, Messrs. Paul & Son, Cheshunt, coming in first with the group, and also for twenty Roses in pots. For twelve distinct *Dracaenas* first Mr. B. S. Williams, London; second, Messrs. R. P. Ker & Sons, Aigburth Nursery, Liverpool; third, Mr. J. F. Mould. In the group of miscellaneous plants, occupying a space not exceeding 300 square feet, Messrs. Ker had a splendid arrangement, and bright in colour; second, Mr. A. J. Bruce, Chorlton-cum-Hardy. *Primula Sieboldi* from Ryder & Sons, Manchester, attracted many admirers. Messrs. B. S. Williams & Sons, Liverpool Horticultural Co.; Messrs. Dickson, Chester; and Shuttleworth, Carder, and Co., Bradford, are represented by many fine things. Fruit was well shown considering the season, the following being the prize-winners:—Sir J. W. Pease, Bart., M.P., Guisbro'; Duke of St. Albans, Duke of Sutherland, R. H. C. Neville, Esq., Mr. J. Thorpe.

— PHENOLOGICAL PHENOMENA.—A Committee of the British Association was appointed at York in 1844 for the purpose of reporting on the registration of periodical phenomena of animals and vegetables and in the following year presented a report which consisted mainly of a series of "Instructions for the Observation of Periodical Natural Phenomena." In 1875 the question was taken up by the Meteorological Society, which then issued a list of plants, insects, and birds recommended to be observed, with a code of instructions to observers. The list was slightly enlarged in 1883, but has now been greatly reduced, and, commencing with the year 1891, records of only twenty-four phenomena, relating to twenty-three species, are required. Forms on which to record observations, with a list of the species to be observed and instructions to observers, are supplied gratis by the Royal Meteorological Society, 30, Great George Street, London, S.W., and should be returned quarterly to Mr. E. Mawley, F.R.Met.Soc., Berkhamsted, Herts. We are requested to draw the attention of our readers to this investigation, as there may be many amongst them who would be willing to join the staff of observers, and under Mr. Mawley's supervision as recorder for the Society the system of observation has been greatly simplified.

— WIDCOMBE (BATH) INSTITUTE HORTICULTURAL CLUB.—An interesting meeting in connection with this Club was held at the Institute, Widcombe Hill, recently, to hear and adjudicate upon the essays written by members on the "Cultivation of the Potato." There was a fairly numerous attendance, presided over by Mr. W. Pumphrey (President). The essays were not to exceed 1700 words, so as not to take more than ten minutes in delivery, and altogether five were sent in for competition and read by the Chairman. Taken collectively the opinions expressed in the papers were extremely practical, interesting, and chatty. Some of the essays dealt with the introduction of the Potato into this country, and generally speaking the essayists, from their own experience in the cultivation of the almost indispensable vegetable, alluded to the most favourable time for and the best methods of planting the various species, the different modes in vogue as regards space, &c., earthing and manuring the soil, and other matters incidental to producing a crop. Each also referred to the Potato disease, and suggested various means to protect crops to a certain extent against its ravages. On a vote being taken it was found that there were twelve each recorded in favour of essays Nos. 1 and 4, and on another ballot there was a majority of two in favour of No. 1, under the *nom de plume* of "Jack Tar," and written by Mr. Trimby, No. 3, Regent's Terrace, who accordingly took the first prize. On account of the close voting it was resolved to give an extra prize to essay 4, "Practical," and sent in by Mr. J. Doe of Crow Hall Gardens.—(*Bath Argus*.)

— THE usual monthly meeting of the ROYAL METEOROLOGICAL SOCIETY was held on Wednesday evening, the 20th inst., at the Institution of Civil Engineers, 25, Great George Street, Westminster. Mr. Baldwin Latham, M.Inst.C.E., F.G.S., President, in the chair. Dr. M. G. Foster, M.A., and Mr. J. Robinson, J.P., were elected Fellows of the Society. The following papers were read:—1, "On the Vertical Circulation of the Atmosphere in Relation to the Formation of Storms," by Mr. W. H. Dines, B.A., F.R.Met.Soc. After giving an outline of the circulation of the atmosphere, the author refers to the two theories

which have been suggested to account for the formation of storms—viz., (1) the convection theory, which is that the central air rises in consequence of its greater relative warmth, this warmth being produced by the latent heat set free by condensation; and (2) the theory that the storms are circular eddies produced by the general motion of the atmosphere as a whole, just as small water eddies are formed in a flowing stream of water. The author is of opinion that the convection theory is the more probable of the two, but more information about the temperature of the upper air is greatly needed. 2, "On Brocken Spectres in a London Fog," by Mr. A. W. Claydon, M.A., F.R.Met.Soc., F.G.S. During the dense fogs in February last the author made a number of experiments with the view of raising his own "spectre." This he ultimately succeeded in accomplishing by placing a steady limelight a few feet behind his head, when his shadow was projected on the fog. He then made some careful measurements of the size and distance of the spectre, and also succeeded in taking some photographs of the phenomenon. 3, "An Account of the 'Leste,' or Hot Wind of Madeira," by Dr. H. Coupland Taylor, F.R.Met.Soc. The "Leste" is a very dry and parching wind, sometimes very hot, blowing over the island from the E.N.E. or E.S.E., and corresponds to the sirocco of Algeria, or the hot north winds from the deserts of the interior, experienced in southern Australia. During its prevalence a thin haze extends over the land, and gradually thickens out at sea until the horizon is completely hidden. It is most frequent during the months of July, August, and September, and usually lasts for about three days. Mr. Shelford Bidwell, M.A., F.R.S., exhibited an experiment showing the effect of an electrical discharge upon the condensation of steam. The shadow of a small jet of steam cast upon a white wall is, under ordinary conditions, of feeble intensity and of a neutral tint. But if the steam is electrified the density of the shadow is at once greatly increased, and it assumes a peculiar orange-brown hue. The electrical discharge appears to promote coalescence of the exceedingly minute particles of water contained in the jet, thus forming drops large enough to obstruct the more refrangible rays of light. It is suggested that this experiment may help to explain the intense darkness, often tempered by a lurid yellow glow, which is characteristic of thunderclouds.

THE SENSATIONAL WEATHER — THE FRUIT PROSPECTS.

THE enclosed photograph, taken by myself at a quarter past four on Monday morning, May 18th, will give you an idea of a memorable storm. The Friday preceding was very stormy. On Saturday we had bright sun. Snow fell about 4 P.M., and covered the ground. Later in the evening the ground and shrubs were covered thickly. Sunday was very stormy, hail, rain, and snow fell frequently during the day; at noon heavy thunder, with vivid flashes of lightning prevailed. During the evening snow again fell very heavily, and continued during the whole night and until about 6 A.M. on Monday morning (Whit Monday). Trees, shrubs, and fruit trees, the latter in full bloom, were laid flat upon the ground with their burden of snow, tall trees in leaf had branches broken off, Hyacinths and Tulips were broken down, but Violas were none the worse for the covering. Damsons that were in full bloom are casting off their blossom. We have a row of fine clumps of *Pæonies* 140 yards long, with from fifty to seventy buds upon each clump, which suffered the worst with the weight of snow.—J. GREGORY, *Haselbeck Hall, Northampton*.

I SEND a few branches of Spruce and Larch Fir, Ash and Beech, to show the damage done by the frost of Sunday, May 17th. In the valleys the Larch, from 1 foot high to 8 feet, have the appearance of early autumn, when the trees are changing colour previous to shedding their leaves or needles. Where the situation is more elevated no injury has been done. The Ash shoots are the tops of young trees planted two years since, many of them being virtually dead at the point. The Beech branches are from the undergrowth in the woods, trees of this escaping uninjured.—E. MOLYNEUX.

[The examples sent show the damage to have been very great. The Larch has especially suffered.]

SEVERE frosts on three successive mornings have put a very different complexion upon our fruit prospects, though it is by no means certain that so much damage has been done as at first imagined. On the morning of May 17th there were about 5° of frost, but on the following Tuesday morning the thermometer registered 8°, and this was when most damage was done throughout this district. Many of the Apples were in full bloom, but I am inclined to think were more injured by hail than by frosts, and apparently there are plenty of flowers uninjured.

Pears had set good crops both in the case of wall trees and those in the open, and I had already commenced thinning out. As far as the wall trees are concerned not much harm has been done; but the fruit on those in the open are much injured. It is too early to judge of the effects of frosts on the Plum trees, and I am still in uncertainty regarding Morello Cherries, the latter being only just set, and still presenting a somewhat gay appearance. Gooseberries are badly hit, very much of the fruit being destroyed. Red Currants appear all right, but Black Currants do not. Strawberries are the worst damaged, not a flower or well advanced bud escaping. We have saved a good crop on the protected plants of Noble, and may yet have enough on the latest varieties.—W. I., *Somerset*.

We have had some stormy weather here lately. On Monday morning, the 18th inst., we registered 6° of frost. All the Potatoes were cut down, and Strawberries that were in bloom were completely spoiled.

DURING the past week we have not had much improvement in the weather. True, we have not had the showers of sleet, but the wind keeps very cold, and there is a great deal of uncertainty as to the damage done with the severe weather of the previous week. I can hear accounts of Potatoes being cut down to the ground. Night temperatures, May 20th, 31°; 21st, 37°; 22nd, 37°; 23rd, 30°; 24th, 40°.—R. P. R., *Liverpool*.

I HAVE to-day made a thorough inspection of several large fruit plantations in this centre of fruit culture, and I find that in spite of the recent severe weather the prospect of securing an abundant crop of many kinds of fruits is very promising. Cherry trees, as a rule, are thoroughly loaded with young fruits, which, a close inspection showed, have successfully passed the critical stage, which occurs just after the setting is completed, and the early kinds are beginning to swell in a free and promising manner; and if the season of 1831 is not noted for

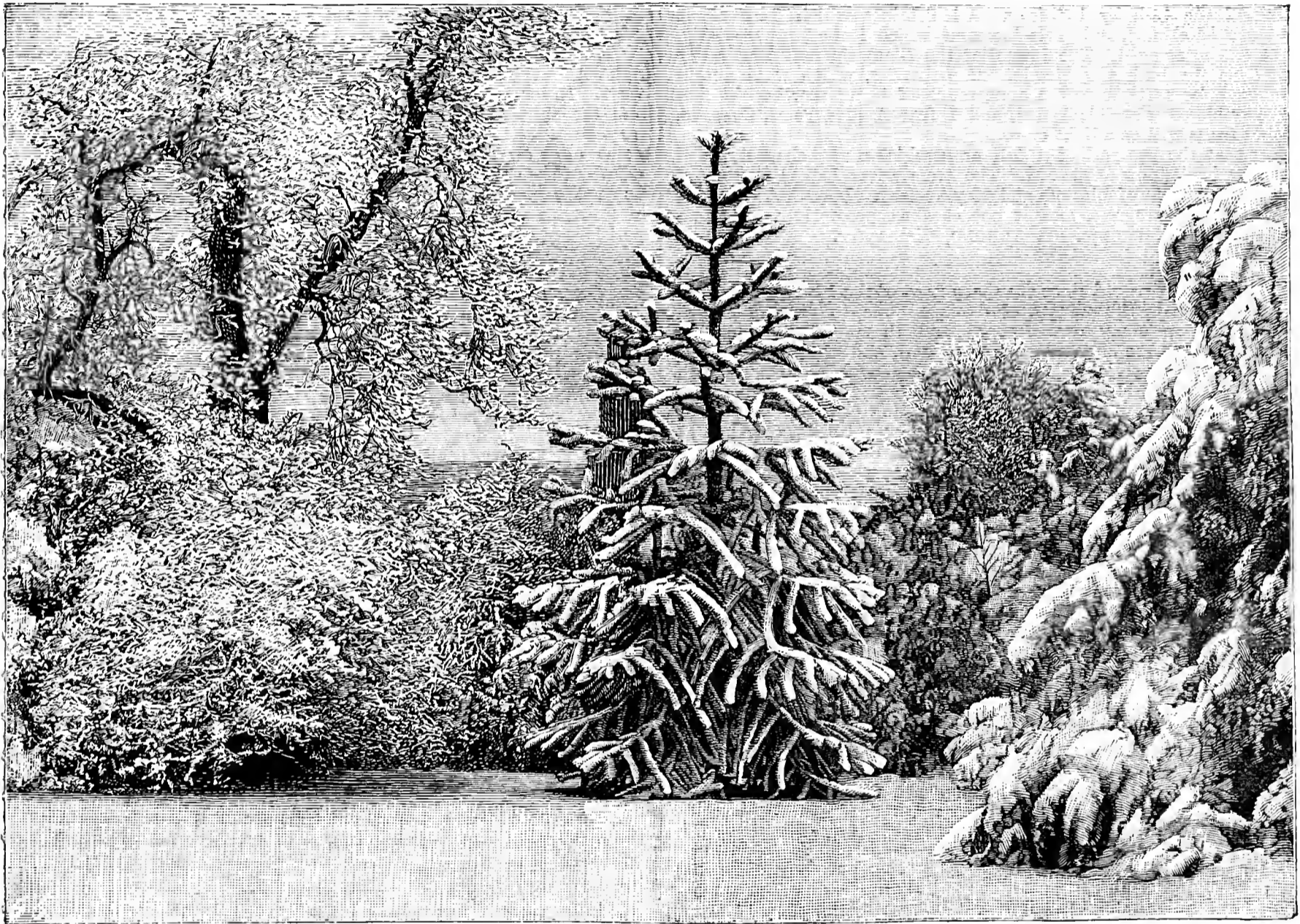

FIG. 79.—A GARDEN SCENE AT HASELBECH HALL IN MAY.

Besides these, our British Ferns, Lastreas, Osmundas, and Polypodiums were all cut down by the frost.—T. G., *Keswick, Cumberland*.

WE have had another week of cold, unseasonable, and ungenial weather. From the afternoon of the 15th till the evening of the 17th hail and snow showers fell frequently. The night temperatures of the 16th, 17th, 18th, 19th, 20th, 21st, and 22nd were respectively 27°, 27°, 27°, 28°, 28°, 28°, 28°. The day temperatures have been variable. The thermometer fluctuated between 40° and 45° on the first-mentioned three days, and the four last between 43° and 59°. A change appears to have come. The sky is overcast, the air is calmed, and is more genial.

The fruit blossoms where the leafage is good appear to be unharmed, and with the exception of early blossoms of Strawberries and some varieties of Gooseberries there appears to be nothing damaged as yet. But the protracted cold must have a bareful influence upon the embryo fruit. The only fruit that has suffered to appearance is on poor soil—one of the greatest arguments in favour of manuring heavily all fruit trees or bushes either with solid manure in the autumn or liquid manure in the winter.—W. T., *Lanarkshire*.

its abundance of this popular fruit the cause must be traced to unfavourable weather after this date, as I am convinced they have come through the ordeal successfully so far. The same remarks apply to Plums and Damsons, but Gooseberries and Black Currants are casting their fruits. It is yet too early to say what effect the weather will have upon the Apple blossom, but the general opinion is that not much damage is done. Many of the early Strawberry flowers were ruined.—H. DUNKIN, *Maieston*.

A FORTNIGHT ago the prospects of an abundant crop of fruit of all kinds was all that could be wished for; but since the 15th inst. the aspect of affairs has changed altogether. On the morning of the 18th the ground was white with snow, and on the following morning white with frost. Nearly everything has suffered; on low lying ground near to brooks the worst effects are seen. The Apples were in full bloom, but now they are looking very brown, and I am afraid very severely injured. On the higher ground the outlook is not nearly as bad. Damsons flowered profusely and set a good crop; these are considerably thinned, still, on the whole, I think there will be a fair crop. Plums, too, on low land are cut a good deal, on the higher ground they are very much better

and so are Cherries. Black Currants have suffered a good deal in some places and crops will be light. Still in more sheltered places there will be a good crop. Gooseberries are looking well and will be plentiful, but the caterpillars are attacking them very badly; we are hand-picking them, going over them about twice a week, and so keeping them in check. Red Currants, too, are looking well; Walnuts are black, all the points killed back. Potatoes are cut to the ground that were not protected with some kind of covering; the Oaks and Ash near to water are blackened. Still, if we get some warm weather from now onwards, I think the year 1891 will compare favourably with its predecessor.—J. WILLIAMS, *The Gardens, Whitbourne Hall*.

UNDER the above heading you gave in your last issue a long list of reports of the late unseasonable weather. I am very sorry to have to add one more to that list. On the 11th, 12th, and 13th of the present month we had midsummer weather, the temperature rising to 80° in the shade on two occasions. On the 14th the wind took a turn and settled in the east, and we had some cold storms of rain, hail, and snow for two days. On the morning of the 17th we registered 9° of frost, followed by more cold storms of snow and hail. This was followed on the morning of the 19th by 10° frost. All Potatoes which were above ground are blackened, and fruit blossoms, which looked so promising, must be much damaged. The flowers of the Black Currant are already falling from the bushes wholesale. Gooseberries, which were nearly large enough for tarts, have the appearance of being scorched by fire. Strawberry blossoms are blackened, and I fear Apples, Pears, Cherries, and other fruits will be a light crop.

I fear that the prospect of a full crop, which a very short time ago was so cheering, is now at an end. The trees never looked more promising, being a sheet of blossom and very healthy. I see the caterpillar is making rapid progress, and if not checked promptly will do an immense amount of damage.—T. ARNOLD, *Cirencester*.

A WEEK having passed since the sharp frost of the 16th and 17th, we are able to estimate the amount of damage done to our fruit crops thereby. As regards my own orchard and those of my immediate neighbours, which are situated on low ground, and as a general rule suffer more from frosts than those on higher levels, I believe such damage is very slight. Neither Cherries nor Plums seem to be seriously damaged, and both appear to be setting heavy crops. Pears also look satisfactory, the blossom on which was fully expanded at the time of the frost. Only a small portion of the Apple blossom was then open, and I do not think it has suffered much injury. Contrary to general rules, trees on the higher grounds appear to have suffered much more severely than ours. I yesterday was told by several having fruit grounds so situated near to here that their Plum crop is ruined. I also find that the amount of frost they registered was several degrees higher than was the case here. I attribute the fact that the higher grounds suffered most to be owing to the snowstorm immediately preceding the frost, which had made all wet alike, and the cutting easterly wind, which struck with more force on such grounds.

The caterpillars appear remarkably inactive at present as compared with previous seasons, and are scarcely larger in size now than were specimens examined three weeks since. The trees are already getting well covered with healthy-looking foliage, much of which is entirely uninjured by the maggots. We have had heavy rains during the past week, which have penetrated to a considerable depth, and will do incalculable good to the trees. Yesterday was warm and genial, with the wind S.S.E. On Monday it has again veered round to N.E., and the weather was correspondingly cold and gloomy.—W. K. W., *Leicester*.

THE past week has been an improvement on the preceding. The first few days were dry, bright, and cold, but latterly a good few heavy rain-showers have fallen, and the air has been somewhat softer, although north-easterly winds still continue. The temperature during the night has been low, and hoar frost has occurred on several mornings. More rain is much needed.—B. D., *S. Perthshire*.

THE AURICULA.

[A paper read by Mr. G. W. GILL, at the meeting of the Wakefield Paxton Society, May 2nd.]

(Continued from page 412.)

ONE of the first properties in Auriculas is the shaded petal. In the Alpine the base of the marginal or ground colour must be dark with a paler edge, the dark hue shading off into the pale tint, and the more richly shaded a flower is the more is it appreciated. Another important property in the Alpine is that whether the centre be yellow, cream, or even white it must be free from any trace of the much-prized meal which is found in the true self Auricula. The yellow centre is not indispensable to the true Alpine as now grown, for there are some fine shaded flowers having white centres, but the yellow centred varieties are considered by far the most valuable by growers of the Alpine Auricula. Pale yellow centres are admissible, but the nearer they approach to white the less their value. So much were the yellow-centred Alpines esteemed above those with white centres that within the last six or seven years it has been found necessary to create a special class for the last named at the Exhibition of the National Auricula Society.

The edge of the Auricula is very different from the edge of a Sweet

William. Indeed, the whole beauty of the Auricula is original, curious, and striking. It is not due alone to the colouring of the petals, but the presence of the smooth and snow white meal laid on certain parts of the flower (as well as on the plant in some cases) adds greatly to the beauty of both plant and flower.

The stem of the Auricula ought to carry its own head well above the foliage of the plant without the aid of "crutches." The stalk of each pip must be set so as to allow each one of them to stand in regular order and stiff upon the truss. If the pips be crowded too closely together small pieces of cotton wool should be carefully placed between the pips to keep them at their respective distances from each other. The pip itself should be strong, exactly round, and flat, but as a rule the selfs are generally of a much thinner substance than the other classes.

In the centre of the pip is a "tube" varying in colour from gold to greenish yellow, and set round with yellow anthers. The number of anthers required in the Auricula is five—that is, one anther for each petal, so that there should always be five petals as well; but when a pip contains, as it sometimes does, more than five petals, there is generally an attendant anther. The tube is thus the central feature of the flower, and if it should be in any way faulty it spoils the whole flower. The tube should thus be round, of good strong substance, of a rich yellow colour, and should rise to the level of the pip when flatly expanded.

The positions of the pistil (or seed pod) and of the anthers as they rest within the tube are of very great importance, as they vary in many ways. In some cases the pistil is in or beyond the mouth of the tube, and the anthers are at the bottom; or in another flower the anthers may be at the mouth and the pistil among them; but in a florist's point of view the anthers, which should be bold, are round the mouth of the tube, and the pistil is at the bottom, and their being in any other position will disqualify the whole flower. Take a handful of Cowslips or Primroses and you will find that, like the Auricula, the positions of pistil and anthers within the tubes are various.

Next in order upon the pip comes a ring of white meal, which is termed the paste. This should be smooth, thick, circular, white, and free from all blotches. After the paste comes the circle known amongst Auricula growers as the ground colour. This should be very dense and bright, free from any dots of meal, and with a good style of marking—that is, feathering off in flashes towards the circumference of the flower. Sometimes a yellowish tinge of colour creeps in between the ground colour and the paste, or the ground colour itself may very often lose its density and pale off into a weaker colour nearer the paste, and wherever either of these freaks may be present it forms an unsightly fault, and however pretty some people may think a shaded petal looks in the most common of bedding Alpines generally grown about Wakefield, it is not in the florist's Auricula, a beauty so deep and pure as the one rich colour.

Beyond the ground, and making up the outline of the flower, comes the much-prized edge. For a green-edge it should be a bright solid green, free from all meal; for a grey-edge the green is frosted over with a slight sprinkling of the meal; and for a white-edge it should be as thoroughly whitened over as the paste itself; so, as I before remarked, the classification is determined by the absence or the quantity of meal upon the edge of the flower.

The space which the tube and other circles occupy in the flower should be well and evenly balanced; they vary very much in this respect according to the florist's standard. I take the pistil, or seed pod, as the centre of all the flower, and the distance from pistil to paste, the paste to the ground colour, from ground to edge, and from edge to the circumference, should each be equally proportioned in width. A good broad paste and fine tube have a most telling effect, but on no account should one circle encroach upon another; if this occurs it mars the evenness of the whole flower, and causes it to look either cramped in one circle, or very one-sided.

CULTIVATION.

Having given a short sketch of the nationality, described the different classes of which the Auricula is composed, and given what I consider the standard of perfection attainable by that plant, and also defined certain drawbacks which are observable in any collection, I will commence with the mode of cultivation and aspect customary with old Auricula growers and exhibitors.

The growth of the Auricula through February, March, and April is very fast, considering that they are in no way forced. As the flowers die break the stem off just below the truss (that is if it is not required to seed). It will then ripen, dry as a bit of straw, but if it be broken short it may decay, and so kill the plant. The plants will still continue to grow fast, and will make the largest foliage they will ever have. That is the time for removing them to their summer quarters, the Auricula delights in being kept crisp and dewy through the summer. Nothing will answer the purpose for the habitation of the plants during summer months better than a clean well-ventilated frame in the shade of a north aspect. The Auricula must not be kept too wet, and here it will require less frequent waterings. Let the plants have the warm gentle rain, though there is a great safety in keeping dry overhead a plant with a water-logged heart; let them have all the air possible, but of course protect against strong winds, which would sadly wreck the foliage and check the plants materially. If any are wanted for seed either leave them in their quarters or place them in the frame with the north aspect with the others; the only difference will be the pods will ripen a little later, and the plants will not be so much distressed with the sunshine as in the house.

There is a great divergence of opinion as to the proper time for

potting the Auricula, some preferring the first or second week in May, but I recommend, without the least hesitation, that it be done in August, for the simple reason that I think with early potting the plants are apt to become too excited and grow too long before they rest for the winter; and at flowering time they look so ugly, with a long stem standing with only the least bit of foliage stuck on the top. I have plants now that have been potted in May and plants that have been potted in August, so I can speak on this subject now from practical experience.

There are three very important points in potting Auriculas. Of course the principal one is the compost, which should be natural, simple, and sweet. Florists do not now treat the Auricula with such terrible composts as in former days; goose-dung, blood, sugar-baker's scum, and other unnatural stimulants are no longer used. Each cultivator differs a little from his brethren in the quantity of different ingredients used. Many kinds of composts, if natural, cool, and sweet, will grow the Auricula well. The ingredients which I should suggest, as I have found them the best, are equal parts of good fibry loam from an old pasture, cow manure two or three years old, or manure from old hotbeds of the previous year, and the third material good pure old leaf mould. Of course you need not have the proportions minutely exact. If the soil looks heavy and sad I should add bits of charcoal about the size of peas, and a small allowance of sand, to keep it open, and you will soon be able to tell by the look of the foliage whether or not the plant is satisfied with its soil, and if so it will send out long white roots into the middle of the ball as well as to the sides of the pot.

The second important operation in potting is that of preparing the plant, if an old one. After having turned it out of the pot in which it may have previously been growing, take away as much of the soil as will shake from the roots; take hold of the plant in your left hand, by the stem, or neck, as it is called, and just at the base of the foliage; be sure not to take hold lower or you may break some of the many young roots which will be pushing from nearly every joint on the old stem, or "carrot," as it is sometimes called. Having the plant in this position, and being previously supplied with a sharp knife, clear away the old roots and try to detect the least unsoundness in the old stem, cut all decayed portions back until you get to a perfectly sound stem, as it is of no use leaving a partially decayed "carrot" and a bunch of old inactive roots. Have a healthy stem at all risks, even if you have to carve out holes to get out a cankered piece, or if you have even to cut right up to the neck of the plant for it. This operation may appear very artificial to a great number of people, but nevertheless it has its foundation in the natural habits of the plant, as from minute observation you will find that the Auricula periodically parts with a portion of its underground stem by a process of natural decay, which, however beneficial it may be in its wild state, would be very injurious to a plant of pot culture. After having followed out my suggestions with regard to the cutting, or tapping, I find it advisable to rub the wound with charcoal dust.

We now have the compost and the plant all ready for potting, so that the next important detail is the pots to be used and the method of putting the plants into them. The pots should be all clean washed and proportionate to the size of the plants to be placed in them. Some growers recommend potting in what I think are too small pots. I should suggest a 5 or 6-inch pot for an average sized plant, putting plenty of clean crocks at the bottom for drainage, then on the top of that a bit of cocoa fibre, or a little of the roughest compost to keep the finer soil from being washed down amongst the crocks. Fill the pot to the proper height with the compost, which should not be too wet and sad as to stick clammily together, nor yet so dry as to refuse water, but just moist. Next spread the roots out evenly and carefully on the soil, and fill up to the collar of the plant, pressing the soil moderately firm.

When potted place the plants in frames or houses for a week or a fortnight until they get well established in the fresh soil. Do not water them for a day or two, so that any of the roots that might have got broken or cut may have plenty of time to heal up. When the plants have begun to feel themselves at home give them plenty of air; if in frames the lights should be taken off during the daytime, except during heavy rains or winds. Keep a good look out for green fly, and remove all decayed foliage. I should advise following the above treatment all through the winter, only protect the house or frame at night with mats, or anything to keep off the keen frosts.

PROPAGATION.

The Auricula is propagated by seeds and offsets; by the former to obtain new varieties, and the latter to increase existing kinds. Offsets are the young growths formed in the axils of the leaves, and suckers from the old roots. These, if allowed to remain, may throw out roots on their own stem; but sometimes it is found convenient to remove them before they can make the rootlets. If the offset has a heel it will soon form roots. Some growers say that offshoots will not develop unless rooted previous to their removal from the old plants. The Rev. F. D. Horner pricks his offsets round the sides of the pots in which the parent plant is growing, and nearly all his pots will be found fringed with offsets in this style. I used to take the offsets off and place them round the edges of pots, and cover with a bellglass. When they are sufficiently well rooted they should be potted singly into smaller pots, using a similar compost as recommended for the older plants.

To obtain seeds and raise new varieties the flowers should be artificially crossed, or fertilised as it is called. To do this take a small camel-hair brush and collect the pollen from the anthers and apply it to the

pistil of the one it is desired to take seed from. Care will have to be taken to prevent any bees from getting to the flowers, as they have a tendency to carry pollen from one flower to another on their wings as they collect the honey. It is also best when fertilising to keep the classes separate. For instance, green-edged varieties should be crossed with green edge, grey and white edges with their respective classes, and selfs to be crossed with selfs.

By the end of July or the beginning of August the seed will be ripe, and may be sown at once in pots or pans, using the same compost as the general stock are grown in, only it should be rubbed very fine. Fill the pots to within an inch of the top, and press the surface firm and level. Scatter the seeds evenly over the surface, but do not cover with additional soil; place a piece of glass over the top to prevent evaporation, and stand the pots in a saucer of water, which must be replenished when it is all taken up. The young seedlings delight in a moist atmosphere in their early stage of growth, but on no account should they be kept too wet or too dry. I have no doubt many failures I have heard of with Auricula seed is the result of either burying the seed or of allowing the surface soil to be alternately wet and dry. In about three or four weeks some of the seed will germinate, but a portion will perhaps remain dormant until the following spring, so the seed pans should not be too hastily cast aside.

When the young plants have made two or three pairs of leaves prick them out in other pots, and if they cannot receive daily attention it will be best to cover them with a piece of glass, the same as recommended for the seed pots, and as they get established give air gradually by propping the glass up on one side. Seedlings should now have very close attention, top-dress the large ones like old plants, and let the soil come up to the base of the leaves; they will root very vigorously from that part, and sometimes even through the foliage itself. In all seedlings under blooming size the object should be to get them to root strongly, as they will never go along until this is attained. A pot of neglected Auricula seedlings will be found very unsatisfactory.

FRUIT PESTS.

WE gather from the *Evesham Standard* that the Fruit Pests Committee appointed some time ago in the district have recently paid a visit to Toddington, when a conference was held respecting various experiments and investigations undertaken by the members and others. Mr. W. Gibbon presided, and those present were Messrs. J. Masters, C. D. Wise, J. Swift, F. Hooper, T. E. Doeg, J. C. Hiam, Malleison, Chichester, De Launc, and Pritchard.

MR. BULLOCK'S EXPERIMENTS.

Mr. Masters reported upon the experiments carried out at Wickhamford by Mr. Bullock. He said he had little to report of his own fruit trees, as the general appearance of the whole of his plantation was very healthy, and apparently the caterpillar was not sufficiently numerous to affect the prospect of a large crop of fruit. But he had been much interested in watching and making observations on Mr. Bullock's plantation. This time last year it would be scarcely possible to find trees worse infested with the caterpillars. He gave instructions what to do, and found out very speedily the efficacy of Paris green, and in a very short time appeared to exterminate the caterpillar on his fruit trees and bush trees. He found out some time after the application that some of his trees upon which several experiments had been made with Paris green and other insecticides were scorched in the foliage considerably, and that this season in these trees the blossom was slight, but on the trees where there was but one application of Paris green after the flowering season the crop of fruit last year was good, and the bloom this year is excellent. Although Mr. Bullock has grease-banded his trees last autumn, very few moths were captured, and his trees were remarkably clean and free from caterpillar this season. He had sprayed his trees and bushes this year at the break of the bud from the wood with a mixture of 1 oz. of Paris green to 8 gallons of water. The machine used was the Eclair or Knapsack. He was so satisfied as to the efficacy of Paris green, that he hoped to discontinue grease-banding. At the same time that the trees were sprayed he washed the trunks of his trees with nicotine in the proportion of one part to thirty parts of water. Mr. Bullock stated that he had found the nicotine at that strength efficacious in destroying the aphides. Some experiments he had made on some greenhouse plants had proved most satisfactory. Some few Tomato plants he (Mr. Masters) had syringed last night with the nicotine, and that morning most of the aphides were dead. The fluid should be about milkwarm. He had further discovered a very simple contrivance by which the value of the Eclair sprayer had been much enhanced. It would be remembered by the Committee that the main objection to the Eclair was that its spray would not reach the large trees. The distance the jet would throw the fluid would be from 14 to 15 feet. He first enlarged the small hole through which the fluid passed to about twice its size. Afterwards he placed two threads across the mouth of the aperture. The effect of this simple contrivance was that it not only gave a fine misty spray, but getting to the windward it would emit the spray from 25 to 30 feet, sufficient to top the largest Plum trees.

Mr. Hooper was rather disappointed that Mr. Masters made no reference in his report to the strong liquid used last year on Mr. Bullock's trees. It was so strong that the Committee could not possibly approve of or recommend it.

Mr. Masters said he stated that some of the trees were scorched.

Mr. Doeg said the term nicotine was very vague. It should be further described.

GREASE-BANDING, ITS VALUE AND DISADVANTAGES.

Mr. Hooper said his plantation looked very healthy indeed, and as it would not require any spraying machines to be used. He kept part of his plantation ungreased as a test. He found that there were as few grubs upon that part not grease-banded—and in fact less—as there were upon other parts where grease-banding had been generally adopted. He looked forward to the time when spraying would be most efficient in protecting them from any insect blights. Other members of the Committee might have tried the results of not grease-banding some portion of their plantations.

Mr. Swift thought the fact of Mr. Hooper not having any caterpillars on the parts where he did not band might possibly be attributed to the extraordinarily hard winter. They saw very few butterflies about—he did not think he had seen twenty this season. If the hard weather had destroyed them possibly it destroyed the caterpillars which infested their trees.

Mr. Hooper said they should aim at something which would be a complete remedy. Grease-banding was only a partial remedy. It involved a great deal of labour, and he found that it was injurious. Trees which he had had grease-banded did not look well at all.

Mr. Swift thought his experience as to the injurious effects of grease-banding was simply on young trees. On the old trees it had no effect whatever, and if when the time had gone by they scraped the young trees it did not hurt them.

Mr. Hiam pointed out that the Committee had adopted the system of putting bands of paper on the trees to prevent injury to the bark. That also kept the matter adhesive, and prevented its absorption into the bark. He had some specimens which showed hundreds of the moths caught on those bands of paper.

The Chairman said he had grease-banded his trees for many years, and found no injurious effects, but they were old trees. If any injury was done he thought it was to young trees.

Mr. Hiam said the hard weather had had no effect whatever on the eggs. He had watched the eggs hatch out particularly on trees.

Mr. Masters was of opinion that it was not so much in the egg stage as when developing from the egg to caterpillar life that some kind of weather would be fatal to the caterpillar. 1886 was a very remarkable season. In the autumn of 1885 there was a large number of moths, but in the spring of 1886 there was a very extraordinary continuance of frost through March and the early part of April very similar in many respects to the season they had this year, and the result was a remarkable immunity from caterpillar. Consequently there was a good crop of fruit in 1886.

Mr. Doeg thought that would be owing to the very late frosts killing the young caterpillars as they hatched. They had pretty good proof that no amount of frost killed them when in the egg state.

AN INTERESTING DISCOVERY.

The Chairman said Mr. Wise had shown them some specimens of the gall growth upon the Black Currants, and he had been in correspondence with Miss Ormerod upon the subject. Early in the spring he found that the gall buds were full of the mite called the Phytopti, and with them he also found a white grub about an eighth of an inch long. He forwarded a specimen to Miss Ormerod, and this seemed to be a great discovery. Miss Ormerod replied to his letter in a letter dated April 21st. She said she was glad to have the opportunity of examining the co-tenant of the swelled Black Currant buds which Mr. Gibbon's nicely arranged specimens afforded her. She had carefully examined it after soaking it for a little while in glycerine and water, so as to render it transparent, and could say now with certainty that it was the maggot of a two-winged fly, or to write more technically the larva of some species of Diptera, and she thought it likely that this observation might prove very interesting. It was totally impossible to give the specific name of a fly maggot unobserved before, but Mr. Gibbon's observations and some other points made her think that it was very likely carnivorous, and that it fed on the little gall mites or Phytopti. Mr. Gibbon mentioned that he sent the grub (with the Phytopti all about it) carefully encased within two pieces of glass, and thus it reached her safely. She examined it with a 2-inch and 1-inch object glass before opening the packet (that was the two slides which Mr. Gibbon had so carefully secured that she had a little difficulty in cutting them apart), but she saw no Phytopti. Then after soaking the fly maggot in glycerine and water, without removing it from the glass, she examined it again with a 1-inch power glass, and still found no Phytopti, but was very much struck with the condition of the fly maggot, which was quite swelled out with food, not with juice but with solid matter, which she removed on to the slide. She conjectured that the maggot was of a carnivorous kind, and had eaten the Phytopti, its fellow passengers, as food on the journey. If so they had a friend in the co-tenant of the buds. She could not as yet say that it was so, but she thought all the circumstances pointed to this being likely, and scientifically there was no reason against it, but quite the reverse. It would be an interesting point for Mr. Gibbon to follow up, and if they could rear the fly they could get it identified and add a useful practical observation. In reply to a letter from Mr. Gibbon Miss Ormerod wrote on April 25th again expressing the opinion that there was strong reason for supposing where the Phytopti were gone. That was extremely satisfactory, as she

thought they might hope they had a parasite which would help to keep the Phytopti in check. If Mr. Gibbon could manage to rear the fly she would try to get it trustworthily identified.

Mr. Wise said if the grub ate up the Phytopti they would breed them there if they had to set up a hatching establishment.

Mr. Hiam said as regarded his investigations he had been unable to find this particular maggot or grub anywhere except in Mr. Gibbon's trees.

The Chairman said he was very thankful he had got it.

Mr. Doeg thought Miss Ormerod was very likely correct. A large number of Diptera were carnivorous. He had sent some of the galls to Mr. Enoch, who was the greatest authority on Diptera, and he would breed them.

The Chairman said he had all the galls picked off the Currant trees, and hundreds of Phytopti were found inside. In reply to Mr. Wise he said he did not syringe after the buds were broken off.

Mr. Wise said they had all the buds picked, and in some cases they went over them twice. They had not taken any notice of them for some time, but this year they increased so much that they were obliged to do so.

THE RED SPIDER.

Mr. Swift referred to the Stott machine, which he said sent a spray to the top of the tallest Plum trees. With respect to Paris green and the red spider Mr. Pritchard dressed the Gooseberry bushes with Paris green at 1 lb. in ninety gallons, just before the buds came out, and it entirely destroyed the red spider, and the bushes were now looking remarkably well. Since then he had dressed others when the leaf was out and it did not kill the red spider nearly so well as before, and a lot of leaves drooped, though the solution was then only 1 lb. to 120 gallons. It was evident to him that the red spider could be destroyed if the bushes were dressed at the proper time.

The Chairman said he had been spraying his Gooseberry bushes. He observed the saw fly on the Gooseberry bushes, and they sprayed them with Paris green, and they could not see any left now. They used 1 oz. of Paris green paste to 12 gallons of water. His trees were looking beautifully healthy. He believed those insecticides were sure death to the saw fly.

Mr. Hooper said he had not seen or heard of any spraying going on round his district, and the trees looked remarkably well, and gave a very fine promise.

The Chairman said he had been spraying eight rows of trees with Paris green, eight rows with London purple, and he left eight rows untouched, as a test.

Mr. Hiam said at the last meeting he was not sure as to the eggs of the Plum aphid. They had hatched since, and they were the proper Plum aphid. They were eggs laid in the autumn, which he watched through the winter, and they hatched out in the spring.

PESTS AT TODDINGTON.

Mr. Wise reported as to the plantation at Toddington. The comparison of this year with last year was very favourable. They could find hardly any trace of the green fly and very few caterpillars, except in the nursery on the young trees which were not grease-banded, but nearly all of which were well dressed with Paris green. On the plantation trees they could find very little trace of the caterpillar. Some trees dressed with the strong mixtures used by Mr. Bullock were killed. He referred to the grub which had appeared among the Red Currant bushes, and which was stated in last week's *Evesham Standard* to be the larva of the *Incurvaria capitella*. He said the shoots of the trees were withered up; the leaves withered and drooped, and if picked off they found the small grub inside the shoots. Both Miss Ormerod and Mr. Doeg were of opinion that it was the caterpillar of the *Incurvaria capitella*. It was a question whether they could do anything to catch the moth which hatched at the end of May. They had also found what they believed to be a weevil, but which, however, was contrary to the belief of Miss Ormerod and Mr. Doeg. Amongst the Raspberries they had the red maggot, which he reported upon last year, and it was doing a good deal of damage. They picked them off last year, but they were decidedly more numerous this year, and he should say it would affect their crop.

Mr. T. E. Doeg said he had no doubt about the grub in the Currant bushes being the larva of the *Incurvaria capitella*. It appeared to be a day-flying moth, and in all probability it was double-brooded, and they would have another brood towards the autumn, feeding in the stems. He thought they were adopting the most effectual plan in plucking off the shoots.

Mr. Wise said on their Black Currants they had found the same pest that Mr. Gibbon had given a description of, and they were following his example and picking off the buds. They found very little of the luper caterpillar, and that he attributed to the use of Paris green last year. They got the Paris green on the trees by the French pump in the most approved way, and they certainly found very few. They would, however, most decidedly grease-band their trees again in the autumn. They would not wash again, as it was not necessary this year. He referred to a visit to some plantations in Herefordshire, where he was told by no means to give up grease-banding. He had a recipe given him for syringing Pears and Plums. It must be used before growth commenced, or it would scorch the foliage. It was half a pound of caustic soda, half a pound of erude commercial potash, and five gallons of hot water. For Apricots and Peaches eight gallons of water should be used. He was told that that would kill the green fly or anything living.

Mr. Hiam said he had been advocating killing bullfinches for some years, and he produced some small Plum branches from which the blossom had been picked by these mischievous birds. It was stated that the sparrow also did harm in this way.

Mr. Swift invited the Committee to meet him at his plantation at Charlton, and it was arranged that the next meeting should be held there on June 3rd.

EXHIBITION CELERY.

Good and useful specimens of early Celery are often grown in trenches, and also blanched in the ordinary manner, that is to say by moulding up; but to have it extra good, or equal to winning the first prize in good company, a very different method of culture should be adopted. In order to have fully grown well blanched Celery early in August, plants of Wright's Giant White, or some other approved variety, ought now to be ready for their final quarters. To keep them longer in a root-bound state singly in 6-inch or larger pots, or in boxes or frames, where to leave them any longer would greatly weaken them, would be a great mistake. In most instances from twenty to forty plants would be ample for the summer shows, and these should be grown on raised well-prepared beds rather than in colder trenches. At one end of a sunny open plot of ground mark out a space sufficient to hold the number of plants prepared disposed 15 inches apart each way. Next drive in stout stakes and enclose with wide stout boards. Throw out the best of the surface soil, and after mixing with it liberal quantities of the best loam available, good decomposed manure and charred garden rubbish in about equal quantities, return on to the inside of the boards. The Celery plants being carefully and firmly planted in this, lightly sheltered from either cold winds, frosts, and fierce sunshine, being also kept moist at the roots, will soon commence active growth, and continue to grow far more rapidly and strongly than they usually do in trenches. Liberal supplies of liquid manure, and carefully and heavily bandaging up the stems with brown paper, instead of blanching with the aid of soil, will do the rest, the Celery being both of great size and extra clean by the time wanted.—I.

CARPET BEDS.

We have just two other designs prepared by Mr. Graham, and methods which he suggests for planting them effectively, though they might be planted in half a dozen different ways, according to the provision of plants and individual preferences.

The round bed (fig. 80) may be furnished as follows:—1, Raised and planted with *Sempervivum montanum* and a succulent of any kind as a centre plant, or it may be all planted with succulents; 2, groundwork *Herniaria glabra*, *Mentha*, or *Veronica incana*; 3, *Alternanthera* of any kind; 4, *Alternanthera* of a different kind to the above or *Leucophyton Browni*; 5, the bed raised about 4 inches above the grass, and edge

mentioning that I fully expected from what I had seen and heard from him we might expect some good results from the pans of seedlings which I then saw, and which were the result of most careful hybridising. I was not far wrong; he raised, but alas! did not live to distribute

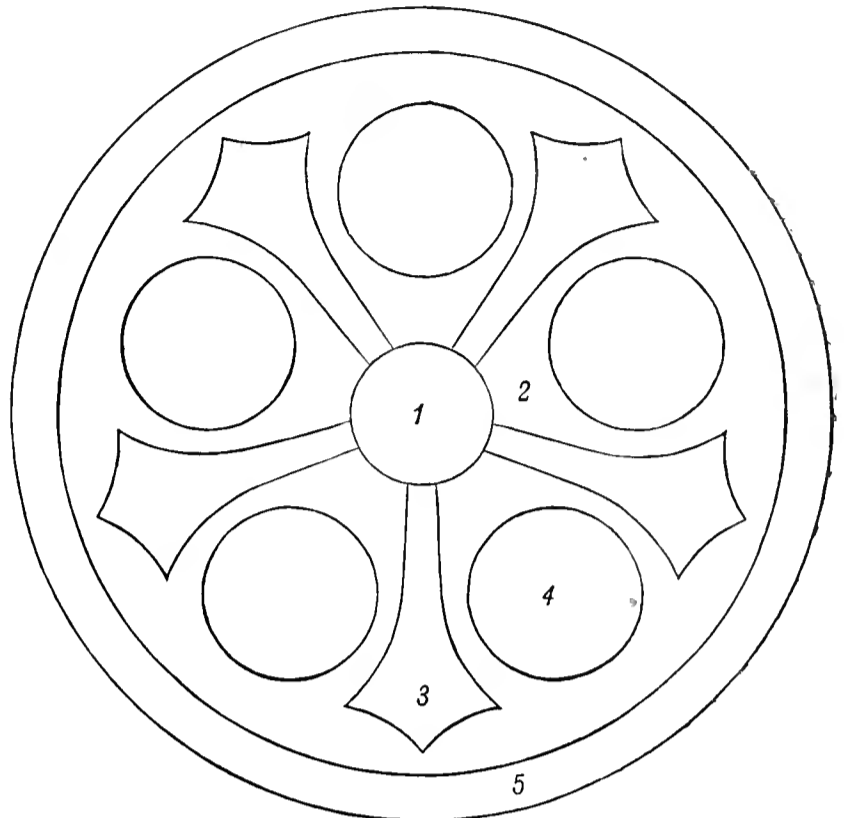
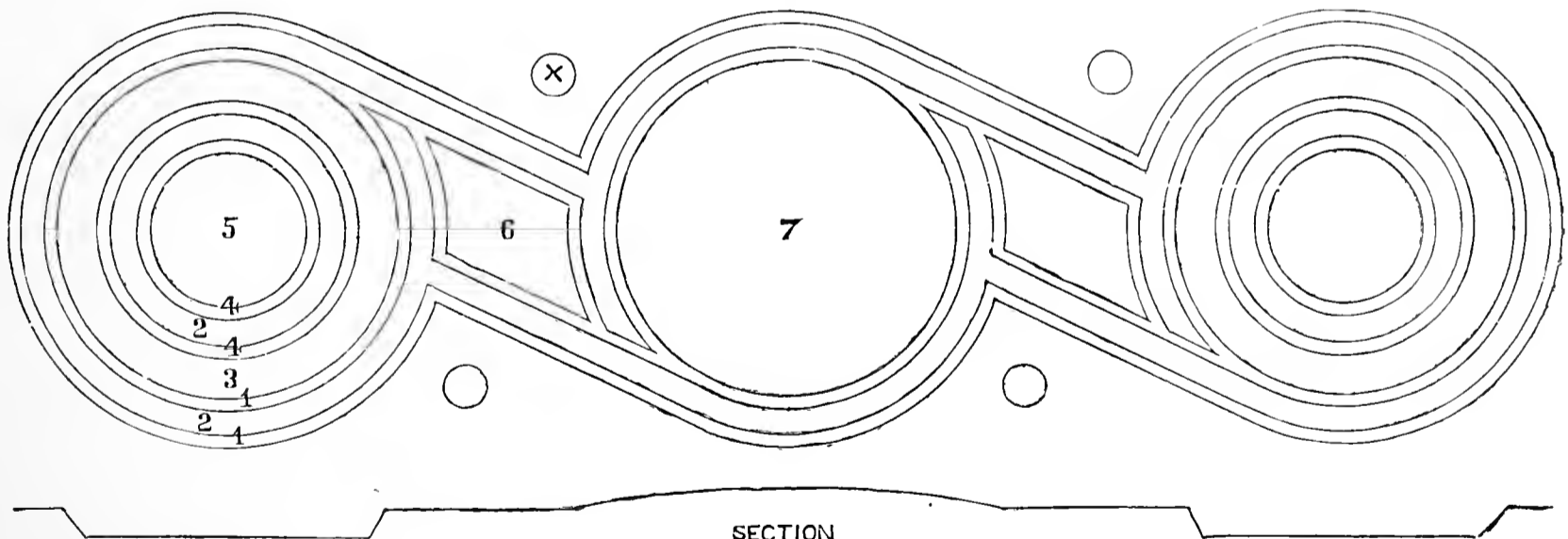

FIG 80.

For References see Text.

four varieties—Black Bess, Mrs. Dodwell, George Rudd and Rachel. He has passed away. His excellent sister continues not far from their old home to grow the collection he formed, and it is a great pleasure to her to see the position these seedlings have taken, and to all who knew him to find that his anticipations were correct, and to make all Auricula lovers mourn his early death.

The Committee of the National Auricula and Primula Society decided last year to invite some of the best Auricula growers to give their opinion as to the best varieties of each class. As this list was



SECTION

FIG. 81.

REFERENCES FOR PLANTING.—1, *Cerastium tomentosum*; 2, *Alternanthera amoena*; 3, *Echeveria secunda glauca* and *Sedum glaucum*, mixed; 4, *Pyrethrum laciniatum*; 5, *Alternanthera magnifica*; 6, *Mentha Pulegium gibraltarica* dotted over with *Echeverias* or small *Aloes*; 7, Silver-leaved *Pelargoniums* and blue *Lobelia*, mixed; x, Succulents.

planted with two rows of *Echeveria secunda glauca*, and some *Sedum glaucum* interspersed.

The design (fig. 81) is suitable for a bank or level ground, and the circular ends can be represented in sunken panels by those who may desire it as indicated.

MR. WOODHEAD'S (THE LATE) AURICULAS.

SEVERAL years ago I paid a visit to Shibden Head, near Halifax, where on the top of what we in Kent should probably call a mountain, but in Yorkshire is only a hill, I saw one of the choicest and best cultivated collections of Auriculas I had ever seen cultivated by the late Mr. Thomas Woodhead. I recorded my impressions of it, and remember

for the guidance of purchasers, it was a mistake, I think, to include in it flowers which are not yet in commerce. I find that there were sixteen voters, but the highest number of votes recorded for any one variety was fourteen, and as I think that variety (*George Lightbody*), would be, I imagine, in everybody's list, I cannot quite understand it. Now in these lists I found amongst grey edges *George Rudd* taking fifth place, and *Rachel* the seventh. When one considers that this is the most numerous class of all amongst Auriculas, and that the flowers that are before them are *Lightbody*, *Lancashire Hero*, *Mabel*, and *Silvia*, it is a strong testimony to their excellence. In white edged, *Mrs. Dodwell*, which I regard as the best of the four, comes fifth; but, in fact, may be said to be third, as it obtains an equal number of votes with *Smiling Beauty* and *John Simonite*, while *Black Bess*

amongst selfs comes third, after Heroine and Mrs. Potts, both new flowers, and beating all the older flowers, such as Pizarro, Lord of Lorne, Blackbird, C. J. Perry, Mrs. Douglas, &c., and having only three votes less than Heroine, and two less than Mrs. Potts, both of these being considered the very *crème de la crème* of selfs.

There is another test which, perhaps, many would consider a fairer measure of strength than even this consensus of opinion, and that is—how they stand on the exhibition table? what place do they hold, if any, in the winning stands? Taking, then, the Southern Exhibition, held on April 21st, I found the following record in the first prize stands:—In Mr. Henwood's twelve Mrs. Dodwell, Black Bess, and George Rudd; in his six plants Mrs. Dodwell and George Rudd were again shown in the class for fours. Mr. Wheelwright had in his first prize stand Mrs. Dodwell and George Rudd; in the class for two Mr. Wheelwright again won, and one of the two was George Rudd. As to the single classes I do not think much is to be gained from them; for if these were all good F. D. Horners they would win in greens, Lightbodies in greys, and Heroine or Mrs. Potts in selfs. In whites, I believe good plants of Acme would sweep the board, unless such plants as Mr. Henwood's John Simonite, a delicate grower, and therefore rarely seen, were to be staged. I cannot but think this is a very remarkable record for new varieties.

In the Northern Exhibition we have to deal with the champion grower and raiser, the Rev. F. D. Horner, and it may suffice to show how successful he is when we find that all his exhibits in the highest classes were his own seedlings, and with the exception all, I believe, only in his hands; but Miss Woodhead took the second place, and in her lot were two of her brother's seedlings—Rachel and Mrs. Dodwell, while in the other classes George Rudd and Black Bess appear.

It may be worth while for those who do not know the flowers to give a brief description of them.

George Rudd has a clear grey edge, dark body colour, and a yellow tube; it is somewhat in the style of Traill's Beauty, when that very irregular flower can be caught right, but so far last better.

Mrs. Dodwell.—A fine white edged flower, with dark body colour, which does not run out into the edge, and a deep coloured tube. This I think to be the best of the four.

Black Bess.—A fine dark self with smooth petals, good tube, and solid paste. This is sometimes notched at the edges, but I believe with proper treatment this disappears, and it is a formidable rival to our best self.

Rachel.—A grey edged flower, somewhat in the style of George Rudd, with excellent tube and paste.

There are two things noticeable in all these seedlings of Mr. Woodhead's; the one is their excellent constitution and the freedom with which they give offsets. We know how trying it is to have a good variety, say Prince of Greens, and to watching it year after year to get some increase from it, and to be looking in vain, though a grower told me the other day that he had had a plant of Prince of Greens in perfect health for eight years, and had never got an offset from it. Another point about them in which some modern flowers are lacking is the yellow colour of the tube. How much this enhances the beauty of the flower can be easily seen by placing Prince of Greens and F. D. Horner side by side, the washy character of the tube of the former flower giving it a dead character, the yellow one of the latter brightening it up.

I am glad to be able to say that, good as these varieties are, it is quite on the cards that we may by-and-by be having something even better, for while I am writing this I have just (May 20th) received from Mr. McDonald, Miss Woodhead's able gardener, a pip of a white-edged seedling of great promise. It is to be named Miss Woodhead; the flower is large, well formed, and the edge a most decided white, reminding one of the edges of such old flowers as Taylor's Glory and Summerscale's Catherina, and not of that very undecided character between white and grey which marks so many of the flowers in this class—flowers which may sometimes be shown as greys. In thus drawing attention to these flowers, I feel I am doing service to those who do not know them, and I believe that the record of this year will be maintained.—D., Deal.



FRUIT FORCING.

PINES.—Plants of these under good management yield, as a rule, the finest fruits when they show them ten to twelve months from the time the suckers were first potted, but some allowance must be made for autumn suckers, which were then potted and have to make a part of their growth under adverse influences. Plants finally potted last September are showing fruit. If any of that age are not fruiting, subject them to comparative rest for four to six weeks, lowering the heat at the roots to 75°, and admitting air fully at 75° to 80°, and let the temperature fall to 75° before closing the house for the day. Little artificial heat will be required, but it must be afforded, if necessary, to prevent the temperature falling below 60° at night. Do not allow plants to become excessively dry, but whenever a plant needs it afford

water liberally. The smaller suckers of the plants referred to potted this spring must be kept growing until the pots are filled with roots, when, if it be necessary, they can be subjected to the same course of treatment as advised for the larger plants, and these will afford a successional supply of fruit.

Suckers Potted in March.—The strongest of these should now be in their largest pots. If they are not yet potted do not tolerate further delay, as to retain them longer in small pots is detrimental to their after growth. Let recently potted plants have a regular bottom heat of 85° to 90°, and be thoroughly supplied with water after potting, and give no more until the soil becomes dry, as it is necessary to exercise more care than usual at this stage, the state of the individual plants being ascertained before its application.

Routine.—Young stock are making rapid progress, and must be regularly attended to, allowing such plants sufficient space for development, as nothing is so inimical to sturdy plants as crowding them in the early stages of their growth. Ventilate early in the day at 75° to 80°, to render the foliage dry before it is affected by the sun. Discontinue shading successional plants, but for fruiting plants with the crowns in close proximity to the glass a slight shade from powerful sun will be beneficial.

PEACHES AND NECTARINES.—*Earliest-foreed Houses.*—The early varieties, such as Alexander and Early Beatrice, are nearly cleared of the fruit. The shoots on which the fruit has been borne, if not required for the extension of the trees, must be cut away to admit light freely to the foliage. Syringe forcibly to cleanse the foliage of red spider, and if this and scale continue troublesome the prompt application of an insecticide will be necessary to eradicate those pests. It is highly important that the foliage be kept healthy, and to prevent over-maturity or premature ripening it is necessary to keep the houses as cool as possible by ventilating to the fullest possible extent after the fruit is gathered. The borders, floors, &c., must be moist, and in showery weather remove the roof lights. Keep gross laterals stopped, but avoid checking the growth by removing a quantity of foliage at one time, as this has a tendency to hasten the ripening of the wood, and when this is the case the trees will be swelling their buds through over-development when they should be resting. Trees of Hale's Early, A Bec, Early Alfred, Early York, and Early Grosse Mignonne, with Royal George, Stirling Castle, and Crimson Galande in the same house, or in a house to themselves, which is much the best, will now be ripening their fruit, and must not be syringed, though if the trees become infested with red spider a thorough syringing may be given when there is a prospect of a fine day; but with the water hanging about the skin is liable to crack in fruits that are partly ripe, while those that are nearly ripe will be much deteriorated in quality; in fact, they are given a very unpleasant musty flavour. The trees must have sufficient water at the roots, but any excess at this stage has a tendency to cause splitting at the stone.

Houses Started Early in January.—The fruits are now advancing fast towards ripening. The leaves will have been turned aside and the fruit raised on laths placed across the wires of the trellis with its apex to the light. This insures the fruit colouring well and ripening evenly. If the weather prove cold and wet gentle fire heat will be necessary to secure a circulation of air constantly, the temperature being maintained at 60° to 65° artificially at night and 5° to 10° rise by day. Cease syringing so soon as the fruit begins to be soft, and take care to have the foliage free from red spider before the syringing ceases, or the pest will increase so rapidly as to serious prejudice future prospects. See that there is no deficiency of moisture in the borders, and if necessary give a thorough supply of water, mulching with some light material such as partially decayed stable litter or spent Mushroom bed manure.

Succession Houses.—During stoning the trees must not be hurried, but be given time to complete this exhausting process. Allow a free extension of the laterals as an encouragement of root action, but be careful not to crowd the principal foliage, and keep insect pests in check by syringing twice a day. When the fruits have stoned remove all surplus fruits, and turn the others to the light to insure their colouring well from the apex. Give thorough supplies of water through a good surface mulching of manure, and supply liberally any weakly trees with tepid liquid manure. Vigorous trees will not need more than a surface mulching, as high feeding will only cause grossness, and must be studiously avoided. Ventilate early and close early in the afternoon, with plenty of atmospheric moisture, so as to raise the heat up to 80° or 85°, and ventilate a little afterwards for the night, the temperature being allowed to fall to between 60° and 65°.

Late Houses.—Young shoots that are to carry next year's crop must be tied in, and allowed to extend as far as space admits, taking care to avoid overcrowding. Pinch all side shoots that are not wanted for next year's fruiting or for furnishing the trees, and stop any gross shoots, so as to cause an equal distribution of the sap. In thinning leave a few more than will be required for the crop. A Peach to every square foot of trellis covered by the trees is ample. Nectarines may be left a little closer. Keep the foliage clean by syringing twice a day in fine weather, and always sufficiently early to allow the foliage to become dry before night. Mulch the borders with manure, or if the trees are young and vigorous some lighter and less rich material will be better. Water thoroughly whenever necessary, always sufficient given at a time to reach the drainage. Ventilate early, and increase the ventilation with the sun heat, closing early if the ripening is to be accelerated, but if wanted late keep as cool as possible by free ventilation day and night.

Young Trees.—Those in course of formation for filling their allotted space must be properly disbudded, leaving the main branches or shoots

for forming them about 18 inches apart, and the bearing wood at 18 to 24 inches along them, training the extensions their full length, and pinching the side shoots on last year's wood to two or three leaves, so as to form spurs, and to one of subsequent growth. Laterals on the current wood should be pinched at the first joint, and successional growths as made.

CHERRY HOUSE.—When the whole of the crop is ripe the chief consideration will be to keep the fruit fresh and prolong the season as long as possible. Shading will do so, but it is only desirable when the fruit is exposed directly to the sun owing to the limited foliage. Free ventilation must be attended to, and in hot weather a sprinkling of the surface of the border in the hottest part of the day will assist in keeping the fruit plump. The supply of water must not be neglected, for dryness is inimical to the development of the buds for the ensuing crop of fruit and health of the trees.

CUCUMBERS.—Plants in houses that have been in bearing since the beginning of the year may be cleared out, and the house cleansed preparatory to replanting with young plants, or Melons for a late crop. If, however, the old plants are fairly healthy, and Cucumbers are still sufficiently supplied from pits and frames, they may be kept in fruiting a time longer by removing the surface soil with a small fork, and replacing with some lumpy loam, afterwards surfacing with decayed manure, giving a good soaking of tepid water, and afterwards following with liquid manure. Thin out the old growths, and encourage young in their place. Shade from powerful sun, syringe both ways in the morning and early afternoon, and damp well down before nightfall. Admit a little air at 75°, increasing with the advancing sun, keeping at 85° through the day with sun, and close early so as to run up to 90° or 95°. Fire heat need only be employed to prevent the night temperature falling below 60° to 65°, and to insure 70° to 75° by day.

Pits and Frames.—Plants in these should be ventilated from 7.30 to 8 A.M., and in the hottest part of the day a slight shade from fierce sun will be beneficial, and keeping through the day at 85° to 90°; close at 85°, increasing 5° to 10° with sun heat. Keep them watered as required, about twice a week will be necessary in bright weather, and damp overhead on fine afternoons. Avoid overcrowding the foliage, thinning well, keeping up a succession of bearing wood, removing bad leaves, stopping one or two joints beyond the show of fruit, and avoid overcropping. If straight fruits are wanted place them in glasses or pieces of half inch deal nailed together so as to form open-ended troughs about 3 inches wide, which must be slightly inclined so as not to hold water.

STRAWBERRIES IN POTS.—Early Strawberries, as a rule, have not been good. Last season did not favour the maturation of the crowns, the plants not perfecting as good a growth as was essential to the successful fruiting of the early forced batches. The successional Strawberries have been much better, but they are variable, and the later plants are affording the finest fruits. Copious supplies of water are necessary, especially in the early stages of swelling, for if the plants once lack that essential element the fruit may be so dried as not to swell freely afterwards, and a somewhat moist condition of the atmosphere is necessary to obtain well-swelled berries; therefore, avoid drying currents of air, especially when cold. Water the plants two or three times a day according to the weather, and have liquid manure two or three times a week until the fruit commences ripening, after which give water only sufficient to prevent the foliage flagging. This, with plenty of air, improves the flavour.

THE KITCHEN GARDEN.

RUNNER BEANS.—A short spell of extra hot weather hastened the germination of seed and caused the plants to grow rapidly, but all unprotected were cut down by frosts which occurred on or about May 18th. This, though a regrettable occurrence, is yet easily obviated. Supposing an early supply of Beans is needed more seed should at once be sown either singly in 3-inch pots, or thinly in boxes and placed in heat to germinate. The plants ought to be hardened off before becoming much root-bound, and be planted where the failures occurred. Naturally the least check is experienced by those turned out of pots, but these Beans are readily transplanted either from boxes or the open ground where thinning out is possible or desirable. More seed might also be sown in the open ground, and if it is soaked for twenty-four hours prior to sowing it will germinate more quickly. Market growers will be the greatest sufferers from the effects of frost, as in all probability it will be impossible to procure sufficient seed to make good the losses, and in any case the crops must be late. There will be therefore a better prospect for those who market surplus produce of getting good prices for their crops.

KIDNEY BEANS.—Much that has been advanced concerning runner Beans also applies to the dwarf Beans, these being cut down wholesale, and that too in spite of being located on raised borders. In order to keep up a good supply of this popular vegetable look well after the plants in pits and frames, and in many instances it is advisable to sow or plant yet another batch under glass. Given good room, well fed at the roots, and free of red spider, frame-grown plants are very productive, and in fact almost indispensable this season. A gentle rather than a strong heat best suits them at this time of the year. Raise a few score or hundreds of plants under glass for transplanting to warm borders, and if handlights can be afforded these will serve to give them a good start. Sow more seed in the centre of the ridges between Celery trenches, where the plants will thrive and crop surprisingly well even in the hottest summers.

CELERY.—Not only is it advisable to prepare the trenches well in advance of planting time, but other work ought not to prevent the young seedlings also being taken in hand before they become drawn up in the seed

beds or boxes. If frames cannot be spared for them lights might be, sides being temporarily formed with the aid of a few boards and stout stakes. Fix these or set frames on hard ground, and in the bottom place a layer of short manure trampled down to a depth of about 4 inches, on this placing a layer of light sifted soil 2 inches deep. Prick out the seedlings in straight lines 4 inches or rather more apart each way, give a gentle watering, keep rather close and shaded from bright sunshine till they commence growing strongly, and never let them become dry at the roots. When they touch each other is the time for transplanting to the trenches, and being on a hard bottom they will move off cleanly with good squares of manure and roots attached, flagging seldom taking place. Nothing is gained by treating even the latest raised plants similarly to ordinary Cabbage, the better plan being to give them a strong start under glass as just advised for the early and main crop batches. It is not the most stunted Celery that keeps the longest, and by ordinary good treatment, early sowing being avoided, it is possible to keep fully grown Celery till late in the spring. As a rule the varieties with coloured stalks are the most reliable for the main crop and late supplies, the white forms being most liable to run to seed prematurely, and as a rule are not nearly so solid and crisp as the red and pink sorts. The former may well be grown for affording early supplies as being the quickest to blanch; but the bulk of the stock of plants pricked out should be of the coloured forms.

A NEW FUNGICIDE AND DISTRIBUTOR.

MESSRS. BARR & SON, the agents for Messrs. Tait & Buchanan's preparation for destroying fungoid growths on plants of various kinds, send us the annexed illustration of their powder distributor. It is a very handy appliance for the purpose, and delivers a cloud of dust where

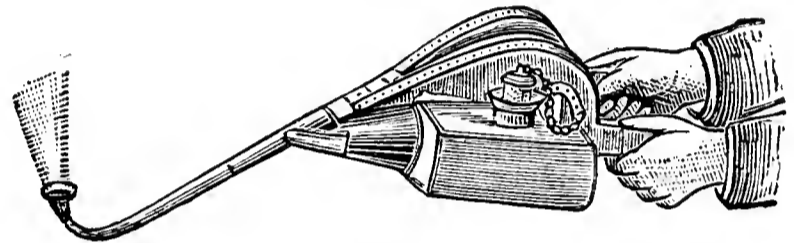

FIG. 82.

it is wanted. The preparation, which has been found to be of great service in vineyards in Portugal, is said to contain no sulphate of copper, but the copper is present as a hydrated oxide of copper intimately mixed with lime by a special method of manufacture, the copper oxide being equal to about 10 per cent. of sulphate of copper. This fungicide is referred to in the report of the Scientific Committee of the Royal Horticultural Society on page 413 last week, but the Committee did not recommend its being tried at Chiswick for the reasons there given. One of the objections appears to be based on the fact that the fungicide is a commercial product, as if seeds, plants, and other things tried there were not of a commercial nature and their commercial value thus determined. Many persons consider that Chiswick is just the place where new inventions and introductions intended to be of benefit in gardens ought to be tried for the guidance of the horticultural community, but the Scientific Committee do not appear to be of this opinion.



APIARIAN NOTES.

THE APIARY.

OWING to the extremely low temperature bees make no progress. The daily loss appears to be as great as the increase, and has been greater between the 15th and 22nd of the month than at any time during the whole year. But even with so great a loss the hives are so well forward in brood that with fine weather for but a few days the most of my hives would be ready to swarm or super. Young queens are the first consideration, and for that reason I shall encourage a per-centage of my stocks to swarm. Drones are now numerous, and in order to insure fertilisation will do my best to have no queens later hatched than in June.

I shall supply at first with little super room until the weather and flowers are more promising; but I hope that any half measures will be but very temporary, and that although clouds darken our hopes for a bountiful harvest and heavy yield of honey, brighter days are in store.

FOREIGN BEES—THE STANDARD HIVE.

The standard hive is too small for any foreign bee, as it was for the old black bee; but where is it, or who has it in Britain? I have sent crossed and pure bees to many parts of Britain and

the isles in the far north of Scotland, and as queens mate with drones at a distance of six miles bee flight I think there will be few bee-keepers isolated further than that from foreign blood. But the standard hive is not only too small to test the working powers of any bee; but the bees are further restricted from developing their works by the use of queen-excluder zinc and other absurd ideas of restriction, or I may say constriction, and yet they advocate strong hives, but often at the wrong season, but do not show the bee-keeper the common-sense system of bee-keeping.

I need not repeat the properties of the Punic race of bees. Your readers had the facts not long since, but I may add, notwithstanding the untoward weather, my Punic bees are now quite ready to swarm. Does that show them to be tender? Who ever saw or heard of a common black hive of bees raising 33 lbs. weight as I recorded two years ago?

In 1886 I had two crossed Syrian swarms join, and in less than a week it raised upwards of 100 lbs., which the late Mr. Alfred Neighbour saw, and at the end of the Heather season, and it was not a good one either, the gross weight of the hive, not including what it took to keep, it was 280 lbs., 40 lbs. being the tare of the hive, 240 nett. These are but two of many examples of what foreign bees did, yet these two hives refuted many of the ideas held by some of our bee-keepers of the modern school. In ten days after I hived the first mentioned two swarms I took 60 lbs. of super comb beautifully pure, and which was stored in the supers direct from the field, not as some teach "stored first in the body of the hive to ripen, then carried aloft," a belief by some, but simply impossible with the standard hive; then the short life of the bee was also disproved. All which I have explained before, but in the interests of bee-keepers and truth, I mention again.—
A LANARKSHIRE BEE KEEPER.

BEES AND THE DEATH'S HEAD HAWK MOTH.

It must now be taken as proved that this moth visits hives of deliberate purpose, and enters the combs when it can to suck up the honey. But I wish to point out that the discovery of a dead moth within a hive by no means proves that the bees killed it; the insect may have died there, owing to being unable to make its way out. Many of the old bee-keepers, as well as some naturalists, seem to have been under the impression that bees would not touch this moth, and several of them have given us descriptions of the blockade they sometimes formed at the floor of the hive to exclude their foe. A modern entomologist, indeed, has stated, from his examination of this insect's structure, that he hardly believes it possible the sting of a bee could enter the body, as the point would be turned by the down and the elastic membrane. One of the funny mistakes made in regard to the death's head is to be found in Staveley's "British Insects." The author remarks that the larva of this species enters hives in order to feast upon the comb.—ENTOMOLOGIST.



•• All correspondence should be directed either to "THE EDITOR" or to "THE PUBLISHER." Letters addressed to Dr. Hogg or members of the staff often remain unopened unavoidably. We request that no one will write privately to any of our correspondents, as doing so subjects them to unjustifiable trouble and expense.

Correspondents should not mix up on the same sheet questions relating to Gardening and those on Bee subjects, and should never send more than two or three questions at once. All articles intended for insertion should be written on one side of the paper only. We cannot reply to questions through the post, and we do not undertake to return rejected communications.

Answering Questions (H. II., I. U., C. J.).—We are sorry your questions arrived one post too late for being answered in the present issue.

Babylonian Gardens (C. II.).—The article to which you direct our attention was, no doubt, set up from our pages. The editor of our

contemporary in his search for good things naturally turns his attention to the *Journal of Horticulture*.

Cucumbers Bitter (A. J. L.).—Heavy dressings of soot are quite apt to cause bitterness in the fruit, especially during a period of dull weather when the assimilative functions of the leaves are somewhat impaired. The bitterness will pass off, and the fruit you have sent is not nearly so bitter as many we have tasted. Top-dressings judiciously applied of artificial manures that are advertised will stimulate the growth of the plants and not impair the quality of the fruit.

Sewage Sludge (F. S.).—As has been frequently stated, though you appear to have overlooked the notification, we do not undertake the analysis of manures or soils for ascertaining their constituents. Analyses can only be obtained from agricultural chemists, who supply them professionally at varying charges. Judging by a cursory examination of the sample, we should prefer good stable manure, but a trial of both would satisfy us without an analysis, the one best adapted for our soil and crops. It is easy to make soil too rich for Tomatoes, and that which grows good crops of Potatoes is rich enough for the edible-fruited Solanum.

Market Gardening in Pre-railway Times (C. G.).—We have no record of vegetables having been sent to the North of England from the London market gardens before railway times. On mentioning the subject to a member of a Fulham market gardening family, established 200 years, the reply was, "Never heard of such a thing, and if any such trade existed I think my grandfather would have mentioned it in talking about the history of the business as he was fond of doing." It was agreed that vegetables were most likely sent northwards by carriers, but the term "North" had then reference to places very much nearer London than those to which it now applies. Perhaps some of our readers may be able to supply information on this subject.

Tomatoes Falling (J. R.).—There is nothing in your letter in respect to soil, temperature, or treatment to afford us any guidance in suggesting what may have been the contributory cause of the peculiar condition of the plants. If they have not been overfed, the atmosphere too moist, and the temperature too low we fear they are beyond cure; but if you have any doubt on those points try a change of treatment, keeping the soil and atmosphere much drier, and raising the temperature considerably. The appearance of the leaves indicates that they have not been able to elaborate the sap, and that the plants in consequence are in a state somewhat analogous to that of blood poisoning in individuals. We will examine them more closely than time permits before preparing this reply, and if we have anything to add will refer to the subject again.

Drying Flowers in their Natural Colours (A. L., Clontarf).—The following method is recommended by one who has had much experience in the work:—Take two pints of a saturated solution of sulphurous acid in water (which can be had at any chemists, and is very cheap if brought in large quantities); add to this one pint of methylated spirit. Keep this mixture in a wide-mouthed bottle, which should be so tightly closed that the contents do not evaporate when not in use. Leave ordinary flowers in this mixture for about ten to twenty minutes; inflorescences of Bromeliaceae and Aroideae must be left in it about an hour. In most cases the colour will completely disappear, but it will gradually return during the process of drying, or even after the plants have become apparently quite dry. Having treated the specimens with the mixture for a short time as stated above, take them out and shake off the adhering drops of fluid. Leave the plants in a dry warm place in order to dry them superficially (they must not be allowed to shrivel), and then dry them in the usual way between blotting paper. If artificial heat is used in the latter part of the process excellent results are obtained, and it is not even necessary to change the drying paper. If hot-water pipes are available it is very convenient to place on them the bundle containing the plants to be dried, which need not be subjected to very great pressure. As it is sometimes difficult to prevent flowers from collapsing when using this method of preservation, and as often it is almost impossible to spread out those flowers when they have collapsed, we often put them loosely between sheets of vegetable parchment before immersing them in the fluid. Orchid flowers will require very careful treatment both in drying and pressing, as it is difficult to preserve their forms owing to their fleshy substance.

Canker in Apple and Pear Trees (R. W.).—The trees that were in good bearing order, but now die back at the tips of the shoots or boughs and bear very small and crippled fruit, are in the condition of many others to be found in orchards. We have taken note of Apple trees in various parts of the country, and have found that of those in grass one-sixth of the trees are falling a prey to canker at the "tips of the boughs," as in your case, whilst in those that are subjected to cultivation the average of diseased trees through canker is not more than 6 per cent. This proves that canker is in part due to or accelerated by a deficiency of nutrition, though the disease itself may have been introduced at a time when the growths were gross and the bark susceptible of damage from hailstones, punctures of insects, or the tissues ruptured by frost in consequence of the aqueous matter they contained. By some such agency the disease is at first set up, and the remedy is to render the disease latent whilst energising the trees, and causing them to make free healthy growths and so overcome the canker. Nothing short of removing the cankered parts of varieties in which the disease is prevalent or inherent and putting on fresh heads of

varieties that are seldom affected is remedial. That we advise in your case. The stems, we presume, are quite healthy and free from large wounds. Such is generally the case when canker affects the tips of the boughs, and the trees die by degrees. It is too late to operate this season, but next autumn we advise your cutting off the heads and regrafting the trees next spring with those varieties that in your immediate neighbourhood show no trace of canker. Such varieties as Lord Grosvenor, Ecklinville Seedling, Golden Noble, Lord Derby, and Bramley's Seedling Apples are not prone to canker, and all are good profitable varieties; but the safest plan is to be guided by the trees in your locality. We presume the ground is efficiently drained, and that the trees have the advantage of light and air, neither crowded in the branches, cumbered with dead wood and thickly clustered twigs, nor the trees so close together as to crowd each other. If either, thinning would afford some alleviation. The trees should be cut over soon after the leaves fall, leaving eligible arms for putting on grafts in spring at the required height and place, leaving the stems a little longer than the proposed place of inserting the grafts so as to admit of a little being taken off at the time of grafting. Burn all the heads, or if saved for firewood take them away from the orchard. If the ground is in grass and long eat it off with sheep fed on oil cake. In three years from grafting the trees should bear fine fruit. We have known worthless trees made highly profitable by the method advised. If you decide to keep the trees and try the effect of thinning the heads and cutting away the diseased parts, which should be burned, also all the trimmings, strewing the ashes on the ground, eat the grass off bare with sheep, and apply the following mixture:—3 cwt. steamed bone meal, 2 cwt. kainit, $\frac{3}{4}$ cwt. sulphate of iron, and 5 cwt. sulphate of lime, mixed, per acre in autumn or in February, distributing evenly, and leaving for rain to wash in.

Horticulture in the Cape Colony (H. Fahey).—We are very pleased to hear that horticulture is making "rapid strides" in the Cape Colony, and that a stimulus is being given to the cultivation of plants, flowers, and fruit by the Uitenage Horticultural Society. The schedule of your February Show is very comprehensive, and contains 122 classes for various kinds of summer flowers, fruits, and vegetables, and we note that your "spring show" is to be held in November. As in exhibiting you "wish to go on the lines of horticultural societies in England," we can assure you that both amateurs and nurserymen can and do compete in "open classes." Amateurs have as much right to show in classes thus described as nurserymen have, but nurserymen are absolutely debarred for entering in the "amateurs' classes." In some schedules "nurserymen's classes" are provided, and from these classes amateurs are excluded. In localities where there are not sufficient trade exhibitors to compete and make a good display amongst themselves, certain classes are made "open," in which they can enter with amateurs, and both compete amicably together. It is not at all unusual for nurserymen to be defeated by their amateur friends, and when this occurs the former cheerfully acquiesce in the verdict of competent judges. In England a nurseryman would never think of showing in the "amateur classes," no matter how many amateurs competed against him in those described as "open." If a nurseryman should think that amateurs are accorded special privileges in being allowed to show in two sections and he in one only, it should be remembered, and is well understood in England, that the nurseryman has the privilege of selling his goods and taking orders from visitors, and that is his compensation. It is right to encourage amateurs to exhibit in and win prizes if they can in the "open classes," and the greater the numbers of such successful amateurs the better, not for themselves alone, nor for the Society, but for nurserymen. So well is this recognised in England that business firms contribute substantial amounts to the prize lists of shows, and on opening a schedule at our elbow, that of the great Show to be held at Shrewsbury on August 10th, we find that Messrs. Webb, Sutton, Carter, Sydenham, Davies, and Colchester provide an aggregate of £50 to be awarded in fourteen classes. The stipulations in your schedule appear very explicit and the rules concise and good. One of them might be worth the attention of some local societies in the "old country"—namely, "Any exhibitor feeling himself aggrieved by the award of the judges and causing any unpleasantness on the day of the Exhibition shall forfeit all prizes that may have been awarded him on that day." At most shows, however, it is happily the rule for losers to accept defeat manfully. We trust you will go on progressing, and shall be glad to hear from you at any time, and answer any questions we can that you may desire to ask.

Names of Plants.—We only undertake to name species of plants, not varieties that have originated from seed and termed florists' flowers. Flowering specimens are necessary of flowering plants, and Fern fronds should bear spores. Specimens should arrive in a fresh state in firm boxes. Slightly damp moss, soft green grass or leaves form the best packing, dry wool the worst. Not more than six specimens can be named at once, and the numbers should be visible without untying the ligatures, it being often difficult to separate them when the paper is damp.—(T. G.).—*Piptanthus nepalensis*. (*Nemo*).—1, *Iris pseudacorus variegata*; 2, *Stachys lanata*; 3, *Alyssum saxatile*; 4, *Corydalis lutea*; 5, *Spiraea salicifolia*; 6, *Ranunculus aconitifolius* fl.-pl. (*W. R.*).—The very imperfect specimen resembles the Cape Gooseberry, *Physalis pubescens*. (*J. R.*).—1, *Kerria japonica* fl.-pl.; 2, *Doronicum plantagineum*; 3, *Trollius asiaticus*; 4, *Stachys lanata*; 5, *Amelanchier botryapium*. (*H. J. P.*).—1, *Odontoglossum citrosimum*; 2, *Thun'ia alba*; 3, *Adiantum trapeziforme*. (*W. E. C.*).—1, *Orchis latifolia*; 2, *Trollius europæus*; 3, *Doronicum austriacum*; 4, *Iberis sempervirens*; 5, *Cheiranthus alpinus*; 6, *Saxifraga hypnoides*.

TRADE CATALOGUES RECEIVED.

Yokohama Gardeners' Association, 21 and 35, Nakamura, Yokohama, Japan.—*Descriptive and Illustrated Catalogue of Plants*.
 J. Carter & Co., 237 and 238, High Holborn.—*Illustrated Lists of Primulas, Calceolarias, Cinerarias, and Cactus*.
 J. Veitch & Sons, Royal Exotic Nursery, King's Road, Chelsea.—*Catalogue of Plants and Novelties (illustrated)*.
 W. Bull, 536, King's Road, Chelsea, S.W.—*Catalogue of New and Rare Plants (illustrated)*.
 W. Richardson & Co., Darlington.—*Catalogue of Horticultural Buildings (illustrated)*.
 Dicksons & Co., 1, Waterloo Place, Edinburgh.—*List of Bedding and Border Plants*.

COVENT GARDEN MARKET.—MAY 27TH.

Business better, with supplies shorter.

FRUIT.			
	s.	d.	s. d.
Apples, $\frac{1}{2}$ sieve	1	6	to 6 0
" Nova Scotia and Canada, per barrel	15	0	26 0
" Tasmanian, case	6	0	14 0
Grapes, New, per lb. ..	2	6	4 0
Kentish Cobs	40	0	to 50 0
Lemons, case	15	0	20 0
Oranges, per 100	4	0	9 0
Peaches, per doz.	6	0	24 0
St. Michael Pines, each..	3	0	8 0
Strawberries, per lb. ..	1	6	5 0

VEGETABLES.

	s.	d.	s. d.
Asparagus, per bundle ..	0	6	to 2 6
Beans, Kidney, per lb. ..	0	9	1 0
Beet, Red, dozen	1	0	0 0
Brussels Sprouts, $\frac{1}{2}$ sieve	0	0	0 0
Cabbage, dozen	3	0	0 0
Carrots, bunch	0	4	0 0
Cauliflowers, dozen	3	0	6 0
Celery, bundle	1	0	1 8
Coleworts, doz. bunches	2	0	4 0
Cucumbers, doz.	3	0	5 0
Endive, dozen	1	0	0 0
Herbs, bunch	0	2	0 0
Leeks, bunch	0	2	0 0
Lettuce, dozen	3	0	3 6
Mushrooms, punnet ..	1	6	to 2 0
Mustard & Cress, punnet	0	2	0 0
Onions, bushel	3	0	4 0
Parsley, dozen bunches	2	0	3 0
Parsnips, dozen	1	0	0 0
Potatoes, per cwt.	8	0	4 0
Rhubarb, bundle	0	2	0 3
Salsafy, bundle	1	0	1 6
Scorzoner, bundle	1	6	0 0
Seakale, per bkt.	1	0	1 6
Shallots, per lb.	0	3	0 0
Spinach, bushel	5	0	6 0
Tomatoes, per lb.	1	0	1 3
Turnips, bunch	0	0	0 4

AVERAGE WHOLESALE PRICES.

CUT FLOWERS.

	s.	d.	s. d.
Anemone, dozen bunches	2	0	to 4 0
Arum Lilies, 12 blooms ..	2	0	6 0
Azalea doz. sprays	0	9	1 0
Bluebells, dozen bunches	1	0	2 0
Bouvardias, bunch	0	9	1 6
Camellia, white, per doz.	2	0	4 0
" red	0	9	1 6
Carnations, 12 blooms ..	1	0	2 0
Cowslips, dozen bunches	0	6	1 0
Cyclamen, doz. blooms ..	0	3	0 6
Daffodils, doz. bunches ..	2	0	6 0
Eucharis, dozen	3	0	6 0
Gardenias, per doz.	1	0	3 0
Iris (Various) doz. bchs.	6	0	12 0
Lapageria, 12 blooms ..	2	0	4 0
Lilac (English) per bunch.	0	6	1 0
" (French) per bunch	5	0	6 0
Lilium longiflorum, 12 blooms	3	0	4 0
Lilium (Various) dozen blooms	1	0	3 0
Lily of the Valley, dozen sprays	0	6	1 0
Lily of the Valley, dozen bunches	4	0	9 0
Maidenhair Fern, dozen bunches	4	0	9 0
Marguerites, 12 bunches	2	0	to 4 0
Mignonette, 12 bunches..	3	0	6 0
Mimosa (French), per bunch	1	3	1 6
Myosotis, dozen bunches	2	0	4 0
Narciss (Various) dozen bunches	1	0	3 0
Narciss (double white) dozen bunches	4	0	8 0
Pansies, dozen bunches..	1	0	2 0
Pelargoniums, 12 bunches	4	0	9 0
" scarlet, 12 bunches	4	0	6 0
Primula (double) 12 sprays	0	6	1 0
Primroses, dozen bunches	0	4	0 9
Roses (indoor), dozen ..	0	6	1 6
" Red (English) per dozen blooms ..	2	0	4 0
" Red, 12 bls. (Frch.)	2	0	4 0
" Tea, white, dozen ..	1	0	3 0
" Yellow, dozen	2	0	4 0
Spiræa, per bunch	0	6	0 9
Tuberose, 12 blooms ..	1	0	1 6
Tulips, per dozen	0	3	0 6
Violets (Parme), per bch.	3	0	4 0
" (dark), per bch.	1	0	1 6
" (English), doz. bunch	0	6	1 0
Wallflower, doz. bunches	1	6	3 0

PLANTS IN POTS.

	s.	d.	s. d.
Aralia Sieboldi, dozen ..	6	0	to 18 0
Arbor Vitæ (golden) doz.	6	0	8 0
Arum Lilies, per doz.	9	0	12 0
Azalea, per plant	2	0	3 6
Calceolarias, per dozen ..	6	0	12 0
Cineraria, per doz.	5	0	8 0
Cyclamen, per doz.	9	0	18 0
Deutzia, per doz.	6	0	8 0
Dracæna terminalis, doz.	24	0	42 0
" viridis, dozen	12	0	24 0
Erica, various, dozen ..	12	0	24 0
Enonymus, var., dozen ..	6	0	18 0
Evergreens, in var., dozen	6	0	24 0
Fairy Roses, per doz.	9	0	12 0
Ferns, in variety, dozen..	4	0	18 0
Ficus elastica, each.	1	6	7 0
Foliage plants, var., each	2	0	10 0
Genista, per doz.	6	0	9 0
Geraniums, Ivy, per doz.	4	0	to 8 0
Hydrangeas, per doz.	9	0	12 0
Lilium longiflorum, per dozen	18	0	20 0
Lily of the Valley, per pot	1	0	2 0
Lobelia, per doz.	4	0	6 0
Marguerite Daisy, dozen	6	0	12 0
Mignonette, per dozen ..	4	0	9 0
Musk, per doz.	2	0	4 0
Myrtles, dozen	6	0	12 0
Palms, in var., each.	2	6	21 0
Pelargoniums, per doz.	9	0	18 0
Pelargoniums, scarlet, per dozen	4	0	9 0
Primula sinensis, per doz.	4	0	6 0
Spiræa, per doz.	8	0	12 0
Stocks, per dozen	4	0	6 0
Tropæolum, per dozen ..	3	0	6 0

Bedding plants (in variety) in boxes, from 1s. to 3s.; in pots, per doz., 1s. to 2s.



GOOD BUTTER.

Two reminders have we had recently of the steady increase of subscribers to the Journal, and of the consequent necessity of a

frequent repetition of its most useful lessons. Well informed as old subscribers are, it can do even them no harm to jog the memory a bit, and even if they are sensible of knowing all about it, they must take such a benevolent interest in our efforts to assist others, and in the ever widening influence of the Journal that their approval is a very safe foregone conclusion.

Certainly our title this week is a suggestive and tempting one, for who does not regard really good butter as one of the most delicious things we can have upon our tables? That two of our friends in Shropshire do we have proof in the letter of one asking for practical details of butter making, and the prompt adoption by the other of the hints which we involuntarily let fall upon tasting some excellent, but not perfect home-made butter, during a recent visit to that famous grazing county. The butter sent to table was of good flavour and high colour, but when cut white streaks were visible, affording sure evidence of faulty churning. Our hostess said that neither she nor her cook had been taught butter making, but she was so anxious to have good butter that she gave close personal supervision to the work. A description of the correct method of churning, of the importance of stopping the churn immediately upon the appearance of the butter grains, of thorough washing of the grains in the churn, and of the use of the butter worker, was listened to with intelligent interest. Butter grains we were told had never been heard of before, and the churn had been kept going till the grains had been pounded into a mingled mass of butter and casiene, hence the white streaks. Next day was churning day, and at luncheon came the triumphant announcement of butter grains and perfect washing! Depend upon it there will be no more discoloured butter in that house; but it must not be forgotten that good butter is not entirely a result of correct churning, there are other important factors to success which must have due attention, and of primary importance among them is

CREAM MANAGEMENT.

Whatever is the system favoured, whether shallow pans, deep pans, or immediate separation, the cream should be kept either in glass or glazed earthenware jars about twelve hours after it is skimmed or separated to induce ripeness, and so not only facilitate churning, but to ensure all the butter being got from the milk. The addition of a small teaspoonful of powdered saltpetre to 3 gallons of cream prevents bitterness, and is worthy of attention. Inequality of condition in cream prevents good butter being made. Newly skimmed cream should not be mixed with old cream at the time of churning, but cases arise when it becomes desirable to churn all the cream that can be had. The cream, new and old, should then be well stirred together, and stand for a few hours before churning. The colder the weather the longer should it stand, and while standing it should be stirred occasionally, so that the whole of it is put into the churn of the same consistency, and not part in thick clots, and part in a much thinner liquid state, as is so often the case when cream is left unstirred.

Good butter is obtained from weekly churnings, but churning twice a week is decidedly preferable for the bulk of the cream; most home farmers churn daily. Cream that has soured a little yields the butter grains more quickly than quite sweet cream, and we have heard of most excellent butter being made from cream with which a little sour buttermilk was mixed. The longer a cow has calved the longer will it require to churn before the butter grains are visible, because the cream globules are smaller than they are in the milk of cows that have calved more recently. It is obvious, therefore, that much butter may be lost when the cream of "stale" and "fresh" cows is mixed. The butter grains from the fresh cows being visible so quickly misleads the churner who, under the very natural idea that the whole of the butter has "come," runs off the buttermilk and with it the smaller invisible butter grains of the older cream. It should be clearly understood that the larger the butter grains are the sooner do they become visible in the churr, and it is for this reason that butter is obtained so quickly from the

cream of the milk of Jersey cows as the cream globules are so large. In butter-making contests time is taken into account, but in common fairness the cream used by each competitor ought to be from the same breed of cows, and also be equal in the freshness of cows and ripeness of the cream. It is by giving close attention to such little matters of detail that good butter is made, and there are several such matters to which attention will be given next week.

WORK ON THE HOME FARM.

Very seldom indeed is land left for a long summer fallow now. The once popular idea of resting the land in this way is now pretty well exploded, and recourse is only had to a bare fallow when land has become so foul with Couch Grass and other perennial weeds that it can only be got clean by repeated ploughings and harrowings. In such extreme cases every opportunity of pushing on such work should be taken, and much good may now be done before haymaking begins. All the large roots of Couch Grass, Thistles, and Docks should be cleared off by the harrows, but for smaller roots hand-picking and hand-raking may be necessary. It is only by such care that it is possible to clean foul land.

The plant of all root crops should be singled as soon as it is large enough to handle, and both horse and hand hoes must be kept going briskly to keep down weeds. If it is intended to apply a top-dressing of nitrate of soda to Mangolds let this be done immediately after the plant is singled, so that the manure is well worked into the soil by the hoes in order that the moisture in the soil may act upon it and cause it to dissolve. A shower of rain will do this quickly, but then we dare not reckon upon rain. It probably comes in good time, but it is uncertain, and it is wise to make as sure as we can of the prompt action of the manure. See that Potatoes have the soil drawn to the stems in good time before growth has so far advanced that harm may be done by the plough, which is the case when the roots have previously spread far in the soil.

Several instances of washing sheep in unsuitable weather have come under our notice recently. For all ordinary flocks it is simply an affair of a day, and it is surely only wise to wait till the weather is really warm, and not to plunge the sheep into water while the weather continues so cold. Very strongly is the necessity for washing wool in this way questioned now. Much wool is sheared "in the grease" or unwashed state, and we believe its quality and value for all purposes is equal to that which is washed on the sheep. The wool staplers are, of course, sharp enough to raise any quibble by which farmers may be induced to accept something less per pound for the wool than market value, but this is a matter that should and could be set right once for all by Agricultural Chambers.

OUR LETTER BOX.

Butter not Keeping (*Perplexed*).—If your butter loses quality in a day or two after the churning it is probably owing to keeping it in some place where its surroundings are impure. It may be the air is tainted by odours from other food or stores, or even from the walls, floors, or furniture of the room, and butter so quickly absorbs any taint that it is soon spoilt. We hope to deal fully with this important matter in our Farm article next week. Meanwhile we shall be glad to have a precise description of your butter store, including floor, walls, woodwork, and general contents.

The Wheat-bulb Fly (*W. R.*).—Your Wheat appears to be attacked by this destructive visitant, *Hylemyia coarctata*. It is illustrated in Miss Ormerod's fourteenth "Report," published by Messrs. Simpkin, Marshall, Hamilton, Kent & Co., and can be obtained through a bookseller for 1s. 6d. We do not know that any certain remedy has been discovered, but we believe some persons like yourself have found soot useful, and others consider dressings of nitrate of soda advantageous.

METEOROLOGICAL OBSERVATIONS.

CAMDEN SQUARE, LONDON.

Lat. 51° 32' 40" N.; Long. 0° 8' 0" W.; Altitude, 111 feet.

DATE.	9 A.M.					IN THE DAY.				RAIN.
	Barometer at 32° and Sea Level.	Hygrometer.		Direction of Wind.	Temp. of soil at 1 foot.	Shade Temperature.		Radiation Temperature.		
		Dry.	Wet.			Max.	Min.	In sun.	On grass.	
1891.										
May.										
Sunday	29.73	43.7	59.7	N.	51.6	49.6	31.7	93.6	29.2	0.632
Monday	29.28	41.0	49.0	N.E.	50.3	45.1	37.8	66.0	32.4	0.076
Tuesday	29.53	45.0	38.9	N.	48.2	53.6	33.4	104.6	28.0	0.180
Wednesday	29.729	51.3	45.8	S.W.	48.6	56.3	41.1	93.4	34.3	0.324
Thursday	29.42	46.0	44.9	N.E.	49.0	49.9	42.0	62.9	42.9	0.051
Friday	29.59	46.9	43.0	S.W.	48.8	59.4	44.1	107.9	44.5	—
Saturday	29.76	51.6	45.8	N.	49.0	58.9	43.1	91.8	39.0	0.663
	29.585	43.5	43.0		49.4	54.0	33.9	90.0	35.8	1.240

REMARKS.

- 17th.—Bright till 10 A.M., then spots of rain and hail, and generally cloudy after, with frequent showers of rain and soft hail.
 18th.—Steady rain from 0 A.M. to 10 A.M., and from noon to 1 P.M.; overcast with drizzle at other times.
 19th.—Fine, but cloudy at times in afternoon, and heavy rain from 4.45 to 6.30 P.M.
 20th.—Bright early; overcast, showery day, and heavy rain from 11 to noon.
 21st.—Wet from 1 A.M. to 8 A.M., and overcast and showery all day.
 22nd.—Gloomy and damp all morning; generally bright in afternoon, but slight shower at 5 P.M., and cloudy evening.
 23rd.—Fine and bright early; generally cloudy after 11 A.M., and at times threatening.
 A wild, cold, wet week, noteworthy for the frosts on the 17th and 19th.—
 G. J. SYMONS.



TOMATOES IN THE OPEN.

TOMATO culture in the open air—that is to say, in any position where the plants are at the mercy of whatever weather is going, will always partake somewhat of a lottery, or more so than other vegetable crops that may be grown. In spite of this uncertainty I would still counsel perseverance, as should success attend their cultivation one heavy crop of sound fruit would well repay for two or three partial or complete failures; and there is also a comfortable feeling in the matter, especially should the success be a somewhat isolated case. As it happens a complete failure rarely occurs when those responsible go the right way to work. Haphazard cultivation is the most likely to end in failure, and it is also unwise to adopt any hard and fast lines in the cultivation of open air Tomatoes.

Instead of annually planting in one or two certain positions, where more often than not failures occur, those who mean having a crop in some form or other, ought to try what can be done in various spots, both in the open and against sunny walls. Sometimes those supported by one wall will become badly diseased long before the fruit has ripened, while the plants against another wall or fence will escape all contamination. I have even met with instances where Tomatoes have failed against the walls and yet succeeded when grown in the open, but as a rule the plants are least affected by disease when they are sheltered in some way from much of the rain that falls. If the foliage can be kept dry, or nearly so, all the time not much disease will affect them. Forest trees partly overhang our warmest garden walls, and what Tomatoes are grown between the Peach trees rarely fail, the same remark applying to the plants located among Apricots under a glazed coping. Those, therefore, who can utilise sheltered spaces between their fruit trees on the sunniest walls ought to continue to do so, and in all probability it would pay well to place glazed copings to lower walls specially for Tomatoes and Chrysanthemums, the latter being transplanted from the open quarters to the foot of the walls in the autumn.

Some of the best positions for Tomatoes are the high front or south walls of forcing houses, the plants getting the benefit of the warmth from the walls, and if they could be further protected with copings or lights on end the crops would be heavy and failures few and far between. If head room is somewhat limited the plants can be trained obliquely, while if there is no regular border a temporary one could easily be formed. Plants grown against wooden screens erected on sunny borders sometimes succeed admirably, but there is no certainty about them, any more than there is with those grown singly in the open and staked uprightly. If, however, Tomatoes in abundance are desired, there is no reason why each and every plan of growing them should not be adopted, and it will be a very bad season indeed if all fail.

Much depends upon the way in which the preliminary details are carried out, the loss of two or three weeks at the outset seriously militating against ultimate success. Either very small or comparatively old and much starved plants have a considerable leeway to make up before they arrive at a full bearing state, and it will usually be found to pay well to take more pains in the preparation of the plants. Of the two extremes I would rather put out young plants than any that have been drawn up and starved in small pots. Only a small minority probably are in a

position to shift plants raised in March into 8-inch pots, and to keep them in airy pits or light positions in cool houses till the present date, at which time many of them would already be furnished with one cluster of fruit with more setting, yet this is the most correct practice. The next best plan is to defer sowing seed till near the end of March, the seedlings being potted off in pairs in 6-inch pots, and kept steadily growing under glass till close upon planting time. Plants thus treated would be healthy, vigorous, and have their first bunches of bloom well advanced when turned out, and it would be the cultivator's own fault if an early crop failed to set. This may seem a somewhat bold assertion, but it is indisputable.

The idea that young plants require to be starved at the roots in order to make them fruitful is responsible for a good many failures, and in still more cases the practice, without the idea, is the cause of the early flowers especially dropping off. That over-luxuriance is to be guarded against I readily concede, but let the plants first become well established in their fruiting quarters before the drying-off or let-alone policy commences. Doubtless instances have been met with where the plants have never had any water from a watering pot or hose from the time they were first put out, but in all such cases they must have been in a more exposed position than is generally good for them. All I know is that if our plants under the copings are not well supplied with water at the roots they gradually assume a glaucous hue and fail completely. Nor is there any wisdom in planting in poor dry soil such as may usually be found close up to walls. Let each plant have two or three shovelfuls of loam and decayed manure to start in, and rank growth will be checked by the surrounding firm soil. If thought inadvisable to give water when the plants are growing strongly, there is yet much necessity for its application till such times as the roots are spread into the surrounding soil. Should the old balls of soil and roots be in a semi-dry state when turned out, and subsequently be neglected or left to take their chance, the first flowers that open must inevitably drop off owing to want of sustenance. Keep the balls uniformly moist, without saturating the surrounding soil, and the chances are a healthy root and top growth will quickly be made and an early crop set. A mulching of manure is not thrown away upon Tomatoes, whether these are planted against walls or in the open, and if the plants are kept properly supported and denuded of all superfluous growth, nothing but a very unfavourable season will prevent a heavy crop from ripening off.

Many act and write (and I may have done the same) as though there is only one way of rightly training Tomatoes, this being the single-stemmed or cordon system. As it happens, the plan of laying in two or three side branches answers admirably, and is the least liable to fail owing to too liberal treatment at the roots. Our best crops were obtained last season from plants put out where they could cover good wall space, the branches being laid in 12 inches apart, and allowed to extend to a height of 6 feet. A photograph of two plants of the Conference thus treated was taken and a copy duly forwarded to the Editor of this journal. If the plants are much confined for head-room and very liberally fed at the roots, failure is probable enough; but given moderately liberal treatment, plenty of head-room, and shelter from rains, and success is almost certain. It is somewhat late to discuss the value of different varieties for open-air culture, and I will merely add that Laxton's Open Air and Sutton's Earliest of All are the first to ripen fruit, and are reliable and heavy croppers, the quality also being fairly good. The Conference is remarkably productive, the fruit being of a serviceable size and superior quality. A good stock of Old Red is sure to crop heavily, and so also is Dedham Favourite. Perfection, Ham Green Favourite, Abundance, Hackwood Park Prolific, Sensation, Chemin, and such like are all fine productive varieties, and the red and pink forms of Mikado are also well adapted for open-air culture, none excelling these in point of size or quality. Golden Queen, Golden Sunrise, Yellow King, and Blenheim Orange are all heavy cropping

yellow fruited varieties, the last-named being the best of the four in point of flavour.—W. IGGULDEN.

[We have no recollection of receiving the photograph referred to. No doubt it was good, as our correspondent is not the man to photograph a failure.]

THE CARNATION.

[A Paper by Mr. JAMES DOUGLAS, read at the meeting of the Hawick Horticultural Mutual Improvement Association, May 29th.]

THE HISTORY.

It has now been determined, as nearly as anything can be, that the original wild plant from which our beautiful garden Carnations have been derived is the *Dianthus caryophyllus*, or Clove Pink, of Linnaeus. It produces pale flesh-coloured flowers, and has been naturalised on old walls in various parts of England. As a garden flower it is supposed to have been cultivated as early as the time of Edward III. It is mentioned by Chaucer because the flowers were useful to flavour ale. It is alluded to by Spenser in the "Shepherd's Calendar" amongst other garden flowers in these words:—

"Bring hither the Pincke and purple Cullambine,
With Gilliflowres;
Bring Coronations, and Sops-in-wine,
Worn of paramours."

Shakespeare, of course, alludes to the Carnation. In the "Winter's Tale" Perdita is made to say—"The fairest flowers o' the season Are our Carnations, and streaked Gillyflowers, Which some call nature's bastards: of that kind Our rustic garden's barren; and I care not To get slips of them." The work of Rembrandt Dodoens was translated by Lyte and published in 1578, and there we come upon the word Carnation for the first time.

In 1597 the "Historie of Plants" was published by John Gerarde, and at page 472 he tells us all that he knew of the garden varieties, "and how every yeere every climate and countrie bringeth fourth new sortes, such as haue not bene heretofore written of; some whereof are called Carnations, others Cloue Gilloflowers, some Sops-in-Wine, some Pagiants or Pagon colour, Horseflesh, bluncket, purple, white, double and single Gilloflowers, as also a Gilloflower with yellow flowers. The which a worshipfull marchant of London, Master Nicholas Lete, procured from Poland, and gaue me thereof for my garden, which before that time was neuer seen nor heard of in these countries." He alludes to a few garden varieties and figures "the great double Carnation" with only a few extra petals, and also a variety with more double but much smaller flowers, "the double Cloue Gilloflower."

Gerarde was therefore the first to grow and write about the yellow Carnation. The "Paradisus" of Parkinson was published in 1629, and contains a list of nineteen varieties of Carnations and twenty-nine varieties of Gilloflowers. There were many colours—white, crimson, blush, flakes and stripes, the yellow or orange-tawney. A number of the best varieties are figured, but the figures do not give one any idea of a really double flower. The Carnation had much the largest flowers, the Gilloflowers were smaller. The type of the Carnation was "The Great Harwich or Old English Carnation," which Parkinson calls a goodly great flower worthy of a prime place. The Gilloflowers seem to be of the type of our Pinks. Rea's "Flora," published in 1665, gives us more information, and hints that some of the varieties formerly grown in our gardens had passed out of cultivation; and as far as we can learn from later authors the Carnation in its various form of selfs, flakes, and stripes was successfully cultivated during the later years of the seventeenth and the early part of the eighteenth century. The second edition of the "Gardeners' Dictionary" was published by Miller in 1733. Philip Miller was gardener to the Worshipful Company of Apothecaries at their botanic garden, Chelsea, and he writes a long and elaborate article on the Carnation, which contains all that was likely to be known of it up to that date. He says the "florists" divide the Carnation, or Clove-gilliflower, into four classes. The first they call flakes, these are of two colours only, and their stripes are large, going quite through the "leaves" (petals?). The second are called "bizarres," these have flowers striped or variegated with three or four different colours. The third are called "Piquettes," these flowers have always a white ground, and are spotted (or pounced as they call it) with scarlet, red, purple or other colours. The fourth are called "Painted Ladies," these have their petals of a red or purple colour on the upper side and are white underneath.

Here we have a correct definition of the Carnation as it was

cultivated in England more than 150 years ago. Miller informs us that then, as now, the list of names of cultivated varieties was a long one, the names being borrowed from "the titles of noblemen or from the person's name or place of abode who raised it." The "florists' properties of a flower as defined by Miller were as follows:—

"1, The stem of the flower should be strong, and able to support the weight of the flower without hanging down. 2, The petals of the flower should be long, broad, and stiff, and pretty easy to expand, or, as the florists' term them, should be free flowers. 3, The middle pod of the flower should not advance too high above the other part of the 'blowers' (? flower). 4, The colours should be bright, and equally marked all over the flower. 5, The flower should be very full of petals, so as to render it when blown very thick and high in the middle, and the outside perfectly round."

The above flower properties are given exactly in Miller's own words, and as a matter of cultural and historical interest his directions for culture are much the same as we now practise in our own gardens, even to the system of planting one or a pair of plants in small pots and sheltering them in cold frames. Miller says he used pots that cost a halfpenny each. The plants were put to bloom in pots measuring 9 inches across in the clear. From the time of Miller until the end of the eighteenth century we have evidence that the Carnation had been brought by the art of the florists to as high a state of floral excellence as we now see it in our gardens. In the year 1788 there was figured in Curtis's *Botanical Magazine* a scarlet bizarre Carnation named "Tartar," which had been produced from seeds by an ingenious cultivator of these flowers named Franklin, who had his garden in Lambeth Marsh. The coloured plate of this Carnation is No. 39, *Bot. Mag.*, and when placed in juxtaposition with the finest scarlet bizarres of the present day Mr. Franklin's flower can hold its own with the best of them. Mr. Curtis here states that the *Dianthus Caryophyllus* or wild Clove "may be found, if not in its wild state, at least single, on the walls of Rochester Castle, where it has been long known to flourish, and where it produces two varieties in point of colour, the pale and deep red."

In 1824 the third edition of Hogg's "Treatise on the Carnation" was published, and therewith we have coloured plates of the bizarre Carnation and also the yellow Carnation or Picotee. In respect to the quality of the flowers of the bizarre Carnation there is no advance upon that figured by Curtis, but yellow Carnations and Picotees had attained to a high state of perfection. Hogg says his coloured plate represents a yellow Picotee, but as the petals are marked with flakes or stripes, and the margin is also marked with short lines instead of a continuous margin as we have now upon the best yellow varieties, it could not be admitted with the modern Picotees. Thomas Hogg was a good Carnation grower, and gave most minute cultural instructions; but we have learned to grow our plants well without the endless trouble entailed in mixing up, turning over and over again the elaborate composts recommended by him.

In the "Horticultural Register" of 1836 there is a coloured plate of a true yellow Carnation, under the name of Rodger's Unique Golden Crimson Bizarre; it is beautifully marked in two colours on a rich yellow ground. It is stated that the nearest approach to it is one of the lately introduced yellow Picotees. We are further informed that the seeds from which the plant was raised had been obtained from Brussels; moreover, a small stock of plants only could be obtained, and as the constitution of it was not very vigorous it would soon pass out of existence, and unless seedlings were raised from it the stock itself would be lost to the floral community.

DESCRIPTIVE REMARKS.

For garden purposes the Carnation is divided into numerous sections, in which must be included the Picotee, and these are arranged as under in the schedules of the National Carnation and Picotee Society.

I. *Scarlet Bizarres*.—This type of Carnation has for many years been at the head of the list in exhibition schedules and the catalogues of the leading florists. The flowers have flakes or stripes in maroon and scarlet on a white ground.

II. *Crimson Bizarres*.—The flowers of this section are striped and flaked with a colour approaching crimson, and also purple on a white ground.

III. *Pink and Purple Bizarres*.—These have a pale pink colour in place of the crimson or deeper pink with the purple flakes; the ground being white.

IV. *Purple Flakes*.—In this the flowers are merely flaked or striped with purple of various shades, and in some cases the colour is broken up into spots or small blotches, which is a serious fault. The purer the white the more is the flower esteemed; the flakes and stripes should be distinctly marked, and their beauty lies in their irregularity.

V. *Scarlet Flakes*.—The same remarks apply to this as to the purple flakes, and the colour should be a rich and decided scarlet colour; the brighter the colour and the greater the purity of the white the better.

VI. *Rose Flakes*.—This is a very pleasing section of the Carnation, and is always much esteemed for the delicate rose tints on the white ground.

VII. *Selfs*.—This is doubtless the earliest type of the Carnation, and by many tasteful persons is the most highly valued. The colours are rich and brilliant, rose scarlet, crimson maroon, purple, white, yellow, &c., of many shades. They are all extremely beautiful for planting in masses or as isolated clumps in the borders.

The Picotee is for garden and exhibition purposes divided into six sections, although there are but three well defined colours. Each colour is again sub-divided into broad and narrow edged. These definitions may be as under:—

VIII. *Red-edged*.—In this as well as the other colours there are of course various shades, which in individual specimens are narrow, as in Thomas William and Violet Douglas, wherein the colour is represented by a line, like fine wire round the margin of each petal. The medium edge has a broader and more irregular line, as in Emily, and the extreme width of the marginal colour is in an old and well known variety named Brunette.

IX. *Purple-edged*.—Here the colours are in the same degree of narrow, medium, and broad.

X. *Scarlet and Rose-edged*.—Herein the colours are supposed to be scarlet, and a very few of the varieties in cultivation may be described as of that colour. Most of them are rose or salmon, but the most beautiful varieties of Picotees are in this section, such as the beautiful narrow rose-edged Liddington's Favourite and the broad-edged scarlet Mrs. Sharpe.

XI. *Yellow Ground Picotees*.—The varieties in this section have become very numerous during recent years, and we have now as good quality in the yellow Picotees as in the white ground varieties. One named Remembrance is of a rich yellow colour and unmarked, except a fine line of rosy red round the edge of each petal.

XII. *Fancy Carnations and Picotees*.—All flowers that by reason of their peculiar shades of colour cannot be admitted into any of the above classes find a refuge here. Some of them are very beautiful, and are adapted for border culture.

XIII. Into this last class I have placed the tree or perpetual flowering Carnations. This class is greatly valued because of the plants flowering during the autumn, winter, and spring months. The stems partake of a woody nature, and produce side growths, which in their turn prolong the time of flowering, and delight us with their beautiful sweetly scented flowers at midwinter.

(To be continued.)

BELVOIR AND ORTON IN MAY.

"BRITISH GARDENER," in the Journal of 21st ult., challenges me to correct him if he has overdrawn anything in his description of the charming domain of Belvoir. I may at once say there is nothing to correct, for even he, skilful writer as he is, would find it well nigh impossible to give too high praise to what we saw on that perfect spring day. I went to Belvoir expecting to be pleased, I came away enraptured; it is a scene which, to anyone with an eye for the truly beautiful, is worth going many miles to see, but let them not go in the expectation of being able to do the same in their own gardens next spring. No mere copyist could produce such results, it requires the mind and eye of an artist, and years of experience. Not beds on stiffly laid-out lawns, but in delightful dells and openings in the wood. What can be more enchanting than a bed of red flowering Saxifrage, with yellow Tulips dotted among it, or yellow Oxlips, with crimson Tulips rising from them? Then observe the Narcissi growing naturally out of the grass and between rocks, and far surpassing in beautiful effect those planted in the more usual formal border. "British Gardener" has omitted to mention the herbaceous border in the walled garden. Who, after seeing that, would not have an herbaceous border? Its description I must leave to a more skilful pen, for I confess mine is unable to do it adequate justice. Not the least pleasing experience of the day was to have the opportunity of making the acquaintance of Mr. Ingram, whose kindness and courtesy to one who had been previously a stranger to him I gratefully acknowledge.

To pass on to Orton, here again the inexperienced pen of the amateur is fain to confess its inability to adequately describe all he saw. Totally different in style to Belvoir, yet with a beauty all its own, where else are to be seen such Conifers, giant kings of their kind? An avenue of Wellingtonias, nearly a mile long, well nigh half this being in a straight line, the largest rising in majestic grandeur to a height of some 70 feet. Unfortunately, or perhaps it should be said fortunately, the wood of the Wellingtonia is,

Mr. Harding says, too spongy to be of much practical utility, while on the other hand the Californian Redwood (*Sequoia sempervirens*), a fine specimen of which stands on the lawn, is coming more into use year by year, large quantities of it being annually imported from America. He speaks highly of *Thuia gigantea* for ornament and use, and has good reason to do so. Further on we find the *Abies excelsa*, which produces the white wood imported in such immense quantities from Norway and Sweden. There were many other handsome Conifers, including a magnificent *Cupressus lasiocarpa*; a grand pair of *Libocedrus decurrens*; the Nutmeg tree (*Torreya myristica*), preparing for a good crop of its chestnut like fruits; and scores of others the names of which I cannot remember; but I recollect the two gardeners putting their heads rather close together when examining large clumps of the so-called tender Orchid, *Bletia hyacinthina*, established in the open ground, where they passed the winter without protection, and were pushing fresh growths freely.

I must leave the task I have so poorly begun to my friend, "British Gardener," to finish. It is in gardens such as these that the amateur feels how little he really knows and realises what untiring skill and forethought are requisite to conduct them. Mr. Harding is one of those in whose company it is impossible to remain very long without learning something, and the pleasant time spent with him, during which we enjoyed the kind hospitality of himself and Mrs. Harding, will long remain in the memory of one who signs himself only—AN AMATEUR.

DURING my recent visit to Belvoir Mr. Ingram referred with satisfaction to the creditable positions attained by men who had been trained under him in the gardens. From one of them in America he had received the following letter, which he thought might be interesting to some readers of the *Journal of Horticulture*. It will be seen that Philadelphia is ahead of London in the possession of a horticultural hall, described as "large and handsome," and it appears to differ somewhat in character from the building that is projected at home. The letter is evidently written by an intelligent, persevering gardener, and is well worthy of insertion here.

Horticultural Hall, Fairmount Park, Philadelphia, U.S.A.

Mr. Ingram,—Dear Sir,—You may, perhaps, like to hear how I am getting along in this country. In the first place, I must say I have no reason to regret coming so far, although at first I was rather discouraged, being unable to get a suitable position; but through the kindness of my first employer, and my own perseverance, I succeeded in getting to the Horticultural Hall in Fairmount Park, a position which is well suited to me. I have been at the Hall eleven months now, and judging from the confidence placed in me I have every reason to believe I am giving satisfaction. I have always endeavoured to prove myself reliable and trustworthy, and so far with success, thanks for the good instructions in gardening I received at Belvoir, for I assure you I am never at a loss to do anything, and I am trusted with the most particular work in the establishment.

The Horticultural Hall is one of the buildings that were erected for the Centennial Exhibition of 1876, and is very large and handsome. There is a very fine collection of plants, particularly Palms. They are planted out in the borders in the main building, with *Selaginella* covering the whole surface. Joining the main hall are four more houses, two on each side, where the smaller plants are exhibited. They are the temperate, Fern, forcing, and economic houses.

Standing apart are the propagating houses and Resevoir.

The summer bedding here is very fine, the climate being suitable to the development of fine colours in everything, and also to permit us using many plants that are unsuitable to the English climate. We have fine beds of *Crotons* of the best and latest varieties, and very handsome they look. The *Cacti* beds look well too. As regards the softer bedding plants, we have four varieties of *Alternanthera*, five of *Coleus*, *Steris*, *Abutilons*, *Begonias*, *Ageratums*, &c. The beds require constant dressing, as they grow so rapidly. I must not forget to mention the *Cannas*. We have this year those latest dwarf French varieties. They are remarkably pretty. In mixed borders we plant out *Hibiscus*, *Lantanas*, and many other hothouse plants.

This is quite a tropical climate for about three months, the thermometer rising into the nineties most days, and on several occasions past the 100° mark. I have found the heat very trying; in fact, that is my worst trouble, for I dread July and August. A great many people lost their lives last summer, it being the hottest for some time.

We flowered the *Victoria regia* outside last summer, and the *Nymphæas* do well in the Lily ponds. We have *N. alba*, *dentata*, *devoniensis*, *lotus*, *cœrulea*, and *Sturtevanti*; *Nelumbium speciosum*, *Lymnocharis Humboldtii*, *Aponogeton*, *Pontederia crassipes*, &c., all of which require winter protection.

As regards wild flowers, we have some very handsome ones here. I am getting together a small collection of the most showy and rare I can find. But this climate is not suitable for long walks and study after a day's work, for I have not half the energy I had in England; in fact, a person who employs himself to constant study is liable to contract typhoid fever, as the system so soon gets run down. A certain amount of recreation is necessary to everyone.

Amongst the wild flowers I have found a very pretty white *Scilla*,

Erythronium, a little yellow Wood Violet, and a Sisyrinchium, Sanguinaria canadensis, Houstonia cærulea, Impatiens flava, Phytolacca decandra, a dwarf Solanum, Heuchera americana, Osmantaya, Eupatorium, and the lovely Cassia marilandica growing in the woods on the banks of the Schuylkill river; many varieties of Asters, and the lovely Golden Rod (Solidago), which is likely to be adopted the national flower; in fact I have found a great many, and more than I have been able to find the name of.

Rose-growing is a great business in this country. It seems customary among the gardeners the first question to ask, "How are the Roses?" and indeed they are successfully and well grown here, of course I mean under glass. We have a Rose house 100 feet by 22, with about 1000 plants in it, and they produce on an average from 100 to 200 buds per day (ours are for the Park Commissioners). They are planted out in shallow borders in July, and allowed to commence flowering at the end of October, and they keep on more or less till May. Do you know if this plan could be done successfully in England? We have such varieties as La France, Duchess of Albany, American Beauty, W. F. Bennet, Papa Gontier, Niphotos, Madame Hoste, Bride, Perle des Jardins, Sunset, Catherine Mermet. Many people get their living at Rose-growing here, as they are worth from 5 to 30 cents per bud. Some of the florists have acres of Roses.

I visited the Chrysanthemum Show at the Horticultural Hall in Broad Street last November, and they certainly can grow them here, I think, about as fine as they do in England, some varieties being extra good, such as Mrs. Alpheus Hardy, Puritan, L. Canning, Gloriosum, Tokio, Cullingfordi, Mrs. G. W. Childs, &c. Some of the classes are very good. My brother Edward has a small place about three miles from me at Bala, just outside the city limits. He has two houses, kitchen garden, flower beds, lawn, &c., in his care, and is getting along very nicely. He has been there three years in February, so we see each other often. He is very good with Carnations and Roses. He also has a small collection of herbaceous plants from the Boston Botanic Gardens, but people don't appreciate them so much as the more showy florists' flowers, but I think they will soon become more popular, as there are one or two enterprising nurserymen in Germantown growing them rather extensively.

Philadelphia is a large and handsome city. There are very fine buildings everywhere, the finest of which is the City Hall, which has already cost 11,000,000 dol., so you can imagine its greatness. It is much handsomer than St. George's Hall in Liverpool. The Masonic Hall, too, is remarkably handsome. Electricity is very extensively used; nearly all the street, stores, and hotels use it, and the Edison incandescent is in nearly all the wealthy people's houses. It is also used for the locomotion of street cars, both the overhead wire two-battery system; in fact the Americans seem far ahead of the English in many things, although I don't like to own it.—Yours most respectfully, FRANCIS CANNING.

The writer of the above letter is evidently a true Britisher in not liking to own that the English can be beaten, though he has to admit the Americans take the lead in "many things" besides the horticultural hall. It is for him to sustain his reputation as a horticulturist, and at least keep well abreast of his American friends, and he will then be a credit to the Old World and the New.—A BRITISH GARDENER.

CUPRESSUS MACROCARPA.

I FIND that more than 20° of frost damages this fine Conifer very much, and am not at all surprised that "W. L. Somerset," remarks at page 407 regarding its doubtful hardiness. It is stated to be a native of South California, where doubtless the more powerful sun in the summer months thoroughly ripens the young growths, or possibly its habitat may be near the sea coast, where the frost is not so severe. I have never seen a tree of it killed outright by the frost, but the terminal shoots of many of last summer's growths, about a foot in length, seem to have turned brown and dead, giving the trees an unsightly appearance. If anyone living within a few miles of the sea coast in Britain would give their experience it would be a guide to those who wish to plant it near the sea, as it seems a fine tree for shelter.

I fear, however, that not much can be said in its favour as a timber tree. The trunks are knotty, and the wood when sawn through has a very rough and coarse-grained appearance, and is not durable. In 1882 a trunk 2 feet in diameter that was taken down was sawn in sections of about 18 inches in length, to be placed here and there about the grounds and shrubbery walks as rough seats; and although they are still in that position now the wood in many parts can be picked to pieces with the thumb nail. Some English Elm that had been similarly treated two years before is now sound.

After the severe winters of 1879, 1880, and 1881, Cupressus macrocarpa, although not killed, was nevertheless much injured, and the succeeding spring of the latter year from thirty to forty trees here, none of them less than 45 feet high, were grubbed up. They were growing in close proximity to another kind of Conifer, and spoiling them, were also browned very much with frost, so the order was given to root them out. They were most of them of the upright or fastigiata form, and many of them had fair-sized

trunks; but a timber merchant of great experience that I called in to see them said they would be of little value, except perhaps as gate-posts. I could very well see that the wood was not of much value, and as we had cut down a large tree of it on the lawn the year previous, from that I had a very poor opinion of it. The timber merchant, however, bought them at a price, that with the hard wood left and the faggots for kindling purposes, also two years peasticks picked out of the half-dead branches, they about paid for the labour of grubbing them out, a work that took two good men a month, including the cutting up of the branches. It certainly throws plenty of wood useful for fencing purposes and mending hedgerows, but not at all equal to the Oak, Ash, or Elm. These trees are not so easy to grub out as appears on the surface, for the rootstock or stem enlarges very much in the ground. The Wellingtonia is even worse for enlarging below. One tree of it grubbed out a short time since measured at the ground line 11 feet in circumference, but 9 inches below that 15 feet round.

There are two distinct forms of the Cupressus macrocarpa, although the cones from each are exactly alike and the foliage is also similar. The upright, or fastigiata form, appears from about thirty or forty good specimens left here of both sorts, to suffer the most from frost, although the spreading form of it is browned badly in some trees. The upright kind ascends in height more rapidly than the other form. What appears to be the tallest tree, I find on taking the tree measurer to it, is 60 feet in height, with two main trunks about a foot in diameter each at bottom. The spreading form, however, although it does not ascend so rapidly, makes a trunk of finer proportions. On running the tape round at a foot from the ground of one of our finest trunks I find it to be 8 feet 6 inches. It is from 45 to 50 feet in height, and apparently of the same age as the upright form at 60 feet above mentioned. It is a fine specimen, with a spread of branches 36 feet in diameter. As showing the quantity of branches and wood that grow on this Conifer, I may state that this year, three trees near a drive, the bottom branches of which were choking all other evergreens near them, were sawn off at the trunk to the height of 6 feet to let more light and air in, and to get about comfortably under them. From these three trees about a hundred good household faggots were made, besides a large quantity of hard wood. Many of the under branches near the ground were dead, and had been for some time, the others above, being thick and very close together, having smothered them. The green foliage makes a capital Christmas evergreen: nevertheless, I should advise that not too many be planted about a place inland, even if it be extensive, as there are other kinds of North American trees that are more handsome and far hardier:—H., North Hunts.



NEW ORCHIDS.

ORCHID lovers had a floral feast at the Temple Show last Thursday and Friday, and were not at a loss for novelties with which to increase their collections. Never have so many Orchids been shown on one occasion, and very rarely have thirteen been found worthy of awards at one meeting of the Orchid Committee. The members, who acted fully up to their instructions, remorselessly rejected several good plants that did not appear to possess sufficient distinct characters or were not in condition to justify an award. There was certainly no laxity on this occasion, and the Committee was repeatedly nearly equally divided in opinion regarding the novelties submitted. Taking the amateurs' exhibits first, a few words of description may be devoted to those that secured honours from this Committee.

ONCIDIUM LOXENSE.—This was shown by J. Ingram, Esq., of Godalming, and readily obtained a first class certificate, for it is an extremely distinct species. It is a Peruvian Oncidium of the O. macranthum section, and though known for a considerable time it has not been imported alive for the past fifteen years, and there are few plants in Europe at the present time. The flowers are of moderate size, the sepals roundish ovate, pale green transversely striped with brown; the petals are of similar shape, dark brown, the lip is rounded, curiously hollowed, and bright golden yellow. The flowers are borne in long twining racemes like others of the section, and the growth also resembles them.

AERIDES SAVAGEANUM.—This handsome Aerides was shown by Baron Schröder, Sir Trevor Lawrence, and Mr. Sander, and in accordance with the custom of the Royal Horticultural Society a first-class certificate was awarded to each exhibitor, though much

difference was observable in the varieties. The one first selected, that in the Dell collection, was very bright in colour, the flowers dark, clear rosy crimson, with a paler margin. It is a free growing and profuse flowering species from the Philippine Islands, and one of those shown had five racemes.

LÆLIA ELEGANS STATTERIANA.—A charming variety from T. Statter, Esq., Stand Hall, Manchester, who had several other good forms of the same species. It has pure white sepals and petals, a very large expanded lip, creamy white in the centre, with crimson lines, and a rich crimson tip (award of merit).

MASDEVALLIA HARRYANA LUTEO-OCULATA.—One of the Burford Lodge varieties, remarkable for the great size of the flowers, the brilliant colour, and the yellow centre, which brings the tint of the other portion of the flower into great relief.

DENDROBIUM PARISHI ALBENS.—As shown by Messrs. H. Low and Co., to whom the award of merit was adjudged. This is a delicately beautiful variety of *D. Parishii*, with whitish or pale flowers, instead of the dark rose hue which usually distinguishes the species. The plant exhibited had abundant flowers, rather smaller than the type.

CYPRIPEDIUM STONEI MAGNIFICUM.—A variety with large flowers, and much richer markings than are seen in the ordinary

Awards of merit were also granted for *Cypripedium Juno*, a hybrid between *C. Lawrenceanum* and *C. superbiens*, intermediate in floral characters, and combining the chief attractions of both parents; for *C. barbato-superbiens*, the parentage and style of which is indicated in the name; for *Odontoglossum Amesianum*, described and figured in this Journal on page 361, May 7th; and for *Odontoglossum excellens Sanderæ*, one of the finest varieties yet introduced.

To some of the more notable varieties not selected for certificates reference will be made another week. I have also nearly completed a list of all the species, varieties, and hybrids included in the different collections, thanks to the kind assistance of the exhibitors themselves, and I hope to give some statistics with further notes on those represented.—L. CASTLE.

FRUIT FARMS IN COLORADO.

As an Englishman, who came to Denver, Colorado, nearly eight years ago, I frequently receive inquiries from England from people who contemplate emigrating, and are therefore desirous of obtaining reliable information about various countries, as to what opportunities this State presents to the English emigrant, more



FIG. 83.—MAXILLARIA SANDERIANA. (See page 450).

form of *C. Stonei*. It was shown by Messrs. Heath & Son, Cheltenham.

CATTLEYA HYBRIDA PRINCE OF WALES.—This and the remaining Orchids were from Messrs. Sander & Co. It is said to be the result of a cross between the white *Cattleya Mossiæ Wagneri* and *Lælia elegans*; but *C. calummata* has also been assigned as one of its parents. The plant shows characters that might be considered intermediate between the first two; but whatever its parentage, there is no question that it is a delightful and valuable seedling. The sepals and petals are pure white, as also is the lip, with the exception of a series of pale rose veins in the centre, and a finely frilled margin (first-class certificate).

CATTLEYA HYBRIDA LOWRYANA.—Somewhat in the way of a fine *C. intermedia*, the sepals and petals solid white of great substance, the central lobe of the lip only being a peculiar bluish mauve or purple tint (first-class certificate).

MASDEVALLIA HYBRIDA MUNDYANA.—This is described as the result of a cross between *M. ignea* and *M. Veitchiana*, and is undoubtedly a fine addition to the limited number of hybrid *Masdevallias*. The flowers are of great size and excellent shape, the colour brilliant orange (first class certificate).

GRAMMATOPHYLLUM MEASURESIANUM.—An extraordinary Orchid, with racemes four or five high, erect, with large greenish-white flowers, the sepals and petals burred or spotted with a bright shade of chocolate brown, and heavily tipped with the same colour (first class certificate).

particularly in fruit growing. To those of your readers who desire such information the following will be interesting.

Colorado is a comparatively new State, dating from the Pike's Peak gold excitement in 1859, and many people at a distance are yet under the impression that Colorado produces little else besides minerals. It will, therefore, surprise them to know that for 1890 the estimated value of the farm products of Colorado was 45,000,000 dols., while the value of the gold, silver, lead, and copper output of the State was 30,000,000 dols. Years ago it was practically demonstrated that Colorado was especially suited by location, altitude, soil, and climate to the growth of Apples, Pears, Plums, Cherries, and on the Western or Pacific slope of the Rocky Mountains of Peaches, Apricots, Nectarines, Grapes, &c. The success of the early orchards and vineyards and the high prices which fruit commands in the local markets have led to a very great amount of fruit tree planting within the last few years. In the spring of 1890 it was estimated that more land was planted with orchards in Colorado than in all the preceding years of the history of the State, and the planting of the present spring will equal, if not exceed, that of 1890. The fact is, that the American people, as a nation, are great fruit consumers; in Colorado the local supply has never been able to overtake the local demand, nor does it seem likely to do so, and large quantities of fresh fruit are obtained from California, Missouri, and Texas, which in the nature of things, by reason of being gathered before fully ripe, after its long journey does not equal the Colorado fruit in quality and flavour. More-

over, the local market is particularly good from the fact that one-third of the population of the State is engaged in mining at from 7000 feet to over 11,000 feet above sea level, where gardening is out of the question, while another third is resident in cities. This state of things seems more likely to increase than otherwise, and hence the good prospects for local fruit farms.

The following items will also be interesting to English readers:—The man who planted the first Apple tree in Colorado in 1863 was William Lee, a native of Surrey, now residing about four miles from Golden in Jefferson County, Colorado. He carted his first Apple trees over 600 miles across the plains from the nearest nursery before the railroads were built. One of the most successful fruit growers and market gardeners at Boulder City about thirty miles from Denver, is John Brierley, a Lancashire man. In the town of Colorado Springs, William Bush, baker, an Englishman (I do not know what county he comes from) has a garden 150 feet long by 100 feet wide. A few years ago he read a paper on fruit growing before the State Horticultural Society, showing that his garden contained seventeen Apple trees, seven Cherry trees, six Pear trees, four Plum trees, 100 Gooseberry and 100 Currant bushes, and several Grape Vines, while two-thirds of the ground was planted with Strawberries. From this small town garden he took in one season 640 quarts of Strawberries, 500 quarts of Currants, and 400 quarts of Gooseberries, exclusive of what was consumed by the family. At Wheatridge, four miles from Denver, one of the finest orchards is that of David Brothers, formerly farmers in Suffolk. At Canon City, in Fremont County, John Gravestock from Hertfordshire, has a fine orchard and vineyard and nursery stock. So other Englishmen throughout the State might be mentioned who have had years of local experience in fruit growing and could be consulted by any emigrant.

The proper way for a practical man with capital, more or less, is to come out to Colorado and see for himself, buying nothing until he has looked round thoroughly. He will learn more and realise it better by seeing than he possibly can from reading about it. On the eastern side of the Rocky Mountains in Colorado at various places, and more particularly at Canon City and vicinity, he could see numerous fine young orchards. At Canon City, Judge W. B. Felton, a friend of mine, has a ten-acre orchard and fruit farm, the first stock of which was planted in May, 1881, yet in 1889 he cleared from the ten acres, after paying all expenses, over 3600 dols.—that is, more than £70 sterling per acre, his Apples alone from 5½ acres amounting to 4750 bushels, which sold for over £800. A visitor on the western slope in Montrose, Mesa, and Delta counties, particularly in the valley of the Grand River, can see stone fruit and Grapes to perfection in orchards of from five acres to 160 acres in extent. For instance, among the newer orchards Messrs. Hughes & Rose four years ago planted 13,000 Peach trees on 160 acres of land, which it is anticipated will yield this season from present appearances 60,000 boxes of Peaches, worth gathered in the orchard 3s. per box. It is a well recognised fact that ten acres of Apple or Peach trees in Colorado will pay much better than ten acres of Oranges either in Florida or California.

Land suitable for fruit growing can be obtained on reasonable terms in various parts of Colorado, which existing orchards prove to be suitable for the purpose, and of course an Englishman coming here should look all round and satisfy himself before locating. I have just returned from a visit to a district about to be laid out in orchards, particulars of which will doubtless be interesting to your readers as illustrating how things are sometimes done here, and how an industrious, enterprising, and practical man can make a start even on a small capital. I may say that I am in no way personally interested in the property except as a possible purchaser of a small portion of it. On the north bank of the Grand River in Garfield county, about sixty-five miles above the town of Grand Junction (already celebrated for its Peach orchards), is Grass Valley, containing about 15,000 acres, with a gentle slope to the south, and protected from the north, west, and east by cliffs and hills; in fact, a sheltered nook among the mountains, and the beau ideal of an orchard site. The soil is a fine alluvial deposit of great richness and depth, rich in gypsum, lime carbonates, and oxide of iron. In colour it is part a dark brown and in part a red colour, such as produces in California and Colorado the largest crops of fruit. The trans-continental railroads, the Denver and Rio Grande, and the Colorado Midland from Denver to Salt Lake city, traverse the valley with frequent trains, and the local station is called Antlers, as the district yet abounds in deer, and antlers are common. A company has built an irrigating canal, twenty-one miles long, conducting an abundant supply of water from a mountain stream, so as to make 15,000 acres of the valley land capable of cultivation, as is the rule all over Colorado, where sunshine is nearly perpetual, the rainfall being only about 14 inches per annum. In Colorado we do not simply go to church and pray for rain for the crops, then do nothing; but also go to the irrigating

ditch and turn the water on from the mountain streams, which are supplied from streams and melting snows.

The company has a 1000 acres farm on which this year they are sowing or planting 300 acres of Oats, 100 acres of Wheat, 100 acres of Indian Corn, 40 acres of Potatoes, 3 acres Onions, 60 acres Navy Beans, 5 acres of Hops, 20 acres of miscellaneous stuff such as Melons, Tomatoes, Celery, &c.; also planting nearly 20,000 fruit trees, exclusive of Grape Vines, small fruits, shade trees, and 20,000 Apple root grafts. Outside their own farm the Company has already sold this season about thirty small orchard tracts, ranging from 5 to 15 acres each at from 50 dols. to 75 dols. per acre, all ploughed and ready to receive a crop or trees. As some people are not prepared at once to go and live there, the Company for 200 dols. per acre sell a 10 acre or larger tract, fenced, planted with eighty-four fruit trees to the acre of standard varieties of Apple, Pear, Peach, Plum, Apricot, and Cherry, cultivate and care for the same for three years, guaranteeing at the end of that term 90 per cent. if the trees shall be living and flourishing. Even this 200 dols. per acre does not have to be paid at once, but can be paid by easy instalments, without interest. The Company, on its own orchard land and on the land sold in small orchard tracts, plants this spring over 25,000 trees, and other land owners in the valley are planting about 20,000. While I was there two Frenchmen from Normandy, who have bought 10 acres from the Company, ordered 800 fruit trees and 2000 Grape Vines. The Company has also laid out 40 acres close to the railroad station, as a town site to be called "Antlers," in the centre of which is a public square on which all shops will face. No lots in the town site are sold except to those who will at once build houses, and every deed contains a clause against the sale of intoxicating liquor. A per-centage of the price of every acre of land sold by the Company will be appropriated for the establishment of a public library in the town. As this town and valley are on the main line of railroad, within easy range of the rising watering place of Glenwood Springs, and of the great mining cities and districts of Leadville and Aspen, it is easy to see that Grass Valley has a great future before it. I may also mention that not many miles up the valley of the Grand from Antlers are stations on the railroad called Newcastle and Cardiff, so named on account of the vast local deposits of coking, anthracite, and other coal, which are only just commencing to be worked to any extent. There are also in the same neighbourhood large bodies of iron ore, slate, marble, &c., which, with the coal before mentioned, are certain to result in the location of a considerable manufacturing population at no distant date. Just above Antlers in the Foot Hills I went up to where coal crops out of the ground and farmers go there and simply fill their waggons with a spade as at a wharf.

In Colorado Wheat yields 20 to 50 bushels per acre; Barley, 40 to 90; Oats, 30 to 75; Peas, 30 to 60; Potatoes, 100 to 400; Cabbages, from 10 to 35 lbs. each, and often 50,000 lbs. to the acre. Upwards of 1000 bushels of Onions (field culture) have been produced to the acre, and sold at 5s. per 100 lbs. One man got 500 dols. per acre on pickling Onions. Cauliflowers are grown 15 inches in diameter. Celery makes wonderful crops, and Grapes 15 tons to the acre. Tomatoes produce 12 tons to the acre; Carrots, 1000 bushels to the acre, and so on.

The schedule of prices which prevailed during 1890 was as follows:—Strawberries, from 15 cents. to 20 cents. per quart; Peaches, Pears, Plums, Apples and Grapes (averaged) 10 cents. per lb.; Cherries, 15 cents. per lb.; Oats, 60 cents. per bushel; Wheat, 1 dol. 20 cents. per bushel; Indian Corn, 80 cents. per bushel; Timothy, 15 dols. per ton; upland wild grass, 15 dols. per ton; Alfalfa or Lucerne, 8 dols. 50 cents. per ton; Potatoes, 90 cents. per bushel; Cabbage, Onions, &c., 2 cents. per lb.

In the older portions of the State orchard lands, in bearing, are held at from 700 to 1000 dols. per acre, while unimproved lands adapted to fruit culture, are held at from 100 to 150 dols. per acre.

In conclusion, such places as Grass Valley are well worth personal investigation by the right sort of men, and if any such come from England to Denver and will call on me, I will give them introductions to different successful fruit growers, which will ensure their having a good insight into "Fruit farming in Colorado." The Editor has my address.—THOMAS TONGE (formerly of Manchester, England).

WASPS.

A CORRESPONDENT gave a word of warning in the Journal of May 21st, page 407, as to the unusual number of queen wasps which appear to have been abroad lately, and he advises a can of water and syringe to be always about, so as to damp the wings of the wasps and render capture easy.

In a very large garden, however, something more than this must be done, and remembering the old adage that "a stitch in time saves nine,"

it will be wisest to start operations at once against the wasps, for it strikes me we shall have a plague of them this year. I know that at Patshull, near Wolverhampton, the seat of the Earl of Dartmouth, Mr. Farr is up in arms already against the enemy, such a large number of wasps having already appeared in the gardens there, and he pays 1s. per dozen for every wasp killed in the garden, not out of it. I was much struck last year with a simple and inexpensive glass trap I saw at Patshull, which answered so excellently as a wasp trap that I have written to him to send one on to you, for I think no greater boon can be conferred just now than information as to a cheap and efficacious method of dealing with the wasp nuisance, and to be ready for operations before much mischief has been done—in fact, before the crops are ready for destruction. Mr. Farr first noticed wasps about in the month of February, three or four were caught in the Pine stove or early Peach house, but in the latter part of April, on examining fruit crops on a south wall, he was surprised to find a quantity of wasps about, and at once set to work to destroy them. They were most numerous of an evening, and to capture a queen was good work. Up to the 21st May



FIG. 84.—WASP TRAP.

about 250 wasps had been caught, but the Patshull gardens inside the walls are eight acres in extent, and contain several glass houses, so that wasp catching requires to be dealt with on a large scale.

Mr. Farr uses extensively the glass trap, of which he sends you a sample. These cost 4s. 6d. per dozen, and treacle and water are used and found to answer better than beer. These glass traps stand upon three short legs, and rough stands can be easily knocked together by any labouring man on which the trap is placed. Three stakes form with the top a tripod, on which the trap is placed; they can be moved at pleasure, and at various heights as required. The traps are so constructed that they are easy of access to the wasps, but not so easy to escape from, and can easily be emptied. Mr. Farr remarks in a letter to me, "I have no hesitation in saying they are the best traps I ever saw or used." The trap (fig. 84) is about 6 inches in diameter.—W. D.

THE WEATHER AND THE CROPS.

MAY I venture a few remarks upon the past and present prospects of the hardy fruit crop for 1891? Well, let me begin at the beginning, and say that, as in most things, before we can hope for any great measure of success we must lay a good foundation, and in the case of the fruit trees this was well laid in the fine autumnal weather we had last year, which ripened the wood thoroughly, enabled it to endure the exceptionally severe winter without injury, and to develop an enormous quantity of blossom buds, which during the fine weather of February swelled up and gave promise of an abundant display of bloom in due season. Then came March, ushered in according to the old proverb, "like a lion," but instead of going out "like a lamb" he continued to roar throughout the whole month, and so infected April with his cold, rough, and blustering manner that the month of showers followed suit, and, the contagion becoming general, May in turn was smitten with the cold, and though she has once or twice tried to deck her bowers and smile upon us, it has only been in a half-hearted sort of way, and the consequence of it all is, that we have a remarkably cold and backward spring, and trying though it has been both to plant and animal life, those of us who try to gather consolation and extract a modicum of good out of adversity began to indulge in the hope that all the bad weather would be forgotten amidst the abundance of fruit which a backward spring is supposed to give us. Nor can anyone blame us for indulging in this, for it is but reasonable to suppose that the longer the blossoming is retarded the less likelihood there is of its injury by frosts? but we have relied on a broken reed this time, and Jack Frost has let us know that however late the blossoming may be he can be still later, and all our hopes have been scattered to the winds, or rather to the snows. It is most disheartening this year when the promise was so great and the realisation, as it were, almost within our grasp. More especially is it to be regretted after all the encourage-

ment which has been shown and the impetus given to the cultivation of our hardy fruits; but we must not be cast down by one disaster, but rather let it stimulate us to renewed exertions and "at it again," for perhaps after all our young trees will be all the better for not carrying too heavy a crop.

But I am leaving the main line, and may find myself shunted on to a "siding" if I do not hark back to the weather, for it is on the effects of the late severe frosts that I sat down to write about, and I need not go into particulars in regard to it, as it seems to have been almost general throughout the country. I will only say we had from 10° to 15°. We had a heavy fall of snow and hail, which cut the tender leaves to shreds. It was a spell of arctic winter long to be remembered. My first impulse was to go to the garden, and the sight was one not easily to be forgotten. The Asparagus beds, which had a fine healthy growth of young shoots, had completely collapsed, the Potato tops had disappeared, and the Apple and Pear blossom had strangely altered in colour; the Beech hedge was brown, and the effects of the severe frost everywhere apparent. Let me particularise a few of the worst cases.

Strawberries.—Laxton's Noble, an early bloomer and very tender, with little foliage to protect it, has severely suffered. Not only are the open flowers killed, but the unopened ones likewise. The precocity of flowering in this kind will be much against it. "Marguerite," another early bloomer, with little foliage to help it, has also suffered much; not much harm was done to others, and none to such good old sorts as Keens' Seedling, Black Prince, &c. I may state that where young plantations are relied on they will have suffered, because young plants mean early flowers, and these have "caught it" and no mistake.

Plums, which had a few really good "setting" days, and were fast going out of bloom, will, it is to be feared, be much injured, probably three-fourths destroyed; and the same may be said of all stone fruits, for though the Peaches were well set, the frost was severe enough to have frozen them through and through, and likely enough did so.

Pears caught just at the critical time here, and as the blossoming is of short duration—i.e., the flowers open nearly all together, I fear, as a general rule, the crop is "done for." There are a few varieties which extend their time of flowering, as the Hessle, Beurré Diel, Doyenné d'Été, &c., and a few late bloomers as Doyenné du Comice, &c., which may with genial weather have a fair crop.

Apples.—These are much injured, but fortunately were not in full bloom except a few early flowering kinds; and be it remembered that early ripening does not always mean early flowering, nor the reverse. Well, all expanded flowers are utterly killed, and most of the unexpanded ones too—that is, all those which were so far forward as to have but one covering of petals. I am glad to say that the more backward flowers in which the delicate organs were less fully developed seem safe, and it is to be hoped will give us a fair crop of fruit. I made a note of the early and late flowering kinds, and am glad to say some of our best sorts, such as Cox's Orange Pippin, are late bloomers.

The bush fruits are much damaged, notwithstanding the extent of foliage, and full crops must not be expected. I cannot close without saying how much I sympathise with all that so bright a prospect of an abundant harvest of all our hardy fruits has been so suddenly and completely destroyed.—F. BOYES.



EVENTS OF THE WEEK.—On Saturday next, June 6th, the Royal National Tulip Society will hold their annual Exhibition in the Botanic Gardens, Old Trafford, Manchester, the Show having been postponed, as announced last week, from May 30th. It is hoped the display will be a good one, but the season has been most adverse. The Royal Horticultural Society's Fruit, Floral, and Orchid Committees will meet at the Drill Hall, James Street, on Tuesday, June 9th, when classes with medals and money prizes open to amateurs will be provided for twelve Rhododendrons, twelve cut trusses of Orchid flowers, twelve specimen Orchids, and a silver-gilt Flora medal for the best seedling Orchid (open). The Kelway medal is also offered for six single and six double Pyrethrums, three blooms of each, and a lecture on alpine plants will be given by the Rev. C. Wolley-Dod, M.A., at the general meeting in the afternoon.

— THE WEATHER IN THE SOUTH has been dull and warm during the past week, with occasional thunderstorms and much rain. In London on Saturday morning a remarkable darkness, due to the dense mist overhead, lasted for several hours, rivalling the worst of November experiences. In some localities hail is said to have caused much damage, and one Chrysanthemum grower says his plants "have been nearly stripped of their leaves, those remaining being reduced to shreds."

— NATIONAL CHRYSANTHEMUM SOCIETY.—The usual summer outing of the members of the above Society will this season take the form of a visit to Ascott Park, Leighton Buzzard, the charming Buckinghamshire residence of Leopold de Rothschild, Esq., one of the Vice-Presidents of the Society. The usual time for the outing is the last week in July, but the date cannot be definitely fixed for a few days. Meanwhile the arrangements for the annual trip are being made by the Secretary, Mr. Richard Dean, who will shortly communicate with the members. Ascott Park is a place full of interest, and the surroundings of a delightful character. An illustration and description of Ascott Gardens were given in the *Journal of Horticulture*, page 105, Feb. 5th this year, and the Carnations were described, page 439, Nov. 20th, 1890.

— ROYAL BOTANIC SOCIETY OF LONDON.—Professor Stewart, President of the Linnean Society, delivered at the Gardens last Friday the first of two lectures upon the "Relationship Between Certain Plants and Animals," dealing more particularly with the association for mutual assistance occurring between plants and insects, and in which the advantages to be derived from it are so equally divided that it is difficult to find out its origin. Notably has this been the case with a plant belonging to the Madder order, growing in Borneo. Upon its stem it produces hollow nest-like swellings, and these form the homes of three different kinds of ants, which live amicably together, but turn out and attack in crowds any living thing touching the plant; and as these ants can both bite and sting the plant flourishes without fear of molestation from man or beast.

— IN REFERENCE TO EXHIBITING GRAPES AT THE EDINBURGH INTERNATIONAL SHOW, Mr. Witherspoon of the Red Rose Nurseries, Chester-le-Street, wrote at page 407, stating some difficulties. He now writes to this effect:—"The Secretary has very kindly written to say that I am eligible to compete in all classes open to gardeners and amateurs. I am very glad that I have this news to send, as for some time I have determined to show at the International. This will be an interesting season regarding outside fruit crops, as the hardy constitution of varieties will have been seriously tested."

— WEATHER AT LIVERPOOL.—As I write the weather here is much improved, and the temperature much higher; but it is only within the last two days that the improvement has taken place. All last week we had heavy rains, and nearly every day the sky was overcast with dark clouds. On Thursday afternoon a smart hailstorm visited us a little after 3 P.M., and one of much more severity which lasted for five minutes, presented itself at 8 A.M. Night temperatures: 25th, 36°; 26th, 32°; 27th, 37°; 28th, 32°; 29th, 38°; 30th, 38°; 31st, 37°.—R. P. R.

— GARDEN PROSPECTS IN MUNSTER.—My gardening friends of England and Scotland have many advantages, natural and acquired, over us in the Emerald Isle; but in one respect—our climate—we are more fortunate than either. On several mornings, notably that of the 18th May, I must confess I went out to my garden with a considerable amount of trepidation. I generally took a first look at my early Potatoes—Myatt's, Ashtop Fluke, Kiltinan Kidney (local), and Seven Weeks that I am calculating to have fit for use in mid-June, and am proud to say so far they have escaped untouched. Cherries, Gooseberries, and Strawberries are also perfectly safe, but I cannot say the same of Plums and Pears. This may, however, be owing in my case to most of my trees being only planted last October rather than to the weather. Although the temperature is under the average the present moist weather presages a plentiful season in Ireland.—W. J. MURPHY, *Clonmel*.

— BLACK CURRANT MITE PARASITE.—On reading the "Interesting Discovery" at page 434, I was anxious to make further research in the matter. I procured some buds for examination. The first bud I selected under a small lens showed some silky-looking material betraying the presence of a caterpillar, and on removing one of the scales of the bud I discovered a caterpillar with brown head and feet. It measures nearly a quarter inch long; it is visible on glass to the naked eye, and does not require a strong power to see it. I enclose it herewith roughly mounted on glass, and the bud which shows the galleries of the caterpillar, so that it is easy to determine whether the mites have been consumed by the caterpillar. Its movements resemble the looper moth caterpillar, and every time I touched it with an instrument or finger it immediately threw out a silken thread and suspended itself to whatever touched it.—WM. THOMSON. [The specimen received fully illustrates our correspondent's remarks.]

— We are desired to state that the ELTHAM ROSE AND HORTICULTURAL ASSOCIATION'S annual Exhibition has been postponed until July 11th.

— THE EFFECTS OF ADVERTISING.—We are requested to state that since he commenced advertising the trade of Mr. William Cooper has increased enormously, and he has again to enlarge his premises. During the twelve months ending March 31st 2149 houses were dispatched to various parts of Great Britain, Ireland, France, and Africa.

— SUCCESSFUL CALCEOLARIA CULTURE.—Without doubt the finest Calceolarias it has ever been my lot to see are at present flowering at The Hollies, Woolton, the residence of Thomas Brocklebank, Esq. Having heard from several friends of the merit of the Calceolarias I called on Mr. Vaughan, the gardener. The plants, numbering forty to fifty, were arranged on the side stage of the conservatory. A few of the plants are grown in 9-inch pots, and if they could be staked out to their full dimensions would measure many of them 3 feet 6 through, whilst in one or two instances 4 feet would be the correct measurement. The remainder of the plants are grown in 5 and 6-inch pots, and have heads measuring from 18 inches to 2 feet 6. The strain is Messrs. Ker's, Aigburth Nursery, and present nearly every shade of colour. Asked how he managed to secure such clean healthy plants, Mr. Vaughan replied that he sowed the seed at the present time last year, and grew the plants as cool as possible. Careful watering and using the syringe twice a day, are the means attained to bring about such excellent results, and Mr. Vaughan is to be complimented on such successful culture.—R. P. R.

— NARCISSUS MAXIMUS FROM SPAIN.—Mr. Hartland might have seen from my first note on this matter that I did not write with a view to what he calls controversy, but simply to ask him, as a favour to those who desire only accurate facts to be recorded concerning the geographical distribution of the Narcissi, not to speak with certainty where he cannot have certain knowledge. What is certain in the matter under discussion is this, that these Pyrenean collectors and dealers have over and over again made untrue statements as to the origin of the bulbs which they sell. There is also considerable evidence that garden bulbs have been sent out by them as collected. But Mr. Hartland knows that I spoke as being quite uncertain myself, and admitted the possibility of *N. maximus* being Spanish, deprecating only the air of certainty which appeared in Mr. Hartland's first note. As to the pale *maximus*-like flowers, I am familiar with them. My friend, Mr. Wolley Dod, has obtained them from the Pyrenean district—not, however, from the Spanish side—and has more than once exhibited very fine samples at the R.H.S. meetings. I have some in my own garden.—G. H. ENGLEHEART.

— PLANTS IN FERTILISED MOSS.—It is doubtful if the merits of fertilised moss are sufficiently recognised among plant growers generally, but more would commence using it if they were fully aware what remarkable results can be achieved with its aid. Captain Thomson, Port View, Exeter, has been particularly successful with it, the material used being fertilised by his own process, and which cannot here be described. His plants of *Maréchal Niel* Rose rooting solely in this moss, confined in comparatively small pots, were wonderfully floriferous this spring, the foliage being large, clean, and healthy, and the blooms fine and richly coloured. One plant in a 9-inch pot produced sixty blooms, and several others did nearly or quite as well. For house decoration Roses rooting in fertilised moss only are particularly serviceable, as they can have a soaking of water prior to being turned out of pots and suspended or trailed about in various fashions. Captain Thomson also grows *Gloxinias*, *Tuberous Begonias*, and a variety of other plants solely in moss, and the growth is most satisfactory. Mixed freely with compost, fertilised moss serves to keep it porous and sweet, and the plants evidently derive much benefit from its presence in the soil, none more so than *Bouvardias*.—W. I.

— WE are informed that Kew has recently acquired by purchase from Mr. F. Curtis, a descendant of William Curtis, the founder of the "BOTANICAL MAGAZINE," about 1650 original drawings, chiefly of figures which appeared in that publication. They belong partly to the first series and partly to the second, from 1800 to 1826—that is to say, during the period that the magazine was edited by Dr. Sims. Many of these drawings are very beautiful, and very carefully coloured, especially those done by James Sowerby and Sydenham Edwards; but some of the finest of their work was not reproduced in the plates. The collection also includes some of the poorest work that ever appeared in the magazine. In 1815 Sydenham Edwards seceded, and worked for the

rival "Botanical Register;" Sowerby had ceased contributing, and there seems to have been a lack of novelties for illustration. Towards the end of Dr. Sims's editorship, in 1826, the "Botanical Magazine" was doubtless supplanted in a great measure by the "Botanical Register" then conducted by the vigorous Lindley. Its circulation greatly decreased, and the impression was small; hence this series is very rare. The following year, however, Sir William Hooker became editor, and speedily raised both the artistic and botanical character of the magazine. Many of the plates published during the latter half of Dr. Sims's editorship are not signed, but all the drawings are, and we learn that William Hooker, the artist of the "Paradisus Londinensis," was an occasional contributor. The collection also contains a number of unpublished drawings.—(*Nature*.)

— THE value of the sweet-scented and one-flowering *CHOISYA TERNATA* is well known, and it is extensively grown in pots, but few are acquainted with its great usefulness for covering walls in sheltered positions in the open air. A robust healthy specimen is growing against Warwick Castle walls, and has passed through the late severe winter unscathed. It is planted in the natural soil, which is light and well drained, and evidently suits the subject under notice. The position is a sunny one, but thoroughly exposed to south-east winds. This should be a convincing proof of its hardiness when grown in similar positions; and but few hardy shrubs produce flowers that are so choice and fragrant and suitable for making up into sprays and buttonholes. The plant growing here is at the present time in full beauty.

— PROFUSELY flowered specimens of *BERBERIS DARWINI* and *B. DULCIS* form objects of great beauty on lawns and in shrubberies, but in order to show off their beauty to the best advantage they should, when planted among other shrubs, stand well clear of them, otherwise the graceful arching branches are not seen under favourable conditions. This remark applies especially to the latter, which I prefer on account of its freedom of growth, while others award the palm to *B. Darwini* on account of the rich orange yellow of the flowers. Both should be grown where flowering shrubs suitable for arranging in glasses are in request. At the present time effective arrangements may be made by associating flowering branches of the common Lilac with these *Berberises* when placed in tall trumpet-shaped glasses.—H. DUNKIN, *The Gardens, Warwick Castle*.

MR. F. SANDER.

ORCHIDS have been so closely associated with Mr. Sander's name for some years, and the group contributed by his firm at the Temple Show last week was of such an exceptional character, that many readers will welcome the portrait (page 451) of one who has taken so prominent a place in the horticultural world.

Mr. F. Sander was born in Bremen in 1847, and commenced his horticultural career early in life as an apprentice at Erfurt, subsequently proceeding to the firm of Messrs. Peter Smith & Co. at Hamburg. He came to England at the age of eighteen, and entered the nurseries of Messrs. Carter & Co., Forest Hill, where he remained for about six years, and succeeded in raising several new plants, besides gaining some experience with Orchids, of which at that time a good collection was grown at Forest Hill.

During the later years of his engagement with Messrs. Carter & Co. Mr. Sander was appointed agent for the remarkable traveller Roezl, and this was the commencement of the Orchid importing business, which was subsequently so largely developed. A short time afterwards he also became agent for Endres and Wallis, both experienced travellers, and to these three men Mr. Sander owes very much, for not only did they send large quantities of plants, but invaluable information was gained respecting the habitats of Orchids, the modes of packing, and transportation to the sea coast that could not have been otherwise obtained except at the cost of considerable labour and expense—in fact, it would have been almost impossible for one man to have secured such knowledge in any other way.

In 1872 the old establishment in the town of St. Albans was taken, and a consignment of 150,000 Mexican Orchids from Roezl filled every available space. The glass houses not being finished they were piled up in the warehouse, huge heaps of *Oncidium tigrinum*, *Odontoglossum Cervantesi*, *O. Insleayi*, and *Epidendrum vitellinum majus* being the great features. It is even said that Potatoes were hurriedly lifted from the ground and Orchids laid in their places. This was practically the commencement of Orchid importing on a large and organised scale, and the financial success which attended speedily led to an extension of the business, until as many as twenty-two travellers were engaged at one time in exploring every tropical country where Orchids grow. In one year 400,000 plants of *Odontoglossum crispum* were imported, and the total of all Orchids for that year including living and dead plants was about a million. But as an example of the failures that always attend great enterprises, it is said that in the same space of time £5000 worth of Orchids have been lost through death during transit, accidents, and

various causes. In less than twenty years, however, about 200 new species or previously rare plants have been introduced to this country.

The new establishment at St. Albans was commenced in 1883, and 4 acres are now entirely covered with glass houses devoted exclusively to Orchids, while eleven new houses are in course of construction for seedlings. Raising seedling Orchids was commenced in 1875, and has been continued ever since, with the result that large numbers of crosses have been secured, and something novel and good is constantly appearing.

The elaborate illustrated work on Orchids, the "Reichenbachia," was founded in 1886, and about 100 plates have now appeared. The late Professor Reichenbach contributed the descriptions and botanical analyses to the earlier numbers of this work, and continued doing so until his death. It may be remarked that the letterpress is entirely composed and printed on the premises at St. Albans, which, besides printing offices, includes extensive store houses, potting departments, stables, and all the necessary adjuncts of such an establishment.

Amongst Mr. Sander's public feats it may be recorded that he had the honour of preparing a bouquet of Orchids for presentation to Her Majesty the Queen at Buckingham Palace on the occasion of her Jubilee; he secured the highest award in the exhibition at Dresden in 1887, the Grand Prix at Paris in 1888, the Prix d'Honneur at the same place in 1890, and several silver cups at the Temple Show, London.

Mr. Sander's energy, enterprise, and foresight, combined with a remarkable constitution, have enabled him to accomplish great results in a comparatively short period, but his uniform courtesy and geniality have also gained him many influential friends, to whose ready assistance he modestly attributes a large share of the astonishing success which has attended his career.

THE TEMPLE SHOW.

MAY 28TH AND 29TH.

IN our preliminary notice last week of the Royal Horticultural Society's fourth annual Exhibition in the Temple Gardens we briefly sketched the chief features of a wonderful floral display and promised fuller details for the present issue. These we will now attempt to furnish, that many of our readers who were unable to attend the Show in question may be able to form some idea of the remarkable assemblage of plants provided.

Before, however, referring to the exhibits individually it will be desirable to recapitulate the general method of arrangement adopted and the leading characteristics. Here it must be remarked that throughout the larger exhibits suffered from the space being insufficient to meet the increased demands, and this, too, although more tent accommodation had been provided. No limits to groups or collections were given in the synoptical schedule issued, and the result was that the majority of the exhibitors generously endeavoured to help the Society to the full extent of their power, with the undesirable result that some had to be considerably restricted. This was one defect of the Show, and where there was so much to admire it is well to notice this first, and it must also be said in justice to Mr. A. F. Barron and his willing assistants that every effort was made to minimise the difficulties which arose in consequence of the exhibitors' requirements far exceeding the space at disposal. A most unenviable task it was to apportion space and positions to large exhibitors all naturally desiring the best places and possessing equal claims to attention. That it was performed with such general satisfaction is a sufficient proof of the care exercised, the judgment and experience brought to bear upon a matter bristling with difficulties which few could understand except those actually concerned. It is not easy to suggest a remedy for this state of affairs, but it seems clear that it will be necessary to provide several classes for groups and to define accurately what is required and the space that shall not be exceeded except by special arrangement. Another matter also requires attention, and that is to place the greatest attractions where the most path space is at command, for dangerous crowding occurred in some instances on the two days, which caused certain valuable exhibits to be unavoidably damaged. It was reasonably thought that dividing the principal exhibits would tend to obviate any such result as this, but unfortunately it did not have the full effect anticipated.

Having disposed of these little matters we turn to the features of the Show, which, as was said last week, has never been equalled in the City of London, and this opinion was amply confirmed by the freely expressed admiration of the numerous visitors. The tents were so conveniently arranged that a complete tour of the Exhibition could be taken without passing outside, and had the weather proved very unfavourable this would have been a great advantage, and in any case it was a wise precaution, as the prospects on the preceding days were not encouraging. Happily, however, though rather unsettled, with occasional showers and much wind, the weather proved fairly fine and comparatively warm on both days. The first tent was the long, rather narrow one which has been seen at several of the R.H.S. Shows; it is 170 feet long and 30 feet wide, and contained a variety of interesting exhibits, hardy flowers and Ferns predominating, a suitable introduction to the more imposing contributions in succeeding tents. Next followed one 140 feet long and 40 feet wide, the centre portion of which was filled with nurserymen's groups of Orchids, and the side stages with brilliant *Begonias*, *Pelargoniums*, and other plants. Then we came to the great marquee 160 feet long and 60 feet wide, a magnificent lofty structure, where again the central stage was occupied with amateurs' collections of Orchids, while around the sides upon the fresh green turf were the glorious *Roses*, stately foliage plants, and various tasteful groups each

possessing some special merit. The last tent of the series contained the miscellaneous exhibits, the fruit, which was more largely represented, and of a more interesting character than might have been expected at this time of year and in such a season. There were also cut flowers and floral decorations, besides various implements, models, and horticultural sundries, giving a rather more comprehensive character to the Show than has hitherto been the case.

Much credit is due to both exhibitors and Superintendent for the promptitude with which the arrangements were completed without confusion or trouble of any kind. The positions were all marked out the night before the Show; the exhibits mostly came in good time, and it was astonishing what a magical change was effected in a few hours of well-regulated hard work, and all was ready for the Judges by the appointed time—10.45 A.M. Although not a competitive show in the true sense of the term, silver cups and medals were offered by the Council, and these had to be awarded to the exhibits in the order of merit. The Judges selected for performing this task were as follows:—Orchids and fine-foliage plants, Messrs. H. J. Veitch, James O'Brien, and Lewis Castle; miscellaneous plants and cut flowers, Messrs. T. Baines, H. Herbst, J. Fraser (Leyton), and J. Fraser (Kew); fruit, &c., Messrs. G. Bunyard, J. Smith, J. Hudson and A. H. Pearson.

ORCHIDS.

For convenience in noting the exhibits these will be grouped under their respective heads, taking them as nearly as possible in the order of their extent and importance. None could refuse the first place on this occasion to the Orchids, which were grandly represented, and it may be safely said that such a magnificent display of these beautiful plants had never previously been publicly provided. Their adaptability to grouping, to which we referred last week, was admirably illustrated in several instances, but in others, owing to the unfortunate crowding, much beauty was lost, and twice the space would have been needed in one or two cases to have done full justice to them. The amateurs' exhibits were allotted the whole of the central stage in the large marquee, and to these we will first devote a few notes. Taking them in the order they were visited from the entrance the first silver cup group was that from Sir Trevor Lawrence, Bart., Burford Lodge, Dorking (grower, Mr. White), who contributed liberally from his great collection, and the group was an extremely bright one, owing to the preponderance of finely grown, richly coloured varieties of Masdevallias. These plants are most successfully grown at Burford Lodge, and not only are the plants vigorous, but they also flower with astonishing freedom, and the two conditions are not always combined, as many amateurs can testify. In fact, it is not unfrequently the case that really strong plants are the least satisfactory in their flowers. At Dorking they have struck the "happy mean," and with sturdy growth, sufficient rest, and constant attention, the plants both grow and flower splendidly. Some of the finest forms of the *M. coccinea* and *M. Harryana* types were represented similar to those recently exhibited at the Drill Hall, bearing dozens of flowers each. A handsome specimen of *Cypripedium Rothschildianum* was also very prominent in this group, the stately flowers of considerable size and the dark veins in bold relief. The singularly distinct *Maxillaria Sanderiana*, which caused so great a sensation when shown at the Orchid Conference in 1888, was another characteristic plant, the ivory white substantial flowers having a peculiar dark claret purple centre (fig. 83). The exquisitely delicate *Cattleya Mossiae Wagneri* was another notable member of the group, together with choice *Odontoglossums*, the graceful and useful yellow *Oncidium ampliatum majus* and *Marshallianum* contributing important features to the group, while several distinct *Cypripediums* were included, especially *C. Swannianum* and *Cypripedium Fraseri*, the latter with purple tinted flowers from a cross with *D. hirsutissimum*. Of *Vanda teres* and the strange rich brownish *Masdevallia Schlimi* numerous plants were also shown.

Immediately following the above was the group from Baron Schröder (gardener, Mr. Ballantine), The Dell, Egham, which were awarded a silver cup of equal merit. The wonderful collection at this garden is noted alike for the rarity and beauty of the Orchids it contains, for their remarkable culture, and for the unique specimens represented. It was not, therefore, difficult for "the Baron" to find something to please and astonish the visitors to the Temple, and much more space could have been filled with ease, in fact even the plants shown would have benefited by more room. There was a grand mass of rich flowers varied both in form and colour, most of the principal genera that flower at this time of year being noted. Very conspicuous were two magnificent specimens of *Cattleya Skinneri* with scores of rosy flowers each, and scarcely less remarkable was *Masdevallia Veitchi grandiflora*, having thirty brilliant flowers. To enumerate the *Odontoglossums* alone would require more space than can be spared, for superb forms of *O. vexillarium*, *O. Wilckeanum*, *O. Halli*, and *O. excellens*, with *O. Pescatorei Veitchi* and many others were there in abundance. *Lælia purpurata* in select varieties, rare *Cypripediums*, the Golden *Spathoglottis aurea*, the charming white *Aerides Fieldingi Williamsi*, the old familiar but in its way still unsurpassed *Ada aurantiaca* were admirably shown. Of the Philippine *Aerides Savageanum*, with rosy crimson flowers, the best variety was included in this group, and secured for Baron Schröder (with Sir Trevor Lawrence and Mr. F. Sander) a first class certificate of merit.

A successful attempt was made in the group from T. B. Haywood, Esq., Woodhatch Lodge, Reigate (gardener, Mr. C. J. Salter), to show how Orchids should be arranged, and the silver Flora medal awarded was well deserved. Arising from a ground of fresh green *Adiantums* were

elegant Palms with fine *Odontoglossums*, a few *Masdevallias* for colour, *Phalænopses*, and the golden *Dendrobium chrysanthum*. Though comparatively few plants were employed, the effect was good, light, and free. *Cattleyas* have long been a speciality with A. H. Smee, Esq., The Grange, Carshalton (gardener, Mr. Cummins), and his group was in consequence mainly composed of the choice varieties of *C. Mossiae* and *C. Mendeli* he has so carefully collected. With them were tastefully associated *Lælia purpurata*, *Masdevallias*, *Odontoglossum vexillarium*, Ferns and Palms, the high quality of the group securing a silver Flora medal as in the preceding case.

The Duke of Marlborough, Blenheim (gardener, Mr. Whilans), had a group of large specimens bearing abundant beautiful flowers—*Cattleyas*, *Dendrobiums*, *Lælia purpurata*, *Odontoglossum citrosimum*, *Vandas*, and *Cymbidium*s were the most noteworthy, the whole group being neatly margined with small Ferns (silver Flora medal). F. Wigan, Esq., Clare Lawn, East Sheen (grower, Mr. W. H. Young), had a smaller but bright and creditable contribution—*Vanda teres*, *Cypripedium lævigatum*, with *Cattleyas*, *C. purpurata*, *Oncidium Marshallianum*, and *Odontoglossums* in variety, all healthy and good (silver Banksian medal). A similar award was secured by Malcolm S. Cooke, Esq., Kingston Hill, for well-grown Orchids, amongst which were *Cattleyas*, *Lælias*, capital examples of *Epidendrum vitellinum majus*, and *Oncidium crispum*.

Vanda teres is a favourite Orchid with many cultivators, but too few can manage it successfully. Strange to say, however, in several of the gardens owned by the members of the Rothschild family this Orchid is grown with the best results. It is even said that in some instances as many as 250 spikes of flowers have been cut for decoration in one year. Therefore the admirable group of this *Vanda* from Messrs. Rothschild, Gunnersbury Park (gardener, Mr. Reynolds), which comprised sixty strong well flowered plants, was especially interesting, and the honour accorded—a silver-gilt Flora medal—was a fitting recognition of so important a contribution to the Show, and such creditable examples of good culture. Most of the spikes had from four to six large flowers each, the colours also being rich. Mrs. Arbuthnot, Bridgen Place, Bexley (gardener, Mr. Mitchell), had some good plants of *Odontoglossum vexillarium* and *Lælia purpurata*, a large *Sobralia macrantha*, with *Cypripediums* and *Anthuriums*, but the latter would have been better omitted from an otherwise satisfactory group (silver Flora medal).

Still, taking the exhibits in their order, in the central stage we have next to notice the group of *Phalænopses* (bronze Flora medal) from Major-General Berkeley, Bitterne, Southampton (gardener, Mr. J. Godfrey), and though it was only a small collection of *P. speciosa*, *P. Luddemaniana*, and *P. tetraspis*, with a few others of those types, it was full of interest. This was not only because the plants were very healthy and attractive in themselves, but for the reason that the exhibitor has himself been an amateur Orchid collector who has succeeded in introducing several well known plants to England. W. F. Darnell, Esq., Devonshire House, Stamford Hill (gardener, Mr. Elliott), staged a small but pleasing group of *Cattleyas* and *Lælias* arranged with Palms (bronze Flora medal). Mr. G. Burnett, 17, Paget Road, Stoke Newington, contributed examples of *Lælia purpurata*, well grown and freely flowered, the varieties also good. R. B. White, Esq., Arddaroch, Garelochhead, N.B., sent a plant of *Odontoglossum crispum guttatum*, a handsome variety with finely proportioned flowers, heavily spotted with brown, also a capital *Cattleya Mendeli*. To conclude the amateurs' Orchid contributions we have only to record that T. Statter, Esq., Stand Hall, Whitefield, near Manchester, showed a beautiful collection of cut flowers, representing most of the popular Orchids obtainable at the present time, but the gem was *Lælia elegans Statteriana*, a superb variety for which an award of merit was adjudged with a silver Banksian medal for the whole of the exhibit. The Right Hon. J. Chamberlain, Highbury, Birmingham, sent a collection of *Masdevallia* flowers tastefully arranged, including several very handsome varieties (silver Banksian medal).

Prominence has been given to the amateurs' groups, for they constituted an important part of the Exhibition, and they moreover occupied the post of honour in the great marquee. Now some space must be devoted to the trade collections which filled the central stage in the second tent. One side of this—the left entering from the Embankment—was allotted to Messrs. F. Sander & Co., St. Albans, who succeeded in providing the most sensational attraction in the whole Exhibition. It was a triumph in Orchid grouping which excited admiration in those who know what can be accomplished with Orchids, and astonishment in those to whom the plants were comparative strangers. We have never had the satisfaction of seeing such a group at any other show in the kingdom, and though it may be altered another year, and possibly equalled, it is not likely it will ever be excelled even by the same firm. Having an enormous collection to select from obviously gave a great initial advantage; then again it is only in a large space that a representative Orchid display can be successfully attempted, and although less staging was at disposal than originally expected, yet the full run of about 140 feet allowed a chance to effect something of an uncommon character. We cannot attempt in the present issue to enumerate all the notable fine plants shown, but reserving that for another occasion, the general features of the group may be indicated. As a background and foundation handsome bushy specimen *Areca lutescens* were employed with some fine *Kentias*, *Cocos Weddelliana*, and *Adiantums*; then a series of effective groups of the same kind of Orchids formed the next leading feature. For instance, at one end of the stage were numbers of vigorous plants of *Cymbidium Lowianum*,

bearing long arching racemes of flowers; next followed a bold and beautiful cluster of *Lælia purpurata*; then attention was arrested by a mass of the graceful *Oncidium ampliatum majus* beneath a dark-leaved *Kentia*, and in fine contrast with it. The centre of the group presented another strikingly tasteful characteristic, for about fifty plants of *Odontoglossum citrosimum* were suspended at the back, bearing long pendent racemes of soft tinted fragrant flowers, while beneath and in

first-class certificates and awards of merit for plants that are described elsewhere in this Journal. It is almost needless to say that the Judges awarded the highest honour at their disposal—namely, a silver cup—for this magnificent contribution, in which about 150 distinct species, hybrids and varieties, were represented.

The other trade groups were necessarily much smaller, as four were confined to the opposite side of the central stage. Starting at the end



FIG. 85.—MR. F. SANDER. (See page 449).

front were choice *Odontoglossums* by scores, with here and there a brilliant *Masdevallia*, lighting up the lighter flowers surrounding with remarkable effect. Towards the other end were further clusters of *Lælia purpurata* and *Odontoglossum vexillarium*, and the very conspicuous *Grammatophyllum Measuresianum*, with four tall racemes of its strangely spotted flowers. The margin was very well managed, *Odontoglossum vexillarium* being freely used with *Adiantums*, imparting a charming finish to a really superb arrangement. The group was equally as remarkable for the number of valuable rarities and novelties it contained, and the Orchid Committee adjudged no less than eight

the first was from Mr. J. Cypher, Cheltenham, who had an effective group of admirably healthy plants, amongst which a large specimen of *Dendrobium Jamesianum*, some splendid examples, *Lælia purpurata*, with *Masdevallias*, *Cattleyas*, *Odontoglossums*, *Cypripediums*, and scores of other choice Orchids (silver Flora medal). Following this was an imposing and highly creditable exhibit from Messrs. B. S. Williams, Upper Holloway, who have so long held a foremost position amongst Orchid growers and exhibitors. Large numbers of distinct and beautiful forms were included, the enumeration of which would take too much space this week, but all the leading genera were admirably

represented, the most effective part of the group being formed with *Lælia purpurata*, *Oncidium Marshallianum*, and *Odontoglossum vexillarium*, *Cymbidium Lowianum*, and choice *Cattleyas* (silver Flora medal). Messrs. H. Low & Co., Clapton, contributed a group of useful medium-sized plants, representing about thirty distinct forms, the most conspicuous being two clusters of the whitish *Dendrobium Bensoniæ* and the beautiful new *Dendrobium Parishii albens*. Messrs. Heath and Son, Cheltenham, also sent a few Orchids, including *Cypripedium Stonei magnificum* and *Masdevallia Heathi* in the way of *Chelsoni*. Messrs. J. Veitch & Sons sent three hybrid Orchids of much interest. One was *Odontoglossum excellens*, which had been raised from an artificial cross between *O. triumphans* and *O. tripudians*, the second was *Epiphronitis Veitchi*, and the third *Masdevallia caudata Estradæ*, both of which have been previously described.

ROSES.

Returning to the large marquee, many other important exhibits demand attention, and scarcely less attractive than the Orchids to the general public were the delightful Roses from the great exhibiting firms in the south of England. Messrs. W. Paul & Son, Waltham Cross, had a magnificent group of specimen plants in grand health, the substantial rich or delicate blooms in fine contrast with the fresh green foliage. Besides the plants, too, there were twelve boxes of cut blooms, representing scores of beautiful varieties. Amongst the novelties very notable Hybrid Perpetuals were the soft pink Spenceer, the fine crimson *Souvenir de Rosieriste Gonod*, and the glorious rich velvety *Crimson Queen*, a trio of fine Roses, for which awards of merit were granted, while a silver cup was accorded for the whole group.

Tasteful and rich was the group of Roses from Messrs. G. Paul and Son, Cheshunt, which also secured the honour of a silver cup. At the back were large specimen Roses of the most approved exhibition types, with graceful Bamboos, which form one of the many notable specialties at Cheshunt; then in front was a novel arrangement of dwarf white *Lilæes* and *Adiantum pedatum*, which is admirably adapted for grouping purposes. Baskets of *Maréchal Niel* Roses were greatly admired, as also were specimen plants of Paul's Single White and *Polyantha grandiflora* Roses, *Amaryllises*, and a double white fragrant hardy *Azalea* being included with these. The third large group of Roses came from Mr. W. Rumsey, Waltham Cross, who had a fine collection of medium sized plants in excellent condition both as regards foliage and flowers (silver-gilt Flora medal).

TUBEROUS BEGONIAS.

Much interest was excited by these plants, for the two firms who have aided so greatly in improving and popularising Tuberous Begonias—namely, Messrs. Laing & Sons, Forest Hill, and Messrs. Cannell & Sons, Swanley, were both contributing their treasures, and there was considerable eagerness to ascertain which were the leaders. The Judges, however, found the respective merits so evenly balanced that a silver cup was awarded in each case, an honour amply deserved. Messrs. H. Cannell & Sons, Swanley, had rather more space at their command, of which they had taken full advantage, and had two exceedingly bright groups of single and double varieties remarkable for the size, substance, form and colour of their flowers. Two of the most distinct were selected for awards of merit—namely, *Lady Addington*, double, rich salmon, and *Wm. Marshall*, single, a fine shade of orange, but there were many others of nearly equal merit. Messrs. J. Laing & Sons' group suffered somewhat from being rather crowded, but it contained a choice selection from the numberless grand Begonias that have been sent out from this nursery during recent years, affording an admirable idea of the beauty, range of variation, and usefulness of the family. A single variety, *Mrs. R. Dean*, was accorded an award of merit, the flowers of superb form, white in the centre edged with rose.

PELARGONIUMS.

The floral attractions of the meeting were materially increased by the Show and Decorative Pelargoniums, especially by those from Mr. C. Turner, Slough, of which about thirty medium-sized specimens, superbly flowered, were staged in one group, representing many good varieties. One of these, *Royal Ascot*, was found worthy of an award of merit. It is a brilliant scarlet decorative form with a white centre and dark blotches, vigorous but compact in habit (silver Flora medal). Mr. D. Baldwin, Hillingdon Heath (gardener, Mr. Wiggins) also had a collection of well grown Pelargoniums—*Goldmine*, *Brilliant*, *Duchesse de Morny*, *Kingston Beauty*, and *Emperor* being notable varieties (silver Banksian medal). Specimens of the new *Regal Pelargonium Pearl*, with two boxes of cut blooms came from Mr. Rupert Miller, Southdown Nursery, Shoreham, and were much admired. It is a pure white sport from *Madame Thibaut*, and inherits all the good qualities of that well known variety.

CALCEOLARIAS.

There is an impression abroad that *Calceolarias* are deteriorating in quality, and that their culture is not so well attended to as formerly; but both of these erroneous opinions would have been effectually altered by an inspection of the plants and types represented at the Temple. First to require notice were those from Sir C. Pigott, Bart., Wexham Park, Slough (gardener, Mr. Ford), which were most satisfactory examples of the best culture, compact, strong, with good foliage, large heads and fine flowers of varied colours. It was the finest group of these plants we have seen for some time, and the Judges recognised its merit by the award of a silver-gilt Flora medal. From Messrs. J. James & Son, Farnham Royal, also came a collection of extremely dwarf *Calceolarias*, the flowers of the usual quality distinguishing the Jamesian productions

(silver Flora medal). Messrs. James Carter & Co., High Holborn, also had a group of excellent *Calceolarias* of the Victoria and Japanese prize strains, which are noted for the rich and diverse colours of the flowers. A silver cup was adjudged for these with other contributions from the same firm. Messrs. J. Peed & Sons, Roupell Park, also had a good group of well grown *Calceolarias*.

AZALEAS.

Though it might have been expected that the time of year would have been just right for the Azaleas, yet these were not largely shown, for the specimens of the indica section seem to be over, and the hardy Azaleas, of which a grand display had been promised, were not fully out. Mr. C. Turner, however, contributed a series of half-specimen *Azalea indica* varieties, neat plants, profusely flowered, and they constituted a beautiful group, edged with Ferns (silver Flora medal).

GROUPS.

Considerable space was devoted to groups of a miscellaneous character which cannot be conveniently classified under distinct headings. One of the most remarkable was a bank of *Carnation Souvenir de la Malmaison* from Leopold de Rothschild, Esq., Ascott, Leighton Buzzard (gardener, Mr. Jennings), which occupied a position backing up to one end of the central stage in No. 3 tent, where they attracted the admiration of all visitors. The three types—white, pink, and crimson—were represented in proportionate numbers; the plants were very healthy, and the flowers of great size (silver Flora medal).

Messrs. J. Veitch & Sons, Chelsea, had two important and beautiful exhibits—one a graceful miscellaneous group in the large marquee, the other a collection of the useful new hybrid *Streptocarpus* in No. 1 tent, the firm thus securing double honours, a silver cup and a silver-gilt Flora medal. The miscellaneous group comprised double and single hardy Azaleas, grand *Pæonies*, the graceful *Spiræa astilboides*, the snow-white *Chionanthus*, *Staphylcas*, *Hydrangeas*, *Rhododendrons*, the elegant *Clethra alnifolia*, *Daphne cneorum*, and the blue *Leschenaultia biloba*. These were effectively arranged, and formed a group quite distinct in character from anything else in the Exhibition. For the distinct *Rhododendron Rosalie Siedel*, with pure white flowers relieved by a few dark dots, an award of merit was secured. The *Streptocarpus* hybrids (fig. 86) received more attention than many other exhibits, as they were new to most visitors. The dwarf plants were bearing numerous white, lilac, mauve, and rosy flowers, and an award of merit was granted for the type. As easily grown plants, readily raised from seed, these are certain to become very popular.

Messrs. B. S. Williams had an extensive and well arranged group of foliage and flowering plants, Palms, *Dracænas*, and Azaleas, with *Anthuriums* forming the leading features, while *Clivias* were also conspicuous for the size of their flowers and trusses. The group was neatly margined with the graceful *Carex variegata* and other small plants (silver Flora medal).

Caladiums from Messrs. J. Laing & Sons were very handsome, the foliage being finely coloured and the varieties the best procurable. *Charlemagne*, *Anna de Condeixa*, *Raymond Lemonier*, *L'Aurore*, *Gabrielle Lemonier*, and *Chactus* were noteworthy amongst the many others, while one named *B. S. Williams*, the leaf large, veined with red on a white ground, had an award of merit (silver Flora medal). A fine group of Palms, *Anthuriums*, and Orchids also came from the same firm, and a similar medal was accorded.

Messrs. J. Cutbush & Sons, Highgate, staged a capital group in one corner near the entrance to No. 3 tent, and a silver cup was awarded to the firm. Palms, Ferns, *Dracænas*, and greenhouse hardwooded plants predominated; *Ericas*, *Leschenaultias*, *Boronias*, the charming white and free *Leptospermum bullatum* (fig. 87), *Hydrangeas*, and *Spiræa palmata* were conspicuous attractions; as also was a group of *Mignonette* *Snow-drift* with massive white very fragrant flower heads.

Hardwooded plants of moderate size were shown by Messrs. H. Low and Co., useful healthy little specimens of the popular *Heaths*, Azaleas, *Rhododendrons*, *Helichrysums*, and many New Holland plants (silver-gilt Flora medal). The remarkable blue *Leschenaultia biloba major* (fig. 88), which appeared in so many groups, was well shown by Messrs. Balchin and Son, Hassocks Gate Nurseries, who have for some years made this plant a successful speciality (silver Banksian medal).

Messrs. Peed & Sons, Roupell Park Nurseries, S.W., had an imposing array of *Anthurium Schertzerianum*, of which they possess a series of the best varieties, and disposed, as these were with sufficient Palms and other foliage plants to provide a foil to their bright tints, they afforded a grand display (silver Banksian medal). Mr. W. Ieeton, The Nurseries, Roehampton, contributed some magnificent Palms, surrounded by variegated *Maples*, *Lilium longiflorum*, *Dracæna Lindenii*, and margined with various small variegated plants (silver Flora medal).

Messrs. J. Carter & Co. had, in addition to the *Calceolarias* already noted, a beautiful group of *Emperor Petunias* and *Queen's Prize Mimulus*, very rich and varied in colours and markings in both cases. The *Marble Prize Gloxinias* were also notable for their high quality, and beyond these there were numerous interesting curiosities amongst the miniature Cacti (silver cup). Mr. Pritchard, Christchurch, staged an uncommon group of hardy plants naturally arranged—that is several plants of the pretty *Ramondia pyrenaica* and the bright blue *Gentiana verna* were shown in little hollows of lichen and moss surrounded by other alpine plants. *Saxifraga longifolia*, *Eriophorum vaginatum*, the White Portuguese Broom, and *Genista Andreana* were well represented.

Only two groups of Ferns were shown, but these were both of exceptional character, representing distinct departments of the Fern business.

The first of these was from Messrs. W. & J. Birkenhead, Sale, and comprised a great number of species and varieties of exotic and native Ferns in all their numerous interesting and elegant departures from their respective types in creasing, &c. Three were found sufficiently distinct for awards of merit, but they were rather overburdened with names. They were *Polystichum angulare divisilobum densum*, with finely elegant fronds; *Athyrium Filix-fœmina Girdlestonei cristatum*, with slender crested fronds; and *Asplenium lanceolatum microdon*, having bright green undulated pinnæ, the very compact and neat. A silver cup was adjudged for this group, and a silver Flora medal went to Mr. H. B. May, Edmonton, for a group of useful market Ferns arranged in his useful tasteful style.

A large and interesting group of herbaceous plants and cut flowers and pans of showy Alpines was arranged by Messrs. Paul & Son, The Old Nurseries, Cheshunt (silver Flora medal); and pure white *Clematis* came from Messrs. R. Smith & Son, Worcester. The remarkable yellow *Ca'la Elliottiana* from Mr. G. M. Knight, Farnborough Park, attracted much attention, as also did the tall upright spikes of *Eremurus himalaicus* (first-class certificate) from Mr. John Smyth, Ballinacurra, Cork. A plant of the pretty blue *Tropæolum azureum* was shown from the Society's Gardens, Chiswick; and Mr. Smout, Hastings, contributed beautiful arrangements of seaweeds.

CUT FLOWERS.

Some large collections of cut flowers were shown which merit a few words of reference. Messrs. J. Veitch & Sons had a choice and beautiful assortment of Tulips, Daffodils and hardy flowers, with which



FIG. 86.—HYBRID STREPTOCARPUS. (See page 452).

were associated plants of *Gloxinias* of remarkable brilliancy, *Flambeau*, *Hector* and *Garnet* exceptionally so (silver-gilt Flora medal). Messrs. Kelway & Son, Langport, contributed a superb collection of *Pæonies*, *Pyrethrums*, *Amaryllises*, and various hardy flowers which formed an important exhibit in the entrance tent, and found crowds of admirers during the two days (silver cup). Mr. T. S. Ware, Hale Farm Nurseries, Tottenham, had a magnificent group of tree *Pæonies*, of cut flowers, of *Iris*es and *Tulips* in abundance (silver Banksian medal). Messrs. Barr & Son, King Street, Covent Garden, had a grand display of *Tulips*, including many singular forms; *Violas*, *Pæonies* and hardy flowers generally were also admirably represented from the same firm (silver Flora medal).

Mr. W. Chambers, Isleworth, sent some elaborate and beautiful floral decorations in the shape of wreaths, baskets, &c., together with specimens of the pure white *Snowflake Viola* (silver Banksian medal).

Mr. G. Phippen, The Nurseries, Reading, was a large exhibitor of wreaths, bouquets, and other cut flower arrangements, and he also had a collection of *Pansies* and *Violas* in the best varieties (silver Banksian medal). Messrs. Dobbie & Co., Rothesay, staged an extensive and beautiful collection of cut flowers of *Pansies* and *Violas* (silver Banksian medal). Single *Anemones* and bunches of double *Pyrethrums* were contributed by Messrs. Hennecquin, Denis & Co., Angers, France. Messrs. Ryder & Son, Sale, Manchester, had a collection of *Primula Sieboldi* in great variety. Messrs. Victor Lemoine et Fils, Naney, France, had six varieties of new double *Lilacs*. Mr. F. Hooper, Vine Nurseries, Bath, showed several boxes of good *Pansies* and *Violas* and four dozen splendid blooms of *Maréchal Niel* *Roses*. Mr. J. Walker, nurseryman, Thame, contributed excellent stands of *Tulips*, *Maréchal Niel* *Roses*, and *Zonal Pelargoniums*. *Tulips* were also well shown by Mr. J. Lakin, Temple Cowley, Oxford, which were inspected with much interest by many visitors who cultivate or admire these beautiful flowers.

CERTIFICATED PLANTS.

The Orchid and Floral Committees held meetings on the first day of the Show to adjudicate upon the numerous novelties submitted, and the following were selected for honours by the Floral Committee. The majority of these we noted in the course of the report, and the Orchid novelties are described under that heading in another page.

Eremurus himalaicus (Mr. T. T. Smith).—This giant and shapely relative of the *Asphodel* has very tall close spikes of white flowers, resembling in habit *E. robustus*, which is often seen with pink flowered spikes 7 feet or 8 feet high (first-class certificate).

Dracæna australis variegata (Laing & Sons).—A peculiarly handsome foliage plant, extremely useful for decorative purposes, owing to the clear white variegation of its leaves (first-class certificate).

Cocos Pynaerti (F. Sander & Co.).—A provisional name for an elegant little Palm of "stocky" habit; the pinnæ narrow and closely set on the rachis. It is likely to be a serviceable addition to the list of table plants (first class certificate).

To the following awards of merit were granted, and where the names only are given the plants are described in the preceding report under the exhibits of the respective firms.

Tuberous Begonia Mrs. R. Dean (Laing & Son); *Lady Addington and W. Marshall* (Cannell & Sons).

Caladium B. S. Williams (Laing & Sons).

Rhododendron Rosalie Siedel (Veitch & Sons).

Streptocarpus New Hybrid (Veitch & Sons).

Pelargonium Royal Ascot (Turner).

Asplenium lanceolatum microdon, *Athyrium F. f. Girdlestonei cristatum*, and *Polystichum angulare pulcherrimum divisilobum decorum* (Birkenhead).

Lilac Madame Lemoine (V. Lemoine & fils).—A double variety with pure white flowers.

Lilac Michael Buchner (V. Lemoine & fils).—Another double variety with pale whitish mauve flowers, very distinct and delicate.

Clematis Snow White Jackmanni (R. Smith & Co.).—A distinct acquisition with white flowers, which are said to be even better out of doors and preserve their character.

Pæonia arborea Mrs. W. Kelway (Kelway & Sons).—A superb variety with large pure white flowers.

Rose Spencer (W. Paul & Son).—A Hybrid Perpetual with soft pink blooms of good substance and shape. The plant is also of sturdy habit.

Rose Souvenir de la Rosieriste Gonod (W. Paul & Son).—Another Hybrid Perpetual with handsome rich crimson flowers, very strong habit and free.

Rose Crimson Queen (W. Paul & Son).—A third Hybrid Perpetual, perhaps even more meritorious than either of the preceding, for the flowers are of a wonderfully rich velvety crimson. They are of excellent shape and substance, and the habit of the plant leaves nothing to be desired.

Rose Clothilde Soupert (Paul & Son).—A beautiful pink Hybrid Perpetual of great promise, the blooms full, well-formed, and striking.

FRUIT AND VEGETABLES.

Vegetables were few but excellent, fruit much more plentiful and excellent too. The trees in pots from Messrs. T. Rivers & Son, Sawbridgeworth, attracted the lion's share of attention. There were between twenty and thirty of them in 10-inch pots. Peaches, Nectarines, Plums, and Cherries, as well as Orange trees in smaller pots, laden with blossom impregnating the air with its powerful fragrance. The Peach and Nectarine trees, which were pyramids 3 to 4 feet high, contained about a dozen fruits each, some more, some less, ripe or approaching ripeness. A *Czar Plum*, 3 feet high, was ripening nearly a hundred fruits, and Cherries were similarly heavily laden. Alexander appeared to be the earliest Peach, the fruits large. Lord Napier was the earliest of the Nectarines in commerce, and very fine the fruits were; but in size, colour, and earliness they were quite superseded by those of a new variety, one of Mr. Rivers' seedlings, trees of which have not been distributed, and it is not known when they will be, as growing the fruit for sale at 4s. a dozen, presumably "pays" better than selling the trees. The variety was not named, and for convenience is referred to as Rivers' Early Red, because of the question often heard asked by one gardener of another, "Have you seen that fine red Nectarine of Rivers's?" It was the fruit of the Show undoubtedly. Fruits of Lord Napier on trees started at the same time were quite hard and green, appearing to require ten days or a fortnight to ripen. On a lightly cropped tree of the Early Red the fruits were 9 inches in circumference and ready for gathering. They were bright bronzy red in colour, and as the writer of these lines has had the privilege of tasting the fruit of this variety he is able to pronounce it as good as it looks, and of first-class excellence. This new Nectarine must rank among the most important fruits yet raised at Sawbridgeworth, and is bound to take the lead in the section to which it belongs. A silver cup was awarded to this collection of trees.

Next in importance in the fruit classes was a remarkable collection—over ninety dishes of Apples in eighty varieties, for which a silver medal was awarded to Messrs. James Veitch & Sons. The fruits had been admirably kept, some of them suggesting by their smoothness and solidity that they would keep "till Apples come again." Among the freshest were Lanc's Prince Albert, Dumelow's Seedling, Winter Colman, Northern Greening, Bramley's Seedling, Bismarck, Sandringham, Grange's Pearmain, Lansberger Reinette, Herefordshire Beefing, Betty Gecson, Flower of Kent, King of Tomkins County, Ribston Pippin,

Cox's Orange Pippin, Galloway Pippin, and Brownlee's Russet, all of which were in sound condition for use. Messrs. Veitch also exhibited bush and standard trees of the St. John's Fig, as the earliest to ripen, and retaining its first crop better than any other, while its productiveness was demonstrated.

Collections of fruit were staged by J. F. Campbell, Esq., Woodseat, Uttoxeter (Mr. J. Hollingworth, gardener), and E. Pettitt, Esq., Broadwater, Oatlands Park (Mr. J. W. Reed, gardener), the Foster's Seedling and Black Hamburg Grapes of the former being very good indeed, and other dishes creditable, meriting the award of the bronze Flora medal accorded. The fruit in the other collection was smaller, except the Melons and Oranges.

Mr. J. McIndoe, Hutton Hall, Guisborough, sent very fine dishes of Grosse Mignonne and Crimson Galande Peaches, also Lord Napier Nectarine; and Messrs. F. Burton & Son, Bexley, exhibited a box of Alexander Peaches, but so deeply buried in wadding that their size was not adequately displayed. From Major Shuttleworth, Old Warden (Mr. G. R. Allis, gardener), came characteristic fruits of Hero of Bath



FIG. 87.—LEPTOSPERMUM BULLATUM. (See page 452).

Melon and a very fine fruit of A. F. Barron. Five large, ribbed, and well netted fruits of the Ruxley Lodge Favourite Melon were staged by Mr. J. Miller, gardener to Lord Foley; and remarkably fine Brown Turkey Figs, also President Strawberries, were brought by Mr. G. Wythes from Sion House. Splendid Sir Charles Napier Strawberries were exhibited by Messrs. W. & E. Wells, Hounslow (Mr. G. Thomson, gardener), also twenty-four fruiting plants in pots, and a bronze Banksian medal was awarded.

The market collections of fruit from Mr. G. Munro, Covent Garden, attracted considerable attention. One of these collections represented home-grown, the other Channel Island produce. The former consisted of baskets of black and white Grapes, of fair average quality, from Mr. G. Piper; Tomatoes, such as are not often seen at this season, from Mr. J. Rolfe, Stamford-le-Hope; remarkably fine Sir Charles Napier and good President Strawberries from Mr. R. Mitchell, Orleans House, Twickenham; and handsome fruits of what appeared to be the Countess Melon from Mr. J. Miller. The Channel Island fruit consisted of nine baskets of Black Hamburg and six of Muscat Grapes, each containing about 8 lbs. of medium-sized bunches with large uniform well-coloured berries, distinctly superior to those above mentioned. They were closely wedged in cross-handled baskets without any packing material, and had travelled well. The Melons (fifteen) were magnificent well-netted fruits, and there were also two baskets of first-class Figs. Whatever natural advantages the Channel Islanders may possess, it cannot be denied that they also possess cultural skill, or they could not send such admirable produce to market.

With the fruit were three baskets of Peas of first-class quality, the pods very large, dark green, and well filled, the variety resembling the Duke of Albany; and it is questionable if finer Canadian Wonder Beans have ever been seen, while the Ashleaf Potatoes in the collection have not often been excelled from outdoor crops. A silver cup was adjudged to Mr. Munro for his valuable contribution to the Exhibition. Excellent Cucumbers and Asparagus also came from Mr. W. Godfrey Colchester.

Two boxes of Mildura raisins were shown from the Irrigation Colonies, Victoria (the Chaffey Concession), by Messrs. Alford and Millar, "from Vines planted one year and nine months and one year old when planted." The samples appeared very good, large, and well coloured.

MISCELLANEOUS.

Among these were noticeable rustic work in the form of attractive summer house, chairs, and vases from Mr. G. W. Riley; good pottery in variety from Messrs. W. S. Iles & Co.; samples of reform glazing from Mr. Newton; piles of active looking Mushroom spawn from Messrs. Cutbush; peat and various sundries, including light and handy bamboo ladders from Messrs. Wood & Son; spraying appliances from the Stott Company and Messrs. Clarke & Co.; manures and other garden requisites from Mr. George; Balmoral (olive green) flower glasses from Messrs. Green and Nephew; Orchid baskets from Messrs. Walters & Co.; and last, but evidently not least in interest, a model greenhouse by Mr. C. Toope and Co., showing a method of ventilating, which is said to deprive the fog of its poisonous gases by filtering it through the great absorbent and antiseptic substance charcoal. A house is to be erected at Chiswick for testing this bold grappling with the fog fiend by a man who does not like to be beaten in anything he undertakes. If he succeeds in his object he will deserve a gold medal, and in any case his system of ventilation will find favour with many amateurs. He says his Orchids sustained no injury last winter in the foggy, smoky, densely populated "east end" of London.

LIST OF AWARDS.

The following is the official list of awards:—

SILVER CUPS.

Baron Schröder, The Dell, Staines, for group of Orchids.
Sir T. Lawrence, Burford Lodge, Dorking, for group of Orchids.
Messrs. F. Sander & Co., The Nurseries, St. Albans, for group of Orchids.
Messrs. W. & J. Birkenhead, Sale, Manchester, group of Ferns.
Mr. G. Monro, Covent Garden, collection of fruit.
Messrs. Kelway & Son, Langport, hardy herbaceous plants and cut flowers.
Messrs. J. Veitch & Sons, Chelsea, group of hardy plants.
Messrs. H. Cannell & Sons, Swanley, group of Begonias.
Messrs. J. Laing & Sons, Forest Hill, group of Begonias.
Messrs. W. Cutbush & Son, Highgate, group of foliage and flowering plants.
Messrs. Paul & Son, Cheshunt, for group of Roses, &c.
Messrs. W. Paul & Son, Waltham Cross, group of Roses, &c.
Messrs. B. S. Williams & Son, Upper Holloway, group of foliage and flowering plants.
Messrs. T. Rivers & Son, Sawbridgeworth, collection of fruit.
Messrs. James Carter & Co., High Holborn, miscellaneous groups of plants.

SILVER-GILT FLORA MEDALS.

Messrs. de Rothschild, Gunnersbury Park, Acton (gardener, Mr. G. Reynolds), for group of Vanda teres.
Messrs. Barr & Son, Covent Garden, groups of hardy herbaceous plants and cut flowers.
Messrs. J. Cypher & Son, Cheltenham, for group of Orchids.
Leopold de Rothschild, Esq., Aseott, Leighton Buzzard (gardener, Mr. Jennings), for group of Carnations.
Messrs. J. Veitch & Sons, for hardy cut flowers and Streptocarpus and Gloxinias.
Messrs. H. Low & Co., Clapton, group of New Holland plants.
Sir C. Pigott, Bart., Wexham Park, Slough (gardener, Mr. Ford), group of Calceolarias.
Mr. W. Rumsev, Waltham Cross, group of Roses.
The Duke of Marlborough, Blenheim (gardener, Mr. Whillans), group of Orchids.

SILVER FLORA MEDALS.

T. B. Haywood, Esq., Woodhatch Lodge, Reigate (gardener, Mr. Salter), group of Orchids.
A. H. Smee, Esq., The Grange, Carshalton (gardener, Mr. Cummins), group of Orchids.
Mrs. Arbuthnot, Bridgen Place, Bexley (gardener, Mr. Mitchell), group of Orchids.
Messrs. B. S. Williams & Son, group of Orchids.
Mr. H. B. May, The Nurseries, Edmonton, groups of Ferns and foliage plants.
Mr. W. Iceton, The Nurseries, Roehampton, groups of Palms and foliage plants.
Messrs. J. Laing & Sons, for miscellaneous group of plants and Caladiums.
Messrs. Paul & Son, for group of hardy herbaceous plants.
Messrs. J. James & Son, Farnham Royal, Slough, group of Calceolarias.
Messrs. J. Veitch & Sons, collection of fruit.
Mr. C. Turner, Slough, groups of Pelargoniums, Azaleas, and Roses.

SILVER BANKSIAN MEDALS.

- F. Wigan, Esq., Clare Lawn, East Sheen, group of Orchids.
- M. S. Cook, Esq., Kingston Hill, group of Orchids.
- T. Statter, Esq., Stand Hall, Whitfield, Manchester, Orchids (cut blooms).
- Right Hon. J. Chamberlain, M.P., Highfield, Birmingham, group of Masdevallias.
- Messrs. H. Low & Co, group of Orchids.
- Messrs. W. Paul & Son., cut Roses.
- Mr. W. Chambers, The Nursery, Isleworth, floral devices.
- Mr. J. Walker, Thame, cut Roses, &c.
- Mr. M. Smout, 4, Quarry Crescent, Hastings, seaweed, shell, coral, &c.
- Mr. G. Phippen, Reading, bouquets.
- Messrs. Dobbie & Co., Rothesay, N.B., Pansies and Violas.
- Mr. F. Hooper, Bath, Pansies and Roses.
- Mr. D. Baldwin, Hillingdon Heath, group of Pelargoniums.
- Mr. Balchin, The Nursery, Brighton, group of Leschenaultias.
- Mr. T. S. Ware, Tottenham, group of Pæonies.
- Messrs. J. Peck & Sons, The Nurseries, Norwood Road, S.E., group of Anthuriums.
- Mr. G. W. Riley, 81, Dulwich Road, Herne Hill, rustic summer houses, seats, &c.



FIG. 88.—LESCHENAUTIA BILOBA MAJOR. (See page 452).

BRONZE FLORA MEDALS.

- Messrs. J. Cheal & Sons, Crawley, collection of fruit.
- Messrs. W. & E. Wills, Hounslow (gardener, Mr. Thompson), Strawberries in pots.
- J. F. Campbell, Esq., Uttoxeter (gardener, Mr. Hollingworth) Black Hamburg and Foster's Seedling Grapes.
- Messrs. W. S. Iles & Co., Warner Road, Camberwell, collection of pottery.
- Major Berkeley, Bitterne, Southampton, group of Orchids.
- W. F. Darnell, Esq., Devonshire House, Stamford Hill (gardener, Mr. Elliott), group of Orchids.



HARDY FRUIT GARDEN.

REGULATING THE GROWTHS OF TREES.—All trained fruit trees should be attended to now that growth is going on so fast, in order that inequalities in the distribution of sap may be regulated and a waste of

energy averted. We like to see a certain amount of healthy young growth in all fruit trees at this season of the year provided there are also prospects of a good crop of fruit; but very often one part of the tree will grow too strongly and appropriate more than its due share of the sap, and strong sappy wood is made which has to be cut away in the autumn. All such strong shoots should be taken away now if they can be spared without spoiling the shape of the tree, or else they must be stopped if it is necessary they should remain. Cherries of the Bigarreau class are very apt to offend in this respect, also young trees of all kinds of fruits, and some older specimens. Any trees that persistently refuse to bear a crop of fruit cannot be cured by pruning the tops only, this merely causes them to make fresh growth, and they gradually get worse. Such trees should be left without any pruning during the summer, and be dealt with by root-pruning in the autumn. Gooseberry and Currant bushes often make strong useless growths in the centres; too often these are left to extend until the winter pruning, to be then cut away and burnt, whereas if cut out now the sap will assist the fruit instead of being wasted, and the sun and air admitted will give better colour and flavour to the crop, and improve the wood for future bearing.

NEWLY GRAFTED TREES.—The scions will now be starting into growth, and should be encouraged to do so by reducing the number of shoots left on the old stock for drawing the sap into action. If any of the scions have failed a strong young shoot may be encouraged to grow, and eventually budded to fill up the gap. Stakes should be made ready in wet weather on which to fasten the grafts, in order to prevent the wind from blowing them off. If dry weather occurs the clay should be well attended to by damping it occasionally to prevent it cracking; where moss has been applied over the clay a sprinkle with a water-can will be all that is required.

CLEAN CULTURE.—All fruit plantations should be periodically hoed to keep down weeds. It is easy to do this when they are small, and then if wet weather comes for a week or two they will not get overgrown and need hand-pulling, which is much more expensive, and hoeing also does much good in dry weather by preventing undue evaporation of moisture. Currants of all kinds are much benefited by a mulching of long strawy manure at this season, which prevents soil particles being dashed on the fruit by heavy rains, and also keeps the roots cool and moist if hot dry weather ensues.

FRUIT FORCING.

VINES.—*Early House.*—As soon as the Grapes are cleared of the Vines give the inside borders a thorough supply of liquid manure, with tepid water added. This will help to plump the buds and encourage root action so essential to the activity of the laterals, which, if allowed moderate extension, is the best preventive of premature ripening of the foliage. Keep the ventilators open constantly, even in cold weather. Syringe thoroughly to cleanse the foliage of dirt and insects, especially red spider, and repeat occasionally or as found necessary to keep the old or main leaves healthy. Fresh laterals will soon be produced, and cultivators should maintain an even growth all over the Vines, pinching the gross laterals and encouraging the weak. The mulching or covering having been removed from the outside border, with just enough of the lighter part left to protect the roots, a good watering with liquid manure may be given, but this will only be needed where no rain has fallen. Avoid heavy mulchings; nothing is better than an inch or two of short fresh stable manure with the long strawy portions shaken out.

Second Early House.—Vines started at the new year have the Grapes ripening, but there is fully a fortnight to three weeks difference in the time of ripening between Vines carrying light crops and those with heavy crops, and whilst there is no fear of the first finishing well, there is always doubt of the latter passing the "red" stage. Maintain a circulation of warm, rather dry, air constantly, increasing the ventilation early. Keep the floors well damped on hot days with a view to check excessive evaporation, allowing the temperature to fall to 60° at night when cold, or 65° when warm, with sufficient warmth in the pipes to prevent moisture condensing. If there is likely to be any want of finish allow the Vines time by giving as long a rest at night as possible. If there is any doubt about the roots lacking moisture examine the border, and, if found necessary, give a thorough soaking in the morning of a fine day, and when soaked in mulch with a little light material. This will probably be sufficient to keep the border moist until the Grapes are cut; if not, it must be repeated. Moderate moisture, even after the Grapes are ripe, is essential to the health of the foliage, hence damping the floors and stages must be resorted to occasionally, as there is no fear of its damaging ripe Grapes at this season if only it be accompanied with air; besides, the moisture will assist in keeping the Grapes, and to prevent colour being taken out of Hamburgs a double thickness of pilchard nets should be drawn over the roof lights. Allow a moderate extension of the laterals to encourage root action, but keep gross laterals well in check so as to cause an equal distribution of the sap. When ripe a minimum temperature of 60° will be sufficient.

Midseason Houses.—Vines in these will be in various stages of development, according to the time of starting. Those that have stoned will be swelling the berries fast, and the borders should have a soaking of tepid water through a surface mulching an inch or two thick; or if the Vines are not vigorous and carrying a heavy crop, afford either a surface dressing of superphosphate 2 ozs. to the square yard, washed in with tepid water, or apply tepid liquid manure. The drainage being good, the watering, whether with water or liquid manure, will need to

be continued weekly if the border is limited to a small area, or fortnightly intervals, until the plants are somewhat advanced in colouring, when it must be stopped; yet the border must not be allowed to become so dry as to affect the foliage injuriously. Admit a little air constantly at the apex, and ventilate freely in the early part of the day, closing early with sun heat and a genial condition of the atmosphere. Fire heat will only be necessary to secure 60° to 65° at night, and 70° to 75° by day, keeping through the day at 80° to 85°, and closing sufficiently early to run up to 90° or 95°. This will insure the berries swelling to a good size, and with a free circulation of air a good finish may be secured.

Grapes Stoning.—During this process the Vines should have a regular temperature of about 65° at night, and 70° to 75° by day from artificial heat, if the Grapes are wanted by a given time, but if not 65° only need be maintained on dull, cold, wet days, but admit air in good time, always a little at 70° or before after a spell of dull weather, so that any moisture will be dissipated before the sun acts powerfully upon the foliage. Allow a moderate lateral extension, but avoid over-cropping, and supply liquid manure or water, washing in a top-dressing of artificial manure, or passing through a light mulch of short stable manure. Avoid, however, feeding luxuriant Vines too liberally, especially with ammoniacal manures, giving in their case steamed bone meal. This will enable the Vines to maintain steady progress and finish their crops, whilst storing food for the coming season's bearing.

Grapes Scalding.—Muscats and Lady Downe's in the later stage of stoning are liable to scald, therefore must be watched in hot bright weather, and air admitted more freely for a fortnight or three weeks until colouring commences, when all danger will be over. Black Hamburgs are sometimes scorched when the berries are exposed to the direct rays of the sun, which can mostly be avoided by a good spread of foliage, and remedied by a bountiful supply of air by day and a little ventilation constantly at the upper part of the house, with a genial warmth in the hot-water pipes.

Early Muscat Houses.—The fruit ripening will need a dry condition of the atmosphere as compared with Black Hamburgs, but avoid great aridity, or the foliage will fall a prey to red spider. Muscats must have time to ripen and acquire that amber colour so much prized. Do not allow any deficiency of moisture in the borders, for Muscats are gross feeders, but give either tepid liquid manure or tepid water through a rich surface mulching. The supply of water to the roots will in some measure compensate for the drier condition of the atmosphere. Provide a circulation air constantly, preventing the moisture condensing on the berries by sufficient warmth in the pipes to insure a changing atmosphere. Lateral extension is the best safeguard against shanking at this stage along with a steady temperature. Avoid sudden fluctuations and depressions. Keep the night temperature at 65° to 70°, 80° to 85° by day with a little sun, and 90° to 95° with it in full force. Ventilate early, and regulate by the sun's increase, and so with its decline, reduce early, securing as long a day of ripening from sun heat as possible. The old leaves of Muscats are liable to be scorched under powerful sun after a period of dull cold weather. In very bright weather draw a single thickness of tanned net over the roof lights, which, without impeding too much light, will prevent the condensation of moisture.

Late Houses.—Late varieties of Grapes in flower must have a circulation of dry warm air, and a temperature of 70° to 75° at night, rising to 85° or 90° from sun heat, or without this the thick-skinned varieties do not set well. Thin the berries freely as soon as they are set, but this in the case of shy setting varieties must be confined to the removal of the smallest and imperfect berries in the first instance, deferring the general thinning until the properly fertilised berries can be determined by their free swelling. There must not be any deficiency of moisture at the roots, therefore afford liquid manure copiously after the Grapes are thinned and swelling, or a top-dressing may be given of some approved artificial manure, distributing it evenly on the surface, and washing it in with tepid water.

MELONS.—Plants in flower must have a little air constantly with a free circulation on fine days, fertilising the flowers as they become fully expanded, and when a sufficient number of fruits about equal size are set upon a plant remove all the others and all flowers; three or four fruits are as many as a healthy plant can bring to a good size, over-cropping being fatal to quality, and very often the fruit does not reach maturity, but ripens prematurely. Plants swelling their fruits should have liberal supplies of tepid liquid manure and additions made to the ridges or hillocks of fresh soil as the roots protrude, and it should be warm.

Young plants in pits and frames with the shoots trained over the surface must be thinned to four, two being taken to the front and two to the back, keeping the laterals rubbed off to quite 6 inches from the stem, and pinching the main shoots when 12 to 15 inches from the sides of the pits or frames. The laterals will show fruit at the first or second joint, and the flowers being fully expanded fertilise them about noon on a fine day, leaving a little air on constantly to prevent the condensation of moisture, a moist close atmosphere being fatal to a good set. Pinch out the points of the shoots one joint above the fruit, and after three or four fruits are set and swelling on a plant remove all others. Keep the laterals closely pinched, and thin them if likely to crowd the principal foliage. Afford weak liquid manure, but keep it from the foliage, and sprinkle the plants in the afternoon of fine days, closing about 3.30 P.M. to 4 P.M., or so early as to raise the temperature to 90° or 95°, and

ventilate early in the day, or from 7.30 A.M. to 8 A.M., keeping through the day at 80° to 85° or 90°, and reduce the ventilation gradually. Keep a sharp look out for aphides, and fumigate on two or three consecutive evenings moderately, an overdose doing great injury. Shade the following days slightly if the weather be bright, and always have the foliage dry when fumigating. If canker appear rub quicklime into the affected parts until they are dry, and repeat as occasion requires, being careful to keep water away from the collar. Red spider will not appear if the plants are kept moderately moist.

THE FLOWER GARDEN.

Early Bedding Out.—The summer-like weather experienced during the early part of May tempted many to commence bedding out comparatively tender plants much earlier than usual, but these would have been far better off out of the ground till the first week in June. Cold saturating rains, hail, snow, and frosts have proved very harmful to large numbers of plants—in some cases even where they were only being hardened off. Calceolarias and Violas have come out of the ordeal well, but the Pelargoniums, Verbenas, Ageratums, and Fuchsias have been so much injured that they will have to be put out much thicker than usual, those beds already planted requiring to be freshened up with more plants. Not till the beds have been warmed considerably ought the more delicate and the crippled plants to be put out, and in the meantime the latter should have been protected from the prevailing cold rains and light frosts. Iresines, Coleuses, Alternantheras, and in some cold districts Heliotropes, ought to be kept out of the ground till the middle of June, and the two former especially answer well potted off singly after the pots are liberated by Pelargoniums, and kept under glass till well rooted. Thus treated, they transplant to their final quarters without sustaining a check. Sub-tropical plants generally not to be planted before the middle of June, and these, in addition to having sheltered positions, should also for a time be protected from strong winds and cold.

A Scarcity of Plants.—There were so many losses during the late winter, and in some cases again this spring, that many gardeners and amateurs will most probably find they have not nearly enough plants to fill their beds. To make matters worse, annuals sown in the open borders have either come up badly or the plants have disappeared during the late wet and cold weather. The only way out of the difficulty is to either buy what more plants are required or else to make a fresh departure in the way of turning out larger pot plants and transplanting others. Fuchsias, either planted out or kept plunged in pots, make grand bedding plants, and these dotted among a groundwork of dwarf growing or trailing plants of any kind—notably Ivy-leaf Pelargoniums—soon fill a large bed, the effect also being pleasing. A few trained plants of Ivy-leaf Pelargoniums, one of the best of which will be found in Madame Crousse, among Violas, Verbenas, Calceolarias, and such like, are also very effective from the beginning to the end of the season. Marguerites with a clear stem that have flowered in pots up to the present time would if cut back and planted among Petunias soon present a very gay appearance, or young plants may be similarly arranged. Variegated Maize included the newer *Zea gracillima*, are effective interspersed among any bright flowering or dwarf fine-foliaged plants. A mixture of these with the rich blue *Salvia patens*, with a bright edging of some kind, forms one of the most effective beds imaginable, and the herbaceous Lobelias form grand centres of beds, being also very showy in mixtures, especially if contrasting with *Cineraria maritima*, *Centaureas*, or other silvery foliaged plants. Mixtures of Fuchsias, *Plumbago capensis*, variegated and flowering *Abutilons*, *Acacia lophantha*, *Gladioli*, *Marguerites*, tuberous and fibrous rooted *Begonias*, *Salvias*, *Zinnias*, and *Heliotropes*, quickly fill large beds, and are particularly to be recommended for semicircular and other borders with a background of high shrubs. Anything is better than half empty beds, and there are plenty of greenhouse or conservatory plants that would look and thrive better planted out than in a half-starved state where they now are.

OTHER CHANGES might be made in the arrangements, a better use being made of several kinds of annuals and a few other kinds of plants. *Gaillardias*, if given an open position and good room, are very showy in beds, also affording abundance of cut flowers. The best for the purpose are *G. picta* and *Lorenziana*. Fill the centre of a circular bed with them, and edge with *Coleus* and *Lobelia*. Ten-week Stocks, *Princess Alice* excepted, do not last long enough to be given a place in prominent beds, but strong plants of the *Mid-Lothian* and earliest flowering autumn Stocks are very suitable for beds and ribbon borders. Given a fairly good soil they will flower grandly from July till very sharp frosts intervene. *Zinnias* in masses are very attractive, quite gorgeous in fact, and no one need hesitate about giving them a place in a prominent bed, or say, by way of a substitute for tall growing Zonal Pelargoniums. Nothing can well be more showy than *Asters*, and these can be had in separate colours and relied upon to come true to name. The *Empress* (Veitch), crimson, white and light blue, are particularly well adapted for bedding out, and present level masses of colour not easily equalled by any other kind of bedding plants. The taller growing varieties peg down well, and develop quite a carpet of colour. Naturally they are over some time before frosts destroy the tender plants generally, but this difficulty is easily got over, and a variety given in the garden by having a number of stocky plants of *Chrysanthemums* *Madame Desgrange*, *C. Wermig*, and *Felicity*, ready to take the place of the *Asters*. These *Chrysanthemums* transplant readily and flower well in the open beds. Several of the dwarf summer or earliest autumn flowering

Chrysanthemums are quite gay and continuous flowering enough for flower beds, the neat growing La Petite Mary being suitable for front rows. If Poppies are sown or planted out from pots where they are to flower in masses they present a mass of colour during the early of the summer, but are soon disfigured by seed pods. These ought, therefore, to be early followed by Chrysanthemums, or something that will flower in the autumn. Dwarf Nasturtiums are excellent substitutes for Zonal Pelargoniums, these withstanding much rain and also dry weather well. Somewhat poor ground suits them best, and they must have good room, being either planted or thinned out where they are sown to not less than 1 foot apart each way, much of the beauty of the foliage and flowers being lost when the plants run into each other. The Tom Thumb varieties come true to name, and masses or lines of one colour can be had, if preferred, to mixtures. Dell's Crimson or similar forms of garden Beet are a good substitute for Iresines, and a suitable edging for beds filled with tall plants. It is too late to sow where the plants are to grow, but the thinnings from the kitchen garden might be used with advantage.

PLANT HOUSES.

Gardenias.—Plants that have flowered may be cut hard back, and washed with an insecticide solution if infested with scale or mealy bug. Place them in brisk heat until they start into growth, and if gentle bottom heat can be provided all the better. Young plants may be placed into 6-inch pots. Pinch those shoots that take the lead, and tie them outwards to induce the plants to push up from the base, which they will do freely when established in these pots.

Poinsettias.—Insert quantities of cuttings singly in small pots and place them under handlights until they are rooted. Keep them close, moist, and well shaded. As soon as these are rooted, if sufficient stock has been obtained, the old plants may be cut close back and allowed to commence growth. If cut close to the soil they will have the appearance of young plants after they have been repotted. Allow them to start in heat and establish themselves after repotting, then gradually harden them to cooler treatment. If kept in strong heat Poinsettias become soft and tall, and the best bracts are always produced by those that make firm sturdy growth. Young plants as they are well rooted should be placed into 5-inch pots, and when they have commenced rooting into the new soil give them intermediate treatment, where they will be fully exposed to the sun. Those raised from portions of the stem will be growing freely in 6-inch pots. Use for these a compost of fibry loam, one-seventh of decayed manure, and sand, pressing the soil firmly into the pots.

Asparagus plumosus nanus.—Where specimens 4 or 5 feet high can be used for room decoration, and those of a light slender nature are appreciated, few plants are more suitable. For this purpose they can be grown in pots, according to the size of the vases in which they are employed. Provide a central stake and secure all the growths loosely to it: With but little care in tying graceful examples can quickly be produced by keeping the plants in heat until the desired size has been attained. Before removing them to rooms they must be thoroughly hardened. Another good plan of preparing plants for this purpose is to place four or five stakes round the sides of the pot, tie them together in the centre, and train the plants round them until the whole of the stakes are hidden from view. When the stakes are furnished no harm is done by cutting the plants occasionally, but the reverse; they grow much more thickly.

Caladiums.—Where these are grown for conservatory decoration remove them from the stove to a vinery where air is daily admitted, they will grow sturdily in these structures, and bear removal to the conservatory without the foliage drooping. From the end of June until the close of September these are most effective in the conservatory. At first avoid placing them close to open ventilators.

Gloxinias.—Frequently these are grown in too warm houses. They will succeed in a vinery where the syringe can be kept from them, and where they can enjoy a fair amount of light. Seedlings when once established in small pots must be placed into cooler quarters. Seedlings that are just up will, if cared for, make good flowering plants by autumn. Those that have practically flowered should be placed in a cool, light place, and supplied with water until the foliage naturally dies.

Euphorbia jacquiniæflora.—Place into 3-inch pots all that are rooted, and start them into growth in brisk heat. Insert plenty of cuttings, and cut back a portion of the old stock and allow them to start into growth. There is some difficulty in obtaining abundance of these plants unless one method is practised, and then scarcely one damps off. Allow the old stool plants to make growths 3 inches in length in a warm house, and then remove them to a cool one fully exposed to the sun for ten days or a fortnight. The cuttings will not have grown much, but if they are slipped up with a sharp knife close to where they issue from the old stem and are inserted in sandy soil under handlights, watered and shaded from the sun, nearly every one will root.

Justicia flavicoma.—Where stock plants have been retained cuttings will be plentiful. Insert these in small pots, and grow them without pinching. Those raised from cuttings annually are the best. Old specimens are subject to attacks of scale if they are checked. Where the stock is limited old plants may be grown on as well as those raised by means of cuttings. Few plants are so useful for conservatory decoration as this old favourite, and it deserves to be grown more generally in quantity than is the case at present.

THE BEE-KEEPER.

APIARIAN NOTES.

WINTERING BEES

I HAVE frequently alluded to, and if anyone wishes to know why my bees are in so good condition, is simply because I practise what I write, and what I have proved to be rational management, that is all. One of the questions involved is, How is it your hives are so far advanced in brood from many other bee-keepers? My answer is the same as above. The crowns of my hives allow of an insensible upward ventilation, which retains the heat, yet allows the vitiated and respired air to pass away without a draught or leaving damp behind inside the hive, which reduces the temperature to a dangerously low degree. Then as bees naturally cluster some distance from the crown, preserving the honey, and a heated space above them, the bees are kept healthy, and their food wholesome, and never colder than what is congenial for them to eat during the lowest temperature we are acquainted with, and breeding goes on uninterrupted from the end of December, which keeps bees in a more healthy state than when breeding is disallowed by the unnatural process of bringing the bees above their combs. Just think of the two plans, which is the most likely to succeed? Any novice may easily answer the question without the risk of giving it a trial.

I never had any difficulty in wintering bees, and I have experienced some severe winters. The trying time as it has been so well exemplified this year generally begins with March, and continues at times till far on in June, and sometimes throughout the whole summer. To keep up the prosperity of hives if the weather is untoward and prevent the loss of bees feed them with pea meal mixed to a thin paste with pure honey inside the hive.

I regret to hear that some bee-keepers have been wintering their bees in single cased hives without protection. No doubt they have been misled by reading the discussions on single versus double walled hives. The latter are intended to be self-protecting, but are inferior in every respect to well protected single cased ones, but which should be kept at one uniform quantity of cover the year throughout. Two inches of dried grass between two plies of material such as scrim upon the sides, covered with an oilcloth, with from 4 to 6 inches on the top, and over this a curved iron roof, cannot be well excelled.

ROBBING.

With the slight improvement in the weather, with but a paucity of flowers, robbing will be the order of the day, strong hives will be making continual raids upon weaker ones, and when, by bees' wiles they soon overcome the propensities of defence in the weaker stocks, and in a short time are *non est*. Great caution for some time to come will have to be taken to prevent a beginning, for when once begun the end will be near, but where there is no beginning there will be no end, but all will prosper to the ultimate profit of the bee-keeper.—A LANARKSHIRE BEE-KEEPER.

QUEEN EXCLUDER ZINC.

THIS is used for the purpose of obtaining honey free from all impurities by all advanced modern bee-keepers by confining the queen bee, the mother of all the bees, to what is generally called the body of the hive, where all the brood should be reared. Formerly the queen had access to the whole hive, no matter how many storeys or boxes, and not unfrequently the honeycomb in the supers was spoilt by brood having been reared in the centre, of what would otherwise have been pure virgin honeycomb. Many fine supers have been disqualified at the various exhibitions on this account.

After many experiments with perforated zinc of various shapes and sizes, there is a consensus of opinion among the scientific bee-masters of England, Canada, and the United States as to the size of perforations that will allow the worker bees to pass freely to build their comb and deposit their store of honey, and at the same time prevent the queen and drones from passing beyond the brood chamber.

In America Dr. Tinker of New Philadelphia, Ohio, perfected several patterns, all having the same size perforations, but differing in the arrangement of the holes and the width of metal between them. In *British Bee Journal* of April the 9th is an impression of a piece of one of Dr. Tinker's patterns, which the editors say is "the most perfect form of excluder we know." At the request of one of their customers, Messrs. C. J. Harvey of Lewisham, S.E., have made a quantity of queen excluder zinc, for which special tools were made with perforation of exactly the same size as those in Dr. Tinker's pattern, from a piece of which it was taken. This differs slightly from that illustrated in the *B. B. Journal*, in that the metal between the openings is narrower, making more openings in a given distance for the bees to pass, and having less chilling surface of metal. Notwithstanding there is less metal it is stronger and not in the least liable to be bent or bulged as the zinc. No. 14 gauge is much stouter than that hitherto used. So far as my judgment goes the pattern which he calls the British is superior to any other excluder made.

Mr. C. W. Abbott of Southall was, I think, the first (now many years ago) to use excluder for the purpose of obtaining virgin honeycomb. He placed a piece on either side of a frame, in which a full sheet of foundation was fixed, which he put in the centre of the brood nest, and so obtained honeycomb earlier than could be done in any other way. Mr. Abbott afterwards used it in his combination hives, placing a divider of zinc at the back of the brood frames, and frames of foundation on the other side for extracting, or a wide frame containing sections for comb honey. These hives are still preferred by many. I much prefer storifying hives, giving additional space at the top, as advocated many years ago by the late Mr. Woodbury in your paper, and as was done in the Stewarton hives, also described.

The hives most in favour now both in Europe and America are worked on this plan. In Great Britain the swarm is put into a hive that contains nine or ten standard frames. As soon as honey is coming in, and the number of bees warrant it, and before they get the swarming fever, a piece of excluder is placed on the top of the frames and a 6-inch shallow hive upon it. If we are working for extracted honey, that is honey taken from the comb in an extractor by centrifugal force, the combs being returned to the hive to be refilled, additional shallow boxes being added as the population increases. If comb honey is desired crates of $4\frac{1}{4}$ by $4\frac{1}{4}$ sections are placed above the excluded; a second and third being added if circumstances require. In either case, by the use of the excluder the purest honey is obtained.—JOHN M. HOOKER, 9, Beaufort Gardens, Lewisham, S.E.



•• All correspondence should be directed either to "THE EDITOR" or to "THE PUBLISHER." Letters addressed to Dr. Hogg or members of the staff often remain unopened unavoidably. We request that no one will write privately to any of our correspondents, as doing so subjects them to unjustifiable trouble and expense.

Correspondents should not mix up on the same sheet questions relating to Gardening and those on Bee subjects, and should never send more than two or three questions at once. All articles intended for insertion should be written on one side of the paper only. We cannot reply to questions through the post, and we do not undertake to return rejected communications.

Bordeaux Mixture (*W. E. T.*).—The information you require is embodied in our reply to another correspondent ("J. R.") in the present issue.

Elliott's Shading (*F. L.*).—Many persons who have used it find it satisfactory, and we believe it has a large sale. It is advertised, and can be had from most seedsmen and dealers in garden requisites.

Drying Flowers (*C. C.*).—We will refer your letter to our correspondent, and give you his reply in another issue. The ingredients of all such mixtures can usually be changed for several others of a similar character.

Cool Orchids (*P. J. C.*).—We will forward your letter to our correspondent, who may perhaps be able to supply some details on the method of culture pursued in the achievement of the satisfactory results to which you refer.

A "Double" *Odontoglossum citrosum* (*T. W. S., Morpeth*).—The flower is a peculiar one, and seems to be the result of a complete fasciation, as all the parts of the flower are present in each, and the two peduncles are distinctly traceable. It would no doubt occur early in the bud stage.

Diseased Cucumbers (*W. H.*).—We are sorry to inform you that your Cucumbers are stricken with a disease that is practically incurable. It is caused by minute nematoid worms that take possession of them, and may have been introduced in the soil, manure, or water. All you can do is to cut off the worst parts, mulch the bed with a mixture that will incite fresh roots, water with a solution of nitrate of soda twice a week, 1 oz. to a gallon of water, and maintain a high temperature for encouraging fresh growths and the quick swelling of the fruits.

Stopping Vines (*A. P. T.*).—In stopping the laterals the point should be nipped off as soon as it can be taken hold of with the finger and thumb without injuring the small leaf at the end which is to be left to develop. When the Vines are close together this may be the first leaf beyond that opposite the bunch, or the second leaf if there is space for the full expansion of all the foliage, not otherwise, as overcrowding the leaves is injurious to Vines. The laterals should not be less than 15 inches apart along each side of the rods. It is not usual to top the leader, but it is sometimes done when very strong and the laterals below it very weak in comparison.

Tomato Blossoms Falling (*H. H.*).—This usually arises from keeping the plants too close and warm. The remedy is more air, especially in the early part of the day, with due but not excessive supplies of water at the roots. If the plants are weak afford a sprinkling of steamed bone meal or superphosphate of lime occasionally on the surface; if exuberant keep them dry. Sometimes the non-using a feather or camel's-hair brush, applying the pollen to the setting, is due to want of fertilisation; therefore fertilise the flowers, central part of the flower, and you will be rewarded by a good set of fruit, but take care to have the house well ventilated and to fertilise the flowers as they expand during the early part of fine days.

Calceolarias (*W. Mowbray*).—The flowers you have sent, five to ten on a branchlet, are equal to any we have seen, and far above the average in size, colour, and quality. There were no better at the Temple Show, and your plants "in 16-size pots, 2 feet through the heads of bloom, and plants and pots 18 to 20 inches high," would have stood an excellent chance of a medal if they had been exhibited at the Show in question. Sir C. Pigott's handsome specimens, grown by Mr. Ford, were highly and deservedly honoured, and yours appear to be of a similar character. It is a pity you "could not get them to the Show." Many persons would like to know how you manage to grow such very fine plants and blooms.

Exporting Vegetables (*C. G.*).—We have no doubt that both Cabbages and Cauliflowers have been sent from the London market gardens to France and Holland, but far more vegetables were imported from those countries in past times than were exported from England. At one time all the Cauliflower seed sold in this country was raised in Holland, and it used to be customary to obtain plants from there for growing in our market gardens, as well as private gardens, dealers paying visits to the Continent for purchasing them in large quantities for this purpose. We have seen large crates of early Cabbages, Rhubarb, and Cucumbers being conveyed by steamer to Antwerp during recent years. We shall be glad to have the transcript at any time convenient to yourself.

Cottage Gardening (*J. D.*).—It depends entirely on the educational capacity of the men whether your well meant proposal will answer or not. Some men acquit themselves most creditably in the garden or allotment field who would be quite unable to write a paper that would do them either justice or credit, while others are somewhat apt with the pen, but not the best cultivators; or, in other words, some work well but cannot write, while others write well but do not work effectively. Since you intend offering a prize, why not let the subject be—"How to Make the Best of a Garden Plot"—of half an acre, or whatever the extent may be? The competitors would then name the vegetables they had found best, and tell the methods of growing and arranging the crops. If you adopt our suggestion we should rather like to see the prize paper.

Carnation Plants Dying (*T. B. D.*).—The plants of *Souvenir de la Malmaison* "dying off one by one," are no doubt destroyed by the very small worm, which is probably the larva of one of the skipjack or click beetles. These are very fond of Carnations, and eat into the root stems, living on their substance. You may water the plants with a solution of nitrate of soda, dissolving half an ounce in a gallon of water. This may cause the pests to leave the plants, and to trap them insert pieces of Carrot just within the soil, and if a pointed stick is thrust into each it will serve to examine the baits by. This should be attended to every day and the worms destroyed. When Carrots cannot be had use Potato baits instead, but the wireworm prefers the Carrot. Do not repeat the nitrate of soda application more than twice, with a week interval between, and dust around the plants with soot. This will drive away the pests.

Revising Matter for Press (*Contributor*).—You are sorry we curtailed the matter you sent. You ought to have been glad that we did not allow you to weaken your evidence. You may not have intended the personal references to be offensive, but all the same they would have provoked a rejoinder that you would scarcely appreciate. If any writer had alluded in similar terms to yourself the article would certainly have been curtailed. If you reflect a moment on the whole subject you will perhaps arrive at the conclusion that it is not in our interest to cast aside matter of public interest. There was a great deal too much husk with the kernel, and we simply threw the husk away. We are pleased to

note your intention in the future. Garnishing is acceptable when appropriate, but what you refer to as "oil for the salad" was a little too rancid to be palatable. You will observe we have taken care not to reveal your identity.

Tomatoes Failing (J. R.).—Upon further investigation of your plants we find them infested with the dreaded Potato disease—namely, *Phytophthora infestans*. There are two methods of treatment—1, To destroy the plants, but that is of no use unless you also destroy the fungus. Therefore wash the house with a 10 per cent. solution of sulphate of iron, and apply a dressing of that substance to the soil at the rate of half an ounce to the square yard; then you may put in fresh plants with a chance of success. 2, Spray the plants with Bordeaux mixture made according to the following formula:—Sulphate of copper 6 lbs., dissolved in 4 gallons of hot water; quicklime 4 lbs., dissolved in 4 gallons of cold water. Mix the two together by pouring the limewash into the copper solution slowly, and dilute to 22 gallons with cold water. This must be sprayed, not syringed, on the plants, so as to wet them thoroughly on the under side of the leaves as well as the upper, also the stems; in fact, every part. Repeat, if necessary, in twelve or fifteen days. We commend the spraying of all plants infested with the dreaded *Phytophthora infestans* on its very first appearance, particularly the Potato and Tomato. The above is a 2½ per cent. solution of sulphate of copper. It must not be exceeded, and if applied in time will destroy the fungus. If the foliage is very tender employ a weaker solution, but not less than 2 per cent. The advertised "Anti-Blight" is found to destroy fungoid growths and not injure plants.

Grapes Scorched and Rusted (J. H.).—We are sorry you did not write to us before, as it is not in the power of man to make the shrivelled berries plump again, or the rusted berries clean. All the former must be cut out, and as many of the worst of the latter as can be done without spoiling the bunches. It is possible the border has been moist enough on the surface by the dripping from the plants (which ought to be avoided by having a close stage) but too dry below. You had better examine it by digging down with a trowel, and if you find dry soil, pour on sufficient tepid water to moisten the entire mass, then follow with liquid manure. There has also been some error in the ventilation, and we suspect the house has on more than one occasion been kept closed too long in the morning. We have known more than one house of Grapes spoiled on a Sunday morning through the attendant finding the temperature much too high, then lowering it by too free ventilation—throwing open the sashes too wide at once. That is the way to make Grapes rust and scald. You must commence ventilating earlier, and admit more and more air gradually with the steadily increasing temperature, and reduce the air gradually in the afternoon. We also strongly advise you to examine every bunch at once, and touch every mealy bug you can find with a feather dipped in lemon oil or methylated spirit. If you do not do this promptly and repeatedly the Vines will soon be overrun with the filthy pest, the Grapes rendered worthless, and your character jeopardised. We find numbers of the insects on one of the small bunches, yet you do not mention them. We are bound to say your management has not been so good as it ought to have been, and we say this with the object of stimulating you to more thoughtful work and strenuous endeavour. We wish all young men who do not feel sure what to do would write to us fully in good time, and we might be able, as we should certainly be willing, to avert possible disaster.

The Edible Morel (C. J.).—What you send is a very fine specimen of the Morel, *Morchella esculenta*. In some districts and seasons Morels are plentiful, but in many localities they are seldom if ever seen. We have usually found them the most abundant in rather damp positions under trees, but have also gathered them from moist treeless banks, the soil no doubt containing a good deal of vegetable matter. The following extract from the "Eatable Funguses of Great Britain" may perhaps be of interest to you and other readers:—"From the complaint that Dr. Badham makes, that in England this Fungus is only known as an article procurable at the Italian warehouses, we surmise that he has not been brought up among the thrifty housewives of Yorkshire. In the kitchens of that county, at any rate of the northern and western divisions of it, a string of Morels pendant from the ceiling is as familiar an object as a bunch of Sage twigs or bundles of Thyme, and the heads of the household complain of the cook's neglect if she omits the Morel flavour in certain sauces. As children we knew the plant at sight, and brought it home whenever we encountered it in our walks; and the poor knew it also, for ever and anon the women who gathered Cowslips for the wine brewing would bring a few in the corner of their basket, and plead for an extra shilling for the 'Jew's Ears,' as they were pleased to call the Morel. In Germany the excellence of the Morel was well appreciated, and finding that it flourished the most luxuriantly on wood ashes it became a regular system to burn down a portion of the forest annually to secure a crop of Morels. This custom was stopped by an edict of the Government, and thus legislation was turned against the Fungi. M. Roques gives some receipts for the dressing of the Morel, which our readers may find serviceable:—'1st. Having washed and cleansed them from the earth, which is apt to collect between the plants, dry thoroughly in a napkin, and put them into a saucepan with pepper, salt, and Parsley, adding or not a piece of ham; stew for an hour, pouring in occasionally a little broth to prevent burning. When sufficiently done bind with the yolks of two or three eggs, and serve on buttered toast. 2nd. *Morelles à l'Italienne*.—Having washed and dried divide them across, put them on the fire with some Parsley,

Scallion, Chervil, Burnet, Tarragon, Chives, a little salt, and two spoonfuls of fine oil. Stew till the juice runs out, then thicken with a little flour; serve with bread crumbs and a squeeze of Lemon. 3rd. *Stuffed Morels*.—Choose the freshest and whitest Morels, open the stalk at the bottom, wash and wipe them well, fill with veal stuffing, anchovy, or any rich farce you please, securing the ends, and dressing between thin slices of bacon. Serve with a sauce like the last."

Names of Plants.—We only undertake to name species of plants, not varieties that have originated from seed and termed florists' flowers. Flowering specimens are necessary of flowering plants, and Fern fronds should bear spores. Specimens should arrive in a fresh state in firm boxes. Slightly damp moss, soft green grass or leaves form the best packing, dry wool the worst. Not more than six specimens can be named at once, and the numbers should be visible without untying the ligatures, it being often difficult to separate them when the paper is damp. (*Ignorant*).—The package was damaged and some of the figures displaced. 1, *Dendrobium fimbriatum oculatum*; 2, we could not find; 3, *Selaginella sulcata*; 4, *Pteris serrulata*; 5, *Selaginella levigata*. (*E. M.*).—A poor specimen, but apparently *Prunus Padus*. (*A. D.*).—1, *Ajuga reptans*; 2, *Pyrus spectabilis*; 3, resembles *Prunus Pissardi*. (*Matfen*).—1, *Cattleya Mossiae*; 2, *Lycaste Harrisoniae*; 3, *Polygonum compactum*; 4, *Caltha palustris fl.-pl.*; 5, *Leucocjum aestivum*; 6, *Swainsonia galegifolia alba*.

COVENT GARDEN MARKET.—JUNE 3RD.

Business better, with supplies shorter.

FRUIT.

	s.	d.	s.	d.		s.	d.	s.	d.	
Apples, ½ sieve	1	6	to	6	0	Kentish Cobs	40	0	to 50	0
" Nova Scotia and						Lemons, case	15	0	20	0
" Canada, per barrel	15	0	26	0	Oranges, per 100 ..	4	0	9	0	
" Tasmanian, case	6	0	14	0	Peaches, per doz...	6	0	24	0	
Grapes, New, per lb.	2	6	4	0	St. Michael Pines, each..	3	0	8	0	
					Strawberries, per lb. ..	1	6	5	0	

VEGETABLES.

	s.	d.	s.	d.		s.	d.	s.	d.	
Asparagus, per bundle ..	0	6	to	2	6	Mushrooms, punnet ..	1	6	to 2	0
Beans, Kidney, per lb. ..	0	9	1	0	Mustard & Cress, punnet	0	2	0	0	
Beet, Red, dozen	1	0	0	0	Onions, bushel	3	0	4	0	
Brussels Sprouts, ½ sieve	0	0	0	0	Parsley, dozen bunches	2	0	3	0	
Cabbage, dozen	3	0	0	0	Parsnips, dozen	1	0	0	0	
Carrots, bunch	0	4	0	0	Potatoes, per cwt. ..	3	0	4	0	
Cauliflowers, dozen ..	3	0	6	0	Rhubarb, bundle	0	2	0	3	
Celery, bundle	1	0	1	3	Salsafy, bundle	1	0	1	6	
Coleworts, doz. bunches	2	0	4	0	Scorzoneria, bundle ..	1	6	0	0	
Cucumbers, doz.	3	0	5	0	Seakale, per bkt. ..	1	0	1	6	
Endive, dozen	1	0	0	0	Shallots, per lb. ..	0	3	0	0	
Herbs, bunch	0	2	0	0	Spinach, bushel	5	0	6	0	
Leeks, bunch	0	2	0	0	Tomatoes, per lb. ..	1	0	1	3	
Lettuce, dozen	3	0	3	6	Turnips, bunch	0	0	0	4	

AVERAGE WHOLESALE PRICES.

CUT FLOWERS.

	s.	d.	s.	d.		s.	d.	s.	d.	
Anemone, dozen bunches	2	0	to	4	0	Mignonette, 12 bunches..	3	0	to 6	0
Arum Lilies, 12 blooms ..	2	0	6	0	Mimosa (French), per					
Azalea doz. sprays	0	9	1	0	bunch	1	3	1	6	
Bluebells, dozen bunches	1	0	2	0	Myosotis, dozen bunches	2	0	4	0	
Bouvardias, bunch	0	9	1	0	Narciss (Various) dozen					
Camellia, white, per doz.	2	0	4	0	bunches	1	0	3	0	
Carnations, 12 blooms ..	1	0	2	0	Narciss (double white)					
Cowslips, dozen bunches	0	6	1	0	dozen bunches	4	0	8	0	
Cyclamen, doz. blooms ..	0	3	0	6	Pansies, dozen bunches..	1	0	2	0	
Eucharis, dozen	3	0	6	0	Pelargoniums, 12 bunches	4	0	9	0	
Gardenias, per doz. ..	1	0	3	0	" scarlet, 12 bnchs	4	0	6	0	
Iris (Various) doz. bchs.	6	0	12	0	Primula (double) 12 sprays	0	6	1	0	
Lapageria, 12 blooms ..	2	0	4	0	Primroses, dozen bunches	0	4	0	9	
Lilac (English) per bnch.	0	6	1	0	Roses (indoor), dozen ..	0	6	1	6	
" (French) per bunch	5	0	6	0	" Red (English) per					
Lilium longiflorum, 12					dozen blooms	2	0	4	0	
blooms	3	0	4	0	" Red, 12 bls. (Frch.)	2	0	4	0	
Lilium (Various) dozen					" Tea, white, dozen..	1	0	3	0	
blooms	1	0	3	0	" Yellow, dozen	2	0	4	0	
Lily of the Valley, dozen					Spiraea, per bunch	0	6	0	9	
sprays	0	6	1	0	Tuberose, 12 blooms ..	0	6	1	0	
Lily of the Valley, dozen					Tulips, per dozen	0	3	0	6	
bunches	4	0	9	0	Violets (Parme), per bch.	3	0	4	0	
Maidenhair Fern, dozen					(dark), per bch. ..	1	0	1	6	
bunches	4	0	9	0	" (English), doz. bnch	0	6	1	0	
Marguerites, 12 bunches	2	0	4	0	Wallflower, doz. bunches	1	6	3	0	

PLANTS IN POTS.

	s.	d.	s.	d.		s.	d.	s.	d.	
Aralia Sieboldi, dozen ..	6	0	to	18	0	Geraniums, Ivy, per doz.	4	0	to 8	0
Arbor Vitæ (golden) doz.	6	0	8	0	Hydrangeas, per doz. ..	9	0	12	0	
Arum Lilies, per doz. ..	9	0	12	0	Lilium longiflorum, per					
Azalea, per plant	2	0	3	6	dozen	13	0	30	0	
Calceolarias, per dozen	5	0	9	0	Lobelia, per doz.	4	0	6	0	
Cineraria, per doz. ..	5	0	8	0	Marguerite Daisy, dozen	6	0	13	0	
Cyclamens, per doz. ..	9	0	18	0	Mignonette, per dozen ..	4	0	9	0	
Deutzia, per doz.	6	0	8	0	Musk, per doz.	2	0	4	0	
Dracena terminalis, doz.	24	0	42	0	Myrtles, dozen	6	0	12	0	
" viridis, dozen ..	12	0	24	0	Palms, in var., each..	2	6	21	0	
Erica, various, dozen ..	12	0	24	0	Pelargoniums, per doz. ..	9	0	18	0	
Euonymus, var., dozen ..	6	0	18	0	Pelargoniums, scarlet, per					
Evergreens, in var., dozen	6	0	24	0	dozen	4	0	9	0	
Fairy Roses, per doz. ..	6	0	9	0	Saxifraga pyramidalis, per					
Ferns, in variety, dozen..	4	0	18	0	doz.	0	0	0	0	
Ficus elastica, each. ..	1	6	7	0	Spiraea, per doz.	8	0	12	0	
Foliage plants, var., each	2	0	10	0	Stocks, per doz.	4	0	6	0	
Genista, per doz.	6	0	9	0	Tropæolums, per dozen ..	3	0	6	0	

Bedding plants (in variety) in boxes, from 1s. to 3s.; in pots, per doz., 1s. to 2s.



GOOD BUTTER.

It may be well to remind our readers that care, watchfulness, and a regular system, combined with scrupulous cleanliness, are as necessary to success as close attention to detail in every part of dairy management. Watch results closely, and if they are not entirely satisfactory do not rest till they are so. That results are often puzzling there can be no doubt, as, for example in the case of "Perplexed," who says, "Our churn is without dashers; we stop churning when the butter is in grains, it is then well washed until the water is quite clear, and is then worked with a Bradford's butter worker, but the butter will not keep good, and 'goes off' in a day or two." With the cows entirely upon grass as they are now, and such careful churning, the butter ought not to lose quality. The cause must therefore be sought for in surroundings of the butter after it is worked and made up. We have repeatedly known butter to "go off" so much in a day or two in a grocer's shop as to be practically unfit for table; and there can be no doubt that in that brief space of time it absorbs enough of the thousand and one odours given off by the goods around it to spoil it. Bacon, cheese, Spanish Onions, tobacco, spices, Oranges, and all the multifarious stores of an enterprising grocer and provision dealer are there. Can we wonder therefore that a substance so sensitive to taint as butter is should under such conditions "go off" and become unpalatable quickly?

Precisely the same thing happens in a private house. The cream may be well managed, the churning well done, the butter worked and made up in an entirely satisfactory condition, but if it is then suffered to come in contact with impure air, so surely does it lose quality. Clearly, what we have to ascertain is the reason of atmospheric taint, and to remove it at once. It may come from anything, from the store-room itself, the walls, the floor, woodwork, or drainage; but much more frequently is it from other food, or the general contents of the store-room. It may safely be laid down as a general rule that butter should never be placed in or upon anything that is not quite sweet and clean. One of the most simple, inexpensive, and efficient store-rooms for butter we know is that of Lord Spencer's dairy factory at Harleston, which is just a square room with perfectly clean walls and floor, without a single article of furniture or utensil of any sort in it, nothing but iron brackets on the walls. As the butter is made up in the adjacent dairy it is placed upon common roofing slates, which, as they are filled, are taken into the store-room and placed upon the brackets, where the butter remains till it is packed for despatch to market. The drainage, be it said, is entirely upon the surface, so that as the floors of the store-room and other parts of the factory are washed the water passes quite away from the buildings at once. The importance of this is obvious, for it must not be forgotten how often foul air enters the dairy by the drains and windows, and in more than one instance have we known the windows of a farm dairy to open upon a yard full of manure reeking with foul odours.

Predisposing causes of failure must also have attention. The use of Carrot juice as colouring matter is objectionable, because such vegetable matter quickly decays and spoils butter. Then, too, there is the importance of thorough cleanliness of utensils and all the surroundings of the cows. Objectionable as is the exposure of the cows on Leicestershire farms, yet the practice in force there of milking out on the pasture and the use of bright clean tin utensils precludes the possibility of tainted milk, except it be from the hands of the milkers, which we fear are not always perfectly clean. A dry clean hand for milking and a clean udder are alike impor-

tant. It is when cows are milked in dirty cowhouses by dirty cowmen in dirty pails that the milk is tainted. It is also when cows drink foul water or eat improper food that milk is tainted, neither of which causes ought to be possible now that the cows are out altogether upon pasture.

With a full yield of milk from grass-fed cows good butter ought to be a certainty; if it is not so, then let every detail in cowshed and dairy be looked closely into, and faulty practice in some form or other will certainly be detected. The remedy is not difficult; see that it is prompt and thorough, and in future be always on the alert to prevent recurrence of such faults. We regret knowing that there is so much carelessness and negligence on the part of those having charge of cows and dairy; nor is this always the negligence of servants, but very frequently of farmers whose losses by the death of valuable animals and the low prices realised from the sale of inferior produce so often mount up to a ruinous extent.

We have striven to formulate no strict set of rules in these articles, but rather to jot down hints for general guidance as they occurred to us. To any of our readers having dairy difficulties which they are unable to overcome, we say Try, and send us full particulars at once, and we may probably be able to indicate safe lines of possible improvement.

WORK ON THE HOME FARM.

The calving of old cows and heifers is almost at an end for this season, and dairy work is daily on the increase. The low temperature and frequent changes of weather has made it an anxious time for cheese makers, and they are fortunate who have a well arranged dairy with an efficient heating apparatus for keeping the cheese room at a steady temperature of 60°. Butter making has also required an extra amount of care and forethought under such trying changes of weather; but by strict attention to details there has been a steady improvement in the appearance as well as in the quality of the butter. With hand churns it is of much importance to have an experienced churner. A raw hand will dash away without rhyme or reason, and soon spoil the butter. Churning should always begin slowly, and the speed should increase to a steady uniform rate, rather fast while the weather continues cold, and slow with warmer weather. Churning should be simply agitation, and butter-working pressure; in neither thing should there be excessive friction. Any tendency of the cream to swell in churning is easily checked by the addition of a little salt; but if powdered saltpetre is used in the cream work there should be no trouble with cream swelling.

The cows have required very close attention, and a certain amount of contrivance has been requisite to house the calves and keep them clean and comfortable. We altogether object to any exposure of young calves, and they are never by any chance let out of their warm dry quarters at this season of the year. Delicate cows low in condition are still having the mixed dry food at milking time at the rate of 4 lbs. each time, which tends to improve condition and promote a full flow of exceptionally rich milk. Milk of high quality is all-important at every home farm, and it is only exceptionally good old cows that are kept long in the herd. Those of moderate quality are got rid of before there is a material falling off in quantity or quality of milk, sound young cows being altogether preferred, and our number is well sustained by bringing some heifers into the herd every spring. Keep no inferior cows; they consume as much food and often require more care than really good ones. The way to insure this is to retain every heifer of promise, as heifers not wanted are easily sold at prices which afford some margin of profit.

METEOROLOGICAL OBSERVATIONS.

CAMDEN SQUARE, LONDON.

Lat. 51° 32' 40" N.; Long. 0° 8' 0" W.; Altitude, 111 feet.

DATE.	9 A.M.					IN THE DAY.				Rain	
	Barometer at 39° and Sea Level.	Hygrometer.		Direction of Wind.	Temp. of soil at 1 foot.	Shade Temperature.		Radiation Temperature.			
		Dry.	Wet.			Max.	Min.	In sun.	On grass		
1891.	Inches.	deg.	deg.		deg.	deg.	deg.	deg.	deg.	In.	
May.											
Sunday	24	29.635	47.9	46.8	N.E.	49.3	50.2	44.3	63.1	37.6	0.510
Monday	25	29.725	43.6	41.4	N.	48.7	49.9	40.4	83.8	40.7	0.024
Tuesday	26	29.722	51.1	44.7	S.W.	48.0	57.4	40.3	106.8	36.2	0.042
Wednesday	27	29.614	48.7	45.6	S.W.	48.3	56.7	39.4	86.5	34.2	0.024
Thursday	28	29.680	50.6	45.4	S.W.	48.7	59.7	42.9	107.4	37.3	0.062
Friday	29	29.793	51.1	49.3	S.E.	49.0	62.3	45.0	104.3	40.0	0.119
Saturday	30	29.789	51.3	50.4	N.	49.9	61.3	49.0	85.6	47.4	0.017
		29.708	49.2	46.2		48.9	56.8	43.0	91.1	39.1	0.793

REMARKS.

- 24th.—Wet from 6 A.M. to 1.30 P.M., and 3.45 to 10 P.M.; thunder and lightning at intervals from 4 to 9 P.M.
 25th.—Overcast, with frequent slight showers.
 26th.—Bright early, and at times during the day; rain at noon and from 4 to 5 P.M.
 27th.—Variable; a good deal of bright sunshine, but frequently threatening, and occasional showers.
 28th.—Fine and generally bright in morning; frequent showers with sunshine between in afternoon.
 29th.—Bright early; wet from 8 to 9 A.M., then bright again; generally cloudy in afternoon, and wet from 5 to 10 P.M.
 30th.—Gloomy and drizzly all morning; fair afternoon with some sunshine.
 A cold damp week with very little sunshine.—G. J. SYMONS.



EARLY in the present year I had the opportunity of spending a few days in Paris, and amongst the horticultural excursions which fully occupied the comparatively short time at my disposal, one of the most enjoyable was that undertaken, in very pleasant companionship, to the Peach gardens at Montreuil. Frequently had I heard and read of the pomological wonders to be there seen; frequently had I wished for the chance to personally inspect them, and most eagerly I accepted the kind offer of a resident friend to guide me thither and to procure introductions to the chief cultivators.

Montreuil is some nine or ten miles to the westward of Paris, a moderate size suburban town, easily reached by 'bus from Paris, or by tram to Vincennes, which is only a short walk from the town, and as we had to call for instructions upon M. E. A. Carrière, the veteran editor of the *Revue Horticole*, on the way, the latter route was the more convenient. M. Carrière at once entered into the object of our visit, most readily communicated some interesting particulars, and favoured us with cordial introductions to the leading Peach growers in the district. But for the very evident fact that he was only too slowly recovering from a prolonged illness he would have willingly accompanied us on the journey, but this pleasure we had to forego. As one of the oldest and most practical horticultural writers in France, M. Carrière has gained a great reputation, and is highly respected; his indisposition has consequently been regarded with much concern, and I am pleased to learn that, having subsequent to my visit passed some time in the South, he has returned in greatly improved health. Quitting our genial friend, a few minutes' walk brought us to the first of the Peach gardens, and several others were passed on the way to the establishment of M. Gustave Chevalier fils, and as they are all of a similar character, the latter being thoroughly representative in every respect, a description of that will suffice to indicate the features of an important industry.

First, it may be remarked that Montreuil itself is notable for the elevated and hilly character of the district, on a limestone formation which in several places comes very close to the surface with only a few inches of soil above it. This of course provides the great essential in stone fruit culture, an abundance of calcareous matter, but in other respects it is not particularly favourable, being in many cases cold, heavy, and difficult to work. Then again it does not appear that there is anything specially favourable in the climate except in one important respect, and that is a clearer atmosphere than is usual in Britain, the greater sun force ripening the wood thoroughly and enabling the trees to better resist winters quite as severe as on this side of the Channel. One thing is certain—a considerable amount of labour has been expended in the development of the Peach-growing business at Montreuil, with close attention to all the details of culture; and though some instances of indolence and ignorance occur with the attendant failures, these form an extremely small minority, and it is seldom where numbers of cultivators are engaged upon the same speciality in the same district that the results are so uniformly satisfactory.

The hillsides have a peculiar appearance, as they are crossed and recrossed with substantial limestone or Cob walls, enclosing tracts of land varying in size from a few rods to an acre or more, but the enclosures are generally small, as a much greater wall

space is thus obtained upon the same area of ground, an important matter where land is so valuable. The tops of the walls are generally covered with sloping tiles or boards, which project about 6 inches beyond the surface, thus affording some slight protection to the trees trained thereon. I was informed that there are nearly 300 occupiers or owners of these small Peach farms, and that altogether 400 arpents, each composed of 3300 mètres, a total of something like 330 acres, are almost exclusively devoted to Peaches in the district. What this represents will be gathered from the following statements supplied by M. Chevalier. It is estimated that about four million Peaches are every year gathered and despatched from these farms, the quantity varying slightly, according to the season. The price obtained for these in the Parisian markets is said to average 100 francs per 1000 fruits, or about one penny each, a total in English money exceeding £16,000. The smaller growers combine Peach culture with other forms of market gardening, but the larger cultivators devote themselves to the Peaches entirely, with the exception of Vines grown for their leaves in the spaces between the walls.

Turning to the trees themselves it may be said that generally these are remarkably healthy, well furnished with bearing wood, evenly and carefully trained, closely pruned, and seem to be comparatively free from the enemies and maladies from which the Peach too often suffers out of doors in England. The walls are about 8 feet high, but some exceed this. The surface is whitened, and the trees are either secured to wires or nailed to the surface, which is usually a thick covering of cement over the stone. There are many trees from twenty to fifty years old, and I was shown one stem which was known to have been planted in 1810, and has never been removed since, though repeatedly regrafted, and it has now as well furnished a head of branches as the best young tree could have. The regrafting or budding is followed out consistently without lifting the old stems, and it is seldom that a tree becomes sufficiently bad to have to be destroyed. The stems are cut in, grafting or budding is performed, and the tree is speedily rejuvenated. In this way, also, all the new and promising varieties are tested in comparison with the older ones, and increased or rejected according to the results secured. One interesting fact is worthy of note here, and that is the practice of placing on one tree several varieties ripening at different times, so as to concentrate the strength of the tree upon successive fruits. I saw some trees with from four to eight varieties upon them for this purpose. Another point strictly observed, too, is placing the weaker varieties in the centre of the tree where the current of sap is strongest, thus equalising the product as far as possible.

It is stated that at least 100 varieties are in cultivation at Montreuil, and it does not appear that any special preference is given to certain varieties, though Sea Eagle is said to sell well as the fruits come very large. Another variety, Admirable Jaune, the Yellow Admirable of the "Fruit Manual," is liked for the same reason, and M. Chevalier has gathered a fruit of this variety weighing over 1 lb., which was sold as a curiosity at one of the leading Parisian restaurants for eight francs. Belle Bauce is a favourite at Montreuil, and is one of the Grosse Mignonne type, and is said to come of fine flavour in France. Dr. Hogg has the following interesting note concerning it in the "Fruit Manual:"—"Although this is an old French Peach and is mentioned in the Chartreux Catalogue of 1775, it was not till long after the beginning of this century that it was introduced to this country. It was raised by M. Joseph Bauce, a Peach grower at Montreuil, and was chiefly brought into notice by M. Christophe Hervy, who cultivated it with special care in the garden of the Chartreux at Paris. It is also mentioned by Roger Schabol in 1774." We thus have evidence of its being grown at Montreuil for considerably over 100 years, and it is still included in a select list of the best with another large fruited variety, Belle Impériale. The Salwey, though often condemned here, is a favourite in France, also the Princess of Wales; Bellegarde, there known as

Galande or Noir de Montreuil; Amsden, and Alexander. Early Rivers is one of the best early varieties, also Early Grosse Mignonne and Belle de Vitry, which I have been unable to identify, and it is said to be a local variety possessing much merit. Madeleine Rouge or the Red Magdalen also succeeds well.

The trees are cropped heavily, indeed they are allowed to carry on an average twice as many as we should here. A tree covering 10 square metres of wall space was pointed out as having borne 400 fruits last season, and this was not regarded as an exceptional crop but about the average. One effect of this continual heavy cropping is that the vigour of the trees is kept within reasonable bounds lifting and root-pruning being rarely practised. A little manurial assistance is afforded in the shape of stable or farmyard manure applied as a light mulching, as much for the sake of preserving the moisture in the soil as for its fertilising qualities. Various forms of training are adopted, but that most in favour is the palmette verrier, which has been several times strongly commended in this Journal, and especially by Mr. Edward Luckhurst some years ago. This form has been proved to be more easily retained in useful bearing condition than any other, the strength of the tree is more equalised, and the crops more even.

In one important respect the French horticulturists unquestionably take the lead of the British, and that is in the recognition accorded to the necessity for practical and scientific education in what may be termed the demonstrative form. At Montreuil, for instance, classes of young students are taken round by qualified men, and all the details of Peach culture fully explained and illustrated, the pupils being tested individually both as to their theoretical knowledge and manual skill. I understand that M. Chevalier has been appointed official instructor, and, judging by the manner in which he discoursed upon the occasion of my visit, he must be an admirable teacher. The preceding is only an outline sketch of the Peach gardens, and is intended merely to indicate the salient features; to do full justice to the theme a small treatise would be requisite.—LEWIS CASTLE.

DR. HOGG'S TULIPS.

"FLORISTS' Tulips are fascinating flowers when you understand them." Such was the remark of a visitor at the recent Temple Show as he was examining the blooms from Mr. Walker and Mr. Lakin. He confessed he did not understand them as he would like, and some of them which he appeared to admire the most would be the least appreciated by the learned florist. I am somewhat of a novice among Tulips, still just able to weed out the bad from the good, especially as I have lately taken a lesson from a master who undoubtedly knows them and grows them well when the Fates are not unkind.

After an examination of the Temple exhibits and the privilege of a talk with the Doctor over them, I ventured to ask if I could see his collection at home. "Yes, certainly," was the reply, "if you do not mind a journey into Sussex, and the flowers are now I think about at their best." His "little place," as he calls it, is most delightfully situated between Tunbridge Wells and Eastbourne. That is as near as I can tell, and as the Tulips are over it will be near enough at present, as they cannot be seen again until next year. I am bound, however, to differ entirely from the Doctor in the description of the "place," for if all the beautiful tract of country were mine, a diversified expanse of hill and dale, woods, copses, and green fields almost as far as the eye can see, and a quaint Old World village nestling in the centre, I should feel myself a man of large possessions. But let that pass. On the southern side of a sunny slope, with a view to the distant sea, we find ourselves under a sheeting tent, on a brilliant day, and commence a talk about Tulips.

The Doctor's chief Tulip bed is planted in the orthodox form of seven bulbs in a row, crosswise. It runs east and west, and there were upwards of 60 rows of plants, most of them flowering. A stout and lofty span-roofed framework is erected over the bed, covered with sheeting, which on the south side reaches to the ground to keep the sun from the blooms. On drawing aside the veil at one end, we found ourselves in a dazzling house of Tulips. "Just in time," was the involuntary observation as we walked down the south side to enjoy the feast of beauty, such a feast as few see in these days, and not soon to be forgotten. A rail is affixed on posts

along that side of the bed a foot or so high, on which the rows are clearly numbered, and with book in one hand and wire hook with wooden handle in the other, the back blooms are drawn forward and examined, the name of any variety in the bed, though known by the owner, being verified in a moment on reference to the book. For instance, we ask the name of a grand bizarre, the fifth bulb, we will say in the tenth row, and there it is sure enough in bed and book as George Hayward; and that dainty rose, the sixth in the fifteenth row, is Aglaia; this charming byblœmen, the third in the twentieth row, Talisman; and so on through between two and three hundred varieties, the book revealing the name of every one in a moment, without a label of any kind in the bed.

There are Tulips from many collections in England, and several from different continental sources, but there is no mistaking the superiority in form, substance, and accuracy of the best of English florists' Tulips over all others that are grown in comparison with them. The "amateurs' Tulips, as they are called on the Continent—the term being equivalent to our designation "florists"—are in general appearance attractive, and the colours of some compel admiration, but in most of the blooms these are where they ought not to be—running right down to the base of the petals, and in some other respects irregular. Many of the petals are also too long, pointed, and flimsy—lacking the close cup-like shape and stout texture of the best English forms. These, too, are clear at the base, as if a sun was set at the bottom of the bizarres, and the most silvery of moons in the roses and byblœmens, lighting up the colours of the flamed and feathered petals there displayed in beautiful regularity and indescribable hues.

Some of the varieties stood out bold and clear in character and markings from the great assemblage, and in examining them for identification over and over again they proved among the roses to be such varieties as Annie McGregor, Alice, Heroine, Lady Sefton, Aglaia, Mabel, Lizzie Watkins, and Triomphe Royale; among byblœmens Adonis, Anastasia, Richard Yates, David Jackson, Duchess of Sutherland, Everard, Lord Denman, Mrs. Jackson, Talisman, and Violette Aimable; among bizarres Ajax, Colbert, Dr. Hardy, Dr. Horner, George Hayward, Lord Lilford, Sir Joseph Paxton, Vicar of Radford, Victor Emmanuel, and Vivid. These are only a few of many that stood out as fair and gorgeously equipped aristocrats in the mixed community, and very mixed it is and diversified, of the Tulip world, represented in—as the rustics love to call their native county—the "Kingdom of Sussex."

In a critical examination of hundreds of blooms not a few of the names were crossed out in the book, a sure and certain sign that the varieties will not have a place of honour in the covered bed again. Evidently the Doctor intends having a collection as choice as he can obtain, and when he has a definite object in view he is not deterred by trifles from accomplishing it; and probably since that day of weeding he has travelled hundreds of miles in quest of his favourite flowers. Of that quest they are worthy, so rare are they, and so different from and superior to the vast number that are known to the majority who grow Tulips for "decorative purposes." The educated florist grows them for this and more. They are to him intellectual productions; he sees in them the beauty that has been provided by years of care and patient waiting by floral devotees, whose characters and attainments are stamped on the blooms.

The Doctor has other beds than the one under the covered roof with hundreds of plants in them; glossy self-coloured "breeders" with the gold or silvery basal discs, and one here and there "breaking"—bursting into flame, so to say, from the glowing embers of colour that have remained stationary for no one knows how long. You may wait years for the new life you hope to see start from these probationers and place them on the roll of fame; but there is this to say about them—they are beautiful during all the time of waiting, when they are good, and the florist knows quite well those that are well worth keeping.

There is a great deal beyond Tulips to see and admire in Dr. Hogg's domain; his ornamental trees and shrubs, fruit collections (so full of promise), and wealth of hardy flowers. He has changed the whole face of the district, erecting mansion and smaller yet commodious and charming subsidiary residence, renovating cottage homes, planting everywhere, and making gardens—not of the stiff, formal, please keep-off-the-grass order, but enjoyable unconventional gardens, with a great deal of nature about them; and now having done that he appears to have returned to his first love—Tulips, for which he won prizes now many long years ago, and all who know him will share most heartily in the hope that they will afford him real pleasure and true intellectual enjoyment for many years to come.

After the pleasant greeting, the enjoyment of all that was good for me, and the needed Tulip lesson, I left as the shades of evening came creeping over the weald, bringing with them the songs of

nightingales that filled the air with melody till the thunder came after that bright Tulip day, and brought it and the concert to a close.—A NOVICE.

FREE GROWING ALPINES.

THE term "free growing" I here employ to distinguish the plants I shall presently name from the more diminutive Alpines, the majority of which are slow growers, and better suited for culture in pots or for growing upon the well made rockery; those which I regard as "free growing" are better adapted for clothing bare spots quickly, and such happily that only require ordinary skill and intelligence to make them quite a success.

Under this head I would include the whole, or at least the larger portion, of the Alpine Phloxes, and in particular the many beautiful varieties of *P. setacea*, also *P. subulata*, *P. frondosa*, *P. amoena*, *P. reptans*, and others. We have in these collectively a charming variety of colour, and considerable difference also in time of flowering and of duration. All these, moreover, are at the present time making a wonderful display of their flowers, and borne upon the tiny prostrate tufts of somewhat spiny leaves in dense masses that cannot fail to please. They may be grown on a level piece of ground without the least fear of their charms being marred by pelting rains, for the density of their cushion-like tufts is a safe guarantee in this direction. On the rockery, again, where large patches could be planted 2 or 3 feet or more across, nothing is more beautiful; or planted again on the summit of a low, rugged wall, and allowed to droop naturally over the sides.

Some years ago I had under my charge many such walls, all erected for a purpose, yet at the same time the useful was also rendered beautiful. Save for occasional internal supports or "headers" through the wall, if the height of the latter demanded it, many of these walls were hollowed in the centre, and this space was eventually filled by soil, sometimes 2 feet, and sometimes 3 feet deep. On the summit of these walls shallow pockets were constructed, and the most showy and free flowering of Alpine plants found themselves in possession of a home, the suitability of which none ever doubted who saw the plants; in fact, till the secret of the depth of soil contained in these hollow walls was known many who saw the plants were not a little surprised at their vigour.

In such places as these we planted freely Rock Roses, *Aubrietias* which overhung the sides in their rich telling carpets of colour, *Hutchinsia alpina*, *Dianthus* in variety, *Snapdragons*, *Linarias*, particularly alpina; quantities of *Saxifrage*s and *Sedums*, and *Wallflowers* and purple *Honesty* in many available crevices. These by no means exhaust the list, but it may suffice to show what variety of showy plants may be gathered together in places of this kind.

The varieties of *Phlox setacea* include some charming pure whites, vivid pink, rose, and dark red purple, all alike beautiful and highly ornamental. The *Aubrietias* as just named are equally free and most enduring. The most distinct of the Mossy *Saxifrage*s, such as *muscoidea atro-purpurea* and *Wallacei* (*Camposi*), should always be borne in mind. The former is quite unique in its moss-like carpet of the most beautiful green, covered during April and May with myriads of its rosy purple flowers. These are extremely attractive. *S. Wallacei*, on the other hand, of more vigorous growth, flowers for a much longer period than the one just noticed, and keeps up a continuous display of pure white flowers, which for elegance and grace are fitted for association with the choicest of flowers, and would undoubtedly have figured long ago in many a choice bouquet, but its stems are too brittle to endure wiring with any safety. It is easily grown and readily increased.

Then, again, take the whole range of the *Gentian* family from end to end, and what have we to compare with, or what to vie in intrinsic beauty, the old garden *Gentianella*, *G. acaulis*? It is at once the most vigorous grower and the most profuse flowering of its race, and above and beyond these facts specially suited to a large proportion of English gardens. Speaking of its profuse flowering reminds me that I have small plants now flowering averaging 4 inches across and bearing a dozen flowers, some of the best carrying as many as sixteen and eighteen flowers; in fact, in every growth a flower. Our soil is a light loam overlying a deep bed of gravel; and my experience in the cultivation of this *Gentian* is that it grows and flowers with great freedom always where either a gravelly subsoil or a subsoil of sandstone prevails. I do not, however, infer that it does not do equally well on other soils than those named, yet I know some twenty-five-year-old clumps in a garden where the soil is heavy and overlying blue lias clay that just keep alive and rarely produce a flower. Within the past ten years I have divided and replanted some of the clumps, adding old mortar and giving fresh soil, but with little or no result. The growth is slow and small and the plants by no means happy.

I do not, however, know another instance where this lovely plant appears so difficult to please.

Such *Primulas*, too, as *rosea*, *denticulata*, *cashmeriana*, and *intermedia* are all extremely beautiful and among the easiest to grow, delighting at all times in a cool and somewhat moist soil of a loamy nature; though, given the shade and moisture, they are by no means particular as to soil, for I have had them doing equally as well on a reddish clay as on a deep sandy loam, and I consider the position named to be a primary point, particularly for the three first; while *intermedia* will welcome abundant supplies of moisture all through its growing season. What a host of charming and useful plants we have in the dwarf *Campanulas*, especially the *pumila* section! What pleasing sheets may be formed, for example, with *pumila*, *pumila alba*, *pusilla*, the rich drooping solitary flowers of *pulla*—all these quickly form exquisite masses of colour, and with by little or no trouble when once planted. Surely everyone who reads the *Journal* knows something of the snow-white purity of *pumila alba* and its sheets of bell-shaped flowers barely 6 inches high. What a lovely plant for pots or the rockery! Others equally beautiful, though more at home on the rockery or suspended in pots, are *C. isophylla* and its pure white form *fragilis* and *fragilis hirsuta*, *garganica*, and others; while *turbinata* and *carpatica*, with its forms *pallida* and *alba*, are equally beautiful in masses, but grow to a foot high or rather more.

Cheiranthus alpinus, *Iberis corifolia*, *Tiarella cordifolia*, *Iris nudicaulis*, *Saponaria ocymoides*, *Lychnis Lagasce*, *Aster alpinus*, *Arnebia echioides* are all very beautiful and interesting in their way, and well suited for growing in the majority of gardens, and in the main providing a rich and lengthened display of flowers. These are a few of the many that could be named that would amply repay a good deal of care, if this latter were needed, but seeing they may be grown so easily there is little reason why they should not be grown abundantly in many gardens where they are now seldom seen.—J. H. E.

SIXTY YEARS OF HORTICULTURAL PROGRESS.

(1760-1820).

(Continued from page 238.)

THOUGH in its size the London of 130 years ago, big as it seemed to the folks of that day, was a mere dwarf beside our modern metropolis, it exercised then an important influence upon British horticulture. Many circumstances combined to make the capital a centre of information and a recipient of rarities from distant countries, but owing to the tardiness of inland communication neither knowledge nor plants travelled frequently or speedily to distant towns and villages. Gardening pursuits had no periodical or journal devoted to them, and they were seldom referred to in the ordinary newspapers of the time. Hence not a few of those who followed horticulture for pleasure or profit while George III. reigned looked upon a visit to London as an event to be long remembered, and turned it to the best account in seeing notable London establishments, and "interviewing" men reputed to be skilful gardeners.

To mention the name of Abercrombie is at once to recall the fact of the indebtedness of modern horticulture to many men whose native land was the northern division of Britain. Whatever old Sam Johnson might have felt in regard to the intrusion of Scotchmen into southern enterprise, looking at the matter from his point of view, we cannot but think that had he been anything of a gardener he would have commended Scottish skill and perseverance as manifested by such men as John Abercrombie. Indeed, his most important book, small in size certainly, but rich in details beyond all of the kind that had preceded it, his "Every Man His Own Gardener," occupies a position no other work on gardening of George III.'s reign can approach. More's the pity, say some, that he did not at once acknowledge it to be his own, instead of trying to secure public patronage by putting on the title that it was partly written by Mawe, gardener to the Duke of Leeds, and other gardeners. Doubtless he had from Mawe and several friendly gardeners sundry hints which he used, but the work was in reality quite his own, and though Dr. Goldsmith agreed to correct the style he did not. Abercrombie had, when a lad, been working in his father's market garden near Edinburgh, but started southward when eighteen, and obtained employment at some private gardens in London. One of these was at Leicester House, for then this mansion had grounds in the rear, occupying the space where we now see Lisle and Gerrard Streets. (How near the country approached to the metropolis about that time appears from the fact that just to the north of Oxford Street there were two farms of some extent, on which corn and vegetables were raised, and Tottenham Court Road had quite a rural aspect.) Abercrombie found many friends among the nurserymen of Hoxton, Islington,

and other places in North London, and he had already begun to make copious notes of his observations in the course of his daily round of duties. "Every Man His Own Gardener" appeared in 1766, and the demand for it was considerable, the profits enabling him to open establishments both in Middlesex and Surrey, where he did a good business, especially as in the later editions of his books the names of these—one being at Tottenham Court, the other at Newington—were mentioned on the title page, and brought him numerous customers for seeds and plants. And as his fame spread abroad, he had numerous applications from gentlemen who sought his advice upon the best methods of planning and arranging gardens. In his old age he was chiefly employed thus, having relinquished his nurseries, the last of which was near the Shepherd tavern at Hoxton, held by him for many years. Here he gave special attention to the culture of exotics, and the formation of new varieties of fruits. Next to the work mentioned his "Gardener's Pocket Journal, or Domestic Assistant," had most popularity. This appeared in 1791. His little book on the Garden Mushroom, however, led many to grow this esculent, and the "Forcing Gardener," of 1781, contains much original thought. He found time to write sixteen books altogether in his odd hours, and was one of those who heartily believed in the inspiration afforded by tea, of which he drank thrice daily.

We may couple here with the name of Abercrombie that of Lee, he, too, being born north of the Tweed, and his "Vineyard Nursery" at Hammersmith took high rank amongst the establishments of that period, largely helping to advance the culture of plants on improved principles, while quantities of species previously unknown in Britain were received there during the latter half of the eighteenth century. James Lee, the elder, had his training under Miller at the Chelsea Garden (an enclosure no gardener should pass without lifting his hat, for so many men famous in horticulture have worked there); afterwards he went to Whitton, near Hounslow, to the celebrated gardens that were originated by the Duke of Argyle, subsequently owned by another patron of horticulture, Sir W. Chambers. This Duke devoted himself particularly to the work of obtaining specimens of exotic trees, hence some contemptuously called him a "tree-monger," and in 1762 Kew was enriched by a large number of shrubs and saplings removed from Whitton to that establishment. In company with Kennedy he started the Vineyard Nursery, and soon obtained extensive patronage, which enabled him not only to have correspondents in various countries, but also to send out collectors of his own to North and South America, the Cape, and North Africa. It is considered that he rendered his greatest service to horticulture, however, by the publication of his "Introduction of Botany," the first edition appearing in 1760, which was meant to simplify the Linnaean system for gardeners, and so lead them to study the structure and habits of the plants they grew. He also followed in the footsteps of his friend Furber, of the Kensington Nursery, who had for many years devoted much time to the selection of the best varieties of fruit trees, and who had brought out in 1732 an illustrated list of choice trees, which was circulated largely amongst amateurs.

The first "Hortus Kewensis" appeared in 1789, probably the most important catalogue of its time, as giving an impetus to horticultural progress; though, some years previously, Scottish perseverance and enterprise, in the person of Dickson & Co. of Edinburgh, had brought out a well arranged list of greenhouse, hardy, and half-hardy plants which served as a model to other nurserymen. But there really existed at that date few facilities for making known by the Press the merits or beauties of new and choice plants, so that, for instance, Mr. Redmond of Islington, when he had for sale, at half a guinea each, some Auriculas he called the "Triumph," advertised them in the *Connoisseur* of March, 1756. Great was the popularity of the Auricula then, and for years subsequently, the remarkable fact being that it was grown by the poor as well as by the rich. So, too, were varieties of the Iris and the Fritillary, rarely to be seen in modern gardens. Rocque of Walham Green, who had discovered new varieties of grasses for garden lawns, was, early in the reign of the third George, calling attention to the Hyacinth by means of a pamphlet upon the flower partly translated from the Dutch. He also had a vineyard of the sort common in that reign, the Vines being either grown upon sloping banks, or in rows, fastened to stakes 4 or 5 feet high. Speechly, between 1760 and 1790, raised, for experiment, many varieties of the Vine from seed. The notable Vine of Hampton Court dates from 1769.

Arable and pasture orchards were very common in the eighteenth century; orchards, that is, in which corn was grown or cattle grazed, but sensible men were beginning to see their drawbacks even then. From manuring scarcely at all the practice of manuring to excess prevailed, gardeners seeming to think that the more nourishment they gave the plant the greater must

be its growth, forgetting how much depends upon assimilation. Middleton tells us that in Middlesex stable litter was thought most of, next to that the contents of London cesspools, but many gardeners speculated in bones, coal ashes, shavings of horn and leather, hog's hair, and the feet of animals sold cheap by butchers. Soot was beginning to be valued as a nutriment and a destroyer of insects, but the Georgian chimney sweeps were wont to adulterate the article with ashes. There was much demand about London for a calcareous marl dug in Enfield Chase, supposed to be good as a subsoil.—J. R. S. C.



JOTTINGS.

AFTER a careful analysis of the Orchid exhibits at the Temple Show I have obtained the following statistics, which show that the number of species and varieties was considerably greater at the Orchid Conference in 1885, but there were more plants of certain types at the Temple. For instance, of *Miltonia vexillaria* there were over 500 plants, while of *Cattleyas*, *Laelias*, and *Masdevallias* the total would be larger still. In 1885 fifty-seven genera were represented, in 1891 there were forty-one genera; the number of species, varieties, and hybrids in 1885 were 348, this year they were 276. The Conference, therefore, still takes the lead as expected in this matter, but in total number of plants and quantity of flowers the Temple Show of 1891 has never been surpassed. Reference will be made at intervals to the genera chiefly represented and the varieties included, but this week attention can only be called to one of the exhibits, which, although amongst the smallest, was yet one of the most interesting.

This was the little group of *Phalænopsis* from Major-General Berkeley, Spetchley House, Bitterne Park, Southampton, which comprised plants mostly collected by himself in the Malay Archipelago and the Andaman Islands. They were as follows:—*Phalænopsis speciosa*.—The type white striped with rosy purple. *Phalænopsis speciosa* var. *Imperatrix*.—A rare variety of *P. speciosa*, in which the white markings are absent, the entire flower being rosy purple. Several varieties were also exhibited intermediate between the first two. *Phalænopsis tetraspis*.—Pure white, among which were two extra good plants. *Phalænopsis Luddemanniana*.—With several spikes of flower to show the difference of this old *Phalænopsis* from the more recently discovered varieties. Besides the group of *Phalænopsis* a curious plant was exhibited which seems to have been lost sight of for many years. *Catasetum atratum*, *Lindl.*.—The plant has a long arching scape of flowers; colour green, very much spotted with purple. This plant was named by Lindley in 1838 from a plant which flowered that year in Messrs. Loddiges' collection.

Amongst the *Phalænopses* General Berkeley has done especially good work, and the first living plants of *P. tetraspis* were sent by him to Mr. W. Bull about ten years ago from the Andaman Islands, where he says the plants were growing "on Mangrove and other trees in muddy swamps at the extreme end of the creeks where the water is fresh, and where the plants hang from the branches a few feet above the water, growing with extraordinary luxuriance." The species was, however, first found by Mr. Thomas Lobb when collecting for Messrs. J. Veitch & Sons, but the locality was lost.

Another of the small-flowered *Phalænopses* introduced by the same gentleman is *P. speciosa*, which is very beautiful, owing to the fine bluish-purple tint of the flowers. This was found growing upon trees in the islands of the Malay Archipelago, and the distinct variety *Imperatrix*, mentioned above, admirably figured in "Reichenbachia," was also collected by General Berkeley, who has recorded many interesting facts concerning several other members of the same genus.

The recent exhibition organised by L'Orchid enne at Brussels, and held in the Rue Wiertz, appears to have been a particularly successful gathering, the exhibits numerous and of great merit. The King and Queen of the Belgians visited the Show, and were received by MM. J. Linden and Lucien Linden, who also presented the members of the Jury to their Majesties. The exhibition continued three days, during which time there was a large attendance

of visitors. A full prize list is published in the *Journal des Orchidées* for June 1st.

M. A. Godefroy-Lebeuf gives in the last issue of *L'Orchidophile* to hand an excellent coloured plate of *Odontoglossum Leroyanum*, a hybrid raised at Baron E. de Rothschild's establishment at Armainvilliers from a cross between *Odontoglossum crispum* and *O. luteo-purpureum*. M. Godefroy makes some apology for giving "a new name" to a plant which, judging by the parents assigned by Reichenbach to the supposed natural hybrid *O. Wilekeanum*, is of the same origin. There are, however, sufficient differences to afford more warrant for a distinctive name in such an exceptional case than in many others that could be mentioned. He has, however, overlooked the fact that the plant was first described and the name applied in the *Journal of Horticulture*, p. 445, May 29th, 1890, in the following note:—

"Hybrid Orchids are now numerous in some of the more popular and best known genera, but the artificial production of hybrid *Odontoglossums* has hitherto proved too much for the skill of Orchid cultivators in this country. Seed has been obtained and plants even have been raised, but they have either died or have failed up to the present to produce flowers. A remarkable exception in France is worthy of notice, however, and will always possess considerable historical interest as the first hybrid resulting from artificial crossing amongst the *Odontoglossums*. This is in the collection of Orchids formed by the Baron Edmond de Rothschild a few miles from Paris on the Strasburg line. It was secured from a cross effected about five and a half years ago between *O. crispum* and *O. luteo-purpureum*, the former being the seed parent. The seeds were sown when ripe, and several plants were raised, which have steadily progressed until the present year, when the most advanced produced a raceme of seven flowers early in May, and these are now fully expanded, the characters indicating a true combination of the two species named. The pseudo-bulbs are rounder than those of *O. crispum* and more like *O. luteo-purpureum*, the larger being $1\frac{1}{2}$ inch in diameter and depth and flattened, but the other is more conical in form. The leaves are 10 to 12 inches long, and $1\frac{1}{2}$ inch broad, stiff, and bright green. The flowers are $3\frac{1}{2}$ inches across from tip to tip of the petals, and 2 inches from the tip of the upper sepal to the margin of the lip. The sepals and petals are nearly equal, the latter slightly broader; the sepals of a pale yellowish ground tint, most strongly marked at the tips; the petals are whiter, and perhaps will become still more pure. The sepals have each three broad reddish brown bars, these being more clearly defined in the upper one than the two lower. The petals are undulated at the margin, with one large blotch in the centre, two smaller rounded ones at the side, and a few still smaller near the centre of the base. The lip is three-quarters of an inch in diameter, somewhat like *O. luteo-purpureum* in shape, fringed at the edge, white, with one large reddish blotch, and a deeply divided yellow crest at the base on a reddish ground. In general appearance the flowers are very distinct, the sepals and petals being slightly curved forwards. Baron Edmond de Rothschild specially desires the plant to bear the name of his gardener, M. Leroy."

Since this note was written Messrs. J. Veitch & Sons have succeeded in raising and flowering a seedling *Odontoglossum* of the *O. excellens* type from a cross between *O. triumphans* and *O. Pescatorei*. This plant was shown at the Temple and again at the R.H.S. meeting last Tuesday, when it excited much interest. The flower indicates a preponderance of *O. triumphans* characters, in which respect it differs from several other forms of *O. excellens*, in which the *O. Pescatorei* form is most marked.

The Orchid-growing nurseries in and around London are extremely gay just now. Messrs. J. Veitch & Sons and Mr. W. Bull at Chelsea; Messrs. B. S. Williams & Son at Upper Holloway; Sander & Co., St. Albans; Low & Co., Clapton, with others, have brilliant floral displays that show the decorative value of these plants to perfection.

NEW ORCHIDS.—LÆLIA ARNOLDIANA.—At the Royal Horticultural Society's meeting on Tuesday, a special class was provided for seedling Orchids, and though only two exhibits were entered these were of such exceptional merit that they are well worthy of descriptive paragraphs. *Lælia hybrida Arnoldiana*, from Messrs. F. Sander & Co., St. Albans, was awarded a silver-gilt Flora medal, together with a first-class certificate, and double honours of the same value have never been secured by a new Orchid before. It is the result of a cross between *Lælia purpurata* and a variety of

Cattleya labiata, the seed having been sown in 1881, so that the plant shown with five pseudo-bulbs and leaves of different sizes is just ten years old, not too long to wait for such a handsome Orchid. *Cattleya labiata* presents an astonishing range of variation, and it is therefore not surprising that though hybrids between that type and *Lælia purpurata* have been previously obtained, as in the superb *Lælia bella* and *callistoglossa*, yet the distinctions are strongly marked in all the progeny hitherto flowered, and the grand addition now under notice is a success of a remarkable character.

L. HYBRIDA ARNOLDIANA appears to be of vigorous habit, the narrow fusiform pseudo-bulbs being 6 to 8 inches long, the leaves about 12 inches long, $2\frac{1}{2}$ inches across, of very stout and bright shining green. The flowers exceed 7 inches in diameter, and have a peculiarly graceful outline and pose; the sepals are narrowly lanceolate, of a delicate evenly diffused rosy purple hue, regularly spreading; the petals are of similar colour, broader, drooping, or decurved at the tips, the margin undulated, and slightly darker veins in the centre. The lip is very handsome, the broad rounded central lobe nearly 3 inches in diameter, of an intensely rich magenta crimson, with a few still darker veins, and a golden bronze tinge in the throat. The whole aspect of the flower is very striking, and the hybrid must be assigned a place amongst the finest yet raised.



FIG. 89.—DISA VEITCHII.

DISA VEITCHII.—A silver Flora medal and a first-class certificate were unanimously awarded to Messrs. J. Veitch & Sons' beautiful new *Disa* (fig. 89), which possesses the especial interest of being the first hybrid in the genus that has flowered. It was obtained from a cross between *D. racemosa* and *D. grandiflora*, and shows a clearly discerned combination of the characters of the two parents. *D. racemosa* was figured and described in this Journal, page 221, September 6th, 1888, and is remarkable for its free growth, profuse flowering, and its rosy crimson or purple hue. *D. grandiflora* is too well known to need description. In habit

and style of flowering the hybrid is near to *D. racemosa*; the colour, too, resembles that species, but the flowers have gained somewhat of the size and shape of *D. grandiflora*. The two lower divisions are ovate, of a bright deep rose tint; the upper one is nearly cordate or rounded and cucullate, of a paler colour, nearly white at the base; the small lip is hollowed and spotted with deep crimson. This will probably become a popular companion to *D. grandiflora*.—L. C.

PREPARING STRAWBERRY PLANTS.

STRAWBERRIES are popular, not simply on account of the fruit, but for the ease with which Strawberries may be cultivated. Some cottagers produce fruit equal to those found in gardens of far greater pretensions; it is also the first outdoor fruit obtainable by the poorer classes. No other hardy fruit can be grown under so many conditions, and certainly no other fruit will bring in such a quick return for the outlay on land and labour. But it is not respecting the quality and value of Strawberries as a crop that I write this short article, the intention is to give a hint or two on the preparation of the plants.

To secure the best results an early start is absolutely necessary, whether the Strawberries are intended for forming new plantations or for pot culture. I have an instance of this, for single plants of Vicomtesse Hericart de Thury, placed out early last August, had an average of twelve trusses each, the trusses with from twelve to fourteen flowers, a splendid prospect for fruit on such young plants; but unfortunately the frost of May 17th spoilt this. On plants of Noble, treated in the same way, there are six and eight trusses; while some of President, which did not receive any special preparation, and were not placed out for a month later, have not more than four trusses at the most, and a smaller per-centage of blooms. Results like these are worthy of some consideration.

The method we adopt may entail a little more labour I admit, but the result fully compensates for the extra outlay in labour. In the first place, we provide plants to give us early runners, and nothing else. These are not intended to ripen any fruit. We, therefore, plant a few roots of each kind in any out-of-the-way place, when the stock for pots and outdoor plantations have been secured the previous September. Owing to want of space in the kitchen garden, and for convenience in attending to them afterwards, ours are placed out 9 inches apart within the Box edging, near the Gooseberry and Currant borders. Such an arrangement obviates the necessity of treading on the soil to layer the runners, and to afford them water daily afterwards in dry weather.

The flower trusses are not allowed to develop, but are promptly removed as soon as they show, which concentrates the whole energy of the plant on the formation of runners. When the runners make their first joint they are ready for layering into 3-inch pots. At the bottom of each pot we place one crock, not solely for drainage, but to prevent the passage becoming stopped by worms. We fill the pots firmly to within half an inch of the top with a compost of three parts fibry loam and one part of the materials from a spent Mushroom bed. On the top of the soil we secure the runner with a small peg made from twigs, or, what is better still, thin galvanised wire, which lasts many years. Some persons fasten the runners down with a stone, which answers very well if not removed, but in the event of an accident many runners may be disturbed, which interferes with their rooting; pegs provide a greater safety. Other runners will start from this, which may be utilised to the extent of three from the first if the stock of any variety is short; but if a plentiful supply of single runners, or at the most two, can be had they are preferable, as the plants then quickly gather strength when restricted.

Plunge the pots in the soil, which will minimise the labour in supplying them with water during dry weather. The soil in the pots must be kept moist to favour quick rooting. When the plants are well furnished with roots the runners may be severed from the parent plant. Those intended for culture in pots should be transferred to their largest pots at once. If for outdoor culture the sooner they are planted after that stage the better it will be for their future welfare, choosing showery weather for the work if possible.—E. MOLYNEUX.

THE CARNATION.

[A Paper by Mr. JAMES DOUGLAS, read at the meeting of the Hawick Horticultural Mutual Improvement Association, May 29th.]

(Continued from page 443.)

CULTURE.

As is well known, the Carnation is perfectly hardy, and succeeds well as a decorative plant in the flower garden; and the plants are, I think, most beautiful in masses of one colour. The soil ought to be deep, and well manured with good decayed stable manure, which ought to be about 6 inches below the surface, that it may

not come into immediate contact with the roots of the plants. The roots will run into it during their period of growth. I approve of planting the layers out as soon as they can be obtained in the autumn, that they may be well established and have good hold of the ground before the frosts of winter set in to disturb them. The watchful cultivator will see that his ground is free from wireworms before the plants are put out, and also that no slugs or leather-coated grubs are allowed to feed at their leisure upon the leaves when the weather is mild in winter. Sparrows are everywhere, and the old birds are attracted by the fresh young leaves as soon as new growth is formed in the spring; they bite off the leaves and mangle the flower stems; but the birds are easily scared by white cotton thread being strained over the beds 6 inches or more above the plants. Neat sticks about 2 feet in length should be placed to the flower stems. The flowers will open about the end of July.

The plants are obtained in three ways—by seeds for new varieties, by layering, and by cuttings. The saving and sowing seeds is perhaps the most interesting part of the florist's work. There is much pleasurable excitement in watching the development of the plants, from the small seedlings to the large bushy flowering specimen, which will produce as many as two hundred flowers. The opening of the flowers is a delightful surprise to the young cultivator; he is expecting great things, and if his expectations are not quite realised there is sure to be some distinct and good varieties amongst them. The seeds of Carnations and Picotees can be purchased at most large seed shops, and some good varieties are likely to be produced therefrom; but the most satisfactory way is for the cultivator to save his own seeds by carefully hybridising certain varieties. For instance, take the class of scarlet bizarres, and apply the pollen of one of the best varieties to the stigmatic portion of the flower of another good variety in the same class, or any other of the classes may be treated in the same way, it not being desirable to intermingle the classes. The result of this careful treatment may be the production of three or four really good varieties in a hundred plants that may be worth trying again. Ten or a dozen plants may produce flowers quite single, many will be self-coloured, and the remainder streaked and spotted in a fantastic manner. Most of them are adapted to cut for decorative purposes, to arrange in vases, &c., their perfume being varied and delightful. The time to sow the seeds is the last week in March or the first in April. Sow them in pots or small pans and place them in a hotbed to vegetate; if there is a brisk but not too strong bottom heat the plants will be up in a week from the time of sowing. The young plants must be pricked out also as soon as the seed leaves have grown to their full size; if this is not done promptly many of the young seedlings may damp off and be lost. After they have been pricked out about 2 or 3 inches apart in boxes the plants are safe. They must be gradually inured first to the temperature of a cold frame, and later out of doors, to be planted about 15 inches asunder where they have to flower about the end of May or early in June. The plants will flower very strongly the following season, producing immense numbers of blossoms on each plant. The soil ought to be deeply worked and well manured.

The flakes, bizarres, Picotees, and selfs are propagated by layering. This operation is performed in July or early in August. The sooner it can be done after the layers are large enough the better. The plants will be stronger; they can be removed from the parent plant earlier, and may be planted out by the middle of September, so that they become well established before the winter sets in. If they are for planting in small pots to pass through the winter in cold frames a good time to do this is the last week in September or the first in October, one pair or a single strong plant in a large 60.

The tree or perpetual flowering varieties are usually produced from cuttings of the side growths; these form roots freely in the early months of the year; they are planted in small pots singly after roots are formed, and if grown carefully in a glass house or pit until the first week in June may then be placed in an open sunny position out of doors, and will thus form good flowering plants by the end of the season. Their flowers are produced all through the winter months; but it is necessary to grow the plants near the glass where they get as much light as possible, and in a temperature of about 55°. This section is not grown in such large pots as the others; very good flowering plants may be produced in 6-inch pots. The whole process of culture is this:—The cuttings are placed ten or a dozen together in a 5-inch pot, when they have formed roots they are planted in thumb pots or small 60's. When well established they are repotted into larger sizes, and they are gradually removed from the propagating house to a greenhouse, and from thence to a cold frame; but they make the best plants if left out of doors during the summer months.

(To be continued.)



STRAY NOTES.

A FEW of the leading rosarians have been kind enough to answer my questions as to the amount of damage they estimate to have received from the Whitsuntide frost. Yorkshire and Herefordshire seem to have been the greatest sufferers, and I do believe that for a wonder I got as little of it as anyone; 9° or 10° of frost seems to have been the general amount, our Irish friends being no better off than the majority, and Devonshire not escaping. My thermometer was unfortunately on a north wall, where it was much sheltered; it there registered 30° F., and I estimate that my Roses were not exposed to more than 7° of frost. I think a friendly haze or cloud must have come over and protected me in the small hours, as was certainly the case on the severest nights in the past winter. It was plain a frost was coming, though we had no snow; and we worked as long as there was any light in covering up Potatoes and everything we could. The worst damage was to the early blossoms of Noble Strawberry.

On May 1st, 1886, my thermometer happened to be in the same place, and then registered a minimum of 25°, 5° colder; vegetation was then pretty nearly as forward as it was on the 18th this year. I remember this by the length of my Rose shoots, which were then much injured; the majority of shoots, both H.P. and Teas, were stopped—*i.e.*, went blind, and much of the foliage was considerably hurt. I have now a few blind shoots, but quite a few, and such Tea buds as had appeared are apparently likely to be deformed, otherwise I can see no injury whatever, and a sufficient time having elapsed it is plain that there has been none. I fear my friends are likely to find a good many blind shoots, but I would try to comfort them by the assurance that my Roses in 1886, though all fresh planted, wonderfully recovered afterwards; and I am in hopes, in view of the present forcing weather and the great vitality of strong-growing shoots at this season, that in a short time most of the Roses will have forgotten that terrible Whitsuntide, and will perhaps not be so very late after all.

As an instance of the recuperative power of a strong young shoot, I had a single strong maiden H.P. shoot budded an inch below the surface on a very strong Briar cutting. It was 8 or 10 inches long, and had had its first tie to the bamboo which was to support it. One morning it was apparently broken. The tie had slipped by the shoot becoming flaccid, and all but the bamboo was flat on the ground. Probably the bamboo had received a blow which had jarred the shoot, somewhat strained by the tie, nearly out of the stock. The place of rupture was beneath the ground, and I left it alone. A day or two ago I very nearly gave it up; the leaves had withered completely away, and the poor thing was prostrate and apparently quite dead. We had a warm shower in the night, and in the morning it was off the ground. This morning it is nearly upright again, and though there is no sign yet of its shooting at the eyes, I have little doubt that it will reunite and form a strong plant by the end of the season. A good many years ago I remember that going out one morning I found a "blown out" maiden shoot beneath a standard stock. I cut it back to two or three buds, popped it in again and tied it up, and it lived and grew. I often tried this again with blown out shoots, but was never afterwards successful.

I think the bamboo canes sold as sticks and supports are a great improvement on the extemporised stakes that used to be in vogue. Their not being likely to rot and break just below the surface is a considerable advantage. I should think they are very trustworthy in that way, but they are difficult to cut, turning the edge of my pruning knife in an alarming manner. Another point in their favour is their smooth and shiny surface, which not only looks neat but must also offer little protection for the eggs and seeds of insect and vegetable pests. I have always looked upon an old stake with loose bark as a very likely source of infection.

A well-known amateur informs me that this year maiden H.P.'s seem to be coming into bloom before the cut-backs. This is very unusual, but on looking at my own collection I find that it is also the case to a considerable extent with me. It is difficult to account for this; we must lay it, like everything else, to the weather.

In looking over an old edition of Rivers' "Rose Amateurs' Guide," I find it suggested that dormant Tea buds in stocks may be protected from frost by two or three coats of collodion. This is a new idea to me, and it seems a very good one if it is effectual, so simple, quickly, and easily done. And if effectual, why should not the lowest inch or two joining the stock be thus preserved in standard Teas? I do not think it would be a bit more trouble than some of the elaborate modes of covering now used, and if thought necessary we could still employ them as well. I am sure I should find it of great service if it is a real protection. Will anyone say who has tried it how far it is a preservative against severe frost?

The edition is dated 1863, and it is very interesting to see what Roses were considered the best twenty-eight years ago by so good an authority. One is of course prepared to find some varieties held in the highest esteem which have since nearly, if not quite, gone out of cultivation; but, on the other hand, it is odd to see sorts still held to be of sterling value placed without comment among the common herd. Thus, in crimson H.P.'s of the sorts commended, *Senateur Vaisse* and *Gloire de Santenay* are selected for especial praise; while *Charles Lefebvre*, still one of our best, is reckoned with *François Laeharme*, *Alphonse Damaizin*, &c. It had, however, only been introduced two years. Among the carmine, *Madame C. Crapelet*, now a first-class Rose, goes with *Duke of Cambridge*, *Lord Palmerston*, &c., while *Jules Margottin* is pronounced the finest Rose known. In pink the highest possible praise is given to *Comtesse de Chabillant*, it is good if it were not so very small; while in this section there appear to be none now held of much account, with the exception, perhaps, of *Victor Verdier* or *Louise Peyronny*. In blush Mrs. Rivers and *Madame Vidot* were most esteemed—above *Mlle. Eugénie Verdier*, which I thought was much later. There was no good white H.P. at that time.

In Teas *Adam*, *Devoniensis*, *Gloire de Dijon*, *Madame Willermoz*, and *Souvenir d'un Ami* are deservedly praised; while *Niphotos* is commended, *La Boule d'Or* deprecated, and *Souvenir d'Elise Vardon*, which had been out nine years, mentioned, but omitted from the abridged list. Ah, well! it is easy to be wise after the event. These Roses were no doubt not estimated from the same exhibition standpoint from which they are now judged; and Mr. Rivers' representative twenty-eight years hence would not have much trouble, I fancy, in picking some serious holes in my notes.—W. R. RAILLEM.

HARDY FRUIT.

[A prize Essay read at a meeting of the Cardiff Gardeners' Mutual Improvement Society.]

(Continued from page 424.)

RED AND WHITE CURRANTS.

THE cultivation of these fruits is of the simplest description; new varieties, of course, are only obtained by seed, propagation by cuttings being the customary mode. Shoots well ripened from 10 inches to a foot long make the best cuttings. Remove all the eyes with the exception of the top three or four. A heel at the base is not essential, and a joint only will suffice. Plant them 6 inches apart in rows 1 foot asunder. Nearly all will take root, and should be transplanted the following autumn into nursery lines 1 foot apart, in rows 18 inches asunder. Prune hard to three or four eyes; they break away with vigour and form from five to ten shooted plants, with a clean stem from 6 to 9 inches; one year in the nursery beds and they are fit for sale, and generally realise 3s. per dozen. The second year they generally increase 6d. to 1s. per dozen; but 4s. per dozen is the top price for Currant bushes. So easy is their cultivation that many nurserymen have been led to propagate too many, and I daresay Currant bushes four or five years old, stunted, and in hundreds could be had at less than the above prices, but they are not the best for the purchaser.

For garden cultivation plant in rows 4 feet apart, or if space is plentiful 6 feet. An open centre is best. After sufficient shoots are formed and a moderate height is attained spur them in by cutting all lateral growths to three or four eyes, increasing the height of the bush by allowing the main shoots to extend five or six eyes annually until the maximum height is reached, about 5 or 6 feet. They are never allowed to exceed this height, more generally they are kept at about 4 feet by hard pruning. In this state they will continue to yield good crops annually. New branches when required are formed by encouraging new growth from below. It is best to fork between the rows, as the spade is liable to injure the roots. Give liberal dressings of manure, alternating with road scrapings, soot, and lime. A plantation would last twenty years, but twelve years is long enough. After that they deteriorate rapidly, and may be said to be worn out.

Birds in severe winters play havoc with the buds of Red and White Currants and the Gooseberry. Netting is the best remedy, but all persons cannot afford nets, and they should wash their bushes occasionally with a mixture of soot and lime; in fact, anything that would make the buds bitter to the taste without injury to the bushes would prevent the birds attacking them.

BLACK CURRANT.

Birds never touch this fruit, owing to the bitter nature of its buds, and it is one of the most profitable and useful fruits known. Under the most neglectful treatment it will continue to yield its fruit; but with good care it will increase the size of its berries to an astonishing extent, and pays well for the extra attention. It differs from the Red and White in bearing its fruit along the wood of the last season's growth, and not upon spurs. It is propagated and grown on like the Red and White, sold at the same price; the distance between the rows when planted permanently should, however, be a foot or so more, as it is taller.

I do not know why the single stem is preferred. I suppose it is more accommodating to the nurserymen who sell them, and it is hard to break through an old custom. But the most profitable bushes of Black Currants are invariably those which are allowed to throw up shoots from the very base of the plant. It loves moisture at the roots in abundance, and is a gross feeder. In pruning, or rather thinning, do not

cut back as advised for the Red and White, but leave the best and strongest shoots their whole length, encourage young wood from below, and cut out all weak wood and long weak branches, and keep generally open and well balanced all through. Black Currants do not seem to me to be so durable as the Red. Eight or ten years seems to be the limit of fertile life with this fruit. It is long enough, however, considering the pleasure of change, and by that time the land around the roots begins to collect perennial weeds, which it is difficult to get rid of when they once attain a footing in such quarters. Varieties.—Black, Black Naples, Lee's Prolific, Red and White Datch, the Cherry.

THE GOOSEBERRY.

This is one of the most valuable of hardy fruits. Like the Currant bushes, it is found in every poor man's garden, and pays well for good culture. It is always saleable, from the half-grown green fruit for culinary purposes to the coloured fruit fit for dessert. The propagation is the same as that for the Red Currant, the price about 1s. per dozen dearer. The garden cultivation, however, with regard to pruning differs, as the young wood of Gooseberries is not left entire as in the case of the Black, nor is it spurred in as the case of Red Currants, with the exception of the laterals, which, if anything, are cut in still more closely. The main shoots are allowed to remain nearly their whole length, and only slightly pruned at the points. Young wood ought to be encouraged by judicious summer pruning or thinning out, leaving only sufficient growth to develop as would form a good head of healthy and strong shoots annually; the winter pruning would then consist of reducing the points of such shoots, and cutting out the older branches entirely. Keep an open centre, let every shoot be as distant from its neighbour as to allow of the hand passing between the branches to pick the fruit. Planting of the Ribes family, like most other fruit, is best done as soon as the leaves begin to turn yellow. There are many varieties of Gooseberries all of which have some merit, few are absolutely worthless, but I object to the pendulous varieties for I cannot see the advantage of a weeping habit in a Gooseberry bush. Let the fruit be ever so good one half would be spoiled by the splashing of the soil during a heavy storm, to say nothing of the extra annoyance during picking. Gooseberries hang on the bush long and well if protected by covering with a mat to keep the birds away and the fruit dry. It is grand for market, comes quickly into bearing, and it is surprising that it is not more largely grown in the vicinity of Cardiff, the vast population of 130,000 people being chiefly supplied with fruit from distant districts.

Culinary and Dessert Varieties.—*Warrington, Ironmonger, White Venus, Pitmaston Gage, Yellow and *Red Champagne, Yellow Sulphur, and Crown Bob. The two marked with an asterisk are valuable for preserving.

THE RASPBERRY.

This fruit is well known as one of the best, if not the very best, for preserving purposes. It is propagated by suckers, which it throws up freely. It is also easily raised from seed. Strong canes can be purchased at about 1s. per dozen.

Planting should be done early and the ground well trenched and heavily manured. The old custom of planting in clumps and secured to a stake is fast going out. The better way is to plant in rows 5 or 6 feet apart, and of the same height trellis. In many old gardens can be seen permanent iron railings for Raspberries which look strong enough to last a century. There is no necessity for going to such expense. It stands to reason that any bush of the size and habit of the Raspberry which is so easily transplanted would benefit by a change of quarters, and to effect this with economy a wooden trellis would last long enough, look just as well, and its cost would not be a tenth of the former, and from which crops of equal quantity and quality might be gathered. Wires strained upon wooden uprights would last at least eight or ten years, and I do not think a plantation of Raspberries would improve if left any longer than that period in one place.

Assuming the canes were planted in October, they should be cut back in February or March to 18 inches, with the object of insuring fine canes for the second year. If left unpruned they not unfrequently die back. From the second season onward they ought to yield good crops. It is important to thin out the suckers while quite young, but bad practice to allow all suckers to grow up anywhere. If they were thinned early, only allowing as many as were required, about two for every foot of space, to attain maturity, those left would in every way repay for the extra attention. Select, if possible, canes that spring up in line with the trellis, cutting all the rest right away. In winter reduce the canes to a certain height. If strong and stout they may extend 6 inches above the top wire. A portion of those that are not so strong may be cut back to 3 feet and upwards. Manure liberally by mulchings applied in June and allowed to remain, and fork between the rows in spring. When well treated the canes respond with vigour and need but one tie each. We often see wiry-looking rows of Raspberries not more than 3 to 3½ feet high. This result can generally be traced to being left too long in the same ground. Sometimes the Raspberries will refuse to grow in fresh positions. I am inclined to attribute such cases to the condition of the soil which having been so long under cultivation has gone almost black by the humus of past manuring. In such cases it would be best to bring in a few loads of loam, or if this cannot be had, burn the old soil. This latter course is often effectual with ground that has "lost heart," as gardeners say, and is one of the best and cheapest methods of renovation for an old garden.

I know but few varieties of the Raspberry. The ordinary varieties

of Red and Yellow Antwerps I am most accustomed to; but there are others offered by the trade I know, but I am not acquainted with them. The Red is better than the Yellow for all purposes.

(To be continued.)



EVENTS OF THE WEEK.—The chief horticultural gathering will be the Royal Botanic Society's second summer Show for the year, to be held in Regent's Park on Wednesday, June 17th. This is always one of the best of the season, as besides plants and cut flowers there is a good representative collection of fruits in competition. The Society meetings comprise the Royal Society, Thursday, June 11th (to-day), at 4.30 P.M., and the Royal Botanic Society on June 13th, at 4 P.M. Messrs. Protheroe and Morris announce a sale of Orchids at their Cheapside Rooms on Friday next, June 12th. They will chiefly consist of Orchids imported by Messrs. Charlesworth, Shuttleworth & Co. A sale of plants will also be held by Messrs. Protheroe at the Assembly Rooms, Bath, on June 16th and 17th. The York Floral Fête and Gala opens on June 17th and closes on June 19th.

— **ROYAL HORTICULTURAL SOCIETY.**—We are informed that the R.H.S. dinner at the Hotel Métropole on Tuesday, June 23rd, promises to be a great success. Amongst the invited guests of the Society who have already accepted the invitation of the Council, we may mention the American Minister, the Greek Minister, the Right Hon. the Lord Mayor, the Right Hon. the Earl of Rosse, the Right Hon. Sir Lyon Playfair, Bart., M.P., the Lord Justice Fry, Sir James Paget, Bart., Sir Joseph Lister, Bart., Sir James Whitehead, Bart., Sir Henry Thompson, Mr. Sheriff Farmer, Mr. Brymer, M.P., Dr. Farquaharson, M.P., General H. D. Donnelly, Norman Lockyer, Esq., S. B. Bristowc, Esq., Q.C., Dr. Aitchinson, the Mayor of Croydon, Dr. Herman Weber, H. W. Lawrence, Esq., &c. &c. A few tickets (price 12s. 6d.) may still be obtained on application to the Secretary, 117, Victoria Street, S.W.

— **BRIGHTON AND SUSSEX NEW HORTICULTURAL AND MUTUAL IMPROVEMENT SOCIETY.**—At the last meeting of this Society C. W. Cott, Esq., was elected President; a Committee was formed with Mr. W. Balchin, jun., as Chairman and Mr. J. Cheal as Vice-Chairman. The rules were also thoroughly discussed and confirmed. It was stated that Mr. J. Wright had offered to read a paper at the first meeting on Thursday, June 11th, the subject being "The Objects and Usefulness of Gardeners' Improvement Societies." Other papers are promised by Mr. Lewis Castle (July 9th), Mr. George Gordon (October 8th), and Mr. J. Cheal (August 13th). The place of meeting is the Imperial Hotel, Queen's Road, Brighton, at 6.30 P.M.

— **UNDER** the curiously compound title *CLIVIEUCHARIS PULCHRA L'illustration Horticole* for May 15th has a note respecting a bi-generie hybrid, which should possess considerable interest. It is stated that M. Rodigas has given the name to a plant which has recently flowered for the first time in M. Louis Van Houtte's nursery at Ghent, and which had resulted from crossing a Clivia with pollen of Eucharis amazonica. Though it is said to be intermediate between the two parents no description is given, that being reserved until more flowers have been seen, but it is strange the colour is not mentioned.

— **THE GARDENERS' ORPHAN FUND.**—At the meeting of the Committee on Friday evening last 10 guineas were received from Mr. John Wills, the first instalment of 50 guineas he so generously offered for the charity. In view of the loss sustained by the discontinuance of the Covent Garden Fête, through its obstruction to business in the market, and also in view of the number of applicants for the benefits of the Fund, arrangements for a national collection in gardens on Saturday, 13th inst., were completed, and if every gardener collects a few shillings, or even a few pence, it will amount in the aggregate to a valuable and much-needed contribution. It is hoped that gardeners, old and young, will be glad to contribute something on the occasion for the support of children now waiting for election. It has also been decided to hold a "Floral Fête and Rose Fair" at the Crystal Palace on Wednesday, July 15th. An extensive and unique display is expected, and among other attractions a cricket match will be provided between

the gardeners and seedsmen of the United Kingdom, Mr. E. Molyneux, The Gardens, Swanmore Park, Bishops Waltham, and Mr. C. H. Sharman, The Nurseries, Forest Hill, S.W., having kindly promised to marshal the forces respectively, and to them offers of help may be sent. The occasion would appear to be suitable for a gardeners' holiday, and may be worth the attention of the members of mutual improvement societies who have not completed arrangements for their annual "outing." The subject will be further referred to.

— *EUONYMUS RADICANS VARIEGATUS* is not nearly so often treated as a wall plant, yet a mass of it 12 feet high is a fine sight at this time of year when the young leaves have a deep golden tint, rendering them exceedingly showy in the sunlight. The habit of the plant is dense, well fitting it for covering spaces. It is not particular as to position, although a southern aspect insures more rapid growth and deeper colouring of the leaves.

— THE LEMON-COLOURED BROOM is a useful waterside plant; its drooping character well fits it for the margins of a lake, especially when a rockery close to the water offers a suitable position for it to grow in elevated some distance above the water; the reflection then in the water is very clear and generally admired. This Broom succeeds in almost any soil when once established; a heavy retentive one suits it well. In a peaty mixture the growth in its young stage is more quickly made.—S.

— FRUIT PROSPECTS—MID-SUSSEX.—The dry weather that prevailed up till the middle of May has been favourable for fruit "setting" on our heavy land. The frost on the morning of the 17th was not so heavy as in other parts of the country as reported, but it was sufficient to cut the Potatoes nearly to the ground. Strawberries just beginning to open their first blooms were destroyed, but fortunately the greater part of the bloom was well protected by foliage, and is all right. Bush fruits will be a full crop, but Gooseberries not protected by leaves have dropped from the frost. Apples have had a poor chance, for it has been more or less wet every day since they came into bloom. Pears are a full crop, and will require thinning freely.

— THE TOTAL RAINFALL AT CUCKFIELD, SUSSEX, for May was 2.50, being 0.65 inch above the average. The heaviest fall was 0.52 inch, on the 17th. Rain fell on nineteen days. The highest temperature was 76°, on the 13th; the lowest 29°, on the 17th. Mean maximum 59°, mean minimum 41.1°, mean temperature 50°. Partial shade readings a little below the average.—R. I.

— THE WEATHER IN WARWICKSHIRE.—A severe thunderstorm passed over this district on Thursday afternoon, which did a great amount of damage to roads, trees, and property. The street drains were in many cases completely blocked up, and the ground floors of houses gutted. Garden walks and drives presented a sorry appearance when the deluge of rushing water had torn out the gravel, leaving deep channels in the sides. The general opinion is that so severe a thunderstorm has not visited this neighbourhood for thirty years.—H. DUNKIN.

— WEATHER AT RIPLEY, YORKSHIRE, DURING MAY, 1891.—May was very changeable, and on the whole a cold month. On 12th and 13th the weather was lovely. People were as loud in protesting about the heat as previously and subsequently they were about the cold. From the 17th to the 20th severe frosts were registered, and on the former date a heavy snowstorm of upwards of two hours' duration. Rain fell upon eighteen days; total fall for month, 1.65 inch, of which 0.30 fell on 1st. Mean reading of barometer, 29.81. Mean maximum temperature, 58.5°; mean minimum temperature, 36.9°; mean temperature, 47.7°. Highest maximum temperature, 76° on 12th, in shade; lowest minimum temperature, 20° on 18th, in shade. At or below 32° on five days.—J. TUNNINGTON, *Ripley Castle Gardens, Yorkshire*.

— THE WEATHER LAST MONTH.—May was remarkable for two very hot days, 12th and 13th, also for very cold weather after, with snow on 16th, 17th, and 18th; the last three days of the month were warm again. Total rainfall was 2.88 inches, which fell on twenty days, the greatest daily fall being 0.53, which came as snow on the 17th. Barometer was changeable; highest 30.29 on 12th at 9 A.M., lowest 29.39 on 18th at 9 A.M. Highest shade temperature 79° on 13th, lowest 29° on 19th, lowest on the grass 24° on 19th; mean temperature of the month 49.4°. We had only two clear days, and nine bright ditto. All vegetation was very backward at end of the month, Elm trees not in leaf, and some of the Apples not in flower until the 27th. The garden spring ran 10 gallons per minute on the 31st.—W. H. DIVERS, *Ketton Hall Gardens, Stamford*.

— REPORT OF WEATHER DURING MAY, 1891.—The weather during the past month has been of an uncongenial nature for horticultural purpose. The early part of the month was cold and dry, with the wind in the north and easterly quarters. The 11th, 12th, 13th, and 14th were grand summer days. The 16th was of a very wintry character, snow and hail falling like a winter's day, and continuing until the evening of the 17th; the sharp frosts both preceding and following doing a great amount of damage, Plums which were fully out in bloom suffering very much, but in spite of all I believe we have a fair crop left. Rain, hail, or snow fell upon seventeen days; maximum in any twenty-four hours being 0.81° on the 17th; minimum, 0.01° on the 10th. Total for the month, 2.76 inches, against 1.72 of 1890.—E. WALLIS, *The Gardens, Hamel's Park, Buntingford, Herts*.

— WEATHER AT LIVERPOOL.—The favourable change in the weather upon which I remarked in last week's issue has not been of long duration. We had last week scarcely a day free from heavy rains accompanied by strong cutting winds from E. and N.E. On Friday, Saturday, and Sunday nights the thermometer was very low indeed, and the weather might be compared to October, so cold was it. The only sunshine of any note for more than a week we are having to-day (Monday). Still the wind is N.E., and vegetables do not make very rapid progress. Pears have set remarkably well considering the severe weather experienced whilst in bloom. Strawberries are in full bloom; Gooseberries and Red Currants seem to be a good crop, and a great promise for Raspberries. Apples can scarcely be judged from their being so late to bloom, but we ought to have a good crop.—R. P. R.

— BULLFINCHES.—Under the head of "Fruit Pests," copied from the *Evesham Standard* (page 435), I am reported to have advocated "killing" bullfinches, instead of catching them in trap cages. As this is a misprint both in the *E. S.* and in the *Journal*, I may as well correct it in the *Journal*, because it is contrary to what I have so often advocated in your *Journal* on the score of humanity and economy if carried out at the proper season in the autumn. It is sometimes necessary to use the gun in the spring, but I never use it unless I feel it an absolute necessity.

— QUEEN WASPS.—Like other correspondents I notice a large number on the wing this spring. This is easily accounted for, as the nests last autumn produced a very large quantity of queens. For some unexplained cause, so far as I know, some seasons very few are to be found in nests. I have found hundreds some years, and others not a single queen except the old mother at the end of the season, when they should have been at maturity. I have just secured two nests, each about the size of a walnut, and one small comb inside, one *Vespa vulgaris*, and the other *Vespa germanica*. The former builds from Oak wood, and the paper is brittle; the latter from Willow, Poplar, or Ash, and the paper is tougher and slate colour.

— BLACK CURRANT MITE PARASITE.—Noticing the paragraph on page 448 on the "interesting discovery," perhaps I had better inform Mr. Wm. Thomson that he is quite wrong in supposing the maggot referred to was a caterpillar. I was present when Mr. Gibbon accidentally placed the maggot under his microscope and called my attention to it, and I examined many infested buds before I could detect a grub under my own microscope, although by continual research we found many others. They were without legs, and it was difficult to tell head from tail, as they were in shape almost exactly the shape of a cigar. I have never been able to detect these maggots in any other buds from other gardens or plantations, or at a subsequent visit and investigation at Mr. Gibbon's, at which I saw a large number of the buds placed in a glass jar, and although there were thousands of the phytophagous crawling round the inside of the jar we could see no maggot or fly inside the jar, as we hoped to do. There were numerous caterpillars crawling round the buds, such as referred to by Mr. Thomson; but these had, no doubt, been picked off the bushes on the buds unnoticed, so we did not even care to notice them in connection with the object of our researches.

— CANKER ONCE MORE.—I have read very carefully the remarks on page 424, and also on pages 438-9, and would recommend others to do the same and compare the two paragraphs, and perhaps they will come to the conclusion that "we are not at the bottom of this question yet." There is no question on gardening matters that I meet with where there appears to be such utter confusion of ideas. When I called for the *Journal* last week I was invited into a friend's garden, and in passing a Pear tree I was asked the cause of the tips dying in the usual way. Looking to the seat of the mischief I had no hesitation

in pointing out that it was a true and genuine case of canker. Cutting off a shoot which was just withering in the foliage I said I would put it under the microscope. I took off a piece of the bark at the point of attack, and had no difficulty in finding the usual insect pests, and I pointed out that at every rough place which shows signs of breaking out and bursting there the insect life is sure to be found. But I must not believe these to be the cause of canker but the effect. Get rid of them and canker disappears. Trees become healthy without regrafting. The roots are down in the "bad subsoil" where they have been thirty or forty years, and are not likely to be disturbed in grass orchards.—*J. HIAM, Astwood Bank.*

— **THE PEARL BUSH.**—*Exochorda grandiflora*, sometimes called *Spiraea grandiflora*, is flowering freely now in the shrubberies, and the snowy white flowers contrast so well with the green foliage that it is a pity more of it is not seen in gardens. It is handsome growing as a bush in the mixed shrubbery, but it succeeds better when treated as a wall plant, especially if it can enjoy a southern aspect, where the growth becomes so much better ripened than when in the open. A loose method of training the shoots gives the best effect, allowing the front branches to hang down from the wall, afterwards removing the weakly ones annually.—*E.*

— **DOUBLE TULIPS** are not often employed in the beds; why I do not know, except that they are more liable to be broken by winds and heavy rains, which latter, owing to the cup-like form of the flowers, present a lodgment for water, which increases the weight of the flowers. So much appreciated here is the variety *Tournesol*—crimson and gold—that precaution is taken to reduce the loss to a minimum from breakage of the succulent flower stems by the weight of the blooms, that to each we place a support, a thin hazel stake, giving just one tie with bast. By employing the last year's shoots of the hazel the bark is similar in colour to the stem of the Tulip, so that such support is not obtrusive. This variety succeeds capitally out of doors, growing about 10 inches high.—*S.*

— **THE FROST.**—Bush fruits have partly escaped injury, there being in most cases something like half a crop. Strawberries have suffered considerably. All the "king" fruits are destroyed in the early kinds. A few Nobles in a warm early corner are more than half destroyed, although many flowers were not anything like open at the time. Several large Beech trees about here are so much injured by the 16° of frost that it seems doubtful if they will break again. There are no signs at present. The Ash and the Oak at present show scarcely any sign of breaking into leaf. Everything will be unusually late in this district, as the weather is still very cold. Wind N.E.—*W. A. JENKINS, Durham.*

— **LAXTON'S COMMANDER STRAWBERRY.**—I herewith send you a few fruits of Laxton's Commander Strawberry. They are a fair sample. You can picture a shelf with 100 plants in 6-inch pots, bearing long stems with eight to fifteen fruits, ripe and colouring, on each plant, hanging well over the pots. They were grown in a cool Peach house on a shelf close to the glass. I send also fruit of James Veitch grown on the same shelf. We have picked some 1½ oz. in weight. They are not so good in quality as Commander. Noble has done well in the same house. The flavour was better than when grown out of doors last year. We are trying about 100 pots of Waterloo under glass. It does remarkably well out of doors, and is of good quality.—*G. FOSTER.* [The fruits of Commander were of the first size and quality, the richest in flavour we have yet tasted, and those of James Veitch very fine indeed.]

— **MR. MALLENDER** sends the following SUMMARY OF METEOROLOGICAL OBSERVATIONS AT HODSOCK PRIORY, WORKSOP, NOTTS, FOR MAY, 56 feet above mean sea level. Mean temperature of month, 48.5°. Maximum on the 13th, 74.7°; minimum on the 17th, 27.1°. Maximum in the sun on the 31st, 125.9°; minimum on the grass on the 17th, 18.3°. Mean temperature of the air at 9 A.M., 50.3°. Mean temperature of soil 1 foot deep, 49.6°. Nights below 32°, in shade four, on grass thirteen. Total duration of sunshine in month 150 hours, or 31 per cent. of possible duration. We had seven sunless days. Total rainfall, 3.27 inches. Rain fell on seventeen days. Average velocity of wind, 9.3 miles per hour. Velocity exceeded 400 miles on one day, and fell short of 100 miles on four days. Approximate averages for May:—Mean temperature, 50.6°. Sunshine, 175 hours. Rainfall, 1.93 inch. A cold, unsettled, rather dull and wet month. Snow showers on the 16th and 17th; vegetation very late. The Hawthorn opened a few flowers on the last day of the month; Horse Chestnuts and Lilacs only during the last few days. Potatoes and fruit blossoms are damaged by the frosts.

— **CARTER'S NURSERIES, FOREST HILL.**—A "Visitor" who called at these nurseries a week ago appears to have been more than satisfied. The *Caecolarias*, he describes, were represented in a great variety of bright colours, and the blooms large, smooth, and well formed. The *Cinerarias*, though naturally fading for seeding, still made an effective and diversified display. *Gloxinias*, grown in immense numbers, were noticeable by their handsome blooms, plants and varieties alike being superior; *Petunias* in bewildering variety and indescribable colours. *Begonias* were just unfolding, and will soon have a brilliant effect, and *Cacti* were represented in all the grotesque forms for which these interesting and easily grown plants are remarkable. He concludes by saying he never saw the nursery looking so well, and he considers the collections referred to a credit to the firm, manager, and cultivators.

— **AT the ordinary meeting of the ROYAL METEOROLOGICAL SOCIETY**, to be held at 25, Great George Street, Westminster, on Wednesday, the 17th instant, at 7 P.M., the following papers will be read:—*"A Curious Case of Damage by Lightning,"* by Alfred Hands, F.R.Met.Soc. *"Mean Temperature of the Air at the Royal Observatory, Greenwich, as Deduced from the Photographic Records 1849-1888,"* by William Ellis, F.R.A.S. *"Comparison of Thermometrical Observations in a Stevenson Screen and on the Revolving Stand at the Royal Observatory,"* by William Ellis, F.R.A.S. *"Phonometer,"* by W. F. Stanley, F.R.Met.Soc., F.G.S. *"Some Suggestions Bearing on Weather Prediction,"* by Alex. B. MacDowall.

— **NEW TOMATOES.**—Tomatoes are grown very extensively by Mr. Henry Whateley, Spring Gardens, Kenilworth, this district being noted for its market gardens, and especially for Strawberries. Mr. Whateley was induced this season to try three or four new varieties, two of which he considers to be acquisitions, and that he intends growing extensively another year. One is an American variety named *Ignotum*, which was strongly recommended to him by Messrs. Hooper and Co., and it certainly deserves all that was said by them respecting it. It is early, much earlier than Conference growing by the side of it, is a heavy cropper, the fruit very large and smooth, and for the future this fine variety will be extensively cultivated at Spring Gardens. The other is a new variety named *Tennis Ball* recommended by Messrs. Watkins & Simpson, a distinct round handsome fruit of more of an oval shape, of medium size, and bearing from eight to ten good fruits in a cluster. This good variety also comes into bearing early.—*D.*

STONELEIGH ABBEY.

STONELEIGH ABBEY, the Warwickshire residence of Lord Leigh, is easily reached from Kenilworth, Leamington, or Warwick, and is a massive noble mansion, from which terraces and steps lead to the River Avon, a broad stretch of which runs for a long distance in front of the Abbey and pleasure grounds. At some time I will enter more into details of the many objects of interest in the gardens. The unique and greatly admired Ivy-covered walks are of great length, width, and height, forming two sides of a square, with a very large handsome rustic summer house in the centre. I think there is nothing like it in the country; it has been the work of years, and alone is worth seeing. My chief object in visiting Stoneleigh early in June was to ascertain the state of the fruit crops there, for the gardens are very extensive, well walled, and fruit is well cared for.

The cultivation of Gooseberries is carried out in a somewhat novel manner. No bush trees are grown. There is a long high north wall covered with cordon-trained Gooseberry trees a few inches apart, run up on a single stem and kept closely cropped, the men now being at work cutting out all the young growth. These trees are loaded with fruit, from which they have been gathering for some time. Opposite is a wire fence or trellis, 5 feet high and 50 yards long, on which are cordon Gooseberries 9 inches apart, an unbroken hedge of fine trees full of fruit. Red spider made its appearance amongst them about the middle of April, and Mr. Beddard has close by a large tank of lime water, and with a garden engine gives repeated syringings to the trees and keeps them clean and healthy, and a good drenching of liquid manure is occasionally applied to the roots. Looking at this wonderful Gooseberry fence it is seen that by this method of culture there is great economy of ground; that protection can be so very easily applied at the time of late spring frosts should it be necessary to do so, but Mr. Beddard does not, as the foliage is ample; and that the trees can be so readily kept clean on both sides by syringing. The Currant crop is only a moderate one, but Black Currants in the district altogether have suffered severely from the late frosts, and there will be very little fruit. Raspberries promise fairly well. Strawberries promise well, but the late frosts destroyed very many of the early blooms, so that the early crop is a failure, and that means a serious loss to growers in the Kenilworth district, where Strawberries are so extensively and generally cultivated. Apples promise a great crop; Pears and Plums, on bush and other trees, a fair crop. The Stoneleigh gardens are rich in outdoor trees, many of them of considerable age, and all are kept closely pruned. Mr. Beddard may well be proud of his wall trees and the enormous crop of Pears.

In talking with one of the oldest of the gardener's men, who has spent a long life at Stoneleigh, he told me that he could not remember so great and general a crop there. There are a number of very fine Pear trees, and it is a pleasure to see such crops. Morello and other Cherries on the walls are well set, and there is a fair sprinkling of Apricots. A long wall of Coe's Golden Drop Plum trees, some of them forty years old, are well set with fruit, but on another wall of Plums of other kinds there is only a very moderate crop. Peach trees on the walls do not look so well as could be wished, and it is to be regretted that covered walls do not exist here. The Stoneleigh Gardens lie close to the River Avon, and late frosts are felt. There is only a sprinkling of Peaches and Nectarines, and with glass coverings there would be at least two fine walls of Peaches and Nectarines.

In the pleasure grounds the large plants of Pampas Grass are almost killed, and a fine old Cork Tree has been seriously injured by the severe winter. The Tree Pæonies have escaped, and are now in bloom, and are always worth looking at at this time of the year. Potatoes were cut down to the ground by the late frosts, but Mr. Beddard had had them well moulded up, fearing frost, and they are now going ahead again.

Immense quantities of cut flowers are constantly wanted, and must

Jennings' admirable system of managing Carnations was then fully described in this Journal (page 439, November 20th, 1890).

In some of the leading gardens of this country these stately Carnations are now much prized, and very handsome they are for grouping or similar decorative work. At all the establishments of our great horticultural patrons the Rothschild family Carnations are favourites, and nearly equally share the honours with the Orchids, but in other places also the culture of these plants is successfully carried out. A notable instance of this is afforded at Canford Manor, Wimborne, the residence of Lord Wimborne, where the gardener, Mr. Crasp, has a large house filled with vigorous plants in perfect health and showing substantial blooms in great abundance. They will provide a grand floral display for some weeks to come.

CULTURE OF CELERY.

CELERY is a hardy biennial, and is a native of Britain, being found wild in marshy places, and by ditches in meadow land. Well grown specimens of the cultivated varieties are much appreciated, not only in

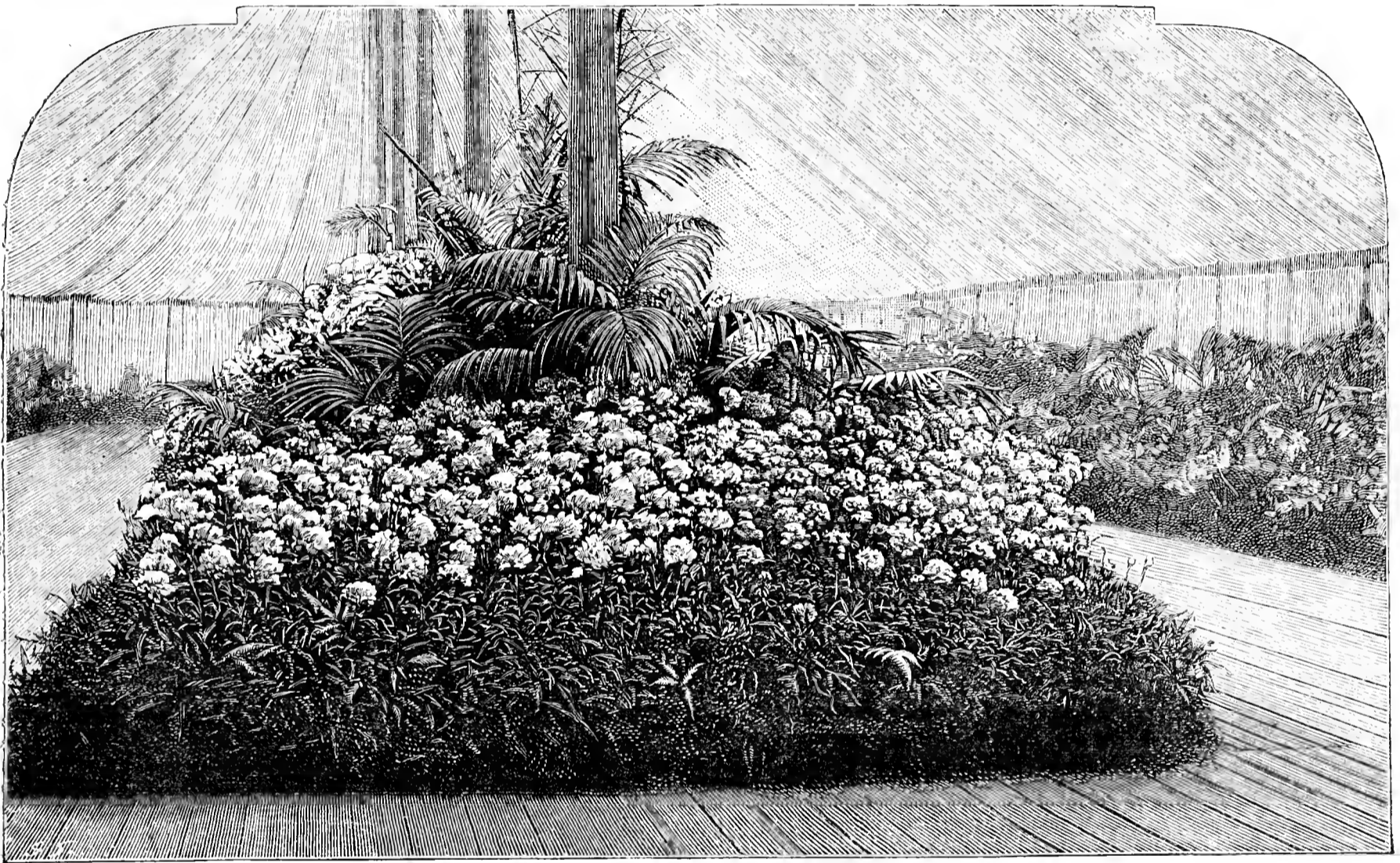

FIG. 90.—GROUP OF CARNATIONS AT THE TEMPLE SHOW.

be supplied. The crops of Grapes are very promising, especially Muscats; and the general requisites of the household and of such a large establishment—they are heavy—require watchfulness and care. Stoneleigh is always worthy of a visit, and is especially so through the summer, and the gardens are kept in admirable order. In one of the houses I noticed several plants of *Streptocarpus* in full bloom, and I mention it as Messrs. Veitch & Sons are bringing out some fine new varieties. In the Italian gardens bedding Pansies and Violas play an important part, and are now bright masses of colour.—A VISITOR.

CARNATION SOUVENIR DE LA MALMAISON.

AT the recent Temple Show the group of Carnation *Souvenir de la Malmaison* from Ascott, the residence of Leopold de Rothschild, Esq., constituted one of the special features which attracted as much admiration as any other exhibit from the numerous visitors who are interested in these fashionable favourites. The gardener at Ascott, Mr. Jennings, has repeatedly proved his skill as a cultivator of these and other plants, and the groups occasionally shown at exhibitions have invariably gained high honours though not entered in competitive classes. Carnations generally are well grown at Ascott, and it may be remembered that about 1500 plants of *Miss Joliffe* are grown, and that upwards of 50,000 flowers were fully open or expanding at one time last November. Mr.

this country, but also throughout Europe. It is undoubtedly a very wholesome vegetable, and though not agreeing with some constitutions, there are persons who attribute wonderful virtues to its use—to wit, the curing of rheumatism.

The following are the best varieties to grow:—Sutton's White Gem.—The sticks of this variety are very close and firm, and edible almost to the leaf. Well-grown specimens are sweet, crisp, and possess a fine nutty flavour. Carter's Solid Ivory is of dwarf compact habit, and beautiful white colour, and very crisp. Webb's Solid White.—A large handsome variety, with dwarf habit of growth, very solid, crisp, and of fine flavour. Veitch's Solid White is of close habit, growing 2½ feet high, thick, hearts firm and solid, and good flavour. Other good white varieties are Sandringham, Turner's Incomparable White, Wright's Giant White, Daniel's Giant White, and Dickson's Matchless. Carter's Standard Bearer Red.—This is a grand variety, sometimes attaining a length 3 feet and upwards, and 1 foot in circumference, crisp, and solid. Webb's Mammoth Red is a quick growing variety, solid, and tender, and possessing a pleasant nutty flavour. Daniel's Giant Red.—This is another large and excellent red Celery, being solid and of good flavour. Major Clarke's Fine Solid Red is a good all-round variety. Williams' Matchless Red, Dickson's Superlative Red, and Sulham Prize Pink, and Wheeler's Pink Perfection, are also good varieties.

Soil.—The soil which Celery delights in is light, rich, and moist

rather than dry. At the same time, it must not remain excessively damp during the winter, because such a soil would cause the Celery to rot. A stiff and adhesive soil is not suitable for the culture of this moisture-loving plant, except in the case of plantings for autumn use.

Seed and Sowing.—Where there is not the convenience of a hotbed in which to raise young Celery and other plants, open a pit about 2 feet square, and the same depth, in a warm corner of the garden. Fill this with short stable dung to within 4 inches of the top, and surface with light, rich, fine soil, made level and firm with the hand, and on this sow the seed thinly about the middle of February, covering it lightly with some of the same kind of soil, and then water gently through a fine-sprayed watering-pot. Place a handlight or a square of glass over the seed bed, and cover with a mat or litter until the young plants appear, when they should be fully exposed to daylight, tilting up the glass a little on fine days to prevent the plants making a weakly growth. Make another small sowing in the middle of March, and a third on a warm border a month later, without protection.

Pricking Out the Seedling Plants.—As soon as the plants have made two or three rough leaves they may be pricked out about 4 inches apart in 2 or 3 inches deep of sifted soil, placed on a like depth of short dung, resting on a hard bottom near a south or west wall or fence. They should be dropped into holes made with a small pointed stick, the soil being pressed about the roots, sufficient water being given to settle the soil about them, then shaded from sunshine until the roots have pushed into the soil. This may be easily done by placing a mat or cloth over a few Bean sticks supported by short forked sticks. The soil should always be kept moist about the roots of the plants. As the days lengthen, and the plants increase in growth, the application of water at the roots should become more frequent.

Preparing the Trenches.—The best way to grow Celery is in trenches running north and south. The width of these must be determined by the number of rows intended to be planted in each trench. The best sticks of Celery are secured by planting only one row of plants in each trench. These single-row trenches must be 4 feet apart from centre to centre, at least 12 inches deep and 16 inches wide; the soil taken therefrom being formed into a ridge between the trenches, on each of which a couple of rows of Lettuce may be grown at 1 foot apart during the interval from opening the trenches to the general earthing-up of the plants. Into each of these trenches dig 6 inches deep of the best manure at command, breaking the soil fine as the work of digging is proceeded with.

Transplanting.—The plants, having been pricked out in soil prepared in the manner recommended above, can be lifted with balls of earth and short dung attached to the roots. Set these 9 inches asunder along the centre of the trench, planting them therein with a garden trowel, and making the soil firm about the roots with the hands, giving water immediately afterwards to settle the soil. Take advantage of showery weather to transplant these and all other plants, as they then experience little, if any, check. As soon as the plants, from any or all of the sowings, have attained to a height of 3 or 4 inches, they should be transplanted in the manner just described.

Earthing the Plants.—When the plants have made from 12 inches to 15 inches growth earth them in this way. The soil is cut down a little from the ridge on either side the plants, the leaves are then drawn together in an upright position at the top, and held with one hand while the loosened soil is drawn up and pressed round each plant with the other hand up to within a couple of inches of the heart or top of central leaves, taking particular care not to let any of the soil get into the heart of the plants in the process of landing them up, as this would spoil the heads or sticks of Celery. By allowing the plants to reach the heights mentioned before earthing them up, labour is economised and the chance of soil getting into the hearts is lessened, while the primary object of earthing-up—blanching the head, is secured as completely as by carrying out the operation at shorter intervals. It is not only a waste of labour to earth Celery when about 6 inches high, as is frequently done, but the risk of getting soil into the hearts is thereby increased. The last earthing should be done before frost sets in. In the event of the weather being severe the tops of the plants must be protected by a sprinkling of the Braeken Fern (which is very plentiful in some districts) or straw. This can be removed in mild weather and returned when necessary. It is almost impossible to keep Celery plants too moist at the roots during the summer and early autumn, therefore copious supplies of water should be given during hot weather, or a large per-centage of the plants will "bolt," *i.e.*, run to seed.

Insect Attacks.—The Celery fly (*Leptis onopordinis*) lays its eggs in or upon the leaves of the plant, and the larvæ produced feed upon the soft green substance of the leaves, forming blisters or hollows within the leaf. These maggots are found from June to November, and the only way of preventing their spreading is to pinch the blisters as soon as they appear, cutting off and burning all the affected leaves that can be removed with safety to the plant. A mixture of fresh soot and lime dusted over the plants while damp is a good remedy for most insects which attack the leaves.

Turnip-rooted Celery.—This is much prized in France and Germany as a table vegetable. Unlike the common Celery the stem instead of forming a mere extension of the leaves develops into knobs, weighing from 1 to 5 lbs. each. This is sometimes sliced and used as an ingredient in salads. It is much more hardy than the ordinary Celery, and its roots can be taken up and stored out of the reach of frost. The plants can be raised in the same way as the ordinary Celery, and the young plants treated in the way recommended above. At the beginning

or middle of June the plants can be placed out in a piece of moderately rich and rather sandy soil, in rows 18 inches apart, and the plants set 1 foot asunder in the row. Before planting all the side shoots, some of the outside leaves and the side or branching fibres on the roots are removed. The plants are set shallow, the roots being scarcely so deep in the ground as they had previously been. During growth a little of the soil can be drawn from around them once or twice, and all lateral or side fibres removed. When nearly full grown the bulbs should be covered with a little soil in order to bleach them.

Taking the Crop.—The roots will be fit for use in September or October. Before severe weather sets in the crop may be taken up, divested of all the foliage except the heart leaves, and be laid in a dry border in front of a south wall or fence, burying the bulbs about an inch underneath the soil, and protecting them with fern or litter when considered necessary.—H. W. WARD.

THE ROYAL NATIONAL TULIP SOCIETY.

MANCHESTER.—JUNE 6TH.

IN dull weather, with leaden skies overhead and a north-easterly wind reminding one of March, the annual Exhibition, postponed from the 30th ult., was held. A more trying season for Tulip growers has scarcely been experienced. Not only are the flowers late, but they show signs of stress of weather—damaged in petal, tinted with green, and otherwise defaced; and yet a great many more blooms were staged than we expected to see, and a few exceptionally good blooms were exhibited, but they were generally small, and so late are they in some districts that the fear is for lack of warm sunny weather to assist the expansion. Many buds may rot. At the luncheon to the Judges which followed the making of their awards, Mr. Samuel Barlow made allusion to the serious losses the Tulip Society has experienced during the past year through the deaths of leading supporters, and deplored the falling off in subscriptions which would be the result, and expressed the hope that some young growers would be found coming forward to take the places of those they had lost.

The flowers were arranged on tables placed down the centre of the glass-covered annexe. There were six collections of twelve dissimilar Tulips, two feathered and two flamed, in each class. The first prize was awarded to Mr. Thomas Haynes, Warwick, for twelve blooms, which stood out from all the rest in regard to size, marking, and finish. He had of feathered bizarres Sir Joseph Paxton and Duke of Edinburgh (Haynes), the latter a seedling from Captain White or Sanzio, of a bright deep golden ground colour, feathered with rich crimson, a variety of excellent build; flamed bizarres, Sir Joseph Paxton and Dr. Hardy; feathered bybloemens, Violet Amiable and Bessie; flamed bybloemens, Duchess of Sutherland and Talisman; feathered roses, Heroine and Lizzie (Dymock); flamed roses, Mabel and Aglaia. In addition to Duke of Edinburgh, flamed bizarres Sir J. Paxton and Dr. Hardy and flamed Rose Mabel were in very good character. Second, Mr. J. H. Woods, Royton, with blooms much smaller in size than the foregoing, having feathered bizarres Sir J. Paxton and Masterpiece; flamed bizarres, William Lea and Sir Joseph Paxton; feathered bybloemens, Talisman and Adonis; flamed bybloemens, Chancellor and Duchess of Sutherland; feathered rose, Aglaia and Miss Wood, a charming flower, feathered with cherry-rose; and flamed roses, Mabel and Aglaia. Third, Mr. Samuel Barlow, Stakehill House, whose flowers were quite small owing to their lateness. He had feathered bizarres Lord Stanley and William Wilson; flamed bizarres, Sir J. Paxton and Ashmole's Seedling; feathered bybloemens, Mrs. Cooper and Alice Grey; flamed bybloemens, Jackson's Seedling and Talisman; feathered roses, Heroine and Modesty; flamed roses, Lady Catherine Gordon and Annie McGregor. Mr. C. W. Needham, Royton, was fourth, and Mr. J. W. Bentley, Stakehill, the Hon. Secretary to the Society, fifth. There were nine stands of six varieties, and here Mr. T. Haynes was again first with six excellent blooms, one feathered and one flamed, in each class. He had of bizarres George Hayward, feather very fine, and Sir J. Paxton, flamed, also in fine character; bybloemens, Conersby Castle, feathered, and Talisman, flamed; roses, Mabel, both feathered and flamed. Second, Mr. C. W. Needham, with bizarres Masterpiece, feathered, and Sir J. Paxton, flamed; bybloemens Unknown, feathered, and Duchess of Sutherland, flamed; roses, Mabel, both feathered and flamed. Third, Mr. J. H. Wood, with bizarres Sir J. Paxton, both feathered and flamed; roses, Modesty, feathered, and Mabel, flamed; bybloemens, Adonis, feathered, and Talisman, flamed. Fourth, Mr. Samuel Barlow, who had in fine form General Grant, a red-feathered bizarre, and Friar Tuck, feathered bybloemen. Fifth, Mr. Joseph Hague, Stockport. Sixth, Mr. J. W. Bentley. Seventh, Mr. W. Dymock, Stockport.

Class 3 was for six Tulips, one of each class, the competition confined to half-guinea subscribers only, four of these competing. Here Mr. John Hayes, Lowton, was first with bizarre Sir J. Paxton feathered, and Orpheus flamed; roses, Industry feathered, and Mabel, flamed; bybloemens, Bessie feathered, and Adonis, flamed. Second, Mr. J. Housley with bizarre Royal Sovereign feathered, and Sir J. Paxton flamed; bybloemens, Agnes feathered, and Chancellor flamed; roses, Mrs. Seaforth and Mabel flamed. Third, Mr. S. Johnson, Stafford. Fourth, Mr. W. Prescott, Lowton.

In the class for three feathered Tulips, one of each class, Mr. J. H. Woods was first with bizarre Sir J. Paxton; bybloemens, Violet Amiable and Modesty flamed. Second, Mr. Samuel Barlow with bizarre William Wilson, bybloemen Mr. Cooper, and rose Sarah Headly,

very bright. Third, Mr. C. W. Needham with bizarre Masterpiece, bybloemen Bessie, rose Alice. Fourth, Mr. W. Kitchen, Stockport. Fifth, Mr. John Hayes. Sixth, Mr. W. Prescott. With three flamed Tulips, one of each class, Mr. T. Haynes was again first with bizarre Sir J. Paxton, bybloemen Duchess of Sutherland, and rose Aglaia. Second, Mr. John Hayes with bizarre Orpheus, bybloemen Seedling, rose Mabel. Third, Mr. Samuel Barlow with bizarre Ashmole's Seedling, bybloemen Adonis, rose Aglaia. Fourth, Mr. J. Housley. Fifth, Mr. W. Kitchen. Sixth, Mr. J. Hague. Classes 6 and 7 were each for one feathered and one flamed flower. In the case of class 6 the competition was confined to half-guinea subscribers only, but the stands whether receiving a prize or not, could compete in class 7. But one competitor appeared in class 6, Mr. J. Housley, Stockport, who had flamed bizarre Sir Joseph Paxton and a feathered rose unnamed. This stand was also placed second in class 7, Mr. T. Haynes being again first with bizarres Sir J. Paxton flamed, and Masterpiece feathered. Third, Mr. John Hayes with bizarre Sir J. Paxton flamed, and Aglaia feathered. Fourth, Mr. W. Kitchen, Stockport. Fifth, Mr. A. Moorhouse. Sixth, Mr. C. W. Needham. Eight stands competed in this class.

Ten prizes were offered for the best single blooms of feathered and flamed Tulips of each class. The feathered bizarres were as follows:—First, Mr. S. Barlow with William Wilson, and second with Garibaldi; third, Mr. J. H. Wood with Sir Joseph Paxton; fourth, Mr. A. Moorhouse with Masterpiece; fifth, Mr. S. Barlow with General Grant; sixth, Mr. John Hayes with John Ratcliffe, very like Masterpiece; seventh, Mr. J. Hayes with Sir J. Paxton; eighth, Mr. S. Johnson with William Wilson; ninth, Mr. T. Haynes with Ajax; tenth, Mr. S. Barlow with Lord Stanley. Flamed bizarres.—First, Mr. T. Haynes, second, Mr. J. H. Wood, both with Sir J. Paxton; third, Mr. T. Haynes with Dr. Hardy; fourth, Mr. John Hayes with Orpheus; fifth, Mr. T. Haynes with Smith's Prince of Wales, a very promising flower, raised at Leicester; sixth, Mr. C. W. Needham with Masterpiece; seventh, Mr. W. Dymock with William Lea; eighth, Mr. S. Barlow with Seedling; ninth, Mr. W. Prescott with Pilot; tenth, Mr. J. Housley with Ajax. Bybloemens, feathered.—First, Mr. W. Prescott with Guide; second, Mr. J. W. Bentley with Bessie; third, Mr. W. Prescott with Violette Amiable; fourth, Mr. J. H. Wood with Alice Grey; fifth, Mr. W. Dymock Unknown; sixth, Mr. S. Barlow with William Parkinson; seventh, Mr. W. Dymock, and eighth, Mr. W. Prescott with Seedlings; ninth, Mr. J. Houseley with Lancashire Hero; tenth, Mr. S. Johnson with Talisman. Bybloemens, flamed.—First, Mr. W. Dymock with Chancellor; second, Mr. T. Haynes with Beauty of Litchurch; third, Mr. S. Barlow Unknown; fourth, Mr. S. Johnson with Chancellor; fifth, Mr. John Hayes with Lord Denman; sixth, Mr. W. Prescott with Adonis; seventh, Mr. S. Barlow with Bessie Improved; eighth, Mr. S. Johnson with Duchess of Sutherland; ninth, Mr. John Hayes with Seedling; tenth, Mr. A. Moorhouse Unknown. Roses, feathered.—First, Mr. W. Prescott with Industry; second, Mr. J. W. Bentley with Modesty; third, Mr. J. H. Wood with Industry; fourth, Mr. W. Prescott with Miss Headly; fifth, Mr. W. Prescott with Aglaia; sixth, Mr. J. W. Bentley with Julia Farnese; seventh, Mr. John Hayes with Mrs. Bright; eighth, Mr. S. Barlow with Sarah Headly; ninth, Mr. J. Hayes Unknown; tenth, Mr. J. H. Woods with Heroine. Roses, flamed.—First, Mr. John Hayes with Mabel; second, Mr. T. Haynes with Sarah Headly; third, Mr. John Hayes Unknown; fourth, Mr. John Houseley with Aglaia, and fifth with Annie McGregor; sixth, Mr. S. Barlow with Lady C. Gordon; seventh, Mr. W. Prescott with Mrs. Woolley; eighth, Mr. T. Haynes with Triomphe Royale; ninth, Mr. W. Dymock with Queen Henrietta; tenth, Mr. J. Houseley with Industry. In all the foregoing classes for single blooms a considerable number were staged.

Breeder Tulips lacked the fine size and rich colouring we have generally seen at this Exhibition. Mr. Samuel Barlow's first prize stand of six blooms was very correct, but much smaller in size than what he usually shows. He had of bizarres Hepworth's seedling 140 and Criterion; bybloemens, Glory of Stakehill and Maid of the Mill; roses, Mrs. Barlow and Rose Hill. Second Mr. J. H. Wood with bizarres William Lea and Lord Delamere; bybloemens, Alice Grey and Surpasse le Grand; roses, Mrs. Barlow and Mabel. Third, Mr. J. W. Bentley with bizarres Horatio and Sulphur; bybloemens, Hepworth's Seedling and Adonis; roses, Mabel and Unknown. Fourth, Mr. T. Haynes. Fifth, Mr. A. Moorhouse. Five stands competed in this class. There were eight stands in class 11 for three breeder Tulips, and Mr. S. Barlow was again first with bizarre Sir J. Paxton; bybloemen, Glory of Stakehill; rose, Miss Burdett-Coutts. Second, Mr. S. Johnson with bizarre Unknown; bybloemen, Maid of Orleans; rose, Miss Burdett-Coutts. Third, Mr. J. H. Wood with bizarre Sir J. Paxton; bybloemen, Alice Grey; rose, Mabel. Fourth, Mr. John Hayes. Fifth, Mr. J. W. Bentley. Sixth, Mr. J. Hague. Seventh, Mr. W. Prescott. Eighth, Mr. A. Moorhouse. In the class for single blooms of bizarre breeders the awards were as follows—First, Mr. W. Prescott with Sir J. Paxton; second, Mr. J. H. Wood with Stevens' No. 4 and third with Lea's No. 1; fourth, Mr. S. Barlow with Richard Yates and fifth with Pilot. Sixth, Mr. J. H. Wood with Sir J. Paxton. Seventh, J. W. Bentley with William Lea. Eighth, Mr. S. Barlow with Seedling. Bybloemen breeders.—First, Mr. S. Barlow with Ashmole's 126; second with Ashmole's 114; third with Unknown; fourth with Adonis. Fifth, Mr. J. Hayes, with Unknown. Sixth, Mr. Barlow, with Glory of Stakehill. Seventh, Mr. T. Haynes, with Seedling. Eighth, Mr. S. Barlow, with Seedling. Rose breeders.—First, Mr. S. Barlow with Seedling;

second with Mabel; third with Mrs. Barlow; fourth with Miss Burdett-Coutts; fifth with Seedling; sixth with Seedling. Seventh, Mr. A. Moorhouse with Annie McGregor. Eighth, Mr. J. W. Bentley with Industry.

Premier Tulips selected from the entire Show.—Premier feathered, Mr. J. H. Wood with Mrs. Wood; rose premier flamed, Mr. T. Haynes with Sir J. Paxton; premier breeder, Mr. S. Barlow with bybloemen Ashmole's 126.

NARCISSUS BERNARDI.

THOUGH not one of the large flowering and imposing Daffodils this little plant is interesting and not devoid of attractions. It has been shown several times lately in good condition, and at one of the meetings of the Royal Horticultural Society the sketch was taken which is reproduced in the accompanying woodcut (fig. 91).

Under *N. incomparabilis* albus in Mr. J. G. Baker's review of the genus *Narcissus* he has the following note:—

"Extending as a wild plant from Spain and the south-west of France to the Tyrol, and nearly or quite as common as the Daffodil in cultivation. It quite corresponds with the Daffodil in the leaves and general habit, but even through the double-flowered forms may always be known by the crown being not more than half as long as the divisions of the limb. Herbert produced a plant, figured at tab. 38 of vol. xxxix of the "Botanical Register," which is exceedingly like the

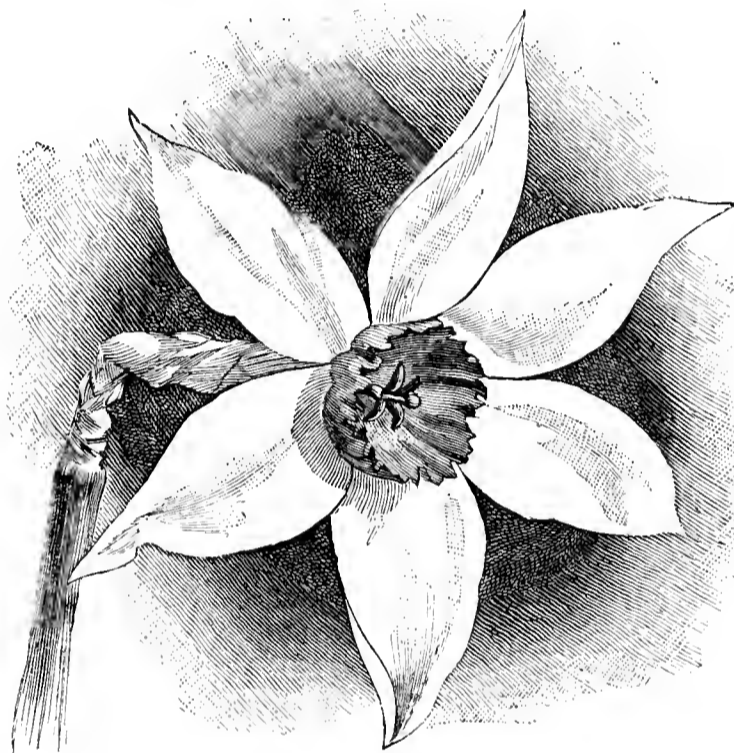

FIG. 91.—NARCISSUS BERNARDI.

var. albus, by fertilising one of the varieties of the Daffodil with the pollen of *N. poeticus*. We cannot distinguish *N. Bernardi* of Henon, judging of it from Henon's figure, and from copious dried specimens, by any definite character from *incomparabilis*; but Prof. Grenier, in his excellent and full account of the French *Narcissi* in the "Flore de France," keeps up *incomparabilis* as a species, but regards *Bernardi* as a hybrid between the Daffodil and *poeticus*. If this view be correct, we have a true and a hybrid *incomparabilis* barely distinguishable from one another, like the true and hybrid *Oxlip*."

ROYAL HORTICULTURAL SOCIETY.

JUNE 9TH.

THE Drill Hall was filled with varied exhibits, hardy flowers and Orchids predominating. Strawberries and other fruits were also represented in sufficient numbers to impart much additional interest to the meeting.

FRUIT COMMITTEE.—Present: Philip Crowley, Esq., in the chair, and Messrs. J. Lee, R. D. Blackmore, G. Norman, J. H. Veitch, J. Cheal, G. W. Cummins, W. Warren, A. H. Pearson, A. Dean, G. Wythes, J. Hudson, H. Balderson, J. Smith, F. Q. Lane, C. Penny, and Dr. R. Hogg.

From the Marquis of Salisbury, Hatfield (gardener Mr. G. Norman), came a tray of about fifty wonderful fruits of Sir Charles Napier Strawberries, of great size and fine colour. One of the largest fruits weighed 1½ oz., but there must have been many exceeding 1 oz. Strawberries are exceedingly well grown at Hatfield, and we understand that within ten days 140 lbs. of fruit were gathered from the variety named with Vicomtesse Hericart de Thury and a few others. A bronze Banksian medal was awarded for this remarkable exhibit. Mr. J. Smith, Mentmore Gardens, also sent several dishes of fine Strawberries, representing Laxton's Noble, Auguste Nicaise, Keens' Seedling, Sir Joseph Paxton, and Vicomtesse Hericart de Thury (vote of thanks). Mr. Allan, Gunton Park Gardens, Norwich, showed four seedling Strawberries, the merits of which were well tested by the Committee, and especial approval was expressed with regard to some that are to be tried at Chiswick.

The Messrs. Rothschild, Gunnersbury (gardener, Mr. Hudson), contributed a box of a dozen Lord Napier Nectarines, equally as remarkable in their way as the Strawberries from Hatfield. The fruits were very large, of an extremely rich dark colour, and they were described as part of a crop of twenty-four dozen gathered from a tree planted in 1878, which now occupies a space 24 feet by 12 feet (cultural commendation). Mr. Miller, Ruxley Lodge Gardens, Esher, sent some fine samples of Grand Admirable and Hick's Hardy Green Cos Lettuces, also three fruits of Melon Ruxley Lodge Favourite, and a dish of Peaches. Mr. Miller, Rood Ashton Park Gardens, Trowbridge, exhibited some well filled pods of Windsor Castle Pea (cultural commendation). Mr. J. Chinnery, Cefntilla Court, Usk, showed a seedling scarlet-fleshed Melon named Lord Raglan, and Messrs. Veitch & Sons, Chelsea, sent by request samples of the Apple Northend Pippin, which were compared by the Committee with fruits of the Gooseberry Pippin from A. H. Smee, Esq., and considered to be identical. Mr. G. Wythes, Syon House Gardens, Brentford, gained a cultural commendation for a dish of large Brown Turkey Figs, and an award of merit for a seedling Melon (unnamed), with a deep well flavoured white flesh, yellowish towards the centre.

FLORAL COMMITTEE.—Present: W. Marshall, Esq., in the chair; and Messrs. Herbst, R. Dean, J. Laing, C. T. Drucry, H. B. May, H. Cannell, R. B. Lowe, J. T. Bennett Poë, G. Phippen, T. Baines, C. Noble, B. Wynne, J. Walker, F. Ross, G. Nicholson, G. Gordon, J. Fraser, and W. Goldring.

Lord Wimborne, Canford Manor, Wimborne (gardener, Mr. T. H. Crasp), exhibited a large basket of handsome Rhododendrons, a box of fine Gardenias, and a collection of Pyrethrum. O. T. Hodges, Esq., Lachine, Chislehurst, had a small group of Alpine plants, including *Ramondia pyrenaica*, *Saxifraga McNabiana*, *Primula japonica alba*, and *Erinus alpinus*. Mr. E. Davies, Leamington Villa, Bishopston, Bri tol, sent flowers of Zonal Pelargoniums, and Mr. R. Dean, Ealing, showed a few English and Dutch Tulips, with the reddish *Lathyrus Sibthorpi* and the purple *L. rotundifolius*.

Messrs. J. Veitch & Sons, Chelsea, had an interesting collection of hardy flowers, amongst which the hybrid *Aquilegias* were very fine (strain commended). Several varieties of *Hydrangea hortensis* were also shown, including the large flowered bright rose mandshuricus, and the peculiar tricolor, which has green leaves edged with white and yellow, also the double purple *Wistaria sinensis fl.-pl.* and the distinct composite *Celmisia spectabilis* (certificated). Messrs. Kelway & Sons, Langport, contributed a grand collection of *Pæonies*, *Irises*, *Pyrethrum*, and hardy flowers (silver-gilt Flora medal). Messrs. W. Paul & Son, Waltham Cross, had an extensive exhibit of about twenty boxes of Rhododendrons, also samples of their beautiful new *Roses* (silver Banksian medal). Messrs. Collins Bros. & Gabriel, 39, Waterloo Road, showed a most effective group of *Pæonies* in many fine varieties, gaining a similar award to the preceding; as also did Mr. T. S. Ware, Totenham, for one of the brightest and most tasteful groups of hardy flowers seen at the Drill Hall for some time; and Messrs. Barr & Son, King Street, for a similar collection. Messrs. J. Laing & Sons, Forest Hill, staged a tasteful group of *Palms*, *Ferns*, *Tuberous Begonias*, and a few *Orchids* (bronze Banksian medal), and Messrs. H. Cannell & Sons, Swanley, showed some single and double *Begonias*, including a new double pink variety of dwarf habit. Flower heads of the purplish *Rhododendron fastuosum fl.-pl.* were also sent from Dropmore Gardens.

ORCHID COMMITTEE.—Present: Harry J. Veitch, Esq., in the chair; Messrs. S. Courtauld, T. B. Haywood, J. Douglas, J. O'Brien, E. Hill, C. Pilcher, H. Ballantine, H. M. Pollett, De B. Crawshay, A. H. Smee, and Lewis Castle.

Though two Orchid classes were provided for amateurs at this meeting, each one apparently expected the competition would be so keen that he feared defeat, and in consequence not one exhibit was entered, to the great subsequent disappointment of some of the nervous individuals when they found what an easy victory could have been scored. The competition for seedling Orchids excited some interest, but there were only two exhibits in that class, and these are described in the Orchid column. Still, four Orchids were found worthy of first-class certificates and three of awards of merit.

Messrs. Rothschild, Gunnersbury (gardener, Mr. Hudson), exhibited some strong racemes of a handsome *Lælia purpurata* named *superbiens* (vote of thanks). T. Statter, Esq., Stand Hall, Manchester, sent several varieties of *Cattleyas* and *Odontoglossums*. R. B. White, Esq., Arddaroch, showed *Cattleya Mendeli Enchantrass*. G. Fowler, Esq., Glebeland, South Woodford (gardener, Mr. Davis), sent varieties of *Cattleya Mossiæ* (vote of thanks). Mr. Le Doux had well grown plants of *Miltonia vexillaria* (cultural commendation); and Mr. R. B. Cater, Westfield, Bath, showed two varieties of *Cattleya Mendeli*, and a finely spotted *Cypripedium bellatulum*.

In addition to their hybrid *Disa* Messrs. J. Veitch & Sons, Chelsea, exhibited *Thunia Veitchi* from T. Bensoniæ and T. Marshalliana, with white sepals and petals, and a purple lip; *Lycaste hybrida*, supposed to be from L. cruenta and L. Deppei, with small deep yellow flowers; *Odontoglossum excellens*, from O. triumphans and O. Pescatorei, which together with *Epiphronitis Veitchi* has been previously noted.

Messrs. Sander & Co., St. Albans, had a small group of Orchids, the chief attractions of which were their hybrid *Lælia* (described on page 465) and the new *Miltonia vexillaria* Mrs. Henry Ballantine (certificated). With these were a delicate variety of *Cattleya Mossiæ Reineckiana* and a hybrid *Bertolonia* named *Madame Léon Say* (Bleu, 1890), charmingly veined, spotted with silver on a dark green ground. Messrs. Pitcher and

Manda, Swanley, had a group of hardy *Cypripediums*, and Messrs. H. Low & Co. showed a new *Cattleya* of the intermedia type, the sepals and petals spotted with crimson.

CERTIFICATED PLANTS.

Lælia hybrida Arnoldiana (F. Sander & Co.) and *Disa Veitchi* (J. Veitch & Sons)—Described on page 465.

Sobralia macrantha var. *Kienastiana* (Baron Schröder).—A magnificent variety with pure white flowers of great size, the lip extremely broad and long, with a lemon throat.

Miltonia vexillaria Mrs. Henry Ballantine (F. Sander & Co.).—An unusually distinct and charming variety, the sepals pure white, the petals bright rose in the centre edged with white, the lip rich rose.

Celmisia spectabilis (J. Veitch & Sons).—A dwarf plant of the Compositæ family, about 6 inches high with narrow lanceolate leaves, white and woolly beneath, the flower heads 2 inches across with narrow white ray florets and a gold centre. An interesting little plant that seems well adapted for culture in pots and perhaps for bedding purposes, but it was not stated whether it is hardy or not. For this and preceding first-class certificates were awarded. The following were adjudged awards of merit.

Pink Princess Maud (John Stacey, Farnham Royal).—A variety with large globular flowers, the petals white, fringed at the edge, and faint purple at the base.

Begonia Duchess of Leinster (J. Laing & Sons).—A single tuberous variety with grandly proportioned flowers, the petals very broad and rounded, the colour an extremely rich shade of orange.

Begonia Lady Lawrence (H. Cannell & Sons).—Another fine single variety with broad petals, the colour a clear golden yellow.

Cattleya Mossiæ Lawrenceiæ (Sir Trevor Lawrence).—Numerous as are the varieties of *Cattleya Mossiæ* this is very distinct and beautiful, the sepals and petals broad, pure white, the lip veined with gold on the throat, a few purple streaks in the centre, and a broad frilled margin.

Lælia elegans Cullimore's Variety (Malcom G. Cooke, Esq.).—Notable for the rich magenta lip, the colour extending nearly to the base of the side lobes. The sepals and petals are tinted with rose.

Spiræa multiflora compacta (Collins Bros. & Gabriel).—A most distinct form of the *S. japonica* type, very compact in habit, with fine feathery spikes of white flowers. A useful decorative plant.

Carnation Selby (Leopold de Rothschild, Esq.).—A free vigorous and handsome Tree Carnation, with well formed substantial flowers of a clear bright yellow colour, excellent in its colour and class.

Iris Queen of May (Kelway & Sons).—One of the *I. germanica* group, soft rosy mauve, the falls lighter at the base with darker veins.

Iris Princess of Wales (Kelway & Sons).—A variety of the same section, white, with a faint creamy tint in the centre.

Pyrethrum James Kelway (Kelway & Sons).—Single, remarkable for the brilliant crimson colour of its broad florets.

Tree Pæony Louise Mouchelet (Kelway & Sons).—Large white flowers of great substance.

Pæony Paradoxa (Kelway & Sons).—A handsome form of the *P. officinalis* group, with dark red flowers and an *Anemone* centre; it differs materially from the *Pæonia paradoxa* shown by Messrs. Barr and Son at the same meeting.

AN EXPERIMENT IN MUSHROOM GROWING.

I WAS rather interested on reading about growing Mushrooms, "A Critique and Reply," in the *Journal of Horticulture*, page 90, January 29th, 1891. I bought one of Wright's books last year, and made up two beds with manure as per account enclosed, which I send you. Do you think it was a medium success, or was it a success at all? As I am a beginner I should like to know your opinion. We are still getting a few pounds off the bed which I shall enjoy myself.

MANURE AND SPAWN PURCHASED.

	£	s.	d.
Twenty-five tons, nineteen cwt., manure at 2s. 6d.	3	4	11
Carriage of ditto, at 2s.	2	11	11
Cartage from station	1	19	0
Eight bushels of spawn, at 5s.	2	0	0
	£9	15	10

MUSHROOMS SOLD.

	£	s.	d.
October, 72½ lbs.	5	1	11
November, 147 lbs.	10	19	4
December, 43 lbs.	3	4	6
January, 34 lbs.	2	11	0
February, 120½ lbs.	8	0	2½
March, 133 lbs.	8	0	2
April, 76 lbs.	4	7	11
May, 35 lbs.	1	16	11½
661 lbs.	£44	2	0

Labour I cannot very well get at, as the young men have been employed an hour or two one day and an hour or two another at odd times. The beds have had no very close attention through our having a good bit of other work to do.—A. A. BENNETT, *Ashford Gardens, Cobham, Surrey.*

[Mr. Bennett tells a very different story from that on the page to which he refers. The Liverpool "Inquirer" failed because he

blundered; then of course blamed the book; but here by following exactly the same instructions a "beginner" tries his hands, and realises a profit on outlay which may fairly be put at 400 per cent. The account really shows nearly 500 per cent., but a reduction is made for 1 hour, and this, with the value of the manure in the beds, provides full compensation. Mr. Bennett does not "blame the book" nor doubt the statements in it.

It will be observed that manure in this case cost a little over 5s. 6d. a ton, and that the Mushrooms sold at an average of 1s. 4d. a pound during the months named, which are the only months in which Mushrooms can be profitably grown on ridges in the open air. That they can be so grown with advantage when suitable manure is obtainable at a reasonable price is beyond question, and as a matter of fact not a few London market gardeners, growers of vegetables and fruit, have found Mushrooms far more remunerative than any other crop during the past and present year.

It is not to be understood that every person who attempts the practice indicated will succeed to anything like the same extent that Mr. Bennett has, because some persons are more apt in appreciating the cardinal points in instructions than others are, and in carrying them out; but his experience is conclusive, that with suitable materials and intelligent management failure will not occur. He has proved the accuracy of every statement and every estimate in the work which "Inquirer" referred to so doubtfully with a very large margin to spare in favour of the author.—J. W.]



FRUIT FORCING.

PEACHES AND NECTARINES.—Earliest House.—When the fruit is all gathered from individual trees, the wood on which it has been produced should be cut away to the shoot at its base, which is to afford the bearing wood for next season, except if the fruit has been produced on wood that is necessary to retain for the extension of the trees. All growths not absolutely necessary for bearing next season or for the extension of the trees must be cut away, as it is important the foliage be fully exposed to light and air, and it is equally important that it die naturally, not prematurely through attacks of red spider or lack of moisture at the roots. Employ the syringe freely, keep the inside borders well watered, and the outside border must not be neglected if the weather be dry. Admit all the air possible, and when the buds are plump, and the wood thoroughly ripened, the roof lights, where moveable, may be taken off.

Trees Ripening their Fruit.—In gathering the fruit great care is necessary, as slight pressure is sufficient to spoil the appearance. Gather fruit for packing before it is quite ripe. Some netting suspended beneath the trees is useful to prevent falling fruits being bruised, but let the netting be "pocketed" so as to prevent the fruit clashing against each other. Ventilate freely, leaving a little air on constantly, and to ensure the preservation of the foliage in health sprinkle the paths, borders, and all available surfaces with water in the morning and afternoon, not allowing the soil to become dry, but giving water as required. A mulching of short spent material is very useful in preventing the surface cracking and the roots going down in quest of moisture. Syringing must cease directly the fruit commences to soften for ripening, or the moisture will cause the skin to crack and leave an unpleasant musty flavour, as well as spoiling its appearance.

Trees Started in January.—After the fruit takes the last swelling give every attention to the trees in watering with liquid manure or affording water through a mulch of short manure. The shoots should be allowed to extend, not pinching the laterals in too closely, but they must be prevented shading the fruit, which must be raised with its apex to the fullest light. This can be effected by placing laths across the trellis, securing them to the wires. Continue forcible syringing morning and afternoon until the fruit begins ripening, then cease syringing; but do not allow the border and other surfaces to become parchingly dry, as moderate moisture, provided the ventilation is liberal, will not injure the fruit, and it is absolutely necessary for the benefit of the foliage. The preceding remarks apply to trees that have been brought forward gently, and in consequence will ripen their fruit a month later than those started at the same time and brought forward as rapidly as consistent with ripening their crops.

Trees Started in February.—The fruit of these is stoning. It has made satisfactory progress, attaining to a good size, as is always the case when the trees are not hurried, not overcropped, and well attended to as regards aliment and proper exposure of the foliage to light and air with free ventilation on all favourable occasions. To continue the fruit in steady progress and insure its stoning satisfactorily there must not be any deficiency of moisture at the roots, and the foliage must be kept clean by daily syringings, and if necessary by the prompt application of an insecticide. Continue the temperature at 60° to 65° artificially, and a free circulation of air allowed between 70° and 75°, having it full when the latter is reached, and close at 75° with plenty of atmospheric

moisture. If the temperature rise to 80° or 85° it will not do any harm, but admit a little air after nightfall, so as to allow the pent up moisture to escape and the temperature to gradually cool through the night. Commence increasing the ventilation with the advancing heat from 65°.

Later Houses.—If it is desired to retard the fruit in any of these, so as to prolong the season of supply, it is best effected by freer and lengthened ventilation during the day and night when mild. Indeed there is only need to ventilate day and night to keep back the crop, so as to ripen about the same time, as that usually occurs with trees against walls, and by judicious ventilation the fruit may be had over a lengthened period. It is necessary not to overburden the trees with more fruit in the early stages of growth than can remain for the crop, and a moderate crop is always better than a heavy one; therefore thin well in the early stages, leaving a few more than will be required ultimately. Keep the trees well syringed, and mulch lightly, so as to keep the surface moist, thereby encouraging the roots to the surface, giving thorough applications of water when necessary, and if the trees are weak or heavily burdened with fruit afford liquid manure.

PINES.—Fruit Ripening.—When the fruits commence colouring syringing must cease, but the supply of moisture or water at the roots must be maintained, affording it whenever necessary. With a view to improve the quality of the fruit ventilate whenever circumstances permit, but do not allow the temperature to fall below 80° in the day, applying fire heat to maintain a night temperature of 70° to 75°, gradually reducing the moisture in the house. Queen and Providence Pines started in February will ripen this month, coming in about three weeks or a month before Smooth-leaved Cayenne, Charlotte Rothschild, and similar varieties started at the same time and under similar conditions. They afford a good successional supply, which may be still further extended by removing some of the plants with the fruits to a cooler house. Although the Providence Pine is not equal to a Queen in quality, yet its size being superior grow a limited number, as large fruits are useful at parties if only for effect in table decorations: The heat at the roots should be 85° to 90°.

Plants for Winter Fruiting.—The strongest of the plants in the fruiting pots last September will now be showing fruit, if not means must not further be delayed to effect it for a supply of fruit for winter use. Bring the plants together and subject them to a comparative state of rest for the next month or six weeks, lowering the heat at the roots to 75°, maintaining a free circulation of air about the plants in favourable weather, ventilating at 75°, and allowing the heat to fall to that degree before closing the house, only employing artificial heat to prevent the temperature falling below 60° at night, not withholding water altogether, but whenever a plant becomes dry afford it liberally. The smaller suckers of last autumn that were wintered in 7 and 8-inch pots, and shifted this spring, must be kept growing until the pots are well filled with roots, at which time, if considered necessary, they may be subjected to the same treatment as advised for the larger ones, and these plants will then give a successional supply of fruit.

Spring Potted Suckers.—The strongest of those potted last March may be in their largest pots, if not there must not be any further delay, as to allow them to become root-bound is detrimental to their after well-doing. Recently potted plants require regular bottom heat of 85° to 95°, and to be thoroughly watered after potting, not giving any more until the soil becomes dry. A too wet soil is not favourable to the formation of roots.

Ventilating, Watering, and Shading.—Young stock will be making rapid progress, and must be regularly attended to in every particular, allowing such plants sufficient space for development, as nothing is so injurious to a sturdy growth as crowding in the early stages. Ventilate early in the day at 75° to 80°, to render the foliage dry before it is affected by the sun. Examine the plants twice a week for watering, not giving any until it is needed, and then a thorough soaking with tepid liquid manure, being careful not to give it too strong. Discontinue shading succession plants; but fruiting plants with the crowns in close proximity to the glass will require a slight shade from powerful sun. Syringe the plants on bright afternoons, and otherwise maintain a genial condition of the atmosphere by sprinkling the house, but avoid moisture in dull weather, as it only tends to cause soft growth. So long as water remains in the axils of the leaves syringing is not much required, and pour the water well up the plants, as the leaves have roots at their base that contribute to the vigour of the plants and swelling of the fruits.

Potting Suckers.—The early-fruited plants as they finish will afford suckers, which should be taken in sufficient quantity to meet the demand and started at once, which will afford plants for fruiting about this time next year, forming supplementary plants to those started in the spring. The treatment then given will answer for these, only they will require more careful shading and frequent attention to damping, keeping close until rooted as indicated by their commencing to grow.

FIGS.—Early Forced Trees.—Generous treatment will be needed after the first crops are gathered to enable the trees to swell the second. Syringe twice a day to keep red spider in check, and afford liquid manure when watering is necessary, trees in pots requiring it daily, sometimes twice a day, and trees in borders once or twice a week, according to the extent of the rooting area. The second crop should be thinned before the fruit is the size of Walnuts, and in thinning reserve the largest fruits at the base of the shoots. Mulch trees in pots with rich material.

Succession Houses.—When the fruit commences ripening a free circulation of warm dry air should be afforded, which is essential to high

quality, not less so being the tying-in and regulating of the shoots by thinning and stopping, so as to afford the fruit the benefit of all the light possible. The moisture in the atmosphere will need to be moderated, not wetting the fruit, though if red spider attack the fruit should be gathered closely and a good syringing given, which will not injure the remaining fruit, provided it is done early on a fine day, so that the moisture does not remain long on the fruit. Do not allow any lack of water at the roots, yet give less supplies than when the fruits were swelling.

Young Trees in Pots for Next Year's Early Forcing.—These must not be neglected or disappointment is inevitable. They must have all the light possible, and be kept near the glass or as high as practicable without touching, so as to secure sturdy, well-ripened growth, keeping clean by syringing, and affording liquid manure to effect a stout growth. The growth being completed they may be stood outdoors to induce rest, but the wood must be well ripened previously, and to be of use for early forcing the wood must be matured early.

PLANT HOUSES.

Zonal Pelargoniums.—Where cuttings were rooted early for low standards to flower in winter the plants should now be ready for 7 or 8-inch pots, and will soon attain the height of 18 inches, when the point of the plant may be removed. Remove all side shoots except a few near the top required for furnishing the head. All others for autumn and winter flowering must be placed into their largest pots and arranged in cold frames to harden ready for standing in a sunny position outside. Plants that have only just been rooted may be placed direct into 4-inch pots, and when well established hardened and stood outside. Ivy-leaf varieties flowering in autumn may have the same treatment. If those to flower inside throughout the summer are not overpotted, they flower profusely when root-bound and arranged in a sunny position, artificial manure being supplied occasionally.

French and Zonal Pelargoniums.—Cuttings that are rooted may be placed singly into 3-inch pots and stood in cold frames until they are established, when abundance of air must be admitted or the plants stood outside. Cuttings of moderately firm wood can be inserted, and they will root quickly in gentle warmth, and make excellent plants for early flowering next season. Discontinue pinching, and even the latest may be allowed to come forward into bloom. Keep them cool, ventilating liberally by day and a little at night to maintain a dwarf sturdy growth. When the flower buds are visible artificial manure applied to the surface of the soil once a fortnight will prove beneficial. Soot water in a clear state is an excellent stimulant.

Hydrangeas.—Shoots that have failed to flower on plants that started into growth early are well developed. These may be removed and rooted singly in small pots under bellglasses in a warm house. It is not necessary to cut the shoots to a joint; any portion of the stem roots freely if kept close, moist, and shaded. The cuttings must be short, with a pair of good leaves at the base, and inserted so that what will eventually be the flower bud is only just above the surface of the soil. Two or even 3-inch pots may be used and filled with good loam, one-seventh of manure, and a little sand in the centre. Plants from which cuttings are taken will, if cut back closely, and kept under glass fully exposed to the sun make short-jointed growths, and carry three or four large heads another year.

Gladiolus The Bride.—Those in pots that have flowered under glass may be placed outside in a sunny position. If they are supplied with water as they need it until the foliage naturally dies away, they will flower freely again another season. Ixias and Freesias may have the same treatment.

Azaleas.—Varieties of *A. indica* that are just ceasing to flower should have all seed pods removed and subjected to a close shaded atmosphere to push them into growth. Carefully examine these plants, and if any trace of thrips exists upon them wash thoroughly in a solution of tobacco water, in which one ounce of soft soap to each gallon has been dissolved, and a piece of common washing soda the size of a Cob Nut. Plants that have flowered early for some years, and have been assisted by heat and moisture to make their growth, can be gradually hardened to cooler and more airy conditions ready for removal outside to ripen their wood. These as well as others that have not been repotted may have occasional applications of artificial manure applied to the surface. Soot water in a clear state imparts to the foliage a fine dark hue. Syringe freely, and do not allow these plants to suffer by an insufficient supply of water, or their silk-like roots will perish.

Epacris.—The main stock of these has started into growth, repot all that need more root room. Small shifts are desirable. The pots used should be liberally and carefully drained, and the plants after they are potted stood on a bed of ashes in cold frames. Syringe amongst the pots once or twice daily according to the weather. The plants may also be syringed lightly. Admit air freely during the day to insure sturdy growth, but close the frame early in the afternoon so as to raise the temperature a few degrees. Those that were assisted into growth by gentle heat may be gradually hardened to cool treatment. If kept too long in a confined atmosphere the growths will not have strength to support themselves.

Erica hyemalis.—These are much better in low frames than houses where abundance of air can be admitted daily after they have once started into growth. All that flowered early and have been repotted will now be well established and growing freely. A little air may be left on the frames in which these are growing all night. Those that flowered during January are ready for potting. Use for a compost good peat and sand; drain the pots well, and press the soil firmly into them.

For a fortnight or three weeks the frames in which these are grown may be kept on the close side.

Rhodanthes.—Let these have free ventilation, in fact they will succeed as well arranged on ashes outside as in frames. Support the stems with a few slender stakes and sow more seed.

THE BEE-KEEPER.

APIARIAN NOTES.

ALTHOUGH the weather is more favourable to field and garden, the bees are kept within their hives, much to their own and owner's advantage, as saving bee live now means at no distant time more honey. Since March came in with arctic severity bees could venture out only on three days without many being lost: and yet on these three days few bees flew. True to their instincts as barometers, they appeared to know the cold that was approaching, and which visited us the following day.

Although we can never depend upon the weather destructive to bee life being past before the middle of June, still I never experienced so long a term of it. Consequently queens have laid an enormous number of eggs to keep up the strength of the hive, far beyond the requisite number had the season been more favourable. Pointing to the chances that queens may give way at any time and be deposed, young queens will be brought forward, and one or more of these will lead off several swarms, much to the annoyance of the expectant but disappointed bee-keeper, who had, as he thought, given timely room by supering to prevent it. That this is sure to take place, especially where queens are above one year old, there need be no doubt, and bee-keepers will be studying their own interests by taking time by the forelock and have a good supply of young queens in readiness to meet emergencies. To accomplish this either form an artificial swarm or depose one or more queens, and after ten days or so form the stocks into nuclei, as described several weeks ago, gradually depose the old queens, when there will be less swarming and more supers filled.

SWARMING.

I hear of several swarms that came off about the 20th of May, and, singular to say, one of these stood at an elevation of 500 feet. I have not heard whether the old queens accompanied these swarms, or if they may have been premature owing to the queen relaxing in egg-laying. The old adage "That a swarm of bees in May is worth a load of hay," will not hold good this year, as in all likelihood in their great desire to work many will be lost, others will be worn out before there is sufficient food outside for them; thus feeding, while doing good in one sense, aggravates loss in the other. Where young queens have accompanied swarms weeks may pass before they can commence egg-laying.

Swarms are never more remunerative and give more satisfaction than when they issue at the beginning of the honey flow, unless the weather previously has been favourable; in that case an early swarm has the advantage. But, again, the size of the swarm has to be taken into account; and it is not unusual for a large late swarm to far surpass an earlier but smaller one. To ascertain the proper condition of things in this respect full sized hives must be used with all the other requisites, without which failure from one or more of the causes is certain. My own stocks are so far advanced that swarms may issue at any time, but they will not suffer in any way from delay, as the hives are all large enough to keep the queens laying even although they deposit the maximum number of eggs daily. With undersized hives this is prevented, because there are not empty cells enough to allow queens to deposit the maximum number daily, and consequently the bees swarm.

BEES AND THE DEATH'S-HEAD MOTH

It would be assuming too much to attempt to instruct "Entomologist" or to criticise his remarks in any way regarding insects;

but I must point out that we cannot be too cautious in accepting as facts the evidence of old authors.

I think I had good reasons for saying that the bees killed the death's-head moths, because they entered the hives and had the same doorway to escape as they entered by; and, secondly, the wings of the moths were invariably mutilated as if caused by the bees.

The propolis of the doorway I believe to be done to exclude stranger or robber bees. In my experience this always followed an attack by robbers. Some are of the opinion that it is done to guard against prospective cold. Be that as it may, the propolis defence is always allowed to remain till genial weather arrives the spring following the autumn when the defence was made.

Regarding the opinion that bees cannot sting the moth to death on account of the down and elastic membrane. I doubt that very much. A bee will penetrate the hair of a dog or the hair of a human being and deposit its sting in the skin beneath; but that is not even necessary to inflict pain or cause death, because bees eject the venom from their stings frequently when irritated, and I have often witnessed one bee kill another by this method, and have frequently had the acid squirted into my eyes without the bees touching me. Bees appear to know full well the vulnerable parts of their enemies.—A LANARKSHIRE BEE-KEEPER.

DEATH OF "A RENFREWSHIRE BEE-KEEPER."

A LARGE circle of friends and bee-keepers will learn with deep regret the death of J. M. McPhedran, Esq., of Craigbet, Renfrewshire, took place on May 28th last. He was well known amongst the latter as "A Renfrewshire Bee-keeper," the only signature he ever attached to his bee articles. He had not been long ill, and his death came with terrible suddenness upon many who knew him, and who had so lately seen him looking the picture of health. Mr. McPhedran was born in Greenock sixty-four years ago; he received a high education and good training, and although heir to an estate entered a shipping office while yet a young man. So exemplary in his manner and attentive to his duties that at the expiry of his apprenticeship there was a keen competition by different firms for his services, but at this stage he chose to enter into his estate, inherited through the death of his uncle, Dr. McCulloch, where he has remained ever since. A life-long abstainer, of the most simple habits, purest principles, and unostentatious piety, he scorned the hollow forms of polite society; he refused all county honours and local dignities. His splendid physique and commanding person attracted attention everywhere, yet he was so modest as never even to have been photographed.

It was as a bee-keeper, however, that readers of the *Journal of Horticulture* will feel the greatest interest in him. He has been a reader from the first number of the *Cottage Gardener* to the latest number of the *Journal of Horticulture*, and it is worth mentioning that on several occasions when the merits of various journals were discussed, he took the *Journal of Horticulture* in the one hand, and placing a finger of the other upon it, exclaimed, "This is the Journal!" It was through his excellent and practical articles upon the Stewarton hive that awakened so much interest in bee-keeping, and being in correspondence with the late Mr. T. W. Woodbury, revealed much information to the latter gentleman. As some of your readers are aware, he found under the pavilion of his mansion house a great colony of bees; carefully examining the whole bee edifice, and had bees and combs transferred to a hive of his own construction, and of the proper width of 1½ inch from centre to centre of combs, as the bees naturally build them. In the Stewarton hive he found the nearest approach to the bees' own system, and at once adopted it, and in time improved it. He had an observatory hive made, and studied minutely the habits of the insect, and very soon struck in with a powerful pen (through the *Journal*) into the controversy that went on as to wood or straw hives when Mr. Woodbury was bee editor. His contributions were so practical as to at once command respect, while being free from bitterness commended his opinions, even to those who were opposed to them.

He invented some useful things, such as the queen's introducing cage, and the bee drinking fountain is the prettiest and most efficient thing of the kind ever introduced. It, as well as other of his inventions, have found their way to America, and all are common property, even claimed by some here as well as in America, but which was received by him with a smile of amusement.

For years he was a most successful breeder of Leicester sheep, carrying off the prizes from the keenest competitors. Fond of the best quality of all kinds of farm stock, he was ever proud to assist others to attain to his high level of excellence, and would never condescend to the little tricks of exhibition breeders.

He never married, but lived with his two sisters a quiet life, extending always an open Scottish hospitality of the old style to many friends who will long cherish his memory.

His garden was one of the best kept, and contained the finest collection of old fashioned flowers in the county. He was ever proud to

share his flowers to all of his friends who desired them, while his orchard fruit and much of his home farm produce went to the poor. I will conclude with the following, which might well be emulated by employer and employé. When any young person was taken into his service he took them under his care as a father, teaching them all duties, supplied them with suitable books, two of which were the bible and a bank-book, with £1 as a beginning, and added to it periodically during the term of service, and not a few young men can attribute to this care and kindness their present successful career, and one old servant in his employ at his death has upwards of £1000 to his credit in the bank to support him in his declining years.—A LANARKSHIRE BEE-KEEPER.

QUEEN EXCLUDER ZINC.

I MUST enter my protest against the remarks of Mr. J. M. Hooker, on page 457, as being to a very great extent misleading, and contrary to the previous teachings of this *Journal*. Mr. Abbott was not the first to use excluder zinc. I think the Germans were the first to employ it while Messrs. Neighbour and myself made and sold excluders of strong wire before the time indicated by Mr. Hooker.

It is simply a piece of sophistry to say that previous to excluders the queen had access to the whole hive including supers. The Scotch bee-keepers were too shrewd to confine the queen to a less breeding space than was demanded, or so foolish as to open up the whole crown of the hive for the vitiated air to ascend and darken the combs, as our modern bee-keepers do, or to restrict the freedom of the loaded bees to ascend. Queen excluder zinc is superfluous and labour-giving to the bees.

The late "Renfrewshire Bee-keeper," as well as myself, long showed the superiority of the Stewarton system in preserving the purity of the comb, and our shows as well as the first Crystal Palace Show demonstrated the great superiority of the honey. Mr. Abbott attributed this to the use of comb foundation, then but little known amongst our modern bee-keepers; and commenting upon the honey at the Crystal Palace Show the *Times* said, "It eclipsed everything."

Mr. Abbott showed me the comb of honey referred to by Mr. Hooker, said to be taken from the "centre of the brood nest." I possess some knowledge of bees as well as of bee-keepers, but do not at all times express my opinion, but will do that on this occasion. It is contrary to the nature of bees to store honey in the centre of the brood nest, and consequently I am unable to accept any statement to the contrary.

I am glad to see Mr. Hooker approves of the storifying hives, but it was not Mr. Woodbury who invented them. Mr. Hooker does not, however, appear to urge this, but only alludes to Mr. Woodbury having "advocated" them. It was the late "Renfrewshire Bee-keeper" who improved the system, and by his sensible letters in the *Cottage Gardener* made bee-keeping what it is now.

Mr. Hooker's article in some respects proves what I have often said, that shows have been a failure so far as the cottager bee-keeper is concerned; and at our earlier shows he as a judge ignored the very hives he now praises, and what British and American bee-keepers now approve I proved to be good years ago, and publicly recommended them long before a single modern claimant knew anything about them.

I observe the queen excluder zinc is largely advertised, and I regard Mr. Hooker's article as nothing else than a huge advertisement.—A LANARKSHIRE BEE-KEEPER.

ON page 457 Mr. J. M. Hooker dilates on the advantages of the above to keep queens out of supers. May I be allowed to advise him to learn the true art of supering, as taught in this *Journal* by "A Renfrewshire Bee-keeper" and "A Lanarkshire Bee-keeper," when he will be able to keep queens out of supers without such an objectionable adjunct as excluder zinc.—A HALLAMSHIRE BEE-KEEPER.



TO CORRESPONDENTS

•• All correspondence should be directed either to "THE EDITOR" or to "THE PUBLISHER." Letters addressed to Dr. Hogg or members of the staff often remain unopened unavoidably. We request that no one will write privately to any of our correspondents, as doing so subjects them to unjustifiable trouble and expense.

Correspondents should not mix up on the same sheet questions relating to Gardening and those on Bee subjects, and should never send more than two or three questions at once. All articles intended for insertion should be written on one side of the paper only. We cannot reply to questions through the post, and we do not undertake to return rejected communications.

Mildew on Vines (H. B.).—Your letter arrived too late to be answered this week. The case shall have attention, and in the meantime we refer you to replies to other correspondents.

Tulips Failing (W. S).—We shall be glad if you will state the kinds of Tulips to which you refer, when and how they were planted, and if top-dressed with what material.

Exhibiting Mushrooms (G.).—Certainly a dish of first-class Mushrooms would "carry some weight" in a collection of vegetables exhibited towards the end of July, but whether those you may happen to have at the time will carry "more weight than Kidney Beans" no one can say without comparison. Inferior Mushrooms would be weaker than superior Beans and *vice versa*. The superiority of either on the day of the show should determine the choice. Never stage a had dish of anything if you have a good one of anything else.

Muscat Grapes (Anxious).—If you mean by the "limbs withering," the non-swelling of some of the berries, it is the result of imperfect fertilisation. This may be the consequence of too much atmospheric moisture or a too low temperature at a critical time. In our "Work for the Week" columns the proper conditions and methods for setting Muscat Grapes have been repeatedly pointed out. The bunch you have sent is not half so faulty as many we have seen, and it would not be by any means a bad one if it had been left and properly thinned. Remove the abortive berries, leaving those that are swelling freely, and you will not have to grieve over a very great failure if you sent one of the worst bunches from the Vines.

Mildew on Vines (Under Gardener and J. H.).—This is induced by a chill, the result of a too low temperature or sharp current of air which affects the fluidity of the sap and arrests its free movement, also by a too close and damp atmosphere, and keeping the ventilators of houses closed too long in the morning, as well of by drought at the roots. The parasite will undoubtedly spread from house to house when the conditions are favourable for the germination of the spores. Sulphuring the pipes is, we suspect, rather preventive than remedial, and in virulent cases seldom effectual. Direct applications are then necessary, and if sulphur fails we can only direct you to the references embodied in a reply to "W. A. J." under the heading of "Tomatoes," and to a preparation of sulphur and lime described on page 377, our issue of the 7th ult.

Beetle Infesting Strawberries (J. W. W.).—It is an insect called *Harpalus aeneus*, one of the family of ground beetles, of predatory habit, known to feed upon small molluscs and insect larvae or grubs, hence till lately regarded as a garden friend rather than a foe. About five years ago, however, observations in various places proved that this beetle and several allied species attacked ripe and unripe Strawberries, doing considerable mischief. Some enterprising beetle, it may be surmised, had experimented on the new food, and finding it good as a change circulated the news amongst its brethren. They defy most insect killers, and the most effectual plan is to trap them, for they come out to feed at night. Slates or boards should be laid about here and there, under these the beetles will hide when daylight appears; or a still better trap is to put down some drain-pipes loosely filled with hay, into which they creep, and can be shaken out into boiling water. The larvae of the beetles eat the roots of the plants.

Weak Asparagus (J. H.).—The weakness of the produce is certainly not the result of non-salting the beds this spring. The character of the stems is governed by the condition of the crowns as formed and matured during the preceding summer and autumn. The stronger the summer's growth the finer the spring heads, and salting in spring does not strengthen the stems for cutting, but it favourably influences the after growth of those uncut in some soils and seasons. Generally, the practice of salting is good, especially in dry soils and localities; but a good dressing of manure is often of greater advantage. Probably most cultivators both dress the beds with manure after the stems are cut down, and apply salt in the spring. If the salting did nothing more than keep down weeds it would do material good, as these appropriate the virtues from the soil that would otherwise be retained in it for the Asparagus. Cutting too closely and too late is a common cause of weak Asparagus, and several applications of liquid manure to the beds in summer are of greater benefit than the majority of persons appear to appreciate. Some Asparagus beds are much overcrowded, and the produce then is bound to be weak.

Fungus on Tomatoes (W. A. J.).—The fungus has been kept so much in check as to do little injury, if not entirely destroyed, with one or other of the remedies that have been recently alluded to in the *Journal of Horticulture* (see pp. 407 and 459), also the advertisement of the "Acme" Chemical Company, which is now appearing. The efficacy of these, as of all remedies, depends largely on the action of individuals. If fungi or insects are allowed to become firmly established on plants no one has a right to expect their sudden extirpation and the quick recovery of the lost health of the plants. It is only when prompt measures are taken on the first appearance of plant enemies that these can be effectually subdued, and in the absence of this early action no one can justly condemn a preparation which, if applied sooner, might effect the object intended. We do not suppose that any application to the roots would destroy the fungus on the leaves, nor is there any danger when these are dressed soon enough of the fruit being rendered in the least unsafe for use. We can only advise you to act in accordance with your well-known intelligence in doing what is best under the particular circumstances of the case. You may learn a good deal from a few well-conducted experiments.

Mushrooms Withering (W. H. W.).—When a number of very small Mushrooms spring up round the larger and shrivel after the best

are pulled it is in consequence mainly of the nutriment having been diverted and appropriated by the larger specimens. You may regard it if you like as an example of the principle embodied in the famous dream of old of the "fat eating up the lean kine," or, as otherwise expressed in the Darwinian law of the "survival of the fittest." But when small pea-like Mushrooms appear in quantity they shrivel, whether the large ones are cut or not, also if there are no large ones. This is the result of inherent weakness, caused by the extreme sub-division of the force of the spawn, instead of its concentration on fewer points. The withering is more common at this period of the year than earlier, and a multitude of small Mushrooms indicates poverty of material in the manure or soil, and also sometimes occurs when the spawn is made to "run" near the surface more than it ought by some error in covering the beds. If you think the shrivelling of the small is caused by the pulling of the large, why not try cutting them instead? Many gardeners cut the crops and twist out the stems a day or two afterwards, but the most successful growers of Mushrooms for market do not do so for two or three good reasons mentioned in the work to which you refer.

Warts on Vine Leaves (T. M. J.).—You do not commence ventilation sufficiently early in the morning. It is a mistake to keep the house entirely closed till the thermometer registers 75°. A free circulation of air is essential at all times, avoiding sharp currents. The following is what Mr. William Thomson says on the subject in his admirable work on the Vine, published by Blackwood:—"This is a sort of conglomerate of little green warts that form on the lower surface of the leaf, as if the result of an extravasation of sap through its epidermis or skin. Some writers say this is not a disease. If it is not such, strictly speaking, it is at least organised matter in the wrong place; and I am confident it seriously impedes the important functions of perspiration, digestion, and respiration; so that if not in itself a disease, it leads to functional derangement, which is nearly the same thing. As has been remarked while treating of the effects of sulphur, these green warts are more easily affected by the particles thereof floating in the atmosphere of the vinery than any other portion of the Vine, except the embryo berries. I can undertake to produce or prevent this disease—shall I call it?—at any time betwixt the first expansion of the foliage and the stoning of the fruit. A close, warm atmosphere, saturated with moisture, will produce it; whereas a free circulation of air, moderately charged with moisture, will prevent its appearance. I have seen instances where the leaves were so affected by it that they all cupped themselves up round the edges, the fruit did not swell to much more than half its natural size, and the general progress of the Vine was retarded." Your other question cannot be answered this week.

Renovating Orchids (P. J. C.).—The following is, as nearly as possible, the culture practised with such excellent results by Mr. Osborne at Aymestry Court, but some time must elapse before your plants can be restored to growing condition. Though it is getting rather late for potting, still in some instances it may be done until the end of June with good results. In this case to save the plants potting must be done at once. The first thing to proceed with is to have on hand some good fibrous peat, broken up about the size of large walnuts, and pass it through a coarse sieve to remove the finer particles; some sphagnum moss from which all weeds and rubbish have been removed, a heap of clean crocks, some charcoal, and lastly the pots themselves, which must be thoroughly clean. Three parts fill the pots with crocks (the larger ones at the bottom), then a few lumps of charcoal, on which place a layer of peat. Now for the plants themselves. Turn them out of the pots they are at present occupying, and shake from the roots every scrap of the old compost, removing all decayed roots. Place the plants carefully on the peat, and work peat round the roots, so as to bring the plants a little above the rim of the pot, finishing off with a little sphagnum pushed in between the peat with a label. Previous to plants being placed in position on the stages see that the woodwork, &c., of the house is thoroughly cleaned, then stage the plants and water them through a fine rose. When growth has fairly commenced they will require a liberal supply of water at the roots—in fact, they should never be allowed to become dry. Plenty of water may be thrown about the house and stages, and the plants receive a slight dewing morning and afternoon throughout the summer. Mr. Osborne has during the summer a layer of sweet leaves 6 inches deep spread underneath the stages, which he considers admirable for containing a certain amount of moisture, tending to keep the plants healthy. A little sunshine is very beneficial, but during bright sunshine shading must be resorted to. Various experiments have been tried with manures, but very weak guano water given once a week during the growing season has proved far and above every other yet tried, especially in the growing of *O. vexillarium*. If insects make their appearance careful sponging with clean water will be found the safest plan to follow. The temperatures recommended are—summer 55° night, 55° to 65° day; autumn and winter 45° night, 55° day. Many advocate a lower winter temperature, but 50° is considered a greater aid to successful cultivation than 40°. A few of the *Odontoglossums*, such as *O. vexillarium*, *Roezli*, *grande*, *Harryana*, &c., are the better for an intermediate house. If "P. J. C." follows this system of culture the collection is certain to improve.

Names of Plants.—We only undertake to name species of plants, not varieties that have originated from seed and termed florists' flowers. Flowering specimens are necessary of flowering plants, and Fern fronds should bear spores. Specimens should arrive in a fresh state in firm boxes. Slightly damp moss, soft green grass or leaves form the best packing, dry

wool the worst. Not more than six specimens can be named at once, and the numbers should be visible without untying the ligatures, it being often difficult to separate them when the paper is damp. (J. B.).—1, *Sophranitis grandiflora*; 2, *Oncidium Papilio*; 3, *Vanda teres*. (R. J.).—1, *Asplenium dimorphum*; 2, *Adiantum reniforme*. (T. J. S.).—Next week. (M. M.).—1, *Paeonia officinalis*; 2, *Papaver nudicaule*; 3, *Aquilegia chrysantha*; 4, *Achillea mongolica*. (W. B. H.).—*Abutilon vitifolium*, see *Journal of Horticulture*, page 165, August 23rd, 1888. (D. R. B.).—You probably refer to *Castanea vulgaris*, var. *japonica*; it is distinct from the common Chestnut.

Drone-breeding Queen Bees (*A Devonshire Amateur Bee-keeper*).—There is either a fertile worker or an unfertilised queen in the hive. If the latter it will be easily recognised, and should be destroyed; if the former it will be troublesome, and you had better let the hive alone, as there is not likely to be as many bees now as will make it worth troubling with. But if there are a good number try it in either case with a frame of brood in all stages, and better if a few bees accompany it, as they may destroy the fertile worker and raise a perfect queen. The comb appears to contain drone and not queen cells. The white spots alluded to are particles of wax, often present when a hive is in an abnormal state as yours is. In all probability it lost its queen in 1890, as a queen bred since April would not as yet have begun laying drone eggs, that is if it were a perfect one.

COVENT GARDEN MARKET.—JUNE 10TH.

Business unaltered, with all classes of goods well supplied and prices easier.

FRUIT.

	s.	d.	s.	d.		s.	d.	s.	d.		
Apples, $\frac{1}{2}$ sieve	1	6	to	6	0	Kentish Cobs	40	0	to	50	0
" Nova Scotia and						Lemons, case	15	0		29	0
" Canada, per barrel	15	0		26	0	Oranges, per 100	4	0		9	0
" Tasmanian, case	6	0		14	0	Peaches, per doz. . . .	6	0		15	0
Grapes, New, per lb. . .	2	0		3	6	St. Michael Pines, each..	3	0		8	0
						Strawberries, per lb. . .	1	6		5	0

VEGETABLES.

	s.	d.	s.	d.		s.	d.	s.	d.		
Asparagus, per bundle ..	0	6	to	2	6	Mushrooms, punnet .. .	0	8	to	0	10
Beans, Kidney, per lb. . .	0	9		1	0	Mustard & Cress, punnet	0	2		0	0
Beet, Red, dozen	1	0		0	0	Onions, bushel.	3	0		4	0
Brussels Sprouts, $\frac{1}{2}$ sieve	0	0		0	0	Parsley, dozen bunches	2	0		3	0
Cabbage, dozen	3	0		0	0	Parsnips, dozen	1	0		0	0
Carrots, bunch	0	4		0	0	Potatoes, per cwt.	3	0		4	0
Cauliflowers, dozen. . . .	3	0		6	0	Rhubarb, bundle	0	2		0	3
Celery, bundle	1	0		1	3	Salsafy, bundle	1	0		1	6
Coleworts, doz. bunches	2	0		4	0	Scorzoner, bundle	1	6		0	0
Cucumbers, doz.	1	6		4	0	Seakale, per bkt.	0	0		0	0
Eudive, dozen	1	0		0	0	Shallots, per lb.	0	3		0	0
Herbs, bunch	0	2		0	0	Spinach, bushel	5	0		6	0
Leeks, bunch	0	2		0	0	Tomatoes, per lb.	0	10		1	0
Lettuce, dozen	3	0		3	6	Turnips, bunch	0	0		0	4

AVERAGE WHOLESALE PRICES.

CUT FLOWERS.

Orchid Blooms very good, rather plentiful.

	s.	d.	s.	d.		s.	d.	s.	d.		
Anemone, dozen bunches	2	0	to	4	0	Mimosa (French), per					
Arum Lilies, 12 blooms ..	2	0		6	0	" " " " " " "	1	3	to	1	6
Azalea, doz. sprays	0	6		1	0	Myosotis, dozen bunches	2	0		4	0
Bluebells, dozen bunches	1	0		2	0	Narciss (Various) dozen					
Bouvardias, bunch	0	9		1	0	" " " " " " "	1	0		3	0
Carnations, 12 blooms ..	1	0		2	0	Narciss (double white)					
Eucharis, dozen	3	0		6	0	" " " " " " "	4	0		8	0
Gardenias, per doz.	1	0		3	0	Pansies, dozen bunches ..	1	0		2	0
Iris (Various) doz. bchs.	6	0		12	0	Pelargoniums, 12 bunches	4	0		9	0
Lapageria, 12 blooms .. .	2	0		4	0	" " " " " " "	4	0		6	0
Lilac (English) per bunch.	0	6		1	0	Primula (double) 12 sprays	0	6		1	0
" (French) per bunch	5	0		6	0	Roses (indoor), dozen .. .	0	6		1	6
Lilium longiflorum, 12						" " " " " " "	2	0		4	0
" " " " " " "	3	0		4	0	" " " " " " "	2	0		4	0
Lilium (Various) dozen						" " " " " " "	1	0		3	0
" " " " " " "	1	0		3	0	" " " " " " "	2	0		4	0
Lily of the Valley, dozen						" " " " " " "	0	6		0	9
" " " " " " "	0	6		1	0	Spiraea, per bunch	0	6		1	0
Lily of the Valley, dozen						Tuberose, 12 blooms	0	6		1	0
" " " " " " "	4	0		9	0	Tulips, per dozen	0	3		0	6
Maidenhair Fern, dozen						Violets (dark), per beh. . .	1	0		1	6
" " " " " " "	4	0		9	0	" " " " " " "	0	6		1	0
Marguerites, 12 bunches	2	0		4	0	Wallflower, doz. bunches	1	6		3	0
Mignonette, 12 bunches ..	3	0		6	0						

PLANTS IN POTS.

	s.	d.	s.	d.		s.	d.	s.	d.		
Aralia Sieboldi, dozen .. .	6	0	to	18	0	Geraniums, Ivy, per doz.	4	0	to	6	0
Arbor Vitæ (golden) doz.	6	0		8	0	Hydrangeas, per doz. . . .	9	0		12	0
Arum Lilies, per doz. . . .	9	0		12	0	Lilium longiflorum, per					
Azalea, per plant	1	6		3	0	" " " " " " "	18	0		30	0
Calceolarias, per dozen ..	5	0		9	0	Lobelia, per doz.	4	0		6	0
Cineraria, per doz.	5	0		8	0	Marguerite Daisy, dozen	6	0		12	0
Deutzia, per doz.	6	0		8	0	Mignonette, per dozen .. .	4	0		9	0
Dracæna terminalis, doz.	24	0		42	0	Musk, per doz.	2	0		4	0
" " " " " " "	12	0		24	0	Myrtles, dozen	6	0		12	0
Erica, various, dozen	12	0		24	0	Palms, in var., each.	2	6		21	0
Eucalyptus, var., dozen ..	6	0		18	0	Pelargoniums, per doz. . . .	9	0		18	0
Evergreens, in var., dozen	6	0		24	0	Pelargoniums, scarlet, per					
Fairy Roses, per doz. . . .	6	0		9	0	" " " " " " "	3	0		6	0
Ferns, in variety, dozen. .	4	0		18	0	Saxifraga pyramidalis, per					
Ficus elastica, each. . . .	1	6		7	0	" " " " " " "	12	0		18	0
Foliage plants, var., each	2	0		10	0	Spiraea, per doz.	8	0		12	0
Fuchsia, per doz.	6	0		12	0	Stocks, per dozen	4	0		6	0
Geuista, per doz.	6	0		9	0	Tropeolum, per dozen .. .	3	0		6	0

Bedding plants (in variety) in boxes, from 1s. to 3s.; in pots, per doz., 1s. to 2s.



A GOOD DAIRY COW.

If the recent visit of the Dairy Farmers' Association to the Channel Islands should lead to a more general recognition of the high value of the Guernsey cow it will have a result of more than ordinary importance, for there can be no doubt that the more fashionable Jerseys have won such favour with the public as has caused the higher value of the cows of the sister island to be overlooked. We have had reason to deplore this fact for a long while, and have done what we could to alter it by calling attention to the superiority of Guernseys from time to time. Strange indeed is it that this should so long and so generally have been overlooked. Even Professor Sheldon in his great work on dairy farming accords them nothing more than a cursory notice, and yet in the Guernsey we have not only the highest milking properties, but also the large frame and a thrifty condition which enables them to be fattened quickly when they cease to be valuable for the dairy. It is considered by competent judges that development is still possible in them, and efforts in this direction are quite certain to be richly rewarded by the formation of herds of cows of a much higher degree of excellence than we now have.

Jersey was the first island visited by the Association, yet no information of real importance was obtained, nor were the papers read remarkable for any addition to our information on dairy management; but at Guernsey the paper on the Guernsey cow read by Mr. Theo. De Moulpiéd was of such importance that some part of it must be quoted as admirably calculated to convey a fair impression of the leading characteristics to our readers.

After dwelling upon its history, he said:—"The Guernsey cow is no mean animal. She weighs from 900 to 1200 lbs. She is an unpretentious useful animal, with a form to delight the eye of the practical dairyman, because it means milk. She is of the wedge form, high and broad in the hind quarters, narrowing towards the front, yet she is not thin in the chest like many milch cows, but has a thickness through the heart which indicates constitution. A deep, full brisket, a fair fulness in the crop; her skin is of a rich yellow, and her milk and butter are more highly coloured than those of the Jersey. In size she is nearly a third larger, and apparently also to about the same extent more robust. An unprejudiced person passing judgment on the two breeds from their appearance only would say the Jersey belonged to the lawn and gentleman's park, while the Guernsey's place was in the rank and file of the hardworkers where butter-making meant business. The head, horns, and neck of many are too heavy to look well; the udder and teats are often deficient, particularly the fore udder and front teats. The udder often appears to be cut away in front, which gives the teats a backward slant that is not elegant. When we come across a Shorthorn or a Hereford the first impression on our mind is, What a fine beef animal! When we see a Jersey our first thought is, What a pretty little beast! but when we meet a Guernsey the first and last impression on our mind is, What a splendid milch cow! You see it in the broad golden rim encircling her eyes, in her green and glossy horns and hoofs; you see it in the orange-colour of her skin, sometimes so full of yellow dandruff as to appear as if the animal had been powdered with gold dust; you see it in a skin as soft as velvet, in her long head and neck, deep wedge-shape shoulders, in her long prominent milk-veins; finally, you see it in that large, deep, well-filled silken bag so yellow, and enveloped by a skin so soft, so fine, so thin as almost to appear transparent; and lastly, if you are still incredulous, a look inside

the ear will be sufficient to convince you of the excellence of the animal before you. But add to these points so essential to a dairy cow her benevolent-looking head, with its large dreamy eyes and clear buff nose, and the beautiful coat of red or lemon fawn and white, and you are justified in adding the word beautiful to the quality of good. In appearance she is rich-looking, long-bodied, with a mild and contented expression, always free from nervousness, has a gentle face, quiet temper, and is full of affection."

The following is the scale of points given for milking qualities by the Royal Guernsey Agricultural Society:—

	Points.
Skin deep yellow on end of tail, on udder, teats, and body generally... ..	6
Skin soft and flexible, well covered with soft fine hair, colour of hair red and white	8
Milk veins very prominent	5
Udder full in front, large, but not fleshy	5
Udder full and well up behind... ..	5

A comparative milk test for richness of the four leading breeds shows Guernsey 4.80 per cent. fat; 14.09 solids. Jersey, 4.26 per cent. fat; 13.06 solids. Shorthorns, 3.79 per cent. fat; 12.07 solids. Dutch, 2.97 per cent. fat; 11.08 solids.

After calving the cows are milked three times a day sometimes for months, later on they are only milked twice. Mr. de Moulpied also said, "If the Guernsey cow has often been compared to a bag of bones, her abundant yield of rich milk preventing her laying on fat, there comes a time when, in the fattening stall, she will compare favourably with any other beef breed. After milking herself away to a skeleton, and once becoming dry, she will take on flesh like a bullock, losing the thin neck and chin of the deep milker and underlaying her hide everywhere with a fatty layer."

As an example of Guernsey cows, take the six cows of Mr. Le Provost at L'Etieunerie. They now produce from 45 to 50 lbs. of butter a week. One of the cows gives twenty-two quarts of milk a day. The dry food used consists of 3 lbs. each of bran, ground maize, and crushed Oats three times a day. This is a liberal allowance, but the custom of milking three times a day renders liberal feeding both desirable and profitable. The cows of Mr. Le Provost are said to be the best in the island, and are milked four times a day for five or six months after calving.

WORK ON THE HOME FARM.

June came in warm and showery, and grass is abundant at last. Bare rickyards are just now a strong reminder of the importance of making an ample provision of stack forage for another winter, and the question of hay or silage must now be decided. Ensilage has ease, simplicity, economy, and certainty to recommend it. The grass is off the land immediately after it is mown; there is none of the risk, labour, doubt, and expense of haymaking, and the farm animals are all fond of and thrive upon it. Very confidently do we predict the general substitution of silage for hay for home consumption; yet in this, as in most other things, farmers are slow to change, even when the advantage of it is so obvious, and there will be much more bad hay made and much more money wasted before silage takes its proper place in farming economy. Well, we can only say once more that all that is necessary to make good silage is to mow grass or other green crops, to cart at once, stack on the bare ground, and apply pressure at once and continuously sufficiently to exclude air. Only there must be no faint-heartedness, no making of little trial heaps, but the stacks must be large and substantial.

We have now an ample supply of green fodder. Rye is being mown and cut up with dry food for all horses not turned out upon grass. Field Peas of the early sowings are in bloom, but the haulm is so short that the crop will be a small one. Fields of early Potatoes have been hoed and hand hoed, but growth has been checked by frost. The horse hoes are kept going among all root crops, excellent work being done by our light iron expansion implements with strong V-shaped hoes, which are decidedly best for all general purposes; with these and quick-stepping Suffolk horses a lot of good work is being done just now.

Mowing machines, horse rakes, and all implements and tools required for haymaking or ensilage should be overhauled and got into good working order at once. Lubricating oil, extra connecting rods, and all parts

of mowing machines liable to sudden breakage should be procured, such provision being of the utmost importance when the busy time comes on and every man and horse are wanted at the farm. It is well to be beforehand with all such matters, so as to insure rapid progress as the pressure of work comes on, so that no time is then wasted, and the work goes smoothly and well.

OUR LETTER BOX.

Butter not Keeping Good (Perplexed).—Your dairy appears to be quite clean, and if no foul air enters it from drains or windows it should answer perfectly for butter storage. We gather from your second letter that the butter keeps better now that the cows are out to grass, and we advise you to look closely into the feeding and housing of the cows at other seasons of the year, for there is evidently some fault to be set right. Avoid using Turnips, and let the only roots used for milch cows consist of Carrots in October and two following months, and Mangolds from New Year's Day till turning out time. Care and discrimination are required in the use of these as well as of green maize and cattle Cabbage, for if the cows are allowed to eat to repletion of either roots or green food the butter will be tainted. Avoid linseed cake. See that the drinking water is quite pure. Have cowhouse and cowsheds well whitewashed with lime fresh from the kiln now that the cows are out to grass. See also that the yard drains are in good working order. Never suffer the milking to be done in a dirty shed or near foul litter, and take especial care that milk pails, milker's hands, and cow's udders are all clean at milking time. All utensils should first be rinsed in cold water, and then washed with hot water.

SWINE FEVER IN THE NORTH.—The counties of Cumberland and Westmoreland have enjoyed, thanks to the Chief Constable, a remarkable immunity from swine fever. In counties which are noted for their bacon this is a noteworthy circumstance. Other counties suffered very severely last year. In England alone 12,492 diseased swine were slaughtered, and 8869 others which had been in contact with them, and the nett amount of compensation paid to the owners amounted to nearly £8000. When we find that the neighbouring counties of Northumberland, Durham, and Yorkshire were all afflicted by this contagious disease—in Yorkshire as many as 1600 pigs being slaughtered—and that all the English counties, except Cumberland and Westmoreland, were more or less sufferers from the fever, the farmers of these counties may rejoice that the instructions given by Mr. Dunne to the police as to preventing the introduction into these counties of swine from the infected districts have been carried out with so much efficiency. Results of this kind should not be forgotten. When a question arose recently of giving some reward to the chief officers of police for their extra exertions with respect to contagious diseases among cattle, the Standing Joint Committee refused to recognise any claim of the kind, upon the ground that such work was part of the statutory obligations upon the police. There is some difference of opinion as to the operation of that principle; but even if it be routine duty, rewards for special efficiency are not unknown in the military and the police service, and when next the question comes up for consideration it may be well to bear in mind facts such as these with regard to swine fever. A penny saved is a penny gained in county affairs as well as in personal expenditure, but by keeping swine fever out of Cumberland and Westmoreland the county police have not only saved the pockets of the local ratepayers directly but they have saved a large amount in the form of indirect losses, besides relieving local farmers, salesmen, and retail dealers of a vast amount of trouble and inconvenience.—(From the *Carlisle Journal*, June 5th, 1891.)

METEOROLOGICAL OBSERVATIONS.

CAMDEN SQUARE, LONDON.

Lat. 51° 32' 40" N.; Long. 0° 8' 0" W.; Altitude, 111 feet.

DATE.	9 A.M.					IN THE DAY.				Rain	
	Baromet. at 32° Level.	Hygrometer.		Direction of Wind.	Temp. of Soil at 1 foot.	Shade Temperature.		Radiation Temperature.			
		Dry.	Wet.			Max.	Min.	In sun.	On grass.		
1891.		deg.	deg.	deg.	deg.	deg.	deg.	deg.	deg.	In.	
May and June.	Inches.	deg.	deg.	deg.	deg.	deg.	deg.	deg.	deg.	In.	
Sunday	31	29.921	67.2	54.0	S.E.	50.0	72.0	40.1	110.2	31.3	—
Monday	1	29.907	64.6	53.3	E.	51.3	73.2	48.0	116.0	33.9	0.111
Tuesday	2	29.910	58.1	51.9	N.W.	54.1	67.0	52.2	112.9	52.7	0.143
Wednesday	3	29.882	58.9	57.1	S.	54.7	70.6	55.1	112.2	52.7	0.153
Thursday	4	29.745	57.9	57.2	E.	55.0	68.0	54.7	100.2	52.9	0.021
Friday	5	29.910	60.2	55.9	S.W.	54.8	71.9	54.1	122.0	45.5	—
Saturday	6	29.951	60.1	56.0	E.	55.1	63.1	50.7	116.0	51.1	—
		29.889	61.0	55.8		53.6	70.1	50.0	112.8	46.4	0.314

REMARKS.

31st.—Bright and warm throughout.
 June 1st.—Bright and war day. Thunder storm at 10 P.M.
 2nd.—Cloudy and cool day; rain in evening.
 3rd.—Gloomy, heavy, and damp till 10 A.M., then generally overcast, but occasional sunshine.
 4th.—Gloomy and misty, with frequent rain till 3 P.M.; fine and generally bright after.
 5th.—Bright morning; generally cloudy in afternoon, spots of rain at 3.15 P.M., and occasionally after.
 6th.—Overcast morning; frequently bright in afternoon.
 Temperature near the average, being a considerable rise above that of the two previous weeks.—G. J. SYMONS.



HARDY FLOWER NOTES.

ACCORDING to a Devonshire pixy story, given by Mrs. Bray in her letters to Robert Southey, and quoted at length in Friend's "Flowers and Flower Lore," a beautiful bed of Tulips in an old woman's garden seems to have attracted the admiration of the pixies, and, as night came round, the little creatures were wont to bring their elfin babies to the Tulips, and making use of the flowers as cradles would lull their offspring to sleep. This accomplished the pixies would return to the neighbouring fields and spend the night in dancing round their fairy rings. At the dawn of day they would return to the Tulips, and although still invisible could be heard kissing and caressing their babies. Thus favoured, the Tulips flourished and lasted long in flower, and the old woman is said to have guarded them with such jealous care that she would not allow a flower to be pulled. At her death her successor, who was evidently of an utilitarian turn of mind, destroyed the favoured flowers, and in their place planted a bed of Parsley, which so enraged the pixies that for many years nothing would grow in the garden. The sight of some florist Tulips nodding their heads in the breeze recalled this story to my mind, and did we live in a more credulous age one could only say that the pixies had chosen magnificent couches for their baby elves. What human infant had e'er a cradle like these? Ransack the warehouses for fabrics of the richest colour and design, and nothing can be found which will bear comparison with the beautiful texture and the stripes and markings of these magnificent flowers. And yet our poets have, as a rule, dealt unkindly blows at such noble flowers. Churchill says :—

"The Tulip idly glaring to the view,
Who, tho' no clown, his birth from Holland drew.
When well full-dressed, fears from his place to stir ;
The fop of flowers—the More of a parterre."

And Pope, whose words I dare hardly quote, lest I should incur the displeasure of the fair sex, says :—

"Ladies, like variegated Tulips, show
'Tis to their changes half their charms we owe."

Our later poets have, however, been more appreciative of the noble flower, but at present I must forbear further quotations.

These florists' flowers are so fine that the hardy plantsman finds it somewhat difficult to resist their blandishments. Unless possessed, however, of ample space, and, as a necessary corollary, sufficient assistance in the garden, he must not permit himself to fall a victim to the fascination of florist flowers of any kind lest he should unduly encroach upon the ever-increasing space demanded by his hardy plants. Thus it is that my late Tulips are few in number, but when we come to the species which own Nature as their raiser, one may indulge somewhat in their cultivation.

First among the various species I have grown or seen I must place *Tulipa Greigi*, which is of surpassing beauty. The typical form of this Central Asian species might well be accounted worthy of being chosen—as a kindred congener has been selected—by the Persian youth as the emblem of his love and affection. When a young Persian presents a Tulip to a maiden he signifies that, like the flower, his countenance is as fire and his heart reduced to a coal. Speaking seriously, however, and without the use of hyperbole, I

know of no flower so brilliant as this. The scarlet of the flower is so fine, the petals of such substance, and the rich gloss on the flower so glass-like, that the plant hardly needs the dark stripes or spots on the leaves to aid in its adornment.

I am surprised that this dwarf large-flowered Tulip is not more frequently met with. The species is extremely variable, and several varieties have either been selected or raised from seed. These have been offered at a comparatively high price, and the only one I have grown besides that known as the type is *T. Greigi aurea*, which is of a magnificent yellow, and has in place of the black base of the type slight markings of crimson internally. Blooming at the same time was the curious South European species *T. Celsiana*, which grows about 6 inches high, and has solitary bright yellow flowers, which look somewhat like an immense yellow Crocus. On first opening they are almost horizontal, but are afterwards quite erect. This species is very showy on rockwork. Another curious Tulip at present in flower is *T. carinata violacea*, growing with me about 16 inches in height. It is by no means brilliant, having triangular-shaped flowers with short petals of a purplish-red with a green stripe up the outside of each. Inside the petals are bright red with a greenish yellow base. I have been unable to discover the native habitat of this species, which does not seem to be named in the "Cottage Gardeners' Dictionary," or any other book of reference in my possession.

Very fine, too, is the comparatively new *T. Billietiana*, which is about 18 inches high, with pretty, wavy foliage, more undulated than that of any other species I am acquainted with. The flowers on opening are bright sulphur outside, brighter yellow inside, with a faint zone of orange scarcely half-way up the petals. This becomes gradually deeper, and the outer petals become tinged with orange. Another very showy kind is *T. maculata major*, which is deep crimson inside, with fine black blotches and a yellow zone. The outer petals have more of a pink hue. This grows with me about 20 inches in height.

Several others might be spoken of, such as the dwarf but showy *T. persica*, the brilliant *T. oculus solis*, the splendid *T. Gesneriana*, the parent of the florists' varieties, the dwarf *T. linifolia*, and others : but enough has, I think, been said to draw some attention to these interesting flowers, so much neglected of late years, and which offer a wide field for the hardy plant lover.

But the Tulips must not engross all our attention, and the natural order Ranunculaceæ furnishes us with flowers equal in brilliancy, and perhaps superior in elegance to the Tulips. Among the Anemones will be found flowers of surpassing beauty and simplicity of culture, and of these there are possibly none equal to the varieties of *A. coronaria*. There are now many good strains in the market, but I have found none surpass that known as the St. Brigid strain, from which will be raised flowers of endless variety of colour and form, some of the semi-doubles being particularly fine. It seems doubtful to what flower Shakespeare referred in "Venus and Adonis" when he says :—

"By this, the boy that by her side lay kill'd
Was melted like a vapour from her sight,
And in his blood that on the ground lay spill'd
A purple flower sprung up, chequer'd with white,
Resembling well his pale cheeks, and the blood
Which in round drops upon their whiteness stood."

In any case the memory of the beautiful boy could not be more worthily enshrined than in the Anemone, and we are content, even at the sacrifice of some conflicting opinions, to accept it as the flower which sprung from the blood of Adonis, and the white Wood Anemone as that which was produced by the tears of Venus.

The Crown Anemones do not appear to have succeeded so well this season in this locality. My plants have, however,

although late, done very well. *A. fulgens* has not been so good, and its double form has not flowered at all. The white *A. stellata alba* has proved a great disappointment to me. It has been an instance of a much-lauded plant proving of but little value. I am perhaps singular in my opinion, but the varieties of *A. stellata* are not much appreciated in my garden. Regarding *A. coronaria*, I have, after some considerable experience, found that the most satisfactory results will be obtained by raising plants from seed occasionally and discarding the old tubers.

There are now so many plants in flower that my further notes must be brief, and far from exhaustive of all worthy of note. On the rockery the beautiful *Onosma taurica*, the "Golden Drop," is well in flower, its singular and beautiful yellow blooms having an added charm in the perfume, which has a distinct approach to that of bitter almonds. This is by no means a difficult plant to manage here. I have it in three positions, and in none of these did it receive any covering or protection. Had we had a wet February I would have placed a piece of glass over the plants to preserve the hirsute foliage from the rain. *Hypericum reptans* has not yet come into flower, but has pulled through the winter without any protection: It has been badly cut up in some gardens. I grow it over a patch of a Mossy Saxifrage, and this seems to suit it well. Some of the *Helianthemums* are now in flower, and are as welcome as ever. It is a pity the pretty "crinkled" flowers are so fugitive, and while a sunny position should be chosen it should be as much sheltered from the wind as possible, or a few hours will be the limit of the bloom for the day.

A bed of some forty plants of Rev. A. Rawson's *Columbines* are finely in flower. These *Aquilegias* were raised from seed and planted with the intention of selecting the best forms and discarding the inferior and the duplicates. All are, however, so beautiful that I cannot think to reduce their numbers. The bed, as it is, is much admired, and will most likely be allowed to remain.

The beautiful little *Andromeda (Cassiope) tetragona* is almost out of flower. This exquisite little shrub requires a shady position, and a peaty or sandy moist soil. Thus treated it will display its white Lily of the Valley-like little flowers, and more than gratify all who observe it. The blue *Camassia esculenta* is just coming into flower, and several other bulbous plants are about to follow suit. The white flowered *Allium triquetrum* with pretty umbels of drooping flowers, is in full bloom; while a congener named *A. hierosolymæ* is still in flower. This seems a rare and little known species. The flowers are small, white, and produced on a flat erect umbel, while the leaves are profusely covered with hairy-looking filaments. The *Trolliuses* or Globe-flowers, are well in flower, and I think upon the whole there is none finer than the native *T. europæus*, the "Lucken Gowan" or "Witches' Gowan" of the Scots. Thus, the first week of June yields its tribute to Flora with ungrudging hand.—S. ARNOTT.

THE GARDENERS' ORPHAN FUND.

PROPOSED FLORAL FÊTE AND ROSE FAIR AT THE CRYSTAL PALACE, WEDNESDAY, JULY 15TH, 1891.

WHEN the Gardeners' Orphan Fund was established in 1887 it was not apprehended that such a charity was so urgently needed as experience has proved to be the case. The necessities of the needy—the widows of gardeners struggling with adversity in seeking maintenance for young families, and the humble guardians of orphans who have lost both parents—have come as a surprise, and urged the Committee to make special efforts to alleviate existing distress. They thankfully acknowledge the generous response of many friends and helpers in various parts of the country, and rejoice in having been thereby able to provide means of support for thirty-nine children at an annual outlay of upwards of FIVE HUNDRED POUNDS; but in view of present obligations, and further well founded claims for help, the Committee are impelled to appeal once again to a sympathising and large-hearted public who engage

or delight in gardening, convinced that the appeal will not be in vain.

The object now sought is hearty co-operation over the widest possible field in a great united endeavour to make the above project a success. The necessity for this effort has mainly arisen through the loss sustained by the discontinuance of the Floral Fête in Covent Garden Market, which was equal to an annual income of £200. The great popularity of this Fête led to such an inrush of persons on the opening of the Market on the following morning, as to so impede the transaction of business that the friends who provided the unparalleled displays became material sufferers through their generosity.

Amongst other means resolved on under the circumstances to strengthen the Fund is the holding of a Floral Fête and Rose Fair at the great national place of public resort—the famous Palace of Sydenham. This project is in its nature both speculative and costly; but the Committee desire to make it clearly understood that under no circumstances can the Gardeners' Orphan Fund itself lose one penny. A private guarantee fund has been provided to make good any possible loss that may occur through unforeseen contingencies, such as (1) inclement weather, and (2) a lack of public sympathy. The weather is beyond control, but there is not one other place in the kingdom where thousands of visitors could to anything like the same extent find enjoyment, even on a rainy day, as at the Crystal Palace. In respect to the other possible cause of failure, the Committee are convinced that nurserymen, florists, gardeners, and friends of the fatherless children will not, so far as in them lies, permit it to occur.

The arrangements with the Crystal Palace authorities are made on an equitable basis, and the greater the number of admissions to the Palace on the Fête day the greater will be the benefit accruing, and especially if tickets are purchased, at the ordinary rate, through the officials of the Fund. The Committee would, therefore, first ask all who are desirous of attending the great Rose Fair to not only make an effort to do so, but also make the project widely known in the districts in which they reside, in order that a great multitude will assemble, and thus give their countenance and support towards a truly noble object—helping the helpless children of gardeners who now rest in the earth that they endeavoured to make fruitful and beautiful by their labour and skill.

It is hoped the members of those mutual improvement and horticultural societies who have not yet made arrangements for their annual "outing" will give the Gardeners' Orphan Fund favourable consideration, and if possible let the Crystal Palace be their rendezvous on the 15th of July. They will find much to interest, instruct, and amuse, and will have the satisfaction of feeling that they have shared in an object than which none is more worthy in the horticultural world.

Many gardeners, nurserymen, and florists who are unable to attend on the occasion in question can give substantial help to the project and the Fund. It is to be observed that the great source of attraction is to be not only a floral fête, but a Rose fair. This implies, and is in fact intended to be, a sale of flowers, notably Roses, to the visitors. Fruit also will be sold for the benefit of the Fund. Already the Committee have received generous offers of both, and hope to receive many more. The desire is to have sufficient Roses and other flowers promised to enable such a display being made as will attract a large attendance of London visitors, who invariably attend Rose shows freely, and clamour for the flowers that are not on sale. The "fair" then, where they can buy after a certain hour, it is expected will prove distinctly popular, and draw many persons to the Palace who would not otherwise attend.

The direct railway connection with the Crystal Palace from all parts of the kingdom for the conveyance of substantial packages, and the parcels post for smaller quantities of produce, such as nosegays, coat and dress bouquets, &c., afford adequate means for transmitting whatever the generously disposed who have the power will be willing to place at the disposal of the Committee for the charitable object, with which all who grow and love flowers must desire to help.

Apart from cut flowers it is hoped it will be convenient for several nurserymen to send representative groups or collections of plants for sale or otherwise, as they may determine, and thus contribute materially to the general display. This it is expected will be both extensive and unique, and that by the cordial co-operation of many friends it is thought much good may be done to the charity at a minimum amount of inconvenience to donors and helpers.

The Palace authorities undertake to provide the usual attractions, make the event widely known, and to give all available assistance and facilities towards making the enterprise a great success.

Gardeners and others, especially perhaps young gardeners and

seedsmen, will be interested in the provision that will be made for those of them who enjoy physical exercise, by the few sharing in and the many looking on, at a cricket match that will be arranged between the gardeners and seedsmen of the United Kingdom—the first contest of the kind that has been seen. It is desired that the players will be the best that can be chosen from different parts of the country, so that as far as possible the event will be of a national character. A member of the Committee, Mr. C. H. Sharman, has kindly undertaken to marshal the seedsmen, and Mr. E. Molyneux, of Chrysanthemum fame, the gardeners, both being experts in the national exercise.

All persons who desire to share in making the Floral Fête and Rose Fair a great success, for the benefit of this charitable object, are invited to send offers of what they can contribute in the form of produce, or assistance in any other way, to Mr. A. F. Barron, Royal Horticultural Society's Gardens, Chiswick, the Honorary Secretary of the Gardeners' Orphan Fund, and every well-wisher of this Fund is desired to take such steps as he deems best for adding to the attendance at the Crystal Palace on the 15th July.

OWING to the ready publication in your columns of all matters connected with charitable institutions, I venture to ask your kind insertion of this note on behalf of the Gardeners' Orphan Fund in connection with the fête to be held at the Crystal Palace July 15th. As already announced in the horticultural press, one of the items in the programme is a cricket match—The Seedsmen v. the Gardeners of the United Kingdom. Having the honour to be chosen captain of the latter team, and with a view to create a wide-spread interest in the project, thereby adding to the success of the fête, in the hope that it will assist in swelling the funds for so good an object, I should be glad if players desirous of taking part in the match would send in their nominations as early as possible respectively to Mr. C. H. Sharman, 69, Houston Road, Forest Hill, London, captain of the seedsmen's team, and to myself for the gardeners' team, so that we can make the necessary arrangements as to the number of players on each side. We hope to receive nominations from as wide an area as possible, which would add considerably to the interest in the game and benefit the fund.—E. MOLYNEUX, *Swanmore Park Gardens, Bishop's Waltham, Hants.*

GRAPES THAT WILL KEEP.

THOSE who are anxious to keep Grapes well through the winter, or if need be till late in May, must have this end in view from the time the Vines are started, and in fact in advance of that period. I do not insinuate a special line of treatment is absolutely necessary, but there are a few cultural details that have to be observed, or the chances are there will be more failures than successes. Much naturally depends upon the selection of varieties, some keeping much better than others, though all in the house may be classed as late Grapes. Lady Downe's is undoubtedly the best keeper of all, no difficulty being experienced in keeping well prepared bunches till the end of May, and this variety ought, therefore, to be most extensively grown, especially seeing that it is of superior quality to all of the very late varieties other than Mrs. Pince's Black Muscat. The latter, being a somewhat shy setter and difficult to colour, is not nearly so much grown as it was a few years ago, but it ought not to be needlessly cut out. It will keep fairly plump till the end of April. Alicante, though a very serviceable late variety, seldom keeps good after March, Gros Colman being over at much the same time. No other black varieties that are generally cultivated can be rightly termed keeping Grapes, but both Mrs. Pearson and Muscat of Alexandria frequently keep plump and good till the end of March, and Golden Queen also hangs well, some of ours being very crackling and agreeable in flavour last February. Gros Guillaume is more of a midwinter than a late variety; West's St. Peter's also being at its best in January.

If any or all of the foregoing are to be kept as late as possible, or even fresh and good till the end of January, they must be early and thoroughly ripened, it being a great mistake to delay starting the Vines in the spring under the impression that late ripening would be followed by late keeping. Colouring ought to commence in August, and still earlier in the case of Muscats, and the ripening be nearly or quite completed in September. It is not possible to effect this without the assistance of a considerable amount of fire heat, and this should be applied in the earlier stages of growth, during the ripening period, and during what should be the hottest part of the year whenever the weather is overcast or cold. If the Vines could be rested sufficiently the first week in February is none too early to start, Muscats especially, but the majority of

cultivators close their late vineries about the first week in March, and that date suits us well. Supposing inside borders—and these are the best for late Grapes—are given a good soaking of farmyard liquid manure, or failing this a dressing of special Vine manure or guano at the rate of 2 lbs. to the square rod, and duly washed in with soft water, and the house or houses kept close and warm and a moist atmosphere maintained, the break will be strong and progress rapid. Kept growing at a good rate, without, however, resorting to hard forcing, most of the varieties would usually be in flower from the middle to the end of May, and in order to effect a good set the temperatures might well be increased to 65° to 70° by night, the houses being ventilated early on bright mornings, and the heat kept up to 75° to 80° with air, closing and damping down early enough to run up the figures to 90° or thereabouts. A smart tip of the rods, this being done towards midday, helps to distribute the pollen, and in the case of shy setters the palm of the hand should also be gently drawn over the bunches. Giving the Vines a good room favours a strong growth of bunch, stout footstalks and flowers being followed by the finest berries, and supposing the rods are disposed 4 feet apart and the laterals stopped at the second leaf beyond the reserved bunch, the requisite light to insure this robustness will be admitted. Somewhat high temperatures should also be maintained after the flowering period, the bunches of some varieties failing to run out sufficiently if much air is admitted and comparatively low temperatures are kept, this treatment also serving to hasten the ripening period.

Late keeping being the primary object, it is not advisable to select the largest bunches that show, as these do not keep nearly so well as do those that may be considered of medium and small sizes. It may be very much "against the grain," but there ought to be no hesitation about cutting away either extra large bunches or the shoulders of those somewhat smaller in size, and as this admits of a greater number of bunches being grown on each rod, there is no loss of weight, while the prospect of a better "finish" is improved. Nor must the thinning out of the berries be done in a half-hearted manner. Very many of the failures with late Grapes are due to faulty thinning, not nearly enough berries being taken out before the final swelling commences. Light thinning may be excusable in the case of Lady Downe's, where this variety scalds badly, but as a rule this unfortunate occurrence may be prevented by putting on a little top air the last thing every night, more being admitted before the sun has a chance to suddenly and unduly raise the temperature of the house in the morning. In any case the bunches of Lady Downe's and all the rest must be freely if gradually thinned out, according to the size of their berries respectively. If when nearly or quite ripe they press against each other it is then too late to proceed with the thinning, and later on one bursted or decaying berry may effect the ruin of the bunch. Especially should those berries with an inward or crossing tendency be removed, and not a particle of rubbish in the shape of dead flowers or portions of the same or stoneless berries be left about the stems, or otherwise those responsible may have good cause to rue this oversight. Somewhat thin bunches are not much to look at, but it is these which keep best.

During the time the Grapes are colouring plenty of front and top air should be admitted, but this ought to be dry and warm, and not cold and damp; hence the necessity for keeping the hot-water pipes moderately warm in all but the most summer-like weather. A little front and top air should also be left on during the nights, this being especially necessary to insure perfect colouring of the black varieties. A moderately dry atmosphere is to be preferred to a moist one, the latter being prejudicial to the bloom on the berries. If these conditions are observed and over-cropping avoided the ripening will be perfect, the chemical changes in the berry brought about by the well sustained heat leaving in them a minimum of water and a maximum amount of solid sugary matter. It will be found that the quality and keeping properties go hand-in-hand, Grapes ripened after September being of indifferent flavour, as well as keeping badly.

Having prepared the Grapes for keeping will not alone insure them against losses, and according to my experience there must be no neglect subsequently, it being possible to mar their skins, and therefore their keeping properties, in a few hours. It is good policy to keep the bulk of the bunches on the Vines till late in the year, and during that time they must not be subjected to either very low or high temperatures, the former being guarded against as well as a damp atmosphere by the maintenance of a little heat in the hot-water pipes, air being left on both night and day being a preventive measure against a sudden and dangerous rise in the temperature. This part of my subject might well be returned to at a more seasonable date, and I will, therefore, conclude with the assertion that an unheated disused bedroom for bottling Grapes cannot be surpassed for the purpose.—W. IGGULDEN.

FLOWERING OF FRUIT TREES.

IN a recent issue Mr. J. Wright gave some very practical notes on the above, which would be carefully perused by all interested in fruit culture. We have here made notes on the flowering of fruit trees, extending over some years, and the conclusion we have arrived at is that the winter has little or no effect on that period. As will be seen by the following figures, after one of the hardest of winters the flowering time of Apples was up to date in the majority of cases this year, late flowering Apples being a little later perhaps owing to the arctic weather which commenced on May the 17th. However, there are a few things difficult to account for, Damsons being three weeks later than last year, and Plums two days earlier, and Pears later generally. In 1890 Peaches were in full bloom March 18th, this year it was April 6th before they arrived at the same stage. Morello Cherries were ten days later, Black Eagle eleven days behind.

PEARS	1890	1890	1891	1891
	APRIL	MAY	APRIL	MAY
Jargonelle	6	...	22	...
Baronne de Mello	6	...	22	...
Soldat d'Esperen	9	...	26	...
Marie Guise... ..	9	...	17	...
Duchesse d'Angoulême	9	...	17	...
Beurré Clairgeau	10	...	27	...
Flemish Beauty	15	...	20	...
Beurré Diel	16	5
Marie Louise	20	1
Goubault	20	11

APPLES	1887	1888	1889	1890	1891
	MAY	MAY	MAY	MAY	MAY
Alfriston	17	9	12	12	8
Betty Geeson	14	9
Bess Pool	18	25	24	26	31
Blenheim Orange	22	19	17	23	24
Bramley's Seedling	15	11
Codlin, Keswick	5	8	4	6	11
Cox's Orange Pippin	15	19	16	11	12
Duchess of Oldenburgh	1	3	1	1	9
Ecklinville Seedling	13	12	7	10	13
Frogmore Prolific	17	14
Golden Noble	17	19	15	21	16
Hawthornden, New	21	16	19	22	13
Irish Peach	2	5
Lady Henniker	24	21	26	25	13
Lane's Prince Albert	17	13
Lord Suffield	8	14	9	10	13
Lord Grosvenor	1	4	2	9	12
American Mother	22	22	19	23	14
Maltster	9	8	10	9	9
Peasgood's Nonesuch	20	17	26	21	18
Worcester Pearmain	15	15	19	16	14
Cellini Pippin	15	18	14	21	17
King of the Pippins	15	17	19	15	18
Ribston Pippin	16	12	17	15	12
Worms'ey Pippin	12	12	19	14	13
Pott's Seedling	16	19	21	17	17
Queen Caroline	22	25	20	26	18
Stirling Castle	9	11	8	10	11
Tower of Glam's	13	13	12	13	7
Warner's King	11	7	10	10	11
Dumelow's Seedling	18	18	21	19	18
Yorkshire Beauty...	26	16

—S. T. WRIGHT, *Glewston Court Gardens, Hereford.*

THE CARNATION.

[A Paper by Mr. JAMES DOUGLAS, read at the meeting of the Hawick Horticultural Mutual Improvement Association, May 29th.]

(Concluded from page 466.)

WHEN the weather becomes cold after the middle of September the plants are best under glass again. They begin to produce their flowers late in September or early in October, and will do so all through the winter and early spring months in a mild hothouse temperature, say a minimum of from 50° to 55°, with a rather dry atmosphere. The potting soil required for Carnations and Picotees should be rather rich, and ought to be

composed of yellow loam about four parts, one part decayed stable manure, one part leaf mould, and as much coarse white sand as may be required to keep the compost open. It is best to mix this up about two months or so before it is required for use. A little mortar rubbish mixed with the soil seems to be of much value in keeping the compost open. We ought not to forget that we bring a plant, if not indigenous, at least acclimatised, on old walls and ruins, and plant it in rich garden soil. If the plants lose vigour or decline so much as to be worthless, may it not be our system of overfeeding them? As an exhibition plant the Carnation and Picotee has long been a favourite. Special societies in different districts of the country take them under their special care. The main object of these exhibitions for at least half a century has been to show the excellence of individual blooms, prizes being offered for certain numbers of flowers, which are carefully arranged on stands or trays, the flowers being neatly displayed by the careful hand of the florist upon clean white cards, Carnations on one stand, and Picotees upon the other. In the schedules of the various sections of the National Society all the different types of the Carnation and Picotee find a place; and the object of the Society being to encourage excellence of culture, other ways of exhibiting the flowers have been neglected, such as the production of the best bouquet of Carnations, their arrangement in vases, &c., as they are cut from the plants.

A short time ago the Committee of the National Carnation and Picotee Society, anxious to supply a long-felt want, invited the leading growers of the Carnation and Picotee to send in lists of the best varieties in their respective classes, which were tabulated and appeared in the fourteenth annual report of the Society. The lists have been arranged in order of merit, the variety obtaining the greater number of votes being placed highest.

The following cultivators have supplied the lists:—Samuel Barlow, Esq., J.P., Rev. H. H. D'Ombrain, Messrs. Jas. Douglas, Richard Dean, Blick, T. E. Henwood, F. Hooper, Thos. Hay, Keen, Headland, Jos. Lakin, Martin Rowan, Ben. Simonite, C. Turner and R. Sydenham.

CARNATIONS.

<i>Scarlet Bizarres.</i>		<i>Scarlet Flakes.</i>	
	Votes.		Votes.
Robert Lord	15	Sportsman	13
Admiral Curzon	14	Matador	12
Robert Houlgrave	12	H. Cannell	12
George	8	Alisemond	10
Fred	7	John Bali	8
Arthur Medhurst	7	Clipper... ..	4
Mars	5	John Whitham	3
Edward Adams	4	Richard Dean	3
Joseph Crossland	4	Figaro	2
<i>Crimson Bizarres.</i>		<i>Rose Flakes.</i>	
	Votes.		Votes.
Rifleman	14	Thalia	13
Master Fred	12	Sybil	13
J. D. Hextall	11	Rob Roy	9
Harrison Weir	11	Jessica	8
Jos. Lakin	6	John Keet	7
John Simonite	4	Crista Galli	6
E. S. Dodwell	4	Jas. Merryweather	4
Wm. Bacon	3	Mrs. E. Wemyss... ..	4
Duc d'Aumale	3	Lovely Mary	4
<i>Pink and Purple Bizarres.</i>		<i>Self Coloured.</i>	
	Votes.		Votes.
Sarah Payne	15	Germania	9
William Skirving	14	Purple Emperor... ..	6
Squire Llewelyn	11	Emma Lakin	6
Mrs. Barlow... ..	6	Governor	6
John Harrison	6	Mrs. Reynolds Hole	6
Purity	4	Rose Celestial	5
Sir G. Wolseley	4	Annie Lakin	5
Mrs. Gorton... ..	4	Mary Morris	4
Unexpected... ..	4	Will Trelfall	4
		Joe Willet	3
		Scarlet Gem	3
<i>Purple Flakes.</i>		<i>Purple Flakes.</i>	
	Votes.		Votes.
James Douglas	14	Old Clove	2
Mayor of Nottingham	10	Florence	2
George Melville	8	Gladys	2
Squire Whitbourn	7	Black Knight	2
Florence Nightingale... ..	7	Malvoli... ..	2
Gordon Lewis	5	La Brilliance	2
Dr. Foster	4	Celia	2
Sporting Lass	4	Raby Castle... ..	2
Oscar Wilford	3	Duchess of Connaught	2
		Mrs. Muir	2
		Coroner... ..	2

PICOTEES.

Heavy Red Edged.

	Votes.
Dr. Epps	13
John Smith	12
Brunette	11
J. B. Bryant	11
Princess of Wales	6
Mrs. Dodwell	6
Morna	5
Wm. Summers	4
Dr. Abererombie... ..	3

Light Red Edged.

	Votes.
Mrs. Gorton... ..	15
Violet Douglas	15
Thos. Williams	15
Mrs. Bower	10
Emily	5
Elsie Grace	4
Thos. Jivens... ..	4
Dr. Horner	4
Grösteen	3

Heavy Purples.

	Votes.
Mrs. Chancellor	14
Muriel	12
Zerlina	12
Amy Robsart	6
Pieco	5
Alliance	4
Hilda	3
Princess Dagmar	3
Mrs. Summers	2

Light Purple.

	Votes.
Clara Penson	14
Ann Lord	13
Mary	10
Baroness Burdett Coutts	9
Nymph	7
Mrs. Nicholay	5
Juliette... ..	4

Light Purple (continued).

	Votes.
Jessie	4
Pride of Leyton	3

Heavy Rose.

	Votes.
Mrs. Payne	14
Mrs. Sharp	12
Edith D'Ombraim	9
Royal Visit	8
Constance Heron	8
Lady Louisa	8
Miss Horner	4
Fanny Helen	4
Mrs. Lord	3

Light Rose or Scarlet.

	Votes.
Favourite	15
Nellie	11
Ethel	9
Miss Wood	6
Mrs. Ricardo	6
Lady Carrington... ..	4
Orlando	4
Evelyn	4
Estelle	3

Yellow Ground.

	Votes.
Annie Douglas	13
Agnes Chambers... ..	12
Colonial Beauty	8
Almira	8
Terra Cotta	8
Dorothy	7
Prince of Orange	6
Janira	3
Princess Beatrice	3
Alfred Grey... ..	2
Duchess of Teek... ..	2
Tournament... ..	2
Maud Ellis	2
Ne Plus Ultra	2

in preventing Muscat Grapes from developing their sterling good qualities, and also in bringing once vigorous Vines into a debilitated condition. I remember paying a visit to one of the best Grape growers of the day, whose grand Muscats are the admiration of all who see them. I was somewhat surprised at his primitive method of training, and of the length of the laterals beyond the bunch, but he had wonderful examples of Muscats.—H. D.

ST. JOHN'S FIG.

SMALL trees of this Fig were exhibited both last year and this at the Temple Show of the Royal Horticultural Society, and attracted considerable attention. Some of the trees were on low and others on taller stems, the whole bearing excellent crops, as indicated by the engraving, which is from a photograph taken by Mr. James H. Veitch. The variety, we are informed, is of Portuguese origin, and the great advantage it possesses is the power not only of carrying its early crop,

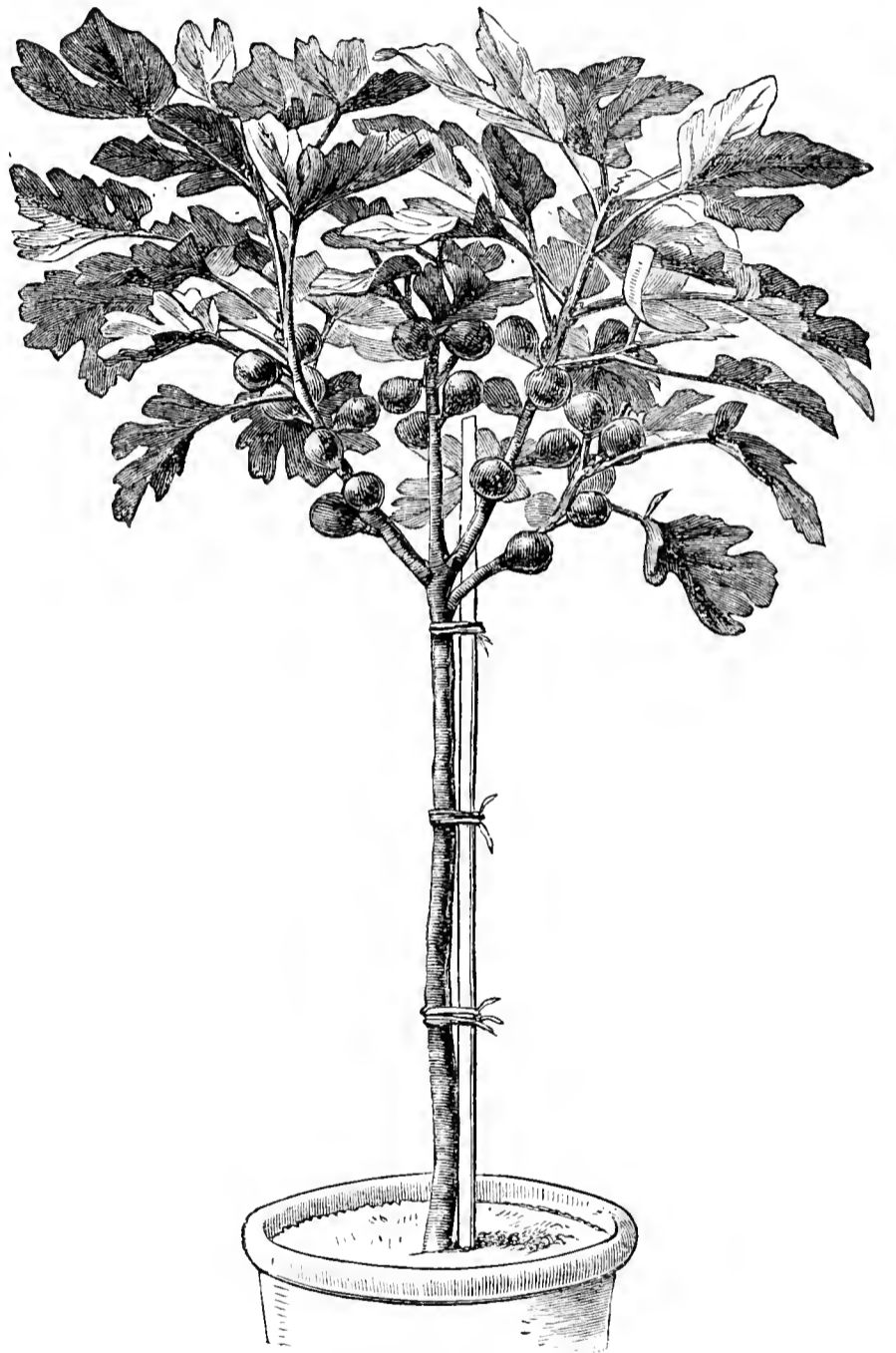

FIG. 92 — ST. JOHN'S FIG.

LATERAL GROWTHS ON MUSCATS.

So many operations connected with gardening are in different places conducted on totally different lines, that it is no wonder beginners in the various branches are sorely puzzled at times to convince themselves of the best course to pursue. This statement seems to me to apply with particular force to the treatment of Vines during the growing season in the way of stopping, tying, and managing the lateral growths, and where one has to deal with a large number of varieties close observation will soon show them that widely different management is required in the manipulation of the shoots of each variety. Not only of each variety, but of each Vine, in order to check the stronger and encourage the weaker. I believe there is no variety of Grape in cultivation which receives greater benefit from a free lateral growth during the time the Grapes are swelling and stoning than the Muscat. As a rule these when in good condition grow pretty freely till the Grapes are set and commence swelling, and it is from this stage onwards that in my opinion they are, speaking generally, stopped too closely. Very often this becomes necessary to a certain extent on account of the Vines being planted too closely, as few people like to allow them the necessary space—viz., from 5 to 6 feet from rod to rod. When large well finished exhibition bunches are wanted this distance is quite necessary to allow lateral growth to be constantly going on till colouring is well advanced, when it should be gradually stopped, and in some cases a good deal of it removed altogether.

I do not advocate the practice of letting laterals run according to their will for a time and then suddenly subjecting them to a severe thinning, as in some cases the result would then be wholesale shanking. The aim should be to always have a little growth going on. This can be accomplished without shading the primary leaves, by keeping all the laterals with the exception of the one at the extremity of each shoot, stopped at the usual one joint, and training or rather allowing it to ramble between the laterals of the next Vine, and in some cases drooping down from the trellis; or where the Vines are trained a good distance from the glass allowing them to grow upwards towards it. Too much attention to strictly methodical training and trim appearance have much to answer for

but of ripening that crop before the varieties at present generally in use are ready for the table, besides being, as may be seen, remarkably productive. In colour the fruit is green, rich in flavour, and very juicy. The St. John's Fig has already given to those gardeners who have obtained it general satisfaction.

PARISIAN MARKET GARDENING—RADISHES.

VISITORS to our city seldom fail to relish the succulent, crisp, delicately flavoured Radishes full of fresh slightly pungent moisture, which, during the greatest part of the year, are served up in our good restaurants. But it is not necessary to go to Bignon, Marguery, Café Anglais, Maire, and other such "good tables" of the boulevards; one may also admire in the streets the attractive bunches, with the roots all of one size and shape, sold by the hawkers or in the shops, and more than once have I observed a visitor buy a bunch to ascertain whether the quality is

equal to the appearance of the roots, and I daresay this was generally found to be the case.

There does not seem to be a vegetable more generally grown around Paris, and it is a well-known fact that our market gardeners indeed excel in its culture. It may, therefore, interest some of your readers to know which are the principal conditions required to produce such exquisite Radishes instead of the coarse, stringy, hollow, ill-flavoured roots which are still too often met with not a great distance from Paris.

The Radish culture, as practised by our market growers, comprises several successive "seasons," to use their own expression. For the first crop they make up, in the course of December, a hotbed as described previously, put on the top of this 5 to 6 inches of compost, and then the frames with the lights on to induce it to heat quickly. During a spell of frosty weather it may be necessary to cover with straw mats. As soon as the heat is in suitable condition the soil is made level, the seed sown rather thinly, and in such a manner that the plants will not stand less than 1 inch apart, being then covered with half an inch of mould, and the lights placed on it at once. In a very few days the seedlings will appear, and it is then necessary to admit abundance of air on every favourable occasion, using, of course, every available means to exclude frost. Under that treatment the Radishes may be gathered in thirty-five to forty days, according to the variety sown.

Frame culture towards the end of December is, however, not without difficulties, particularly in the beginning. To avoid the Radishes becoming drawn and spindly air must be admitted to the frame whenever possible. Radishes when grown in frames always succeed better alone than associated with other early crops. However, it is not always within the means of gardeners to devote a whole hotbed to their culture, in which case it would be advisable to grow them with plants like them that require much ventilation, such as the "fine early white" spring Lettuces and Carrots. For mixed culture the Turnip, and Olive-shaped Scarlet, Deep Scarlet, and white sorts being more hardy than the Olive-shaped White-tipped and other forcing Radishes, are to be preferred. The majority of our growers, owing to the difficulties attending Radish forcing in December, prefer to start towards January 15th, when lights are not required. The operation in that case is as follows:—

A hotbed, 12 to 15 inches deep and 4 feet wide, is formed as if it were to receive frames with lights; about 6 inches of good compost or soil is placed upon it, and the bed covered with straw mats, which are left until it is well warmed through—viz., three or four days. After that time the mats are removed, the soil gently pressed down, and the surface pulverised to render it level. The seed is then sown at the rate of about one third of an ounce per square metre (9 square feet), taking great care to distribute it as uniformly as possible, pressed down firmly with a piece of wood to apply it exactly upon the soil; the bed is then surfaced with a little over 1 inch of good soil, watered if necessary, and the whole covered with straw mats until the seedlings are well up. Then the mats are removed during the day, weather permitting, and replaced every evening. Six weeks to two months later—that is, in the course of March—the whole crop, or a portion of it, is pulled at a time. The ground when cleared is slightly tilled, surfaced with about 4 inches of new soil, hoed, pressed down, and sown again. The straw mats may this time be dispensed with, but the applications of water should be more frequent to prevent the soil becoming dry. This second crop is fit for sale in about one month from the time of sowing. The same hotbed may thus produce from January to June as many as four successive crops if it is surfaced each time with some new compost or mould. It goes without saying that the supplies of water must be more liberal in proportion as the season advances.

To produce Radishes of the best quality it is essential that the plants be grown steadily without a check. From the time of sowing until the roots are pulled they are never allowed to suffer from want of water or nourishment. This is indispensable, particularly with the earlier, quicker growing varieties, such as Turnip Extra Early Scarlet White-tipped Forcing, Scarlet Forcing, and Deep Scarlet Forcing; also the Olive-shaped Scarlet White-tipped (French Breakfast), which are the sorts usually grown by the French market gardeners. It is also necessary to prevent the seed being sown too thickly or too thinly, in order to induce a uniform growth, and although the plants develop with but a very moderate heat, they should never suffer enough from cold to arrest their growth.

To sum up the above notes, I may say that the principal points to success are the following:—Sow on a firm good compost, afford a regular heat and a constantly moist atmosphere, grow the plants steadily and without a check, otherwise the roots instead of being crisp and tender will be coarse and stringy. That rule applies to all Radishes, particularly to the improved early sorts already

mentioned. These sorts can be grown in the best possible condition only in places or near cities with frequent, regular markets, where the roots may be delivered on the day they are fit for sale, for if it is possible to grow them quickly they as speedily become hollow at the centre.

For private gardeners, and in places where the markets are held but once or twice a week, the hardier and less rapid growing varieties, such as the Turnip Scarlet and Early Scarlet, Olive-shaped Scarlet, Deep Scarlet and Purple White-tipped are to be given the preference. These may be grown in ordinary garden soil, but will succeed better if the soil has been mixed with some leaf mould. The Scarlet White-tipped Turnip, whether grown on a hotbed, under frame, or in the open ground, requires the same attention as the Olive-shaped White-tipped, which is the kind most grown in February on hotbeds without any other protection than that of straw mats as described; but to give the best result the soil wherein the former or White-tipped Turnip is grown should be trodden over or pressed down more firmly before sowing, and the seed should be covered with hardly half inch of mould. The open air culture, from April onwards, supplies roots until November, and even later; after that time come in the Radishes obtained from sowings made in October in the open ground under cold frames or bellglasses.

Where uninterrupted supplies are to be taken to the market during summer a sowing should be made every two days, or even every day in a firm, rich, cool soil. All our market growers proceed in that way, and it would be well if private gardeners did the same.

It is through not following the above simple rules, and by trying to grow the earliest and less hardy kinds as they grew the older sorts (sowing them in ordinary garden soil too wide apart), that people so often complain of the result they obtain with improved forcing and French Breakfast Radishes.—E. SCHÆTTEL, Paris.



ROSE NOTES.

It is now the busy season, when constant attention is necessary to Roses, thinning out all weakly shoots, and looking closely after the Rose grub. The severe winter has had no effect in diminishing this pest, as they are plentiful enough now. We pinch them between the thumb and finger, at the same time pulling the leaf off. When we left them on after pinching them we could not tell as readily afterwards the live ones from the dead without unrolling the leaves. The spittle-fly should also be destroyed, although it is not so destructive as the grub. Any traces of the orange fungus should be carefully removed and burnt. It is surprising how rapidly it spreads when once it commences. Softsoap will kill it, but it is difficult to syringe the under side of leaves of dwarf Roses. The season is very backward, and unless the weather becomes hot there will not be many Roses before July.

Tea Roses are quite a fortnight later than last year. Here in the Midlands, on June 10th, not a Rose was early enough for disbudding, excepting Marguerite de St. Amand, which is always ready long before any other. I like to disbud as soon as they can be safely handled, so that the sap can all flow into the central bud.

The Roses still show the effects of the Whitsuntide frost, the leaves that were young then being quite shrivelled up. I always thought Her Majesty a fairly hardy Rose, but we have lost above half of our stock this winter.—ALMA.

ROSE PROSPECTS.

OF course by this I mean the prospects of Rose showing, which is always at this time of the year a matter much talked about in that little world over which Queen Rosa reigns supreme, and many and varied are, according to the seasons, the expressions of hopelessness and despair. I do not think that in my long experience as a sort of chamberlain in the court of her majesty I have ever heard such wails of despair, such pessimistic views, as many of our exhibitors are daily sending me; a very chorus of Jeremiahs, whose tale is nothing but mourning, lamentation, and woe, and more especially is this the case with growers of Tea Roses. They have been, in fact we all have, persuading ourselves that they were as hardy as H.P.'s, and this rude shock to our senses has come from the terribly severe weather of 1890-91. As far as my experience goes the sharp frost of Whit-Sunday has not done much, if any, harm to Roses in this neighbourhood, and it is to the ravages of the winter frosts that we owe the desolation which reigns in many a garden now.

As far as I can gather from reports which I have from all parts and from my own observations, the East Anglians have had the roughest time of it. That noble army of persons who hail from there will probably consider that they deserve to be called "a noble army of martyrs." One friend, whose heart was too full I suppose to write a letter, sends a

card, "No Roses this year, all dead." Of course I do not quite take this in, the language is too bald, but at any rate indicates a very depressed state of mind; perhaps a course of Heidseek or Veuve Cliquot might be a good prescription for him. Another from quite the opposite side of England asks whether it would not be better to postpone the Tea Rose Show till the first week in September. Perhaps he sees in prospect the championship passing away from him, and so pessimistic views seize him too; but he tells one curious and serious fact that eight of his bushes are absolutely budless. The length of the cold weather, the low temperature of the early part of June, when we were anticipating so much warm weather, has been very disappointing; but there does now seem to be a gleam of hope, the temperature has risen, the nights are warmer, the sun shines brightly, and our hopes are quickened.

With regard to Hybrid Perpetuals I hear on all sides that the outlook is most promising. Many communications which I have received record that, although they were severely cut and had to be pruned very hard, that they have broken uncommonly strong, and that should warm weather continue they will carry fine blooms. I do not think that about us here, whatever it may have been in other places, the Whitsuntide frost did any damage to the Roses, not even, as far as I can see, scorching the foliage. It is believed by some that the cold weather will cause the early blooms to be coarse, but I have not as yet seen any proofs of this. Of course, another ten days or so we shall be better able to judge.

There has been, so far as I can ascertain, a great absence of insect pests. The maggot has not been nearly so abundant, perhaps to be attributed, as Mr. Brown of the gardens at Great Doods, Reigate, says, to the very hard pruning necessary this year, and that the cutting away of so much wood destroyed the crevices where the eggs had been deposited; but be that as it may, I have never seen so few of them as this year. Equally remarkable, too, has been the absence of green fly. I always measure the probability of an army of this by the state of the Hops. If growers begin to complain of "fly" I can always then be pretty sure that the time is at hand when Roses will have to pay the penalty of an invasion. Should they appear, syringing must be resorted to. And here let me say, that where there is water power there can be nothing so effectual as Stotts' distributor and the powder killright supplied by the Company, and where there is not one of these, syringes will form good substitutes, to be followed by good syringings of clear water.

It is of course quite impossible to say what the three weeks before the National on July 4th may produce, but there is, I fear, some ground for the belief that it will not be so large as usual, many of the smaller growers having been hardly hit; and I think it is not improbable that we may see the tide of victory rolling westwards. Will the challenge trophy again find its way to Exeter? and will the northerners be so completely out of it as they now say they will be? Time will tell; but I rather incline to think that it is in the direction of the southern and south-western counties that we must look for winners in the big fights.

One Show will be greatly missed by many rosarians, that of Wirral. Since the time when I asked the readers of the Journal the geographical puzzle, Where's Wirral? many a good rosarian has found it, and since that time it has attracted to it most of the best cultivators, both amateur and professional. Here Mr. Jowitt exhibited that wonderful box of thirty-six which has remained fixed in the memory ever since. Here Mr. T. B. Hall began his successful career which ended in his winning the provincial trophy twice; and here many have found out that the hospitable doors of his pretty place, Larchwood, were open to the brotherhood who loved the flowers he loved so well. But I felt that when he retired from the field which he had given up, Wirral was doomed. It could only be a matter of time, and it has come no sooner than I anticipated. There are, I fear, some other societies which are languishing, and with the withdrawal of some of our best exhibitors, especially in the north, the outlook of Rose showing is not of the very brightest character. Then, too, the way in which Rose shows clash is a most fatal error. Each society has its own day and its own way too, and the result is that some days are crowded and others a blank. Perhaps it cannot be avoided, but no more can the collapse of many a society which suffers from want of good management. True there are only about three weeks of Rose showing, and each society is anxious to secure the best days in those weeks—viz., the half-holiday days, and thus the clash takes place.

There are signs of the coming gathering of beauties. I this morning gathered (June 15th) a lovely bloom from the wall of that great acquisition of Messrs. Keynes, Williams & Co., Climbing Niphotos, and another of Sunset, while Belle Lyonnaise and Bouquet d'Or are each hour opening their blossoms. So let us not despair; but I hope that on the 23rd we may see at the Drill Hall a goodly array of Tea Roses.—D., Deal.

HARDY FRUIT.

[A prize Essay read at a meeting of the Cardiff Gardeners' Mutual Improvement Society.]

(Concluded from page 468.)

THE STRAWBERRY.

THE cultivated varieties which are so familiar to gardeners of the present day are hybrids, and according to distinguished botanists the result of crossing *F. virginiana* with *F. chiloensis*, two American varieties.

The Strawberry may be described as the most delicious of English grown fruits, the Pear alone excepted. It is also one of the easiest plants to propagate, throwing off abundance of runners, which may be purchased at about 1s. per 100, unless it happens to be a new variety like Laxton's Noble, then of course it is dearer for a few years. These

runners brought in contact with the soil will form plants within twenty days, and may be separated from the parent and planted out. The custom observed by gardeners, however, is not quite so rough and ready as that.

They generally cut off all runners that are not required for future use, and layer the remainder as follows:—Either fill small pots with soil—the usual garden soil will do if there is no better at hand—or use small pieces of cut turves 2 inches square, and upon them or the pots of soil place the runners, pinching off the running extremity and all lateral runners, selecting those which are strongest and which by their development show the best signs for a strong plant, fasten the runner securely with a peg or small stone, and in about a fortnight they will be fit for separation. It will be found more convenient to draw all runners intended for layering from every two rows to their centre; this gives greater facility for watering should the weather prove dry, especially if in pots.

The foregoing method is only practised where gardening generally is done well. Another method is to cut off the runners, pricking them out into nursery beds about 3 inches apart, allowing them to remain until fit for planting. The great objection to the latter method is that the runners so treated will not form good plants quickly enough to get them planted into their permanent quarters sufficiently early to carry them safely through the first winter. Owing to this fact it is best to leave them in the nursery beds through the first winter, planting being deferred till spring, nearly a whole season and a good crop being thus missed; whereas the plants layered in pots or in the pieces of turf could be safely planted out in late summer, and would be considerably in advance of those planted in the spring following, and would be certain to yield a crop while the others would not.

In large private establishments where the kitchen garden ranges from 3 to 4 acres in extent Strawberries are grown on a proportionate scale. Roughly speaking I should say one-tenth of the areas given is devoted to this fruit. Taking a 4-acre garden for an example, the amount of space devoted to Strawberries, according to the foregoing estimate, would be 64 perches, which should be divided by 3, thus giving 20 perches or thereabouts to each bed in different parts of the garden, if only for the purpose of keeping varieties true to name. It is called the three-year system, and is generally considered the best. By following this, which is as simple as it is effective, one bed would be destroyed after giving its third crop to make way for another planted the same season, but in a different place. It is generally admitted that a bed of Strawberries reaches its best the second year, maintains it the third, after which there is a marked deterioration, and should make way for another; and also because if left any longer it begins to grow weedy, and perennial weeds are difficult to exterminate when once they secure a footing.

Having previously noticed the preparation of runners for planting I will describe the life and management of a bed of Strawberries for three years. The ground should be deeply dug and heavily manured, and also given a dressing of lime if any way stiff, indeed a mixture of soot and lime is an excellent manure for any kind of land. Some advice using gaslime mixed with the manure when in the manure yard previous to wheeling it upon the ground; if used it should be a considerable time before planting, as it is of a burning nature. Plant in rows 2 feet apart, 18 inches between the plants. Early planting is important, early in August, if possible, for upon it depends the prospect of a good crop the first year. Do not plant deep or high. Simply allow the collar of the plant to rest upon the surface of the soil. Watch that the severity of frost does not lift the young plants, as it would do if planted late. Keep the ground clear of weeds by using the Dutch hoc until winter. I do not think it necessary to mulch as heavily the first year as afterwards. A little may be placed around each plant, and upon that in the next season place straw litter to keep the fruit clean. After the first crop is gathered clear off all runners, cut down weeds, and cover with a good mulching of rather long partially decayed manure; this will assist them to develop fine crowns, and also keep them in comfortable quarters during the ensuing second winter. Weeds being kept down the bed would not require any further attention until the crop was fit for gathering in the second year. Some growers fork between the rows in spring, but I do not think it necessary, and besides it injures the roots, and most gardeners are busy enough at that time of the year without adding unnecessary labour. As a rule the July or August mulch well done ought to carry the third and last crop to a good finish, after which it is destroyed.

Protection from birds is effected by netting the beds. Slugs usually get their share, no matter what precautions we may take. In gathering fruit, if decided for dessert, select the finest fruit, leaving the stem on. But if for preserving the rule need not be observed, decayed and immature fruit alone being rejected.

As to varieties, I mention the following as the best I know:—Black Prince, Keens' Seedling, Vicomtesse H. de Thury, President, British Queen, Sir J. Paxton, Eleanor.

Black Prince is the earliest, Eleanor the latest, British Queen the best flavoured, Vicomtesse H. de Thury the most dependable for general purposes. Laxton's Noble comes to us with a great reputation, and the general opinion as to its merits is highly favourable. In appearance and quantity it is classed A1, and as these are profit-getting qualities it is sure to gain in favour, even though its quality may be inferior to some of the varieties mentioned above.

CONCLUDING REMARKS.

The year 1890 will be remarkable for having seen in London the largest competitive exhibition of fruit ever seen in this country, held at

the Guildhall by the Fruiterers' Company, when no less than 35,000 persons visited it. This great fact points to a still greater fact—viz., that the people of England are becoming more interested in fruit culture, and at last are becoming alive to its possibilities and prospects. Much of the credit for this encouraging prospect is due to the efforts of an excellent Society that was formed some few years ago, and well known now as the British Fruit Growers' Association, and it is with the greatest satisfaction that I observe that during the coming summer Cardiff will have the honour of a visit from members of that body, a discussion on Hardy Fruit for Profit being held under the auspices of Cardiff Horticultural Society. We need enlightening on this subject, for around Cardiff fruit is not grown very largely; outside the boundaries of private gardens it is a barren waste as far as fruit trees go, while of orchards I have met with but few; at least, after residing in the district for eight years, such is the impression left on my mind.

Our market gardeners appear to rely solely on vegetables, except in rare instances, to obtain their livelihood. The fact is the natural disinclination of the owners of the land to grant leases on anything like reasonable terms is an effectual bar to fruit cultivation, because no sane man would lay out his capital on other people's land with no prospect of seeing it return. But this excuse will not hold with respect to the smaller fruits, such as Currants, Gooseberries, Strawberries, Raspberries, &c., however forcibly it may apply to the larger fruits, such as Apples and Pears, for the former arrive at maturity quickly, and deserve a trial, especially Strawberries, and any efforts to promote such would be of material value to the community at large and to gardeners in particular. I sincerely trust that the Cardiff Horticultural Society will go to some trouble to get the market gardeners of the district more interested in fruit culture in the future than they seem to have been in the past by inviting them to the Conference. It is also to be hoped that all those who are in a position to afford facilities for the culture of fruit—such as farmers (leasehold and freehold), owners, &c.—will have their attention drawn to the Conference. It is quite possible that they may be able to see that Glamorganshire may be able to produce something else besides coal, strikes, and trade unions, the one thing necessary being to excite public attention. I may say we have the trees, we have the men, we have the money too; but they are separate, and need drawing together to act in unison, and then we may hope to march, and not merely mark time.

[This excellent paper was read by Mr. Charles Lewis, gardener to Alderman Fulton, Park Place, Cardiff, but we did not receive his name in time for publication with the first instalment of his extremely practical address.]



EVENTS OF THE WEEK.—The Royal Horticultural Society's Fruit, Floral, and Orchid Committees will meet at the Drill Hall, James Street, Westminster, on Tuesday, June 23rd, when a silver challenge cup will be offered for the best collection of herbaceous Pæonies from amateurs. Silver-gilt and silver Kelway medals are also offered for Pæonies and Delphiniums, while prizes are provided for laced and border Pinks. Besides these attractions the National Rose Society will have an exhibition of Roses, good prizes being offered for Teas and Noisettes. Mr. T. W. Girdlestone will deliver a lecture on Tea Roses at 3 P.M. At 6.30 P.M. the same evening the Royal Horticultural Society's dinner will be held in the Whitehall Rooms, Hôtel Métropole. A Rose and Begonia Show is announced to be held at the Royal Aquarium, Westminster, on Wednesday and Thursday, June 24th and 25th, and in connection with this Exhibition it has been arranged to have a Rose fair for the benefit of the Gardeners' Orphan Fund. The Richmond (Surrey) Horticultural Society will also hold their annual Show in the Old Deer Park, on June 24th. Messrs. Protheroe and Morris announce sales of Orchids for Friday next, June 19th, and Tuesday, June 23rd.

— The sale of the LATE MR. SHIRLEY HIBBERD'S LIBRARY is announced by Messrs. Sotheby, Wilkinson & Hodge, 13, Wellington Street, Strand, to take place on Monday, June 29th, and Tuesday, June 30th, at 1 P.M. each day. A great number of rare and valuable horticultural and botanical works are included, with complete sets of the "Botanical Magazine" and "Botanical Register." There are 611 lots in all.

— THE WEATHER IN THE METROPOLITAN DISTRICT has been warm and summer-like during the past few days, a most agreeable and long expected change. The fruit prospects generally are better than were anticipated after the frost at Whitsuntide. Low temperatures

have been experienced on several occasions since, and we hear that on June 10th near Ringwood Potatoes a foot high were extensively killed by frost.

— NATIONAL CHRYSANTHEMUM SOCIETY.—The date of the annual picnic of the members, previously mentioned, has been fixed for Monday, July 20th.

— FRUIT PROSPECTS IN KENT.—Strawberries look very well indeed, also Apples; Gooseberries thin, but growing out well. Black Currants almost nil, the frost at the end of April having cut them off; Red Currants are short. Cherries a light crop. Plums are satisfactory at present.—W. K., Maidstone.

— WEATHER IN LIVERPOOL.—The weather on the whole has much improved during the past week. The sunshine has been nearly continuous, but the evenings are cool; and on two evenings the thermometer had been below freezing point, and we have had some strong wind from W. and N.W.

— MR. G. FOSTER, Teignmouth, sends us five handsome fruits of STRAWBERRY WATERLOO, from plants grown in a Peach house. One of the fruits weighed exactly 1½ oz., two others were nearly as much, and two weighed a little over 1 oz. each, making a total for the five fruits of 6½ ozs. They were of the usual dark colour, and the flavour was very satisfactory.

— OF all the spring flowering trees none appears to give more satisfaction than MAGNOLIA CONSPICUA, or its purple-tinted form which is named purpurea. The former variety flowers the more freely of the two, but I think the latter is the more appreciated. I think, too, that it lasts longer in bloom than the pure white sort. In any case both deserve to be seen more frequently. Any good garden soil which has been deeply moved will suit these Magnolias well.—E.

— MR. A. A. BENNETT, Ashford Gardens, Cobham, Surrey, writes:—"In answer to numerous inquiries respecting my MUSHROOM EXPERIENCE let me say time will not allow me to answer each individually by post. The best advice I can give to those who have failed is to read 'Mushrooms for the Million' carefully, and try again. I am glad to hear from some old growers of better success than I had, so may I suppose hope for even better crops as we gain experience."

— THE second quarterly meeting of the SHEFFIELD, HALLAMSHIRE, AND WEST RIDING UNITED CHRYSANTHEMUM SOCIETY was held on Wednesday evening, June 10th, when there was a large attendance of members, and a paper was read by Mr. W. K. Woodcock, Barkby Road Nurseries, Syston, Leicester, on "Various Modes of Chrysanthemum Culture, with the Best Varieties." Mr. Jno. Haigh took the chair, and a useful discussion followed the reading of the paper. Some very choice table plants—Crotons, Palms, Pandanus, and Dracenas—occupied a central table in the large room, being exhibited by the members in competition for several small prizes offered.

— BEGONIA MANICATA is one of the best winter flowering Begonias, and is rendered much more useful by the small amount of heat required to have it in good condition. In a temperature of 45° by night with a rise of 10° during the day with sun heat it flowers profusely and lasts a long time. We have plants of it now in good order which commenced unfolding their blooms at the end of February. In a cut state the blooms last fresh much longer than the majority of Begonias, and being light they associate well with other flowers and greenery. Cuttings strike freely in a gentle bottom heat at the present time. By growing them in the greenhouse during the summer, and not overpotting them, good plants will be obtained by the following autumn.—M.

— EARLY STRAWBERRIES.—We are ten days later in commencing to gather Strawberries than we were last season. Then we picked a good dish on June 2nd, and this year a small gathering of extra fine fruit was ready on June 11th. The variety is Laxton's Noble and the position sheltered, too much so probably, and sunny. Once more the young plants, or those put out early last August, are the first to give us ripe fruit, and that by about five days; and seeing that the few old plants left were adjoining the young ones, the fruit on the latter being also the finest, this is another proof, if such be needed, of the general superiority of youngsters when properly managed. James Veitch will be earlier than Sir J. Paxton, both having the same position and treatment.—W. I., Somerset.

— PYRUS JAPONICA makes a capital hedge with a little attention to tying the branches into shape if good-sized plants are employed, which are generally of an all-round spreading habit provided they are not interfered with. We have this shrub growing on each side of a gravel path at one of the entrances to the kitchen garden on the east side, and right well it succeeds. When planted two years ago some stout stakes and a cross rail or two were fixed to secure the main branches to in the form of hedge required. On both sides the young shoots grew, and which are annually cut close in to the main stems to preserve neatness. A full crop of flowers is now passing away. The leaves have a cheery appearance at the present time when tinged with red, as they are in a young stage.—E.

— FRUIT AND FLOWER PROTECTORS.—We have received from Mr. J. Taylor, a Cheshire gardener of ability and repute, a sample of his appliance for accelerating the ripening of fruits and advancing and protecting flowers for exhibition or otherwise. This appliance consists of a pair of articles in glass, somewhat resembling a Melon cut in two parts and hollowed; or two basins placed face to face, and kept there with a wire spring, the wire also acting as a suspender. We are asked to give an opinion of this protector. Our opinion is that it is one of those things the merits or otherwise of which can only be determined by actual practice, and we think it is for the inventor to have it tried by unprejudiced persons, with the view of determining its usefulness, and after he has done this to place it before the public in the ordinary business way. We have had no opportunity of trying the protector, and our duty is done by announcing its existence.

— PEACH LEAVES BLISTERED.—I have a wall 12 feet high, and there are six Peach trees on the south side. Last year one tree had a great many leaves blistered, but all the others were free. This year the same tree is very badly blistered, scarcely any of the first leaves were free from it, and the other trees nearest to it have several leaves blistered. The trees were well covered with scrim as soon as the first flowers opened. It was fastened under the coping and brought out about a foot from the trees, and it was left on until the fruit was swelling, when it was taken off, as the leaves were blistered while under this warm protection. I cannot see how the weather could cause it, especially as they were all protected alike. Would it be caused by some insect?—ALMA.—[It is caused by a fungus, but it is probable that the sap of the trees was in a morbid state, predisposing the tree to the attack of the enemy.]

— THE NATIONAL DAHLIA SOCIETY.—We are desired to call attention to the fact that the annual report, list of members, and schedule of prizes have been issued by the above Society, and can be obtained on application to the Hon. Secretary and Treasurer, T. W. Girdlestone, M.A., F.L.S., Sunningdale, Berks. The annual Exhibition, to be held at the Crystal Palace, Sydenham, is announced for Friday and Saturday, September 4th and 5th next, when substantial prizes will be competed for in all the sections, thirty-two classes being provided for nurserymen, amateurs, and open. The Society is in a very satisfactory condition, as the accounts for last year show a favourable balance of £31 17s. 7d. Besides the ordinary schedule particulars a valuable Dahlia Analysis by Mr. E. Mawley is included, extending from the year 1883 to 1890.

— EARLY PLANTED POTATOES.—On page 406 mention is made of the fact that large breadths of early planted Potatoes having been destroyed by the sharp frosts experienced in March last, and as I happened to have planted the bulk of ours, also advising others to act similarly, I was naturally somewhat startled at the statement alluded to. As may be imagined, it was not long before I paid a visit to the Potato ground, but soon discovered there was no cause to be alarmed. The ground was in such admirable condition, and the weather so favourable for planting in February, that I could not resist the temptation to get in all our late Potatoes, and although, as it turns out, it was a risky proceeding, I still think we acted rightly in planting when we did. In spite of the 17° or more of frost which we had to endure during the early part of March there are no losses, not a single set apparently having missed starting. All are pushing up shoots strongly and are well rooted, none being forward enough to be injured by the May frosts. I have also paid a visit to another large breadth of Potatoes that I advised should be planted in February, and these again are in admirable condition. In February the ground was in perfect working order, and that, too, to a good depth; but the March snows and frosts left it in a cold, tough condition, and I am fully convinced that we shall be great gainers rather than losers by planting thus early. Ours being heavy ground comparatively shallow planting answers best, and it is some-

what inexplicable how it was our sets escaped injury. The varieties are hardy certainly, these being Magnum Bonum, Laxton's Reward, and Champion.—W. I.

— THE ROYAL HORTICULTURAL SOCIETY.—A schedule of the Conferences and Exhibitions to be held at Chiswick Gardens this year has just been issued, and gives full particulars. Conferences will be held Tuesday, July 7th, on Hardy Summer Perennial Plants; Wednesday, July 8th, on Strawberries, Gooseberries, Raspberries, Currants, and other Small Fruits; Tuesday, October 6th, on Perennial Sunflowers and Michaelmas Daisies; and Wednesday, October 7th, and Thursday, October 8th, on Conifers. The Exhibitions on corresponding dates are—July 7th and 8th, 1891, of Hardy Summer Perennials, and of Strawberries, Gooseberries, Raspberries, Currants, and other Small Fruits; October 6th, 7th, and 8th, 1891, of Perennial Sunflowers, Michaelmas Daisies, &c., and of Conifers. Medals and prizes for amateurs are offered at these meetings.

— ORCHIDS BY SPECIAL TRAIN.—A striking proof is given of the great progress which the love for Orchids is making in this country by the fact that the Liverpool Horticultural Company have recently removed a collection of Orchids which they have just purchased from the executors of a gentleman who resided at Falkirk, N.B., by special train. Liverpool is evidently not behind other parts of the country in its appreciation of this lovely plant. The very high prices at which these plants have often been purchased has no doubt tended to frighten all but the wealthy from indulging in their cultivation, but it is understood that the large importations which are constantly pouring into the country from all parts of the world have so greatly reduced the prices that Orchids are now within the reach of all who can afford to keep a garden and a small greenhouse. There are still plants of special kinds for which high prices have to be paid, but the cheaper and more plentiful kinds are equally as beautiful as the more rare and expensive kinds.—(*Liverpool Courier.*)

— REPORTS ON HORTICULTURAL SUBJECTS in the daily papers rarely make grave pretensions to accuracy, but five mistakes in as many lines, including a serious confusion of persons, rather exceeds the latitude allowable. The *Daily Telegraph* recently, in noticing the Royal Horticultural Society's meeting at the Drill Hall, concludes a paragraph in this way. "The Marquis of Salisbury sent a magnificent collection—of Strawberries especially. Mr. W. H. Smith showed specimens of the same luscious fruit, for which he received the thanks of the Society. The Duke of Northumberland was strong in Melons, and Lord Rothschild in Nectarines." From Hatfield very fine Strawberries were certainly shown. Mr. W. H. Smith, however, did not favour the meeting with an exhibit of any kind, though Mr. J. Smith, gardener to the Earl of Rosebery, Mentmore, had several dishes of Strawberries, and it would perhaps rather surprise him to be mistaken for so distinguished a political personage. From Sion House only one Melon was shown, and Lord Rothschild had no Nectarines there, but Messrs. Rothschild of Gunnersbury exhibited some very fine samples.—R. M.

— BOTANY OF THE BURMESE FRONTIER.—The Eastern papers report that an expedition has, by order of the Straits Government, commenced work on the frontier between Burmah and the Malay Peninsula. Its operations will be chiefly confined to Pahang. It is placed under the charge of Mr. Ridley, Director of Gardens and Forests in the Straits Settlements, accompanied by Mr. William Davison, Curator of the Raffles Library, Singapore, and Lieutenant Kelsall, R.A. The funds available for the expedition are 2000 dollars voted from the Straits Treasury. The object is to ascend the highest mountain in Pahang, incidentally noting all that can be learned about the physical features and the flora and fauna of the country. The expedition was to go by steamer to Pekan; thence up stream to Kuala Lipis; thence northerly up the Tembelinis and Sat rivers. Having ascended the latter river so far as it may be navigable for small canoes, the expedition will strike through forest and jungle, estimated to extend for sixty miles, till they emerge at Gunong Tahan, which is said to be about 8000 feet high. Ascending this mountain, and crossing what is called Cameron's plateau, they will then ascend Gunong Siam, a mountain the height of which has been estimated to be as much as 14,000 feet. Having completed this ascent, they will return by the same route, the estimated period of absence from Singapore being between two and three months. The party were to take with them three Tamil hunters and collectors attached to Mr. Davison's Museum staff, and three Malays of the Gardens and Forests Department.—(*Nature.*)

— **KERRIA JAPONICA FLORE-PLENO.**—As a hardy climber for giving a profusion of flowers in the early spring this plant has no equal. It is regarded by the majority of gardeners as too "common," and perhaps it is in some districts, especially in cottage gardens. It is largely employed for covering the front walls, which is the main cause of its free flowering annually as the wood becomes fully matured. No difficulty need be experienced in increasing the stock, as half-ripened shoots form roots readily if cut into lengths of 6 inches at the end of August, inserted firmly in sandy soil in a cold frame, which by the following May will be in good order for planting in a permanent position. By taking the sucker-like shoots with roots attached is another and an easy way of adding to the number of plants, as old plants readily throw up these offshoots. By planting this *Kerria* in two or three positions the season of flowering will be prolonged as it succeeds elsewhere than a south aspect. Any fairly good soil will be found suitable, and by adding manure freely a greater provision of flowers is assured.—J.

— **NEW ZEALAND APPLES.**—We have received from Mr. W. E. Lippiatt of Albion Nursery, Otahuhu, Auckland, New Zealand, a case of true Golden Russet Apples of very superior quality both as regards the soundness of their condition and the excellence of their flavour. They arrived on the 5th of June, each fruit wrapped in soft paper in the manner in which Oranges are received, and out of the half bushel or so of fruit there were only nine at all decayed. This is one of the most successful importations we have seen of New Zealand Apples, and the richness of flavour which this variety acquires in that climate commends it as one of the best that our antipodean cultivators can grow for exportation "home." In the same case were a few specimens of a seedling called Lippiatt's Seedling, of which Mr. Lippiatt says, "It is a seedling raised by my father at Penge, Surrey, the year before he left home some twenty-six years ago. It was raised from seed of Ribston Pippin, and though it has not the rich flavour of that variety it is a fine keeper, and without doubt the heaviest Apple we have." This is a large, handsome Apple, striped like Cox's Pomona, but as large as Mr. Saltmarsh's Queen, and will be an acquisition anywhere.

— **BLACK CURRANT CATERPILLAR.**—I have seen reports in the *Journal of Horticulture* about the Black Currant mite. I cannot find mites in the buds, but only a small caterpillar. The trees here have been infected in the buds over ten years. Two years ago last February I had them all taken up and burnt, and new fruiting trees put in the same places. Up to the present time they are quite free from the caterpillar. At my cottage about 400 yards away I have Black Currant trees infected. Last year, soon after the fruit was gathered, I found some of the buds swelling, and by the aid of a good microscope I found the little caterpillar in them and in February. In May I found the same, only larger. I carefully took off a few buds and leaves, put them under a bellglass in a room on paper, and in about three weeks I saw some of the leaves had been eaten and a small fly under the glass. I have sent you the fly and the leaves. You will see on them the place the fly came out of. I find picking the buds off a very good way this year. I had them picked off three times, the last time in May, and still finding plenty of infected buds. I hope to find but few next year through extra care in picking off the buds this season.—WILLIAM KIPPS, *Walton Lea, Warrington*. [We shall be glad to have further, and if possible better, specimens for examination at a convenient time, also some buds.]

— It is somewhat surprising to find how well the FORGET-ME-NOTS of different sorts have stood the late winter. They appear to be but little harmed here at any rate. The position certainly is not one of the best to ensure their safe keeping through the winter, but a small amount of sun heat can reach them during the autumn and winter months. *M. dissitiflora* I regard as the best of the *Myosotis* family; the growth is robust, yet compact, the flowers large, intensely coloured, and produced in a great mass. Nowhere does this show to better advantage than when growing close to the water, where the reflection of the flowers can be seen. We have it planted freely amongst the rocks right down to the edge of a pond; the moisture which the roots obtain appears to be just what is needed to ensure a free growth and a full crop of bloom. At one time I used to depend upon cuttings taken singly inserted in a cold frame at the end of July to ensure the strain being kept pure, but I now manage to do this by laying the plants thickly in rows on the north side of a wall, when they are removed from the beds at the end of May. There they remain until the end of August, when the roots are pulled into pieces, dibbled in a west border, and by planting time are stocky, well furnished with roots, and good foliage. This plan I find

takes less time and gives equal results as the cutting process. Messrs. Suttons sent out not long since a variety they call their Dwarf Blue; it is very good, although much later than *dissitiflora* in flowering, which prolongs the display. The white variety of *alpestris* I do not care for, it is too straggly.—E. M.

— **A CACTUS SOCIETY.**—A letter appears in the *American Florist* to this effect:—The Baltimore Cactus Society of Baltimore city is, to the best of our knowledge, the only Society of its kind in the United States. The object is the cultivation of the Cacti, and we must say that our efforts thus far have been crowned with success—they far exceeded our expectations. We organised with a membership of eight in November, 1889, and in April of 1890 were incorporated by the Maryland Legislature through the special efforts of the Hon. Theo. B. Fox, Rep. of the Second Legislative District of the State of Maryland. Since then our membership has increased to twenty-eight active and eight honorary members, which is composed of some of the representative business men of our city, including several florists, who have taken up this "hobby," the collecting and cultivating of this rare and beautiful plant, and a few of them have indeed a collection of which they can well be proud. The interest in the community is gradually growing, and the "fever" now seems to attack the gentler sex as well as our brother "cacto-maniacs." We are banded together as a Society for the purpose of promoting the interest in this plant; we will be pleased to communicate with anyone who is interested in its culture, and will answer any interrogatories regarding them that lie in our power. We hold regular monthly meetings, which are well attended, and great interest is manifested by all in subjects brought up for discussion among the members for the promotion of knowledge in the cultivating of this plant.

SEASONABLE HINTS ON FLORISTS' FLOWERS.

AURICULAS.—Again has the time come round when growers have to determine what they will do about repotting their collections, and the first point that they have to decide is as to when it is to be done; but in the meantime they will have removed their plants into their summer quarters. It is true that we have not as yet had much warm weather, still it will be better to shift the frames to some place where they can have a northern aspect, and where the plants can have cool quarters from June to September inclusive. The question is still an open one amongst growers as to whether it is better to pot now or in August. Many reasons have been brought forward for both sides, on which, according to Sir Roger de Coverly, a good deal may be said on most questions. An interesting conversation took place at the luncheon on the Show day at Westminster on this subject; various opinions were expressed, but I believe that the general opinion was that it did not much matter, and that probably it would be regulated by convenience and by the size of the collection. Where a large number of plants are grown an early opportunity will be seized to get the work well over, and although my collection is a small one I like to have it done at the end of May or early part of June, placing the plants in a closed frame for a few days shaded, and then taking the shading off and opening the frames on all available occasions—*i.e.*, when there are no heavy rains or cold winds.

As to compost, I believe that if good sound fibrous loam can be procured the chief element of success is obtained. Three parts of this, one part of well decomposed cow manure, and one-third of leaf mould, road grit, and powdered charcoal forms, I think, an excellent compost; it should not be riddled. There should be a good quantity of drainage, and care should be taken to pot firmly. The tap root or carrot should be well looked after, and if any of it has become too long—and some varieties have a greater tendency to this than others—it should be shortened, and any spots of decay should be cut away, and the cut dressed with a little powdered charcoal. Care should be taken, too, that the pots both inside and out are perfectly clean. The use of glazed pots, which became so general amongst Auricula growers, is unquestionably good. The plants do not require watering so often, and the pots do not accumulate green upon them as the ordinary ones are wont to do. Of course watering will be carefully attended to. Much depends on the weather, as all who grow pot plants know full well. In all cases where it can be procured rain water is the best to use.

CARNATIONS AND PICOTEEES.—I am afraid that this is a sore subject with most growers of this beautiful class of plants. I met Mr. Samuel Barlow at Manchester, and he told me his collection had been literally decimated. Mr. Lakin told me that his losses might be reckoned by hundreds, and I very much fear many more are in a similar plight. There is not at present much to be done with them. They have already been staked, and are placed out of doors (I allude to those grown in pots), and the only thing they now require is to be kept clear of weeds and to be watered when the weather is dry. The late rains have been very beneficial to them. Those in beds have also suffered a good deal from the terrible winter, even in many places the old Clove being killed. It will now, however, be time to make the beds tidy. Place stakes to the flowering shoots, and apply a little top-dressing.

GLADIOLI.—As far as I can judge from my own collection the frost

has not injured the corms, but I do not as yet see any signs of Lemoine's hardy race making their appearance, and should they turn out to have been killed by the winter they will be a doomed race. In point of beauty they cannot touch the *gandavensis* hybrids, and if in the one point on which their superiority has been extolled they fail few of us would care any more for them. It will be necessary to keep the beds well weeded, and this should be done by hand; a hoe must not be used, as there may be several which have not pushed through the ground, and a snip of the hoe might settle them for the year. Nothing more need be done to them for some time.

PANSIES.—I have never had a better bloom than this season, and they were at the end of May in full beauty. I only grow Fancies, and some of them are of exquisite beauty and great size. Some we grow in pots, and I should imagine that those in the open ground stood but a poor chance this season. My plants have only been allowed to have three or four growths. They have been kept free from weeds, and as soon as the flowering is over I plant them out in a shady place, not

to be fine, to apply one or two doses of liquid manure. I do not think there is any use in giving it later on. What is wanted is to give vigour to the coming flower, and when the bud is formed this seems to be almost too late; and now that we are experiencing stormy weather it will soon be washed into the roots. When the buds are formed then dis-budding must begin. This is a point where amateurs who are not exhibitors too often fail, and yet they go to an exhibition, see Roses which have all been taken from disbudded plants, and wonder their garden does not supply them with equally good ones. The season must be a backward one, let us hope it may be a good one.—D., *Deal*.

LÆLIA HYBRIDA ARNOLDIANA.

At the last meeting of the Royal Horticultural Society classes were provided for Orchids, and it was a surprise to many that in those specially devoted to amateurs there were no entries. In an ordinary



FIG. 93.—LÆLIA HYBRIDA ARNOLDIANA.

under the drip of trees. I do this before the plants contract mildew, as they are apt to do if kept under glass too long. In this position they remain all the summer, and in the autumn they are taken up and divided, and although this seems a lazy method, yet I have found with these Fancy Pansies that it answers very well.

RANUNCULUS.—My beds of the Persian varieties now look uncommonly well. I was in great doubts about them some time ago when we were experiencing such dry and unkindly weather; but the abundant rains completely altered their appearance, and they are now looking as well as I ever had them.

ROSES.—Ah! who shall say what Roses are to be this year? At present they are pushing away as if meaning to make up for lost time. It will be necessary now to look out for the worm in the bud, and there is no way of getting rid of him but by single combat. He must be searched out and syringed to death. Another point is, where Roses are required

way without offering either medals or money prizes several collections are obtained, and it can only be supposed that after the great orchidic effort at the Temple a rest was required.

An open class was also provided for seedling Orchids, a silver-gilt Flora medal being offered, and though only two were shown they were both of an exceptional character. One of these was depicted in last week's *Journal of Horticulture*, and a figure is now presented of the other, *Lælia hybrida Arnoldiana*, for which Messrs. F. Sander & Co., St. Albans, were awarded the silver-gilt Flora medal and a first-class certificate.

This *Lælia* is the result of a cross between *Lælia purpurata* and a variety of *Cattleya labiata*, the seed having been sown in 1881, so that the plant shown with five pseudo-bulbs and leaves of different sizes is

just ten years old, not too long to wait for such a handsome Orchid. *Cattleya labiata* presents an astonishing range of variation, and it is therefore not surprising that though hybrids between that type and *Lælia purpurata* have been previously obtained, as in the superb *Lælia bella* and *callistoglossa*, yet the distinctions are strongly marked in all the progeny hitherto flowered, and the grand addition now under notice is a success of a remarkable character.

L. hybrida Arnoldiana appears to be of vigorous habit, the narrow fusiform pseudo-bulbs being 6 to 8 inches long, the leaves about 12 inches long, 2½ inches across, of very stout and bright shining green. The flowers exceed 7 inches in diameter, and have a peculiarly graceful outline and pose; the sepals are narrowly lanceolate, of a delicate evenly diffused rosy purple hue, regularly spreading; the petals are of similar colour, broader, drooping, or decurving at the tips, the margin undulated, and slightly darker veins in the centre. The lip is very handsome, the broad rounded central lobe nearly 3 inches in diameter, of an intensely rich magenta crimson, with a few still darker veins, and a golden bronze tinge in the throat. The whole aspect of the flower is very striking, and the hybrid must be assigned a place among the finest yet raised.

APPLE SCAB—CRACKING IN PEARS.

THE Apple "scab" is a minute parasitic fungus called *Cladosporium dendriticum*, *Wall.*, which attacks the leaves, shoots, and fruit of the Apple tree, but is more commonly noticeable on the fruit itself. On the leaves its advent is marked by a microscopic blackish speck on the upper surface, which gradually increases in size until it becomes visible to the naked eye as a minute black spot, and continuing to enlarge, attains varied proportions. Usually the spots are a quarter to half an inch across, but the larger the foliage and grosser the Apple tree, the finer the specimen of the fungus. In good examples it attains from one-third to two-thirds of an inch across, and under a powerful lens is a beautiful object, because its mycelial threads branch from the centre and resemble a coniferous tree of exquisite proportions, whence the species name *dendriticum*—tree-like. The fungus in the leaf does not generally develop conidia, but the short cells of the stroma, formed by the division of the threads of the mycelium by cross walls, may (and do) break off, and falling, or resting on a suitable nidus, act as spores, push out mycelium or spawn threads, and reproduce the fungus. This early condition or form of the "scab" fungus is called by Fries, *Spilocœa pomi*, and generally is the early condition prevalent in the fruit. Certainly something analogous to that taking place in the leaves occurs in the shoots in the early stages of the fungus development, but when infection is made sure, and always towards the latter part of the season, spores or conidia are developed abundantly both by the leaf and shoot infestations, and these are scattered over, remain on, and live through the winter attached to the young shoots and upon the scales of the buds of the infested tree ready for their awakening into life the following spring by the sun's warmth and genial showers of rain, whilst the leaves, sere and withered, are driven far and wide, bearing their weight of spores, and thus carry infection to any trees they may come into contact with.

On the fruit the fungus causes black, irregularly rounded spots. These are depressed in the centre, the outside surrounded with a whitish margin, which is the skin or epidermis of the fruit, and around the margin there is a dark reddish border, representing the spreading of the fungus spawn threads between the skin and flesh of the fruit.

The depressed black part of the spot is occupied by an immense number of minute bodies (invisible to the naked eye other than as a mass), which under a powerful lens are found to be club-shaped, but narrowest at the lower end, conidia (spores), generally one-celled, though occasionally, yet rarely, two-celled. These are fixed by the narrow end to the tip and sides of erect short stalks to the densely matted mycelium or stroma, which consists of closely packed small cells, due to the division of the mycelium threads by cross walls. The spawn threads remain almost wholly in the skin of the fruit, its interior not being penetrated beyond a few (sort of anchor-like) branch threads here and there, the fungus confining its foraging to the cells of the epidermis, or between those and the next layer. Continuing to spread the spots run into each other, and cover a large portion of the fruit, often causing it to crack through the contraction of the skin and subsequent attempts at swelling, which greatly disparages its appearance, using, and market value. Even in mild attacks the fruit is considerably hampered in swelling, that side infested always attaining less size than the other, and invariably diminishes the first-class and increases the proportion of inferior fruit, whilst in bad cases it renders the fruit altogether worthless.

"Cracking" in Pears is even worse than "scab" on Apples—in fact, the worst form of the fungus prevails on the Pear. It not only grows on the leaves, shoots, and fruit, but attacks the flowers, often preventing their setting, whilst it siezes on the footstalks of the fruit, causing them to fall or receive indifferent nourishment. If the fruit is beyond its setting stage it is crippled in its growth, and rarely attains any value through the devastation of the fungus, which causes it to have black depressed patches, and cracks in the skin of the fruit, after penetrating to the core, rendering it worthless. This fungus—*Fusicladium* (*Cladosporium*) *pyrinum*, *Fekl.*—differs little from the scab fungus on Apples; it is only less regular in form of the spore stalks, the "clubs" break off with greater facility, which accelerates the spread and malignity of the disease.

As the fungi prey on the leaves and young shoots the infested trees are not only injured in their current crops, but those of the future are greatly prejudiced. The shoots do not grow freely, therefore are stunted, hypertrophied, and distorted, whilst the leaves are prevented elaborating the sap, and assimilated matter is, in consequence, ill stored in the wood and buds for the healthy vigour and continued fruitfulness of the tree. Indeed, trees afflicted with "scab" and "cracking" are always more or less unprofitable and often "cumber the ground."

Scab on Apples and "cracking" in Pears are very common diseases. They are caused by the fungi named. "The weather" is too lame an excuse now to travel beyond the boundary of neglected gardens and orchards; but the disease is found in the best of cultures from the steppes of Russia to the sierras of California, and from the Shetland Isles to New Zealand. It thrives everywhere on the Apple and Pear trees where the spores have reached. All *Cladosporium* wants is an Apple or Pear tree whereon to grow. Fungus-like it revels in moist weather, nowhere so happy as in an orchard with the hedge broken down and the ditch full of water; but it likes the Apple or Pear none the less when growing in ground where the water must run. Indeed, good sites and favouring cultural conditions always tell against disease; but apart from those considerations the fungus thrives on the Apple and Pear everywhere. It is only a question of spores and "a sweet glow of moisture and warmth" to insure germination and a full development of the "plant." That poverty and ill condition of subject favours the spread of parasites goes without saying; but that is no reason why those conditions should not be remedied before the plague appears, and when it does appear take prompt steps to arrest its progress.

It answers no useful purpose to credit "the weather" with the unusual prevalence of the Apple "scab" or Pear "crack," for after all the great question is to find the most suitable remedy to employ in the destruction of the causes of the mischief, and it must be stated that whilst we find consolation in abusing the weather our American friends are combating the disease. The employment of sulphate of copper as a fungicide has long been known and successfully employed in France, and from there it passed to America. There Professor Scribner, whose researches in vegetable pathology have rendered his name famous, has found that sulphate of copper is one of the most effective fungicides that can be used. Experience has proved that this substance in varied modification of the Bordeaux mixture annihilates most, if not all, parasitical fungi. In France it has proved a specific for Vine mildews and the Potato disease, and in America for every kind of "rot;" but there is one kind of fruit it has not proved suitable for, and that is the British Apple. The chief difficulty up to three years ago was to find something strong enough to kill the *Cladosporium* without injury to the foliage of the Apple and Pear. That seems to have been found at last. Instead of using sulphate of copper, ammonical carbonate of copper solutions have been employed with considerable advantage.

Mr. B. T. Galloway, Chief of the Division of Vegetable Pathology, United States Department of Agriculture, Washington, D.C., in "The Canadian Horticulturist," vol. xiv., p. 144, gives the following on the "Treatment of Apple Scab."

"Apple scab can now be prevented so easily and cheaply that there is no longer any excuse for the injury it occasions. We first successfully treated this disease three years ago (1887), and since that time our methods of work have been considerably improved. Briefly the treatment we would now recommend is as follows:—

"When the fruit is about the size of a pea, spray the trees thoroughly with a solution made by dissolving 5 ozs. of carbonate of copper in 1½ pint of aqua ammonia, having a strength of 26°. The copper may be dissolved in an ordinary water-pail. When completely dissolved pour the liquid into a barrel, and then fill the latter with (50 gals.) water. A barrel of the solution made in this way will cost about 35 cents. (17½d.), and it will be sufficient to treat fifteen (thirty) large trees once. Make a second spraying twelve or fifteen days after the first,

and the third two weeks later. If an ordinary season three sprayings will be sufficient, but if raining it will be necessary to make one or two more. In applying the solution it is of the highest importance that the leaves and fruit be thoroughly covered, and this is only possible by using a good strong force pump, provided with a suitable spraying nozzle. Such a machine need not cost over 12 or 15 dols. (50s. to 62s. 6d.), and where one has a larger orchard this amount will be easily saved in a short time.

"The carbonate of copper is sold at retail for 40 cents. to 75 cents. (1s. 8d. to 3s. 1½d.) a pound. It can be made at home, however, much cheaper, the usual method of preparing it being as follows:—

"Dissolve 3 lbs. of sulphate of copper or bluestone in 5 or 6 gallons of hot water. In another vessel dissolve 3½ lbs. of sal (ball) soda in 6 gallons of hot water. When cool pour the soda solution into the copper liquid, stirring constantly the while. Allow the solution to stand twenty-four hours, then siphon or pour off the clear liquid, taking care not to disturb the sediment any more than is necessary. After the clear liquid has been removed add water, and stir up the sediment. Let the liquid stand another day, then draw off the clear liquid again. The sediment, which is carbonate of copper, may then be dried and used as already described."—G. ABBEY.

(To be continued.)



ORCHIDS ON TREE STEMS.

MR. L. CASTLE on page 428 draws attention to the charming effect produced by Orchids growing on stems of trees, and thinks that more of the kind might be seen. Probably he will be interested to learn that as far back as 1873 Peter Spence, Esq., Whalley Range, Manchester, had a large lean-to house 40 or 50 feet long and about 14 feet wide—I am writing entirely from memory as to dimensions, and subject to correction—filled with large boughs of Oak I think, and on which were planted hundreds of Brazilian Orchids, which his son had himself collected in Brazil and shipped home. The thick ends of the boughs were bedded in cement on the floor of the house, and the other ends attached to the roof. The floor was watertight and the sides slightly raised, so that in the growing season there was about an inch of water over the floor of the centre bed. A few Ferns were planted amongst the Orchids on the boughs and stumps, and the effect was at once weird and interesting. Considerable difficulty was experienced in keeping the young growths and flowers from being destroyed by the usual deprecators, the miniature forest of boughs giving them such good harbourage.

In September, 1872, my employer received an importation of Orchids from Dr. Ernest of Caracas; some of these, after being cleaned and hung up to the roof of a plant stove during the darkest part of the year, I on the 24th of the following January fixed on rustic Oak boughs, which I had previously charred and fixed from the coping of the bed in the stove up the roof. Amongst other Orchids that I fixed on these boughs were some good pieces of the miffy growing *Cattleya Acklandiae*. It was a treat to see these plants grow and root and flower; the position suited them perfectly. They were within about 18 inches of the glass, and the roots spread in all directions over the charred surface of the boughs.—HUGH DALE.

JOTTINGS.

A SALE of imported Orchids was rather hurriedly announced to take place on Monday last at Messrs. Protheroe & Morris's rooms in Cheapside, a number of plants collected by Mr. J. L. Osmer in the Dutch East Indies, having been brought over by himself. They included Vandas, *Cypripediums*, and *Grammatophyllums*, all believed to be new; and Mr. Osmer has had so much experience in collecting that his opinion ought to possess some value in this matter. One point was very evident—namely, the remarkably fine condition of the plants, and this, no doubt, helped the sale materially, as the results were very satisfactory.

The *Grammatophyllum* was described as "probably new, collector saw fifty-eight flowers on one spike. Sepals and petals golden yellow with dark purple spots, lip mauve and striped with purple." Dried flowers were shown but not in very good condition, though as far as could be judged the characters are quite distinct. Some thought it was the same or similar to *Grammatophyllum*

Measuresianum, certificated at the Temple Show recently; but a flower of this plant, now at Streatham, was sent for and compared with the new one, when it was at once seen that they were perfectly distinct, the spots being much smaller and more numerous in *G. Measuresianum*, while the colour is also probably different. The imported plants were very strong, great clumps of long, stout pseudo-bulbs being likely to make grand specimens.

The *Cypripedium*, which was said to have been "collected in an entirely new district," was described as possessing flowers with "the dorsal sepal white, with broad stripes; petals 5 inches long, of a violet purple and twisted, with eight heavy spots in the upper part of the petal; lip bright yellow." Opinions differed greatly respecting this plant, which in foliage and habit appears to be one of the *C. insigne* section; one authority, in fact, considers it to be *C. insigne siamense*, another thought it was in the way of *C. Roebelinii*, and several other conjectures were ventured, but the uncertainty did not affect the sale, and the little mystery about it perhaps imported a stimulus to the buyers.

The third introduction was a *Vanda*, of which some 400 plants were offered, including one fine specimen with five stems, clothed with leaves to the base, which was sold for 22 guineas. The collector described it as "very free flowering, the flowers being sweet scented, in long racemes, sepals and petals yellow with purplish spots, lip also yellow, the upper portion of the throat having fine violet purple stripes; twenty-eight flowers counted on one raceme." The leaves are narrow, somewhat short, and the plants are comparatively dwarf. It is suggestive of *Vanda limbata*, and several think that it may be a variety of that species, which is a Javan plant, described by Blume in the *Rumphia* in 1848. *Vanda limbata* has long been a rare plant, though it was introduced to England from Paris by the late Mr. B. S. Williams, and from those which subsequently flowered specimens were figured in "Select Orchidaceous Plants" and the "Botanical Magazine." Even if the imported plant should prove to be a distinct species it will probably be found to be a near relative of *V. limbata*.

An interesting sale will be held in the same rooms on Friday next, June 19th, when an excellent importation of *Cattleya Bowringiana* will be offered, together with *Dendrobium hybridum Venus*, recently figured in this Journal, the handsome *Phaius Cooksoni*, the pretty hybrid *Dendrobium Cassiope*, *Vanda Sanderiana*, *Odontoglossum hastilabium*, with several *Cattleyas* and other plants of special interest.—L. CASTLE.

NOTES ON RHUBARB.

SOME persons consider Rhubarb as something only a little less than poisonous because of the oxalic acid it contains; others consider it wholesome, if not nutritious. It is certainly agreeable to a vast number of consumers, and is probably on the whole, and as prepared for use much more beneficial than injurious. Professor Church says "The food value of this vegetable is very small, and it is esteemed mainly for its pleasant flavour, which is due to a trace of some volatile matter too small to be identified, along with a little Grape sugar and the acidulous compound acid oxalate of potash." This is embodied in the term oxalic acid, of which a "sample of fresh stalks yielded on analysis 0.3 in 100 parts, and 2.1 of sugar (glucose) and gum. It contained 95 per cent. of water." Different varieties vary, no doubt, in the relative proportions of those and one or two other minor constituents, one variety not in general cultivation requiring only a small quantity of sugar to make it not only palatable but enjoyable.

Rhubarb, judging by the great demand for it, may fairly be regarded as a distinctly useful vegetable, and meets a public want between the Apple and Gooseberry seasons. Hundreds of tons are forced yearly both with fermenting material and fire heat, the latter method of production having developed into a great industry in the neighbourhood of Leeds. In 1888 a Suffolk vicar thought he had discovered a Rhubarb that, to speak paradoxically, could be forced by cold—at least he has emphasised his statement in italics that "*cold suits it, and the severer the winter the earlier the Rhubarb.*" He has found out his mistake of course, for he did not gather stalks for use this year till the 5th of March; but in 1888 he gathered on Valentine's Day. The late prolonged and severe winter, therefore, instead of sustaining the new and peculiar theory retarded the growth for about three weeks. In one sense cold does affect and appears to promote the growth of Rhubarb, for experience proves that to obtain the best crops at the earliest date it is a good plan to dig up the roots and leave them exposed till a brisk frost occurs and puts them, if only for a short time, completely to rest. That is the system pursued where Rhubarb is forced on a very large scale by fire heat for markets, and in a few gardens on a small scale for

private use. But the influence of cold in this case is similar to that of sleep on individuals. After a sound, if short night's rest, they move more briskly in the morning than if they had been kept moving, however slowly, all night. Cold arrests growth, warmth excites it, and the warmth of spring must follow the severity of winter before Rhubarb can grow in Suffolk or elsewhere, and regardless of variety.

When the Rev. W. H. Sewell sought to benefit the public by offering roots of his Rhubarb at 7s. 6d. and 15s. each, according to size, a desire was felt to become acquainted with the variety, and if it was found to possess distinct advantages to aid in its distribution. A close examination of the samples, however, led us to suspect our correspondent was deceived, and that his Rhubarb was a very old variety which has been extensively grown for market at least fifty years, and probably much longer. With the object of ascertaining the truth on the subject, which it was naturally thought the Vicar would be glad to ascertain, we suggested that specimens be sent to the Fruit and Vegetable Committee of the Royal Horticultural Society at the then pending meeting on July 10th, to be examined with others from Chiswick by the experienced members of that Committee. To our surprise this offer was refused, on the ground that "no grower of sound judgment would think of exhibiting a vegetable in use in the spring after Midsummer Day;" yet the grower of the self-same vegetable, and in the very next sentence, invited us to commission someone to "inspect it in his garden, describe it, sketch it or photograph it." We could not see that if it was the wrong time for showing it to a committee it was the right time for figuring it. If it was in the wrong condition for one purpose it was wrong for the other, and if it was right for one it was right for both. It was really, as all practical men know, the time when the characters of Rhubarb were developed. Yet the Vicar declined to have his Rhubarb tested in that fair way.

We then suggested that a root be sent to Chiswick on the understanding that roots of the same size and character should be taken up from the collection and planted with it, so that the trial should be absolutely fair. This was declined. It would only be sent on condition that it was to be planted and treated in a special and fanciful manner prescribed by the Vicar. That obviously is not the way that impartial trials are conducted in an experimental garden under competent and unprejudiced superintendence, and the root was not sent. Yet, in a letter before us written during the past month, and a very remarkable letter it is, as will be conceded, Mr. Sewell says, "The Horticultural Society write, as it seems to me, angrily and not fairly in their last journal about not sending them my Rhubarb for them for trial. I was quite willing to do so. It was entirely their own fault that I did not. I do not now, perhaps, much regret the circumstance; for if Mr. Barron could not separate stems of one dwarf kind called Early Red from another dwarf kind certainly not red but an earlier kind, which is pink, how can I place much confidence in his opinion as to accept it without hesitation?"

In the first place, as we have previously said, and now repeat, no official of the Royal Horticultural Society has written a line about the Vicar's Rhubarb, neither in their own *Journal* nor in the *Journal of Horticulture*, and in the next place we note the writer of the letter does "not regret" that he did not send Rhubarb from his garden to be fairly tested at Chiswick. The reflections on Mr. Barron, who has tried dozens of varieties and alleged varieties of Rhubarb over dozens of years by a gentleman who has only tested the old variety in his garden with Johnston's St. Martin's is noteworthy, and Mr. Barron will not in the least mind the suggestion that he "could not separate stems of the Early Red from stems of another not red," because they were all exactly alike in colour, shape, texture, quality, earliness, and every other point. That was not Mr. Barron's "opinion" alone, but the decision of others who examined them, and whose experience with Rhubarb is much greater than that to which the Vicar of Yaxley can have any possible claim. His 7s. 6d. and 15s. roots of Rhubarb are of the Early Red of the London market gardens, and sold by nurserymen at ordinary market prices, either under that name or Prince Albert, Early Albert, or Royal Albert. Mr. Pownall has proved the identity by growing samples direct from the Vicar's garden and direct from Chiswick, and if Mr. Sewell does not accept the verdict the public will, and he has henceforth no more right to sell his Rhubarb as a distinct variety under another name at an exorbitant price than we have to take down his sermons and sell them as our own, and especially at 500 per cent. and more above their market value, good as they may be. It may be added that the prices mentioned are taken from a printed leaflet issued by Mr. Sewell, and sent to us by a correspondent who has found out that the Rhubarb offered is not distinct. The practice of giving new names to old varieties of anything and charging higher prices for them, has been too common in past times, though in many cases,

including the present one, the vendors were fully convinced that they had something really new and distinct to offer, and when men of high principle discover that they have been misled they are only too glad the mistake has been discovered, and it is no longer perpetuated.

As confusion exists respecting the nomenclature of Rhubarb, and as a good deal of interest has of late been apparent in this useful garden crop, a description of some of the varieties grown at Chiswick will not be unacceptable. The essential characters of the plants were noted when the flower heads were advanced on May 6th, and therefore all the parts fairly developed. The varieties are alluded to in their order in the trial now.

PARAGON.—Habit of plant upright; stalks 18 inches long by 1½ inch wide; flat, or slightly concave, outside slightly fluted; colour dark dull red, flesh greenish; leaves small, pointed deep green, the whole plant having a bronzy metallic hue; no flowers. This was one of the earliest varieties during the spring, and is distinct and of good quality.

HAWKES' CHAMPAGNE.—Habit compact; stalks 18 inches long by 1¼ inch wide, flattish, strongly concave, and slightly fluted at the back; colour dull red and flesh slightly red; leaves medium, broad undulated, covered with fine white hairs (having the appearance of faint mildew), which extend partly down the stalks; flower stems numerous and advanced. A first early variety, distinct, and of excellent quality.

EARLY RED.—Habit compact; plant proliferous, producing many crowns; stalks 18 inches long by 1 inch wide, with very sharp edges, inner surface slightly concave, outer somewhat fluted; colour rosy pink at the base, greening upwards; leaves small, bright glossy green; flower stems abundant and early. A popular first early variety, pink when young and very tender. This Rhubarb has many synonyms, as good things often have, one of the latest being the Yaxley.

DANCER'S EARLY RED.—Small, coarse, woolly, very much resembling a wilding, and of no value; colour dark red.

TOBOLSK.—Grown also under the names of Buck's Early Red and Early Crimson; stalks 14 inches long by ¾ inch wide, slightly concave, with sharp edges, very convex, and faintly ribbed; colour dark crimson right through; leaves small, undulated, hirsute, as is the upper part of the stalk; flower heads sparse, quite red, and ornamental. A sample of "Handy Andy's" Tobolsk, as received from Mr. Pownall, differs considerably, neither of them appearing to possess any marked value.

LINNÆUS.—Grown also as Johnston's St. Martin's, Buckley's Crimson, and New Emperor. Habit strong and spreading; stalk 16 inches long by 1 inch wide, inside flat, outside distinctly convex, and slightly fluted, a full firm stalk; colour pale red at the base, green upwards; leaves large, smooth, light green. A productive and useful variety, a little later than Early Red.

HARRISON'S SEEDLING.—Habit vigorous; stalks 20 inches long by 1¼ wide, distinctly concave, outside slightly fluted; colour, lower half bright red, upper half greenish; flesh green and firm; leaves medium, deep green, much undulated, forming curls round the edges by the incurving of the points; flower heads late. A productive and distinct midseason variety.

CRIMSON PERFECTION.—Habit spreading; stalks 18 inches long by ¼ wide, firm, flat, or a little concave, outside faintly fluted; colour dark crimson; leaves, medium, deep green, hoary, no flowers; darker and later than Hawkes' champagne, but not so good in quality. An improvement on Tobolsk.

VICTORIA.—Habit robust; stalks 18 inches long by 1½ wide, full, inside slightly concave, outside strongly fluted; colour rosy crimson, flesh whitish; leaves large, cordate, stout in texture, dark glaucous green, and slightly hoary. One of the most productive and serviceable for midseason and late use. It is the famous "Pink Rhubarb," forced so extensively near Leeds for the London and other markets, succeeding the smaller and earlier sorts.

CONQUEROR (New).—One of Mr. Laxton's seedlings. Habit robust, upright; stalks 22 inches long by 1¾ inch wide, deeply concave with rounded edges, outside nearly smooth; colour deep crimson; leaves very large, stout, dark glaucous green, and slightly heavy. A noble Rhubarb, but how far its strength may be due to the vigour of youth remains to be proved. It is of the Victoria type, and the only real rival of that famous variety during its period of use.

Only four varieties were cooked for comparison—the Early Red, Paragon, Hawkes' Champagne, and a small scarlet Rhubarb received from a Lincolnshire rector. The Tobolsk varieties and Dancer's Early Red are known to be inferior, while the qualities of Linnæus and its varieties, also Victoria, are generally known to be good. Early Red proved the most tender of all, green, very juicy, and of good flavour, just the same as the Yaxley Vicar's when cooked; Paragon was firmer, slightly coloured, and very good. Hawkes' Champagne was pink when cooked, with a piquant, plea-

sant flavour ; but the Lincolnshire rector's Rhubarb far outdistanced all in colour and sweetness. Mr. Barron would like to try this at Chiswick, and Mr. Pownall, who has had a taste of the bright little stalks, will not be happy till he is the proud possessor of a crown.

WAKEFIELD TULIP SOCIETY.

THE annual Show of this venerable Society was held on Monday and Tuesday, June 8th and 9th, at the Brunswick Hotel. It was the fifty-sixth recorded occasion on which the members have met in friendly rivalry. Fifty-six years may appear a ripe old age in the life history of such organisations, but in this case there are good and substantial reasons for believing that the Society has a far longer record, and that it was in active operation, and by its shows promoting the spread of the "fancy" a full generation prior to 1835.

With such a pedigree it is always expected that the annual competitions will produce something to cheer the heart of the florist. This year, we are sorry to say, these expectations were somewhat disappointed, for the exceptional season through which we have just past had left its mark on many of the flowers, a large proportion were not properly open, and some not at all, although the Show had been adjourned for a week. The effects of Whit-Sunday's frost were manifested in the green tipped petals, bad form, and irregularity of colour seen in some of the flowers.

Taking the Show as a whole, it was undoubtedly inferior to many of its predecessors, whilst here and there were to be seen blooms which were decidedly good—notably, four out of the winning stand of six shown by Mr. W. Mellor—viz., Sir Joseph Paxton, a beautiful flamed flower which obtained premier honours in its class ; Queen of England, a grand rose break, though somewhat lacking in depth of colour ; Lord F. Cavendish, another capital break which was awarded the premier position as a feathered flower ; Violet Aimable, feathered bizarre, fairly good. In the breeder class Mr. Moorhouse gained the highest position with Alice Gray. About 1000 blooms in all were staged, and some good British Ferns arranged down the centre of the table relieved the somewhat vivid display of colour.

Mr. Edwin Schofield of Leeds ably fulfilled the responsible duties of Judge, and Mr. Garnett of Wakefield adjudicated in respect of the firms. There was a large attendance of the general public, who freely availed themselves of the privilege of free admission. Appended is a list of the prizewinners.

Six rectified flowers.—First, Mr. Wm. Mellor with the varieties described above. Second, Mr. Edwin Lister with Sir Joseph Paxton, Lord F. Cavendish, Beauty of Brighouse, Bessie, Mabel, Industry. Third, Mr. George Gill with Sir Joseph Paxton, Masterpiece, Lord Denman, Bessie, Baroness Burdett Coutts, Modesty. Fourth, Mr. Alfred Moorhouse with Sir Joseph Paxton, Masterpiece, Unknown, Bessie, Triomphe Royal, and Heroine. Fifth, Mr. Henry Brown with Sir Joseph Paxton (2), Lord Denman, Isabella, Aglaia, and Mabel. Sixth, Mr. Jesse Hardwick with Masterpiece (2), Lord Denman, Mrs. Gill, Crown Prince, and Modesty. Seventh, Mr. Wm. Calvert with John Brook (2), Lord Denman, Majestic, Aglaia, and Industry.

Six breeders.—First, Mr. Wm. Mellor with James Goodhair, Sir Joseph Paxton, Leech, Sarah, Duchess of Sutherland, Baroness Burdett Coutts, and Annie McGregor. Second, Mr. Alfred Moorhouse with Sir Joseph Paxton, Dr. Hardy, Alice Gray, Talisman, Mrs. Barlow, and Baroness Burdett Coutts. Third, Mr. George Gill with Charles Darwin, Talisman, James Goodhair, Mary E. Fawcett, Baroness Burdett Coutts, and Mabel. Fourth, Mr. Edwin Lister with Sir Joseph Paxton, Unknown, Beauty of Brighouse, Adonis, Mabel, and Baroness Burdett Coutts. Fifth, Mr. William Calvert with W. King, Sir Joseph Paxton, Maid of Orleans, Leech, Sarah, Industry, and Mabel. Sixth, Mr. H. Brown with Lord F. Cavendish, John Brook, Maid of Orleans, Adonis, Catherine, and Industry.

Pan of three breeders.—First, Mr. Wm. Mellor with Sir Joseph Paxton, Alice Gray, and Baroness Burdett Coutts. Second, Mr. A. Moorhouse with Sir Joseph Paxton, Alice Gray, and Mrs. Barlow. Third, Mr. E. Lister with Sir Joseph Paxton, Silvester, and Mabel. Fourth, Mr. Geo. Gill with Charles Darwin, Talisman, and Baroness Burdett Coutts. Fifth, Mr. J. Hardwick with Lord F. Cavendish, Beauty of Brighouse, and Queen of England. Sixth, Mr. Wm. Calvert with Hepworth, Adonis, and Industry.

Flamed bizarres.—Mr. Moorhouse first, Mr. Calvert second, Mr. Gill third, Mr. Gill fourth, Mr. Calvert fifth, Mr. Moorhouse sixth, Mr. Mellor seventh, and Mr. Hardwick eighth, all with Sir Joseph Paxton.

Flamed byblœmens.—Mr. Gill first and third ; Mr. Moorhouse second with Talisman, fourth with Hepworth ; Mr. Mellor fifth ; Mr. Brown sixth and seventh with Lord Denman ; and Mr. Calvert eighth with Midland Beauty.

Flamed roses.—Mr. Moorhouse first with Mabel, and second with Lady C. Gordon ; Mr. Lister third with Norah Darling, fourth with Mabel ; Mr. Gill fourth with Mabel, Mr. Brown sixth with Aglaia, Mr. Gill seventh with Mabel, and Mr. Brown eighth with Aglaia.

Feathered bizarres.—First, Mr. Gill with Garibaldi. Second, Mr. Mellor with Lord F. Cavendish. Third, Mr. Moorhouse with Masterpiece. Fourth, Mr. Lister with Lord F. Cavendish. Fifth, Mr. Hardwick with J. Brook. Sixth, Mr. Mellor with Lord F. Cavendish. Seventh, Mr. Calvert with Sir Joseph Paxton. Eighth, Mr. Moorhouse with Masterpiece.

Feathered byblœmens.—First, Mr. Gill with Mrs. Hepworth. Second, Mr. Gill with Lady Denman. Third, Mr. Lister with Grace Darling. Fourth, Mr. Calvert with Majestic. Fifth, Mr. Lister with

Lady Denman. Sixth, Mr. Moorhouse with Adonis. Seventh, Mr. Calvert with Isabella. Eighth, Mr. Moorhouse with Talisman.

Feathered roses.—First and second, Mr. Gill with Modesty. Third, Mr. Mellor with Mrs. Lea. Fourth, Mr. Lister with Industry. Fifth and sixth, Mr. Calvert with Modesty. Seventh, Mr. Lister with Annie McGregor. Eighth, Mr. Moorhouse with Industry.

Bizarre breeders.—First and third, Mr. Gill with James Goodhair. Second and fourth, Mr. Mellor with Wilkinson's King and Hardy No. 9. Fifth, Mr. Brown with Lord F. Cavendish. Sixth, Mr. Moorhouse with Dr. Hardy. Seventh, Mr. Moorhouse with Dr. Dalton. Eighth, Mr. Hardwick with Sulphur.

Byblœmen breeders.—First, Mr. Gill with Ethel. Second, Mr. Moorhouse with Leech Sarah. Third, Mr. Mellor with Duchess of Sutherland. Fourth, Mr. Moorhouse with Alice Gray. Fifth, Mr. Mellor with Duchess of Sutherland. Sixth, Mr. Lister with Queen of May. Seventh, Mr. Gill with Ethel. Eighth, Mr. Hardwick with Talisman.

Rose breeders.—First, Mr. Gill with Annie McGregor. Second, Mr. Mellor with Industry. Third, Mr. Mellor with Mrs. Barlow. Fourth, Mr. Moorhouse with Annie McGregor. Fifth, Mr. Lister with Mrs. Barlow. Sixth, Mr. Gill with Baroness Burdett Coutts. Seventh, Mr. Calvert with Apollo. Eighth, Mr. Lister with Mabel.

Premier flamed Tulip.—Sir J. Paxton from Mr. Mellor. Premier feathered Tulip.—Lord F. Cavendish also from Mr. Mellor. The premier breeder was Alice Gray from Mr. Moorhouse.

A DELICATE DAFFODIL.

ALL the varieties of Daffodils included in the group or section designated Leeds are elegant in form and delicate in colour, but one of

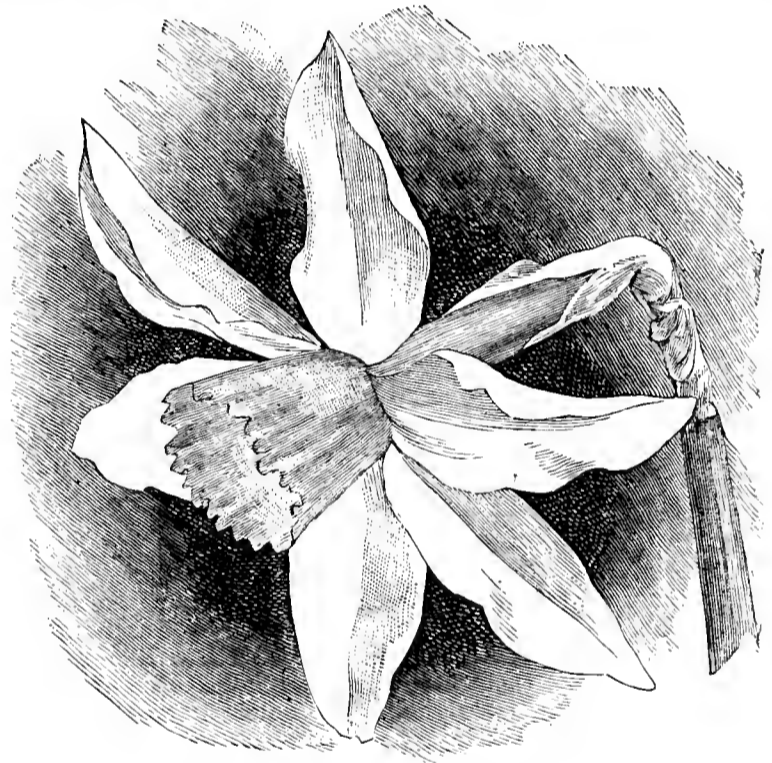

FIG. 94.—NARCISSUS LEEDSI BEATRICE.

the best in these respects is that of which a flower is represented in fig. 94—i.e., *Narcissus Leeds Beatrice*. In the varieties of this type white sepals are usually accompanied by a pale creamy yellow corona ; the flower too is of moderate size, light looking, and gracefully poised on the slender scape.

Mr J. G. Baker gives the following description of the type in his "Handbook of Amaryllideæ :"—"Leaf twisted, canaliculate, glaucous, $\frac{1}{2}$ in. broad. Peduncle two-edged, longer than the leaf. Flower single, horizontal or rather drooping. Perianth-tube, subcylindrical, $\frac{3}{4}$ in. long ; segment spreading, oblong, acute, milk-white, $1\frac{1}{4}$ in. long, $\frac{1}{2}$ - $\frac{3}{4}$ in. broad ; corona cup-shaped, sulphur-yellow, $\frac{1}{2}$ in. long, $\frac{1}{2}$ in. diameter at the erect irregularly crenate plicate throat. Style reaching nearly to the throat of the corona, overtopping the anthers. Intermediate between *poculiformis* and *incomparabilis*. About fifty forms are distinguished by name by cultivators."

ROYAL HORTICULTURAL SOCIETY.

JUNE 9TH.

SCIENTIFIC COMMITTEE.—Present : Mr. Morris in the chair ; Mr. McLachlan, Dr. Müller, Professor Church, Dr. Bonavia, Mr. Blandford, Rev. C. W. Dod, Rev. W. Wilks, Rev. G. Henslow, Hon. Sec.

Vine Branch Grown in Darkness.—With reference to the specimen exhibited at a previous meeting, Mr. Rivers contributed the following additional information accompanied by sketches :—"The situation is absolutely dark ; first, there is a covering of slates overlapping each other, above which is a bed of tan 6 inches deep ; the front wall and the back is of brick ; the temperature must be very high, as the hot-water pipes pass through the place, that of the house being seldom below 70° F. The house was cleared of Grapes and plants by the middle of July, and the heat taken off. It was then undisturbed until March, when the slates

and beds were cleared preparatory to a new crop. The branch was then discovered, its length being about 12 feet. It had, therefore, been about nine months without heat; during part of the time a severe frost had lasted. The leaves and bunch of Grapes were of the colour of a well-blanching Lettuce. It is impossible to say how long the branch was forming. I did not see any seeds in the fruit."

A discussion arose as to the degree of perfection to which flowers can attain when grown in total darkness. Mr. McLachlan, for example, found a Hyacinth, which by accident could not emerge from the ground, to be rose-coloured. Mr. Smee on a former occasion exhibited a dark purple Hyacinth which had developed underground beneath a slate. Many other instances are known. The Committee expressed a wish to receive descriptions of any cases of plants developing in darkness which correspondents may be able to furnish.

Excrescences on Willows.—Mr. Blandford had examined sections of the specimens brought to the last meeting. The woody tissue was very dense, and indicated no clear evidence of insect origin. He suggested that there might have been an old gall, and that the tissues continued to hypertrophy after the escape of the insect, possibly a cryptocampus or sawfly. The wood was referred to Professor H. Marshall Ward for an examination of the tissues.

Staves Perforated.—Mr. Blandford observed that the insect officially reported by the India Office as taken from the barrels, and supposed to be the wood-borer, as mentioned at the last meeting, proved not to be the case. The staves are really perforated by *Xyleborus perforans*, an insect well known since 1855, and detected as perforating Sugar Canes in St. Vincent in 1867. He proposed making further investigations. Mr. McLachlan remarked that the original home of this insect was Central and South America, that it was exported to Madeira, and thence to India. Mr. Morris observed that the distribution also agreed with exportation of the Sugar Cane.

Injuries to the Cocoa Tree, Theobroma cacao.—Mr. Morris remarked upon the presence of *Styrastina depressa* infesting Cocoa trees in Grenada, that it is not a native of the West Indies, but introduced from S. America. At the Jamaica Exhibition Cocoa from Surinam, together with insects injurious to it, were shown. Hence it was undoubtedly introduced into the West Indies along with the Cocoa.

Kampferia, Tuberos Roots.—Prof. Church had examined the tuberos roots, exhibited at a previous meeting by Mr. Morris, which are used as food in Trinidad and Dominica. He found that they contained very little starch, but a relatively large amount of gummy matter, which possessed a strong left-handed rotation, being apparently, therefore, of the levulose group. He remarked that it rapidly absorbed iodine, which became quite colourless, so that it was difficult to detect the starch unless a considerable quantity of iodine was present. These roots, therefore, would seem to have a composition closely resembling the tubers of *Stachys tuberosa*.

Papaver pilosum (?)—Rev. C. W. Dod exhibited a Poppy with orange-coloured flowers, about which some doubt was raised as to its identity. It was referred to Kew.

Apple Twigs Injured.—Mr. Lec of Clevedon sent a number of twigs "ringed" in places. Generally the ringing had taken place at the buds. It was suggested to have been done by bullfinches rather than sparrows, as Mr. Lee intimated. It was observed by Mr. Blandford that hymenopterous insects not unfrequently produce a like result when collecting materials for their nests, as—e.g., hornets on Ash trees. It was suggested that the trees should be searched for the presence of insects at the time when the injury was done.

Hippeastrum Diseased.—Mr. Morris exhibited bulbs with leaves covered with red spots and blotches. They were received from Mr. J. Douglas of Ilford. The bulbs were reddish coloured, and the leaves died off prematurely. It was thought to be due to *Saccharomyces glutinis* (described and figured in the *Gardeners' Chronicle*, 1886, p. 396). It was referred to Prof. H. M. Ward for further examination and report.

LILIUM GIGANTEUM AT HADDON HILL.

A NUMBER of the members of the Bournemouth and District Gardeners' Mutual Improvement Association, at the invitation of the Rev. F. Hopkins, Vicar of Holdenhurst, paid a visit to his residence, Haddon Hill, near Christchurch, to see the *Lilium giganteum* as grown in pots by his gardener, Mr. W. Osborne, who is a very successful cultivator of this noble Lily. Mr. Osborne has the plants in all stages of growth, from the sucker to the flowering bulb. The specimen in flower (of which I enclose a photograph) is a grand example of cultivation. There were three bulbs in a 3-inch pot with three spikes nearly 9 feet high, exclusive of the pot, and carrying twenty-seven blooms. Several other specimens were in the conservatory, and showing strong spikes, which gave promise of being very fine. Mr. Osborne informed us that it took from four to six years to grow them from the sucker to the flowering stage, but having them in various stages he is able to have flowering bulbs every year.

The conservatory also contained some well-grown and freely flowered plants of *Pelargoniums*, *Roses*, *Azaleas*, &c., also some fine *Palms*. The pleasure grounds contained some good specimen *Coniferæ* from 40 to 60 feet high, which were planted by Mr. Osborne twenty years ago. *Rhododendrons* and other American plants are at home in this favoured spot, and made the shrubberies look gay with their flowers. A feature in the woodland walks is an edging of seedling *Rhododendrons* which were self-sown. They are cut to 12 to 15 inches high, and form a splendid edging to the paths. In the kitchen garden the crops looked

very promising considering the late unfavourable spring, and there was a splendid set of fruit on the Apples and Pears, the frost having done no harm, Mr. Osborne informed us. (Happy man, while so many of his brethren are lamenting the damage done to the fruit crops at Whitsuntide.) In the Peach house and vinery there were good crops of fruit, and the stove contained a collection of useful plants. The members were highly pleased with their visit, and especially in having the opportunity of seeing *Lilium giganteum* in flower.—S. B. J.

[The photograph is an excellent one, and the plant is very similar to that represented in one received some time ago.]

ROYAL BOTANIC SOCIETY.

JUNE 17TH.

LOVELY early summer weather favoured the June Show of the Royal Botanic Society this year, a bright sun making the surroundings cheerful and enjoyable. The Exhibition was hardly so densely crowded with good things as on some previous occasions, but it was eminently attractive, and there are few places where plants and flowers are arranged to such advantage as on the banks and mounds adjoining the conservatory in the Society's pleasant gardens at Regent's Park. There was an excellent attendance of visitors. Nothing further than an indication of the general character of the Show can be given in a necessarily brief and hastily prepared report, and reference to the new-plant honours must be deferred.

Pelargoniums are invariably well shown at the Botanic; this year was no exception. Mr. Phillips, Langley Broom, Slough, won with six *Fancies* and also with six Shows, both lots being finely flowered plants. Mr. Turner of Slough was first with both Shows and *Fancies* in the trade classes, exhibiting some grand plants, and Mr. Wiggins, manager to Mr. Baldwin, Hillingdon Heath, was second. Messrs. Phillips and Eason were successful with *Zonals*.

Stove and greenhouse plants were good, but not the feature they used to be a few years ago. Mr. J. T. Mould, Pewsey, won with both twelve and six plants in the nurserymen's classes, his best plants being *Statice profusa*, *Dracophyllum gracile*, *Erica aristella*, *E. ventricosa* *Bothwelliana*, and *E. ventricosa* *superba*, but all were healthy and well bloomed. Mr. H. James, Castle Nursery, West Norwood, was second in each case. Mr. Offer, gardener to J. Warren, Esq., Handcross Park, Crawley, was an easy first in the amateurs' class, Mr. H. Eason following, and Mr. Offer also showed some grand fine-foilage plants, Mr. R. Butler coming second. Mr. James won with these in the other section, Mr. Mould coming third; second prize withheld. Mr. Eason was first with *Fuchsias*. *Coleuses* were moderate, Mr. Eason being first; second withheld, and Mr. Butler third. Mr. Offer, as might have been expected, scored with variegated leaved plants, but Mr. Eason was close behind and showed most creditably.

Mr. James won with *Nepenthes* and *Sarracenias*, a capital lot of plants, and another South London firm, Messrs. Peed & Sons, Roupell Park Nurseries, Norwood Road, had a beautifully clear and healthy lot of plants. Mr. Offer's Ferns, though much crowded in a corner, were of sufficient individual merit to secure him the first prize. Messrs. J. Douglas and R. Butler were second and third. Messrs. Paul & Son of Cheshunt were unopposed with herbaceous flowers. Mr. Jas. Douglas won with a collection of Orchids, a bright, free and tastefully blended display of healthy plants, and Mr. James occupied a corresponding position in the trade section.

There was not a very extensive display of *Roses*, and at so early a period of the season it could hardly be looked for. The principal prize-winners were Messrs. Robins, Osman, Mount (with a neat box of *The Bride* and a good stand of scented varieties), and Rumsey, Waltham Cross, who had a capital dozen of *Niphetos*. The other cut flowers were bright and interesting, comprising Orchids, *Pelargoniums*, and stove and greenhouse plants. Messrs. Douglas and James won with the first and last; Mr. Turner, Mr. Phillips, Mr. Eason, and Mr. Douglas being successful with *Pelargoniums*.

Fruit is invariably a great feature of this Exhibition, but on the present occasion there appeared to be a falling off both as respects quantity and quality, still there was much that was worthy of comment. Mr. J. Edmonds, The Gardens, Bestwood, Nottingham, who has shown successfully before, was awarded the first prize. His Grapes were but moderate, the bunches being small and rubbed. Best of All and Blenheim Orange Melons were fairly good, as were the Peaches (*Hale's Early*), Strawberries (*Sir Harry* and *La Grosse Sucrée*), Fig (*Brown Turkey*), and Pine. Mr. W. Robins, gardener to Colonel Lec, Hartwell House, Aylesbury, was second. His Grapes were weak, Foster's Seedling being the best, and his Pine very poor. The Melons were fair, the Peaches and Nectarines good. Mr. Osman, gardener to L. J. Baker, Esq., Ottershaw Park, Chertsey, a very successful exhibitor of fruit, won with a basket of black Grapes, the variety being *Black Hamburg* in very good condition. Mr. Ocock, gardener to Mrs. McIntosh, Havering Park, Romford, was second with good clusters of *Black Hamburg*, but imperfectly coloured and somewhat rubbed; Mr. Douglas being third with the same variety. Mr. Grindrod, Whitfield Gardens, Hereford, had the best basket of a white variety, being represented by *Muscat of Alexandria* in fair condition. Mr. Smith, gardener to G. Sewell, Esq., Warren Hill, Loughton, was second with Foster's Seedling; and Mr. Robins third with the same variety. Mr. Osman won with three bunches of *Black Hamburg*, medium sized, well coloured, and carrying

a good bloom. Mr. Clinging, gardener to W. Greenwell, Esq., Marden Park, Caterham Valley, was second, and Mr. Ocock third, there being five other lots. Mr. Smith won in the other black variety class, showing Gros Maroe, moderate bunches, somewhat rubbed. Mr. Robins was second with Black Prince; and Mr. W. Whiteley, Hillingdon Nurseries, Uxbridge, third with Madresfield Court, the bunches having been cut from Vines inserted as eyes in February of last year. Mr. A. Smith was first with Muscats, showing bunches of medium quality, Mr. J. Crawford, The Gardens, Coddington Hall, Newark, being second, and Mr. Whiteley third. There were four other exhibitors in this class. Mr. Osman won with any other white, capital clusters of Buckland Sweet-water; Mr. Crawford was second with very good examples of Foster's Seedling; and Mr. Clinging third with large bunches of Foster's Seedling, small in berry.

Mr. W. Robins won with two dishes of Peaches, good lots of Grosse Mignonne and Alexander. Mr. Hicks, The Gardens, Pain's Hill Park, Cobham, was second, and Mr. Hare, Wellingore Gardens, Grantham, third. Mr. Douglas had some capital Nectarines, and won from Mr. Crawford and Mr. Hare. Mr. Divers, gardener to J. T. Hopwood, Esq., Ketton, Stamford, had the two best dishes of Strawberries, Noble and Auguste Nicaise, both excellent, and Mr. Hare was second with President and Sir Joseph Paxton. Mr. Crawford won with Figs and Mr. Hare with Cherries, while the Tomato prizes went to Mr. Whiteley for Hackwood Park, and Mr. Crawford.

The miscellaneous exhibits, for which various medals were awarded, were as usual of a very attractive and diversified character. Various groups were arranged upon the banks, and presented a splendid effect. Messrs. W. Paul & Son, Waltham Cross, had a beautiful display, composed chiefly of Roses and Rhododendrons, but with a good sprinkling of shrubs and herbaceous plants. Messrs. W. Cutbush & Son were represented by a group of greenhouse and stove plants admirably arranged. Messrs. B. S. Williams & Son had a fine bank of Orchids interspersed with Ferns and foliage plants, which was much admired. From Messrs. Sander's great establishment came some of his choice Orchids, including the lovely Phaius Humbloti, and some charming varieties of *Miltonia vexillaria*. Messrs. J. Laing & Sons had a large and well assorted group of indoor plants, in which Begonias played an important part. Messrs. Kelway & Son had a magnificent display of single and double Pyrethrums, single and double Paeonies, Irises, Delphiniums, and other hardy plants, unquestionably one of the best they have ever put together. Messrs. Carter & Co. had a charming display of Gloxinias and an interesting collection of Cactuses, which they are now pushing into prominence. Messrs. Collins Brothers and Gabriel had a most extensive exhibit of Pyrethrums, stretching more than half the length of the conservatory. Mr. T. S. Ware had one of his well-known groups of hardy flowers, comprising a great diversity of material. Messrs. J. Veitch & Sons had an admirable collection of Rhododendrons and a miscellaneous display of hardy flowers, with a charming lot of Ixias. Messrs. Paul & Son of Cheshunt had one of the most beautiful groups in the Show, consisting of Roses, Rhododendrons, and other cut flowers, hardy plants and shrubs, most artistically grouped. Messrs. Hugh Low & Son had a charming bank of Orchids, and other stove and greenhouse plants. Mr. J. F. Mould had a group of Ericas and Carnation Pride of Penhurst. Mr. W. Rumsey had a bright display of Roses, and Messrs. Dobbie & Co. of Rothesay a lovely collection of Pansies and Violas, which they grow largely and well. From Messrs. Barr & Son came some 70 yards of Irises and various herbaceous flowers, a most attractive collection.



HARDY FRUIT GARDEN.

NETTING STRAWBERRIES.—Attend to this as soon as the various kinds are ready; it is better to be a day too early with this rather than wait until the birds have commenced operations, as the finest fruits colour first and the birds have keen eyes for them. Where this fruit is grown in beds instead of single rows raise the nets about 4 feet above the plants to allow the person in charge to walk beneath without removing the nets. This is easily accomplished by inserting stakes of the necessary length at 10 feet apart all over the bed, keeping the outer ones parallel with the outer rows of plants. In order to prevent the nets slipping down the stakes a piece of hayband or similar material may be tied round the stakes at the top to make a good sized knob on which the net will rest. If this is kept level with the top of the stake it is easy to tighten the nets all ways across the beds and to peg them out at the bottom so as to clear the outside plants. A man can then walk underneath and gather the fruit without unfastening the nets. The above system requires rather more net than the ordinary plan, but there is not so much difference as might be expected, because the nets can be pulled tighter, and any excess in this matter is more than compensated for by the greater convenience and the better protection from the birds, which cannot sit on the nets and reach the fruit.

FRUIT FOR EXHIBITION.—Supply liquid manure until the Straw-

berries commence colouring, and must be staked up clear of the ground if there is any danger of slugs attacking them. Laxton's Noble is one of the finest varieties for show, as it swells to a large size, and assumes an excellent colour. British Queen when in good condition will carry more weight than any other kind on account of its excellent flavour, but it is very uncertain. Sir Charles Napier makes a fine show variety in a warm season. Waterloo is one of the finest late varieties, good in flavour, very large, and of first-rate appearance, but a poor cropper in some soils. In order to give every advantage possible the fruit should be kept clear of the foliage, and all small fruits must be removed. In very hot weather sun scorching must be guarded against.

PEACHES AND NECTARINES.—These require attention now to keep all growths stopped which are not needed for furnishing the tree with bearing wood for next season. The fruits also should be thinned to the proper distance, leaving those preferably which stand out from the wall and are not placed near the forks of the branches or any similar position where they would be likely to be wedged and bruised. One fruit to each square foot of surface is ample for a crop, one fair-sized Peach of good flavour being far more satisfactory than two smaller ones that are almost flavourless or bitter. Overcropping also tells seriously on the health of the trees and on the following season's crop. Nectarines may be left at 9 inches apart each way, as they do not grow so large as Peaches. Where any danger of failure at stoning time is anticipated fork a good dressing of dusty lime into the border at once, and wash it in with water if rain does not fall soon after the application. Curl in the leaf seems very prevalent this season, and trees with this disease are soon infested with green fly and mildew. All affected leaves should be removed at once if there are plenty of healthy ones to keep growth going on. If the majority are bad they must be removed by degrees. In any case syringe the trees thoroughly with London tobacco juice and softsoap mixed in water, using one-quarter pint of the former and 2 ozs. of the latter to the gallon, applying it in the afternoon when the heat of the sun has declined and not rinsing the trees after. If red spider or mildew is noticed use Gishurst compound at 2 ozs. to the gallon instead of the above occasionally.

CHERRIES.—Keep a sharp look out for black fly, and as prevention is the best policy syringe the trees thoroughly with London tobacco juice and softsoap, as recommended for Peaches above, only mix it 50 per cent. stronger for Cherries. This pest is most difficult to overcome, and nothing but unceasing attention will stop it when it once has a start on the trees.

FRUIT FORCING.

VINES.—*Pot Vines.*—Stop the canes when from 6 to 8 feet long, pinching the laterals and sub-laterals at one joint as produced. This applies to Vines intended for fruiting next season; those intended for planting may be allowed to make all the growth they can, and be cut back to two or three eyes or to the length required at planting time.

Vines Cleared of their Crops.—Syringe occasionally to keep the foliage clean, afford water to render the soil moist, a mulching of short spent material will prevent the surface cracking, and the moist surface will prevent the roots going down. Allow a moderate extension of the laterals, and admit air freely above 60°. There is no fear of the wood not ripening, and the difficulty is to prevent the premature ripening and fall of the foliage.

Houses of Ripe Grapes.—These will be the better for slight shade from powerful sun. Some pilchard or a double thickness of herring nets drawn over the roof lights will mostly be sufficient shade, and a good spread of foliage will assist Black Hamburgs in keeping their colour. Moderate air moisture will not injure the Grapes if accompanied by free ventilation. Keep laterals fairly under, but a little extension will assist in the retention of the principal leaves, and upon their continuance in health depends the maturity of the buds for next year's crop.

Grapes Ripening.—When the Grapes begin to change colour admit a little air constantly, with sufficient heat in the pipes to maintain a night temperature of 65° and 70° to 75° by day, with 80° to 85° or 90° through the day from sun heat. Avoid an arid atmosphere, damping occasionally, and do not allow the border to become dry. Vines ripening heavy crops will be assisted in perfecting them and storing food for the future by an application of tepid liquid manure, applying it early in the day, and choosing a fine day so that superabundant moisture will be dispersed before evening. A light mulching of dry spent material will assist the Vines by securing uniform moisture and keeping the roots near the surface, whilst avoiding excess of moisture, and thus preventing cracking. It is a confined stagnant atmosphere that does all the mischief in Grapes cracking.

LATE GRAPES.—*Thinning.*—There must not be any delay in thinning the berries and bunches. Nothing is so fatal to perfect finish as overcropping. To burden a Vine beyond its strength is to cause it to ripen its fruit later, and to leave doubts as to the berries colouring, and having that amount of saccharine matter stored in the berries which secures their sound keeping. Thin well to secure large and highly finished berries, leaving those of the larger berried varieties, such as Gros Colman and Gros Guillaume, about an inch apart, the oval-berried varieties not requiring so much room as the round ones, but all should be so thinned that they will have space for swelling fully without wedging, and yet be so close that when dished they will retain their form. Loose bunches that show the footstalks are not so pleasing, however fine the berries, as those more compact. Shy setting varieties are often thin of berries through the number of stoneless ones that must be removed, to guard against which no pains should be spared in getting

the wood ripe, and in fertilising the bunches when in flower with Black Hamburg. A pound of Grapes per foot of rod is usually as many as Vines ordinarily finish off well, therefore reduce the bunches so as to give about that weight, and if error is made let it be on the safe side, as Vines that are overburdened never finish their fruit well, and it is inferior in keeping qualities.

Regulating the Growths.—All foliage that can have exposure to light must be allowed, but when the space is fairly covered with leaves keep the shoots closely pinched. An excess of foliage is not good, though it is often encouraged with a view to root action; but it is elaborated sap that builds up the structure of the Vine, the crop of the current year and the wood and buds that give the fruit of the next. The foliage should be rather thinner in the case of white Grapes than in black; this more particularly applies to Muscats, which of all Grapes require high elaboration of the sap to insure their assuming the rich golden amber so much prized. Avoid large reductions of foliage at a time; it only tends to cause shanking through the check given the roots. Keep the growths tied down from the glass, and so prevent scorching. Vines extending must be allowed to make as much lateral growth as practicable, always bearing in mind the wood on which the fruit is to be borne next season must have full exposure for its foliage, as it is the principal leaves that elaborate the sap and transmit the assimilated matter that forms the buds at their base. The laterals from these having been stopped at the first joint they may be allowed to ramble afterwards, subject to their not interfering with the access of light to the main leaves.

Watering.—Inside borders must be well supplied with tepid water, following in the case of Vines that are carrying full crops and in good, but not too vigorous, health with liquid manure, also in a tepid state, mulching lightly with short rather lumpy material, which if kept moist will give out ammonia, and attract the roots to the surface. If more aliment is wanted apply sulphate of ammonia where the soil is rather strong and not chalky or particularly calcareous, but where the soil is light use nitrate of soda, also where the soil is very calcareous. Half an ounce per square yard is enough of either of these salts, repeating it at intervals of about six weeks. If the Vines require solidity use superphosphate of lime—say, a couple of ounces per square yard; and if the foliage is pale in colour add half an ounce of nitrate of potash (saltpetre). These are best given after the border has been watered, following with a light watering after their application. Do not allow the border to become dry at the surface. Neglect in watering borders that are well drained, as all Vine borders should be, and mulching, especially where the Vines are carrying heavy crops, is not only disastrous to the present crop, through inducing attacks of red spider and premature ripening of the foliage, but injuriously affecting next year's crop of fruit. Outside borders may only need a light mulch, as the recent rains have made them moist enough; but if dry a soaking of tepid liquid manure should be given whenever necessary.

Temperature and Ventilation.—Cold nights render fires still necessary. All late Grapes thrive best in a high temperature, with abundant food both at the roots and in the atmosphere. Fires should be employed to maintain a night temperature of 65°, and 70° to 75° by day in dull weather. Admit air early, admitting a little at the top of the house constantly, increasing the ventilation with the temperature, allowing an advance to 85° or 90°, at which keep through the day from sun heat, reducing the ventilation with the declining sun. Close at 85°, damping the paths well then, and again before nightfall. It is well to close for a short time, and afterwards admit a little air, which will prevent a vitiated atmosphere and allow of the foliage drying in the morning by the time the sun acts powerfully. Late Grapes are generally backward this season, hence the desirability of making the most of sun heat, and aiding with artificial. Avoid cold draughts or sudden depressions of temperature, as they cause rust and favour the spread of mildew.

MELONS.—Late Melons are not held in such high esteem as early; indeed, they are considered worth little after the hot days of summer, but they are often really good when the late summer and autumn months are bright. Plants that were raised some time ago and have been put out, or should be at once, will set freely in July, and afford acceptable fruit in August and September. Make a last sowing for growing in dung-heated pits and frames. Make all the beds at once, sowing the seed in 4-inch pots half filled with soil, placed in a frame or house. One or two seeds may be placed in each pot, and a supply of soil given around the stem as the plants advance, but not higher than half an inch from the seed leaves. When the bed is ready turn the plants out of the pots, place one in the centre of each light, planting to within half an inch of the seed leaves with the soil inclining from the stem. Give a good watering, and shade from bright sun. Pinch out the point of the leader at the second rough leaf, which will induce side shoots. Reduce these to four; take two to the front and two to the back of the frame or pit, rubbing off the laterals to within 9 inches of the stem all round, and every other lateral upon the primary shoots, stopping those at 6 inches from the sides of the frame. The plants will be showing and setting fruit in plenty early in August, and they will ripen in late September. All stopping and disbudding must be done whilst the growths are small, for large reductions of growths only tend to promote grossness in the parts retained, and are unfavourable to the setting of the crop and induce canker.

Second Crops of Melons in Frames.—Plants that have fruited may be cut back, have a little of the surface soil removed, adding a little fresh, and give a good watering. If due regard has been given to watering for the first crop, and shoots retained from near the base of the Vines, fresh growth will be quickly made, and fruit will speedily set

and swell; indeed, fruits may be had set and swelling before the first fruits are cut, growth having been encouraged from near the base of the plants. Dry soil at the roots whilst the first crop is ripening exhausts the plants, often spoiling the fruits, which ripen prematurely, and consequently are poor in flavour. Plenty of moisture is necessary when the fruit is swelling, and enough should be given when ripening to preserve the foliage, there being no comparison of fruit ripened with foliage, and that which has no foliage to aid it during the ripening process. Take every care to preserve the foliage in health, so as to ensure solid perfectly finished fruit.

Setting Melons in Frames.—During moist warm weather the flowers do not set freely. It arises from the plants growing too freely, too moist atmosphere, crowding the foliage, and closeness. Anything like crowding the foliage or shoots is fatal to a good set, therefore the shoots should be kept rather thin by removing every alternate lateral whilst quite small, for to reduce them greatly when large often causes gumming or canker. The laterals retained will for the most part show fruit at the second or third joint; if not, stop them at the second joint and the sub-laterals will show fruit freely, when water should be given sparingly, but if necessary, pour it between the shoots so as not to wet the surface of the bed to any great extent. Place hot dung against the sides of the frame, or grass mowings will do with a little litter over the grass. This will raise a gentle heat, admitting of a little ventilation constantly day and night. Fertilise the flowers when fully expanded, stopping the shoots at the same time one joint beyond the fruit. Admit air freely if fine weather permit, increasing the ventilation at 70°, allowing it to rise to 80° or 85° or 90°, at which keep it through the day, closing at 80°, except the small portion before alluded to. When the fruits are set, two to four on a plant, and the size of a bantam's egg, commence watering by sprinkling the foliage at closing time, always keeping the water from the neck of the plants, and besides the sprinkling give a good watering twice a week in hot weather, once a week will be ample in dull weather. Commence ventilating at 75°, allow the heat to rise to 85° or 90°, close by or before the temperature recedes to 80°, or between 4 and 5 P.M., with a gentle damping. The temperature may run up 10° or more, which will be advantageous to the swelling of the fruit. When the fruit is well advanced for ripening keep the bed well lined with hot dung or grass mowings, and admit air freely, omitting the sprinkling, watering through the spout of the pot instead of through a rose. Admit a little air constantly, which will prevent moisture depositing and may keep the fruit from cracking. Cut the Vine half through a little below the fruit if that occurs, cut the fruit a day or two after it commences giving off its aroma, placing it in a warm, dry room, and in two or three days it will be in perfection, which is when the ripening colour pervades every part of the fruit, after which flavour is lost rapidly, and in a few days is entirely gone.

Growers who have well heated light houses will have no difficulty in maintaining a supply of fairly flavoured fruit through October or November from the sowing up to the third or fourth week in July.

THE FLOWER GARDEN.

Flower Beds, Cold and Wet.—Those newly cleared of spring-flowering plants were doubtless somewhat dry when replanted, and have required more water since, but the case was very different with those that were unoccupied during the winter, these being both cold and moist when planted this June. The surface was fine, as might be expected after a severe winter, and also fairly dry, but underneath there was and still is abundance of moisture, or so much as to render it unnecessary and unwise to water the newly put out plants. Being already too cold for the well-being of most of the plants, frequently and heavily watering them only aggravates the evil. In very many instances there was no necessity to water the plants even once, especially if they were in a properly moist condition at the roots when turned out. In any case it is most unwise to be constantly deluging the beds with cold hard water, but should they be found drier than is good for the plants then give a good watering; next day carefully stir and fine down the surface with a Dutch hoe, and then mulch with either leaf soil, cocoa-nut fibre refuse, or even other fine dry soil. Thus treated the chances are no further waterings will be needed.

Spring-flowering Plants.—Directly, and in some instances before, the summer bedding plants are out the work of preparing a stock of plants to closely succeed them in the beds must be commenced. Alyssums, Aubrietias, Hepaticas, Myosotises, double Wallflowers, and Violas should be pulled to pieces, all rooted divisions be planted out on a moderately cool border and light good soil, out of which they will move well next autumn; the rootless pieces to be dibbled into handlights or cold frames at the back of a north wall, and be kept close and shaded from what bright sunshine may reach them till well rooted. All will make serviceable plants by the time wanted. Daisies, Polyanthuses, and Primroses also divide very readily, and the divisions should also have a place on a cool border. If the soil is at all dry when they are firmly planted or dibbled out give them a good watering, and in dry hot weather give soakings of water occasionally. Seedling Primroses and Polyanthuses are more vigorous and produce much finer trusses than do plants obtained by dividing old clumps, but they ought now to be large enough for planting out on cool yet not heavily shaded borders, where they will attain a good size by the time wanted for the beds. If the seed has been obtained from the best sources the seedlings are well worthy of liberal treatment, as they will make quite a gorgeous display next spring.

Seeds to be Sown.—Wallflowers have fared badly, very few plants escaping the slugs. Where there are too few plants, at once either sow

more seed in boxes of fine light soil, and prick out the plants when large enough, or else open fresh drills on a border, and after a gentle watering has been given sow the seed and cover with fine sifted soil. *Myosotises* may yet be obtained in a similar manner in time to make a fairly good display, and the present time is also favourable for sowing Sweet Williams. Double German Wallflowers and Brompton Stocks do not transplant well, and the seeds should either be sown at once, either where the plants are to flower, or else in boxes, and the seedlings be early dibbled out in their flowering quarters. Now is a good time to sow *Aquilegias*, the plants obtained flowering where they are raised by next June, or the seed may be sown in boxes and the seedlings dibbled out where they are to flower. Iceland Poppies, again, ought to find a place in every garden; plants obtained by sowing seed now wintering in the open and flowering grandly early next summer. They do not transplant particularly well, and the surest way of obtaining a stock of plants, especially in slug-infested gardens, is to raise the plants in small pots and plant out direct into the borders or beds prepared for them. Three distinct colours can be obtained, and a very little seed should be sown in each pot. Keep them in a cool place, shade from bright sunshine, and water very gently till the seedlings are up. Pansies may be readily raised on open borders, the plants obtained by sowing seed now flowering grandly next spring. *Dianthus*es may be similarly raised and wintered in the open. If seed of Hollyhock is sown, either thinly in boxes or in the open borders, a capital lot of plants ought to be available for potting and keeping through the winter under glass. The herbaceous *Campanulas* may also be sown now, and the *Antirrhinums* raised during the summer will usually winter in the open, flowering strongly in the following summer.

PLANT HOUSES.

Kalosanthes.—Plants that are growing on for flowering next year should be thoroughly hardened and stood outside. By this treatment they do not grow so tall and their growths become thoroughly ripened, which insures free flowering. Any plants that have missed flowering may have the tops of the shoots removed and four or five inserted in each 5-inch pot. These root freely in any structure that is kept close and warm. After they are rooted fully expose them to sun and air. Those plants that have no flowering shoots may be cut closely back and allowed to start into growth again. If an increase of stock is needed portions of the stem after the top has been removed may be rooted. These will produce four or five shoots each, but will need growing for a full season before they are sufficiently developed for flowering.

Amaryllises.—These certainly succeed best in a pit or small house that can be entirely devoted to them during the season of growth, but where a few only are grown they will succeed in a light position in a vinery, and after growth in the greenhouse expose them to the sun. A good season of growth and thorough ripening is the secret of success. Plants that are crowded with roots in small pots should have liquid manure freely in a weak state every time they need water.

Begonias.—*Begonias* of various kinds may still be increased. The cuttings root so freely that at this season of the year they should be inserted singly in small pots, so that they can be grown on afterwards without being checked. Place those for autumn and winter flowering into their largest pots, and stand them in cold frames. Keep them close until they are rooting freely, and shade from bright sunshine. Autumn and winter flowering varieties are invaluable, and too many cannot well be grown for cutting purposes.

Cyclamen.—Place the earliest of these into 5-inch pots, and stand them rather close to the glass, where abundance of light can be admitted with a free circulation of air. Keep the soil moist about their roots, and syringe freely twice daily. Repot all that need it, and care is needed that they do not become checked while in a small state, or they often fail afterwards. Where houses can be devoted to these plants grow them in cold frames from the present time, but where they have been kept in heat gradually harden them before removal.



APIARIAN NOTES.

THE WEATHER.

It still continues dry, and unless rain comes soon a dearth of water is certain; already there is a scarcity for animals and domestic purposes, and crops of every kind are making but little progress. The day temperature for two days has now risen from 33° in morning to 75°, but on both mornings—viz., 11th and 12th—it was 5° lower upon the grass, and was white with hoar frost. The first week in June was the most destructive to bee life I ever experienced. Many hives that were good, comparatively speaking, are now useless, and the strongest suffered; but with the change of wind, the first apparently permanent for nearly sixteen weeks, they are again improving, and those that have not succumbed will be in good trim by the time flowers are ready for them.

QUEENS AND HIVES.

As anticipated many queens are deposed, but in most cases young ones were well forward, and with warm weather very little decay will result, as there are plenty of drones.

Unfed hives and those with young queens have, as usual, stood the test best, are the most forward, and will undoubtedly give most profit with the least trouble. I have commenced queen rearing, and shall divide and form nuclei on or about the tenth day after, and either nurse them or transfer them into hives having queens failing in fertility.

HINTS FOR BEGINNERS—DECAYING HIVES.

Twenty years ago there was not such a thing known as hives made from white pine, one of the worst damp-resisting woods we have; it warps, shrinks, and expands with every change of the weather. The only recommendation it has is cheapness. Before the advent of "modern bee-keeping" hives were made from the best yellow pine, and red where possible. These were more expensive, but far more durable, and the great cry raised by certain dealers against high priced hives was simply a trade advertisement, and a delusion.

I have just examined some five-year-old hives that had evidently drawn damp that were made from white pine, and they are quite rotten; the frames went to pieces when the hand was laid upon them, while hives made from red and yellow pine upwards of thirty years ago were quite fresh. Not speaking of the advantages that hives made of the latter wood possess, in point of economy they are the cheapest in the end, and at no great length of time either.

The beginner should therefore have the wood for hives selected, discarding all that of young growth, and blue or sap wood. Before I used the ventilating floors I had only yellow pine in connection with the inside of hives, but after I did not object to red pine. But let me here warn those unacquainted with the nomenclature of the timber trade to avoid that known as red deal. It is of young growth, and warps readily. I need not here repeat the form of hive best suited for bee-keeping further than that the Lanarkshire storifying hive as used by me for upwards of forty years, with but slight alterations, is the hive most suitable for profitable bee-keeping, and is every day becoming more popular both in Britain and the Continents of Europe and America. After the hive select the bees, and be sure the colony is provided with a young queen of the current year. If this has been secured early in June, and the hive nursed forward, it will be in capital order for the Heather.

Young bee-keepers are sometimes misled when they are told queens lay 3000 eggs daily; trusting to that and taking a commercial view of the case, they calculate that in three weeks there will be nearly 100,000 workers in the hive. Having six or seven pounds of bees to begin with, with a young fertile queen in the height of the season, it is quite possible that number may be reached. But the hive must be larger than that known as the standard.

Bees begin breeding a little after the shortest day, and if the weather become warmer as the days lengthen. In most cases all hives would be ready to swarm end of March, but the reverse is the case; and although bees breed in calm weather at almost a zero temperature, they discontinue it at a temperature of 25° to 30°, with the piercing winds of March, April, and May. In short, bees breed and expand or contract their brood nest according to the temperature and the season of the year.

A newly fertilised queen is most prolific shortly after the occurrence and during heat and the incoming of honey, but before she lays 3000 eggs daily she must have in attendance at least 30,000 or 40,000 bees. After a queen has laid that number, be she young or old, Nature demands a rest, and the bees prepare for swarming.

FEEDING.

For some weeks past I have been feeding those that were lightest in the autumn, and have not given them more than

6 ozs. in the week, always in tin scoops from beneath the combs. They are easier fed there, and the bees take it more readily than from above; besides, it is detrimental to bees to have feeders above during cold weather.

In all cases where a scarcity of food is apparent, with no prospects of honey from the fields, continue feeding bees. They seem to become impatient after May, and if June denies them the nectar of the flowers they are liable to draw their brood, even in cases where the hives are well supplied with stores. Should the weather be unfavourable it will be wisdom on the part of the bee-keeper to feed every hive, whether in want or not. One pound of sugar to each hive weekly will prevent brood drawing and preserve the hive, and be in the best possible condition to gather honey the first favourable opportunity, which bees in good spirits and strength will not miss.

UNFED HIVES.

Those that have not had any food given I examined on May 28th, and I was glad to find every one of them had plenty of sealed honey, and the bees almost crowding out—capital proof, if proof had been wanted, that bees do not require stimulative feeding, brood spreading, nor contraction of hives when properly managed in autumn.

SUPERING.

It is unadvisable to attempt supering before the glut of honey begins. It cools the interior of the hive, the bees contract their cluster, and brood drawing is proceeded with in proportion, thus negating the thing desired. This is all the more so under the modern system of admitting bees from between every comb in the hive, encouraging the bees to prepare the cells for eggs, which above all should be beautifully white and clean.

The Stewarton system of slides to open and close according to the weather entirely overcomes all these questionable and objectionable proceedings, and dispenses entirely with excluder zinc, superfluous to a hive, and entails much extra labour on the bees propolis and forcing their way through apertures too narrow to be either comfortable to them or profitable to their owners. Every load of propolis gathered is a loss of more than a load of honey, and the time employed depositing it in the crevices, is at the expense of comb-building. The honey gathering time in the best of seasons is too short to hamper the bees in any way, or by giving them additional or unnecessary labour. If we are to make the most of them, we must not restrict breeding, nor make their passage ways to the supers difficult, but full freedom in both hive and supers, and an easy access to both, particularly the latter.

—A LANARKSHIRE BEE-KEEPER.



All correspondence should be directed either to "THE EDITOR" or to "THE PUBLISHER." Letters addressed to Dr. Hogg or members of the staff often remain unopened unavoidably. We request that no one will write privately to any of our correspondents, as doing so subjects them to unjustifiable trouble and expense.

Correspondents should not mix up on the same sheet questions relating to Gardening and those on Bee subjects, and should never send more than two or three questions at once. All articles intended for insertion should be written on one side of the paper only. We cannot reply to questions through the post, and we do not undertake to return rejected communications.

Renovating Orchids (W. M.).—You have misapprehended the instructions, but as you appear to be an experienced cultivator we shall be glad to publish a description of the system you adopt.

Dwarf Plants for a Border (C. H.).—*Trifolium uniflorum* is very dwarf, and would be suitable for the purpose you name, but you would probably find *Herniaria glabra*, *Sedum glaucum*, or *Mentha Pulegium gibraltaria* more useful.

Tomatoes Unhealthy (W. B.).—We fear you will soon see the "disease" to which you are happily yet a stranger. Symptoms are apparent in the leaf, induced not improbably by a low temperature. Raise it once, and see replies to other correspondents.

Vegetables for Exhibition (H. M.).—You must be good enough to put your question in a more definite form, as obviously no kinds of vegetables can be the "best" for showing at all seasons of the year. It is essential to know the time at which the vegetables are wanted; also please state whether you mean by "rotation" order of time or order of merit.

Early Green Gooseberries (A. Novice).—We do not know a variety named Covent Garden Early. There is a Berry's Early Kent, which Mr. Bunyard in his "Fruit Farming for Profit" refers to approvingly as one of the earliest sent to Covent Garden. Many growers find Whinham's Industry the most profitable early green Gooseberry, but the fruit is red when ripe.

Libonia floribunda (P. J. C.).—How do you think we can tell you why you have failed to flower this free-flowering plant when you do not say one word about your method of trying to do so? With healthy root action, in good soil, and the growths made under the full influence of sun and air, the plants are bound to flower. Some persons grow them on shelves in very light houses, others in frames, and others again in the open air in summer, both planted out (for lifting) and in pots.

Mushroom Spawn (J. T.).—It does not matter how many bricks you have, provided they are set on edge so that there is a little space between them. On the first lot others can be placed in the same way crosswise, continuing the building till the whole are in position, drawing each layer in so as to form a sloping outer face for the manure. The drier the bricks are the moister the covering should be. The spawn in the litter will, perhaps, be of little use, though of course you can try it if you like.

Zonal Pelargoniums for Exhibition (J. E. O.).—If you have pinched off the ends of the shoots quite recently you had better not pinch them again. The flower buds may be removed till six or seven weeks before the show, and the flowers should be carefully gummed as they open. If the pots are filled with roots weak clear liquid manure may be given at once, weekly, and more frequently as growth advances, and in accordance with the condition of the plants. Avoid thick muddy liquid for them as you would reject muddy wine for yourself, if you are a wine drinker; but, perhaps, like most gardeners, you are not.

Tea Roses in Pots (W. T.).—So much depends on the present condition of the plants that it is practically impossible to answer your question usefully without some data to guide us; and it is also desirable to know your cultural convenience as well as the period of the year you desire the plants to flower. If you furnish us with particulars of the nature suggested respecting your question, the matter shall have our ready attention. An excellent little book on the cultivation of Roses in pots by Mr. William Paul, Waltham Cross, Herts, would be of service to you. It is illustrated, and the price is only 2s., but if you order a copy you might reasonably include two or three stamps for postage.

Tulips Falling (W. S.).—Your plants appear to have been overtaken with the disease that affects Tulips, and has done much injury in many places. Dr. Hogg's collection suffered greatly last year, but by the addition of lime to the soil, and preventing its saturation, the growth has been clean and healthy this year. If a serious check to growth occurs through excessive wet, or a sudden and prolonged chill, the sap becomes morbid, and disease ensues. The blooms you have sent appear to be forms of *T. Gesneriana*, except No. 4, which is *T. oculus solis*. The petals fell off when the flowers were taken out of the box for examination, and cannot therefore be referred to under numbers except in the case recorded.

Tomatoes Diseased (P. McT.).—If the whole of the plants in the Cucumber house are in the condition of the samples you have sent it is doubtful if they can be restored to health, and it is for you to consider if it would not be the best plan to clear them out. At least all much affected parts should be cut off and burned, then the ammonia and sulphate of copper remedy, or the sulphur and lime remedy mentioned in our reply to "H. B." under "Mildew on Vines," thoroughly applied. The Cucumber house is much too moist for the Tomatoes, and they should be kept as dry as possible. In the Tomato houses try the simple plan of a Worthing grower, mentioned in our reply to "W. A. J.," as well as either of the remedies named, the first preferably. Many Tomatoes are ruined through being kept too moist and the growth too succulent, especially where a low night temperature also prevails.

Mildew on Vines (J. H.).—As you have "sulphured" the hot-water pipes and not found any benefit we suspect they were not sufficiently heated to give off fumes of sulphur. It is necessary to heat the pipes to 160° or more. Usually sulphur begins to vapourise at a temperature of 170°, to which the pipes should be heated and kept between that and 200° for an hour; but there is danger in too much vapourising, and we have found that the nearer the heat of the sulphured surface is kept to 170° the less danger of injuring the skin of the Grapes. Thus applied the mildew is checked. See answer to "H. B." If you have a sprayer we recommend your trying the

carbonate of copper and liquid ammonia remedy. One gallon will spray three or four large Vines. If you only want a small quantity take say one-eighth of an ounce of carbonate of copper and one-eighth of a pint of liquid ammonia, or 2½ ozs. by weight, dissolving the carbonate of copper in the ammonia, pour into a pail and add 1½ gallon water. With this spray the Vines thoroughly, but not to the extent of causing the solution to drip from the leaves, or when that takes place cease spraying. Repeat at intervals of twelve to fifteen days if necessary. The copper is a poison, but one or two good syringings will clear it all away. It is used extensively in America right up to the Grapes colouring, and has been used many years without prejudice to health.

Fungus on Tomatoes (W. A. J.).—We omitted to say last week that there is no danger in using the Bordeaux mixture or any of the copper solutions on plants, the fruit of which have to be eaten, if the precaution is taken to wash the fruit with water a few times after spraying with the copper solution. It is much used in America on Apples for the cure of "scab," and the fruit is sent to this country and consumed in very large quantities without any disadvantage to anyone except home growers, who, failing to use remedial measures for diseases through prejudice, place lesser quantities and inferior qualities of fruit in the market than they need do were they to take the requisite measures to secure first class fruit. We have recently seen a very fine example of Tomato culture in one of the celebrated market growing establishments at Worthing, and on alluding to the disease (cladispodium) Mr. Scutt observed, "We are quite master of that now; all that is necessary is, as soon as the spots appear, to heat the pipes and maintain a temperature of 80° for a few nights and days, with a dry atmosphere; the fungus then vanishes and the plants go ahead." That we take to be a valuable hint, and the simple plan suggested is worthy of trial everywhere where the fungus appears. Prompt action is most important.

Roses in November (T. M. J.).—You must free the plants from mildew by syringing with a solution of water and powdered sulphur. A 3-inch potful of sulphur in each three gallons of water will be ample. This should be left on the leaves for three or four bright days, and then the plants well syringed with clean water. If every trace has not been destroyed repeat the application. The Roses should now be gradually hardened by the admission of full ventilation until the house can be left open all night, the doors as well. When they are well hardened too much air cannot well be given. If the lights can be removed until the end of September all the better, that is if you want the plants to commence blooming towards the end of November. From the middle of September preparations should be made for a start, and weak growths removed as well as those that are soft and unripe. At that season of the year you can only hope for buds, and therefore must not practise a very severe system of pruning. A mere thinning out only is necessary. If larger blooms are needed you must prune more severely. The main secret is in having the wood hard and ripe. The plants soon start into growth during September after the syringe is used and the house kept closed, giving air only on bright sunny days. Do not bring about a ripened condition of the wood by withholding water at their roots. It is a good plan to give a good soaking, and then mulch them with short manure to prevent giving too frequent applications. Keep the foliage clean during the season, and remove all flower buds as they appear.

Mildew on Vines (H. B.).—The mildew having got strong hold will not be eradicated without leaving its traces on the Grapes. You may apply one of the following remedies as most convenient:—1, Dust every part of the Vines infested with the mildew thoroughly with flowers of sulphur, using a "sulphur duster" (boite à houpe) or a worsted stocking mounted on a stick and partly filled with the sulphur, shaking it over and through the Vines. Look over the Vines occasionally, and if there be any patches that have escaped the first dusting repeat, and persist in this until the Grapes change colour for ripening, when as much of the sulphur may be syringed off, but it can rarely be all cleared off, and sometimes the sulphur must remain until the Grapes are ripe on account of the re-appearance of mildew on young growths. Maintain a drier condition of the atmosphere. 2, Slack 1 lb. quicklime in an iron pot along with 1 lb. of flowers of sulphur, or slack the lime first, then add the sulphur. Add a gallon of water, mix well, place over a fire and heat to boiling, allowing to simmer a quarter of an hour, keeping well stirred all the time. Let the liquor cool, then pour off the clear liquid into bottles, leaving the sediment, keeping well corked in a dark place. Use a pint of this mixture to twelve gallons of water, or half pint to six gallons, quarter of a pint to three gallons. It will resemble milk. With this syringe the Vines thoroughly, using a syringe with a spraying nozzle. Do this on a calm evening, repeat the next and next. This is usually sufficient, but if any mildew afterward appear apply the solution. This will discolour the paint, but it will not injure anything; yet as Vines differ in the texture of their foliage it is always well to try the solution on a few growths, allow them to dry and noting the effect, then proceed accordingly, that is, if it injure the Vines use less of the sulphide. 3, On a fine calm day towards evening heat the hot-water pipes to 170° to 200°, close the house, and brush the pipes over with a thin paint formed of flowers of sulphur and skim milk, coating them evenly throughout. Keep the pipes hot about an hour, then let them cool down to the ordinary temperature. This will check the mildew. The sulphur may remain on the pipes and will give off some fumes whenever they are heated inimical to the fungus. Strong fumes, however, harden the skin of the Grapes and they "colour" prematurely, not swelling well, often cracking. Avoid the use of "hot iron" in using sulphur. 4, If

you have a spraying syringe try the following:—"Mix thoroughly 6 ounces of pulverised ammonia carbonate and 1 ounce of copper carbonate. Keep in an air-tight vessel, and when ready for use dissolve in ten gallons of water." Spray two or three times at intervals of twelve to fifteen days. This ought to annihilate the mildew. Then thoroughly cleanse the Vines by syringing. Anti-fungi, Anti-blight, and other advertised fungicides are well worth the attention of growers, and are often more handy and generally available than other mixtures.

Names of Plants.—We only undertake to name species of plants, not varieties that have originated from seed and termed florists' flowers. Flowering specimens are necessary of flowering plants, and Fern fronds should bear spores. Specimens should arrive in a fresh state in firm boxes. Slightly damp moss, soft green grass or leaves form the best packing, dry wool the worst. Not more than six specimens can be named at once, and the numbers should be visible without untying the ligatures, it being often difficult to separate them when the paper is damp. (*G. L.*)—It is evidently a near relative of the *Pancreatium*, but unfortunately the flower was too withered to furnish sufficient material for identification. (*Matfen*).—The Fig is Brown Turkey, the Orchid is *Trichopilia tortilis*, and the *Pelargonium grossulariaefolium variegatum*. (*B.*)—1, *Fuchsia procumbens*; 2, *Fragaria indica*; 3, *Rubus australis*. (*Inquirer*).—1, *Leschenaultia formosa*; 2, *Leschenaultia biloba*. (*T. J. S.*)—Such specimens could only be determined by comparison in a large herbarium.

Queen-Excluder Zinc (M. H.).—Our columns were full to overflowing when your letter arrived, and it cannot appear this week.

COVENT GARDEN MARKET.—JUNE 17TH.

Business brisker, with good supplies. Prices generally unaltered, excepting Peaches, which are lower.

FRUIT.

	s. d.	s. d.		s. d.	s. d.
Apples, Tasmanian, case	6 0	to 14 0	Oranges, per 100 ..	4 0	to 9 0
Grapes, per lb. ..	2 0	3 6	Peaches, per doz. ..	3 0	1 0
Kentish Cobs ..	40 0	50 0	St. Michael Pines, each. .	3 0	8 0
Lemons, case ..	15 0	20 0	Strawberries, per lb. ..	1 6	5 0

VEGETABLES.

	s. d.	s. d.		s. d.	s. d.
Asparagus, per bundle ..	0 6	to 2 6	Mushrooms, punnet ..	0 8	to 1 0
Beans, Kidney, per lb. ..	0 9	1 0	Mustard & Cress, punnet	0 2	0 0
Beet, Red, dozen ..	1 0	0 0	Onions, bushel. . . .	5 0	6 6
Cabbage, dozen ..	3 0	0 0	Parsley, dozen bunches	2 0	3 0
Carrots, bunch ..	0 4	0 0	Parsnips, dozen ..	1 0	0 0
Cauliflowers, dozen. . .	3 0	6 0	Potatoes, per cwt. . . .	3 0	4 0
Celery, bundle ..	1 0	1 3	Rhubarb, bundle ..	0 2	0 3
Coleworts, doz. bunches	2 0	4 0	Salsafy, bundle ..	1 0	1 6
Cucumbers, doz. . . .	1 6	4 0	Scorzoner, bundle ..	1 6	0 0
Endive, dozen ..	1 3	1 6	Shallots, per lb. . . .	0 3	0 0
Herbs, bunch ..	0 2	0 0	Spinach, bushel ..	5 0	6 0
Leeks, bunch ..	0 2	0 0	Tomatoes, per lb. . . .	0 10	1 0
Lettuce, dozen ..	1 0	1 3	Turnips, bunch ..	0 0	0 3

AVERAGE WHOLESALE PRICES.

CUT FLOWERS.

Orchid Blooms very good, rather plentiful.

	s. d.	s. d.		s. d.	s. d.
Anemone, dozen bunches	2 0	to 4 0	Mimosa (French), per bunch ..	1 3	to 1 6
Arum Lilies, 12 blooms ..	2 0	6 0	Myosotis, dozen bunches	2 0	4 0
Azalea, doz. sprays ..	0 6	1 0	Narciss (double white) dozen bunches ..	4 0	8 0
Bluebells, dozen bunches	1 0	2 0	Paeonies, dozen bunches	6 0	18 0
Bouvardias, bunch ..	0 9	1 0	Pansies, dozen bunches. .	1 0	2 0
Carnations, 12 blooms ..	1 0	2 0	Pelargoniums, 12 bunches	4 0	9 0
Cornflower, doz. bunches	4 0	6 0	scarlet, 12 bnchs	3 0	6 0
Eucharis, dozen ..	3 0	6 0	" Primula (double) 12 sprays	0 6	1 0
Gardenias, per doz. . . .	1 0	3 0	Pyrethrum, doz. bunches	4 0	9 0
Iris (Various) doz. bchs.	6 0	12 0	Roses (indoor), dozen ..	0 6	1 6
Lapageria, 12 blooms ..	2 0	4 0	" Red (English) per dozen blooms ..	2 0	4 0
Lilac (English) per bunch	0 6	1 0	" Red, 12 bls. (Fench.)	1 0	2 0
(French) per bunch	5 0	6 0	" Tea, white, dozen. .	1 0	2 0
Lilium longiflorum, 12 blooms ..	3 0	4 0	" Yellow, dozen ..	2 0	4 0
Lilium (various) dozen blooms ..	1 0	3 0	Spiraea, per bunch ..	0 6	0 9
Lily of the Valley, dozen bunches ..	4 0	9 0	Tuberose, 12 blooms ..	0 6	1 0
Maidenhair Fern, dozen bunches ..	4 0	9 0	Violets (dark), per beh. .	1 0	1 6
Marguerites, 12 bunches	2 0	4 0	" (English), doz. bnch	0 6	1 0
Mignonette, 12 bunches. .	3 0	6 0	Wallflower, doz. bunches	2 0	4 0

PLANTS IN POTS.

	s. d.	s. d.		s. d.	s. d.
Aralia Sieboldi, dozen ..	6 0	to 18 0	Hydrangeas, per doz. . .	9 0	to 12 0
Arbor Vitæ (golden) doz.	6 0	8 0	Lilium longiflorum, per dozen ..	13 0	30 0
Arum Lilies, per doz. . .	9 0	12 0	Lobelia, per doz. . . .	4 0	6 0
Azalea, per plant ..	1 6	3 0	Marguerite Daisy, dozen	6 0	12 0
Calceolarias, per dozen ..	5 0	9 0	Mignonette, per dozen ..	4 0	9 0
Cineraria, per doz. . . .	5 0	8 0	Musk, per doz. . . .	2 0	4 0
Dracæna terminalis, doz. .	24 0	42 0	Myrtles, dozen ..	6 0	12 0
" viridis, dozen ..	12 0	24 0	Palms, in var., each. . .	2 6	21 0
Erica, various, dozen ..	12 0	24 0	Pelargoniums, per doz. . .	9 0	18 0
Euonymus, var., dozen ..	6 0	18 0	Pelargoniums, scarlet, per dozen ..	3 0	6 0
Evergreens, in var., dozen	6 0	24 0	Saxifraga pyramidalis, per doz. . . .	12 0	18 0
Fairy Roses, per doz. . .	6 0	9 0	Spiraea, per doz. . . .	8 0	12 0
Ferns, in variety, dozen. .	4 0	18 0	Stocks, per dozen ..	4 0	6 0
Ficus elastica, each. . . .	1 6	7 0	Tropæolums, per dozen ..	3 0	6 0
Foliage plants, var., each	2 0	10 0			
Fuchsia, per doz. . . .	6 0	12 0			
Genista, per doz. . . .	6 0	9 0			
Geraniums, Ivy, per doz. .	4 0	6 0			

Bedding plants (in variety) in boxes, from 1s. to 3s.; in pots, per doz., 1s. to 2s.



NORMANDY BUTTER.

MEMBERS of the British Dairy Farmers' Association during their recent excursion had striking proof that good butter does not depend upon any particular breed of cows, but upon management and manipulative skill. It was striking, because in the Channel Islands where the milk is so rich that quantity of butter is a certainty, its quality was found to be decidedly inferior, and the outspoken criticism of members of the Association and their offers of instruction gave great offence to Guernsey farmers. Several members of the Association went on to Normandy where they were certain of meeting with good butter, and at the farm of M. Duboscq at Vauselle, near Bayeux, where forty cows are kept, it was of the best quality, altogether superior to the Normandy butter sent to this country from the blending factories. The butter is in high demand in Paris, selling now at from 1s. 6d. to 1s. 10d. per lb., and in winter as much as 2s. 8d. per lb. is obtained for it. The prices denote unmistakably the superiority of the butter, as the yield of butter of only 5½ lbs. per cow per week does the inferiority of the half-bred Normandy cows. The cream is well ripened, a barrel churn is used, in which the butter grains are well washed, and no salt is used. At the farm of M. Castel at Maisons, where fifty or sixty cows are kept, the rate of butter yield was even lower, being only 5¼ lbs. per cow per week.

At the famous butter blending factory of Brétel Frères 150 hands are employed, of whom fifty are women. The butter is obtained at the rate of 60,000 lbs. to 66,000 lbs. a day, or 20,000,000 lbs. a year from the various local centres. It is separated into four grades, put separately through circular butter workers. No salt is used for the first and second grades, only a little for the third; but for the fourth, which goes to India, Brazil, and other hot countries, salt is used abundantly. The salting is done on long narrow tables by weight and measure, the butter then being placed in a mixing machine, and afterwards in a second mixer. For French or British consumption the butter is made up in 2 lb. rolls, being first forced into a square box and sliced off level on top with a wooden strike. This gives the exact weight without actual weighing, and the square blocks of butter are then made into rolls and packed. From 8000 to 9000 cases of 24 lbs. are sent to England weekly.

The butter is made by the dairy farmers, and is sent to the factory precisely as it comes from the churn. The thorough working at the factory ensures uniform quality and a certain standard of excellence, but it cannot do more. Here is our chance, for at British factories the butter is made is decidedly superior to Normandy butter, and with many more or larger factories there should be no difficulty about successful competition with either Danish or Normandy butter. For market purposes there can be no doubt about the superiority of the factory system, and though the instruction now given by means of lectures and demonstration is undoubtedly highly valuable, yet the dairy difficulty is insuperable. For one farmhouse that has a really well appointed dairy there are twenty faulty ones, and it is hopeless to expect a sweeping reform in them. Therefore farmers generally cannot compete successfully with a factory, and it would be much more to their interest to sell milk instead of butter, if only the factory is near enough to enable them to avoid expenditure on milk carriage. It is found that milk can be sent from a distance of a hundred miles to London at a profit; but we wish the money paid for carriage to go into the farmers' pocket, as it would do, and does where factories exist.

The most remarkable thing seen at the Normandy farms was

not the butter-making, but the calf-rearing. At M. Duboscq's farm there were seventeen calves being fattened solely on curdled skim milk. This is the process:—For the first three days they are allowed to suck, and are then fed with new milk till they are three weeks old, when the gradual change to sour skim milk is made until they have nothing else, all the calves evidently thriving exceedingly well upon this food, the biggest one, about four months old, being worth £4 15s. in the local market. This method of fattening calves appears to be general in Normandy, and is certainly worthy of attention by British farmers. It probably answers so well from the curdled milk being more digestible than sweet skim milk; anyhow it does answer, and we strongly advise our readers to turn their valuable hint to account. As one of the deputation said, it was a veritable "eye-opener," for nothing could possibly be more satisfactory than the condition of the calves, and the economy of the plan is self-evident. With these few lessons of usefulness we conclude our notice of the Channel Island excursion. Guernsey cows, Normandy butter, and calf fattening are things to be remembered in such a manner as to be turned to subsequent account.

WORK ON THE HOME FARM.

Never did we see corn crops so foul with weeds in June as they now are, and the backward sickly appearance of much of the corn does not give promise of much profit to cover the heavy expenditure involved in the attempt to kill some of the weeds. It was indeed a sign of the backward season to see the men just beginning work in the corn fields that is usually done in March or April. Charlock is of course rampant, and will, as usual, rob the soil of much of its fertility, which reminds us of the very general evidence of soil poverty we have had in several recent long journeys. Both pasture and corn land show unmistakably lamentable poverty of condition. We have been over midland pasture laid in for hay that will yield nothing like a ton an acre, and it is difficult to see how it can answer to pay rent for land and suffer it to remain so sadly out of condition. It might be supposed that the whole question of the profitable use of manures was about threshed out now. So it is, but to very little purpose so far as the ordinary farmer is concerned. As to chemical manures he is in a cloud, and we question if ever he will come out of it. We know many farmers, models of sobriety and industry, who work early and late to make ends meet, and who do it, too, but who might do so much better for themselves if only they did the best for the land which they hire. Why even the most stolid mind must understand that to keep on grazing or mowing pasture year by year, and to do nothing to it in the way of a systematic application of manure, must induce poverty of soil and practically crop failure.

The singling and hoeing of all root and green crops has made satisfactory progress, and there is an excellent full plant of all such crops. We prefer sowing cattle Cabbage and Thousand-headed Kale in drills where the plants are to grow, and to thin rather than transplant from a seed bed as being more certain. The cost of an extra quantity of seed is more than counterbalanced by the lessened labour. It may appear that thinning or transplanting involves much the same amount of labour, but if the transplanted crop has to be watered a few times the cost mounts up quickly.

OUR LETTER BOX.

Diseased Cow (D. E.).—We should be very sorry to drink any of the milk under the circumstances you describe, and we should think anyone would run a serious risk in doing so.

METEOROLOGICAL OBSERVATIONS.

CAMDEN SQUARE, LONDON.

Lat. 51° 32' 40" N.; Long. 0° 8' 0" W.; Altitude, 111 feet.

DATE.	9 A.M.					IN THE DAY.				Rain	
	Barometer at 32° and Sea Level.	Hygrometer.		Direction of Wind.	Temp. of soil at 1 foot.	Shade Temperature.		Radiation Temperature.			
		Dry.	Wet.			Max.	Min.	In sun.	On grass		
1891.											
June.											
Sunday	7	29.929	51.7	47.0	N.E.	55.2	59.8	46.8	96.4	47.0	—
Monday	8	29.919	56.0	50.9	E.	54.3	66.2	45.7	113.9	43.7	—
Tuesday	9	29.918	58.4	52.0	N.E.	54.9	63.4	51.3	107.1	50.9	—
Wednesday ..	10	29.957	60.0	52.2	N.	55.0	68.7	44.9	110.0	42.1	—
Thursday	11	30.186	51.9	46.2	N.E.	55.9	61.9	45.0	116.6	41.1	—
Friday	12	30.395	51.6	47.9	N.E.	56.9	65.0	45.8	112.8	40.3	—
Saturday	13	30.383	59.7	54.6	S.W.	55.4	76.1	45.9	121.4	41.9	—
		30.102	55.6	50.1		55.5	66.3	46.4	111.2	43.7	—

REMARKS.

- 7th.—Generally overcast and cool, but occasional gleams of sun.
 8th.—Occasional gleams of sun, but generally cloudy in morning; one or two slight showers in afternoon.
 9th.—Fine and generally bright.
 10th.—Bright and fine.
 11th.—Bright, but cool.
 12th.—Overcast and cold morning; generally bright after 2 P.M.
 13th.—Brilliant morning; occasional cloud in afternoon and evening.
 A fine bright week, not so warm, but rainless.—G. J. SYMONS.

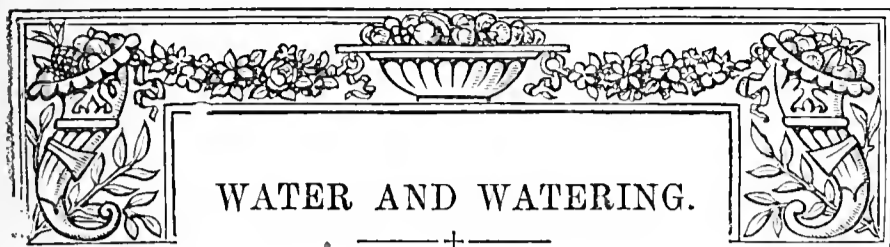

WATER AND WATERING.

AS often as hot and dry weather comes round the question of the water supply and application forces itself on the attention of gardeners, also on some, but by no means all, owners of gardens. In not a few the supply of water is lamentably insufficient, and where this is so gardeners are severely handicapped in the discharge of their duties, and notwithstanding all their efforts to prevent it crops and plants suffer, scarcity of produce following, and this often leading to discontent.

A constant and plentiful supply of water is the first essential in gardens. In some districts it may be both costly and difficult to obtain, but in many of these means of storage might be provided on a more liberal scale than now exist. Where gardening is conducted as a means of profit, and not a penny is knowingly spent uselessly, large sums are invested in providing a constant and abundant supply of water, in full confidence that this will give a good return on the outlay. Without adequate provision in this respect the important work of cultivation could not be profitably conducted, no matter how good the soil and climate, or how favourable the position for the disposal of the produce. The importance, or rather the absolute necessity, of a full supply of water and its convenient distribution is convincingly shown in the great fruit-growing establishments at Worthing, where blocks of glass structures glisten in the sun for miles along the coast close by the sea. The soil, climate, and position are all favourable for the production of Grapes, Tomatoes, Cucumbers, or whatever may be grown, but until deep wells are sunk and steam or wind-worked pumps provided nothing can be done. These are to be seen in every establishment large or small, and it is the water that brings wealth to those who win it in the remarkable industry there established. Yet in many private gardens, not a few of which are owned by persons of wealth, the importance of a similar supply does not seem to be fully appreciated. Let us hope that it will be eventually, and that when gardeners obtain the much-longed-for and most necessary supply they will use it wisely.

Much more water is used, as a rule, in commercial establishments, where plants and crops are grown for sale, than in private gardens; but though it may appear to be used lavishly, in the former it is applied judiciously, or the results could not be satisfactory. In the application of water to fruit borders many things have to be considered for the avoidance of mistakes—the nature of the soil, drainage, temperature, atmospheric conditions, as well as the state of whatever may be under cultivation—whether recently planted or long established. Tomatoes may be ruined, and have been ruined, by saturating the soil too early in the season. One watering given in error may spoil the plants whether they are in pots or planted out, and it is the same with other plants and crops. Overzeal at the commencement of operations in giving water thoughtlessly when there are few roots to imbibe it, is too common. We may respect the motive, but must deplore the want of judgment thus too often apparent; and, conversely, it is sometimes not less apparent later in the season in the opposite direction, when the supplies are inadequate for the needs of plants and crops and the demands of an arid atmosphere. Mr. H. Dunkin communicates sensible remarks on watering, mainly applied to plants in pots, but the

principle on which he bases his action governs the whole routine. He writes as follows:—

“When the long looked for sunshine and warm summer days arrived the beneficial influence was quickly noticed upon all kinds of vegetation, which sprung into active growth with wonderful rapidity. In the case of plants growing in pots, to sustain the large amount of growth recently made, and keep the plants still growing on in a satisfactory condition, growers will have to be on the alert, and bear well in mind the great changes of atmospheric conditions under which their operations are now conducted, otherwise the great caution which has been necessary in watering plants during the long, dull, wet spring months will have the effect of allowing plants to become too dry at the roots before water is given. It is after such great changes from dull cold to tropical weather that the greatest mistakes are made by the inexperienced, and it must be confessed that a thorough knowledge of the quantity of water different classes of plants may with benefit receive in hot weather can only be arrived at by a combination of close observation and well applied reasoning, and among the many operations connected with plant culture I firmly believe proper watering plays the most important part. Even when potted in unsuitable soil judicious watering may do much to secure good results; but pot a plant in soil exactly suited to its requirements and surround it with other favourable conditions, yet with all these advantages neglect or carelessness in watering will produce only meagre results.

“The general tendency seems to be to give too much water in winter and too little in summer. This mistake appears to be brought about by following a regular course of allowing the soil to get into a certain state of dryness before watering, without taking into consideration the immense difference in the amount of evaporation which takes place in the summer time when the days are long, and the amount of light and sunshine produce a light and dry atmosphere which plants cannot withstand without showing signs of distress if the soil in the pots is allowed to become too dry. Another point which must not be overlooked is to find out the conditions of the plants in regard to drainage and the amount of roots they have. With good drainage and plenty of root action going on it is really surprising what large quantities of water such things as Tomatoes, Spiræas, Fuchsias, Chrysanthemums, strong-growing Ferns, and many other plants, require to ensure their fullest development. When once plants have been reared to a high state of cultivation the greater is the check which they receive if allowed to become too dry, because the large numbers of active rootlets are so dependent upon a plentiful supply of water that they quickly perish if it is withheld at the critical time.

“To allow plants which are in a robust condition and well supplied with roots to become as dry before giving water as others more recently potted, or through other causes with less root action, would be to court failure, which would inevitably follow. The one might be greatly benefited by thorough waterings two or three times a day, while the other would not require it oftener than once a day, or in some cases two or three times a week. The practice of rapping pots with the knuckles or a small mallet made for the purpose is doubtless a good one with many classes of plants, such as Heaths, Carnations, Azaleas, and many others; but even then it does not do to depend entirely upon the rapping test, as pots vary so much in the state of their hardness or porosity. In the case of hardwooded plants, however, it is perhaps the best test which can be generally applied, but with the majority of softwooded plants in the summer time those who attend to them regularly can usually tell at a glance by the surface of the soil and the appearance of the foliage whether or not water is required. In the case of strong plants with the soil crammed with roots two or three waterings a day in hot weather is often needed, and at each application enough to thoroughly moisten every particle of the soil should

be given; but I have seen instances in which these frequent waterings were carried too far, with the result that the plants suddenly collapsed. Due care therefore must be exercised to find out the true condition of the soil. Because a plant required water twice or thrice yesterday and the day previous that is no reason why it should require as many applications each day. A slight change in the aridity of the atmosphere, the amount of moisture, or the growth determine the necessity for a greater or less supply of water. With plants that require water more than once a day, after the first daily application is given the safe course to follow, if any doubt is entertained about giving the next supply, is to allow the soil to become slightly drier than at the previous watering, and by watching closely the effect this little variation has on the appearance of the plant will be a useful lesson in watering, and a continual succession of these useful lessons must be constantly going on to enable anyone to become an expert in the work, and so changing and varied are the conditions under which watering has to be conducted that even experts, to be generally successful, must be students as well."

Since the above remarks were written rain has fallen more or less plentifully in some districts, much good having been thereby done; but much good water was wasted through lack of tanks for storage.

APPLE SCAB—CRACKING IN PEARS.

(Concluded from page 493.)

Now, it must be observed that this ammoniacal carbonate of copper solution is at the rate of 1 oz. carbonate of copper to 10 gallons of water. This is very strong and double the strength at which it is safe to use it on Apple or Pear foliage in a moist climate where the foliage is of necessity tender textured. The strength recommended no doubt answered well on trees in the dry atmosphere of Washington, but in Wisconsin, with the moisture of the lakes, Mr. E. S. Goff found a lessened quantity successful; in fact, the quantity of carbonate of copper is not more than 1 oz. to 20 gallons of water, as will be seen from the following taken from "the seventh annual report of the Agricultural Experiment Station of the University of Wisconsin," which contains a report by Mr. E. S. Goff on the "prevention of Apple scab." The solution used was composed of "1½ oz. of carbonate of copper, 1 quart of liquid ammonia, and 90 quarts of water." The trees were sprayed seven times, commencing May 18th, at which time the petals had all fallen from the flowers and the young fruits little larger than peas. The sprayings were repeated on May 30th, June 4th, June 17th, July 1st, July 24th, and August 10th. Other preparations were used—viz., soda hyposulphite, potassium sulphide, sulphur and lime in suspension, and a liquid solution of sulphur; but though benefit were derived from all the ammoniacal carbonate of copper solution showed best result. The trees on which it was used gave the following percentages:—First quality fruits, 75.0; second quality fruits, 23.4; third quality fruits, 1.6. Unsprayed trees gave:—First quality fruits, 23.3; second quality fruits, 54.0; third quality fruits, 22.7. This is very satisfactory, but Mr. Goff states that "owing to the very abundant and frequent rains during June our work did not show as well the past season as in the season of 1889."

The carbonate of copper used in the above experiments is 1 oz. to 20 gallons or water, or 1½ oz. to 22½ gallons of water. Amateurs wishing to give it a trial may use one-eighth oz. carbonate of copper, dissolving in 4 ozs. of liquid ammonia, and diluting with 10 quarts of water—2½ gallons. Prof. Taft, Michigan Agricultural College, advises a modified formula of Eau Celeste, and different from the Eau Celeste modified formula of Mr. Galloway Farmer's Bulletin No. 4, United States Department of Agriculture, 1891; therefore I give both. Mr. Galloway's "Eau Celeste, modified formula.—Dissolve 4 lbs. of copper sulphate in 10 or 12 gallons of water, add 3 pints of strong ammonia, dilute to 50 gallons, and add 5 lbs. of common washing soda. Stir thoroughly, and the solution is ready for use." This is not recommended for Apple scab, but is given as showing the difference in strength recommended by different individuals in different localities, and as pointing to the need of growers exercising judgment in the use of fungicides.

With respect to Eau Celeste for Apple scab Prof. Taft states: "In a favourable season I think you would have best results from perhaps three applications of modified Eau Celeste, made by dissolving 2 lbs. copper sulphate in one vessel, 2 lbs. carbonate of

soda in another, pouring together and adding 1 pint of 20° ammonia and 32 gallons of water. If it comes off cold and wet just before the blossoms open I should spray them. Never spray while in blossom on account of the bees. You will find this an insecticide, but I am not sure whether it can be relied on to destroy the codlin moth. Never add any arsenite to the fungicide, as the ammonia will dissolve it and the foliage will be injured."

Mr. E. S. Goff, of the University of Wisconsin, advises those who are spraying with Paris green for the codlin moth and caterpillars to add also precipitated copper carbonate powder to the water in the proportion of 1 ounce to 25 gallons. This seems to me just the thing to use in this country for the destruction of Apple scab, Pear crack fungi, leaf-eating caterpillars and codlin moth grub. We do not want such strong doses as are necessary in the hotter climate of America, but the question is, Will the carbonate of copper suspended in water prove as efficient as that dissolved in ammonia? or is not the dissolving of arsenite a myth? I cannot understand how Paris green is to escape dissolving in water. It may be urged that it does not remain long enough, or that there is next to no ammonia in water, but there is some, and that must dissolve some arsenite. Then there is the ammonia descending in rain and ammonia ever present in the air. Then how are we to account for the greater potency of Paris-green paste as compared with powder? Surely we are not to ignore the solvent power of rain on arsenite, nor exclude the part solved from inimically acting on fungi. Indeed it seems to my limited vision that we have little to fear from the dissolving of arsenite, and only need to do it and use more water, and prevent and destroy fungi and insects with one substance and one labour. In the "Canadian Horticulturist" (May 1891, p. 133) it is stated:—"Gooseberry Mildew.—Mr. A. Morton, of Brampton, has experimented with ammoniacal Paris green for Gooseberry mildew, and has found it quite effective. He dissolves one-half teaspoonful of Paris-green in ammonia, mixes it in 5 gallons of water and sprays it upon the bushes."

In the *Journal of Horticulture* of May 18th, 1891, page 434, spraying Gooseberry bushes with Paris green for the destruction of red spider and caterpillars is recorded to have been practised successfully as regards destroying the pests, and no one seems as yet to have been poisoned. But the infinitesimal quantity of arsenite dissolved in this country is very small compared with the quantity that is dissolved on the continents of Europe and America and sent to us in the shape of imported fruit. What we have had and what we may expect are different things, but it may be stated that Paris green has long been used on the continent as a remedy for black fly (*Aphis cerasi*) on Cherries, and "dolphin" on Beans. This is all nothing compared with what we are to have from Canada if the recommendation contained in Bulletin No. 10 of the Central Experimental Farm Department of Agriculture, Ottawa, Canada—"Treatment of Apple Scab, Grape and Gooseberry Mildew"—is followed. Mr. Graig recommends a trial of "carbonate of copper, 1½ oz.; ammonia, 1½ pint; Paris green 1½ oz.; water twenty-five gallons," as a combined fungicide and insecticide. This looks like business, and so far as I can see we might just as well dispense with the copper altogether, and trust to the dissolved Paris green, for there is not a thing living that arsenite will not kill. It is only a question of finding out what quantity to use for the destruction of fungi and insects without injuring the foliage of the trees, or causing so much to be absorbed by the fruit as will not injure these eating it.

But to return to scab in Apples and cracking in Pears, Mr. Graig recommends an ammoniacal carbonate of copper solution:—"Carbonate of copper, 8 ozs.; ammonia, one gallon; water, 100 gallons: or, carbonate of copper, 2 ozs.; strong liquid ammonia, one quart; dissolve the copper in the ammonia, pour into a barrel, and add twenty-five gallons of water." These solutions are to be sprayed on in June or July. I think some remarks are demanded in respect of the quantities of copper recommended to be used for the prevention and destruction of Apple scab fungus. To recapitulate, Mr. Galloway advises 1 oz. carbonate of copper to ten gallons of water; Mr. Goff, 1 oz. to twenty gallons; Mr. Graig, 1 oz. to twelve and a half gallons. These varying proportions are very interesting and instructive. The first has to deal with a dry climate, the second with a comparatively moist, and the latter with a more dry than moist. Those considerations account for the discrepancies.

But the most remarkable feature is the recommendation by Prof. Taft of Eau Celeste for the Apple scab. The Apple, though the commonest and hardiest of our fruit trees, is most susceptible of injury from fungicides or insecticides. It detects anything strong, and bears more ills in the shape of fungi and insects than any other fruit tree, excepting the Vine. Professor Taft seems to have hit upon the right thing for the Apple in a moist climate. The solution is not quite a three-quarter per cent. of

sulphate of copper, and it is dissolved to strike and kill the spores of the Cladosporium, and soda to harden the tissues; whilst the ammonia and sulphur energises the diseased parts. We'll may be think that modified Eau Celeste gives the best result, inasmuch as "in his experiments he has saved from 50 to 75 per cent. of fruit that otherwise would have been scabby."

What our American friends recommend is:—"First, in the early spring, before the leaves appear, spray with a simple solution of sulphate of copper, made by dissolving 1 lb. of sulphate of copper in twenty-five gallons of water. This is for destroying any germs of the scab that may be lodged in the crevices of the bark."

"Second, as soon as the petals have fallen, and it would be no longer safe to apply this strong solution, ammoniacal carbonate of copper may be applied. This is prepared as follows: 3 ozs. of precipitated carbonate of copper are dissolved in one quart of ammonia, strength 22° Bume. Dilute with 32 gallons of water." This is a near approach to Mr. Galloway's formula, and is far too strong for use in this country. According to our experience 1 oz. carbonate of copper is ample for 20 gallons of water; but it is easy to ascertain by experiment on a few growths the safe strength at which the copper solution may be applied. This should always be done.

"Third, if the weather be moist and cool, and consequently, favourable to the development of the scab fungus, it would be well to repeat the application of the ammoniacal carbonate of copper once or twice during the summer months."

It only remains to add that, if the trees are not satisfactory in growth, a top-dressing in autumn or early spring of some approved fertiliser will do good, or the following may be used: 5 cwt. steamed bone-meal, 2 cwt. kainit, $\frac{1}{2}$ cwt. sulphate of iron, mixed, per acre. If growth is wanted add $1\frac{1}{2}$ cwt. sulphate of ammonia for clay or loamy soil, or $1\frac{1}{2}$ cwt. nitrate of soda for light and calcareous soils, applying this in three instalments, namely, in March, May, and early June respectively.—G. ABBEY.

RECORD OF EARLY STRAWBERRIES.

It may be interesting to the readers of the Journal to give the dates when the first ripe Strawberries have been gathered here from 1881 to 1891, the variety being Alice Maud planted in a 12-acre field that is favourably situated, sloping gently to the south, and sheltered from the north and east by trees. They receive no artificial protection whatever. We gathered fruit as follows:—

1881.—2 lbs., June 11th.	1887.—30 lbs., June 20th.
1882.—14 lbs., June 5th.	1888.—5 lbs., June 23rd.
1883.—10 lbs., June 16th.	1889.—24 lbs., June 14th.
1884.—1 lb., June 12th.	1890.—12 lbs., June 14th.
1885.—2 lbs., June 5th.	1891.—12 lbs., June 22nd.
1886.—5 lbs., June 19th.	

It will be observed that 1882 was the earliest and 1888 the latest season. The market price has fallen about 40 per cent., as on June 11th, 1881, I have entered 4s. per lb., and to-day, 22nd June, they are 2s. 6d. Of course this is wholesale price and for best dessert fruit.

I may remark here that the frost on Whit-Sunday morning did more damage than ever had been done since I commenced growing Strawberries. It has taken all the best fruit—in fact, thinned them in the rudest possible manner.

With regard to the best variety for early use for market, such kinds as Black Prince and King of the Earlies are useless, being too small. I planted an acre in March, 1890, half with Marguerite and half with Alice Maud, with one row of Noble down the centre, 140 yards long, to divide the two other kinds; thus I have an easy task of observing which is the earliest to ripen. I find Noble and Alice Maud a dead heat, with Marguerite three days later. The fruits of Noble are larger than Alice Maud, but less in number; but this is not a season for condemning or praising Strawberries, as they have not had a fair chance. As far as this field is concerned my old friend, Marguerite, is not yet outdone by Noble. Every grower ought to try Noble, as it is early and handsome to look at. I have no doubt that when grown by hundreds of acres it will considerably reduce the price of early Strawberries.—T. SHARPE, Virginia Water.

CELMISIA SPECTABILIS.

MUCH interest was excited by the plants of this dwarf little Composite exhibited by Messrs. J. Veitch & Sons of Chelsea at the meeting of the Royal Horticultural Society on June 9th at Westminster. Novelties of a really distinct character are becoming very scarce amongst miscel-

laneous plants, and this renders them all the more valuable when they do appear, and that is one reason why the *Celmisia* attracted so much notice. Apart from this, however, the plant evidently possesses sufficient merits to make its way in popular favour. At the meeting in question an experienced and retired market grower remarked that "such a plant as the *Celmisia* would a few years ago have realised a small fortune for market culture in pots."

It is strange that the genus *Celmisia* is almost ignored in gardening and botanical dictionaries. For instance, the name is not found in the "Treasury of Botany," Paxton's, Johnson's, or Nicholson's dictionaries, or in several other scientific or popular works. The characters of the genus were, however, given in De Candolle's "Prodromus" in 1836, and a place was assigned for it in the family Compositae between *Tussilago* and *Brachyglottis*. Only two species are described—name'y,



FIG. 95.—CELMISIA SPECTABILIS.

longifolia and *spathulata*, both natives of New Holland, and of which the describer had only seen dried specimens. In Hooker's "Flora of New Zealand," however, ten species with several varieties are described, and some are figured. Those described include *holosericea*, *verbascifolia*, *coriacea*, *Mackeani*, *spectabilis*, *gracilentia*, *incana*, *hieraciifolia* (or *hieracioides*), and *glandulosa*.

Celmisia spectabilis is the only species which has yet been shown at the Royal Horticultural Society's meetings and secured a first-class certificate, but it will no doubt be followed by some others, though it is not likely to be surpassed in its principal characters. The specimens shown were about 6 inches high, with narrow lanceolate leaves, white and woolly on the under surface. The flower heads are 2 inches in diameter, with closely set, narrow, pure white ray florets and a golden disk. Being very compact, it is well adapted for culture in pots in a cool house, or it may be found useful out of doors when more plentiful.



MODES OF CHRYSANTHEMUM CULTURE, AND THE BEST VARIETIES.

[A paper read by Mr. Woodcock, Syston Nurseries, Leicester, at a recent meeting of the Sheffield Chrysanthemum Society.]

AT a meeting of a Society like ours no apology should be needed for treating this subject on broad lines, as the Society embraces amongst its members and supporters not only exhibitors or those who grow only on the lines usually adopted for producing exhibition flowers, but many who do not attempt such modes of culture, and still are lovers of the flower in whatever form it may be produced. Although the present is what may be termed a dual Society, composed of what were two distinct Societies, I have a very clear recollection of the formation of both, and also of their respective prospectuses, setting forth the aims and objects of each of the two Societies, which were issued at their formation, and in these two documents there was a very strong argument in favour of that amalgamation which has taken place and is working so well. They both agreed in stating it as being one of the main objects of the Society to assist in popularising the flower and in improving the cultivation thereof. Now such being the objects with which each Society commenced operations, it is worth while to inquire how these objects have been achieved, and I certainly think that neither Society is open to reproach in that matter. When the first Chrysanthemum Show was held in the Cutlers' Hall, Sheffield, gardeners certainly could not boast of the excellence to which they had then attained as cultivators; but now there are not lacking those amongst them who are not afraid to compete against the best growers in England. Also such excellent cultivation is by no means confined to the limited few who are exhibitors at one show, but may be met with in—I had almost said—hundreds of gardens, the allotment gardens of the artisan as well as the conservatories of the rich. This condition of things also is not by any means singular to Sheffield, but is the rule almost throughout England, especially in those towns where societies like the present have been for some time in existence.

These facts are, I think, sufficient testimony to the value of such societies as ours and to the good works they are achieving; but I have as yet not stated the whole case, and I may say that it is only during the last season since I have been more fully engaged as a market grower that I have fully realised that for five months out of the twelve of each year the Chrysanthemum has become the most important and principal flower in our markets, and consequently the principal flower in use for all purposes of wear and decoration, wreaths, &c., those months being September, October, November, December, and January. Who shall gainsay the fact, then, that the Chrysanthemum is our autumn queen? and my wish is that long may be her reign. In September we commence by taking in cut flowers, cut from bushes in the open gardens of the earliest of what are known as the summer flowering varieties, such as Early Flora, Nanum, Madame Piccol, Early Blush, and Blushing Beauty, and, although at that time there are not lacking in the markets plenty of good summer flowers, such as Roses, Carnations, Mignonette, and Asters, yet we found that these bunches of small Chrysanthemums were preferred by many. Not many purchasers are, however, found for these varieties as pot plants in flower. With the advent of October, however, there commences a brisk trade for good pot plants of such varieties as Madame Desgrange, Mrs. Hawkins, G. Wermig, and Roi des Précoces, with cut flowers of later types of summer flowering sorts which are sold readily, especially varieties having decided colours, such as Roi des Précoces, dark crimson; Madame Desgrange and Mrs. Cullingford, white; and Alice Butcher, terra cotta, a favourite colour with ladies.

With November comes what is known as the Chrysanthemum fever, when everybody who is anybody talks about Chrysanthemums and wears Chrysanthemums. Throughout December the Chrysanthemum continues the principal flower in our markets, and practically the only one which can be obtained in any considerable quantity. The varieties principally on sale at Christmastide last season were Princess Teck, Lady Dorothy, Mrs. Norman Davis, Jardin des Plantes, Fair Maid of Guernsey, and Ethel, also large quantities of Mdlle. Lacroix, mostly imported from the Channel Islands. With January there came a considerable reduction in the number of varieties obtainable, as also in the quantity offered; but even then a glance at the windows of our leading florists sufficed to show that through this month Chrysanthemums continued to be the principal stock flower, and to be largely used for room decoration, and for the making of wreaths, crosses, and bouquets. White is then almost the only colour obtainable, and Ethel appears still to be the variety principally grown for January flowering. The fact, then, that Chrysanthemums are required and are obtainable in quantities over such a large slice of the year is proof in itself that the modes of culture adopted must be various, and I trust I may usefully spend the short time at my disposal in reviewing some of these.

I will first mention the early summer flowering varieties. These are indeed a very useful section, and give a good return in cut flowers, with

a less expenditure of time and labour in the production thereof, than does any other section. Most of the varieties do not as a rule succeed well if kept in pots throughout the summer, but are much more satisfactory when planted out, and if necessary care is taken in lifting them, and for a fortnight after so doing, whilst they are getting established again, they scarcely appear to suffer at all by the process. Last season I planted out about 300 which did so well and gave us such good returns that I have this season planted out nearly double the number.

My mode of cultivation is as follows:—The cuttings are struck at any time from Christmas to the end of January. (I do not care to take them earlier, as if I did so they would become much root-bound in the 3-inch pots in which they are kept until it is safe to plant them out.) I root them in 4-inch pots, six or eight cuttings in each, and as soon as rooted they are potted separately in the 3-inch pots, in which they remain until it is safe to plant them out (usually early in May). The top is pinched out of them as soon as they commence to grow freely, to cause them to break, and they are again pinched when the breaks are 3 to 4 inches in length, after which they are not again pinched or stopped. I need scarcely say they are kept in a cool airy temperature from the time they have commenced growth after potting until they are planted out. The work required to be done to them during the summer consists almost solely and alone of an occasional use of the hoe amongst them to keep down the weeds. A fortnight before I want to lift them, which is usually late in September, a man goes round each plant with a spade, and cuts down all round the plant to the full depth of the spade, and about 6 inches from the stem, thus cutting through all roots extending beyond that distance, so that the roots left are comprised within a ball of about 1 foot in diameter. When the spade is in the ground it is given a little pressure, forward and backward, and carefully withdrawn, thus leaving a slight open cavity round each plant. When a few rows have been thus treated he commences with the watering cans, and gives to each plant a thorough soaking of clear water, pouring it into the cavity, left open all round, which is thus soaked to the bottom, and causes the cut roots to quickly form bunches of small rootlets, which are of great assistance to the plant when it is lifted.

Before commencing lifting we clear out a good sized Cucumber house, the plants in which are by that time pretty well exhausted; and then in lifting a selection is made of the neatest and best plants for potting, all the remainder being carried straight into the Cucumber house, and planted somewhat thickly together on the benches in the mould which has composed the border for the Cucumber plants. The house is shaded and kept rather close with a moist atmosphere for a few days, until they begin to take hold of the soil, the result being that under this treatment last season they scarcely ever showed signs of distress or flagging. A fortnight after planting that house was a picture to behold, being a perfect mass of flowers from end to end, and I am speaking well within the mark when I say we cut bushels of useful flowers therefrom during October. Those potted are, of course, given similar treatment in another house.

The most useful varieties for this work are Alice Butcher (orange), Blushing Bride (rose), Flora (yellow, very early), Fred, Pélé (crimson), Fiberta (yellow), Golden Shah (yellow), Grace Attick (white), Lyon (crimson purple), Miss Davis (pink), Mrs. Cullingford (white), Madame Desgrange (white), G. Wermig (primrose), Mrs. Burrell (primrose), Mrs. Hawkins (yellow), Alexandre Dufour (violet), and Roi des Précoces (crimson, tipped gold). The last six varieties, commencing with Madame Desgrange, are the only ones in this list of any use to take into the market as pot plants, the others, however, being all useful for cut flowers. We have quite a large number of newer French varieties of like character, we are growing this season for the first time, several of which have received certificates, and I expect from them will come some useful and permanent additions.

A word in passing as to Grace Attick, a new introduction of last year, and said to be the earliest of all. I did not find it so. With me last season it did not flower until late in October, but one could not but admire it when it did come—a large, pure white, quilled flower, produced freely from the top, with smaller neat useful flowers on short laterals all down the stem, produced simultaneously with the larger ones at top. It is of dwarf wiry habit, rather weakly growth until the plants have attained size, and a difficult variety to propagate; but it is certain to become a useful and popular variety for producing cut flowers in quantity when better known.

EARLY JAPANESE AND INCURVED VARIETIES.

Leaving behind us now the strictly early autumn and October-flowering section we are met with a number of well-known varieties, both Japanese and incurved, which follow them very closely, and may readily be had in bloom by the end of October if such is desired. In Japanese the best are Lady Selborne, James Salter, Margot, Madame La Comtesse Foucher de Careil, Wm. Holmes, and L'Ile des Plaisirs. In incurved the best are Mrs. G. Rundle, Mrs. Dixon, and George Glenny. Quite a large number of these three varieties are grown in many market establishments specially for producing the best class of cut flowers at the end of October and early in November, and when well grown they sell freely and for good prices, being much appreciated just then by ladies for use as single flowers in specimen glasses for table decoration, and also for personal wear. The mode of culture adopted for them is to strike the cuttings in November and grow them as stiff and sturdy as possible, pinching them twice, or in some cases three times, to secure sufficient breaks, so that when each plant has been disbudded it

will carry from twelve to twenty flowers. They are grown in pots throughout, finished usually in 9-inch pots, and treated thus give flowers almost, and save only for size, quite good enough for exhibition. One of our leading Leicestershire nurserymen and florists (Mr. Hickling of Loughborough), who grows Chrysanthemums extensively and well for exhibition as well as for market, told me last season that his Glennys and Rundles grown as above for cut flowers paid him better than any other Chrysanthemum he grew.

(To be continued.)

FRUITS IN CALIFORNIA.

ABOUT the time I was reading Mr. Laing's paper on "Horticulture in the United States," as read before the Birmingham Gardeners' Association, I had before me statistics showing the extent of California's fruit and wine crop for last year (1890), and also an account of the first experiments in orcharding in 1851, conducted Mr. William Neely Thompson, a member of the Society of California Pioneers. The record of Mr. Laing's observations must have been of great interest to English gardeners and florists. For my own part I much regret that he did not come to California, for while floriculture here is not yet so advanced an art as in the eastern States, yet Nature has done more than enough to make up for it. But when we come to fruit growing, had Mr. Laing visited us, he would have seen more to have interested him in that line than in all the other States of the Union.

In 1851 Mr. Thompson, before alluded to, commenced the planting of an orchard of some 9000 trees in the Lower Napa Valley, near the Napa Creek, and just above tide water, as practically no rain falls here between May and October. This site was selected as being moist and rich, but the Spanish settlers told him it was "no good," the trees would not live. However, it proved a success, and this orchard was for years the "show" orchard of the State. It cost the owner between 80,000 and 90,000 dols. to get the trees from the East, mostly from Ellwanger and Barry of Rochester, New York, the expense of transportation by Panama being so great.

Subsequently it was discovered that fruit trees would do even better on the uplands and hill sides, all that was needed to promote vigorous growth being a thorough stirring of the soil by horse cultivation throughout the spring and summer. There are many individual orchards now of from 1000 to 2000 acres in extent. Planting commenced forty years ago, slowly increasing until about 1879, when orchard planting was carried on with great zeal, and in many parts of the State. The first orchard alluded to was about forty-five miles north of San Francisco; the planting extended in the vicinity of San Francisco Bay, and along the coast, but has now reached the extreme southern portion, San Diego, 600 or 700 miles from the Suscol orchard of Mr. Wm. N. Thompson. The last few years has seen great planting in the warmer interior valleys and plains, where the soil is even richer than near the coast. Oranges, Lemons, and other semi-tropical fruits are grown in Southern California, where it is necessary to irrigate, owing to lighter rainfall, but with equal success in the upper Sacramento Valley and parts of the San Joaquin.

The following figures may seem somewhat startling, but they are facts, and culled from the report of Mr. U. P. Chipman to the State Board of Trade, who had access to the railroad companies' books to ascertain the amount of goods shipped.

In 1890 there were shipped by rail from California to points in the Eastern States 323,915,181 lbs. of fruits, or, in other words, 16,194 carloads, the whole making a train of cars 123 miles long. In 1880 were shipped 546 carloads, making an increase in ten years of 15,648 carloads.

While for many years "Wheat has been king" in California, the last year's exports show an increase in value of fruits over the Wheat crop of 530,660 dollars. The total value of the above fruit crop is estimated at 19,857,826 dollars—that is, the value at the orchard or vineyard. Itemised, the list would be as follows:—

Green deciduous fruits, 68,084,124 lbs. at	2½ cents,	\$1,702,103
Dried " " 64,595,181 lbs. at	12½ cents,	8,074,397
Raisins 41,120,330 lbs. at	6¼ cents,	2,570,020
Nuts 1,574,230 lbs. at	10 cents,	157,423
Canned fruits 80,121,950 lbs. at	3 cents,	2,403,658
Oranges 1,028,700 bxs. at	\$1 75 cents,	1,800,225
Grapes in wine 18,000,000 glls. at	15 cents,	1,700,000
Grapes in brandy 1,000,000 glls. at	45 cents,	450,000

\$19,857,826

The present year promises a much larger yield, and the orchard planting goes on as largely as ever.

I cannot imagine any more instructive or interesting trip for an English farmer or fruit grower than to visit California during the

fruit season. It always seems deplorable when such men as Mr. Laing will cross the ocean and not continue their trip westward to the Pacific coast. All such would be welcomed by—LEONARD COATES, Napa, California.

HARDY PLANTS.

[A paper read by Mr. ALBERT F. UPSTONE at a recent meeting of the East Anglian Horticultural Club, Norwich.]

MY intention in this paper is to take a survey, as it were, of those hardy plants that are best known, and to give a short description of their relative merits. I propose first of all to deal with the yellow flowered plants, and will head my list with one which, although widely known, is not the less appreciated, and that is the Rudbeckia Newmanii. This superb plant with its golden yellow flowers and black disc is, in my opinion, second to none in noble appearance or floriferousness, and should find a place in every garden. R. californica and maxima should not be overlooked, although not partaking of the neat and elegant appearance of Newmanii. Helenium pumilum, another neat and beautiful plant, is well liked on account of the great demands one may make on its abundance of bloom continuously through the summer, of a beautiful buttercup yellow. Helenium Colandesi, another species which came under my notice when living in the South of London, and which, I believe, came from that grand collection once held by Mr. Parker of Tooting, should not be passed without comment. It reveals a somewhat darker disc than pumilum, and grows fully 3 or 4 inches higher, but not so free flowering perhaps.

Harpalum rigidum is very showy, although by no means adapted for carpet bedding—that is to say, it is more suitable for the shrubbery border or amongst plants of a like height, and will add a great charm amongst evergreen shrubs, as it attains a height, when fairly established, of some 4 feet. Erigeron aurantiacus is exactly the reverse of the foregoing when neatness is taken into consideration, and may be regarded as a perfect gem in hardy plants, and not by any means common, attaining a height of some 9 inches only. Coreopsis lanceolata and grandiflora may be bracketed together, not but that they are unlike, and the latter is the better, but because, so far as I have observed, their demands are very much the same, and in colour and in height they are similar, although grandiflora is more uncommon than lanceolata. These are very similar in growth to the annual Coreopsis tinctoria and others, and are certainly much lighter in appearance and more admirably adapted for decorating epergnes, &c., for the dinner table than the foregoing vars. of Rudbeckia, &c., which are more or less stiff. The Perennial Sunflowers, Helianthus multiflorus major, m. plenus, m. grandiplenus, rigidus, praecox, &c., should be included wherever a quantity of cut flowers is in demand.

Amongst all the yellow varieties, however, the superb Inula glandulosa perhaps can claim the most originality, in the sense that it is most distinct from all others, and not too lavish, although by no means a shy bloomer in its revelations; it attains a height of some 4 or 5 feet. The various species of Trollius, europaeus, asiaticus, and others, should have some passing comment amongst the yellows, they being of dwarf habit, and masses of bloom. Linum arboreum, in formation of flower very like the familiar annual grandiflorum, is a valuable addition to the yellows, and does not exceed more than a foot in height.

The Prophet Flower (Arnebia echioides) I do not think is too well known, is very dwarf and free flowering, and has the peculiarity of being dotted with blackish spots, which disappear gradually as the blooms are in course of development. Ranunculus acris plenus, the old double yellow Bachelor's Button, here rises in my mind, but is too well known to be dealt with fully. Adonis vernalis is conspicuous for its peculiar Anemone-like appearance, golden yellow. Alyssum saxatile compactum, or Gold Dust, as it is commonly called, is well known and deservedly popular for early spring flowering. The Doronicums must be deemed absolutely indispensable, coming into flower when a profusion of bloom is so desirable. Young's Enothera must not be forgotten when forming an herbaceous border, as it is quite worthy a front rank, dwarf and showy.

I will now refer to the shades of blue and kindred colours, and these are extremely sparse in herbaceous plants, or indeed in any other class of plants at present. Stenactis (Erigeron) speciosa shall head my list in this section, being of a distinct mauve colour, and unlike in shade any flower which I know. Aster amellus bessarabicus and others of this family are valuable, yielding a profusion of cut bloom. Lithospermum prostratum is a beautiful dwarf shrubby plant, of a most intense blue, and very free flowering. Tradescantia virginica may be well known, and possess no distinctive merits beyond the fact that it will thrive in wet, boggy places where others fail. Catananche carulca is a pretty lilac blue, but is of a straggling nature, and requires an amount of attention to keep it within bounds.

Polemonium Richardsoni and himalaicum are again two comparatively dwarf and desirable plants, and should be in every herbaceous collection, of a beautiful pale blue colour and extremely pretty foliage. Anchusa italica, a robust plant, in height about 4 feet, producing small flowers of an intense blue, is pretty, and very effective with suitable surroundings. Centaurea montana (the perennial Cornflower) very dwarf, and useful for cutting purposes. Geranium ibericum, another perhaps valueless plant for cutting purposes, but a useful addition to the blue section, blooms in masses and makes an imposing bed. Aconitum pyramidale and japonicum, two very pretty species of the poisonous Monkshood, both attain a height of some 4 feet, and produce a profusion

of bloom of a shady blue. A bicolor, a blue and white species, should not be overlooked; neither, by the way, should I suppress the fact that, taking all things into consideration, the Monkshood being deadly poison, it is not advisable to be grown where children are about. *Scabiosa caucasica* has been very highly spoken of through the horticultural press during the past few years, and deservedly so, being as large as a five-shilling piece, of good substance, and a charming statey blue in colour. *Delphiniums* I might dilate upon at length, but I will merely give them this passing note, that they are indispensable for the herbaceous border. *Agapanthus umbellatus* is very valuable, and its foliage is also very ornamental; flowers a bright blue colour. *Gentiana acaulis*, *verna*, and others are amongst the very best in blues, and cannot be ignored. *Statice latifolia*, the Sea Lavender, shall end my list of blues, though for merit it may well have taken first place, producing masses of dark blue flowers, invaluable for cutting, and when dried will last for months.

The red and rose varieties, embracing pink and light shades, next demand attention. I cannot better commence than with the charming *Senecio pulcher*, to my mind a fit companion for *Scabiosa caucasica* above mentioned, differing of course in colour, which is a superb rose. *Achillea millefolium roseum*, a pretty rose variety of the common Yarrow of the fields, comparatively dwarf, but a little too apt, perhaps, to fade as the blooms develop, particularly when exposed to the sun. *Lychnis chalcedonica*, or the scarlet *Lychnis* as it is commonly called, is a desirable variety of an intense scarlet, but fading very quickly when out. *L. Haageana* is an exceedingly pretty flower, attaining a height of about 1 foot, good-sized, rose-coloured flowers 1 to 2 inches in diameter. *L. viscaria splendens plena*, too, should not be excluded, very dwarf, free of flowering, and richly coloured. *Papaver nudicaule*, the Iceland Poppy, than which a more lovely flower is not grown, colour a bright yellow, lasts well when cut, extremely pretty foliage, and, except in very exceptional winters, perfectly hardy. *P. nudicaule miniatum*, brilliant scarlet, deserves more than a passing comment. *Agrostemma Flos Jovis* and *coronaria fl.-pl.* (the latter a double variety of the "Rose Champion") are two very pretty little flowers, attaining a height of about 2 feet, of a beautiful rose colour, and a somewhat velvety texture.

Two varieties of *Epilobium*, or Willow Herbs, *angustifolium* and *variegatum*, I would particularly warn all herbaceous plant collectors to studiously avoid importing into their gardens, as they are both of a rank and creeping nature, and are not easily got rid of when planted. *Geum coccineum plenum* requires only to be mentioned, its large brilliant crimson flowers being very desirable for cutting. Some other *Geums* might be enumerated, but they pale into insignificance beside the afore-mentioned. *Heuchera sanguinea* is certainly unique in its handsome appearance. Its dwarf and branching habits, coupled with the charming orange scarlet flowers, and the abundance with which the loose spikes are produced, render this the most valuable acquisition to our hardy collections, but be sure you secure a good variety, as there are many weedy ones. *Lythrum roseum superbum* with its massive spikes of red flowers will enliven the shrubby border, attaining a height of about 4 feet. *Anemone japonica* must perforce be mentioned as indispensable for autumn blooming, and is very free. *Chelone obliqua*, a quaint but not undesirable plant, producing spikes of bloom of a pretty rose tint, of very sturdy, albeit rather stiff habit, is a desirable plant to have, it is about 2 feet high. *Dictamnus fraxinella*, or Burning Bush, about 2½ feet in height, producing spikes of curious red flowers, should be cultivated, if only for its peculiarities. *Megasea cordifolia* should be planted where space is no object, as its foliage is very large, and produces large spikes of bright rose flowers. *Monarda didyma* or Oswego Tea is sweetly scented, spreads rapidly, flowers a bright scarlet, altogether desirable to secure. *Potentillas* are not to be despised, and are capital things for cutting. *Zauschneria californica* shall finish my table of red varieties. This is a beautiful bright vermilion, borne in pendent spikes, about 18 inches in height, and is very attractive.

Commencing the white-flowered plants, we have the beautiful *Thalictrum aquilegifolium*, the large pinkish white heads of bloom and foliage alike being most useful. It attains a height of some 3 or 4 feet. *Sidalcea candida* is another pure white variety, borne in spikes, and although freely propagated by division, I do not think is very common. It grows about 2½ feet in height. *Silene maritima fl.-pl.* somewhat resembles a Mrs. Sinkins Pink, though inodorous, very dwarf and compact, and invaluable for cutting. *Achillea Ptarmica fl.-pl.* with its profusion of miniature white flowers borne in masses can have but a passing comment; it is, however, one of the most useful.

The St. Bernard's Lily (*Anthericum liliago*), bearing spikes of Lily-like flowers in profusion, is not to be despised, as likewise *A. liliastrum*, of somewhat more substance than the preceding. *Campanula grandis alba*, a fine old-fashioned perennial, flowers as large as half-crown pieces, produced in spikes and obtaining a height of 3 feet, must not be discarded. *C. isophylla alba* can be seen in plenty all through the summer in Covent Garden, and is an exceedingly pretty trailing plant. *C. persicifolia alba pl. na* (the double white Bellflower) in growth similar to the single *C. grandis alba*, very free flowering and useful for cutting. *Centaurea montana alba* (the white Perennial Cornflower), by no means exclude when ordering, as its usefulness in every respect defies description, and lasts a long time when cut. *Chrysanthemum maximum*, *C. latifolium*, *C. uliginosum*, and *C. semi-duplex eclipse* almost all others in their freeness of bloom and aptitude to last for weeks almost when cut.

Now I come to a perfect gem, but be very choice with it if you can secure a plant, as it is very scarce. I refer to the charming *Cimicifuga*

raccmosa, a very bold showy plant seldom met with. For the edification of those who have not come into contact with it, I may say it produces its feathery white flowers in drooping clusters, most distinct from anything I know, but does not increase its stock very rapidly. *Dictamnus fraxinella alba*, a white form of the Burning Bush previously mentioned. *Anemone japonica alba* is a grand hardy plant, and provides us with an enormous quantity of pure white flowers which are of long duration, and will thrive almost anywhere. *Ranunculus amplexicaulis*, pure white and very dwarf, with yellow stamens, is one of our earliest spring bloomers. *R. aconitifolius plenus* (Fair Maids of France) is also a desirable pure white to have, and which throws plenty of bloom, grows 2 feet high, and does best in a moist situation. *Gypsophila paniculata*, wherever seen, arrests the attention of everyone, bearing, as it does, immense trusses of very small white flowers in great plenty, one of the most effective plants known, and is as useful for bunching with larger flowers as the well-known *Adiantum gracillimum*. *Iberis corraefolia* and *gibraltarica*, two perennial Candytufts, should command a place in every garden, blooming with great effect, and very early. *Saxifraga pyramidalis*, with its massive spikes of white flowers, is indispensable, and well-known to frequenters of Covent Garden in the spring. Had I no fear of trying your patience, I might refer to many hardy plants that are deserving of being cultivated for their foliage alone, but I hope to be able to do so at some other time. I am assured that the prevalent fancy for the revival of the old fashioned hardy flowers in our gardens finds sympathy, and that my few remarks will perhaps tend to the extended cultivation of some of them I have endeavoured faintly to pourtray. I will conclude by reminding you of the fact that most of those I have mentioned are easily increased by division, that the best time to do so is in the month of March or early in April, not forgetting that disturbing the roots in the autumn often leads to disaster and loss. Some, also, do not increase very rapidly, while others require lifting and potting during the winter. The seeing eye, however, will soon discern the requirements of each, and to no class is the familiar Latin phrase more applicable than to hardy plants, "Experientia docet."

HIGHFIELD, WOOLTON.

At any time of the year a visitor is sure to find something of interest at Highfield, the residence of W. H. Tate, Esq. Orchids are the leading feature, and several houses are entirely devoted to their wants; but if the Orchids form such a great attraction, it must not be supposed that other plants suffer in the slightest degree; on the contrary, whatever is taken in hand by Mr. Haigh, the genial gardener at Highfield, is grown to advantage. A short time ago I saw the splendid collection of *Lælia purpurata* in bud. The plants are as fine as can be seen, and continue to make magnificent growths and flower freely year after year. Last week they were in full flower, and a noble bank they were. There are about twenty plants and fifty spikes, averaging five flowers on a spike, and scarcely two plants alike. A fine plant of *Lælia purpurata alba*, carrying twenty-five flowers, was perhaps the most noticeable; *Lælia purpurata Russelliana*, with nine spikes and eleven leads; *Lælia purpurata splendens*, fifty growths and seven leads. Besides these were *Lælia purpurata Wyattiana* and two or three varieties of *Bysiana*. Some others, with golden throats and very dark lips, were charming. The plants are all grown in pots, and the treatment they get is of the best, and Mr. Tate is to be complimented on being the possessor of such a choice collection. In the same house was a capital plant of *Cymbidium Lowianum*, carrying eight strong spikes, twenty flowers on a spike. The markings are strongly defined, and the variety one of the best. *Oncidium crispum* was in bloom, fine well-flowered *Cypripedium Lawrencianum* and *Odontoglossum vexillarium Alexandræ* and *nebulosum* were very conspicuous; *Dendrobium Wardianum*, *Ainsworthi*, *Devonianum*, *Phalaenopsis thyrsoiflorum*, and *Findleyanum* were all growing vigorously, so was the rich strain of noble. The plants are chiefly imported pieces, and many varieties of exceptional merit are amongst them—*Cattleyas* by the hundred of such sorts as *Trianae*, *Mendeli*, *Sanderiana*, *Dowiana aurea*; the two latter, pushing fine strong sheaths, will be a treat later on. In the *Odontoglossum* houses the plants are pictures of health; *O. Harryana*, *O. rubellum* (the autumn-flowering variety) Mr. Haigh considers ought to be grown by everyone having room for it. *O. grande* and many others are to be seen in large numbers. *Oncidium tigrinum* and *Cavendishianum* were making extra strong growths, and I noticed some grand pans of *Cypripediums* and *Cœlogynes* growing freely. *Vanda cœrulea*, *V. Sanderiana*, and *Angræcum sesquipedale* are here in good condition.

Leaving the Orchids we come to a stage filled with Carnations in pots, and just opening their delightful flowers. Many of the plants were layered in the open last August and potted on, the plants being all in the best of condition. The chief varieties grown are *Germania*, *Pride of Penhurst*, *Mrs. Reynolds Hole*, the pink, crimson, and the old blush *Souvenir de la Malmaison*, whilst for a white Mr. Haigh considers *Mdlle. Carle superb*. It is a pity these lovely flowers are not seen in more profusion around Liverpool, where room may be found for their well being, and I hope the day is not far distant when we shall see them cultivated as freely in pots as other greenhouse plants. What can be more handsome than the group figured in your issue of last week; and we Liverpool people can look back with pleasure to the provincial show of the R.H.S., held in Liverpool, where a similar group was exhibited, and which found so many admirers. Another feature pleasing to note were seventy-two pots of a free flowering *Verbena*, named

Hill Cliff Scarlet, a variety of local origin. The flowers are intense scarlet, it is a good grower, and the plants will make a show in the conservatory during the summer. The stove is filled with a fine assortment of Crotons, Dieffenbachias, Impatiens, Caladiums, Dracenas, and Eucharis, chiefly used for house decoration. A small fernery contained a large quantity of Adiantum cuneatum and Platyceriums. The Peach houses contained fine crops of fruit, and in these houses close to the glass were a large number of *Lælia anceps* in variety, in which position they seem to revel. One of the best early Tomatoes I ever have seen Mr. Haigh pointed out to me in Horsfield's Prelude. The plants were growing in a narrow border, and literally laden with handsome bunches of well coloured but rather small fruit. It is a valuable variety, and the fruit sets evenly from every joint. Sutton's Earliest of All was also very fine, but the fruits were more corrugated. A fine crop of Muscats were swelling upon the old Vines, whilst the young ones were just commencing to fruit. A few pot Vines trained on trellis and carrying good bunches are grown for decorative purposes. The conservatory adjoins the house, and in it are placed some useful Palms, and some well cultivated Calceolarias were just at their best. The beds were being filled with plants for the summer, and although the grounds are not very extensive everything is in as perfect order as it could possibly be. Mr. Tait is an enthusiast in his garden, and if he does not exhibit it is not because the plants are in any degree behind those of his neighbours. If Mr. Haigh's name also is not seen at our exhibitions it is pleasing to note in these columns the good work carried out so well at Highfield under his guidance.—R. P. R.



ROSE SHOWS.

Now the Rose season has commenced it will be desirable to remind our readers of the dates of the principal gatherings. They are as follows:—

- June 25th (Thursday).—Ryde.
 „ 27th (Saturday).—Eltham and Reigate.
 „ 30th (Tuesday).—Canterbury, Diss, and Winchester.
 July 1st (Wednesday).—Bagshot, *Brighton, Brockham, Croydon, and *Lee.
 „ 2nd (Thursday).—Farningham and Norwich.
 „ 4th (Saturday).—Crystal Palace (N.R.S.)
 „ 7th (Tuesday).—Gloucester.
 „ 8th (Wednesday).—Dursley, Hitchin, Sutton, and Tunbridge Wells.
 „ 9th (Thursday).—Bath and Woodbridge.
 „ 11th (Saturday).—New Brighton.
 „ 14th (Tuesday).—Christleton and †Wolverhampton.
 „ 15th (Wednesday).—Ealing.
 „ 16th (Thursday).—Hereford (N.R.S.), Bedford, He'ensburgh, and Trentham.
 „ 18th (Saturday).—Manchester.
 „ 21st (Tuesday).—Tibshelf.
 „ 23rd (Thursday).—Halifax and Worksop.
 Aug. 1st (Saturday).—Ripley (Derby).

* Shows lasting two days. † A three-days Show.

THE NATIONAL CRYSTAL PALACE SHOW.

It will be in the recollection of the readers of the Journal that there was some correspondence in the winter as to the schedule of the Crystal Palace Show. It was alleged that large growers were unduly favoured, and suggested that they should be confined to the higher classes. I think the present season will show that this would be unjust. The weather is now warm and forcing; but it is sufficiently plain that with a continuance of cold weather during the three last weeks before the C. P. Show, a good proportion of the large growers, unless allowed to show in smaller classes, would be absolutely excluded altogether. I myself, as it is, see no prospect of being able to show more than twenty-four varieties, and I should think it very hard if I was not allowed to exhibit, or if any imputation was put upon me for entering for twenty-four, or even a lower class if I could not manage that. My Roses have only been fully out twice in the ten years or so that I have exhibited at the National Show; it is surely fair that on other occasions I and those in a similar position should be allowed to "cut our coats according to our cloth."

Although ordinary grubs and caterpillars are not more numerous than usual I find that a large proportion of buds showing colour have tiny caterpillars, which appear to have been hatched on the petals. This is a serious business, as of course actual damage is done directly the creature is hatched, and before it can be discovered.

We have lost three Rose Shows in East Anglia alone: Colchester, Ipswich, and Harleston.—W. R. RAILLEM.

NATIONAL ROSE SOCIETY'S SHOW.—JUNE 23RD.

FEW people, perhaps, looked for an extensive display at the opening show of the Rose season this year. The date is early, but the season is late, and these conditions will have their effect, despite the fact that the Exhibition was confined to Teas and Noisettes cut chiefly from under glass. The Show proved to be a small one, but the blooms were, generally speaking, good and the general display bright and interesting.

There were only two stands of twenty four single trusses, not less than twelve varieties, and that of A. H. Gray, Esq., Beaulieu, Newbridge Hill, Bath, well merited the first prize, which was adjudged for it. The varieties were as follows. Back row: Madame Cusin (two), Niphotos (two), very fine; Comtesse de Nadaillac (two), Maréchal Niel and Souvenir d'Elise Vardon. Middle row: Niphotos, Maréchal Niel (two), Catherine Mermet (two charming blooms), Souvenir d'Elise Vardon, Comtesse de Nadaillac, and The Bride. Front row: The Bride, Catherine Mermet, Alba Rosea (two), Reine du Portugal, Comtesse Pan'esse, Caroline Kuster, and Souvenir d'un Ami. T. B. Haywood, Esq., Woodhatch Lodge, Reigate, was second with much smaller, but fresh and well finished blooms. There were three stands of twelve, not less than six varieties, and here the Rev. A. Foster-Melliar, Sproughon Rectory, Ipswich, scored somewhat easily, the stands being moderate. The winning twelve were as follows:—Rubens (two), the first a beautiful bloom; Marie Van Houtte, Madame Bravy, Madame Hoste (two), charming blooms; Souvenir de S. A. Prince, Anna Ollivier (two), Marie Van Houtte, Hon. Edith Gifford, and Perle des Jardins. The Rev. J. H. Pemberton, Havering, Romford, was second, his best blooms being Souvenir d'un Ami and Rubens. R. L. Knight, Esq., Bobbing Place, Sittingbourne, was third.

T. W. Girdlestone, Esq., Sunningdale, Berks, won from four competitors with six blooms, having a magnificent Comtesse de Nadaillac, which was selected as the best bloom in the Show, and well deserved the honour; Climbing Devonensis, Maréchal Niel, Souvenir d'Elise Vardon, Catherine Mermet, and Caroline Kuster. The Rev. Alan Cheales, Brockham Vicarage, Surrey, was second with Cleopatra and Marie Van Houtte as his best flowers. E. Mawley, Esq., Roebank, Ferkhamsted, was placed third, and Dr. Ashurst, Farningham, fourth. Mr. Gray had the best six of any variety, winning with a moderately good lot of Maréchal Niel, Mr. Cheales and Mr. Girdlestone following with the same variety. Mr. Gray also won with six trebles, a very even and pleasing lot of flowers. The varieties were Catherine Mermet, Souvenir d'Elise Vardon, Comtesse de Nadaillac, Mdme. Cusin, Maréchal Niel, and Souvenir de Thérèse Levet.

The open class for twenty-four flowers brought out three very good stands, the well-known seedling Briar blooms of Mr. G. Prince, 14, Market Street, Oxford, securing the first prize. His varieties were:—Back row: Niphotos, Madame de Watteville, The Bride, Catherine Mermet, Souvenir de S. A. Prince, Souvenir d'un Ami, Souvenir d'Elise Vardon, and Comtesse de Nadaillac. Middle row: Amabilis, Anna Ollivier, La Boule d'Or, Hon. Edith Gifford, Maréchal Niel, Innocente Pirola, Princess of Wales, and C. Koch. Front row: Jean Ducher, Ernest Metz, Caroline Kuster, Princess Beatrice, Madame Cusin, Mdme. M. Arnaud, Devonensis, and Amazone. They were a very bright, fresh, and well-coloured lot of flowers. Mr. B. R. Cant, Colchester, was second with a collection of medium excellence, and Mr. G. Mount, Canterbury, was third. Mr. Prince won again with twelve trebles, and he had a capital stand, the varieties being Souvenir de S. A. Prince, Princess of Wales, Souvenir d'Elise Vardon, Catherine Mermet, The Bride, Jean Ducher, Souvenir d'un Ami, Anna Ollivier, Caroline Kuster, Hon. Edith Gifford, Comtesse de Nadaillac, and Innocente Pirola. Mr. B. R. Cant followed with an even collection, in which Souvenir d'Elise Vardon stood out as the best; and Mr. G. W. Piper, Uckfield, was third with small, but delightfully fresh and well-coloured blooms.

Mr. A. H. Gray followed up previous successes by a highly creditable victory with twelve Maréchal Niels, defeating Mr. Frank Cant, Braiswick, Colchester (second) and Mr. R. L. Knight (third) decisively. His blooms were of good size and perfectly fresh. He also won with twelve of any Tea or Noisette, having a superb stand of Souvenir d'Elise Vardon, so that he may be said to have been the hero of the day. Mr. Prince was second with a splendid box of his beautiful Tea Souvenir de S. A. Prince, Mr. B. R. Cant third with a good stand of Souvenir d'Elise Vardon, and Mr. Mount fourth with Anna Ollivier, small but fresh. The best basket was shown by Mr. G. Mount, a neat and attractive arrangement.

One of the most interesting features of the miscellaneous exhibits was a stand of seedling Sweet Briars, hybrids raised by the Right Hon. Lord Penzance. Some of these were remarkably pleasing. The Sweet Briar crossed with Alfred Colomb, H.P., yielded a charming rosy crimson single flower, but the spicy Briar fragrance was wanting in the foliage. In the case of Lady Penzance the perfume in the leaves was retained in conjunction with small single flowers of a rosy salmon hue, distinct in colour and most pleasing in character. Another good thing is the result of a cross between the Sweet Briar and Paul Ricaut, H.C., which has bright pink flowers. Lord Penzance also exhibited the fine old Rose Fortune's Yellow from a N.E. wall, and the old double yellow Rose, Rosa sulphurea. The trusses of the former were remarkably beautiful, and were greatly admired. The aspect is noteworthy, but it must be remembered that Godalming, where they were grown, is not a cold district. Messrs. G. Paul & Son, the Old Nurseries, Cheshunt, had a box of Rosa rugosa varieties, and such species as De Meaux,

Pomifera, Sweet Briar Janet's Pride, a charming variety, Rubifolia, Domeril, Boecard, White Burgundy, Copper Austrian, and several of the Scotch Roses.



EVENTS OF THE WEEK.—As will be seen by the list in our Rose column the Rose shows are now commencing, and though the early displays are likely to suffer, yet such rapid progress is being made that more blooms will probably be forthcoming than is generally expected. Besides the Shows at Ryde, Eltham, and Reigate, on Thursday and Saturday respectively, there are several next week, Winchester on Tuesday; and Wednesday, July 1st, will be a busy day, as exhibitions are announced for that day at Croydon, Lee and Blackheath, and Brighton. At these Roses usually constitute the chief features, but there are also many other attractions. For instance, at Brighton classes with good prizes are provided for stove and greenhouse plants, groups of Ferns, and other plants. On the following Saturday, July 4th, the National Rose Society's Exhibition will be held at the Crystal Palace. Messrs. Protheroe & Morris announce sales of Orchids for Friday, June 26th, and Tuesday, June 30th, at Cheapside. A new Houletia in flower, from Messrs. Charlesworth & Shuttleworth, will be offered on Friday.

— DEATH OF MR. HENRY POPE.—We regret to announce the death on the 16th inst. of this veteran horticulturist and florist after a short illness at his residence in the King's Norton Nurseries, Birmingham. About twenty years since Mr. Pope removed his business from the Handsworth district to King's Norton, and was most energetic and successful in business, and a few years ago he retired from the business, and his son Mr. John Pope has been the proprietor since. Up to within a fortnight of his death at eighty years of age, he took an active interest in the work of the nursery and in connection with his property; he was a guardian of the district, possessed a most retentive memory, and delighted in talking over horticultural doings of the last sixty years or more.

— THE members of the NOTTS HORTICULTURAL AND BOTANICAL SOCIETY recently paid a visit to Hardwick Hall, the residence of the Marquis of Hartington. About 150 members and friends were present, and the weather being fine, a most enjoyable day was spent in an inspection of the house and grounds.

— MESSRS. F. ROSHER & Co., Upper Ground Street, Blackfriars, E.C., and King's Road, Chelsea, send us an elaborate volume of coloured illustrations representing their specialities in GARDEN TILE AND STONE WORK TESSELATED PAVEMENTS AND STATUARY. Large numbers of most varied and artistic designs are depicted on twenty-five plates, each comprising from twelve to sixty figures admirably executed. The printing is excellent, and the volume is altogether quite unique.

— AT a recent meeting of the SHEFFIELD AND HALLAMSHIRE AND WEST RIDING CHRYSANTHEMUM SOCIETY, noted last week, the rules and catalogue of the Broomhead Library were distributed, a copy to each member. This most useful library, comprising more than 100 books on all subjects pertaining to horticulture, has been generously presented to the Society by Mr. H. Broomhead, its popular Hon. Treasurer, who has held the office from the formation of the Society, and during the whole time has continued to be its most generous and liberal supporter. The gift above mentioned was a perfectly spontaneous act on his part, and deserves high commendations as being the last, but not least, of a long series of valuable gifts he has made to the Society, and which owes much of its success to his generosity and labours on its behalf.

— LAXTON'S SCARLET QUEEN STRAWBERRY.—Mr. T. Laxton sends us fruits and foliage of this Strawberry, which he says was raised from Noble fertilised by King of the Earlies. They are medium sized, conical, much smaller than Noble, and larger than King of the Earlies, bright in colour and good in flavour, but they did not arrive in the best condition in consequence of an insufficiency of leaves in the box for keeping the fruits from moving. The foliage is robust. The fruits, it is stated, ripened outdoors on the 20th inst. in advance of Noble. We wonder why the raiser did not send some to be examined by the Fruit Committee of the R.H.S. on Tuesday last.

— GARDENERS' ROYAL BENEVOLENT INSTITUTION.—We are requested to remind our readers that the fifty-second Anniversary Festival Dinner of the Gardeners' Royal Benevolent Institution will take place at the Hôtel Métropole on July 8th, on which occasion the chair will be occupied by the Right Hon. Joseph Chamberlain, M.P. Those desirous of attending should make early application for tickets to the Secretary, Mr. George J. Ingram, 50, Parliament Street, S.W.

— RESPECTING LILIUM GIGANTEUM at Haddon Hill, mentioned in your last issue, page 496, surely your correspondent "S. B. J." is wrong in stating that "there were three bulbs in a 3-inch pot, with three spikes nearly 9 feet high, exclusive of the pot, and carrying twenty-seven blooms." My experience of *Lilium giganteum* is that "one" good flowering bulb would require a pot 9 or 10 inches in diameter. Many thanks for your courteous reply to my inquiry about "dwarf plants for border."—C. H.

— WASPS.—What is the winter economy of these? We are swarming with large ones, which I suppose must be queens, but how many queens are produced in a nest? When are they hatched, and how do they spend the winter?—D. [Though wasps have commenced making their nests, the "large ones" referred to are no doubt queens, and as far as possible every one should be destroyed. We will leave our naturalist friends to describe the method of hibernating and the number of queens produced, if they can oblige with the information.]

— THE SPURGE LAUREL (*DAPHNE LAUREOLA*) is a capital shrub to plant in the shade of overhanging trees, which it does not seem to mind, and as evergreens which will succeed in such a position are scarce it may be of service to some to know that this *Daphne* will thrive where there is an absence of sunlight. The yellowish green clusters of flower which hang from the under side of the branches profusely are not by any means objectionable in appearance, while the perfume from them is appreciated by most persons. In strong soil this plant grows freely, being thickly clothed with deep green leaves.—E.

— GARDENING APPOINTMENT.—Mr. John Lambert, for several years gardener at Onslow Hall, Shrewsbury, has been appointed head gardener to the Earl of Powis at Powis Castle, Welshpool, and enters on his duties on July 1st. Mr. Lambert is a well known successful exhibitor of vegetables and a good gardener, and it is not long since we published his excellent paper on vegetables, read at a winter meeting of the Birmingham Gardeners' Association. His former employer, the late Col. Wingfield, died recently, and Mr. Lambert's numerous friends will be glad to hear of his transfer to Powis Castle Gardens, where he will have plenty of scope for his abilities.

— EARLY PEAS.—Most gardeners and garden owners look forward with some interest to the time when the first Peas will be ready for the table. It seems like the commencement of summer vegetables, and early Peas are always appreciated. I am sending a few notes relating to time of sowing here, also the varieties, and when gathered, and I am under the impression that a few remarks from other readers of the Journal on early Peas would be of interest to all. I must say first of all our kitchen garden was a green field eight months ago, so that readers will observe we have not a good old garden ground to deal with, but it is splendidly situated, being well exposed to the sun, and the difference in the fall of the ground is 1 foot in 20. On February 4th we sowed Dickson's First and Best; also on the same day Day's Early Sunrise; on February 12th we sowed American Wonder on a south border close to the wall. Considering the long spell of bad weather I did not expect to gather quite so soon, but we had a large dish on June 20th of Dickson's First and Best, and a small dish of American Wonder on the same day, while Day's Early Sunrise will not be ready for nearly ten days. It therefore shows the importance of sowing varieties that will be ready in the shortest time.—A. J. LONG, *Compton Gardens, Stockbridge, Hants.*

— THE WAKEFIELD PAXTON SOCIETY.—The annual wild flower exhibition in connection with the above Society was held at their rooms at the Saw Hotel. Alderman Milnes presided, Mr. H. S. Goodyear filled the vice-chair, and there was a large attendance. Despite the backward state of the season and the scarcity of wild flowers there was a large and beautiful display. Many of the specimens had been gathered in the suburbs of the city, but a large portion of the flowers had been sent from various parts of the kingdom, including Cornwall, Wales, and Scotland. There were also a number of specimens from Holland, which had been specially obtained by Mr. Von Vane, a Dutch gentleman, who has recently settled in Wakefield. In accordance with the Society's

programme a lecture should have been delivered at their rooms on that evening by the Rev. F. D. Horner, Vicar of Kirkby Lonsdale, Westmoreland, late of Kirby Malzcard, near Ripon, but Mr. Horner's clerical duties would not allow him to visit Wakefield, and in order not to be deprived of the lecture it was decided to hold a special meeting on the following Thursday, when Alderman Milnes presided, and Mr. W. Pye, the Postmaster, occupied the vice-chair. In order to illustrate the lecture local Tulip growers exhibited a large number of florists' Tulips, and they made a grand show. Considering the very unfavourable weather and the great mischief done by the severe frost on the 17th of last month and the recent hailstorm, the blooms were fine, and they were greatly admired by professional and amateur gardeners from all parts of the city and its suburbs. The Chairman in commencing the proceedings, which occupied nearly three hours, apologised for the absence of Major Taylor, J.P., the President, and then introduced the lecturer. Mr. Horner had a flattering reception, and delivered a long and interesting lecture upon his favourite subject, and in his usual pleasing manner. It was followed by considerable discussion, and the proceedings closed with votes of thanks to the lecturer and exhibitors.

— THE BLACK CURRANT MITE.—At page 469 Mr. J. Hiam calls attention to my mistaking the caterpillar for a maggot, and mentions that the caterpillars were numerous but the maggots were scarce, and that they did not even care to notice the former. Why? My opinion is that a scarce maggot could be of little service in extirpating the mite pest. After I read Mr. Hiam's article about the scarcity of the maggots, I made an investigation of several buds. Wherever the silky appearance of the caterpillar was present there were no mites, and, singular to say, Nature was making an effort to start growth anew from the miteless swollen buds, but not with those where mites were present. I selected one of the latter, and placed a piece of one of the scales of the bud, about three-sixteenths square under a microscope. Upon this small piece of leaf there were upwards of 100 mites of various sizes, and like the spume hopper insect, of two colours, one less transparent than the other, probably male and female. Some of the mites raised themselves erect, using their two bristles to steady themselves by. There were numerous eggs of various sizes, some of them larger in diameter than any mite I saw. Some were scattered about, but there was one heap which the mites wrought with assiduity and care seemingly. At the side of this heap of eggs there were six cocoons a little longer than the mites, but of the same transparency, but motionless and legless. Then there was a brownish chrysalis which had a tubercle-like appendage. There might be one on both sides, but I did not see them; then at the other end, which was a little raised, there were two silken threads hanging out some distance. Along with these there would be at least 5000 mites in this one bud, and from their movements I was inclined to think they were at times hostile to one another, and to a maggot which was also present in this small place but vast multitude. The maggot was not unlike those that are found in the wild Rasp, and had a striking resemblance in its outward form to the larvæ of the ladybird, but no larger than any mite. I have penned the above facts so that they may stimulate others better qualified to make a proper research.—W. T.

— LEMOINE'S HARDY HYBRID GLADIOLI.—As one who has grown all the varieties of these most beautiful free-flowering and easily managed plants since they were first sent out by their raiser, I must enter a most emphatic protest against the inaccuracy of a statement appearing on page 491 of your last issue over the signature of your well known correspondent, "D., Deal," in which he ventures to assert that "in beauty these hybrids cannot touch the hybrids of the Gandavensis section." Now, I venture to assert that many of the newer varieties sent out by M. Lemoine in the autumn of 1889 (all of which bloomed most profusely in my garden during last summer and autumn) not only "touch," but fully equal in size of flower and delicacy and brilliancy of colour the best of the Gandavensis hybrids; and in proof of this statement I may mention amongst the Lemoinei section the beautiful light variety Venus de Milo and the splendid deep scarlet John Laing, which I have never seen surpassed and but seldom equalled by any Gandavensis hybrid. Amongst the Nanceianus section, also of Saundersi parentage, the fine President Carnot and the brilliant Comte Horace de Choiseul are as fine, if not finer, than any Gandavensis hybrid. I only now speak of those varieties that I have myself seen and successfully grown, but amongst the new varieties of this year, all of which I hope to bloom in the course of this season, I hope to find even finer varieties than any as yet known to me, especially the variety named Le Grande Carnot, which if it is accurately represented in its

portrait must be far in excess of anything we have yet seen both in size of flower and extreme brilliancy of colour. Your correspondent may not have seen these fine varieties, and if so he speaks from insufficient information, and such utterances are only calculated to mislead. M. Lemoine does not claim for his hybrids absolute hardiness, as your correspondent seems to imply, but merely that they are much hardier than any other hybrids, only requiring a slight protection of mats or litter in severe winters. I may add that even in 1879 and 1880 they have proved absolutely hardy here without any protection.—W. E. GUMBLETON, *Queenstown*.

— ROYAL METEOROLOGICAL SOCIETY.—The concluding meeting of this Society for the present session was held on Wednesday evening, the 17th inst., at the Institute of Civil Engineers, 25, Great George Street, Westminster; Mr. Baldwin Latham, M.Inst.C.E., President, in the chair. Mr. J. J. Colman, M.P., Mr. E. B. Duhoff-Gordon, B.A., Mr. G. E. Leon, Mr. T. de C. Meade, Assoc.M.Inst.C.E., and Mr. F. Russell, F.R.G.S., were elected Fellows of the Society. Mr. A. J. Hands, F.R.Met.Soc., gave an account of a curious case of damage by lightning to a church at Needwood, Staffordshire, on April 5th, 1891. The church was provided with a lightning conductor, but Mr. Hands thinks that when the lightning struck the conductor a spark passed from it to some metal which was close to it, and so caused damage to the building. Mr. W. Ellis, F.R.A.S., read a paper "On the Mean Temperature of the Air at the Royal Observatory, Greenwich, as Deduced from the Photographic Records for the Forty Years from 1849 to 1888," and also gave some account of the way in which, at different times, Greenwich mean temperatures have been formed. Mr. Ellis also read a paper "On the Comparison of Thermometrical Observations made in a Stevenson Screen with Corresponding Observations made on the Revolving Stand at the Royal Observatory, Greenwich." From this it appears that the maximum temperature in the Stevenson screen is lower than that of the revolving stand, especially in summer, and the minimum temperature higher; whilst the readings of the dry and wet bulb thermometers on both the screen and the stand, as taken at stated hours, agree very closely together. Mr. W. F. Stanley, F.R.Met.Soc., exhibited and described his "phonometer," which is really a new form of chronograph designed for the purpose of ascertaining the distance of a gun from observations of the flash and report of its discharge by the difference of time that light and sound take in reaching the observer. The instrument can also be used for measuring the distance of lightning by timing the interval between the flash and the report of the thunder. A paper was also read by Mr. A. B. MacDowall on "Some Suggestions Bearing on Weather Prediction."

ROYAL AQUARIUM SHOW.

JUNE 24TH AND 25TH.

THE Begonia and Rose Show, advertised to be held on June 24th and 25th at the Royal Aquarium, Westminster, was opened on Wednesday, and a good display of flowers was provided, though Roses were not sufficiently abundant to constitute a show of any pretensions.

The Tuberos Begonias were the great feature of the Exhibition, and Messrs. John Laing & Sons of Forest Hill had the satisfaction of winning premier honours with the most magnificent group ever entered in competition. It occupied a space of nearly 360 square feet, being 40 feet long and 9 feet wide, the plants being arranged upon the floor with Palms, Ferns, and Asparagus, an edging of *Isolepis* and *Panicum*, and a background of large Palms in front of a green baize screen. All the principal types were represented, doubles and singles of all the firm's best varieties being in good numbers; and there were also varieties adapted for baskets, together with novelties of exceptional merit. Some of the most notable were amongst singles—Duchess of Westminster, rosy crimson, white centre; Darkest Africa, rich maroon; Leah, fine yellow; Lady Pigott, large, of capital form, bright salmon; Juarez, crimson, very free and graceful. Of the doubles, the best were Duchess of Teck, clear yellow, very fine; Duke of Clarence, rosy salmon, distinct shade; Viscount Wolseley, orange scarlet, very free; Henshaw Russell, brilliant scarlet; Lady Kinnaird, very full soft cerise scarlet, crumpled edges; Stanstead Yellow, deep rich yellow; Mrs. Thrower, soft rich rose; Sir Trevor Lawrence, rich crimson; and Mrs. Jekyll, clear scarlet.

Mr. T. S. Ware, Tottenham, was placed second, his group being arranged upon a table with a margin of *Isolepis* and *Adiantums*. Many fine single and double novelties were included, the plants compact, the flowers large, and the colours varied.

A handsome non-competing group of Tuberos Begonias was exhibited by Messrs. H. Cannell & Sons, Swanley, and occupied a space on a long table similar to the group from Tottenham. The plants and varieties were good, the arrangement tasteful, and the effect very satisfactory. *Adiantums* and *Panicums* were employed as a margin.

Hardy flowers were well represented, and in the class for a collection the first prize was awarded to Mr. T. S. Ware, Tottenham, who had a charming group most effectively arranged, and showing the decorative value of these plants to perfection. Messrs. Barr & Son, Covent Garden,

were second with a smaller group; and Messrs. Laing & Sons third. Pyrethrums were shown by Messrs. Collins Bros. & Gabriel, Waterloo Road, and Messrs. Paul & Son, Cheshunt, who were first and second respectively. With a collection of Irises Messrs. Barr & Son, Covent Garden, were first. Mr. Ware took first honours for a grand collection of Paeonies, admirably arranged; and Messrs. Barr & Son were second. Messrs. Kelway & Son, Langport, had a similar collection of flowers to that at the Drill Hall on the previous day, and were awarded a silver medal.

In the Rose classes Messrs. Burrell & Co. Cambridge were first for thirty-six single trusses. Mr. G. Prince, Oxford, was second, chiefly with Tea Roses, and Mr. B. R. Cant, Colchester, third. Mr. Prince was first with eighteen Teas, and second with twelve blooms of Rose Maréchal Niel. Mr. A. H. Gray, Beaulieu, Bath, was very successful in several classes, carrying off premier honours with fresh bright blooms. Mr. Knight of Sittingbourne, and Dr. Budd of Bath also exhibited well.

Mr. S. Mortimer, Farnham, had a group of Coleuses in many fine varieties, and a certificate was granted for Cucumber Matchless from Express crossed with Lockie's Perfection.

Messrs. Sutton & Sons' prizes for their Prizewinner Cucumbers were adjudged to Mr. S. Cook, gardener to J. B. Yule, Esq., Holmewood, Hendon; Mr. Lockie, Oakley Court Gardens, Windsor; and Mr. G. Collins, gardener to Mrs. Anderson Rose, Wandsworth Common, in the order named.

THE BRIGHTON AND SUSSEX NEW HORTICULTURAL AND GARDENERS' IMPROVEMENT SOCIETY.

AT the meeting of this new Society previously referred to there was a good attendance. Mr. W. Balehin occupied the chair, and was supported by Mr. Joseph Cheal and Mr. Miller. Mr. J. Wright's lecture on "The Objects and Usefulness of Gardeners' Improvement Societies," was attentively listened to, and at its close several gardeners were added to the roll of membership. A strong desire was expressed for the publication of the lecture, but only a very brief digest can be given here.

After a few preliminary remarks, Mr. Wright said horticultural societies had long been existent, but until recent years their chief object appeared to have been the providing of exhibitions at which gardeners could win prizes and grumble at judges. As a judge at many shows he had not the slightest objection to being grumbled at, because he knew that grumblers always learned something, and all shows should be educational. Competitive displays of plants, flowers, and garden produce had done great good, both in stimulating to higher culture and creating a wider interest in gardening in various parts of the kingdom, but they had not proved altogether satisfying in all districts, and out of them had sprung a desire for more knowledge on the part of both gardeners and amateurs, hence the establishment of mutual improvement societies, or the holding of periodical meetings for purposes of instruction in the art of gardening.

He was glad to believe that the new Society would embrace all sections and classes of gardeners—amateurs, professionals, and probationers. The combination was most desirable, and the more representative the Society the stronger it would become, and the more useful. He thought there was nothing more gladdening than to see the frank and friendly association of all who love gardening. No matter whether they were rich or poor, old or young, skilled or unskilled, they should be encouraged to join together for a common object, and this object worthy of the combined efforts of all—beautifying the earth and developing its resources.

He was aware that difficulties had been experienced in defining the relative positions of gardeners and amateurs, but after all the question was a very simple one. Any person who engaged in gardening for love and not for gain was an amateur, but those who engaged in the pursuit as a means of livelihood, or with the object of material gain, were professionals; no matter whether skilled or not, if their object was gain they were professional gardeners, and not amateurs. No doubt there were some persons, perhaps several, who would like to combine the two attractions—love and gain. Both were tempting. It was certain there were many gardeners whose love for the pursuit was much greater than the gain they derived from it, and there were amateurs who did not love gardening the less because they made a little out of it, but possibly loved it more. The lecturer thought it was not wise for gardeners to be too sentimental over the amateur question. "Ought not we," he said, "who are gardeners be pleased to see others who are not, take interest in their gardens, and make a little out of them if they like and can? If the great body of toilers and moilers could do that would it not be better for themselves, their families, and the country? It must be so, and when it comes to exhibiting surely terms can be provided that shall be fair to all. I should like for all gardeners' mutual improvement societies open their doors to all members of the garden-loving community."

Allusion was made to the different classes of amateurs—the expert specialists who made the world richer by the distribution of their knowledge at meetings and through the press; the affluent who were the best supporters of gardening and gardeners; and the inexperienced, who were thirsting for information such as professionals could supply, and ought to feel it a privilege to do so. The object of mutual improvement societies was to gain knowledge and distribute it. It was feared there were many gardeners who could impart information that would be of great service to others, but hesitated to do so either because it was neither new nor novel, or could not be presented in the most

attractive literary guise. That was a mistake. Plain facts stated in plain words were what was needed, avoiding slangy terms on the one hand, and inflated language on the other, as both weakened a good case. Also it was certain that not a few persons hesitated to ask for information which they urgently required through either the morbid fear of betraying their own ignorance, or being laughed at by some self-superior person, of which there is a remnant in the gardening world. That also was a great mistake. The men who have acquired the most knowledge have never been afraid to ask questions, and they do not hesitate to seek information from the humblest of toilers if he can impart what they need; and if a gardener boasts of his knowledge, and is at the same time fearful that a little should escape him, it may be taken for granted that he has really little or none to spare. The really competent gardeners are not only willing, but anxious to help the young and inexperienced, and many of those gardeners are justly proud of the positions their pupils have attained in the craft they adorn.

Mr. Wright went on to describe the methods by which mutual improvement societies are made useful—namely, the bringing of plants with which difficulties are experienced, or examples of whatever kind on which information is needed, to the meetings; also by exhibiting superior examples of culture on an equitable basis, for which marks of merit may be recorded, and at the end of the term grants of standard books, awarded in accordance with results as at Ealing, or of medals of the Royal Horticultural Society as at East Grinstead, these being supplied by the "Royal" at a cheap rate to societies in alliance with it. The reading of short essays at the meetings, and inciting discussion thereon, was described as distinctly educational, and to none more than those who prepared them. The offering of prizes for such essays, as at Chiswick through the generosity of a kind lady (Mrs. Lee), was said to have been productive of excellent results in stimulating men to worthy endeavour. In commenting on this practice the lecturer expressed the opinion that really good essays were at least as well worthy of prizes as a few dishes of vegetables and fruit were, or plants either, for somebody else usually provided the means for growing these, but the writers of good essays had to find their own means in their own brains.

Instances were given for the encouragement of gardeners who were perhaps working hard for a little money, of men who were once similarly circumstanced attaining positions of trust and independence by their diligence and perseverance, making the best of the limited means at their disposal instead of refraining from exertion on the plea that "the place was not good enough." Some persons were hard to serve, but even then it was a duty to give the best possible service, and if it failed to satisfy retire. An example was cited of a gentleman having had many gardeners, and therefore gained a "bad name;" at last finding one who had either more ability, tact, or perseverance than the rest, making his master one of the best in the kingdom, and this gardener, though still in his prime, being amply provided for to the end of his days; also of another striking case where long and laborious service was crowned with a rich reward. Those men, and there were many others like them, read attentively, studied closely, and worked diligently—men of knowledge, of prudence, and sustained effort, who did their best in everything they undertook, surmounting early difficulties, and had patience to wait for the results.

The object of gardeners' improvement societies, the lecturer went on to say, was "to provide means of instruction for members by scattering seeds of knowledge in the hope that they will fall on good ground—receptive minds; and just as they do so, and are nurtured by prudence, they will grow and bear fruit, thus demonstrating the usefulness of such societies in due time. No intelligent, industrious, prudent, and competent gardener, with years of work before him, and who enjoys the blessing of health, need fear for the future. He may not gain wealth—that is scarcely to be expected—but if he love his work and let sound judgment govern his actions, he will, sooner or later, gain a position of trust, his labours will be appreciated and himself respected by the best of the community in which he dwells."

UPPER HOLLOWAY.

UPPER HOLLOWAY, as understood in the world of gardening, naturally means the world-famed nurseries of Messrs. B. S. Williams & Son. There is nothing else to many of the readers of these lines to which the term can apply, and they are interested in little else except the way to get there. They may be informed, at least those of them who do not know, that just opposite the entrance appears to be the tram and 'bus terminus from—well, from every where, as there is certainly no part of the United Kingdom that is not connected with those services, for the simple reason that the vehicles run from every chief railway station in London, with or without a change on the way. If there should happen to be a slight obstacle to reaching Holloway by road, such as when 'bus drivers refuse to drive, and conductors have nothing to conduct, as has lately happened, or whether there is or not, the nurseries can be quickly reached from the King's Cross Underground station of the Metropolitan Railway. On turning to the left from Upper Holloway station there is soon seen a Lombardy Poplar in the distance. That is the nursery signal, the point to aim for, and the place to stop at, reached after a few minutes of gentle up-hill walk.

The district has changed somewhat since the late respected and much-lamented Mr. B. S. Williams pitched his tent there nearly thirty years ago. At that time the land was bought for about £1000 an acre, but now property in the neighbourhood is readily sold for £4000 an acre; so that if land has gone "down" in many, if not most parts of

the country, distant from towns, it has gone "up" in London and its suburbs. Lucky then are the owners of London land.

Mr. H. Williams, the head of the firm, is a fine specimen of a British nurseryman, and than this race, British gardeners are vain enough to believe there is no finer in the world. Clear headed, good hearted, straightforward, fair dealing business men is a fair representative description of our leading nurserymen and seedsmen, and their establishments admirably portray the industrial enterprise and the great magnitude of gardening operations in the kingdom.

Moving about from place to place, and making a call here and there, the time came round for a call at Holloway, after an absence of about seven years—too long, no doubt; but all the reproach met with, really no reproach, but a pleasant greeting, was, "Come in, we thought you had forgotten us. We are always glad to see you, you know," reminding of the once familiar tones of the voice that is gone.

And what was there to see on the drizzling day a short while ago?

In passing round the establishment the Palm house was first traversed, a lofty span-roofed structure 100 feet long by 22 wide, stocked with plants of all the best kinds and in almost all sizes, from hardy decorative examples "in 48's" to stately specimens of exhibition quality, and all, large and small, noteworthy by the dark hue of their glossy leaves. The house was brightened with Anthuriums, which are grown in great numbers and variety. A grand effect has often been produced by arranging Orchids in it, but these are now kept in houses better adapted to them, and are a show in themselves, without the Palmy auxiliaries. Passing the large Palms in familiar varieties, one or two were noticed as distinct and particularly attractive in a small state—namely, *Calamus ciliaris* and *Rhapis humilis*. The latter it appears has to be increased by offsets, which is not common with Palms. It is, therefore, naturally limited in numbers, and is both graceful and distinct. These with other small Palms are grown in smaller houses, one containing 3000 *Kentias*, *Geonomas*, *Cocoses*, and the elegant *Phoenix*

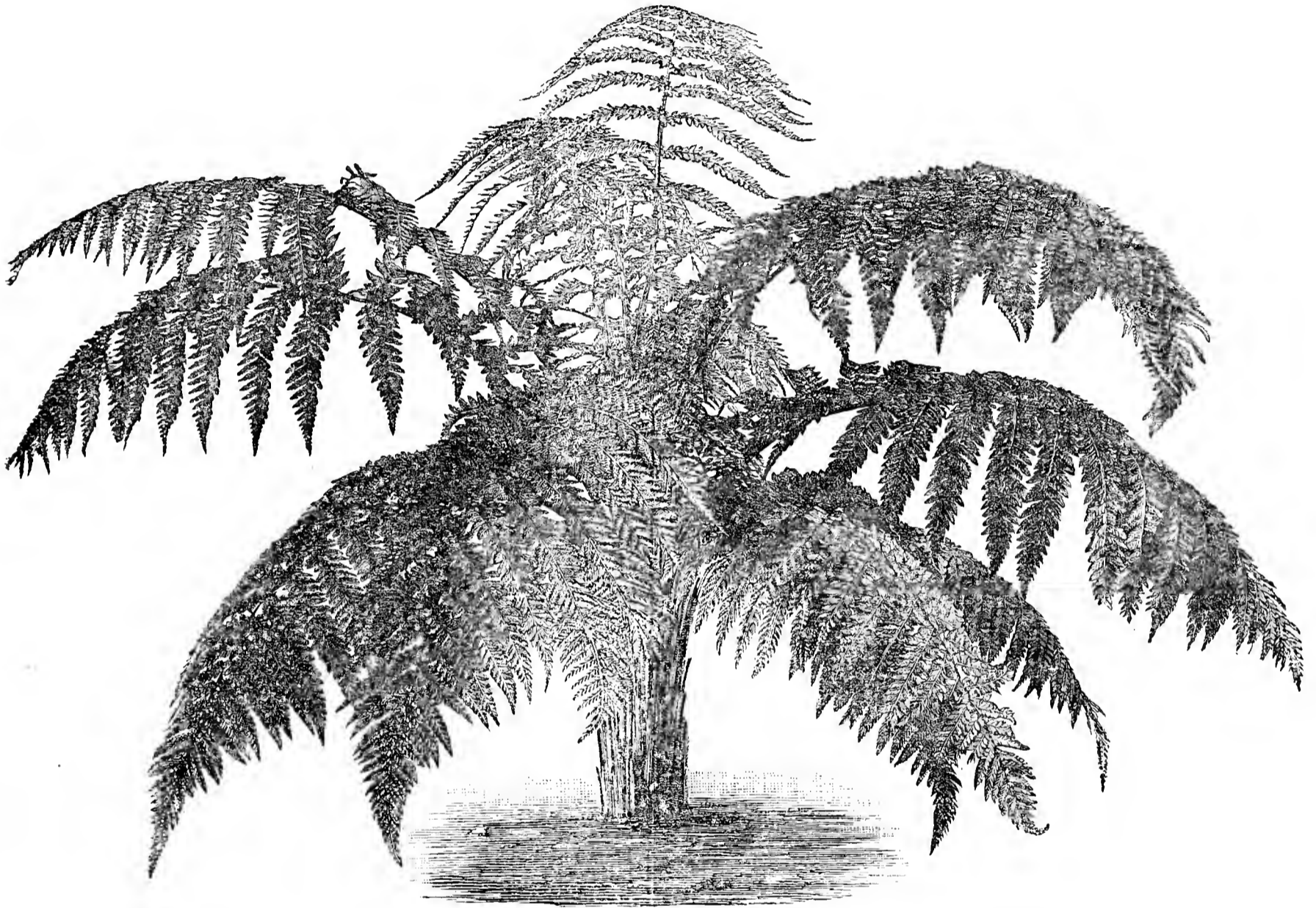

FIG. 96.—DICKSONIA LATHAMI.

A great deal, a very great deal, more than can be told here. Fancy thirty-six houses full of plants of all the chief kinds, grown in stoves and greenhouses in this country, and not a few that are rare, sufficient altogether to fill a catalogue of a hundred pages, and it then becomes apparent how impossible it is to particularise to any material extent in dealing with such a great and diversified collection. The contents of the nursery can only be referred to in the lump, so to say. A celebrated poet writing in a satirical vein once said, or made one of his purse-proud bucolic characters say, "The poor in the loomp is bad." The Holloway collection represents the exact antithesis to that curious doctrine, for there seems to be no poor there, all the plants, as well as their master and attendants, looking thrifty and well. In passing through house after house, the health, cleanliness, and orderly arrangement of the occupants could not be overlooked. In all departments, Orchids, Ferns, ornamental foliaged and flowering plants, as well as in the hardwooded sections, Azaleas, Camellias, Rhododendrons, &c., it was the same, and a glance, more or less penetrating, sufficed to show that the cultural needs of all were provided by able men taking pride in their work. Whether there is a plant hospital in connection with Holloway or not to which weaklings are relegated, or whether it is the rule to summarily depose plants that become afflicted with ailments to which they are liable is not known, and it can only be said there was a remarkable absence of all that could offend or incite a feeling of pity, uniform excellence prevailing all round.

rupicola being represented in proportionately large numbers. Ferns, charming in their fresh spring growth, were next under review. The collection is extensive, filling two large houses. *Adiantum Williamsi* is distinct from all others of the family in the uncoiling fronds being covered with a golden farina-like substance, similar to some of the *Gymnogrammas*; *A. versaillese*, a crested and divided form of *A. cuneatum*, has many admirers, and has had the honour of a first-class certificate. The crisped and crested forms of *Pteris tremula crispa* and *Smithiana*, also *P. serrulata semi-fastigiata* are expected to become general favourites, as their characters are very marked and growth free. *Onychium auratum* is a Fern of great elegance and medium growth; and so we might go on, but stop at a more stately kind, *Dicksonia Lathamii*. It is supposed to be the result of a cross between *D. antarctica* and *D. arborescens*, and certainly bears a resemblance to both. This Fern was raised by Mr. W. B. Latham, the skilled Curator of the Birmingham Botanic Gardens, and was awarded a certificate of merit at the Fern Conference of the Royal Horticultural Society. It is quite as sturdy and massive, as represented in the illustration (fig. 96), and very dark green in colour, but the artist has omitted to show the swollen base, which is a prominent feature of the variety, the broad spreading fronds apparently having absorbed the whole of his attention. It is a very fine Fern, and no doubt will be seen at exhibitions in due time.

Now comes a change—from greenery to floral beauty—the Orchids

Two large structures and several smaller are occupied with them, for the collection is large, and the several plants in as good health and condition as anyone could wish to see. Prominent among those in beauty was a fine plant of *Cymbidium Lowianum* with seven spikes and 180 flowers, *Cattleyas* and *Laelias*, upwards of a dozen species and varieties of the former, including *Acklandiae* and *Warneri*, with *Mendelli* and *Mossiae* in several fine forms contributed effectively to the display, while among the latter *L. purpurata* was bearing seven flowers on a spike, with several varieties, such as *alba*, *Brysiانا*, *Russelliana*, *Williamsi*, and *Yate's* variety to bear it company. *Cypripediums* were in great force, and too many of them flowering even to be enumerated, probably about thirty, and amongst them some of the finest in cultivation. Similar remarks apply to *Odontoglossums*, one or two of the *vexillariums* being unusually rich in colour, and many of the plants bearing from four to six spikes each. *Oncidium*s were also numerous, and *Dendrobium*s and *Vandas*, a very fine lot, well represented. Besides them were *Aerides* and *Anguloas*, *Epidendrum*s and *Cœlogyn*e, *Masdevallias*, *Tricopili*as, *Uropedium*s, *Scuticari*as, and *Zygopetalum*s, with others that cannot be remembered, the whole making a floral feast worthy of the establishment. The *Orchids* must be left, however, or there will be no space for an allusion to anything else in other departments.

Of stove plants, old and new, there is apparently a complete assortment, and the demand for them is increasing. One long house appeared to be almost filled with climbers of various kinds, and the number of *Dipladenias* was astonishing. Greenhouse plants are also grown in great variety and propagated in large numbers. In this department is a fine collection of *Rhododendron*s, the plants as compact as *Azaleas*, the result of free pruning and systematic pinching. Then we came to *Azaleas* and *Camellias*, large and small, among the latter being a number of Japanese introductions.

From these we pass into stoves again—housefuls of *Croton*s, *Dracenas*, *Ixoras*, *Caladium*s, &c.—and find ourselves under a canopy of *Nepenthes*, and beneath them *Marantas* growing as freely as *Cabbages*, with *Aroids* of various kinds, and several more plants that cannot be particularised, remarkable for the beauty of their foliage or flowers. We were glad to get out of the tropics and rest a few moments under the tall *Tree Ferns* and *Palms* in the conservatory which visitors to *Holloway* know so well. The "look round" was a pleasant one, and Mr. *Williams* most courteous and kind. He evidently intends upholding the reputation of the nurseries, and if possible adding lustre to the name he bears; at least, that was the impression of—A BRITISH GARDENER.

CROYDON GARDENERS' AND AMATEURS' MUTUAL IMPROVEMENT SOCIETY.

THERE was a large gathering of the members of the *Croydon Gardeners' and Amateurs' Mutual Improvement Society* at the *County Hotel*, *West Croydon*, on *June 16th*, to hear a lecture by the *Rev. W. Wilks of Shirley*, whose interest in horticultural matters is so well and widely known, upon "Hardy Herbaceous Borders." Mr. *Jones*, who warmly supports the Society, was voted to the chair, and Mr. *Stanley B. Baxter*, the *Hon. Sec.*, had the business of the meeting well in hand, the proceedings affording a pleasing instance as to the method in which mutual improvement is sought to be brought about, and the encouragement, by way of exhibits and honours, originated to obtain that end. The rule is that exhibits are judged, not one against the other, but according to their individual merits, a maximum of points being agreed upon, consequently the first duty was to appoint *Judges*, and Mr. *Box*, Mr. *Carr*, and Mr. *Bishop* were elected to perform the duty. The exhibits were not numerous, but they were supplemented by others, notably a fine specimen of the *Orchid Cattleya gigas Sanderiana* with two spikes, with seven and five gigantic blooms respectively of this grand variety, shown by Mr. *Carr* (from Mrs. *Stephenson-Clarke's* collection at *Croydon Lodge*). Then there was a remarkably well-flowered *Gloxinia* shown by Mr. *Ritchings*; some fine *Cucumbers* by Mr. *Roffey*; bouquet of hardy flowers, *Dracena gracilis*, &c., making altogether a striking little collection. This interesting part of the business being over,

The *Chairman* remarked that it was utterly unnecessary to introduce Mr. *Wilks* to anybody who knew anything about gardening at all, for he was known all over the world, and he thought therefore he could not do better than, without further preface, ask him kindly to give them the lecture he had been good enough to attend to deliver.

The *Rev. W. Wilks* then proceeded to give in a chatty way what proved to be a most interesting and valuable lecture in respect of information accorded. He remarked that there was nothing more disappointing than to have formed great expectations and to have them dashed to the ground. He was told that many people were disappointed on a first visit to *Rome*. They had heard so much, and had formed such expectations of the sights they were to see, that they anticipated more than they found. He knew not a few were disappointed on a first visit to *Switzerland* and seeing the mountains. They expected to see every mountain run up to a peak and covered with snow. He was afraid that would be his position to-night, for Mr. *Baxter* had sent round such a puff that much might be expected, with the result of disappointment. But he would not attempt to give them a lecture, simply have a little chat with them on a most interesting subject to him; and he had not chosen the subject of hardy flowers simply because it was one of his hobbies, nor simply because it was a subject upon which he had particular claim to be heard; but he had

done so for two reasons. First, being somewhat behind the scenes, he could tell more than some of them which way the wind of gardening blew; and he was confident of this, that gardeners were in for a gale of hardy borders. It was coming in the very near future. People had become tired of carpet bedding and endless arrays of *Pelargoniums* and *Calceolarias*. That was his first reason—that it was coming into favour with owners of gardens, and very soon he was sure it would be the fashion. His second reason was that he thought he discerned a disinclination amongst some gardeners to fall in with, or to prepare themselves for, the coming fashion. They were too much wedded to glass houses and all that they meant; they doted on carpet bedding and geometrical borders, and straight lines, and even heads; and they said that anyone could grow hardy things, and that they were rubbish. In one sense they were right. There was rubbish that was fit only for the wild garden; but there they were in their place, and the day would come when gardeners would have to think about that. There was a lot of hardy plants that were rubbish, but was not that a reason why gardeners should begin to study hardy things, so that when the day came when the employer said he was tired of everlasting *Geraniums* and *Calceolarias*, and he would like to have a garden like—Mr. *Wilks's*, at *Shirley*, for instance—(applause and laughter)—they might be prepared for it? Was it not well to study this, and not have to reply that they did not know anything about hardy flowers, with the inevitable result that my lady, having read in the paper that *Messrs. Wheedle & D'em*—(laughter)—would supply 100 hardy plants for 10s. 6d., they then got some hardy rubbish? and no one would be more to blame than themselves in not looking into the subject, and being able to make their own selection.

These were the reasons that he took the subject of hardy borders, or mixed borders, as he preferred to call them, because he did not wish to go to extremes. He wanted to see some hardy, some tender, some, in fact, of all sorts and shapes and sizes and colours; for from such combinations and unity alone could true beauty be obtained in their gardens. This was what he aimed at in his own garden, and any of them could come and look at it whenever they liked, and the oftener they came the more the owner would be pleased. (Applause). There was only this about it—they could not expect to find the borders so brilliant in *July* and *August* as with the usual bedding plants, but still the hardy plants were bright and cheerful from the appearance of the *Snowdrop* till frost set in. He suggested the use of two-thirds of hardy stuff and one-third of tender plants, and the latter could include plenty of all kinds. These should not be planted in formal set lines, patterns, or order, but mixed up together, apparently higgledy-piggledy, aiming at art which consisted in concealing art. He then proceeded to give suggestions as to the mixed border, and first, with regard to the soil, he said he was sure of this, that no soil existed that might not be made to suit, with a little trouble and patience, a mixed border; but every soil had its own particular plants which grew better in it than anything else, and it was the gardener's business to study plants from that point of view and find out such as suited his own particular soil; while some plants might be induced by a little coaxing and attention to grow in any soil. They must not think that all a gardener had to do was to stick things in and dig things out; the man who loved his work would find out the why and the wherefore—why one thing flourished and another thing failed—and by constantly keeping his eyes open and recording he would become a master of his profession. There were only two rules that he knew of—one was if the soil was wet it was necessary to have it drained, and the other rule applied to the opposite state of things—if the soil was dry they must manure it at least once a year. There were some people who expected hardy plants to grow in any soil for any length of time, for ever and for aye, but they would not. No doubt in a rich soil they would do so for a long time, but in a poor soil they would not. But whatever the method of the manuring might be they must bear well in mind that one of the fundamental rules of a hardy border was that it never must be dug over. But as the rains washed the goodness out of such light soils as his own, and as *April* would be the time to manure it, when they would not like to see farmyard manure lying about, this pointed to the use of artificial manure, which they scattered about and then just forked it in. Then they changed the manure, one year using *Clay's*, then *Beecon's*, and another year a *Norwegian fish manure*. But every year they used bone dust with any manure, and every alternate year they gave a dressing of quarter-inch bones.

Some authorities said that the hardy border ought to be dug every five years, but he did not agree with that. His own borders had not been dug for more than eleven years. No doubt some plants would at length wear themselves out, but his plan was this—when he saw that he dug that particular stock up in the autumn or spring, and had the patch of ground in which it stood thoroughly well dug and manured with cow dung, and then he replanted there a little bit of the failing stock, or a cutting of the previous spring, or a seedling. Thus his borders never need to be dug over, but bits of them somewhere were always being treated. He thus avoided that bare appearance which they must have if treated otherwise. The watering and time for planting was then treated upon, and then the method of planting.

He advised them not to plant by rule—not to get a yard measure and stick everything in exactly the same distance apart, but exercise some discretion, and consider the habit of each plant. *Delphiniums*, for instance, would take up a lot of room, while *Lilies* would shoot up straight and take up little space. The propagation of plants from seed, from cuttings, and divisions of the roots was next dealt with, and he

then spoke of tidyness, by which he did not mean primness or formality. Tidyness in his garden was a necessity, and formality an abhorrence. In enlarging upon this point, he said he called it untidy when a gardener took a lot of sticks of the same height and a ball of string and proceeded to tie the plants up to look what they were, a row of martyrs condemned for the zeal of their growth. (Laughter.) Tied too tight they were strangled, and tied too loose they chafed themselves to death. But they must teach the employer, and, better still, the "Missus" and the young ladies, to recognise the fact that a hardy border cannot be spic and span tidy. They must teach them that it was a sin to cut off leaves before they were thoroughly ripe, because upon the thoroughly ripening up of the leaves depended the flowers of next year. It was not untidyness to leave them alone, and they must be content with it. Then they must never let the plant bear seed unless they wanted it to raise next year's plants. Pull off every seed head or pod as fast as it is formed: every one carelessly neglected made a dozen heads of bloom less in the following year. What he was striving for in this paper was to try to get back variety into our English gardens—variety of form and foliage, of colour and stature. Their forefathers had it 150 years ago, and yet now they were so much richer than they were in plants, they were subjected to Geraniums and Calceolarias. But they should not think so much as to how many kinds they could grow, as about growing nothing that is not ornamental in itself.

The Chairman said he was sure they were very grateful to Mr. Wilks for his paper. (Applause). It was their rule to get up a little discussion, and Mr. Wilks would be pleased to answer any questions that might be put to him. They had got him there, and they might as well pump him. They could not pump him dry—(laughter)—only get a little more out of him. If they would only go at him he would be only too pleased to impart as much as he could.

Mr. Carr started the discussion, Mr. Box, Mr. Roffey, Mr. Ritehings, and others taking part therein; and several questions were put to Mr. Wilks, and answered by him in a genial way.

Mr. Carr proposed a vote of thanks to Mr. Wilks for his able lecture, which was seconded by Mr. Roffey, supported by Mr. Bowman, and carried with acclamation.

A vote of thanks was also accorded to the Chairman, and to those who had brought exhibits; and a resolution having been arrived at that the Society should be represented at the forthcoming floral Fête at the Crystal Palace, in aid of the Gardeners' Widow and Orphan Fund, the proceedings terminated.—(*Croydon Chronicle*.)

ROYAL HORTICULTURAL SOCIETY.

JUNE 23RD.

EXCEEDINGLY interesting was the meeting of this Society on Tuesday last, for besides the numerous floral exhibits of a special character, the Orchids and the fruit, the National Rose Society's prizes for Tea Roses brought together far more of these beautiful flowers than the season had given occasion to expect. Four tables extending the entire length of the Hall were filled, and even then some contributions of an important character were crowded into corners or placed upon the floor. At a meeting combining so many attractions as this the capacity of the Drill Hall is indeed severely tested, and the difficulty of displaying the exhibits to the best advantage, or even in their fair characters, causes much dissatisfaction alike to the officials and the exhibitors.

FRUIT COMMITTEE.—Present: P. Crowley, Esq., in the chair; and Dr. Hogg, with Messrs. R. D. Blackmore, G. Reynolds, J. H. Veitch, J. Cheal, J. T. Saltmarsh, A. Dean, G. Wythes, J. Hudson, G. T. Miles, H. Balderson, J. Smith, C. Penny, F. Q. Lane, G. Bunyard, and J. Wright.

Mr. S. Mortimer Rowledge, Farnham, sent beautiful fruits of a new Cucumber named Matchless, a seedling between Express and Lockie's Perfection. An award of merit was proposed and lost by one vote, several members not considering it sufficiently distinct from and superior to existing varieties. Mr. Leech, gardener to the Duke of Northumberland, Albury Park, sent a fine dish of Duke of Albany Peas with very large pods, and a cultural certificate was unanimously awarded.

Mr. J. Collis, market gardener, Acton, sent fruits of Collis's Seedling Strawberry, an early variety but rather small, and the Committee desired to see it again. Messrs. J. Cheal & Sons exhibited splendid fruits of Noble Strawberry grown on heavy land—firm, and of really good quality; by far the best early Strawberry grown at Crawley, and the best flavoured Noble yet submitted. A cultural commendation was promptly recorded.

Mr. Barron placed trusses of Crescent Seedling Strawberry on the table, the fruits still green, though others of Noble grown by the side of them were quite ripe. During the past two seasons Crescent Seedling has been the first Strawberry to ripen at Chiswick, and its lateness this season is remarkable. It is less robust in foliage than most others, and its growth was presumably checked in the early stages by the cold weather, while the more robust varieties kept steadily moving on. It is of American origin, and if its earliness is not maintained will scarcely be worth growing.

Mr. John Watkins, Pomona Farm, Hereford, sent a dish of Duke of Devonshire Apple, fruits of medium size and excellent in quality; also splendid fruits of Striped Beefing, firm and beautifully coloured. A vote of thanks was unanimously awarded.

Mr. G. F. Pontin, Stanley Vineries, Wolkingham, sent a large oval-shaped Melon, not sufficiently good in quality to merit any award. Mr. J. Hudson, gardener to the Messrs. de Rothschild, Gunnersbury, sent a

beautifully netted Melon, not quite ripe, but of such promise that the Committee desired to see it again. Mr. Bishop, gardener to R. Burrell, Esq., Westley Hall, Bury St. Edmunds, sent two new Melons. No. 1, White flesh, large, closely netted, but overripe. The Committee thought it good, and desired to see it again. No. 2, Searlet, oval, not quite ripe nor so good as the other, and passed. Mr. T. H. Crasp, gardener to Lord Wimborne, Canford Manor, sent excellent A Bee Peaches and Stanwick Elruge Nectarines, and a cultural commendation was unanimously awarded.

Cecil H. Hooper, Esq., exhibited a collection of instruments used in fruit tree cultivation in France, some useful, some novel, and a vote of thanks was awarded.

The Chairman announced that arrangement has been made for a series of experiments in drying fruit at Chiswick during the season, and requested the members of the Committee to appoint a few from their body to co-operate with the Chiswick Board in conducting those experiments, whereupon Messrs. J. Wright, J. Cheal, J. Hudson, A. Dean, and J. H. Veitch were nominated for that purpose.

FLORAL COMMITTEE.—Present: W. Marshall, Esq., in the chair, and Messrs. H. B. May, H. Cannell, H. Turner, R. Dean, C. T. Druery, B. Wynne, W. C. Leach, G. Phippen, H. Herbst, J. T. Bennett Poë, G. Paul, J. Fraser, W. Watson, F. Ross, C. Jeffries, and G. Gordon.

From the Royal Gardens, Kew, came a small collection of choice plants, which attracted much attention. Conspicuous amongst them was *Primula imperialis* from the mountains of Java, one of the *P. japonica* type, with long strong broad leaves, and flower stems 2 feet to 2½ feet high, bearing the deep orange coloured flowers in dense whorls, separated by rather long internodes. This plant is especially interesting, owing to the fact that many efforts have been made to import the seeds and raise plants, but the latter has invariably failed until at Kew the experiment was tried of first soaking the seeds in hot water for a time, which resulted in the production of the plants now referred to. It is possible that if a cross could be obtained with *P. japonica* a new race of hybrids would be obtained, and the habit of *P. imperialis* might also be improved at the same time, as at present it appears rather too tall to be of much service from a horticultural point of view. With it was shown *P. Poissoni* from Northern China much in the style of *P. japonica* in form and colour. The deep blue *Exacum macranthum* was greatly admired, also *Disa tripetaloides*, with numerous white and pink dotted flowers in racemes; *D. racemosa* flowering very freely; the handsome *Dendrobium MacCarthiae* from Ceylon; the peculiar diminutive *Masdevallia muscosa*, *Crinum purpurascens*, with long narrow white petals tinted purple on the lower surface, and the strange dwarf *Protea nana*, with drooping bell-like flowers. A vote of thanks was accorded for the group.

The collection of Tulips from S. Barlow, Esq., Stakehill House, Manchester, was a centre of attraction, for it was designed apparently on an educational method to illustrate to the ordinary public some of the distinctions between the various sections which are puzzling to beginners. Thus the flowers were arranged in little groups of feathered and flamed bizarres, then came similar divisions of bybloemens, and following these the "breeders." Considering the distance they had travelled the flowers were fresh and beautiful, and the award of a bronze Banksian medal was amply justified.

Carnations were grandly represented in a group of Souvenir de la Malmaison from Mr. T. H. Crasp, gardener to Lord Wimborne, Canford Manor, Wimborne, and although fine examples have been shown before on several occasions better plants could not be desired. They were in perfect health, vigorous without being gross, the foliage of a beautiful metallic hue, the flowers substantial and numerous. They were, however, placed in a dark and unfavourable position, and could not be seen to the best advantage (silver Banksian medal).

Hardy plants and dwarf Cannas from Messrs. Paul & Son, Cheshunt, furnished an exceedingly pleasing group, and amongst the former were the stately *Eremurus himalaicus*; the pale blue *Codonopsis elematidea*, suggestive of the Canarina campanula of old greenhouses; the compact and graceful *Orobanchium hirsutum*; the golden *Inula glandulosa*; the charming Copper Austrian Briar, and other beautiful single Roses. Bold and effective Poppies were also shown, and the Cannas were remarkable both for their dwarf habit, 2 to 3 feet high, the large size and brilliant colours of their flowers (silver-gilt Banksian medal).

Three tall stems of *Verbascum olympicum* from Messrs. Cannell and Sons, Swanley, were placed at one end of the hall, surprising and delighting many visitors. The stems were 6 to 7 feet high, furnished below with strong leaves, and the upper half a densely branching pyramidal inflorescence of bright yellow flowers. The value of such plants in suitable positions could not be over-estimated, and this exhibit will call prominent attention to them (bronze Banksian medal).

A group from Messrs. J. Veitch & Sons, Chelsea, comprised the remarkable *Iris Gatesi*, certified and described below; the peculiarly graceful *Chionographis japonica*, with long slender spikes of filamentous white flowers suggestive of the Orchid family; two reddish salmon varieties of *Azalea indica* named the Mikado and the Daimio, both from out of doors, where they had stood all the winter. Fine bushes of *Fabiana imbricata* and *Ozothamnus rosmarinifolia* were also shown from the Coombe Wood Nurseries, where so many rare plants flourish.

Sarracenias are seldom so well represented as they were in Messrs. B. S. Williams & Son's collection on this occasion, the healthy well coloured plants admirably illustrating the characters of this singular genus. The most distinct in form and colouring were *Wilsoni*, *Mitchelliana*, *Courti*, *Chelsoni*, *Tolliana*, *deccora*, *Williamsi*, *illustrata*,

and hybrida. Dionæas and Droseras were also included in the group (silver Banksian medal).

By far the largest collection of cut flowers came from Messrs. Kelway and Sons, Langport, Somerset, their boxes of beautiful Pæonies, Pyrethrums, Irises, Delphiniums, Gaillardias, and hardy flowers filling the whole of one side table, and comprising many hundreds of flowers in great variety (silver-gilt Flora medal). Pæonies and Irises from Messrs. Barr & Son, King Street, Covent Garden, also contributed an important exhibit, the Irises including numbers of handsome varieties extremely diversified in colours. Messrs. Collins Bros. & Gabriel, Waterloo Road, showed five varieties of Japanese Irises. Mr. Mortimer of Farnham contributed a fine group of Coleuses (vote of thanks); and Mr. R. Dean, Ealing, sent some Pinks and other cut flowers.

In the classes provided for amateurs there was not much competition, only two entering that for a collection of Pæonies. The Rev. W. Wilks, Shirley, was awarded the first prize for bright flowers, and Mr. T. H. Crisp was second with rather more massive flowers. The Pyrethrums were disqualified because the varieties were not all of English origin as required by the schedule.

ORCHID COMMITTEE.—Present: Harry J. Veitch, Esq., in the chair, and Messrs. De B. Crawshay, H. William, H. M. Pollett, E. Hill, T. B. Haywood, J. O'Brien, and Lewis Castle.

Messrs. B. S. Williams & Son, Upper Holloway, contributed a handsome group of Orchids, comprising Cattleyas, Cypripediums, and Odontoglossums, in many fine varieties and large plants, making a capital floral display. Very notable were *Dendrobium Phalaenopsis Statteriana*, *Cypripedium superbiens*, *O. selligerum majus*, *Oncidium macranthum*, *Thunia Bensoniæ*, the yellow *Anguloa Clowesi*, and the graceful *Palumbina candida* (silver Banksian medal). Messrs. Sander & Co., St. Albans, sent several new and interesting Orchids, and besides those for which awards were granted by the Committee were the strange green and brown spotted *Catasetum barbatum* with a white filamentous lip; *C. callosum*, brown and green; the beautiful *Paaius Humbloti*, *Epidendrum Randi*, and several *Odontoglossums*.

Messrs. Veitch & Sons, Chelsea, exhibited their hybrid *Disa Veitchi*, recently figured in this Journal, and *Cypripedium Astræa*, a hybrid between *C. Spicerianum* and *C. philippinense*, showing much of the character of the former species in the dorsal sepal. Messrs. Seeger and Tropp, East Dulwich, contributed a collection of Orchids, including Cattleyas, several rare *Masdevallias*, the bright red *Saccolabium curvifolium*, the distinct creamy white *Aeranthus grandiflorus* and *Masdevallia Moensi*, a hybrid from *M. Wagneri* and *M. Shuttleworthi xanthocorys*. J. T. Gabriel, Esq., 6, Palace Road, Streatham Hill, showed a variety of *Cypripedium Curtisi*, named *superbum*, having large flowers and a very dark lip.

Sir Trevor Lawrence, Bart., M.P., Burford Lodge, Dorking, exhibited an extraordinarily fine specimen of *Masdevallia Davisi*, having thirty-six fine yellow flowers open, a purple tinted *Odontoglossum crispum* named Purple Emperor, also the peculiar green *Cynoches chlorochilon* (botanical certificate).

CERTIFICATED PLANTS.

Iris Gatesi (J. Veitch & Sons and C. G. Van Tubergen).—A remarkable new Iris in the style of *T. Susiana*, of which some might regard it as a pale variety. The flowers are very large with broad rounded standards and falls about 4 inches in diameter, of a creamy tint and semi-transparent texture, with fine veins of dark purple and numerous minute dots of a similar hue (first-class certificate).

Weigela hortensis nivea (J. Veitch & Sons).—A great acquisition amongst these useful shrubs the flowers pure white, produced in abundance (first-class certificate).

Indigofera Gerardiana alba (J. Veitch & Sons).—Another useful plant with pinnate leaves, and long slender racemes of white flowers, graceful and distinct in habit (first-class certificate).

Lælia Gottoiana (E. Gotto, Esq., The Logs, Hampstead Heath).—Supposed to be a natural hybrid between *Lælia grandis* and *L. Boothiana* or *L. purpurata*, most distinct in form and colour. The flowers are of great size, the sepals and petals rosy purple, the lip very broad, crimson purple, with deeper veins, and an undulated margin (first-class certificate).

Lælia grandis, *Tring Park variety* (Lord Rothschild).—The finest variety yet seen, notable for the breadth of the bronzy brown sepals and petals, and with a dark purple lip (first-class certificate).

Odontoglossum crispum, *Burford variety* (Sir Trevor Lawrence).—A fine variety, with well formed flowers, the sepals and petals nearly equal in size and shape, heavily blotched with brown on a white ground.

Dendrobium Phalaenopsis Statteriana (B. S. Williams & Son).—A variety possessing large flowers of a very dark purplish tint, quite distinct from the ordinary type (first-class certificate).

Lacæna bicolor (Sander).—A peculiar Orchid with a long raceme of creamy flowers, the lip claret purple, and the small petals tinged with purple at the base.

Thunia Bensoniæ Winniana (C. Winn, Uplands, Birmingham).—Very superior to the ordinary form of *T. Bensoniæ*; the flowers large the lip broad, and the colour much deeper than usual.

Odontoglossum luteo-purpureum illustre (Sander).—Flowers of fine shape blotched with bright shining brown on a clear yellow ground, the lip long, tipped with cream, and a broad, dark basal band.

Cynoches chlorochilon (Sir Trevor Lawrence and F. Sander & Co.).—A peculiar green flowered species, strange alike in shape and colouring (botanical certificate).

Gloxinia Electra (J. Veitch & Sons).—A grand variety, deep violet purple, margined with light blue and spotted in the throat.

Gloxinia Monarch (J. Veitch & Sons).—A superb rich crimson variety, flowers massive and of fine form.

Carnation Iver White (C. Turner).—Flowers pure white, of excellent shape, and very fragrant.

Carnation Lord Rendlesham (J. Mill, Wickham Market).—Flowers deep terra cotta or orange, in the way of Mrs. Reynolds Holc.

Canna Jules Ch. étien (Paul & Son).—A fine variety, flowers intensely rich scarlet, very large.

Campanula abietina (Paul & Son).—A charming Bellflower of erect habit, the flowers a soft purple shade, very freely produced.

Begonia Madame la Baronne de Saint Didier (H. Cannell & Sons).—A handsome double Tuberos Begonia of a clear delicate yellow shade.

Begonia Major Hope (H. Cannell & Sons).—Another double Tuberos variety, bright rose, with a lighter centre, full and fine shape.

Iris variegata Robert Burns (Barr & Son).—An effective variety, the standards yellow, the falls rich maroon, veined on a light ground.

Pæony Moonbeam (Kelway & Son).—A large double variety, creamy white, the broad guard petals of a blush tint.

THE ANNUAL DINNER.

THE annual dinner of the Royal Horticultural Society was held on Tuesday evening, June 23rd, in the Whitehall Rooms, Hôtel Métropole, when there was a good attendance of visitors, Fellows, and their friends. The President of the Society (Sir Trevor Lawrence, Bart., M.P.) was supported by His Excellency the Greek Minister, M. Jean Gennadius, Baron Schöler, Sir J. T. D. Llewelyn, Bart., the Right Hon. the Earl of Rosse, the Right Hon. Lord Justice Fry, Sir James Paget, Bart., Sir Joseph Lister, Bart., Professors Michael Foster and W. T. Thiselton Dyer, Dr. Farquharson, M.P., Norman Lockyer, Esq., F.R.S., Martin R. Smith, Esq., Dr. Bonavia, Dr. Hogg, T. B. Haywood, Esq., N. N. Sherwood, Esq., the Mayor of Croydon, J. Eagleton, Esq., and Mr. Sheriff Farmer. The Rev. W. Wilks (Secretary), D. Morris, Esq., Phillip Crowley, Esq. (Treasurer), and Mr. Weathers (Assistant Secretary) presided at the side tables. There was a representative attendance of amateur and trade horticulturists, including many members of the Scientific, Fruit, Floral, and Orchid Committees. During the dinner, which was well served, the band of the Scots Guards performed a select programme of music, adding greatly to the enjoyment of the gathering.

The toast list prepared was as follows:—

"The Queen and Royal Family," proposed by Chairman, Sir Trevor Lawrence, Bart., M.P. "The Ministers of Foreign Countries," proposed by Chairman, responded to by His Excellency the Greek Minister. "The Houses of Parliament," proposed by W. T. Thiselton Dyer, Esq., K.C.M.G., F.R.S., responded to by the Rt. Hon. the Earl of Rosse and Dr. Farquharson, M.P. "The Royal Horticultural Society," proposed by Sir James Paget, Bart., responded to by Sir Trevor Lawrence, Bart., M.P. "Botanical Science," proposed by Professor Michael Foster, Sec. R.S., responded to by the Rt. Hon. the Lord Justice Sir Edward Fry and Dr. C. Stewart, President, L.S. "The Right Hon. the Lord Mayor," proposed by Baron Henry Schröder, responded to by the Rt. Hon. the Lord Mayor, Master of the Worshipful Company of Gardeners. "The Treasurer and Benchers of the Inner Temple," proposed by D. Morris, Esq., F.L.S., responded to by H. W. Lawrence, Esq., Sub-Treasurer of the Inner Temple. "The Visitors," proposed by Martin R. Smith, Esq., responded to by Dr. Aitchison, C.I.E., F.R.S. "The Horticultural Trade," proposed by Sir James Whitehead, Bart., Master of the Worshipful Company of Fruiterers, responded to by N. N. Sherwood, Esq. "The Horticultural Press," proposed by Rev. W. Wilks, M.A., responded to by Dr. Hogg, LL.D., F.L.S.

Owing, however, to the absence of some of the gentlemen named, and to the lengthy character of the earlier speeches, the programme was modified by the omission of the two concluding toasts in the list and the substitution of two others. In opening the business part of the proceedings Sir Trevor Lawrence stated that he had received telegrams and communications from the Lord Mayor and Sir James Whitehead regretting their inability to be present owing to urgent business. Mr. Chaplin and Sir Lyon Playfair had also expressed their regret at not being able to attend. The Chairman then proposed the first toast, and referred to the interest which the Queen and other members of the Royal Family had taken in the Royal Horticultural Society. This toast was followed by "The Ministers of Foreign Countries," to which the American Minister was to have responded, but in his absence M. Gennadius, the Greek Minister, replied in an admirable speech. The "Houses of Parliament" was proposed by W. T. Thiselton Dyer, Esq., and responded to by the Earl of Rosse and Dr. Farquharson in suitable terms, but the speeches were necessarily to a great extent of a non-horticultural character.

Coming to the toast of the evening, "The Royal Horticultural Society," Sir James Paget said the work in which they were engaged was one which ministered to the happiness and welfare of the whole nation. He wished he were better acquainted with the conditions of botany of the present day to be able to speak to them more adequately upon the subject; but the botanical studies of his early years had become somewhat antiquated, and since then his pursuits had been of a very different kind. The Society devoted itself largely to the production of beauty in its most marvellous manifestations. No one could fail to see how

those efforts were appreciated, how the appreciation continually reached lower and lower. At the time the Society was founded, and for years later, the most ordinary flowers were rarely to be found except on the tables of the rich. Now flowers of the greatest beauty were to be found in the lowest alleys of this great City, and everywhere they carried the same civilising and exalting influence (hear, hear). Therefore it was impossible to do otherwise than wish well to a Society which had done so much to develop these influences. The speaker then referred to his long friendship with Sir Trevor Lawrence and his family, and concluded his thoughtful, earnest speech, which was loudly applauded.

The President in replying, after thanking Sir James Paget for his kindly expressions towards himself, briefly traced the history of the Society. He said that since the founding and incorporation of the Society in the early years of the present century it had done much to promote the art and science of horticulture in Great Britain. Collectors had been employed and dispatched on various expeditions in search of plants; records of their proceedings were published, and they had established an experimental garden of much importance and usefulness. Prominent amongst those who had helped the Society in the early part was the name of Sir Joseph Banks; while later in their career they had owed very much to Dr. Lindley. Of their collectors such names as Don, Douglas, Hartweg, and Fortune were familiar to all; and there were many beautiful and now common garden plants which were introduced by these travellers. It was only necessary to mention *Wistaria sinensis*, *Weigela rosea*, and *Jasminum nudiflorum* as examples of these, for to enumerate all would take up too much time. The Society had been particularly instrumental in the promotion of one important industry, for after sending Fortune to the Tea countries he was employed by the East Indian Company in the introduction of Tea culture into India, where it had developed into a business of great extent and economical importance. Sir Trevor Lawrence then referred to the chequered career of the Society from the time the Chiswick Shows to the South Kensington period, and the satisfactory progress which had been made since leaving the gardens at the latter place. The number of Fellows had increased rapidly, now they were applying themselves strictly to the objects for which the Society existed—namely, the encouragement of horticulture in all its branches. He referred also to the additional interest that had been imparted to the fortnightly meetings, and observed that their best thanks were due to both amateurs and the trade who had so freely supported them, and to the members of all the Committees. They were also desirous of improving the Garden at Chiswick and extending their system of experiments. He further remarked that while the Drill Hall had served for a time it was impossible to continue there, as it was in many respects unsuitable, and they hoped ultimately to have a far better place for their meetings (loud applause).

Professor Michael Foster, in proposing "Botanical Science," said that though he was called a scientific man he was also known as a gardener, and it was in that capacity that he wished to perform the task allotted to him. He considered that the true botany properly applied to gardening could perform a useful service, and science after all was only common sense rigidly applied to the things around us. The speech was an admirable one and highly appreciated. In responding, Lord Justice Fry said that he thought while gardening may have been benefited by botany, yet horticultural methods have also helped botany, for gardening was necessarily experimental. Many important problems could be investigated by gardeners that botanists could not study to the same advantage. Sir C. Stewart, President of the Linnean Society also replied.

Baron Schröder stated that the absence of the Lord Mayor afforded him an opportunity of introducing a toast which he thought should not have been omitted—namely, the "Health of the Chairman," which he had much pleasure in proposing, for he knew, as they all knew, how much Sir Trevor had done for the Society. He referred to the proposed Horticultural Hall, which he hoped one day to see an accomplished fact, because he felt convinced it would be greatly to the advantage of horticulture generally as well as to the Society. The Chairman responded with a few expressions of thanks, and Mr. D. Morris then proposed the "Benchers of the Inner Temple," which was replied to by Mr. H. W. Lawrence. "The Visitors," proposed by Mr. Martin R. Smith, and replied to by Sir Joseph Lister, Bart., in the absence of Dr. Aitchison. Sir T. Lawrence then paid a well-deserved compliment to the Secretary (the Rev. W. Wilks), and in proposing his health said it was impossible to describe the value of the services he had rendered. Mr. Wilks briefly expressed his thanks, and this concluded the proceedings, the two remaining toasts being withdrawn, as the evening was far advanced.

GRAPES SCALDING.—Muscats and Lady Downe's often scald at this season of the year. When completing the stoning process the Vines must have abundant ventilation, sufficient warmth being kept in the hot-water pipes to maintain a night temperature of 65° to 70°, and 5° to 10° more artificially in the daytime, as, if they are kept cold and close they are, if the weather prove bright, liable to scald. Muscats may have a single thickness of pilehard or doubled herring netting drawn over the roof lights, especially if the panes of glass are large, which will prevent the sun acting too powerfully on the berries and hinder their scorching, as they sometimes do when exposed to the full glare of the sun at the commencement of the ripening process. Hamburgs are best assisted by a good spread of foliage, not having recourse to shading until the fruit is ripe.—G.



ONCIDIUM LOXENSE.

FREQUENT instances occur of plants distinguished by well marked characters being brought into notice and then disappearing for many years until they are accidentally recovered, and everyone is surprised that they have been so long neglected. *Oncidium loxense*, of which a flower is depicted in fig. 97, is an example of this kind, for though it has been known for over forty years and occasionally introduced in small numbers it has always been scarce, and it is said no plant has been imported alive within the last fifteen years until quite recently, when some strong plants were secured, which have flowered freely during the past and present months. One of these, shown by J. Ingram, Esq., of Godalming, was exhibited at the Temple Show on May 28th, and the Orchid Committee awarded a first-class certificate for it. Though belonging to the *O. macranthum* section it is very distinct in the flowers, which are produced in long twining racemes. The sepals are roundish ovate, pale green transversely striped with brown, the petals are of similar shape and dark brown; the lip is rounded, curiously hollowed, or cupped, and bright golden yellow, which shows well in contrast with the other portion of the flower.

O. loxense was described by Lindley in Paxton's "Flower Garden," vol. ii., page 128, in the year 1851, and he there mentions that it is a native of the Cordillera, near Loxa, flowering in July. "A single plant was found by Hartweg with a flower stem 9 feet long. It is near *O. corynephorum*, but the flowers are more than twice as large; but the lip has quite a different form, and the

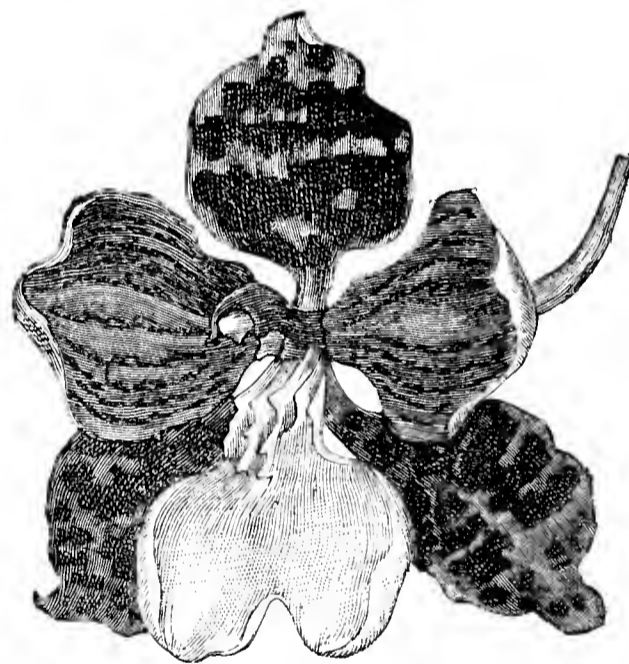

FIG. 97.—ONCIDIUM LOXENSE.

column has two spreading arms near the base." He further mentions that no trace of the "arms" was shown in a drawing by Mathews or a figure by Pæppig which he possessed.—L. C.

REVIEW OF BOOK.

Lindenia, Iconography of Orchids, by M. M. J. LINDEN, LUCIEN LINDEN, EM. RODIGAS, and Mr. R. A. ROLFE. Published by Lucien Linden, 100, Rue Belliard, Brussels.

WE have now before us five parts of the English edition of the "Lindenia," which was commenced in February of the present year, and with plate 265 of the original work. This as is generally known was published in French, and the English edition has been prepared "at the request of numerous amateurs." It is uniform in size, and will give the same plates, with a translation of the descriptions appearing here and in Belgium simultaneously. The coloured plates are from drawings by M. A. Goossens, chromo-lithographed by M. M. P. de Pannemaeker and G. Severeyns, the majority being faithful representations of the Orchids selected. Colour difficulties have occurred in one or two instances, but on the whole they are from that point of view much more satisfactory than is usual in the chromo-lithography of flowers. The descriptions are full and interesting, giving synonyms and references to other works, but the cultural information is too meagre, especially with regard to rare plants.

Four plants are represented in each number, and the following plates have appeared. Part 1, *Cattleya Rex*, *Cochlioda Noezliana*,

Peristeria aspersa, and *Cattleya Warocqueana amethystina*. Part 2, *Catasetum saccatum*, *Cattleya granulosa*, var. *Brymeriana*; *Odontoglossum Claesianum*, and *Phalaenopsis Lowi*. Part 3, *Mormodes Lawrencianum*, *Oncidium Leopoldianum*, *Zygopetalum Lindeniae*, and *Cattleya Parthenia*. Part 4, *Cypripedium Desboiseanum*, *Oncidium lamelligerum*, *Cypripedium Braganianum*, and *Dendrobium Phalaenopsis*. Part 5, *Cypripedium Stonei*, *Laelia purpurata*, *L. purpurata alba*, and *Zygopetalum Gautieri*. As an example of the style adopted we cite the following from the description of one of the most remarkable Orchids figured.

"*Cattleya Rex*.—This is a striking example of the considerable difficulties which sometimes attend the introduction of new Orchids. The *Cattleya* of which we give to-day the representation has been known to M. J. Linden for fifty years, but it was only at the end of last year that it was sent to Europe. Originally discovered by M. J. Linden during his travels in South America, it was met with again, thirty years later, by Wallis, who proclaimed it the most beautiful of *Cattleyas*, but he did not succeed in sending living plants to Europe. Twenty years after this second discovery, one of the collectors which M. Linden had sent to search for it diligently, succeeded at last in obtaining it, and sent some plants in good condition to Brussels. The great difficulty of this search arose especially from the fact that the plant has not, as have Orchids in general, a central district, a place where it may be found in quantity. Also one of the collectors of Messrs. Linden spent a whole year in the same locality (which it is not yet possible for us to divulge), without seeing or collecting more than thirty plants of this *Cattleya* during this long period.

"The country in which it grows is, moreover, one of the least accessible in South America, and the journey across the mountains, among rugged rocks, sometimes cut naturally in nearly vertical steps, without even an indicated path, without any base of operation, in the midst of difficulties without number, entail the loss of considerable time, and frequently the life of the plants collected with so much trouble. One can form an idea of the difficulties encountered when it is stated that not only the plants but also the collectors themselves have to be carried for several days on the backs of the Indians. These persistent efforts were amply compensated for when one of the plants imported produced in December last a raceme of its splendid flowers, of which we now publish a representation. Seldom has the appearance of a new Orchid made an equally striking impression on the beholder, and yet the flowers were produced on an unmaturing growth, and had not attained their natural dimensions. We may affirm that those which will appear this year will be sensibly larger than those represented on our plate. As to colour, we do not think it possible to surpass them in beauty. Throughout the whole Orchid family there exist but few gems comparable to the labellum of this species, in which the purple combined with gold is modified into a crimson of the hue of Spanish wine, and the marblings and the veins are of an exquisite elegance."

The work is well printed on good paper, and will make a fine volume when bound.

YORK SHOW.

THE Committee, by whose efforts the great floral displays are annually produced in the above-named ancient city, scored another triumph at the Show which opened on Wednesday, the 17th inst., and continued over the two following days. In magnitude, diversity, and excellence the Show was alike remarkable, and as a representative Exhibition of specimen and decorative plants, as well as of flowers and fruit, it would be difficult to conceive one more complete and satisfactory. Specimen stove and greenhouse plants were magnificent, groups of plants superb, Pelargoniums wonderful, Fuchsias admirable, Orchids excellent, Clematises imposing, Palms and Ferns superior, cut flowers as arranged in bouquets, baskets, and epergnes and stands charming, Roses, though not in such large numbers as usual, beautiful, while Pansies and Violas far exceeded, both in numbers, variety, and quality, any previous display at York, or, perhaps, elsewhere this season. Fruit was also well and extensively shown by first-class cultivators, and the competition was extremely close in the majority of the classes throughout the Exhibition. Six very large marquees were provided for the produce, and the whole of them filled. The work of arrangement must have commenced with the dawn of day, if not on the night previous, and all was in readiness for judging at the appointed time—an achievement creditable alike to exhibitors and officials. The Show was essentially competitive, and handsome prizes were offered in the leading classes.

STOVE AND GREENHOUSE PLANTS.—The three collections of sixteen specimens, ten to be in bloom, were in a double sense the centre of attraction, first by the size and symmetry of the chief plants themselves, and secondly by the position they occupied—elevated on a stage in the centre of the circular tent. The first prize of £20 was won without much difficulty by Mr. E. H. Letts, gardener to the Earl of Zetland, Aske Hall, Richmond, Yorkshire. It was indeed a grand collection—Azaleas of huge dimensions, fresh and floriferous; splendidly grown Ericas, a fine Hedera and Clerodendron, with sundry others; also large Palms, and a noteworthy example of *Croton angustifolius*. The Veitch Memorial medal and £5, offered for the best flowering plant in the Show, was adjudged to Mr. Letts for *Erica depressa* in this group, a specimen nearly 5 feet in diameter, profusely flowered, and remarkable also for its deep green leaves. The remaining prizes in the great class were won by Messrs. J. Cypher, Cheltenham, and Mr. J. Currey, gardener to Lieut.-Col. Pepper, Milford Hall, Salisbury, both collections containing some well-grown plants. In the class for six specimens in

bloom the competition was extremely close between Mr. H. Johnston, gardener to J. B. Hodgkin, Esq., Elmridge, Darlington, and Mr. F. Nicholas, gardener to the Earl of Zetland, Upleatham, Saltburn, the former just managing to secure the premier position. For three flowering specimens Mr. J. P. Leadbetter was first, the bright old *Diplacus glutinosus* not often being seen represented so well. Mr. Johnston was second in this class. He also won the chief prize for a single specimen stove plant, a fresh *Ixora*; and Mr. Leadbetter in the corresponding class for greenhouse plants with a huge *Imantophyllum (Clivia) miniatum*. Cape Heaths were well exhibited, Messrs. Cypher, Nicholas, and Currey securing the prizes in the order named. Azaleas were rather small, and the chief prize went to the smallest plants, having the best foliage and flowers, exhibited by Messrs. W. Jackson & Co., Cross Lane, Bedale. The best greenhouse Azalea (*A. Veitchi*) was exhibited by Mr. Johnstone.

ORNAMENTAL FOLIAGED PLANTS.—These entirely filled one marquee, Crotons and Dracenas finding positions in others. With one or two exceptions the leading prizes were not granted for the largest specimens, and where there was a conflict between large plants having somewhat faulty leafage, and smaller examples fresh and healthy, the latter were accorded preference. For six fine foliage plants the honours fell to Messrs. Letts, J. McIntyre (gardener to Mrs. Gurney Pease, Darlington), and J. Currie, all with fine clean examples. Mr. Letts was first with four remarkably fine and well coloured Crotons, Mr. McIntyre an excellent second, and Mr. Currie a good third. In the class for four Dracenas Mr. McIntyre was first with good-sized and very healthy plants, Mr. Leadbetter second with smaller but fresh and well coloured examples, and Mr. Johnstone third with the largest of all.

There was great competition in the Fern classes, and many fine examples of culture staged, notably in the exotic section, by Messrs. McIntyre, Letts, Currie, Leadbetter, and Nicholson, who won the prizes somewhat in the order named. They were also successful in the hardy Fern classes. Messrs. W. and J. Birkenhead & Sons contributed greatly to the interest of this department with a large and choice collection of these plants.

FUCHSIAS AND OTHER PLANTS.—Fuchsias were very fine indeed, and the competition great. They were mostly free, well-formed floriferous pyramids from 3 to 5 feet in height the prizes being adjudged to Messrs. McIntosh, Eastwood, Clarke, Guest, and Young. Calceolarias were not equal to those staged at the London shows, yet creditable, Messrs. Guest, Young, and Wood, prizetakers; and the same may be said of Gloxinias and Begonias, Messrs. Veary, Wood, and Bellerby being among the successful exhibitors.

ORCHIDS.—Taking the plants in the classes, together with the large collection of Messrs. Charlesworth, Shuttleworth, & Co., Heaton, Bradford, the display was extensive, diversified, and good, but the plants were overcrowded. In the class for ten and also for six plants, Mr. Cypher took the lead with very fine examples; Mr. P. Blair, Trentham, being a very good second in the first-named class, and Mr. C. Rollison, gardener to W. Bateman, Esq., Pannall, Leeds, in the second. With four Orchids, Mr. G. Cooper, gardener to E. W. Beckett, Esq., M.P., Kirkstall Grange, Leeds, secured the first position, followed by Mr. E. Kirkness, Hessele. In the single specimen class Mr. Eastwood was first with an *Angraecum*, Mr. Townsend second with a *Cypripedium*, both plants in superb condition.

GROUPS OF PLANTS.—Two classes were provided for these, one open, the other for amateurs, the prizes in the aggregate amounting to £51. In the open class the space limit was 250 feet. There were three competitors—Mr. P. Blair, Trentham; Mr. J. McIntyre, Darlington; and Mr. W. H. Simpson, Selby, who were awarded the prizes in the order named. The Trentham group was most artistically arranged, and contained many Orchids in the mounds. It was a fine example of decorative work, and it had to be to defeat the bold and beautiful arrangement of Mr. McIntyre, and Mr. Simpson's third prize group would have won a first position at more than half the shows in the kingdom. The "idea" of the two first especially was a series of flowery mounds or choice elevated plants, and ferny and mossy dells. The margins of all were a little too smooth, and a few bright plants somewhat elevated would have been an undoubted improvement. These were provided by Mr. McIntyre in his first prize group (150 square feet) in the amateurs' section, which not a few persons thought was better than his greater effort, and it was certainly highly meritorious, as indeed were the other two groups in the class arranged by Mr. J. Currey, who was second, and Mr. J. R. Dawe, gardener to Dr. Baker, York. The group tent was a distinct and beautiful feature, and the whole of the exhibitors in the two classes well deserved the honours they won.

PELARGONIUMS.—These are always a marked feature, and on this occasion fully maintained the supremacy of York for Pelargonium culture. In the open class for twelve specimens three superb lots were staged, Mr. Eastwood, gardener to Mrs. Tetley, Leeds, being first with a grand example; Mr. McIntosh, gardener to J. T. Hingston, Esq., York, second, and Miss Stewart, York, an excellent third. Miss Stewart was first with six and three admirable specimens, Mrs. Tetley second, and Mr. J. T. Hingston third. Miss Stewart has been an exhibitor for many years, and this year is to be congratulated on her success and first-rate cultivation. Zonals filled more than one side of the centre of a long tent, and were splendid. For twelve Mrs. Tetley was again first with superb specimens of a large size, Mr. H. Pybus, Ripon, second, and Miss Stewart third; and in the classes for six and three Mrs. Tetley was first and Miss Stewart second. Some fine double Pelargoniums were also staged, and several extra fine specimens of Ivy-leaved Pelargoniums, Mr. G. Cottam, Cottingham, being first in the class also for double Zonals.

ROSES in pots, six varieties, open to all.—First, Messrs. W. Jackson, and Co., Bedale. Second, Mr. H. Pybus, Ripon. Third, Miss Steward. For twelve in not larger than 9-inch pots, open.—First, Messrs. Jackson and Co. Second, Mr. H. Pybus. Third, Mrs. Tetley. Messrs. Jackson and Pybus were also the most successful exhibitors in other classes. Cut blooms were by no means so numerous as last year or so good, and this was not to be wondered at. Three lots of seventy-two blooms were staged. First, Messrs. Harkness & Sons, Bedale. Second, Messrs. D. Prior & Son, Colchester. Third, Mr. Henry May, Bedale. For forty-eight, thirty-six, twenty-four, and eighteen varieties Mr. May was first, and Messrs. Jackson & Son second for thirty-six and twenty-four. For twelve white and yellow Roses Messrs. Harkness & Sons were first with a very good bloom. There were also several classes for amateurs.

BOUQUETS AND CUT FLOWERS.—There were three classes for bouquets—bridal, ball, and hand, two in each class. Messrs. Perkins and Sons, Coventry, won easily in each with their well-known style of bouquets. Mr. A. W. Booty, florist, Harrogate, was second for bridal and ball bouquets, with the new style of a sort of sugarloaf shape. Some charming baskets of flowers were staged, and here Messrs. Perkins was first and Mr. Booty second.

There was a good display of hardy herbaceous flowers, Messrs. Harkness & Sons being first; the Earl of Carlisle second; Mr. J. B. Hutchinson, Kirby Moorside, third; and Mr. Thomas Battensby, Blaydon-on-Tyne, fourth. Some excellent stands of Pyrethrum were staged, Messrs. Harkness & Sons taking first honours for doubles and singles.

PANSIES.—Of these was a very fine display, by far the greatest ever seen at York. In the open classes for twenty-four Show varieties Mr. A. Lister, Rothsay, was first; Mr. A. Bailey, jun., Sunderland, second; Mr. T. Battensby, Blaydon-on-Tyne, third. Twenty-four Fancies (open) Mr. Bailey, jun., first; Mr. Lister second, Mr. T. Battensby third. The several amateur classes were well filled. Mr. Andrew Irvine, florist, Tigh-na-bruaich, Scotland, had a superb lot of blooms not for competition, including many new varieties and first-class seedlings, to be sent out shortly. Of these and other new kinds exhibited here we shall give a special notice soon. Mr. A. Lister, florist, Rothsay, had a number of fine blooms not for competition, and was awarded a certificate for "Mrs. Gray," a fine seedling Fancy. Mr. Henry Brooke, florist, Durham, had a good display of Fancy Pansies, so also had Mr. Forbes, florist, Hawick. Violas were also exhibited in competition, but the usual formal style of exhibiting these is objectionable. It is time some style was adopted showing more the natural habit of the Viola. No new varieties were exhibited.

MISCELLANEOUS EXHIBITS.—These, though not numerous, were important, and comprised splendid Clematises from Messrs. Richard Smith & Co., Worcester; a very fine collection of Orchids from Messrs. Charlesworth & Shuttleworth; a great and diversified assortment of Ferns from Messrs. W. & J. Birkenhead, Sale; an attractive assortment of plants and flowers from Messrs. Cutbush & Sons, Highgate; and a remarkable display of Pansies from Messrs. J. Irvine and Lister, for all of which certificates of merit were awarded.

FRUIT.—Fruit is always a great feature of interest to the many thousands who visit this Show, and although the past season has been very much against fruit growers, that staged was quite equal to former years, the thirteen collections and the single dishes making a most imposing and tempting exhibition. Pines were shown well, also black Grapes and Peaches. White Grapes were good both in bunch and berry, but wanted a little more sun to finish them properly.

Collections.—The chief class was for ten dishes, and excellent fruit was staged by the four competitors. The first prize was won by Mr. R. Parker, Impney, who staged black Hamburgh Grapes, medium sized, and jet black. Foster's Seedling, quite ripe; Queen Pine, 6 lbs., and a good Lord Carrington; Blenheim Orange and Golden Gem Melon, Stirling Castle Peaches, large and well coloured Nectarines, Lord Napier and Pitmaston Orange, and a good dish of Figs. The second prize fell to Mr. Dawes, who had massive bunches of Foster's Seedling and Madresfield Court Grapes hardly finished, a good Queen Pine, large and handsome Temple Newsam Melon. Mr. McIndoe was third prize winner with a very heavy and imposing lot, a small Queen Pine greatly letting this good collection down. The remaining prize was adjudged to Mr. Edwards. In the class for six dishes Mr. McIndoe just managed to defeat his old pupil, staging a first class lot. The Black Hamburgh Grapes being very massive for the time of year. Grosse Mignonne Peaches were large and highly coloured, and he had capital Figs and a good Melon. Mr. R. Parker was a close second. A good Queen 5½ lbs., and Black Hamburgh Foster's Seedling Grapes being his best dishes. Mr. Westcott, Raby Castle, secured the third, and Mr. P. Blair the fourth prize in this class. Mr. McIndoe was first with four dishes, and his heavy Hamburghs were again conspicuous, Mr. Westcott following with good Grapes and Peaches. Mr. Leadbeater third. Mr. Slade was first with a heavy Queen Pine, and Mr. Parker second.

Grapes.—The class for three bunches of Black Hamburghs brought out seven competitors, all staging well. Mr. Allsopp, gardener to Lord Hotham, was placed first with grand bunches, large and even berries, and well finished. Mr. McIndoe second with larger bunches, and Mr. Anderson, Cattal, York, third. In the white Grape class, three bunches, Mr. Allsopp was again easily first with Buekland, model bunches; Mr. Wallis, Kirby Hall, second, with Foster's Seedling; and Mr. Anderson third with Muscat of Alexandria.

Peaches.—These were very good throughout. Mr. Upjohn was first with grand Stirling Castle; Mr. Wallis, Keele Hall, second, with large and well coloured Hals's Early. In the class for Nectarines Mr. P. Blair was placed first, and Mr. Parker second.

Melons, scarlet-fleshed.—Mr. McIndoe took the lead with a small fruit called Scarlet Model. Second, Mr. Riddell, Castle Howard. Melon, white-flesh, Mr. Clayton was placed first, and Mr. Westcott second; and for the green-flesh class Mr. Riddell was first, and Mr. Edmonds second.

Mr. Wallis and Mr. Blair were first and second respectively for Figs. Mr. R. Dawes taking the lead with Cherries, showing a grand dish of Black Circassian. Mr. P. Blair was first in the Strawberry class, staging a splendid dish of Sir Harry. Mr. Hare second with President. Mr. Upjohn was first for Tomatoes, showing a variety called Smith's Favourite.

In the afternoon of the first day the Council, Committees, visitors, chief exhibitors, and Judges lunched together. Alderman Sir Joseph Terry, J.P., Chairman, ably presiding, supported by the Lord Mayor of York and other city dignitaries, with the Mayor of Leeds and representatives from Newcastle and other northern towns.



FRUIT FORCING.

PEACHES AND NECTARINES.—*Early Forced Trees.*—Very early and continuous forcing to have the fruit ripe in May taxes the energies of the trees severely, inasmuch as they have to make the growth during the early spring months and mature it in early summer. Therefore, after the fruit is all gathered, ventilate to the fullest extent, if possible removing the roof lights entirely by the middle of July, or earlier if the weather be hot and the growths are sufficiently matured. If the roof lights are not moveable, in addition to ventilation to the fullest possible extent, the border should be frequently damped and duly watered, so as to keep the foliage fresh, and no check given likely to induce the premature ripening of the young wood and leaves. Keep the latter free from red spider by syringing occasionally, and if necessary apply an insecticide, as it is of the greatest importance that the foliage be kept healthful and ripened naturally. Laterals must be stopped, but where there is space to allow of growth being made encourage it, as a steady and progressive growth by promoting root action will prevent the buds and foliage maturing too early. All shoots that have supported fruit and are no longer required should be removed to let air and light freely to the growths, and if there is too much crowding of the shoots for next year's bearing thin them well to admit sun for the solidification of those left, and the action of water upon the foliage to cleanse and keep it free from red spider.

Houses with Fruit Ripening.—Except on cold nights and in dull weather, to maintain steady progress, with the admission of a little air constantly to insure flavour, fire heat will not be necessary, but later varieties may need assistance in swelling and finishing, therefore circumstances must be taken into consideration. A temperature of 60° to 65° at night and 70° to 75° by day, with 10° to 15° more from sun heat, are essential to the full swelling off and securing of quality in the fruit. Afford moderate air moisture for the benefit of the foliage, and do not allow the border to become dry and cracked, but supply water as required, and a mulching of spent, rather lumpy, but not decayed material will keep the surface in a condition favourable to the activity of the roots, and that without overdue atmospheric moisture. If the weather be very bright some netting spread over the roof lights will be an advantage in preserving the delicate skinned varieties, such as Noblesse, from unduly heating by the sun's rays, causing the fruit to ripen at the apex greatly in advance of those on the lower parts, and the fruit not infrequently decays there through over-ripeness, whilst the lower part is quite hard. These, indeed all fruits, are better ripened gradually than by being much heated, as is sometimes done under the large and clear panes of glass rightly employed in modern fruit houses. A double thickness of herring nets or a single thickness of pilehard net drawn over the roof lights will sufficiently break the most powerful sunlight, ensuring the fruit ripening evenly.

Young Trees.—Disbudding must be practised on all growths not required, and in young trees is apt to be neglected until the growths are considerably advanced. This is a great mistake, as it not only weakens the growths essential for forming the principal branches, but in removing them at a late period wounds are made that induce gumming, and the shoots receive so much sap that they push laterals and favour grossness instead of sturdy growth well solidified as made. The principal branches, or shoots to form them, should be 12 to 15 inches apart, and the shoots for next year's fruiting originated from the previous year's shoots disposed about 15 inches asunder along them, stopping them if necessary at that extent of growth, and the laterals to one joint as produced. The extension, or main shoots, should be trained in their full length, provided they are evenly balanced. If the shoots on one side are stronger than the other, depress the strong and elevate the weak, so as to induce an equal distribution of vigour throughout the tree. Any gross shoots may be stopped, as they are a great inducement to gumming. Indeed, trees gross when young, seldom turn out healthy, therefore it is better to cut out excessively strong wood, encouraging the short-jointed and sturdy. Ventilate early in the day, increase it with the advancing temperature,

avoiding a close vitiated atmosphere by leaving on a little air constantly. Essential growths must be trained so that sun and air have free access to them, keeping them thin so as to insure their thorough solidification; and to keep the foliage clean and healthy is important in supplying the buds with nutriment and to ensure accumulation in the adjacent wood of elaborated matter for the due setting of the blossom and the stoning of the fruit in the ensuing season.

Figs.—Second Crops.—The fruits on early forced trees have now swelled to a good size, and if judiciously thinned there will be a crop of fine Figs. To insure this they must not be overcropped, the foliage kept free from insects, and the feeding liberal. When the crop is heavy, and former thinning not having been sufficient, a second thinning should take place at once, leaving the most forward at the base of the shoots, which will ripen earlier than the others, and so afford more time for the ripening of the shoots at their points, these being kept well up to the light. Early forced planted out trees should have the young wood ripened and be resting by the middle of October.

Watering.—Should the borders have become dry whilst the first crop of fruit were ripening they must be watered repeatedly through a mulching of a stimulating nature until the soil is thoroughly moistened through to the drainage. Liquid manure will be required by trees having their roots in borders of limited extent, and more frequently than by trees with a larger extent of rooting area; about once a week in the first case, and every fortnight in the other, giving the rough supplies, and always in a tepid state. The mulching must be kept moist so as to encourage surface roots.

Insects.—Syringing will need to be practised twice daily, except in dull wet weather, when morning or early afternoon syringing will be sufficient, and always early enough to allow of the foliage getting dry before night. Judicious and forcible syringings are usually sufficient to keep down red spider, but if it gains a hold it must be dislodged. There is no better remedy than softsoap, 2 ozs. to the gallon; or if there be scale brush the leaves and wood over with a softsoap solution, 3 ozs. to the gallon of tepid water; and having dislodged the scale syringe forcibly with the weaker solution, and afterwards with clean water. Painting the hot-water pipes with a cream of lime and sulphur in equal parts and heating them, with the house closed to 160° to 200° for about an hour, with the mixture on the pipes, is an effectual remedy for red spider. The foliage should be dry, and the following morning the trees should be well syringed. Repeat the heating of the pipes and brushing them with sulphur in about ten days.

Temperature and Ventilation.—Unless the weather is unusually cold and wet artificial heat will not now be necessary, but fire heat must be afforded to maintain a night temperature of 60° to 65°, and 70° to 75° by day. Ventilate early, especially on bright mornings. Keep the house through the day at 80° to 85° with sun heat, and close sufficiently early to run up to 85° or 90°, or even 95°, providing plenty of atmospheric moisture.

Succession Houses—Fruit Ripening.—When the fruit changes colour afford more air, insuring a circulation constantly and a free movement of the atmosphere by top and bottom ventilation whenever external conditions are favourable. Reduce the moisture gradually, keeping it from the fruit, which expose as much as possible to light and air. Well-ripened Figs are delicious, badly ripened insipid. Lessened supplies of water at the roots tell in favour of quality, yet they must not be allowed to suffer; therefore keep the soil moist, damping the surface occasionally, as that is needed for the preservation of the surface roots. Red spider may be kept down by syringing forcibly after gathering the fruit close, and this repeated each time the fruit is gathered will keep insects under until the crop is cleared, when more drastic measures can be taken for extirpating the pests. If done early on a fine day the fruit will not be in the least deteriorated, but the water must be soft, warm, and clear.

Trees Swelling their Crops.—Afford a mulching of short manure, and through this supply tepid water, or in the case of trees carrying heavy crops and not over-luxuriant liquid manure. It is hardly possible to overfeed Figs in well-drained properly constructed borders, and with the roots confined to small areas. Wide deep borders of rich material encourage growth at the expense of fruitfulness. The trees grow magnificently, but that is the extent of their use. In fine weather syringe twice a day, always in good time, and close so as to run up to 90°, 95°, or 100°. As the fruit approaches ripening provide a little ventilation before nightfall, and let it remain, increasing it early so as to dissipate moisture deposited through the night before the sun acts in full force on the foliage. Evaporation provokes elaboration, and on the amount of assimilated matter depends the perfection of the current crop and well-doing of the next. By closing early evaporation is arrested, and damping aids the restoration of the wasted energies, securing a maximum of growth in the fruit.

Late Houses.—Grand Figs are grown in cool houses—one crop ripening in August and September. They are not as common as their merits warrant, for the fruit is of a most wholesome kind, and they form grand addition to desserts. Calcareous soil, well-drained narrow borders, light well-ventilated structures afford best results. The chief points are to grow thin, feed highly, ventilate early, close soon enough in the afternoon to keep a good heat until the evening, affording a moist atmosphere. Avoid overcrowding the growths, stop side shoots at the fifth leaf, mulch the surface, and water liberally. Let the shoots grow with their points to the glass, just keep them clear of it, and they will fruit abundantly.

STRAWBERRIES IN POTS.—Outdoor fruit is late, and late indoor supplies, comprised as they usually are of the choicest varieties, as Dr. Hogg and others of the British Queen race, are held in higher esteem than the small early outdoor fruits or their indifferent quality. La Grosse Sucrée is the finest, all points considered, of early forcing Strawberries.

Vicomtesse Herieart de Thury has freedom of setting and quality to recommend it, but unless well thinned the fruits are too small. Noble and Auguste Nicaise have size and free setting and swelling properties, but the appearance of the first is not good; and the latter, though more glossy, has not the quality of the preceding two. Sir Joseph Paxton is superb where it is not injured by mildew, and the best all-round Strawberry. President does well forced, but is liable to spot, and has not the firmness of Sir Joseph Paxton. Sir Charles Napier yields to none in appearance and brilliancy of colour. Marguerite also has bright fruit, and very large. James Veitch fruits freely, and swells to a great size, which is the measure of its utility. Unser Fritz is bulky, and may be put in the same category with Noble. British Queen, Dr. Hogg, and Coeksemb have no rivals for late forcing.

THE KITCHEN GARDEN.

ASPARAGUS.—This was late in starting, and has been considerably checked in growth since by severe frosts, those plants rooting very near the surface and unmulched being the greatest sufferers. All things considered, there is no good reason why the cutting should not be continued rather later than usual, growers in the southern counties not ceasing till near the end of June, and those farther north a week or fortnight later. This will not unduly weaken the plants, and by the dates given Peas, Cauliflowers, and other vegetables ought to be getting plentiful. If any exception is made it should be in favour of comparatively young plantations, cutting late from any not more than three seasons planted greatly checking their progress. The last two or three summers have been very favourable to the increase of weeds, and unless these are kept down it will be next to impossible to clear the beds of them later on, their state becoming worse accordingly. On light soils sufficient salt may be strewn on the surface, or say at the rate of 1 lb. to 2 square yards, to kill the weeds, and this dressing also benefits the Asparagus. On heavy clayey land salt proves injurious, therefore keep down weeds when small by timely surface hoeings and hand-pulling of the larger. Asparagus may yet be transplanted wherever this is necessary for filling blanks.

CAULIFLOWERS.—The earliest of these that have been forwarded in handlights should now be forming useful sized hearts. They ought not, when growing strongly, to be cramped in the handlights, but the latter should be removed and used for forwarding Kidney Beans, the Cauliflowers being thinned if need be, and those reserved carefully opened out somewhat. Very large hearts are not needed, and stunted plants will frequently develop surprisingly good centres with the aid of liquid manure. Put out successional plants on well manured ground, and the earliest raised Autumn Giant ought now to be ready for their summer quarters. To do these justice the rows may well be 30 inches apart, a distance of 2 feet dividing the plants in the rows, but the smaller earlier varieties may be planted more thickly with advantage.

BET.—When the plants are about 3 inches in height, or too large for birds to interfere with, the thinning out may safely be completed. The stronger growers may well be singled out to about 9 inches apart, but those which make less top, notably Dell's Crimson and its synonyms, may be left nearer 6 inches asunder, especially if the ground is good. Large roots are objectionable, hence the necessity for somewhat late sowing and for moderately severe thinning only. The turnip-rooted forms transplant the most satisfactorily, but the longer rooted varieties also move fairly well in showery weather. Even if they form somewhat poor roots, filling up by transplanting is preferable to gappy rows.

CARROTS.—Directly the rows of these or any other root crops are well defined, the flat hoe ought to be run between them. A fine day being chosen for this work all small weeds will be destroyed, warmth and air will be admitted to the seedlings, cracking of the ground prevented, and insect pests dislodged from their breeding quarters. Carrots require to be thinned out when large enough to handle. In the case of Early Horn and other quick-rooting varieties the thinning should be of the lightest description at the outset, and continued according as the roots are large enough to use.

ONIONS.—If the Onion maggot has been troublesome in previous years thin lightly, the ground immediately about the reserved plants being disturbed as little as possible. Soot freely applied during showery weather is a preventive of the maggot, and also serves to hasten growth. Onions transplant fairly well in showery weather, but being rather late this season thinnings dibbled out now will not attain a great size.

POTATOES.—Most of these are recovering rapidly from the effects of the severe frosts, but will be benefited by having the soil between the rows deeply stirred with heavy hoes. This being done in dry weather extra warmth will be admitted to the roots, small weeds destroyed, and the requisite looseness of root run insured. The rows, when the haulm is 6 inches in height, to be heavily moulded up, this being best done after a good soaking rain. If another light dressing of either soot, wood ashes, guano or superphosphate, or any other properly prepared "Potato mixture" is given prior to hoeing between the rows this will greatly benefit the Potatoes, and also any crop that may be planted either between or in succession to them.

NEW ZEALAND SPINACH.—The ordinary Spinach usually fails during very hot weather, and what is known as the New Zealand Spinach is the only substitute. The latter revels in a hot position, and if half a dozen plants are turned out of the small pots in which they have been raised on to a sunny moderately rich border they will usually provide quite as many shoots as a moderately large establishment may need. Plant them a yard apart each way, give enough water at the outset to keep them moist at the roots till they have taken possession of their site, and then no further trouble need be taken with them. It is the tops of young shoots that are used.

PLANT HOUSES.

Allamandas.—Large plants confined in pots will be flowering freely, and to keep them growing place a good layer of manure on the surface, and give liquid manure every time they need water. Repot all young plants that it is necessary to extend, and grow them fully exposed to the sun. These plants do well in loam, one-seventh of manure and sand. Shade only is needed for a few hours during the hottest part of the day when large quantities of flowers are expanded. The flowers of *Allamandas* are useful for dinner-table decorations or for shallow dishes when associated with *Adiantum cuneatum*. Plants that have been trained round four or five stakes and carefully hardened may be removed to the conservatory. Stand them where cold draughts will not strike directly upon them. With careful treatment they will grow and flower for a long time in this structure.

Bougainvillea glabra.—A very useful conservatory plant from this period of the year. It should not, however, be grown too warm when intended for these structures. If grown in heat harden the plants and remove them to cooler quarters for the flowers to expand. When developed under cool conditions they are much brighter in colour, and last much longer than those in too much heat. Encourage young plants to make strong wood, which if well ripened will flower freely another year.

Clerodendron Balfourianum.—Plants that are well grown in 6 and 7-inch pots from cuttings rooted early in the season are, if trained round four or five stakes and brought into bloom about this period of the year, conspicuous in the conservatory. After they have flowered they can be grown for another year; but the best method is to prepare some annually and convey those that have flowered to the rubbish heap, unless larger sized specimens are appreciated. Under these circumstances they may have larger pots. Young plants for next year are growing freely in 6 and 7-inch pots. Train them under the roof of a light house exposed to the sun—in fact, any light warm position will suit them.

Stephanotis floribunda.—Keep plants growing in pots by the aid of weak stimulants every time water is needed. If the surface is mulched with decayed manure the roots will soon take possession of it. As long as the plants can be kept growing they will continue flowering provided they are freely exposed to sun and air. Syringe frequently to keep the plants clean. Some attention is needed to train the shoots as they extend, or they soon become entangled and give endless trouble afterwards. Where practicable train the shoots up strings, for they are much more easily taken down than when they are secured to wires of a permanent nature. Where large plants are becoming too thick draw out large shoots and layer them into 10-inch pots. The process is a simple one, about one-third of the wood on the under side being removed and the shoot pegged into the soil and covered about an inch deep. At this season of the year they root quickly, and will soon fill the pots with roots. This is a quick method of obtaining large plants.

Caladiums.—Plants that have been brought on steadily will, if carefully hardened, bear conservatory treatment from the present time without injury. A few well grown plants are most effective for grouping purposes, and any plants that will last fully three months in good condition deserve attention. Plants of this nature change the appearance of these structures during the summer months, and render them attractive when they would not otherwise be so with the ordinary flowering plants.

Acalyphas.—Few plants can be compared to these when well grown. They deserve attention at the hands of those who produce plants for the market. They will bear brisk heat provided they are fully exposed to the sun, when their foliage colours splendidly and the plants become woody. In the conservatory they are far superior to *Coleuses* if hardened for that structure. Plants stand in rooms for a long time without injury. From the present time they can be grown satisfactorily in cold frames provided they are kept close and the frames closed early in the afternoon.

Crotons.—Repot young *Crotons* as they need more root room, and grow them fully exposed to the sun. Use the syringe freely to keep down thrips and red spider. Give soot water in a clear state to those that are rooting and growing freely, and if syringed occasionally beneficial results will follow. Heads of plants that are growing too tall may be re-rooted, also well coloured side shoots for use in small pots.



APIARIAN NOTES.

THE WEATHER.

THIS continued dry and cold up till the 19th, but for some days past it has been warmer, the night temperatures being 36° and the day 68°. The morning of the 19th was the first one that dew appeared, was calm and genial, without sunshine, as it has been for several days, but rain is needed.

FOUL BROOD.

It will be remembered by some of your readers that allusion was made in autumn to one of the most extensive apiaries, of upwards of a hundred hives, being affected with foul brood of a

most virulent form, the owner being advised through the medium of a contemporary to destroy both bees and hives. Being loth to do so, he consulted me. My advice was taken, and in several months after it was reported to me the bees appeared to be cured. The process of cure was what is known as the "purgatorial" one, described by "A Renfrewshire Bee-keeper," but improved by myself to what may be termed a double refining process. The under-noted report now speaks for itself. Had the other advice been taken it would have entailed a loss of £150 to the proprietor, "A. M. M."

"Just a line to inform you my foul broody hives, treated according to your instructions, are now quite healthy, and I thank you for your invaluable and infallible cure, and which will soon be the recognised remedy. Poor year for bees, a few hives still being fed. No swarms."

SUPERING.

With the advent of summer weather supering will be the order of the day, and may be proceeded with at once, as there will not be much risk of chilling brood in warm weather. In Plane tree districts some supers were filled two weeks ago, although only three miles from here.

HINTS TO BEGINNERS—SWARMING.

Continuing my remarks from page 499 I may say that the causes of swarming are when the hive is crowded with bees and filled with comb and the temperature high. At this stage the queen is as it were crowded out; the bees begin to raise royal cells, weather continuing fine, in from five to eight days after a swarm issues. But if royal cells were raised when the queen regnant had relaxed laying through age or debility, generally speaking the swarm does not issue until a queen is hatched, and frequently old and young queens come off together; but as a rule the former is doomed to destruction.

Queens that have almost or wholly ceased laying is the cause of bees and queen leaving the hive *en masse* during the spring months, improperly termed "hunger swarms." Sometimes, but not often, bees and queen leave their hive when incipient foul brood is present, or some other fault of the hive or combs. Small nuclei, if formed with queens from strange hives, are also apt to leave, but not when formed with a queen of their own raising. Large hives or extra room under certain conditions will not prevent a swarm issuing. We might as well attempt to turn the course of rivers upwards as try to prevent swarms when these conditions are reached.

English and American bee-keepers speak of their fertile queens at the age of three and four years, but although they extend the life of queens to that term, the former limit the life of the worker bees to forty-two days and the latter to thirty-five days. As is well known I find queens to be past their best at twelve months old (although I have had several live to six years old), and my workers live frequently to twelve and even fifteen months old. Some have asked, and others may, who is right? My apiary is open for inspection to prove what I say, and every other bee-keeper can easily put the thing to test in their own apiary. The fact is, if bees lived only forty-two or thirty-five days they would cease to be honey bees. My bees are like swarming, so I must attend to them, and in a future article I will describe how best to treat swarms, and to control swarming.—A LANARKSHIRE BEE-KEEPER.

QUEEN-EXCLUDER ZINC.

WHEN making a few remarks on the use of the above I had no idea that "A Lanarkshire Bee-keeper" would have thought it necessary to "enter a protest against those remarks as being to a very great extent misleading and contrary to the previous teaching of this Journal." What "previous teaching" he refers to I do not know. I am aware that it is often remarked that in the *Journal of Horticulture* your correspondent makes out he has a prior claim to any invention or improvement connected with apiculture. He now claims "that Mr. Abbott was not the first to use excluder zinc," because he ("Lanarkshire") "made and sold excluders made of strong wire before the time indicated by Mr. Hooker." I said "I think" Mr. Abbott was the first, &c., and I am quite ready to be put right in the matter if it was not so; but I

fail to see how "Lanarkshire" having sold strong wire excluder proves the contrary. He says Mr. Abbott "showed me the comb referred to, said to be taken from the centre of the brood nest." "It is contrary to the nature of the bees to store honey in the brood nest, and consequently I am unable to accept any statement to the contrary." This is making out Mr. Abbott to have stated what is inaccurate.

The Judges at the Caledonian Apiarian and Entomological Society Exhibition, held at Edinburgh on 21th to 27th July, 1877, thought differently (they were all Scotch bee-masters), for in class 27, for "any new invention calculated in the opinion of the Judges to advance bee culture," they awarded the highest prize to Mr. C. N. Abbott for his method of obtaining sections of pure virgin honeycomb from the centre of the hive. I may mention that at the same Show in "class 17, for the best and most perfect bar-frame hive with super or set of sectional supers and cover complete, the first prize (a silver medal) was awarded to Mr. C. N. Abbott; the second prize (bronze medal) to Mr. John M. Hooker; and the third (a certificate) to Mr. Wm. Thomson. In class 25, for the cheapest, neatest, and best supers for producing honey in a saleable form, the first prize (bronze medal) was awarded to Mr. John M. Hooker."

Mr. Abbott stated that bees finding a space in the centre of the hive, and the queen being unable to breed there, they would most assuredly not leave the space open. He never said bees would store honey in the brood nest in the natural way. I was not advocating this method, but simply speaking of the early use of perforated zinc as an excluder. I pointed out that in Europe and America the hives most in favour were worked with queen-excluder zinc, and whatever "Lanarkshire" may write to the contrary it will play a great part in the apiculture of the future.

To give weight to his statement your correspondent says, "I possess some knowledge of bees," and I, too, think I have proved that I know something about bees, and how to obtain honey. It is on record that I gained "the Bligh competition, open to Great Britain, for the largest return from one stock of bees." I have also been awarded first prizes for comb honey in sections, as well as for extracted honey, at the exhibitions of the British Bee-keepers' Association, open to Great Britain, on different occasions.

My observations on page 457 "Lanarkshire" is pleased to call a huge advertisement. I can only say I have no interest in the sale of the British or any other excluder zinc, neither do I claim any credit for the improvement or the invention.—JOHN M. HOOKER, 9, Beaufort Gardens, Lewisham, S.E.



* All correspondence should be directed either to "THE EDITOR" or to "THE PUBLISHER." Letters addressed to Dr. Hogg or members of the staff often remain unopened unavoidably. We request that no one will write privately to any of our correspondents, as doing so subjects them to unjustifiable trouble and expense.

Correspondents should not mix up on the same sheet questions relating to Gardening and those on Bee subjects, and should never send more than two or three questions at once. All articles intended for insertion should be written on one side of the paper only. We cannot reply to questions through the post, and we do not undertake to return rejected communications.

Wasp Traps (W. G.).—We cannot answer your question, but you could obtain the desired information by writing to Mr. Farr, whose address is embodied in the note to which you refer on page 446.

Chrysanthemum Buds (A. B.).—At once very carefully remove the premature buds, and the others that follow will be crown buds, and under good management develop fine blooms, probably about the time you require them.

Mildew on Vines (R. F.).—Preparations of which sulphate or carbonate of copper forms part are supplied both in the form of powder and solutions. See answers to "J. H." and "H. B.," pp. 500-501, and to replies given to correspondents on page 478 of the week previous.

Delphinium formosum (Tom.).—The seed of this bright blue-flowering plant may be sown now in an open border, and when the plants are large enough to handle they should be pricked off in a bed of good rich soil about 3 inches apart, and in autumn planted where they are to bloom.

Diseased Onions (J. R.).—The Onions are attacked with the fungus that occasionally ruins the plants. It usually seizes on those which have received a severe check in their early stages, the sap then becoming morbid and favourable to the parasitic growth. Your plants are beyond cure, but others that are healthy will if transplanted distant from the affected bed grow very well.

Passiflora Dying (A. B.).—It is not at all uncommon for old plants to collapse the same as yours have done, especially when the wood of previous years was not well matured, as in this case. Sometimes when the stems are cut right back below all signs of faults in the wood

good growth follows, but not always. You might try the plan, and the lower you cut down the stem the more likely will fresh growths be to start.

Fumigating Peach Trees (H. C.).—The skeletonised condition of the leaves is the result of excessive fumigation, and will injuriously affect the crop. It might be advisable to remove some of the fruits, and you had better not stop any of the growths that are made for some time. When Peach houses are fumigated only the best materials should be used, and the work must be done with great care, or more harm than good may ensue.

Leaflets (W. S. P.).—We know of none on the subjects named, nor could any be produced to be of substantial use. Works on Vines, Tomatoes, and Mushrooms are published at this office. We can give you better particulars for making a Vine border that you can find in any cheap pamphlet, if you wish us to do so, and state the nature of the soil and subsoil of your garden. Sound information on all useful crops is given in the "Gardener's Dictionary," post free 8s. from this office.

Imported Orchids (J. S.).—Spread the plants out on a damp base or stage, not exposing them to the full light at first, and if they are dry syringe them occasionally. The other plants should be treated on the same principle, potting those that need it, and gradually inuring them to the changed conditions, and if they arrive in a fairly good state they will soon start into growth. Send us a few small pieces to indicate what you have, and we shall be pleased to give you fuller instructions.

Measuring Rain (N. C.).—There are measures graduated into 100 parts of an inch and others divided into 1000 parts. Yours is the former, as the majority are in gardens, and if you are careful in setting down the exact quantities of rain collected, and in adding up the figures, you will do all that is required. In the scale to which you refer 0.500 would be half an inch, in your own scale 0.50 would, and 0.501, and 0.51 would be a trifle over in each case. Now do you understand? If you do not, write again.

Dividing and Replanting Garden Primroses (D. W.).—We have divided and replanted many thousands of Primroses and Polyanthus immediately the plants ceased flowering and they have grown well; but if the work is deferred till dry weather occurs and they naturally take a rest, it is best not to divide them till they show signs of growth later in the season. It is, however, often necessary to remove them to make room for other flowers, and in that case the roots may be laid in trenches in a moist shaded place, dividing and replanting when growth starts and the weather is favourable for the work.

Weevil (Alpha).—The weevil is *Otiorhynchus sulcatus*, a most destructive pest, eating nearly anything that grows, and the larvæ or maggots do great damage to the roots of Ferns and other plants. The best method of riddance is to persevere in catching the weevils which feed chiefly after dark, and choose a convenient time for removing as much as possible of the old soil as you can when repotting the plants. We do not know whether Clibran's Eucharis mite killer would destroy the maggots or not, but think it worth a trial in your fernery, proceeding experimentally. You will have seen it advertised.

Hot-water Pipes along Eave Plate (J. W.).—There is no objection to taking an inch pipe along the bottom of the rafters by the eave plate, but clear of it, so as to allow the heat to radiate without heating the plate unduly. This plan in a great measure prevents drip and the freezing of the water on the glass in severe weather, and is a source of heat in no way inimical to plants, if the pipes are kept at least 1 foot above them. The circulation, however, will be very much more rapid in these smaller and higher pipes than in the larger and lower ones, but we have used them successfully for heating, having the flow 1-inch pipe (ours were 1½ inch) connected with the 4-inch flow, and the return 1-inch pipe with the 4-inch return, and a screw valve on both flow and return, at their junction with the main pipes, so as to regulate the heat to a nicety. Without these valves the circulation was mainly confined to the smaller pipes on the higher level.

Caterpillar in Holly Shoots (F. M. M.).—The damage is evidently caused by the caterpillar of some small moth, probably of the *Peronea* group, which does not seem to have been identified yet. These little creatures of a dozen different species, with their brown bodies, black heads, and white "collar," very nearly resemble each other, and it is not possible to decide the name of this particular one till the moth has been reared. We can, however, from our knowledge of kindred species, form an idea of the habits of this. The eggs from which the larvæ or caterpillars appear during the spring being, it is likely, laid in the autumn by the second brood, as in most of these moths there are two broods, though the summer caterpillars are less conspicuous in their operations than the earlier brood. As with others of the tribe, the eggs are too firmly glued to the twigs to be removed by washing or syringing, and the only way of keeping them under is by applications about the time the caterpillars are hatching out. They have been successfully extirpated (that is, this or some kindred species) by a petroleum wash or one of hellebore, by one of nicotinic soap, and by dusting the shoots with sulphur. As you refer to a species of insect yet smaller, we may note that the buds of Holly are also infested about May by the larva or grub of a minute two-winged fly called *Phytomyza ilicis*, which is plentiful in some seasons, and in others scarcely to be noticed at all.

The Litchi (W. H. S.).—The seed is that of the Litchi, which is esteemed one of the finest fruits of the East, and is the produce of *Nephelium Litchi*. The tree is a native of China and the East Indies, and was introduced to this country by the celebrated Warren Hastings. The fruit is the size of a Date, and grows in loose spikes. They are covered with a scaly, hardish rind, which is red on one side and green on

the other, containing a delicious, white, sweet, subacid pulp, and a large somewhat obovate brownish seed. The Chinese preserve the fruit during winter by drying it in the same way as Prunes, and they use it in their tea, to which it communicates its fine subacid flavour, which is preferred to the sweetness of sugar. In the dried state they have of late years been imported to this country; and although they are necessarily inferior to the fresh fruit, still they preserve much richness of flavour. The Li-tchi is cultivated extensively in the southern provinces of China, and the northern provinces of Cochin China, as it is impatient of either too much heat or too much cold; and the fruit is produced in the greatest perfection in the provinces of Fo-ki-en, Quan-tong, and Quan-si. Supplies of the fruit are packed in tin cases with spirits and honey, and transported to Peking for the Emperor's use; and even the trees themselves are conveyed thither; being sent off when in flower, the fruit is generally ripe on arrival at Peking. When eaten to excess, the Li-tchi is said to create an eruption over the whole body. Cultivated in this country the plant requires a stove temperature, or it will grow in a warm conservatory. A sandy fairly substantial loam is required with good drainage, and plenty of water when the plant is growing.

Weevils on Vines (G. R.).—There are several weevils that are hurtful to Vines. The most injurious and prevalent species on Vines are the clay-coloured Vine weevil (*O. picipes*), pitch brown, sometimes approaching clay yellow, upper surface tubercled, minutely scaled grey or yellow, length one-third of an inch; the black Vine weevil (*O. sulcatus*), dark brown or black, with tufts of grey hairs on the wing cases, a little longer than the preceding; and *O. ligustici*, black, with greyish scales. The beetles feed on buds, young shoots, and leaves. *Rhynchites betulcti*, blue shining green combined, one-third to half an inch long; the females make conical habitations for the larvæ by rolling the leaves together, which should be removed and burnt. The beetles also are injurious by gnawing the young leaves for their own food. All the species have similar habits. The beetles conceal themselves by day in holes in walls, under loose mortar, and in the soil. They come out at night to feed, and as they must creep up the Vines or crawl over walls remedial measures may take the form of preventing their gaining access to the Vines. This may be effected by drawing a line of sticky material, as softsoap, Davidson's composition, or Wilson's sticky oil, on paper around the stems to prevent injury to the bark, making a similar line around the walls. This, however, is not very effective, as the black Vine weevil travels over sticky bands, and gas tar is not safe to use in vineries. All points considered the best plan is capture. The beetles fall very readily off their food plants when these are shaken, or when a light is introduced into their vicinity. Cloths or newspapers should be laid on the borders, floors, and stages before dark, and after dark proceed with a lantern to shake the Vines, and the fallen beetles can be swept up or collected in the sheets or paper, and be destroyed in boiling water; or they may be shaken into rough trays of wood, tarred inside. This repeated a few times will effect a clearance of the beetles, but the larvæ remain in the soil, and will in due course turn into beetles and repeat the injury. Dressings of quicklime and soot, 1 peck each per square rod, are useful; but we prefer superphosphate of lime and nitrate of potash, say 2 to 3 lbs. the former, and half a pound to 1 lb. the latter per square rod, alternating the dressings with nitrate of soda, giving the latter when the Vines are bursting into leaf, and at intervals of about six weeks up to the fruit stoning, and half a pound each time per square rod. Apply the superphosphate when the buds of the Vines begin to swell, again when the Grapes have been thinned, and when they begin to show colour. The two first dressings will help the current crop, and the latter the buds for next year's crop as well as proving inimical to the larvæ. Thorough cleanliness is a great point, therefore have all holes in the brickwork filled up with good mortar or cement, remove all loose mortar, and have the walls thoroughly white-washed at the proper time, the border duly freed of the loose surface soil and a fresh surfacing given, making all clean and orderly.

Names of Plants.—We only undertake to name species of plants, not varieties that have originated from seed and termed florists' flowers. Flowering specimens are necessary of flowering plants, and Fern fronds should bear spores. Specimens should arrive in a fresh state in firm boxes. Slightly damp moss, soft green grass or leaves form the best packing, dry wool the worst. Not more than six specimens can be named at once, and the numbers should be visible without untying the ligatures, it being often difficult to separate them when the paper is damp. (*C. H. H.*)—*Spiræa hypericifolia*. (*T. B.*)—*Viburnum Lantana*. (*N.*)—The Orchid is *Dendrobium fimbriatum oculatum*; it is neither very scarce nor valuable, and there are several others of similar colour. (*T. W. G.*)—The *Cypripedium Lawrenceanum* is a fairly good variety, but not unusual. The numbers were detached from the other specimens. The light flower is *Dendrobium japonicum*, the other was not recognisable. (*F. L.*)—The flowers were packed in cotton wool, and arrived in a shrivelled condition, also no numbers were attached. One appears to be *Odontoglossum Sanderianum*, the other *Odontoglossum cordatum*. (*Inquirer*).—1, *Polypodium aureum*; 2, *Adiantum pedatum*; 3, *Adiantum assimile*; 4, Insufficient; 5, *Iris virginica*. (*D.*)—*Clematis montana*.

Hives and Bees (Inquirer).—Your name and address are requisite, not for publication, but for the purpose of you receiving a reply that will be useful.

Young and Drone-breeding Queen (J. McK. B.).—As the queen did not arrive we cannot say positively whether she was young or old, but as she was a drone breeder was in all likelihood an unfertilised one. After bees are supplied with eggs and larvæ ten days is sufficient for the evolution of a queen if larvæ is chosen six days old from the

laying of the egg. Sixteen days is the time necessary for the developing and evolution of the queen from the laying of the egg—three days in the egg, fully four in the larval state, and eight in the sealed cell. You did quite right in removing the queen. A good queen cannot be determined by appearance, not until proven or by dissection. It is cheering to hear of your good success with filled frames and supers. Here it is warm, but so droughty that bees get very little from the few flowers in bloom. In fact so parched is the country that unless rain come speedily there will be no honey, and but poor crops of most things.

COVENT GARDEN MARKET.—JUNE 24TH.

Business brisker, with good supplies. Prices generally unaltered, excepting Peaches, which are lower.

FRUIT.

	s.	d.	s.	d.		s.	d.	s.	d.		
Apples, Tasmanian, case	6	0	to	14	0	Oranges, per 100	4	0	to	9	0
Grapes, per lb.	2	0		3	6	Peaches, per doz.	3	0		1	0
Kentish Cobs	40	0		50	0	St. Michael Pines, each..	3	0		8	0
Lemons, case	15	0		20	0	Strawberries, per lb. . .	1	6		5	0

VEGETABLES.

	s.	d.	s.	d.		s.	d.	s.	d.		
Asparagus, per bundle ..	0	6	to	2	6	Mushrooms, punnet ..	0	8	to	0	10
Beans, Kidney, per lb. . .	0	9		1	0	Mustard & Cress, punnet	0	2		0	0
Beet, Red, dozen	1	0		0	0	Onions, bushel.	5	0		6	6
Cabbage, dozen	3	0		0	0	Parsley, dozen bunches	2	0		3	0
Carrots, bunch	0	4		0	0	Parsnips, dozen	1	0		0	0
Cauliflowers, dozen. . . .	3	0		6	0	Potatoes, per cwt.	8	0		4	0
Celery, bundle	1	0		1	3	Rhubarb, bundle	0	2		0	3
Coleworts, doz. bunches	2	0		4	0	Salsafy, bundle	1	0		1	6
Cucumbers, doz.	1	6		4	0	Scorzouera, bundle	1	6		0	0
Endive, dozen	1	3		1	6	Shallots, per lb.	0	3		0	0
Herbs, bunch	0	2		0	0	Spinach, bushel	5	0		6	0
Leeks, bunch	0	2		0	0	Tomatoes, per lb.	0	10		1	0
Lettuce, dozen	1	0		1	3	Turnips, bunch	0	0		0	4

AVERAGE WHOLESALERS PRICES.—CUT FLOWERS.

	s.	d.	s.	d.		s.	d.	s.	d.		
Orchid Blooms very good, rather plentiful.											
Arum Lilies, 12 blooms ..	2	0	to	6	0	Mimosa (French), per					
Azalea, doz. sprays	0	6		1	0	bunch	1	3	to	1	6
Bluebells, dozen bunches	1	0		2	0	Myosotis, dozen bunches	2	0		4	0
Bouvardias, bunch	0	9		1	0	Narciss (double white)					
Carnations, 12 blooms ..	1	0		2	0	dozen bunches	4	0		8	0
Cornflower, doz. bunches	2	0		4	0	Pæonies, dozen bunches	6	0		18	0
Eucharis, dozen	3	0		6	0	Pansies, dozen bunches..	1	0		2	0
Gardenias, per doz.	1	0		3	0	Pelargoniums, 12 bunches	4	0		9	0
Gladiolus (white), dozen						scarlet, 12 bnchs	3	0		6	0
bunches	6	0		12	0	Pink (various) doz. behs.	2	0		4	0
Iris (Various) doz. behs.	4	0		8	0	Primula (double) 12 sprays	0	6		1	0
Lapageria, 12 blooms ..	2	0		4	0	Pyrethrum, doz. bunches	2	0		6	0
Lilac (English) per						Ranunculus, doz. bnchs.	2	0		4	0
bunch	0	6		1	0	Roses (indoor), dozen ..	0	6		1	6
.. (French) per bunch	5	0		6	0	.. (mixed), per doz. . . .	6	0		10	0
Lilium longiflorum, 12						.. Red (English) per					
blooms	3	0		4	0	dozen blooms	2	0		4	0
Lilium (various) dozen						.. Red, 12 bls. (Ench.)	1	0		2	0
blooms	1	0		3	0	.. Tea, white, dozen. . .	1	0		2	0
Lily of the Valley, dozen						.. Yellow, dozen	2	0		4	0
bunches	6	0		12	0	Spiræa, per bunch	0	6		0	9
Maideuhair Fern, dozen						Sweet Peas, doz. bunches	3	0		6	0
bunches	4	0		9	0	Sweet Sultan, doz. bnchs.	4	0		6	0
Marguerites, 12 bunches	2	0		4	0	Tuberose, 12 blooms .. .	0	6		1	0
Mignonette, 12 bunches..	3	0		6	0	Wallflower, doz. bunches	2	0		4	0

PLANTS IN POTS.

	s.	d.	s.	d.		s.	d.	s.	d.		
Aralia Sieboldi, dozen ..	6	0	to	18	0	Geraniums, Ivy, per doz.	4	0	to	6	0
Arbor Vitæ (golden) doz.	6	0		8	0	Heliotrope, per doz. . .	4	0		8	0
Arum Lilies, per doz. . . .	9	0		12	0	Hydrangeas, per doz. . .	9	0		12	0
Begonias (various), per						Lilium longiflorum, per					
dozen	6	0		18	0	dozen	18	0		30	0
Calceolarias, per dozen ..	5	0		9	0	Lobelia, per doz.	4	0		6	0
Cineraria, per doz.	5	0		8	0	Marguerite Daisy, dozen	6	0		12	0
Coleus (various), per doz.	3	0		9	0	Mignonette, per dozen ..	4	0		9	0
Dracæna terminalis, doz. 24	0	42		0	0	Musk, per doz.	2	0		4	0
.. viridis, dozen	12	0		24	0	Myrtles, dozen	6	0		12	0
Erica, various, dozen	12	0		24	0	Palms, in var., each. . . .	2	6		21	0
Euonymus, var., dozen .. .	6	0		18	0	Pelargoniums, per doz. . .	6	0		15	0
Evergreens, in var., dozen	6	0		24	0	Pelargoniums, scarlet, per					
Fairy Roses, per doz.	6	0		9	0	dozen	3	0		6	0
Ferns, in variety, dozen. . .	4	0		18	0	Saxifraga pyramidalis, per					
Ficus elastica, each.	1	6		7	0	doz.	12	0		13	0
Foliage plants, var., each	2	0		10	0	Spiræa, per doz.	8	0		12	0
Fuchsia, per doz.	6	0		12	0	Stocks, per dozen	4	0		6	0
Geuista, per doz.	6	0		9	0	Tropæolums, per dozen ..	3	0		6	0

Bedding plants (in variety) in boxes, from 1s. to 3s.; in pots, per doz., 1s. to 2s.



SMALL FARMS.

THERE is something very tempting about the mere mention of a small farm, for does it not give rise to visions of peace and plenty, of ease, quiet, and contentment, of pure air, and pure food, most of which is grown on the farm? Milk, cream, butter, eggs, poultry, delicious little porkers, home-cured hams and bacon, pigeon pies, and what not, all are forthcoming from the farm, together with home-made bread from home-grown Wheat. Truly the picture is a tempting one, all the more so because it appears to

be so possible, and yet the reality is very different. Sure enough the farm does afford all the good things mentioned, but the tenant knows full well that in order to pay his way he must convert everything he can into hard cash, must live hard himself, and work hard too—aye, much harder than an ordinary labourer. Well has it been said that, "When the agricultural labourer becomes a small farmer, he exchanges moderate hours and regular wages for incessant toil and a meagre competency."

There can be no doubt that it is the incessant labour of himself and his family which has enabled the small farmer to hold his own, while many a large farmer has gone under. But the small farmers have suffered too, and it is notorious how low the live stock both of sheep and cattle of small farmers has fallen under the agricultural depression since 1875. He has held on, but his clothes have become ragged, his food as coarse as that of the labourer, his yard as bare of stock, for a cow or horse has often had to be sold to enable him "to meet the rent day." His wife has done what she could to help in this serious emergency by her dairy, if she is still so fortunate as to have one, and by taking in lodgers. This may be regarded as an extreme case, but it is common enough in the great corn-growing districts.

Some of the best evidence of the condition and prospects of small farmers was given a few years ago by a well-known Devonshire land agent, who said of them—"The advantages which the small farmers in this locality possess over the large ones are, that their simple mode of living and their industrious habits enable them to do better than the large farmers, who, having to pay for everything which they have done, are being ruined by the very low prices of all kinds of stock and produce, and the low price for labour."

The small farmer, with his wife and children in most instances, not only milks and feeds the cows, rears the calves, looks after the poultry and the pigs, but the wife, after also attending to her dairy and butter making, takes all the produce she can spare from the dairy, poultry, all kinds of vegetables, fruit, and even flowers to market herself; and by these means generally provides the rent by the time it is due, besides occasionally selling the prime joints of pork and black and white puddings, being content to live themselves on that which is not so easily converted into money.

The farmer himself, with his eldest boys, works harder and many more hours than a paid labourer does now-a-days, and always has a watchful eye on all the live stock; he employs as little outside labour as possible, he frequently hires his machines and other implements from his neighbours on the larger farms.

We will give one instance which we think fairly represents their system and management of live stock. We recently went over a farm, not exceeding 100 acres, on which we found about 60 head of cattle of different ages, besides 6 dairy cows and about 150 sheep. The cattle comprised about 15 beasts over three years old, 15 over two years, 14 yearlings, and 16 or 17 rearing calves. On asking the farmer why he was keeping the old cattle he replied that the price he had been offered for them was so miserably low that he could not make up his mind to sell them. We then inquired if they were not worth the same or more money twelve months ago, and he admitted that they were. We said, "By keeping them and giving them all the best roots and grass on the farm you have been starving all your younger cattle." If he had sold them the previous autumn at whatever price he could have made of them, and given the food which they had since consumed to the young stock the 30 yearlings and two-year-olds would have been worth more money than the whole 45 feeding cattle, and by giving them a little cotton-cake with the grass (which in Devonshire is generally in too succulent a state to make cattle thrive well upon it), he would not only have improved the condition of the pasture to nearly or quite the extent of his outlay on cake, but he would have found in the autumn a ready sale for his two-year-old cattle, if not with the butcher, at least with those who would have made them fit for the slaughter house.

The farmer could not deny these facts, but he shrugged his

shoulders at the idea of putting his hand into his pocket to purchase cake. The quotation is valuable as showing the plodding energy of farmers of this class as well as the common want of capacity to deal with an emergency or anything taking them out of the ordinary groove.

WORK ON THE HOME FARM.

This is the farmer's time for taking a few days off before hay time, and the numerous agricultural shows afford him ample opportunities of seeing live stock and implements in the very pink of condition. Some useful lessons are to be had at such meetings by all intelligent men, and not the least important part of them is the discussion of points of improvement or otherwise. Our advice is occasionally sought at the big shows about the purchase of implements, and a few clear hints generally serve to show the purchaser how to obtain a really efficient implement. In doing this one has to look behind the gloss and glitter of show implements, and to see carefully if practical utility has had due attention. The steam digger on view this week at the Doncaster meeting of the Royal Agricultural Society should be worthy of special attention. It is claimed for it that a 10-horse power implement worked by one man will cultivate ten acres a day at a total cost of 50s., or 5s. an acre. If it will do this in the thorough manner specified, why then the Company holding the patents have only to make plenty of the diggers to let on hire to insure a splendid business at once. But will they? To promise to cultivate land at such a price, and to do it, are two things. Few, if any, farmers will be found under the present unsatisfactory condition of agriculture willing to invest £500 even in such a labour-saving implement. But only give farmers a chance to hire them, and see that the work is well done, and there would be no lack of applicants for the hire of the digger.

Such an implement is precisely what we want to enable us to meet the stress of hard times. It is the cost of labour and horses that cripples so many men. If only a saving of half of the present outlay involved in land tillage were possible, as the Steam Digging Company says it is, it would indeed mark a new era in farming. The implement may be all that is said of it; the question is, How are farmers to obtain the use of it, and get their land tilled by it, at the price they are told it can be done for?

SEED STANDS AND GARDEN APPLIANCES AT THE DONCASTER SHOW.—We are informed there is an extensive display of the above by leading merchants and manufacturers, but as a reporter's ticket has not been received we do not send a representative to the Show. This announcement will, however, remind those of our readers who may visit the Show that the exhibits in question are worthy of inspection.

OUR LETTER BOX.

Farm Student (W. R. W.).—The best and cheapest set of books for your purpose are Morton's "Handbooks of the Farm," published in nine volumes at 2s. 6d. each, by Vinton & Co., 9, New Bridge Street, London, E.C. If ordered as a complete set they can be had carriage free for £1. The subjects comprise Chemistry, Live Stock, Crops, Soil, Plant Life, Equipment, Dairy, Animal Life, and Labour. You may by study obtain some knowledge of farming, but practical experience is quite indispensable to enable you to understand the management of a home farm successfully. Get thoroughly grounded in the theory, and opportunities for practice may arise, or you may in due course be able to make them. If you have the prospects of the charge of a home farm your best course, in addition to theoretical study, would be to quietly obtain competent advice, and thoroughly discuss the matter either beforehand or at the outset. If you require such aid write to us, and we will gladly put you in the way to obtain it.

Weed in Pasture (F. G. W.).—The weed you send is *Centaurea nigra* or Black Knapweed. It will be quite likely to impair the quality of milk and butter and should be grubbed out. Is not your pasture poor?

METEOROLOGICAL OBSERVATIONS.

CAMDEN SQUARE, LONDON.
Lat. 51° 32' 40" N.; Long. 0° 8' 0" W.; Altitude, 111 feet.

DATE.	9 A.M.				IN THE DAY.				Rain	
	Barometer at 32° and Sea Level.	Hygrometer.		Direction of Wind.	Temp. of soil at 1 foot.	Shade Temperature.		Radiation Temperature.		
		Dry.	Wet.			Max.	Min.	In sun.		On grass.
1891. June.										
Sunday	30.207	60.0	53.2	W.	51.0	71.7	52.8	110.9	47.8	—
Monday	30.032	61.1	53.0	S.W.	58.2	69.9	49.4	111.0	43.0	0.053
Tuesday	30.096	60.6	51.0	N.W.	58.0	69.6	47.8	119.3	43.9	—
Wednesday	30.307	63.8	57.0	S.	58.7	76.9	49.7	115.3	45.6	—
Thursday	30.341	68.7	62.6	S.	59.9	78.7	55.8	120.1	49.1	—
Friday	30.320	70.2	62.2	N.W.	61.3	77.9	53.4	118.3	47.2	—
Saturday	30.334	63.7	58.1	N.E.	62.1	73.9	55.4	123.3	50.1	—
	30.234	63.9	57.3		59.5	74.1	52.0	116.9	43.7	0.933

REMARKS.

14th.—Fine and warm, but generally a little hazy.
15th.—Overcast morning, bright afternoon, wet from 6.30 to 8 P.M.
16th.—Overcast early, generally bright after 10 A.M.
17th.—Warm and fine, but hazy at times.
18th.—Fine and warm but hazy and oppressive.
19th.—Fine and warm, but at times hazy and oppressive.
20th.—Fine, bright, and pleasant.

Another fine and dry week, but no temperature of 80° in the shade.—G. J. SYMONS.

